

**SURFACE MOUNT
HIGH REPEATABILITY,
BROADBAND TO-5 RELAYS
DPDT**

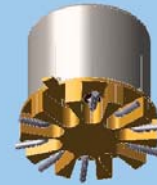

SERIES	RELAY TYPE
SGRF300	Repeatable, RF relay
SGRF300D	Repeatable, RF relay with internal diode for coil transient suppression
SGRF300DD	Repeatable, RF relay with internal diodes for coil transient suppression and polarity reversal protection
SGRF303	Sensitive, repeatable, RF relay
SGRF303D	Sensitive, repeatable, RF relay with internal diode for coil transient suppression
SGRF303DD	Sensitive, repeatable, RF relay with internal diodes for coil transient suppression and polarity reversal protection

DESCRIPTION

The ultraminiature SGRF300 and SGRF303 relays are designed to provide a practical surface-mount solution with improved RF signal repeatability over the frequency range. SGRF300 and SGRF303 relays feature a unique ground shield that isolates and shields each lead to ensure excellent contact-to-contact and pole-to-pole isolation. This ground shield provides a ground interface that results in improved highfrequency performance as well as parametric repeatability. The SGRF300 and SGRF303 extend performance advantages over similar RF devices that simply offer formed leads for surface mounting. These relays are engineered for use in RF attenuator, RF switch matrices, ATE and other applications that require dependable high frequency signal fidelity and performance.

The SGRF300 and SGRF303 feature:

- High repeatability
- Broader bandwidth
- Metal enclosure for EMI shielding
- High isolation between control and signal paths
- High resistance to ESD

The following unique construction features and manufacturing techniques provide excellent robustness to environmental extremes and overall high reliability:

- Uniframe motor design provides high magnetic efficiency and mechanical rigidity
- Minimum mass components and welded construction provide maximum resistance to shock and vibration
- Advanced cleaning techniques provide maximum assurance of internal cleanliness
- Gold-plated precious metal alloy contacts ensure reliable switching
- Hermetically sealed

The Series SGRF300D/SGRF303D and SGRF300DD/SGRF303DD relays have internal discrete silicon diodes for coil suppression and polarity reversal protection. This hybrid package reduces required PC board floor space by reducing the number of external components needed to drive the relay.

ENVIRONMENTAL AND PHYSICAL SPECIFICATIONS		
Temperature (Ambient)	Storage	-65°C to +125°C
	Operating	-55°C to +85°C
Vibration (General Note I)		10 g's to 500 Hz
Shock (General Note I)		30 g's, 6ms half sine
Enclosure		Hermetically sealed
Weight	SGRF300	0.09 oz. (2.55g) max.
	SGRF303	0.16 oz. (4.5g) max.

INTERNAL CONSTRUCTION

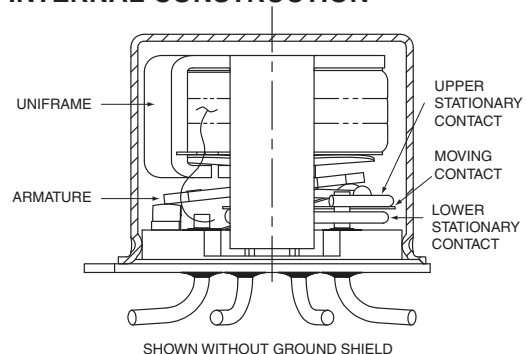

SERIES SGRF300/SGRF303
TYPICAL RF CHARACTERISTICS (See RF Notes)

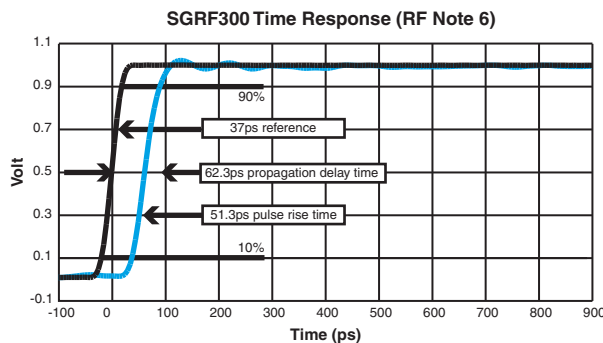
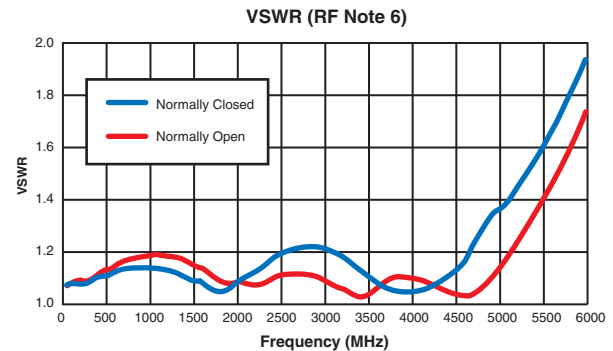
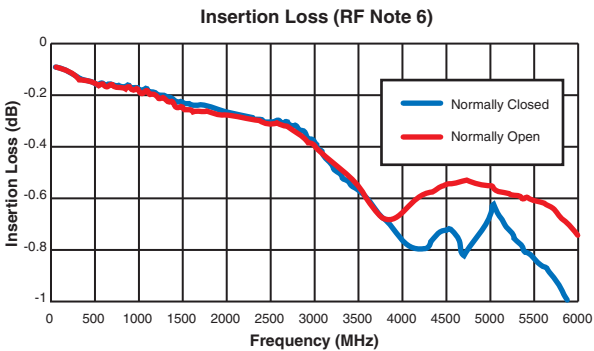
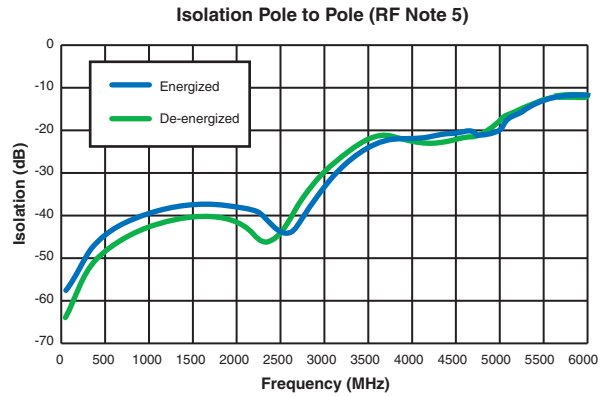
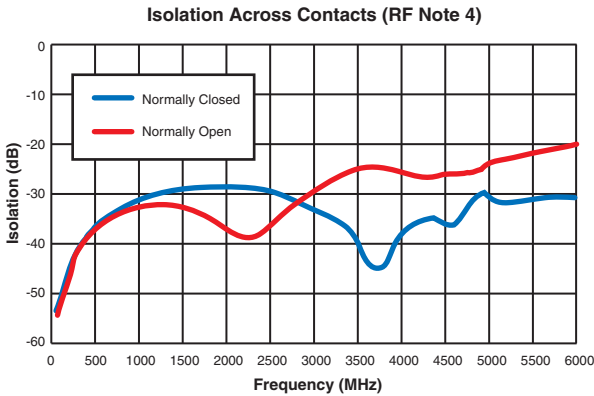

RF NOTES

- Test conditions:
 - Fixture: .031" copper clad, reinforced PTFE, RT/duroid® 6002 with SMA connectors. (RT/duroid® is a registered trademark of Rogers Corporation.)
 - RF ground shield is soldered to PCB RF ground plane.
 - Room ambient temperature.
 - Terminals not tested were terminated with 50-ohm load.
 - Contact signal level: -10 dBm.
 - No. of test samples: 2.
- Data presented herein represents typical characteristics and is not intended for use as specification limits.
- Data is per pole, except for pole-to-pole data.
- Data is the average from readings taken on all open contacts.
- Data is the average from readings taken on poles with coil energized and de-energized.
- Data is the average from readings taken on all closed contacts.
- Test fixture effect de-embedded from frequency and time response data.

SERIES SGRF300 AND SGRF303
TYPICAL RF INSERTION LOSS REPEATABILITY CHARACTERISTICS
(See RF Insertion Loss Repeatability Notes)

REPEATABILITY CHARACTERISTICS SGRF300 RELAYS

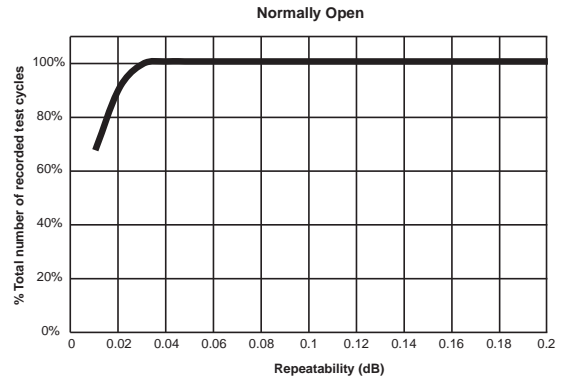
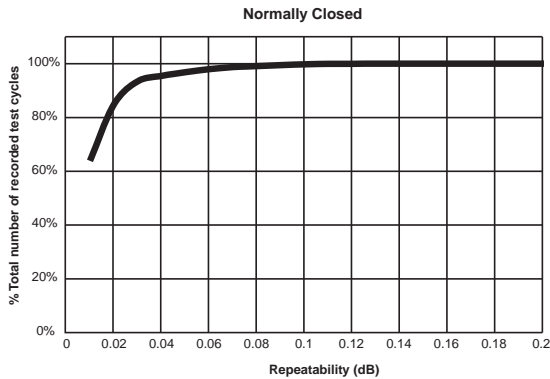

REPEATABILITY CHARACTERISTICS SGRF303 RELAYS

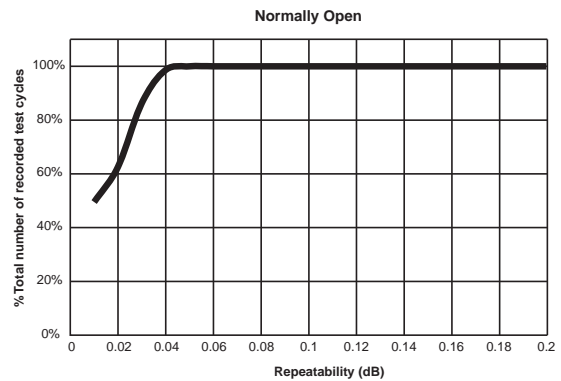
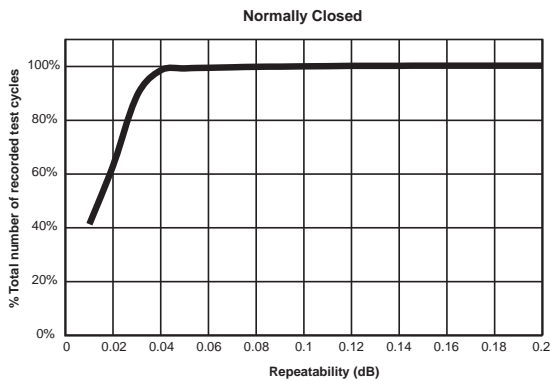

RF INSERTION LOSS REPEATABILITY NOTES

- Test conditions:
 - Fixture: .031" copper clad, reinforced PTFE, RT/duroid® 6002 with SMA connectors. (RT/duroid® is a registered trademark of Rogers Corporation.)
 - Test performed at room ambient temperature.
 - Contact signal level: 20dBm.
- Data presented herein represents typical characteristics and is not intended for use as specification limits.
- Insertion loss repeatability measured over frequency range from 50MHz to 4GHz.

SERIES SGRF300/SGRF303

TYPICAL RF REPEATABILITY PERFORMANCE (See RF Notes 1,2 and 3)

1 Million Cycle Repeatability ±0.1 dB from DC to 3GHz

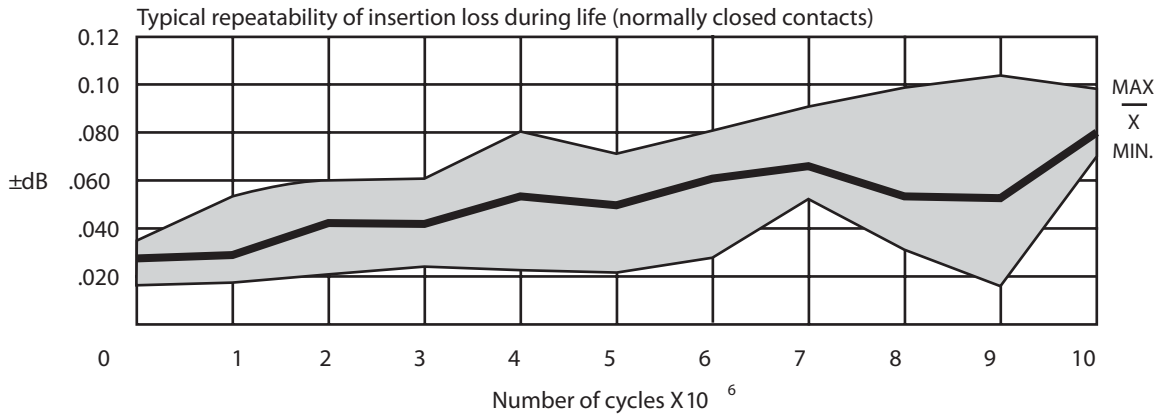
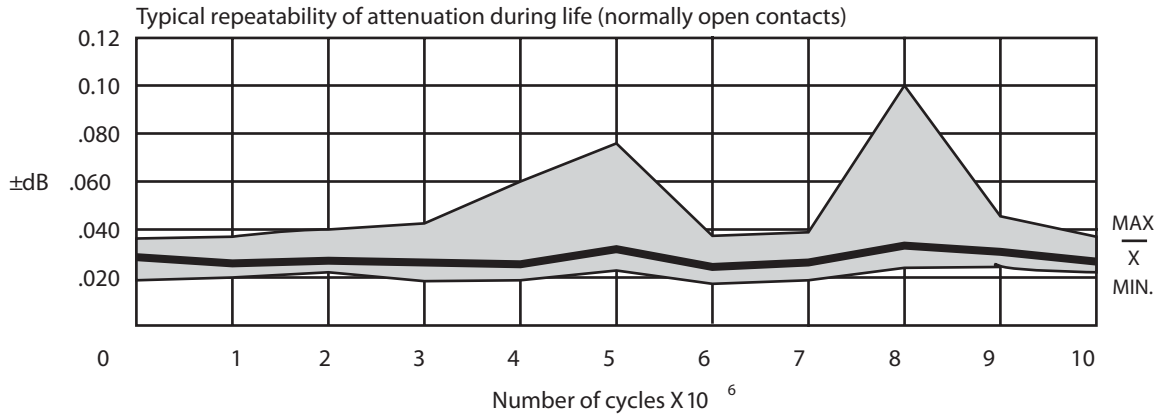

RF NOTES

1. One million cycle repeatability data is based upon 396 observations with an average repeatability ±0.033 dB and a range of ±0.093 dB.
2. Repeatability of attenuation values were obtained from tests conducted in a 20 dB attenuator network with a 0 dBm input signal.
3. Relay operates at frequencies higher than 3 GHz with reduced RF performance characteristics.
4. Curves were developed from tests performed on a 0.031" copper clad, reinforced PTFE circuit board at 20°C (ref). The unused contacts were terminated in 50 ohms; characteristic impedance of measuring equipment is 50 ohms. The relays were mounted flush to the circuit board ground plane without the relay header soldered to the ground plane.

SERIES SGRF300/SGRF303 GENERAL ELECTRICAL SPECIFICATIONS (@25°C)

Contact Arrangement	2 Form C (DPDT)	
Rated Duty	Continuous	
Contact Resistance	0.15 Ω max.	
Contact Load Rating	Resistive: 1Amp/28Vdc Low level: 10 to 50 μA @ 10 to 50 mV	
Contact Life Ratings	10,000,000 cycles (typical) at low level	
Coil Operating Power	SGRF300-5: 500 mW @ nominal coil	SGRF300-12: 370 mW @ nominal coil
	SGRF303-5: 250 mW @ nominal coil	SGRF303-12: 169 mW @ nominal coil
Operate Time	SGRF300: 4.0 mS max. SGRF303: 6.0 mS max.	
Release Time	SGRF300: 3.0 mS max.	SGRF300D, SGRF300DD: 4.0 mS max.
	SGRF303: 3.0 mS max.	SGRF303D, SGRF303DD: 7.5 mS max.
Intercontact Capacitance	0.4 pf typical	
Insulation Resistance	1,000 MΩ min. between mutually isolated terminals	
Dielectric Strength	350 Vrms (60 Hz) @ atmospheric pressure	
Negative Coil Transient (Vdc)	SGRF300D/SGRF303D, SGRF300DD/SGRF303DD	1.0 max
Diode P.I.V. (Vdc)	SGRF300D/SGRF303D, SGRF300DD/SGRF303DD	100 min.

DETAILED ELECTRICAL SPECIFICATIONS (@25°C)

BASE PART NUMBERS (SGRF300, SGRF300D, SGRF300DD)		SGRF300-5 SGRF300D-5 SGRF300DD-5	SGRF300-12 SGRF300D-12 SGRF300DD-12
Coil Voltage, Nominal (Vdc)		5.0	12.0
Coil Resistance (Ohms ±20%)	SGRF300, SGRF300D	50	390
	SGRF300DD (General Note II)	39	390
Coil Current (mAdc @ 25 °C)(RF300DD Series)	Min.	93.2	25.6
	Max.	128.2	32.8
Pick-up Voltage (Vdc max.)	SGRF300, SGRF300D,	3.6	9.0
	SGRF300DD	3.9	10.0

BASE PART NUMBERS (SGRF303, SGRF303D, SGRF303DD)		SGRF303-5 SGRF303D-5 SGRF303DD-5	SGRF303-12 SGRF303D-12 SGRF303DD-12
Coil Voltage, Nominal (Vdc)		5.0	12.0
Coil Resistance (Ohms ±20%)	SGRF303, SGRF303D	100	850
	SGRF303DD (General Note II)	64	850
Coil Current (mAdc @ 25 °C)(RF303DD Series)	Min.	56.8	11.7
	Max.	78.1	15.0
Pick-up Voltage (Vdc max.)	SGRF303, SGRF303D,	3.6	9.0
	SGRF303DD	3.7	11.0

SERIES SGRF300/SGRF303
OUTLINE DIMENSIONS

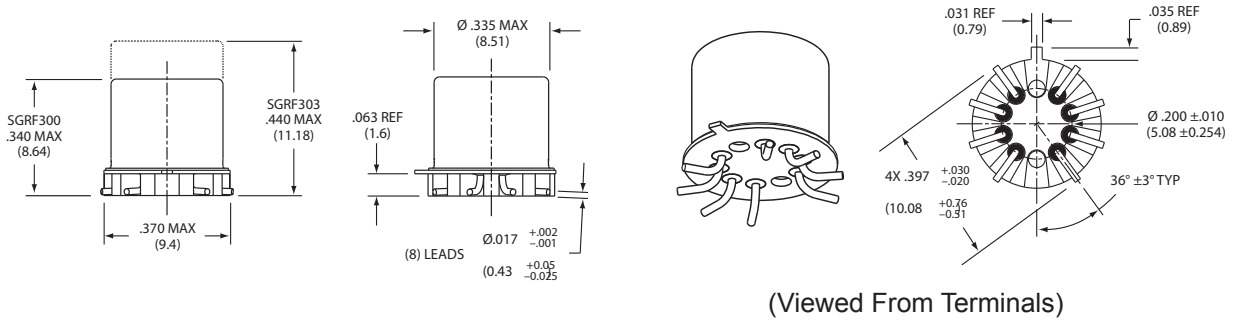

SCHEMATIC DIAGRAMS

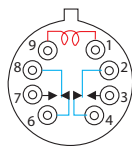

SGRF300/RF303

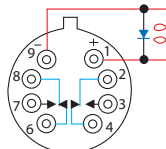

SGRF300D/SRF303D

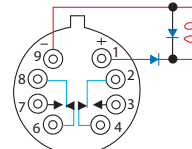

SGRF300DD/SGRF303DD

NOTES:

1. DIMENSIONS ARE IN INCHES, METRIC EQUIVALENTS SHOWN IN ().
2. POSITIONS 5 AND 10 ARE FOR UNINSULATED CASE GROUND OPTIONS.
3. NO PROTRUSION BELOW BOTTOM OF HEADER WHEN GROUND PINS ARE INSTALLED
4. TO ORDER THE CASE GROUND OPTION, AFTER THE SERIES DESIGNATOR, ADD "Y" TO THE PART NUMBER FOR POSITION 5 OR "Z" TO THE PART NUMBER FOR POSITION 10.

Teledyne Part Numbering System for SGRF300/SGRF303 Relays

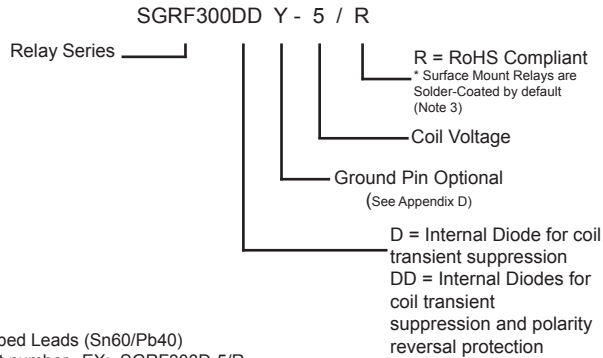

NOTES:

- ¹ Standard Relay lead finish: Solder-Dipped Leads (Sn60/Pb40)
- ² For RoHS Solder, add /R at end of part number. EX: SGRF303D-5/R
RoHS Solder: (Sn99.3/Cu0.7)
- ³ The slash and characters appearing after the slash are not marked on the relay.

GENERAL NOTES

- I. Relays will exhibit no contact chatter in excess of 10 µsec or transfer in excess of 1 µsec.
- II. For reference only. Coil resistance not directly measureable at relay terminals due to internal series diode.

SERIES SGRF300/SGRF303
TYPICAL SIGNAL INTEGRITY CHARACTERISTICS @ 10 Gbps

Normally Closed (Typ.)

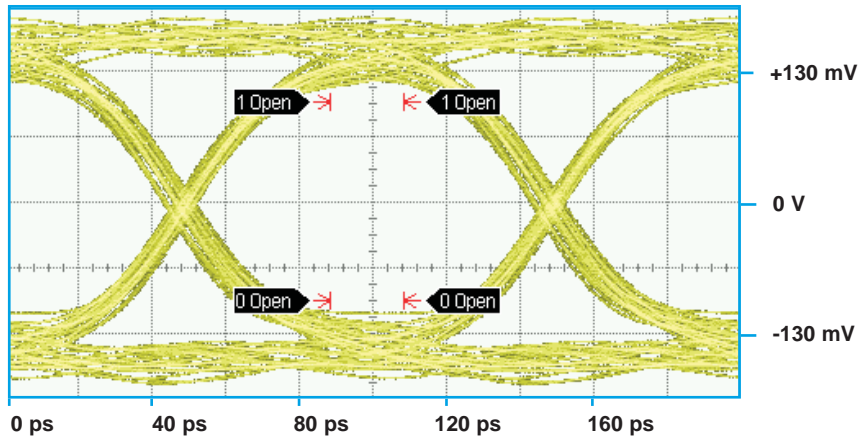

Bit Rate	Eye Height	Eye Width	Jitter _{P-P}
10 Gbps	195.3 mV	87.41 ps	9.78 ps

Normally Open (Typ.)

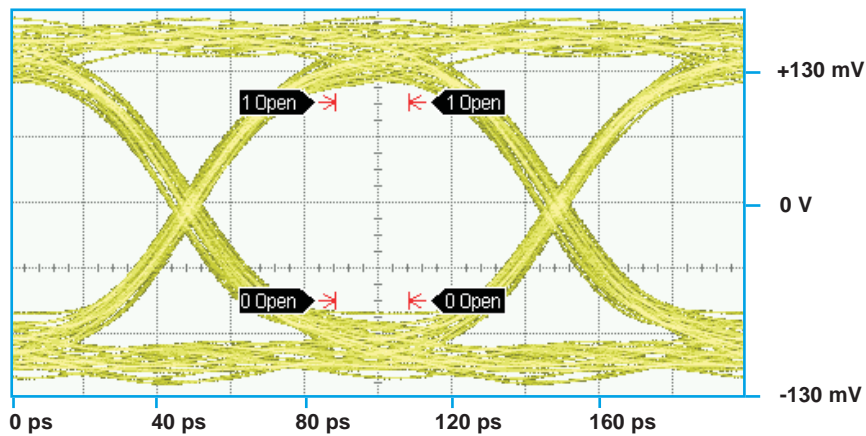

Bit Rate	Eye Height	Eye Width	Jitter _{P-P}
10 Gbps	197.4	82.95 ps	10.67 ps

PATTERN GENERATOR SETTINGS

- 10 Gbps Random Pulse Pattern Generator
- $2^{31} - 1$ PRBS signal
- PRBS output of 300 mV_{P-P} (nominal)
- RF PCB effect (negligible) not removed from measurement
- Data shown is typical of both poles

SERIES SGRF300/SGRF303
TYPICAL SIGNAL INTEGRITY CHARACTERISTICS @ 18 Gbps

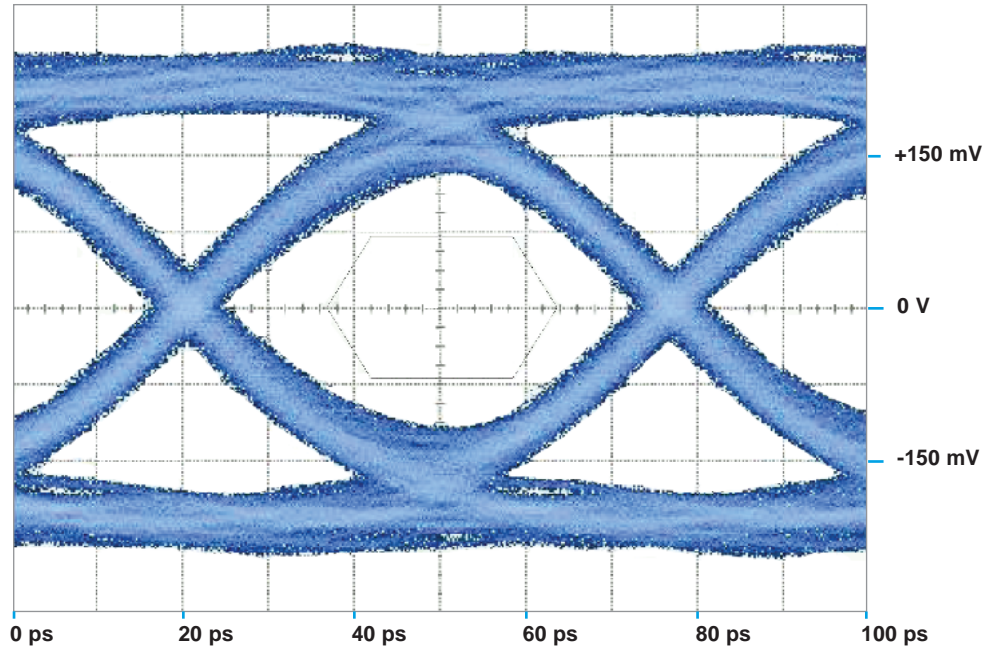

Bit Rate	Eye Height	Eye Width	Jitter _{P-P}
18 Gbps	185 mV	46.4 ps	10.44 ps

PATTERN GENERATOR SETTINGS

- 18 Gbps Random Pulse Pattern Generator
- $2^{31} - 1$ PRBS signal
- PRBS output of 300 mV_{P-P} (nominal)
- RF PCB effect (negligible) not removed from measurement
- Data shown is typical of both poles