



A Unit of Teledyne Electronics and Communications

HIGH REPEATABILITY, NORMALLY CLOSED, BYPASS RF RELAYS

SERIES RF310 RF313

SERIES DESIGNATION	RELAY TYPE
RF310	Repeatable, RF, N.C. bypass relay
RF313	Sensitive, repeatable, RF, N.C. bypass relay

INTERNAL CONSTRUCTION

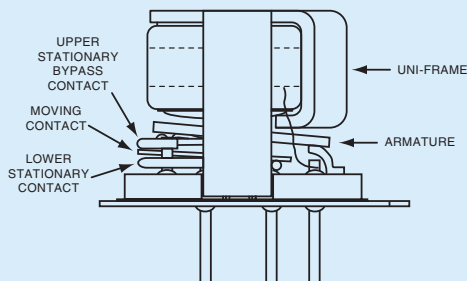

PERFORMANCE FEATURES

The ultraminiature RF310 and RF313 relays are designed with an internal bypass (through path), when the coil is de-energized, to provide low insertion loss and VSWR through the bypass and simplicity of design for the user. Relays have improved RF insertion loss repeatability over the frequency range from dc to 3 GHz. Highly suitable for use in attenuator, linear amplifier and other RF circuits. The RF310 and RF313 feature:

- N.C. bypass configuration.
- Repeatable insertion loss.
- Broad bandwidth.
- Metal enclosure for EMI shielding.
- Ground pin option to improve case RF grounding.
- High isolation between control and signal paths.
- High resistance to ESD.

CONSTRUCTION FEATURES

The following unique construction features and manufacturing techniques provide excellent resistance to environmental extremes and overall high reliability.

- Uni-frame motor design provides high magnetic efficiency and mechanical rigidity.
- Minimum mass components and welded construction provide maximum resistance to shock and vibration.
- Advanced cleaning techniques provide maximum assurance of internal cleanliness.
- Gold-plated precious metal alloy contacts ensure reliable switching.

ENVIRONMENTAL AND PHYSICAL SPECIFICATIONS

Temperature (Ambient)	Storage	-65°C to +125°C
	Operating	-55°C to +85°C
Vibration (General Note 1)		10 g's to 500 Hz
Shock (General Note 1)		30 g's, 6 msec, half-sine
Enclosure		Hermetically sealed
Weight	RF310	0.09 oz. (2.55g) max.
	RF313	0.16 oz. (4.5g) max.

SERIES RF310 AND RF313
TYPICAL RF CHARACTERISTICS (Notes 1, 2 and 3)

INSERTION LOSS AND VSWR CHARACTERISTICS RF310 RELAYS

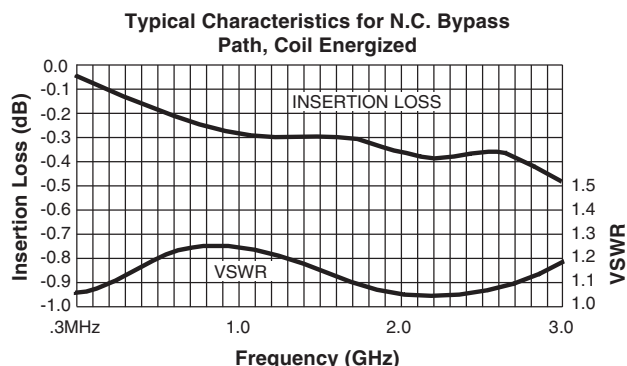
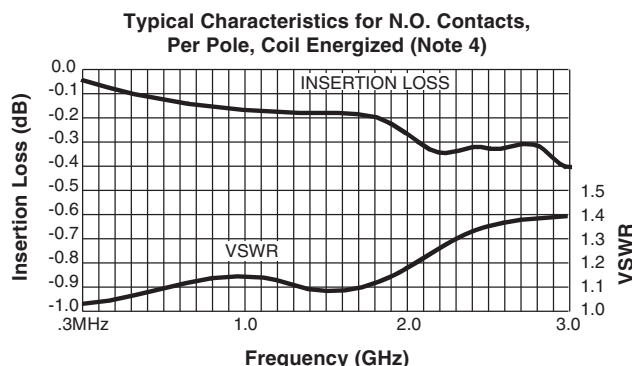

INSERTION LOSS AND VSWR CHARACTERISTICS RF313 RELAYS

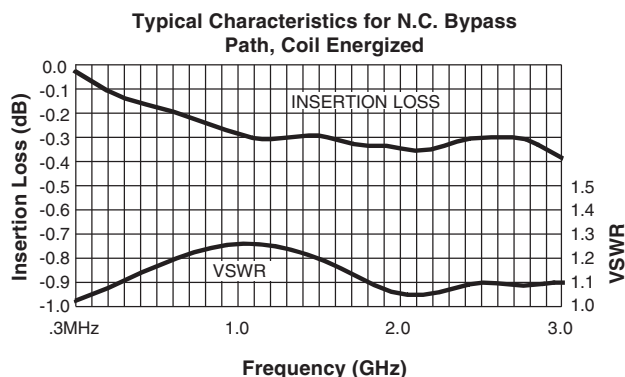
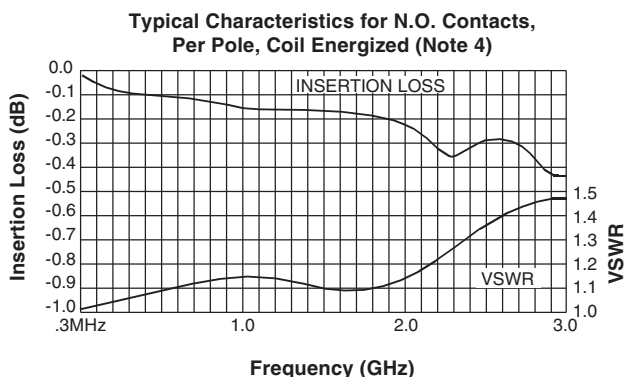

ISOLATION CHARACTERISTICS RF310 AND RF313 RELAYS

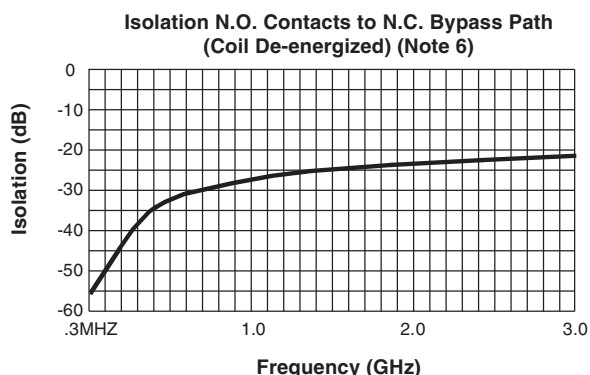
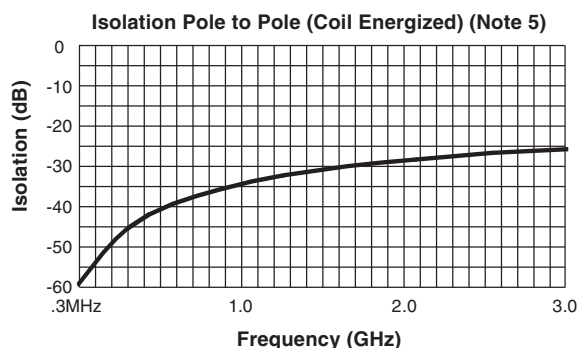

RF NOTES

1. Test conditions:
 - a. Fixture: .031" copper clad, reinforced PTFE, RT/duroid® 6002 with SMA connectors. (RT/duroid® is a registered trademark of Rogers Corporation.)
 - b. Relay header is not soldered to ground plane or connected to ground via ground pin.
 - c. Test performed at room ambient temperature.
 - d. Terminals not tested were terminated with 50-ohm load.
 - e. Contact signal level: 0 dBm.
2. Data presented herein represents typical characteristics and is not intended for use as specification limits.
3. Data is per pole.
4. Measurement points are from pins 2 & 3 to pins 7 & 8.
5. Data is the average of both N.O. contacts to the bypass path.
6. Relays operate at frequencies above 3 GHz with reduced RF performance characteristics.

SERIES RF310 AND RF313

TYPICAL INSERTION LOSS REPEATABILITY CHARACTERISTICS (Notes 1 and 2)

REPEATABILITY CHARACTERISTICS RF310 RELAYS

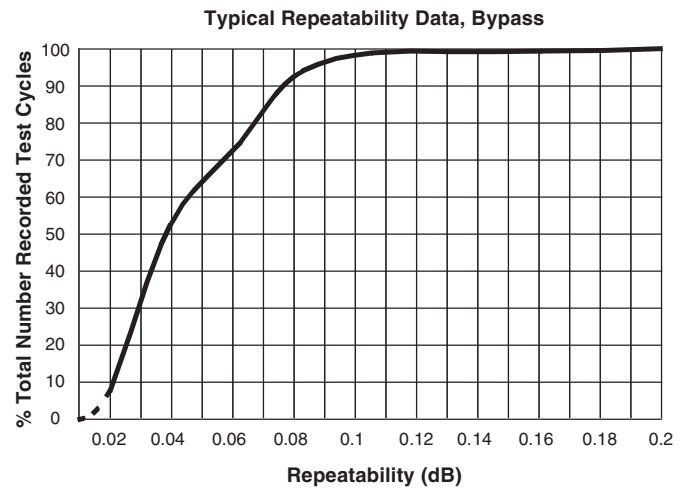
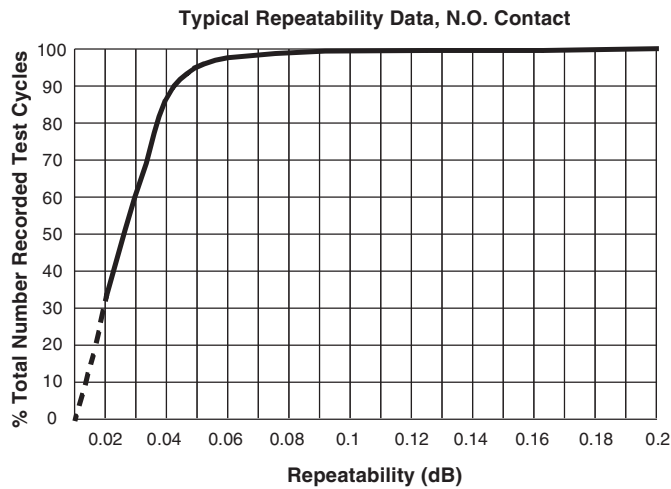

REPEATABILITY CHARACTERISTICS RF313 RELAYS

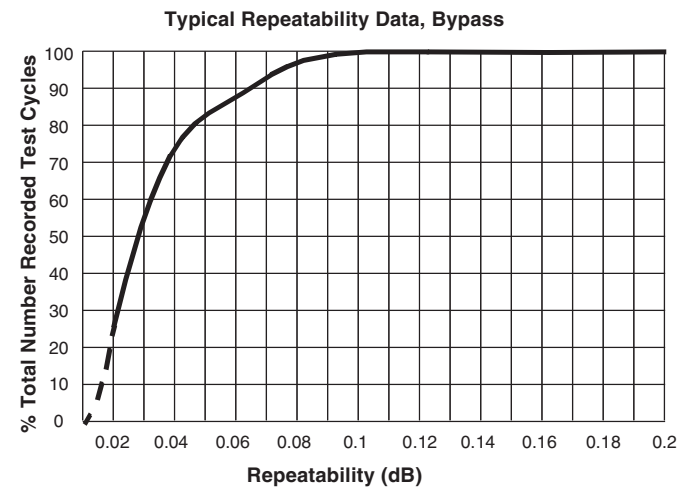
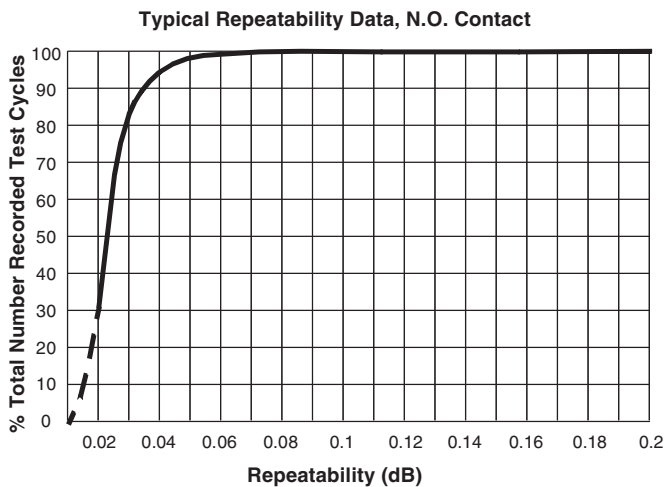

RF INSERTION LOSS REPEATABILITY NOTES

- Test conditions:
 - Fixture: .031" copper clad, reinforced PTFE, RT/duroid® 6002 with SMA connectors. (RT/duroid® is a registered trademark of Rogers Corporation.)
 - Relay header is not soldered to ground plane or connected to ground via ground pin.
 - Test performed at room ambient temperature.
 - Contact signal level: 0 dBm.
- Data presented herein represents typical characteristics and is not intended for use as specification limits.
- N.O. path contacts connected in series externally.
- Insertion loss repeatability measured over frequency range from .3 MHz to 3 GHz.

SERIES RF310 AND RF313
GENERAL ELECTRICAL SPECIFICATIONS (@25°C)

Contact arrangement	N.C. side (coil de-energized)	N.O. side (coil energized)
	SPST, Normally Closed Double Break	DPST, Normally Open
Rated duty	Continuous	
Contact resistance (General Note 2)	0.15 ohm max. initial (measured 1/8" from the header)	
Contact load rating	Low level: 10 to 50 μ A, 10 to 50 mV	
Contact life rating	10,000,000 cycles typical at low level	
Coil operating power	RF310: 450 mW typical @ nominal rated voltage RF313: 200 mW typical @ nominal rated voltage	
Operate time	RF310	4.0 ms. max.
	RF313	6.0 ms. max.
Release time	RF310	3.0 ms. max.
	RF313	3.0 ms. max.
Intercontact capacitance	0.4 pF typical	
Insulation resistance	1,000 M Ω min. (between mutually isolated terminals)	
Dielectric strength	350 VRMS / 60 Hz @ atmospheric pressure	

DETAILED ELECTRICAL SPECIFICATIONS (@25°C)

BASE PART NUMBERS		RF310-5 RF313-5	RF310-12 RF313-12
Coil voltage, nominal, VDC		5.0	12.0
Coil resistance, ohms \pm 20%	RF310	50	390
	RF313	100	850
Pick-up voltage max, VDC		3.6	9.0

OUTLINE DIMENSIONS

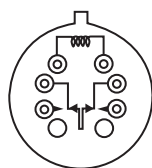
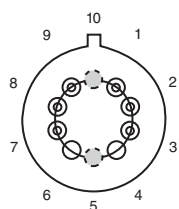

TERMINAL NUMBERING

SCHEMATIC

- HEADER DIMENSIONS, TERMINAL NUMBERING AND SCHEMATIC ARE AS VIEWED FROM THE TERMINALS.
- DIMENSIONS ARE IN INCHES (MILLIMETERS).
- POSITIONS 5 AND 10 ARE FOR UNINSULATED CASE GROUND OPTIONS. SEE APPENDIX.
- NO PROTRUSION BELOW BOTTOM OF HEADER WHEN GROUND PINS ARE INSTALLED.
- TO ORDER THE CASE GROUND OPTION, AFTER THE SERIES DESIGNATOR, ADD "Y" TO THE PART NUMBER FOR POSITION 5 OR "Z" TO THE PART NUMBER FOR POSITION 10.

EXAMPLE: RF310Y-COIL VOLTAGE

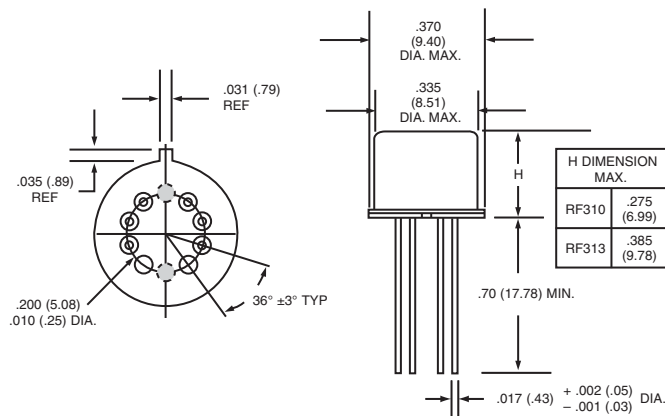

EXTERNAL DIMENSIONS

GENERAL NOTES

1. Relays will exhibit no contact chatter in excess of 10 μ sec or transfer in excess of 1 μ sec.
2. Contact resistance value applies to each closed contact as well as the bypass path.

Appendix A: Spacer Pads

Pad designation and bottom view dimensions	Height	For use with the following:	Dim. H Max.
 <p style="text-align: center;">“M4” Pad for TO-5</p>		ER411T ER412, ER412D, ER412DD	.295 (7.49)
		712, 712D, 712TN, RF300, RF310, RF320	.300 (7.62)
		ER420, ER422D, ER420DD, 421, ER421D, ER421DD, ER422, ER422D, ER422DD, 722, 722D, RF341	.305 (7.75)
		ER431T, ER432T, ER432, ER432D, ER432DD	.400 (10.16)
		732, 732D, 732TN, RF303, RF313, RF323	.410 (10.41)
		RF312	.350 (8.89)
 <p style="text-align: center;">“M4” Pad for TO-5</p>		ER411, ER411D, ER411DD	.295 (7.49)
		ER431, ER431D, ER431DD	.400 (10.16)
		RF311	.300 (7.62)
		RF331	.410 (10.41)
 <p style="text-align: center;">“M4” Pad for Centigrid®</p>		172, 172D	.305 (7.75)
		ER114, ER114D, ER114DD, J114, J114D, J114DD	.300 (7.62)
		ER134, ER134D, ER134DD, J134, J134D, J134DD	.400 (10.16)
		RF100	.315 (8.00)
		RF103	.420 (10.67)
 <p style="text-align: center;">“M9” Pad for Centigrid®</p>		122C, A152	.320 (8.13)
		ER116C, J116C	.300 (7.62)
		ER136C, J136C	.400 (10.16)
		RF180	.325 (8.25)
		A150	.305 (7.75)

Notes:

1. Spacer pad material: Polyester film.
2. To specify an “M4” or “M9” spacer pad, refer to the mounting variants portion of the part numbering example in the applicable datasheet.
3. Dimensions are in inches (mm).
4. Unless otherwise specified, tolerance is $\pm .010$ (.25).
5. Add 10 m Ω to the contact resistance show in the datasheet.
6. Add 0.01 oz. (0.25 g) to the weight of the relay assembly shown in the datasheet.

Appendix A: Spreader Pads

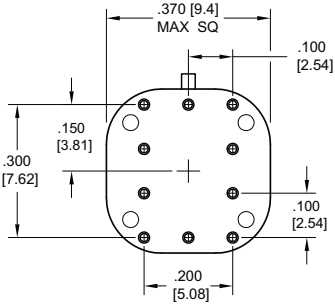
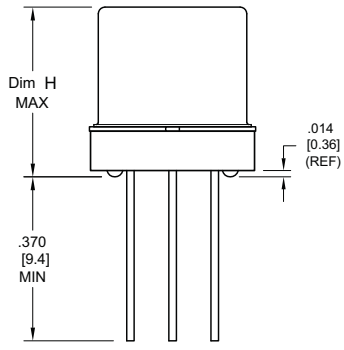
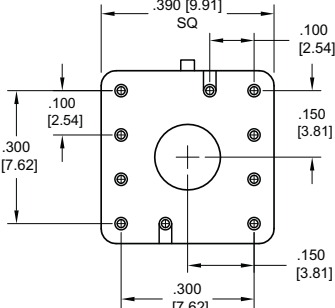
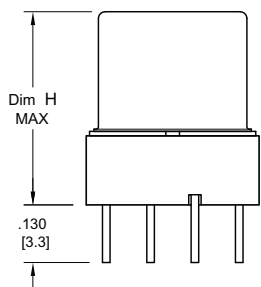
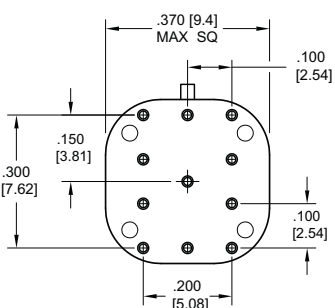
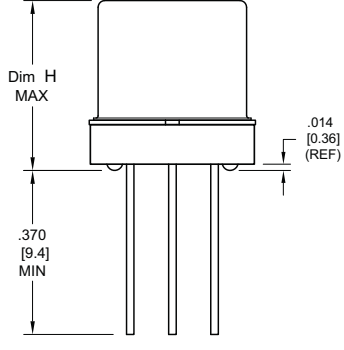
Pad designation and bottom view dimensions	Height	For use with the following:	Dim. H Max.
 <p>“M” Pad <u>5/</u> <u>6/</u> <u>9/</u></p>		ER411T, J411T, ER412, ER412D ER412DD, J412, J412D, J412DD ER412T, J412T	.388 (9.86)
		712, 712D, 712TN	.393 (9.99)
		ER431T, J431T, ER432, ER432D ER432DD, J432, J432D, J432DD ER432T, J432T	.493 (12.52)
		732, 732D, 732TN	.503 (12.78)
		ER420, J420, ER420D, J420D ER420DD, J420DD, ER421, J421 ER421D, J421D, ER421DD J422D, ER422DD, J422DD, 722	.398 (10.11)
 <p>“M2” Pad <u>7/</u> <u>8/</u></p>		ER411T ER412, ER412D, ER412DD J412, J412D, J412DD	.441 (11.20)
		712, 712D	.451 (11.46)
		ER421, ER421D, ER421DD 722, 732D	.451 (11.46)
		ER431T ER432, ER432D, ER432DD	.546 (13.87)
		732, 732D	.556 (14.12)
 <p>“M3” Pad <u>5/</u> <u>6/</u> <u>9/</u></p>		ER411, ER411D, ER411DD ER411TX ER412X, ER412DX, ER412DDX ER412TX	.388 (9.86)
		712X, 712DX, 712TNX	.393 (9.99)
		ER420X, ER420DX, ER420DDX ER421X, ER421DX, ER421DDX ER422X, ER422DX ER422DDX, 722X, 722DDX	.398 (10.11)
		ER431, ER431D, ER431DD ER431TX ER432X, ER432DX, ER432DDX ER432TX	.493 (12.52)
		732X, 732DX, 732TNX	.503 (12.78)

Notes:

1. Spreader pad material: Diallyl Phthalate.
2. To specify an “M”, “M2” or “M3” spreader pad, refer to the mounting variants portion of the part number example in the applicable datasheet.
3. Dimensions are in inches (mm).
4. Unless otherwise specified, tolerance is $\pm .010$ ” (0.25).
- 5/. Add 25 mΩ to the contact resistance shown in the datasheet.
- 6/. Add .01 oz. (0.25 g) to the weight of the relay assembly shown in the datasheet.
- 7/. Add 50 mΩ to the contact resistance shown in the datasheet.
- 8/. Add 0.025 oz (0.71 g) to the weight of the relay assembly shown in the datasheet.
- 9/. M3 pad to be used only when the relay has a center pin (e.g. ER411M3-12A, 722XM3-26.)

Appendix A: Ground Pin Positions



TO-5 Relays:

ER411T, ER412, ER412T, ER420, ER421, ER422,
ER431T, ER432, ER432T, 712, 712TN, 400H, 400K,
400V, RF300, RF303, RF341, RF312, RF310, RF313,
RF320, RF323



TO-5 Relays:

ER411, ER431, RF311, RF331

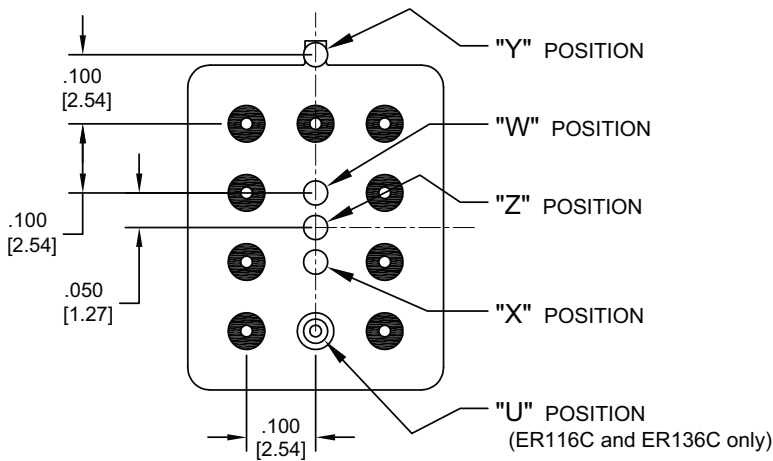

Centigrid® Relays:

RF180, ER116C, 122C, ER136C

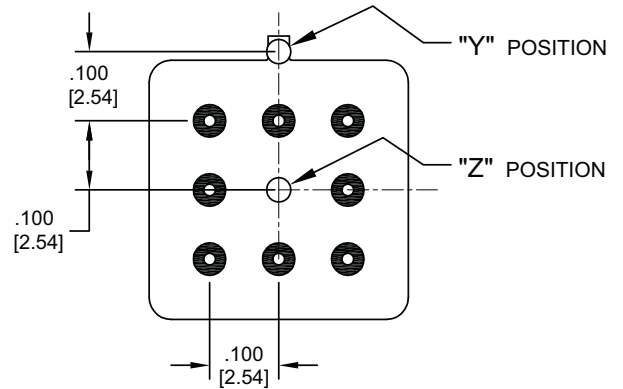

Centigrid® Relays:

RF100, RF103, ER114, ER134, 172

- Indicates ground pin position
- Indicates glass insulated lead position
- ◎ Indicates ground pin or lead position depending on relay type

NOTES

1. Terminal views shown
2. Dimensions are in inches (mm)
3. Tolerances: $\pm .010$ ($\pm .25$) unless otherwise specified
4. Ground pin positions are within $.015$ (0.38) dia. of true position
5. Ground pin head dia., 0.035 (0.89) ref: height 0.010 (0.25) ref.
6. Lead dia. 0.017 (0.43) nom.