

**TELEDYNE  
RELAYS**  
A Teledyne Technologies Company



**HIGH REPEATABILITY  
ULTRAMINIATURE  
BROADBAND  
ATTENUATOR RELAYS**

SERIES  
A152

SERIES DESIGNATION	RELAY TYPE
A152	Attenuator relay series

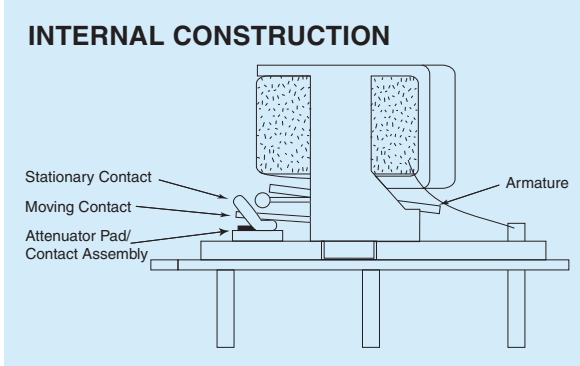

**DESCRIPTION**

The Series A152 highly repeatable ultraminiature attenuator relays are designed for attenuating RF signals in 50-ohm systems over a frequency range from DC to 5 GHz. Their low profile and small grid spacing makes them ideal for use when packaging density is a prime consideration. The A152 relays eliminate the need for additional external resistors/attenuators.

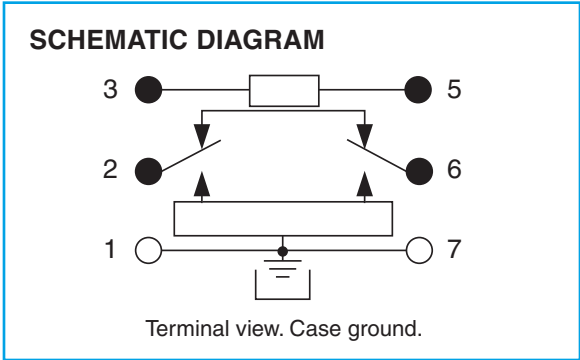

These single section, switchable attenuator relays have an internal matched thin film attenuator pad in a "Pi" configuration. Relays are available in a fixed increment of 20 dB.

The A152 attenuator relay features:

- High repeatability.
- Unique uni-frame motor design which provides high magnetic efficiency and mechanical rigidity.
- Minimum mass components and welded construction for maximum resistance to shock and vibration.
- Advanced cleaning techniques which assures internal cleanliness.
- Gold plated, precious metal contacts, which provide excellent intermodulation performance.
- Flat amplitude vs. frequency response.
- High isolation between control and signal path.
- Stable attenuation vs. temperature.
- Excellent phase linearity.
- Highly resistant to ESD.

**Patent No. 5,315,273**

ENVIRONMENTAL AND PHYSICAL SPECIFICATIONS		
<b>Temperature</b> (Ambient)	<b>Storage</b>	-65°C to +125°C
	<b>Operating</b>	-55°C to +85°C
<b>Vibration</b> (General Note 1)		10 g's to 500 Hz
<b>Shock</b> (General Note 1)		30 g's, 6ms half sine
<b>Enclosure</b>		Hermetically sealed
<b>Weight</b>		0.11 oz. (3.2g) max.

**SERIES A152**  
**GENERAL PERFORMANCE (-55°C to +85°C, unless otherwise specified)**

PARAMETER	MINIMUM	TYPICAL	MAXIMUM	UNITS
Operating Frequency (Note 2)	<b>0.0</b>		<b>5.0</b>	GHz
Power (Notes 5 and 6)			<b>1.0</b>	Watt
Impedance		<b>50</b>		Ohms

PARAMETER	Typical at low level
Contact life rating	10,000,000 cycles

**ELECTRICAL SPECIFICATION (-55°C to +85°C, unless otherwise specified)**

PART NUMBER (Note 7)		A152-dB-5	A152-dB-12	A152-dB-15	A152-dB-26
Coil Voltage Vdc (Note 6)	Nom.	5	12	15	26.5
	Max.	5.8	16.0	20.0	32.0
Coil Resistance Ohms ±20%	@25°C	50	390	610	1560
Pick-up Voltage Vdc Max.	@25°C	3.8	9.0	11.3	18.0
Switching Time ms (Note 8)	Max.	4.0			
	Typ.	2.0			
Insulation Resistance	1,000 MΩ typical (all mutually isolated points)				
Dielectric Strength	300 VRMS / 60 Hz typical (at sea level)				

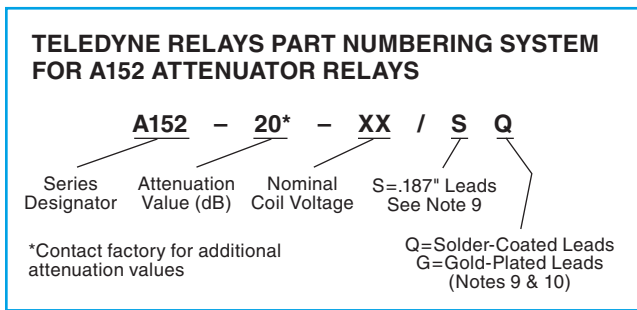
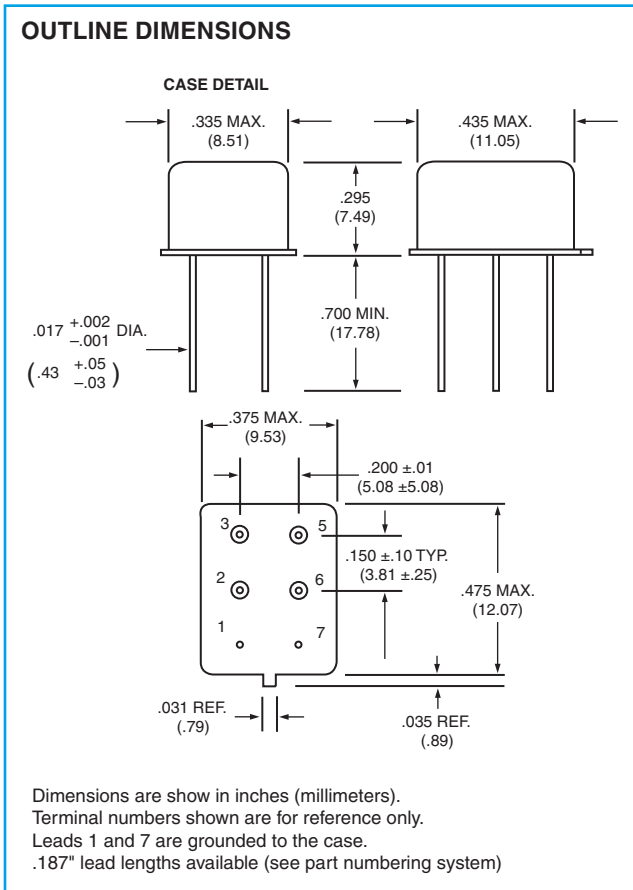

- GENERAL NOTES**
1. Contacts will exhibit no contact chatter in excess of 10 μs or transfer in excess of 1 μs.
  2. Relays may be operated at higher frequencies with reduced RF performance.
  3. For optimal RF performance, solder case to RF ground plane.
  4. Attenuation values shown are with reference to the through path (low loss state).
  5. Power handling for case temperatures of -55°C to +55°C is 1 Watt. Derate power handling 25 mW/°C above +55°C. Case measurement point is adjacent to the relay tab.
  6. Do not operate coil at maximum coil voltage continuously.
  7. Insert attenuation value, see part numbering system.
  8. Switching time includes bounce.
  9. The slash and characters appearing after the slash are not marked on the relay.
  10. Unless otherwise specified, relays will be supplied with either gold-plated or solder-coated leads.

**RF PERFORMANCE (-55°C to +85°C, unless otherwise specified) (Notes 2, 3 and 4)**

PARAMETER	MINIMUM	TYPICAL	MAXIMUM	UNITS	CONDITION
Insertion Loss		0.1	0.25	dB	DC-1 GHz
		0.2	0.35	dB	1-2 GHz
		0.3	.055	dB	2-3 GHz
		See graph			3-5 GHz
VSWR (Through path)		1.10	1.20		DC-1 GHz
		1.20	1.25		1-2 GHz
		1.25	1.30		2-3 GHz
		See graph			3-5 GHz
VSWR (Attenuated path)		1.20	1.25		DC-1 GHz
		1.30	1.35		1-2 GHz
		1.40	1.45		2-3 GHz
		See graph			3-5 GHz

ATTENUATION	MINIMUM	TYPICAL	MAXIMUM	UNITS	CONDITION
5	4.75	5.0	5.25	dB	DC-1 GHz
	4.62	5.0	5.38	dB	1-2 GHz
	4.37	5.0	5.63	dB	2-3 GHz
		See graph			3-5 GHz

ATTENUATION	MINIMUM	TYPICAL	MAXIMUM	UNITS	CONDITION
20	19.8	20.0	20.2	dB	DC-1 GHz
	19.6	20.0	20.4	dB	1-2 GHz
	19.0	20.0	21.0	dB	2-3 GHz
		See graph			3-5 GHz

Contact factory for additional attenuation values

**SERIES A152  
TYPICAL RF PERFORMANCE (Notes 2, 3 and 4)**

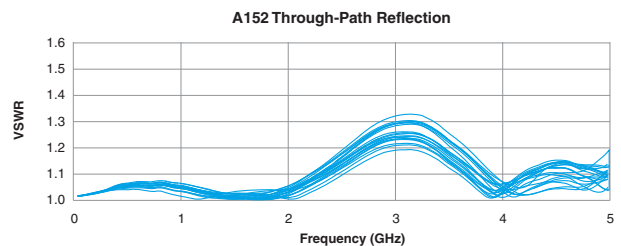
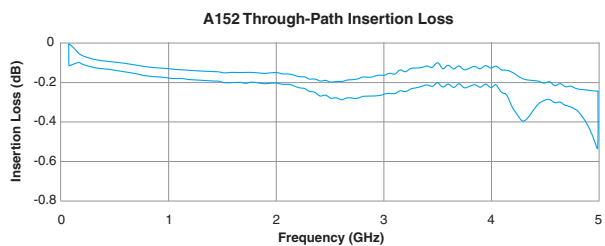
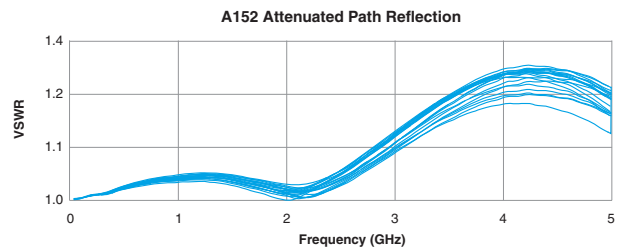
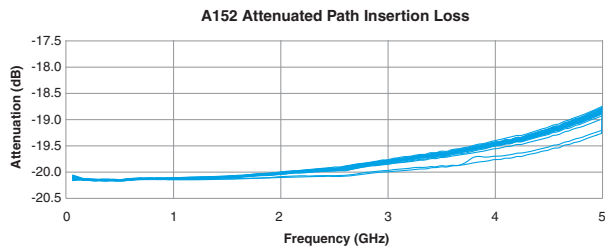

**SERIES A152**  
**TYPICAL RF INSERTION LOSS REPEATABILITY CHARACTERISTICS (Notes 1 and 3)**

**A152 Insertion Loss Repeatability  
(Through Path)**

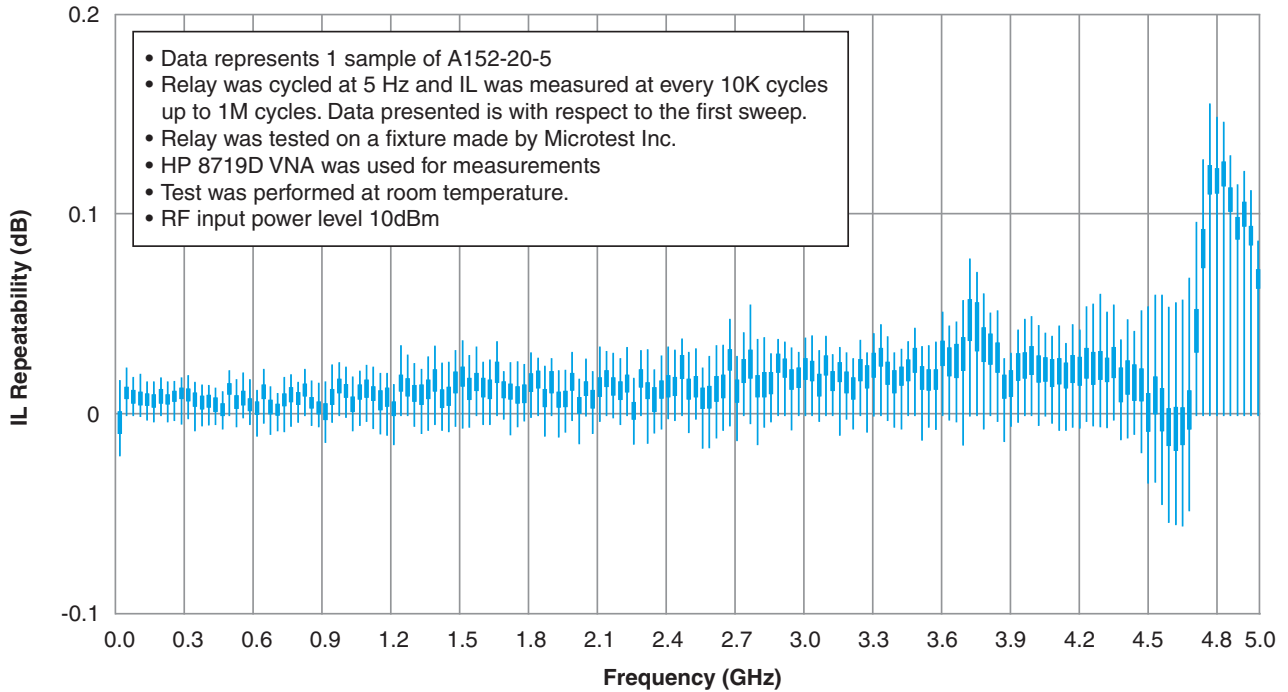

**A152 Insertion Loss Repeatability  
(Attenuated Path)**

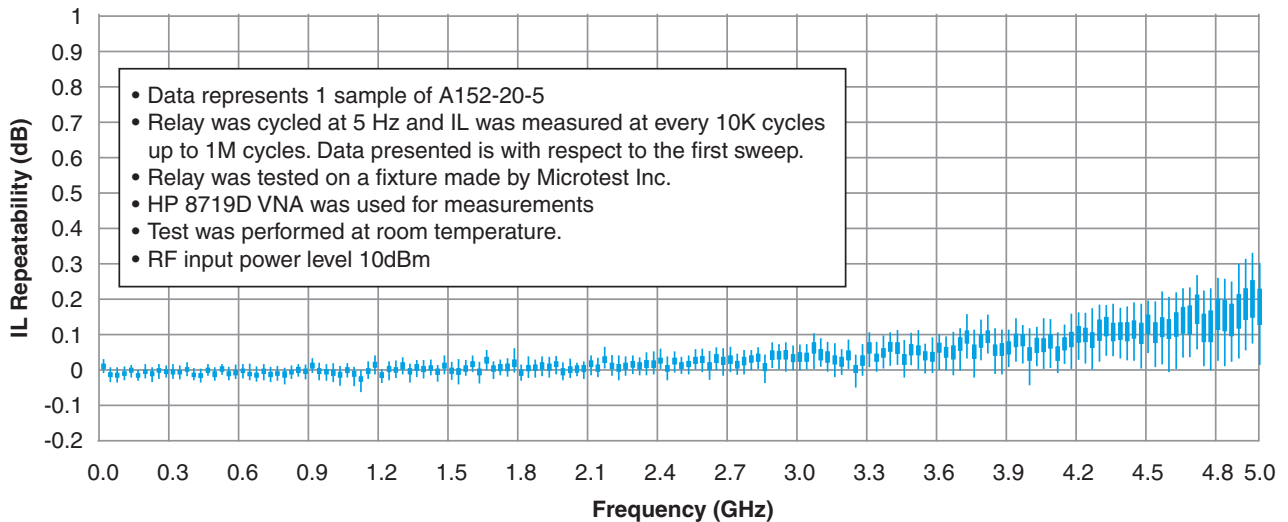

**RF INSERTION LOSS REPEATABILITY NOTES**

1. Test conditions:
  - a. Fixture: Custom plug-in test fixture.
  - b. Relay header is in contact with, but not soldered to, ground plane.
  - c. Test performed at room ambient temperature.
  - d. Contact signal level: 10 dBm.
2. Data presented herein represents typical characteristics and is not intended for use as specification limits.
3. Insertion loss repeatability measured over frequency range from 3 MHz to 5 GHz.

# Appendix A: Spacer Pads

Pad designation and bottom view dimensions	Height	For use with the following:	Dim. H Max.
 <p style="text-align: center;">“M4” Pad for TO-5</p>		ER411T ER412, ER412D, ER412DD	.295 (7.49)
		712, 712D, 712TN, RF300, RF310, RF320	.300 (7.62)
		ER420, ER422D, ER420DD, 421, ER421D, ER421DD, ER422, ER422D, ER422DD, 722, 722D, RF341	.305 (7.75)
		ER431T, ER432T, ER432, ER432D, ER432DD	.400 (10.16)
		732, 732D, 732TN, RF303, RF313, RF323	.410 (10.41)
		RF312	.350 (8.89)
 <p style="text-align: center;">“M4” Pad for TO-5</p>		ER411, ER411D, ER411DD	.295 (7.49)
		ER431, ER431D, ER431DD	.400 (10.16)
		RF311	.300 (7.62)
		RF331	.410 (10.41)
 <p style="text-align: center;">“M4” Pad for Centigrid®</p>		172, 172D	.305 (7.75)
		ER114, ER114D, ER114DD, J114, J114D, J114DD	.300 (7.62)
		ER134, ER134D, ER134DD, J134, J134D, J134DD	.400 (10.16)
		RF100	.315 (8.00)
		RF103	.420 (10.67)
 <p style="text-align: center;">“M9” Pad for Centigrid®</p>		122C, A152	.320 (8.13)
		ER116C, J116C	.300 (7.62)
		ER136C, J136C	.400 (10.16)
		RF180	.325 (8.25)
		A150	.305 (7.75)

**Notes:**

1. Spacer pad material: Polyester film.
2. To specify an “M4” or “M9” spacer pad, refer to the mounting variants portion of the part numbering example in the applicable datasheet.
3. Dimensions are in inches (mm).
4. Unless otherwise specified, tolerance is  $\pm .010$  (.25).
5. Add 10 m $\Omega$  to the contact resistance show in the datasheet.
6. Add 0.01 oz. (0.25 g) to the weight of the relay assembly shown in the datasheet.

# Appendix A: Spreader Pads

Pad designation and bottom view dimensions	Height	For use with the following:	Dim. H Max.
<p>“M” Pad <u>5/</u> <u>6/</u> <u>9/</u></p>		ER411T, J411T, ER412, ER412D ER412DD, J412, J412D, J412DD ER412T, J412T	.388 (9.86)
		712, 712D, 712TN	.393 (9.99)
		ER431T, J431T, ER432, ER432D ER432DD, J432, J432D, J432DD ER432T, J432T	.493 (12.52)
		732, 732D, 732TN	.503 (12.78)
		ER420, J420, ER420D, J420D ER420DD, J420DD, ER421, J421 ER421D, J421D, ER421DD J422D, ER422DD, J422DD, 722	.398 (10.11)
<p>“M2” Pad <u>7/</u> <u>8/</u></p>		ER411T ER412, ER412D, ER412DD J412, J412D, J412DD	.441 (11.20)
		712, 712D	.451 (11.46)
		ER421, ER421D, ER421DD 722, 732D	.451 (11.46)
		ER431T ER432, ER432D, ER432DD	.546 (13.87)
		732, 732D	.556 (14.12)
<p>“M3” Pad <u>5/</u> <u>6/</u> <u>9/</u></p>		ER411, ER411D, ER411DD ER411TX ER412X, ER412DX, ER412DDX ER412TX	.388 (9.86)
		712X, 712DX, 712TNX	.393 (9.99)
		ER420X, ER420DX, ER420DDX ER421X, ER421DX, ER421DDX ER422X, ER422DX ER422DDX, 722X, 722DDX	.398 (10.11)
		ER431, ER431D, ER431DD ER431TX ER432X, ER432DX, ER432DDX ER432TX	.493 (12.52)
		732X, 732DX, 732TNX	.503 (12.78)

## Notes:

1. Spreader pad material: Diallyl Phthalate.
2. To specify an “M”, “M2” or “M3” spreader pad, refer to the mounting variants portion of the part number example in the applicable datasheet.
3. Dimensions are in inches (mm).
4. Unless otherwise specified, tolerance is  $\pm .010$ ” (0.25).
- 5/. Add 25 m $\Omega$  to the contact resistance shown in the datasheet.
- 6/. Add .01 oz. (0.25 g) to the weight of the relay assembly shown in the datasheet.
- 7/. Add 50 m $\Omega$  to the contact resistance shown in the datasheet.
- 8/. Add 0.025 oz (0.71 g) to the weight of the relay assembly shown in the datasheet.
- 9/. M3 pad to be used only when the relay has a center pin (e.g. ER411M3-12A, 722XM3-26.)

# Appendix A: Ground Pin Positions

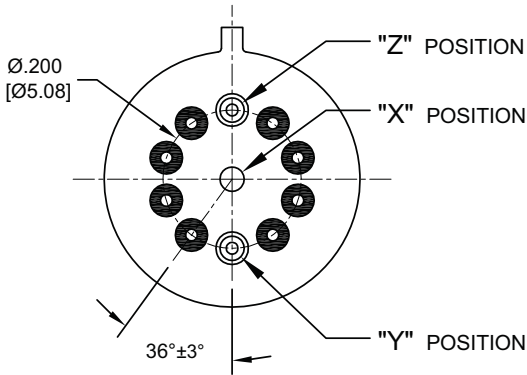

### TO-5 Relays:

ER411T, ER412, ER412T, ER420, ER421, ER422,  
ER431T, ER432, ER432T, 712, 712TN, 400H, 400K,  
400V, RF300, RF303, RF341, RF312, RF310, RF313,  
RF320, RF323

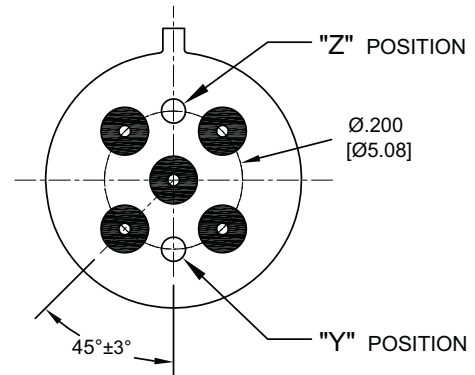

### TO-5 Relays:

ER411, ER431, RF311, RF331



### Centigrid® Relays:

RF180, ER116C, 122C, ER136C

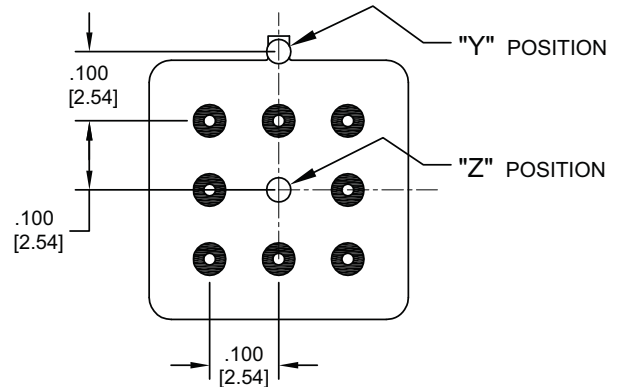

### Centigrid® Relays:

RF100, RF103, ER114, ER134, 172

- Indicates ground pin position
- Indicates glass insulated lead position
- ⊙ Indicates ground pin or lead position depending on relay type

### NOTES

1. Terminal views shown
2. Dimensions are in inches (mm)
3. Tolerances:  $\pm .010$  ( $\pm .25$ ) unless otherwise specified
4. Ground pin positions are within  $.015$  ( $0.38$ ) dia. of true position
5. Ground pin head dia.,  $0.035$  ( $0.89$ ) ref: height  $0.010$  ( $0.25$ ) ref.
6. Lead dia.  $0.017$  ( $0.43$ ) nom.