

## COMMERCIAL SENSITIVE TO-5 RELAYS DPDT

SERIES	RELAY TYPE
732	DPDT basic relay
732D	DPDT relay with internal diode for coil transient suppression
732TN	DPDT relay with internal transistor driver and coil transient suppression diode

### DESCRIPTION

The TO-5 relay, originally conceived and developed by Teledyne, has become one of the industry standards for low-level switching from dry circuit to 1 ampere. Designed for high-density PC board mounting, the Series 732 relays are some of the most versatile ultraminiature relays available because of their small size and low coil power dissipation.

The following unique construction features and manufacturing techniques provide excellent resistance to environmental extremes and overall high reliability:

#### The 732 feature:

- All welded construction.
- Unique uni-frame design providing high magnetic efficiency and mechanical rigidity.
- High force/mass ratios for resistance to shock and vibration.

- Advanced cleaning techniques provide maximum assurance of internal cleanliness.
- Precious metal alloy contact material with gold plating assures excellent high current and dry circuit switching capabilities.

The Series 732D relay has an internal discrete silicon diode for coil transient suppression. The hybrid Series 732TN relay has an internal silicon diode and transistor driver. The integrated packaging of the relay with its associated semiconductor devices greatly reduces PC board floor space requirements as well as component installation costs.

By virtue of its inherently low intercontact capacitance and contact circuit losses, the 732 has proven to be excellent ultraminiature RF switch for frequency ranges well into the UHF spectrum. A typical RF application for the TO-5 relay is in handheld radio transceivers, wherein the combined features of good RF performance, small size, low coil power dissipation and high reliability make it a preferred method of Transmit-Receive switching.

### Part Numbering System

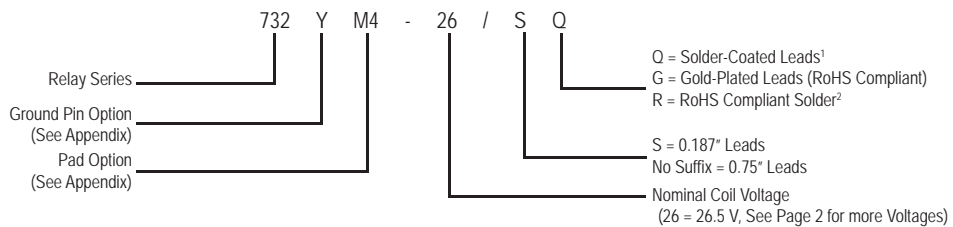

ENVIRONMENTAL AND PHYSICAL SPECIFICATIONS		
Temperature (Ambient)	Storage	-65°C to +125°C
	Operating	-55°C to +85°C
Vibration (General Note I)		10 g's to 500 Hz
Shock (General Note I)		30 g's, 6ms half sine
Enclosure		Hermetically sealed
Weight		0.09 oz. (2.55g) max.

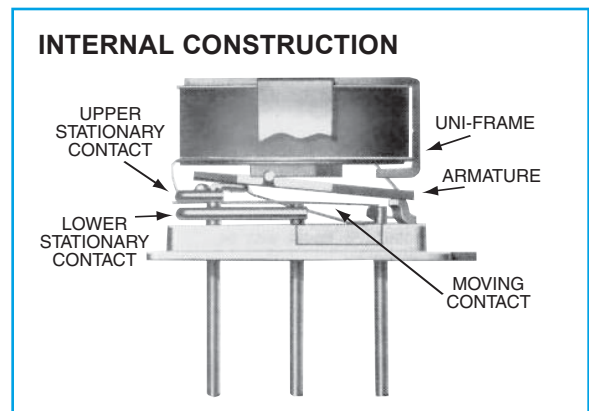

**SERIES 732**  
**GENERAL ELECTRICAL SPECIFICATIONS (@25°C)**

<b>Contact Arrangement</b>	2 Form C (DPDT)	
<b>Rated Duty</b>	Continuous	
<b>Contact Resistance</b>	0.15 Ω max.; 0.25 Ω max. afterlife at A / 28 Vdc	
<b>Contact Load Rating (DC)</b>	Resistive: 1 A / 28 Vdc Inductive: 200 mA / 28 Vdc (320mH) Lamp: 100 mA / 28 Vdc (320mH) Low level: 10 to 50 μA @ 10 to 50 mV	
<b>Contact Load Rating (AC)</b>	Resistive: 250 mA / 115Vac, 60 and 400 Hz (Case not grounded) 100 mA / 115 Vac, 60 and 400 Hz (Case grounded)	
<b>Contact Life Ratings</b>	10,000,000 cycles (typical) at low level 1,000,000 cycles (typical) at 0.5 A / 28 Vdc resistive 100,000 cycles min. at all other loads specified above	
<b>Contact Overload Rating</b>	2 A / 28 Vdc Resistive (100 cycles min.)	
<b>Coil Operating Power</b>	200 mW typical at nominal rated voltage	
<b>Contact Carry Rating</b>	Contact Factory	
<b>Operate Time</b>	6.0 msec max. at nominal rated coil voltage	
<b>Release Time</b>	732: 3.0 ms max.	732D, 732TN: 7.5 ms max.
<b>Intercontact Capacitance</b>	0.4 pf typical	
<b>Insulation Resistance</b>	1,000 MΩ min. between mutually isolated terminals	
<b>Dielectric Strength</b>	350 Vrms (60 Hz) @ atmospheric pressure	
<b>Negative Coil Transient (Vdc)</b>	2.0 Vdc Max.	
<b>Diode P.I.V. (Vdc)</b>	60 Vdc Min.	
<b>732TN Transistor Characteristics</b>	Base Voltage to Turn Off (Vdc)	0.3 min
	Emitter-Base breakdown Voltage (BV <sub>EBO</sub> ) (Vdc)	6.0 min
	Collector-Base breakdown Voltage (BV <sub>CBO</sub> ) (Vdc)	60 min

**DETAILED ELECTRICAL SPECIFICATIONS (@25°C)**

BASE PART NUMBERS (732, 732D, 732TN)	732-5	732-6	732-9	732-12	732-18	732-26	
	732D-5 732TN-5	732D-6 732TN-6	732D-9 732TN-9	732D-12 732TN-12	732D-18 732TN-18	732D-26 732TN-26	
<b>Coil Voltage</b>	Nom.	5.0	6.0	9.0	12.0	18.0	26.5
	Max.	7.5	10.0	15.0	20.0	30.0	40.0
<b>Coil Resistance (Ohms ±20%)</b>	100	200	400	850	1600	3300	
<b>Pick-up Voltage (Vdc, Max.) Pulse Operation</b>	3.5	4.5	6.8	9.0	13.5	18.0	
<b>732TN Base Current to Turn On (mAdc, min.)</b>	1.5	1.00	0.75	0.47	0.38	0.24	

**PERFORMANCE CURVES (Note 2)**

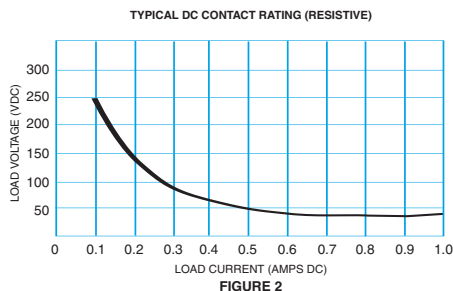
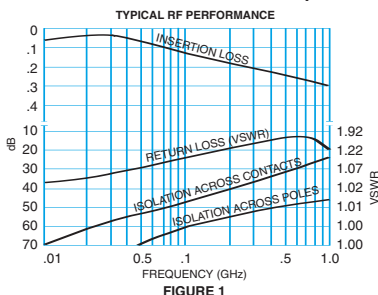

**GENERAL NOTES**

1. Relay contacts will exhibit no chatter in excess of 10 μsec or transfer in excess of 1 μsec.
2. "Typical" characteristics are based on available data and are best estimates. No on-going verification tests are performed.
3. Unless otherwise specified, parameters are initial values.
4. Relays can be supplied with a spacer pad. See appendix.

**SERIES 732  
OUTLINE DIMENSIONS**

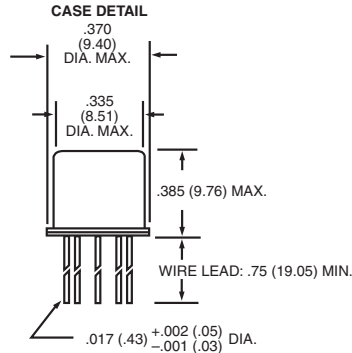

**TERMINAL LOCATIONS AND PIN NUMBERING (REF. ONLY)**  
(Viewed from Terminals)

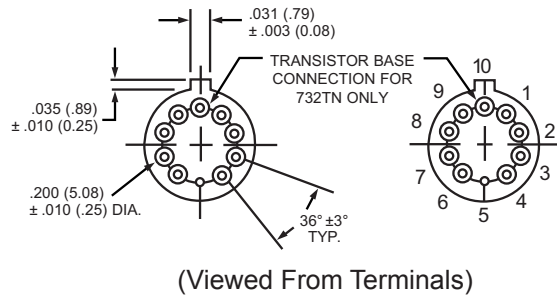

**SCHEMATIC DIAGRAMS**

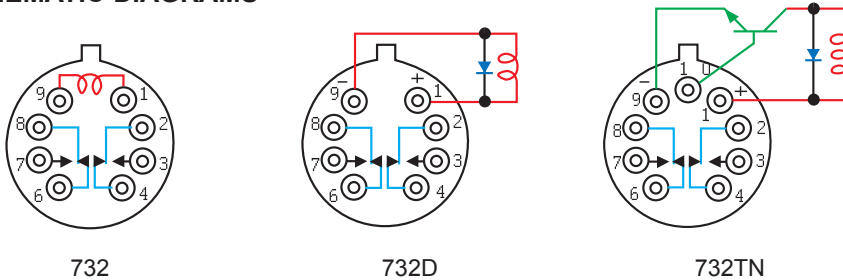

**NOTES:**

1. RELAY CONTACTS WILL EXHIBIT NO CHATTER IN EXCESS OF 10 MSEC OR TRANSFER IN EXCESS OF 1 MSEC.
2. "TYPICAL" CHARACTERISTICS ARE BASED ON AVAILABLE DATA AND ARE BEST ESTIMATES. NO ON-GOING VERIFICATION TESTS ARE PERFORMED.
3. UNLESS OTHERWISE SPECIFIED, PARAMETERS ARE INITIAL VALUES.
4. FOR REFERENCE ONLY. COIL RESISTANCE NOT DIRECTLY MEASURABLE ON 732TN RELAYS.
5. CIRCUIT IS TYPICAL FOR ALL SERIES 732TN. VALUES SHOWN ARE FOR 732TN-5 RELAY AND APPLY FOR FULL TEMPERATURE RANGE. LIMIT BASE-EMITTER CURRENT TO 15 MADC.
6. UNLESS OTHERWISE SPECIFIED, RELAYS WILL BE SUPPLIED WITH EITHER GOLD-PLATED OR SOLDER-COATED LEADS.
7. THE SLASH AND CHARACTERS APPEARING AFTER THE SLASH ARE NOT MARKED ON THE RELAY.

**TYPICAL LOGIC INTERFACE**  
(See Note 5)

