

# Pad Cutters, Insertion Tools

## Pad Cutters



P138A  
Wooden Handle type



Shank Only  
P138C

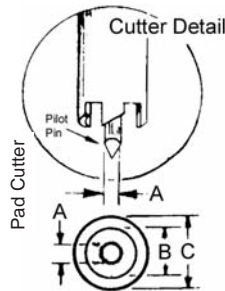

Shows pad removal  
& pad cutter P116C

Vector Pad Cutters provide an effective method for creating isolated solder pads around holes in copper clad boards. Pilot pin enters hole and rotates, creating a clearance area around the solder pad. Available for boards with .062" or .042" diameter holes. Also available without handles for use with manual or power drills.

Part No.	Holder Type	A	B	C	Shank	Use with Vectorbord®
P116C	Handle/Shank	.055"	.188"	.250"	.250"	Pattern G, H, .062" holes
P138A	Handle/Shank	.040"	.086"	.125"	.125"	Pattern P, .042" holes
P138C	Shank Only	.040"	.086"	.125"	.125"	Pattern P, .042" holes

## Hand Insertion Tools for Push-In Terminals

Part No	Terminal P/N	Holder Type
A13	T44	Shank with removable rubber handle
A13-1	T68	Shank with removable rubber handle
P91A	T28	Wooden Handle
P156	T49	Wooden Handle
P133A	T46 series & K24 - K31	Shank with removable rubber handle
P134	K36	Wooden Handle
P149A	T42-1	Wooden Handle
P149	T42-1	Shank with removable rubber handle

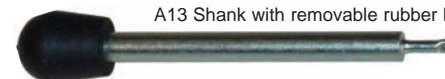

A13 Shank with removable rubber handle



P149 Shank with removable rubber handle



P149A - Wooden Handle Type

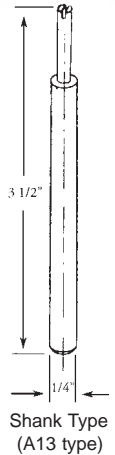

Shank Type (A13 type)

## T107

### Bus Strips

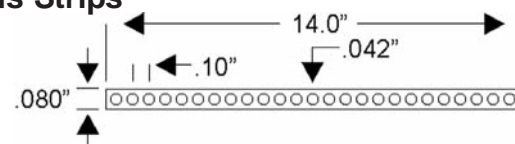

- Flat cold-drawn flat copper wire, 0.017" thick (+/-0.003")
- 0.080"W with 0.042" diameter holes on 0.100" centers
- Hot 100% Tin dipped, fully RoHS compliant
- Compatible with most Vectorbord® hole patterns



Part No.	Pkg Qty
T107/C	100
T107/10	10

## HA14

### Pull Type Ejector Handle

- Extraction/insertion handles
- Mounts on front edge of Plugbord™ with single screw or roll-pin
- Plastic (FE4)

Part No.	Package Quantity
HA14	4
HA14/C	100

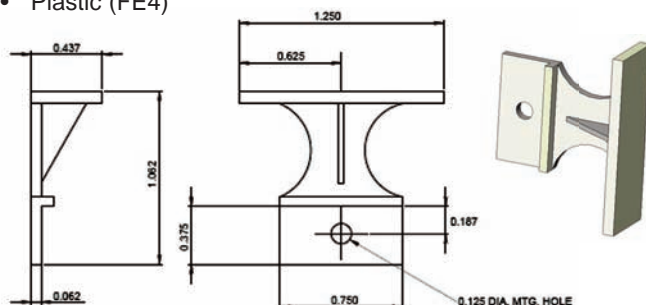

## HA9

### Rotation Type Ejector Handle

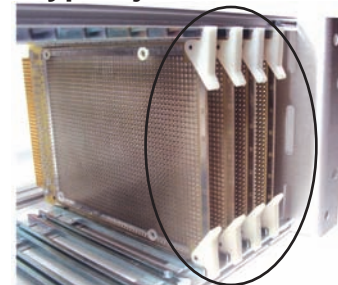

Dimensional information for HA9 is on Page 44

- Card ejector, corner mounting
  - Supports up to 40 lbs extraction force
  - White nylon, (hardware included)
- | Part No. | Pkg Qty |
|----------|---------|
| HA9/4    | 4       |
| HA9/C    | 100     |

### Tefzel 28 AWG Wire Insulation Properties

Property	Test Method	Unit	Value
<b>Thermal Properties</b>			
Nominal Melting Point	ASTM D3159	°C (°F)	255-280 (491-536)
Flow Rate	ASTM D315	g/10 min	20
Upper Service Temperature	UL746	°C	135
<b>Mechanical Properties</b>			
Tensile Strength, 23°C (73°F)	ASTM D3159	MPa, (psi)	40, (6,500)
Specific Gravity	ASTM D792	-	1.71
Ultimate Elongation, 23°C (73°F)	ASTM D3159	%	300
Flexural Modulus, 23°C (73°F)	ASTM D790	MPa (psi)	1,200 (170,000)
Impact Strength, 23°C (73°F)	ASTM D256	J/m (ft-lb/in.)	No Break
Hardness, Durometer	ASTM D2240	Shore D	63
Compressive Strength	ASTM D695	MPa, (psi)	38 (5,500)
Linear Coefficient of Expansion, 0-100°C (32-212°F)	ASTM E831	mm/mm/°C in./in./°F	12.6x 10 <sup>-5</sup> (7.0 x 10 <sup>-5</sup> )

#### Electrical Properties

Dielectric Strength, 0.25mm (0.010in.)	ASTM D149	kV/mm (V/0.001in.)	70 (1,800)
Dielectric Constant, 1MHz, 23°C (73°F)	ASTM D1531	-	2.5-2.6
Dissipation Factor, 1MHz, 23°C (73°F)	ASTM D1531	-	0.00540
Volume Resistivity	ASTM D257	ohm cm	1 x 10 <sup>11</sup> (1 x 10 <sup>11</sup> )
Arc Resistance	ASTM D49	seconds	122

#### General Properties

Water Absorption, 24 h	ASTM D570	%	0.007
Weather and Chemical Resistance	-	-	Excellent
Limiting Oxygen Index	ASTM D2863	%	30-32

Vector 28AWG Tefzel wire is rated 300V at 150 degrees C

### Slit-N-Wrap® Wire

Tefzel Insulated Silver Plated Wire for use with No. 02 Bit

Part No.	AWG	Color	Spool Dia.	Feet/Spool	Spools/Pkg
W28-6A	28	green	1"	50	2
W28-6B	28	red	1"	50	2
W28-6D	28	blue	1"	50	2
W28-6E	28	white	1"	50	2
W28-6F	28	yellow	1"	50	2
W28-6H	28	black	1"	50	2
W28-6AU	28	green	1.5"	150	1
W28-6BU	28	red	1.5"	150	1
W28-6DU	28	blue	1.5"	150	1
W28-6EU	28	white	1.5"	150	1
W28-6FU	28	yellow	1.5"	150	1
W28-6HU	28	black	1.5"	150	1

See specifications on Page 81



### T120-1

#### Slip-On Contacts

- Reels of slip-on contacts. 5" apart
- Slips onto .025" square posts
- 28 gage PVC insulated blue wire
- Temperature Range: -310 to 221°F (-190 to 105°C)

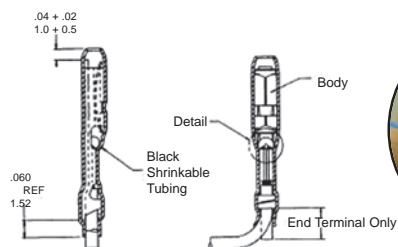
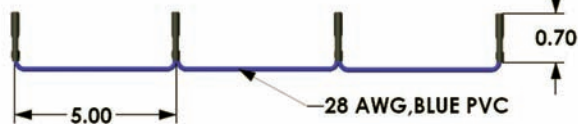

Part No.	Contact Description	Package Quantity.
T120-1/50	installed on wire	Reel of 50
T120-1/250	installed on wire	Reel of 250

### Eyelets T15.23, T123

- 2 versions provide hole size reduction
- T123 - reduces .055" dia. holes to .042"
- T123 eyelets are copper with .0003" to .0005" thick tin plating
- T15.23 - reduces .062" dia. holes to .042"
- Simulates copper thru hole plating
- Used to commit power and ground planes

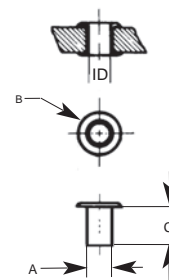
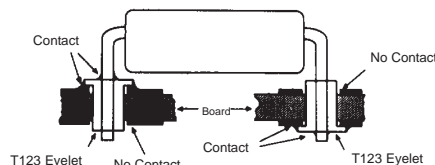

Part No.	Qty	A	B	C	ID
T15.23/M	1000	.062"	.105"	.093"	.042"
T123/500	500	.055"	.105"	.093"	.042"
T123/1000	1000	.055"	.105"	.093"	.042"