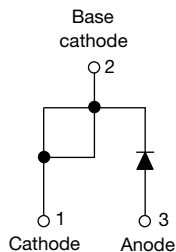

HEXFRED[®], Ultrafast Soft Recovery Diode, 15 A

TO-220AC

FEATURES

- Ultrafast and ultrasoft recovery
- Very low I_{RRM} and Q_{rr}
- Designed and qualified according to JEDEC[®]-JESD47
- Material categorization: for definitions of compliance please see www.vishay.com/doc?99912

RoHS
 COMPLIANT
 HALOGEN
FREE
 Available

BENEFITS

- Reduced RFI and EMI
- Reduced power loss in diode and switching transistor
- Higher frequency operation
- Reduced snubbing
- Reduced parts count

DESCRIPTION

VS-HFA15TB60... is a state of the art ultrafast recovery diode. Employing the latest in epitaxial construction and advanced processing techniques it features a superb combination of characteristics which result in performance which is unsurpassed by any rectifier previously available. With basic ratings of 600 V and 15 A continuous current, the VS-HFA15TB60... is especially well suited for use as the companion diode for IGBTs and MOSFETs. In addition to ultrafast recovery time, the HEXFRED[®] product line features extremely low values of peak recovery current (I_{RRM}) and does not exhibit any tendency to “snap-off” during the t_b portion of recovery. The HEXFRED features combine to offer designers a rectifier with lower noise and significantly lower switching losses in both the diode and the switching transistor. These HEXFRED advantages can help to significantly reduce snubbing, component count and heatsink sizes. The HEXFRED VS-HFA15TB60... is ideally suited for applications in power supplies and power conversion systems (such as inverters), motor drives, and many other similar applications where high speed, high efficiency is needed.

PRODUCT SUMMARY

| | |
|-----------------|------------|
| Package | TO-220AC |
| $I_{F(AV)}$ | 15 A |
| V_R | 600 V |
| V_F at I_F | 1.2 V |
| t_{rr} typ. | 23 ns |
| T_J max. | 150 °C |
| Diode variation | Single die |

ABSOLUTE MAXIMUM RATINGS

| PARAMETER | SYMBOL | TEST CONDITIONS | VALUES | UNITS |
|--|----------------|-----------------------|-------------|-------|
| Cathode to anode voltage | V_R | | 600 | V |
| Maximum continuous forward current | I_F | $T_C = 100\text{ °C}$ | 15 | A |
| Single pulse forward current | I_{FSM} | | 150 | |
| Maximum repetitive forward current | I_{FRM} | | 60 | |
| Maximum power dissipation | P_D | $T_C = 25\text{ °C}$ | 74 | W |
| | | $T_C = 100\text{ °C}$ | 29 | |
| Operating junction and storage temperature range | T_J, T_{Stg} | | -55 to +150 | °C |



| ELECTRICAL SPECIFICATIONS ($T_J = 25\text{ }^\circ\text{C}$ unless otherwise specified) | | | | | | |
|---|----------|---|------|------|------|---------------|
| PARAMETER | SYMBOL | TEST CONDITIONS | MIN. | TYP. | MAX. | UNITS |
| Cathode to anode breakdown voltage | V_{BR} | $I_R = 100\text{ }\mu\text{A}$ | 600 | - | - | V |
| Maximum forward voltage | V_{FM} | $I_F = 15\text{ A}$ | - | 1.3 | 1.7 | |
| | | $I_F = 30\text{ A}$ | - | 1.5 | 2.0 | |
| | | $I_F = 15\text{ A}, T_J = 125\text{ }^\circ\text{C}$ | - | 1.2 | 1.6 | |
| Maximum reverse leakage current | I_{RM} | $V_R = V_R$ rated | - | 1.0 | 10 | μA |
| | | $T_J = 125\text{ }^\circ\text{C}, V_R = 0.8 \times V_R$ rated | - | 400 | 1000 | |
| Junction capacitance | C_T | $V_R = 200\text{ V}$ | - | 25 | 50 | pF |
| Series inductance | L_S | Measured lead to lead 5 mm from package body | - | 8.0 | - | nH |

| DYNAMIC RECOVERY CHARACTERISTICS ($T_J = 25\text{ }^\circ\text{C}$ unless otherwise specified) | | | | | | |
|--|-------------------|---|------|------|------|------------------------|
| PARAMETER | SYMBOL | TEST CONDITIONS | MIN. | TYP. | MAX. | UNITS |
| Reverse recovery time See fig. 5 | t_{rr} | $I_F = 1.0\text{ A}, di_F/dt = 200\text{ A}/\mu\text{s}, V_R = 30\text{ V}$ | - | 19 | - | ns |
| | t_{rr1} | $T_J = 25\text{ }^\circ\text{C}$ | - | 42 | 60 | |
| | t_{rr2} | $T_J = 125\text{ }^\circ\text{C}$ | - | 74 | 120 | |
| Peak recovery current See fig. 6 | I_{RRM1} | $T_J = 25\text{ }^\circ\text{C}$ | - | 4.0 | 6.0 | A |
| | I_{RRM2} | $T_J = 125\text{ }^\circ\text{C}$ | - | 6.5 | 10 | |
| Reverse recovery charge See fig. 7 | Q_{rr1} | $T_J = 25\text{ }^\circ\text{C}$ | - | 84 | 180 | nC |
| | Q_{rr2} | $T_J = 125\text{ }^\circ\text{C}$ | - | 241 | 600 | |
| Peak rate of fall of recovery current during t_b See fig. 8 | $dl_{(rec)M}/dt1$ | $T_J = 25\text{ }^\circ\text{C}$ | - | 188 | - | $\text{A}/\mu\text{s}$ |
| | $dl_{(rec)M}/dt2$ | $T_J = 125\text{ }^\circ\text{C}$ | - | 160 | - | |

| THERMAL - MECHANICAL SPECIFICATIONS | | | | | | |
|--|------------|------------------------------------|--------------|------|------------|------------------------|
| PARAMETER | SYMBOL | TEST CONDITIONS | MIN. | TYP. | MAX. | UNITS |
| Lead temperature | T_{lead} | 0.063" from case (1.6 mm) for 10 s | - | - | 300 | $^\circ\text{C}$ |
| Thermal resistance, junction to case | R_{thJC} | | - | - | 1.7 | K/W |
| Thermal resistance, junction to ambient | R_{thJA} | Typical socket mount | - | - | 80 | |
| Weight | | | - | 2.0 | - | g |
| | | | - | 0.07 | - | oz. |
| Mounting torque | | | 6.0 (5.0) | - | 12 (10) | kgf · cm (lbf · in) |
| Marking device | | Case style TO-220AC | HFA15TB60 | | | |

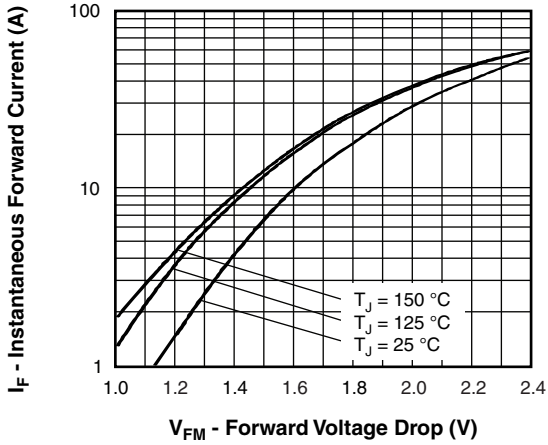

Fig. 1 - Maximum Forward Voltage Drop vs. Instantaneous Forward Current

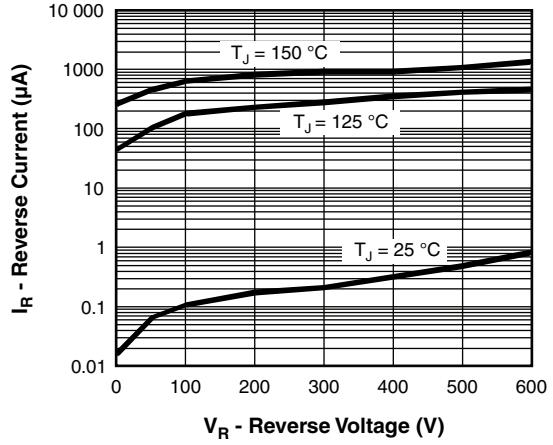

Fig. 2 - Typical Reverse Current vs. Reverse Voltage

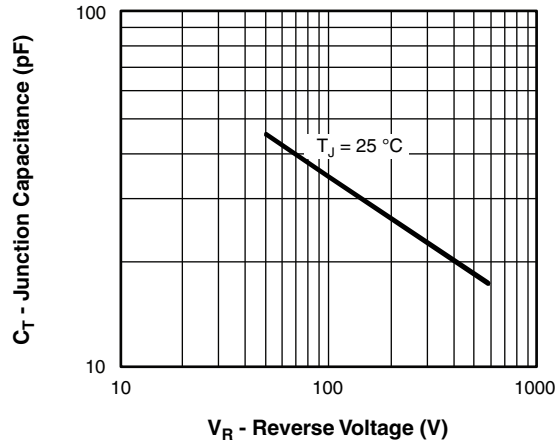

Fig. 3 - Typical Junction Capacitance vs. Reverse Voltage

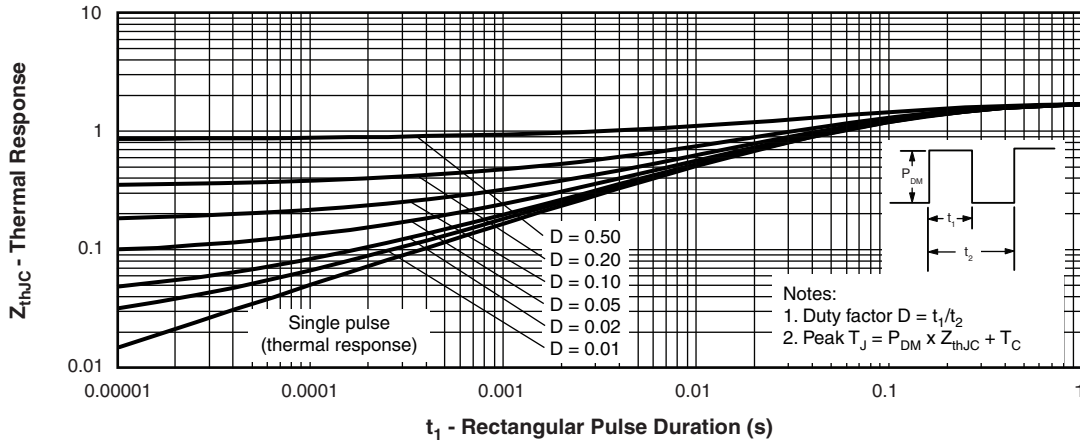

Fig. 4 - Maximum Thermal Impedance Z_{thJC} Characteristics

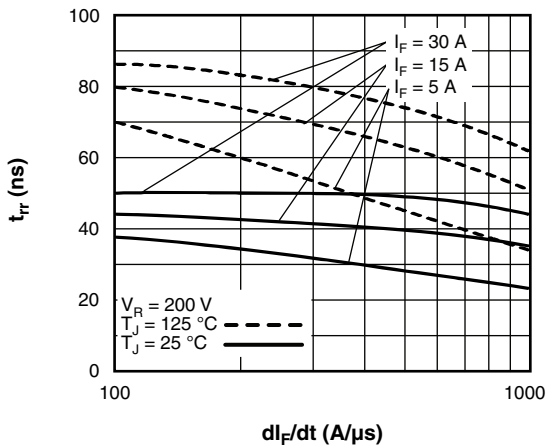

Fig. 5 - Typical Reverse Recovery Time vs. di_F/dt

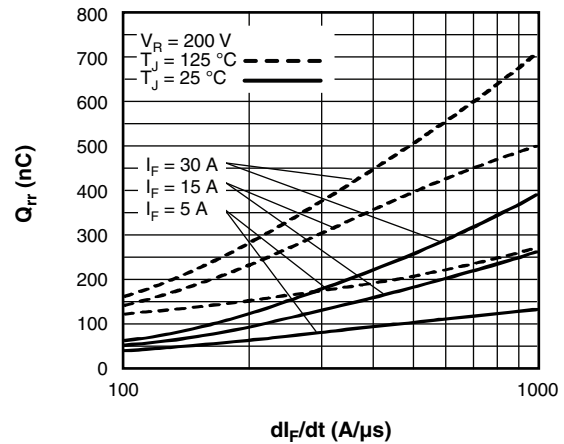

Fig. 7 - Typical Stored Charge vs. di_F/dt

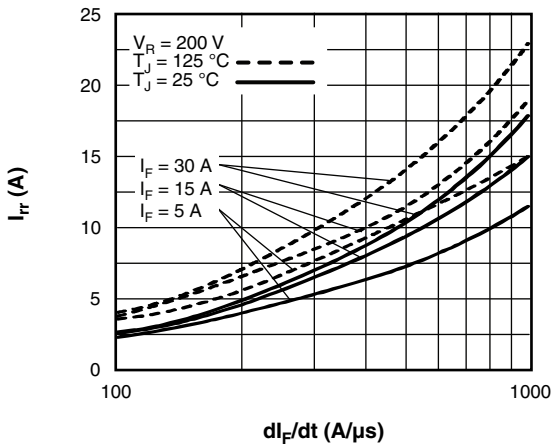

Fig. 6 - Typical Recovery Current vs. di_F/dt

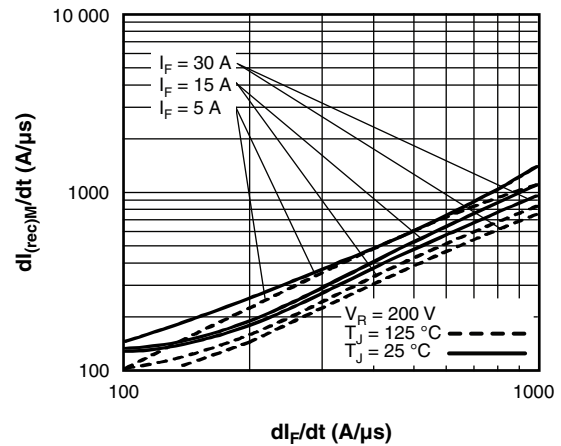

Fig. 8 - Typical $di_{(rec)M}/dt$ vs. di_F/dt

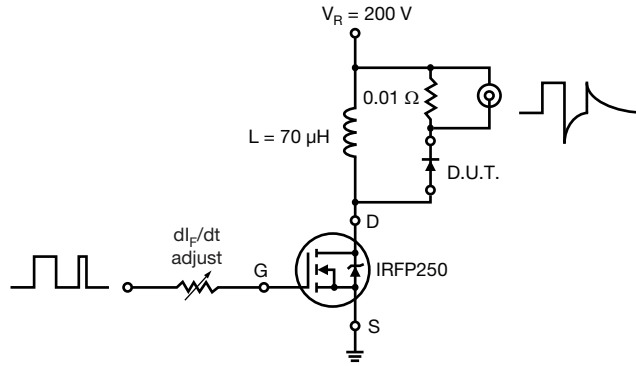
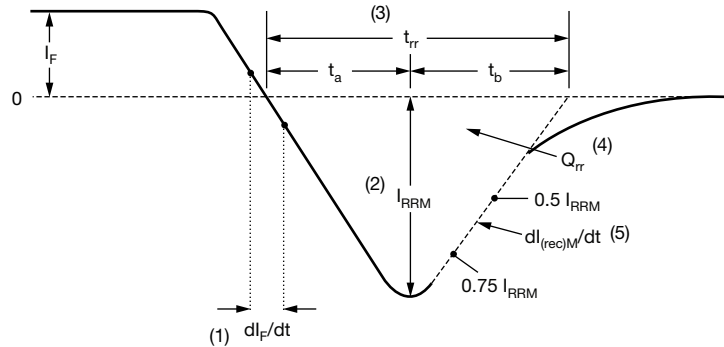

Fig. 9 - Reverse Recovery Parameter Test Circuit



- (1) di_F/dt - rate of change of current through zero crossing
- (2) I_{RRM} - peak reverse recovery current
- (3) t_{rr} - reverse recovery time measured from zero crossing point of negative going I_F to point where a line passing through $0.75 I_{RRM}$ and $0.50 I_{RRM}$ extrapolated to zero current.
- (4) Q_{rr} - area under curve defined by t_{rr} and I_{RRM}
- (5) $dl_{(rec)M}/dt$ - peak rate of change of current during t_{rb} portion of t_{rr}

$$Q_{rr} = \frac{t_{rr} \times I_{RRM}}{2}$$

Fig. 10 - Reverse Recovery Waveform and Definitions



ORDERING INFORMATION TABLE

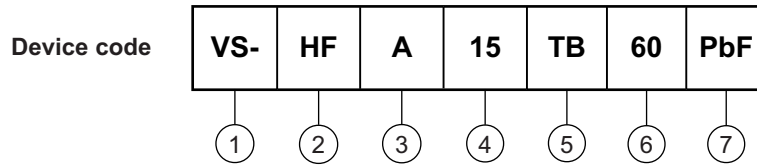

- 1** - Vishay Semiconductors product
- 2** - HEXFRED® family
- 3** - Electron irradiated
- 4** - Current rating (15 = 15 A)
- 5** - Package:
TB = TO-220AC
- 6** - Voltage rating (60 = 600 V)
- 7** - Environmental digit:
PbF = lead (Pb)-free and RoHS-compliant
-N3 = halogen-free, RoHS-compliant, and totally lead (Pb)-free

| ORDERING INFORMATION (Example) | | | |
|---------------------------------------|-------------------------|-------------------------------|------------------------------|
| PREFERRED P/N | QUANTITY PER T/R | MINIMUM ORDER QUANTITY | PACKAGING DESCRIPTION |
| VS-HFA15TB60PbF | 50 | 1000 | Antistatic plastic tube |
| VS-HFA15TB60-N3 | 50 | 1000 | Antistatic plastic tube |

| LINKS TO RELATED DOCUMENTS | | |
|-----------------------------------|-------------|--|
| Dimensions | | www.vishay.com/doc?95221 |
| Part marking information | TO-220ACPbF | www.vishay.com/doc?95224 |
| | TO-220AC-N3 | www.vishay.com/doc?95068 |

TO-220AC

DIMENSIONS in millimeters and inches



| SYMBOL | MILLIMETERS | | INCHES | | NOTES | SYMBOL | MILLIMETERS | | INCHES | | NOTES |
|--------|-------------|-------|--------|-------|-------|-----------------|-------------|-------|------------|-------|-------|
| | MIN. | MAX. | MIN. | MAX. | | | MIN. | MAX. | MIN. | MAX. | |
| A | 4.25 | 4.65 | 0.167 | 0.183 | | E1 | 6.86 | 8.89 | 0.270 | 0.350 | 6 |
| A1 | 1.14 | 1.40 | 0.045 | 0.055 | | E2 | - | 0.76 | - | 0.030 | 7 |
| A2 | 2.56 | 2.92 | 0.101 | 0.115 | | e | 2.41 | 2.67 | 0.095 | 0.105 | |
| b | 0.69 | 1.01 | 0.027 | 0.040 | | e1 | 4.88 | 5.28 | 0.192 | 0.208 | |
| b1 | 0.38 | 0.97 | 0.015 | 0.038 | 4 | H1 | 6.09 | 6.48 | 0.240 | 0.255 | 6, 7 |
| b2 | 1.20 | 1.73 | 0.047 | 0.068 | | L | 13.52 | 14.02 | 0.532 | 0.552 | |
| b3 | 1.14 | 1.73 | 0.045 | 0.068 | 4 | L1 | 3.32 | 3.82 | 0.131 | 0.150 | 2 |
| c | 0.36 | 0.61 | 0.014 | 0.024 | | L3 | 1.78 | 2.13 | 0.070 | 0.084 | |
| c1 | 0.36 | 0.56 | 0.014 | 0.022 | 4 | L4 | 0.76 | 1.27 | 0.030 | 0.050 | 2 |
| D | 14.85 | 15.25 | 0.585 | 0.600 | 3 | $\varnothing P$ | 3.54 | 3.73 | 0.139 | 0.147 | |
| D1 | 8.38 | 9.02 | 0.330 | 0.355 | | Q | 2.60 | 3.00 | 0.102 | 0.118 | |
| D2 | 11.68 | 12.88 | 0.460 | 0.507 | 6 | θ | 90° to 93° | | 90° to 93° | | |
| E | 10.11 | 10.51 | 0.398 | 0.414 | 3, 6 | | | | | | |

Notes

- (1) Dimensioning and tolerancing as per ASME Y14.5M-1994
- (2) Lead dimension and finish uncontrolled in L1
- (3) Dimension D, D1 and E do not include mold flash. Mold flash shall not exceed 0.127 mm (0.005") per side. These dimensions are measured at the outermost extremes of the plastic body
- (4) Dimension b1, b3 and c1 apply to base metal only
- (5) Controlling dimension: inches
- (6) Thermal pad contour optional within dimensions E, H1, D2 and E1
- (7) Dimension E2 x H1 define a zone where stamping and singulation irregularities are allowed
- (8) Outline conforms to JEDEC TO-220, D2 (minimum) where dimensions are derived from the actual package outline



Disclaimer

ALL PRODUCT, PRODUCT SPECIFICATIONS AND DATA ARE SUBJECT TO CHANGE WITHOUT NOTICE TO IMPROVE RELIABILITY, FUNCTION OR DESIGN OR OTHERWISE.

Vishay Intertechnology, Inc., its affiliates, agents, and employees, and all persons acting on its or their behalf (collectively, "Vishay"), disclaim any and all liability for any errors, inaccuracies or incompleteness contained in any datasheet or in any other disclosure relating to any product.

Vishay makes no warranty, representation or guarantee regarding the suitability of the products for any particular purpose or the continuing production of any product. To the maximum extent permitted by applicable law, Vishay disclaims (i) any and all liability arising out of the application or use of any product, (ii) any and all liability, including without limitation special, consequential or incidental damages, and (iii) any and all implied warranties, including warranties of fitness for particular purpose, non-infringement and merchantability.

Statements regarding the suitability of products for certain types of applications are based on Vishay's knowledge of typical requirements that are often placed on Vishay products in generic applications. Such statements are not binding statements about the suitability of products for a particular application. It is the customer's responsibility to validate that a particular product with the properties described in the product specification is suitable for use in a particular application. Parameters provided in datasheets and / or specifications may vary in different applications and performance may vary over time. All operating parameters, including typical parameters, must be validated for each customer application by the customer's technical experts. Product specifications do not expand or otherwise modify Vishay's terms and conditions of purchase, including but not limited to the warranty expressed therein.

Except as expressly indicated in writing, Vishay products are not designed for use in medical, life-saving, or life-sustaining applications or for any other application in which the failure of the Vishay product could result in personal injury or death. Customers using or selling Vishay products not expressly indicated for use in such applications do so at their own risk. Please contact authorized Vishay personnel to obtain written terms and conditions regarding products designed for such applications.

No license, express or implied, by estoppel or otherwise, to any intellectual property rights is granted by this document or by any conduct of Vishay. Product names and markings noted herein may be trademarks of their respective owners.