

Schottky Barrier Rectifier

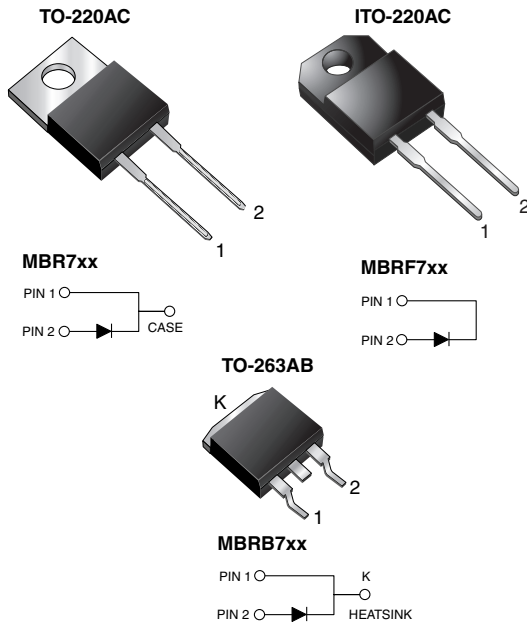

FEATURES

- Power pack
- Guardring for overvoltage protection
- Low power loss, high efficiency
- Low forward voltage drop
- High forward surge capability
- High frequency operation
- Meets MSL level 1, per J-STD-020, LF maximum peak of 245 °C (for TO-263AB package)
- Solder bath temperature 275 °C maximum, 10 s, per JESD 22-B106 (for TO-220AC and ITO-220AC package)
- AEC-Q101 qualified available
 - Automotive ordering code: base P/NHE3_A
- Material categorization: for definitions of compliance please see www.vishay.com/doc?99912

RoHS
COMPLIANT

TYPICAL APPLICATIONS

For use in low voltage, high frequency rectifier of switching mode power supplies, freewheeling diodes, DC/DC converters, and polarity protection application.

MECHANICAL DATA

Case: TO-220AC, ITO-220AC, TO-263AB

Molding compound meets UL 94 V-0 flammability rating
 Base P/N-E3 - RoHS-compliant, commercial grade
 Base P/NHE3 - RoHS-compliant, AEC-Q101 qualified
 Base P/NHE3_X - RoHS-compliant, AEC-Q101 qualified
 ("_X" denotes revision code, e.g. A, B, ...)

Terminals: matte tin plated leads, solderable per J-STD-002 and JESD 22-B102

E3 suffix meets JESD 201 class 1A whisker test, HE3 suffix meets JESD 201 class 2 whisker test

Polarity: as marked

Mounting Torque: 10 in-lbs maximum

PRIMARY CHARACTERISTICS	
$I_{F(AV)}$	7.5 A
V_{RRM}	35 V to 60 V
I_{FSM}	150 A
V_F	0.57 V, 0.65 V
$T_J \text{ max.}$	150 °C
Package	TO-220AC, ITO-220AC, TO-263AB
Diode variations	Single

MAXIMUM RATINGS ($T_C = 25 \text{ °C}$ unless otherwise noted)						
PARAMETER	SYMBOL	MBR735	MBR745	MBR750	MBR760	UNIT
Maximum repetitive peak reverse voltage	V_{RRM}	35	45	50	60	V
Working peak reverse voltage	V_{RWM}	35	45	50	60	
Maximum DC blocking voltage	V_{DC}	35	45	50	60	
Maximum average forward rectified current (fig. 1)	$I_{F(AV)}$	7.5				A
Peak forward surge current 8.3 ms single half sine-wave superimposed on rated load	I_{FSM}	150				
Peak repetitive reverse surge current at $t_p = 2.0 \text{ }\mu\text{s}$, 1 kHz	I_{RRM}	1.0		0.5		
Voltage rate of change (rated V_R)	dV/dt	10 000				
Operating junction temperature range	T_J	-65 to +150				°C
Operating storage temperature range	T_{STG}	-65 to +175				
Isolation voltage (ITO-220AC only) from terminal to heatsink $t = 1 \text{ min}$	V_{AC}	1500				V



ELECTRICAL CHARACTERISTICS ($T_C = 25\text{ }^\circ\text{C}$ unless otherwise noted)								
PARAMETER	SYMBOL	TEST CONDITIONS		MBR735	MBR745	MBR750	MBR760	UNIT
Maximum instantaneous forward voltage	$V_F^{(1)}$	$I_F = 7.5\text{ A}$	$T_C = 25\text{ }^\circ\text{C}$	-		0.75		V
		$I_F = 7.5\text{ A}$	$T_C = 125\text{ }^\circ\text{C}$	0.57		0.65		
		$I_F = 15\text{ A}$	$T_C = 25\text{ }^\circ\text{C}$	0.84		-		
		$I_F = 15\text{ A}$	$T_C = 125\text{ }^\circ\text{C}$	0.72		-		
Maximum reverse current at DC blocking voltage	$I_R^{(2)}$	Rated V_R	$T_C = 25\text{ }^\circ\text{C}$	0.1		0.5		mA
			$T_C = 125\text{ }^\circ\text{C}$	15		50		

Notes

- (1) Pulse test: 300 μs pulse width, 1 % duty cycle
(2) Pulse test: pulse width $\leq 40\text{ ms}$

THERMAL CHARACTERISTICS ($T_C = 25\text{ }^\circ\text{C}$ unless otherwise noted)					
PARAMETER	SYMBOL	MBR	MBRF	MBRB	UNIT
Typical thermal resistance from junction to case	$R_{\theta JC}$	3.0	5.0	3.0	$^\circ\text{C/W}$

ORDERING INFORMATION (Example)					
PACKAGE	PREFERRED P/N	UNIT WEIGHT (g)	PACKAGE CODE	BASE QUANTITY	DELIVERY MODE
TO-220AC	MBR745-E3/45	1.80	45	50/tube	Tube
ITO-220AC	MBRF745-E3/45	1.94	45	50/tube	Tube
TO-263AB	MBRB745-E3/45	1.33	45	50/tube	Tube
TO-263AB	MBRB745-E3/81	1.33	81	800/reel	Tape and reel
TO-220AC	MBR745HE3/45 ⁽¹⁾	1.80	45	50/tube	Tube
ITO-220AC	MBRF745HE3/45 ⁽¹⁾	1.94	45	50/tube	Tube
TO-263AB	MBRB745HE3/45 ⁽¹⁾	1.33	45	50/tube	Tube
TO-263AB	MBRB745HE3/81 ⁽¹⁾	1.33	81	800/reel	Tape and reel
TO-263AB	MBRB745HE3_A/P ⁽¹⁾	1.33	P	50/tube	Tube
TO-263AB	MBRB745HE3_A/I ⁽¹⁾	1.33	I	800/reel	Tape and reel

Note

- (1) AEC-Q101 qualified



RATINGS AND CHARACTERISTICS CURVES

($T_A = 25\text{ }^\circ\text{C}$ unless otherwise noted)

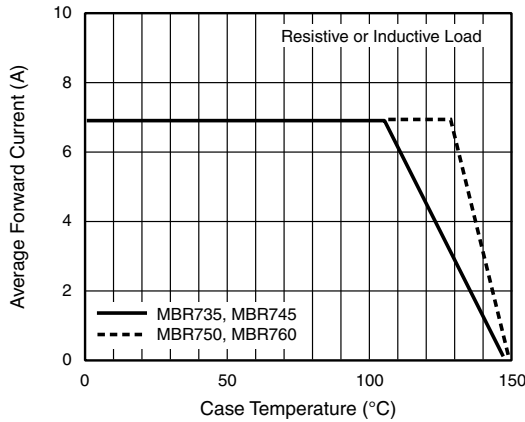

Fig. 1 - Forward Current Derating Curve

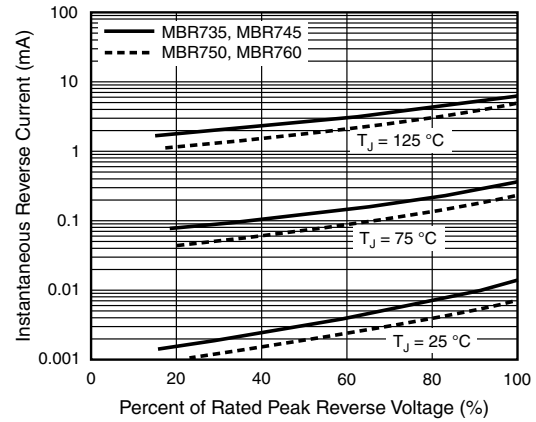

Fig. 4 - Typical Reverse Characteristics

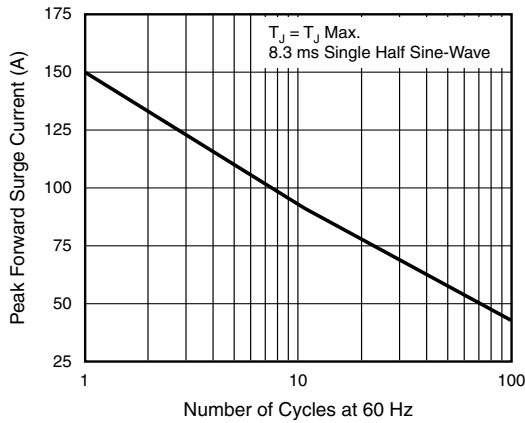

Fig. 2 - Maximum Non-Repetitive Peak Forward Surge Current

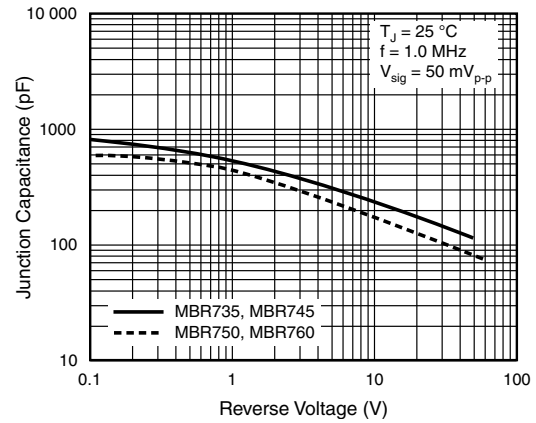

Fig. 5 - Typical Junction Capacitance

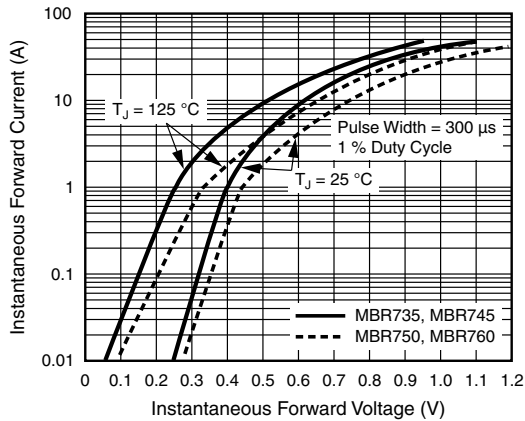

Fig. 3 - Typical Instantaneous Forward Characteristics

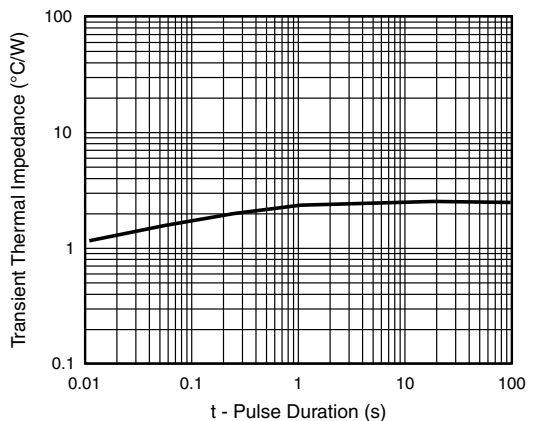
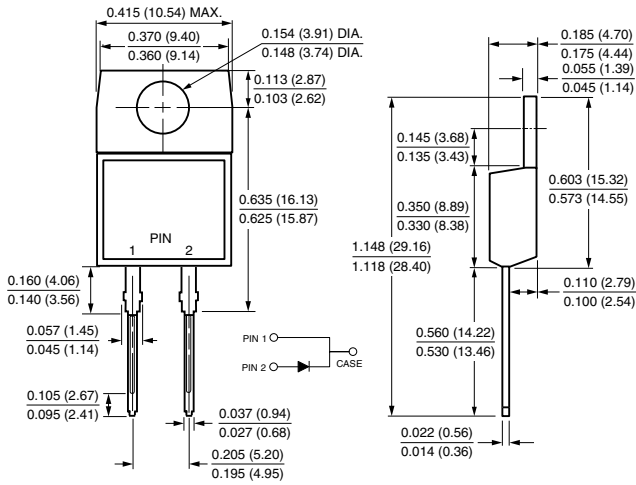

Fig. 6 - Typical Transient Thermal Impedance



PACKAGE OUTLINE DIMENSIONS in inches (millimeters)

TO-220AC



ITO-220AC

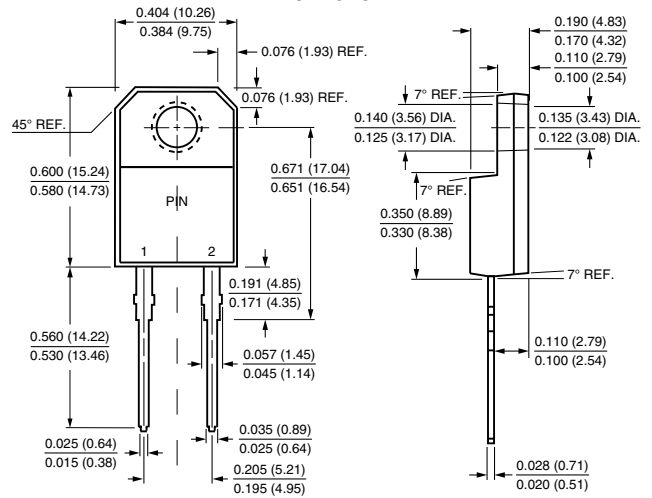

TO-263AB

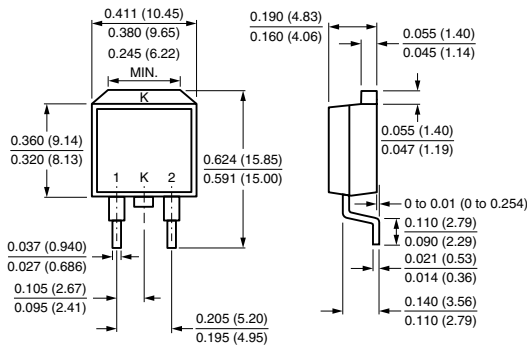

Mounting Pad Layout

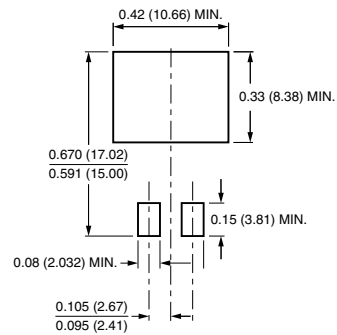



Disclaimer

ALL PRODUCT, PRODUCT SPECIFICATIONS AND DATA ARE SUBJECT TO CHANGE WITHOUT NOTICE TO IMPROVE RELIABILITY, FUNCTION OR DESIGN OR OTHERWISE.

Vishay Intertechnology, Inc., its affiliates, agents, and employees, and all persons acting on its or their behalf (collectively, "Vishay"), disclaim any and all liability for any errors, inaccuracies or incompleteness contained in any datasheet or in any other disclosure relating to any product.

Vishay makes no warranty, representation or guarantee regarding the suitability of the products for any particular purpose or the continuing production of any product. To the maximum extent permitted by applicable law, Vishay disclaims (i) any and all liability arising out of the application or use of any product, (ii) any and all liability, including without limitation special, consequential or incidental damages, and (iii) any and all implied warranties, including warranties of fitness for particular purpose, non-infringement and merchantability.

Statements regarding the suitability of products for certain types of applications are based on Vishay's knowledge of typical requirements that are often placed on Vishay products in generic applications. Such statements are not binding statements about the suitability of products for a particular application. It is the customer's responsibility to validate that a particular product with the properties described in the product specification is suitable for use in a particular application. Parameters provided in datasheets and / or specifications may vary in different applications and performance may vary over time. All operating parameters, including typical parameters, must be validated for each customer application by the customer's technical experts. Product specifications do not expand or otherwise modify Vishay's terms and conditions of purchase, including but not limited to the warranty expressed therein.

Except as expressly indicated in writing, Vishay products are not designed for use in medical, life-saving, or life-sustaining applications or for any other application in which the failure of the Vishay product could result in personal injury or death. Customers using or selling Vishay products not expressly indicated for use in such applications do so at their own risk. Please contact authorized Vishay personnel to obtain written terms and conditions regarding products designed for such applications.

No license, express or implied, by estoppel or otherwise, to any intellectual property rights is granted by this document or by any conduct of Vishay. Product names and markings noted herein may be trademarks of their respective owners.