

Silicon NPN Phototransistor

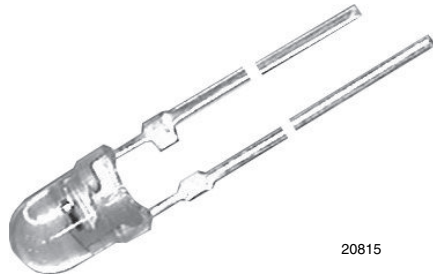

FEATURES

- Package type: leaded
- Package form: T-1
- Dimensions (in mm): $\varnothing 3$
- High photo sensitivity
- High radiant sensitivity
- Suitable for visible and near infrared radiation
- Fast response times
- Angle of half sensitivity: $\varphi = \pm 25^\circ$
- Material categorization: for definitions of compliance please see www.vishay.com/doc?99912



DESCRIPTION

BPW85 is a silicon NPN phototransistor with high radiant sensitivity in clear, T-1 plastic package. It is sensitive to visible and near infrared radiation.

APPLICATIONS

- Detector in electronic control and drive circuits

PRODUCT SUMMARY

COMPONENT	I_{ca} (mA)	φ (deg)	$\lambda_{0.1}$ (nm)
BPW85	0.8 to 8	± 25	450 to 1080
BPW85A	0.8 to 2.5	± 25	450 to 1080
BPW85B	1.5 to 4	± 25	450 to 1080
BPW85C	3 to 8	± 25	450 to 1080

Note

- Test condition see table "Basic Characteristics"

ORDERING INFORMATION

ORDERING CODE	PACKAGING	REMARKS	PACKAGE FORM
BPW85	Bulk	MOQ: 5000 pcs, 5000 pcs/bulk	T-1
BPW85A	Bulk	MOQ: 5000 pcs, 5000 pcs/bulk	T-1
BPW85B	Bulk	MOQ: 5000 pcs, 5000 pcs/bulk	T-1
BPW85C	Bulk	MOQ: 5000 pcs, 5000 pcs/bulk	T-1

Note

- MOQ: minimum order quantity

ABSOLUTE MAXIMUM RATINGS ($T_{amb} = 25^\circ\text{C}$, unless otherwise specified)

PARAMETER	TEST CONDITION	SYMBOL	VALUE	UNIT
Collector emitter voltage		V_{CEO}	70	V
Emitter collector voltage		V_{ECO}	5	V
Collector current		I_C	50	mA
Collector peak current	$t_p/T = 0.5, t_p \leq 10$ ms	I_{CM}	100	mA
Power dissipation	$T_{amb} \leq 55^\circ\text{C}$	P_V	100	mW
Junction temperature		T_j	100	$^\circ\text{C}$
Operating temperature range		T_{amb}	-40 to +100	$^\circ\text{C}$
Storage temperature range		T_{stg}	-40 to +100	$^\circ\text{C}$
Soldering temperature	$t \leq 3$ s, 2 mm from case	T_{sd}	260	$^\circ\text{C}$
Thermal resistance junction/ambient	Connected with Cu wire $\varnothing 0.14$ mm ²	R_{thJA}	450	K/W

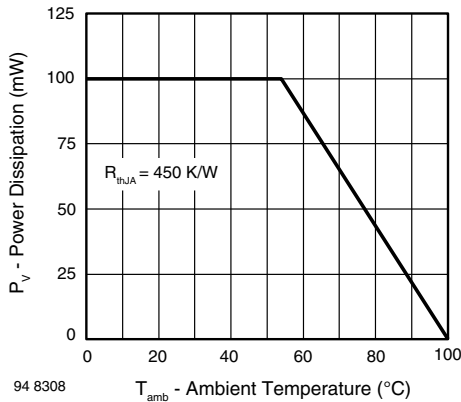

Fig. 1 - Power Dissipation Limit vs. Ambient Temperature

BASIC CHARACTERISTICS ($T_{amb} = 25\text{ }^{\circ}\text{C}$, unless otherwise specified)						
PARAMETER	TEST CONDITION	SYMBOL	MIN.	TYP.	MAX.	UNIT
Collector emitter breakdown voltage	$I_C = 1\text{ mA}$	$V_{(BR)CEO}$	70			V
Collector emitter dark current	$V_{CE} = 20\text{ V}, E = 0$	I_{CEO}		1	200	nA
Collector emitter capacitance	$V_{CE} = 5\text{ V}, f = 1\text{ MHz}, E = 0$	C_{CEO}		3		pF
Angle of half sensitivity		φ		± 25		deg
Wavelength of peak sensitivity		λ_p		850		nm
Range of spectral bandwidth		$\lambda_{0.1}$		450 to 1080		nm
Collector emitter saturation voltage	$E_e = 1\text{ mW/cm}^2, \lambda = 950\text{ nm}, I_C = 0.1\text{ mA}$	V_{CEsat}			0.3	V
Turn-on time	$V_S = 5\text{ V}, I_C = 5\text{ mA}, R_L = 100\text{ }\Omega$	t_{on}		2.0		μs
Turn-off time	$V_S = 5\text{ V}, I_C = 5\text{ mA}, R_L = 100\text{ }\Omega$	t_{off}		2.3		μs
Cut-off frequency	$V_S = 5\text{ V}, I_C = 5\text{ mA}, R_L = 100\text{ }\Omega$	f_c		180		kHz

TYPE DEDICATED CHARACTERISTICS							
PARAMETER	TEST CONDITION	PART	SYMBOL	MIN.	TYP.	MAX.	UNIT
Collector light current	$E_e = 1\text{ mW/cm}^2, \lambda = 950\text{ nm}, V_{CE} = 5\text{ V}$	BPW85	I_{ca}	0.8		8.0	mA
		BPW85A	I_{ca}	0.8		2.5	mA
		BPW85B	I_{ca}	1.5		4.0	mA
		BPW85C	I_{ca}	3.0		8.0	mA



BASIC CHARACTERISTICS ($T_{amb} = 25\text{ }^{\circ}\text{C}$, unless otherwise specified)

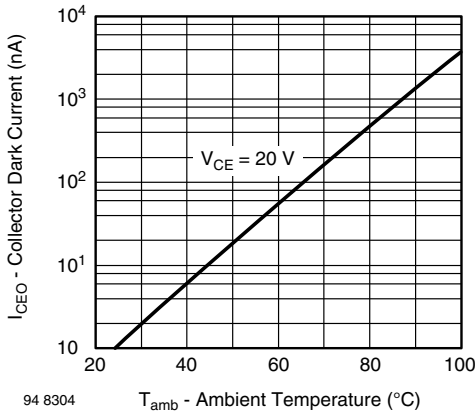

Fig. 2 - Collector Dark Current vs. Ambient Temperature

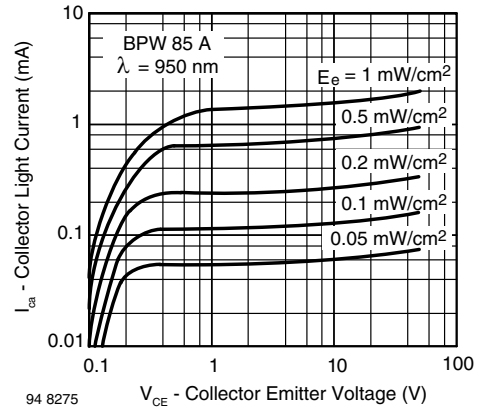

Fig. 5 - Collector Light Current vs. Collector Emitter Voltage

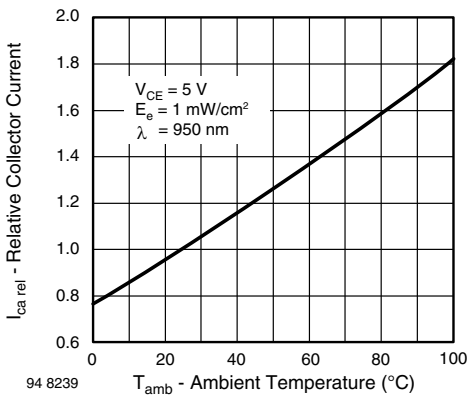

Fig. 3 - Relative Collector Current vs. Ambient Temperature

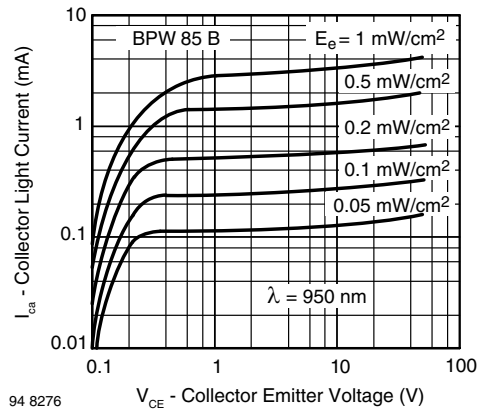

Fig. 6 - Collector Light Current vs. Collector Emitter Voltage

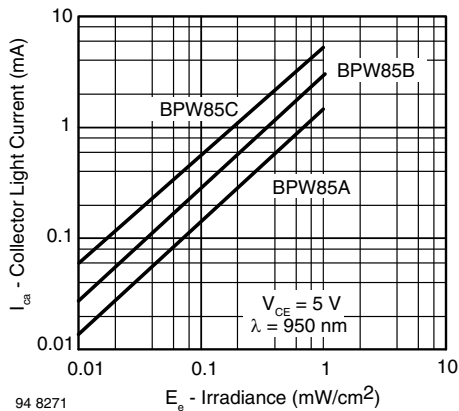

Fig. 4 - Collector Light Current vs. Irradiance

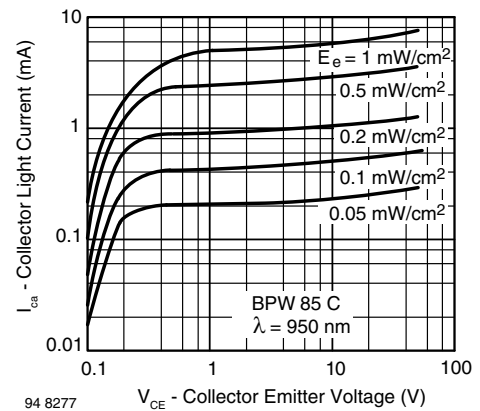

Fig. 7 - Collector Light Current vs. Collector Emitter Voltage

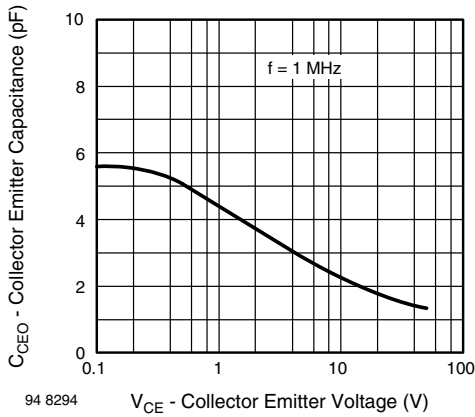

Fig. 8 - Collector Emitter Capacitance vs. Collector Emitter Voltage

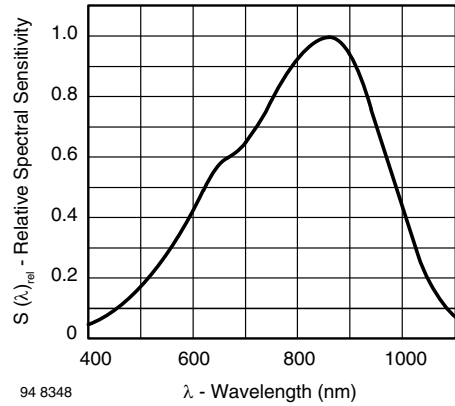

Fig. 10 - Relative Spectral Sensitivity vs. Wavelength

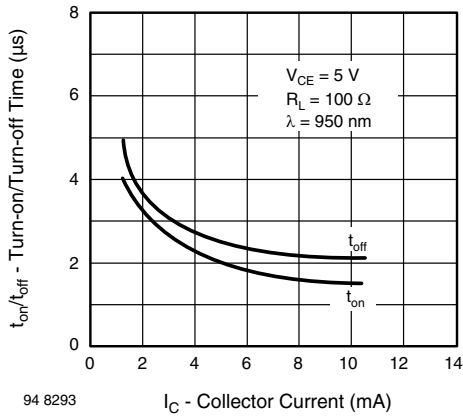

Fig. 9 - Turn-on/Turn-off Time vs. Collector Current

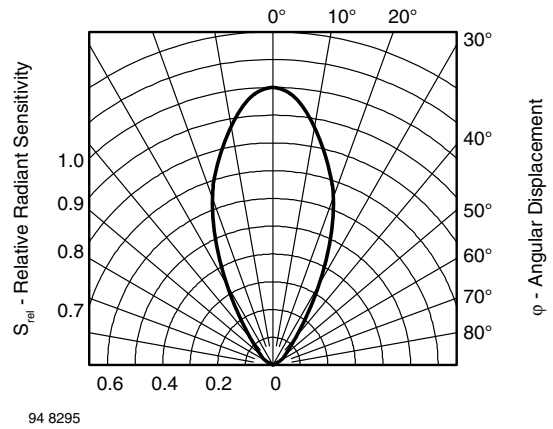
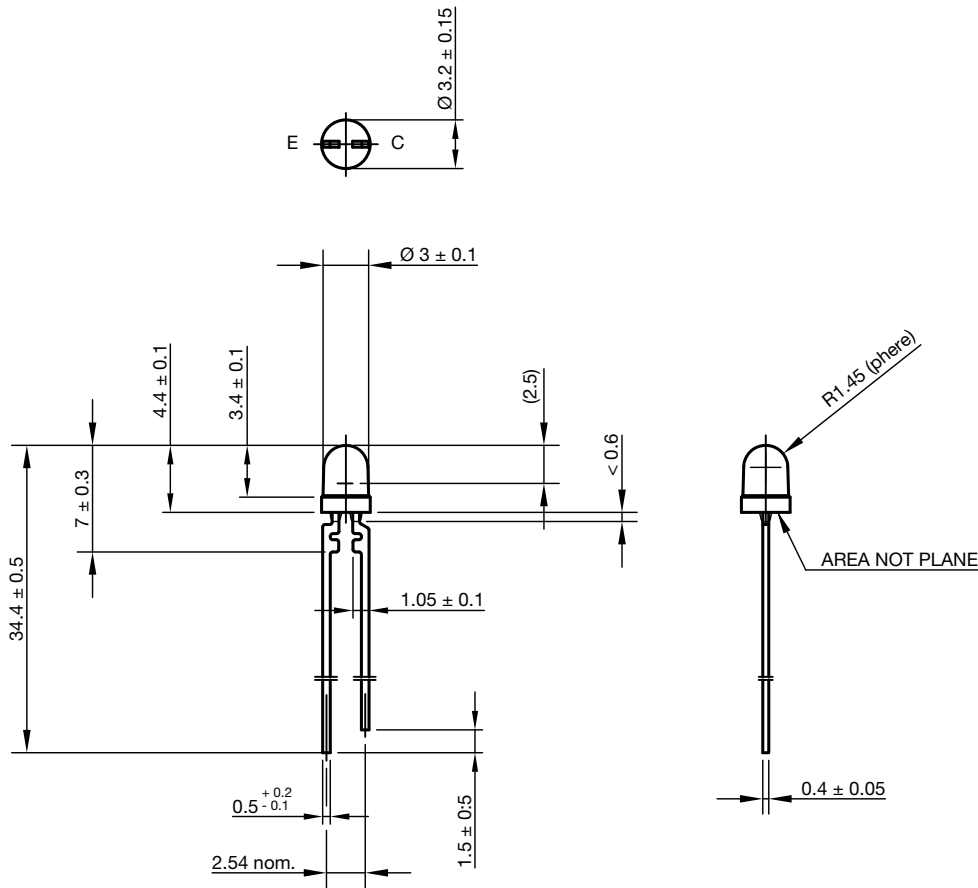

Fig. 11 - Relative Radiant Sensitivity vs. Angular Displacement



PACKAGE DIMENSIONS in millimeters



Drawing-No.: 6.544-5054.01-4
Issue: 5; 28.07.14

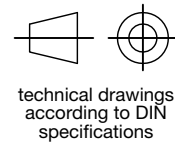



Disclaimer

ALL PRODUCT, PRODUCT SPECIFICATIONS AND DATA ARE SUBJECT TO CHANGE WITHOUT NOTICE TO IMPROVE RELIABILITY, FUNCTION OR DESIGN OR OTHERWISE.

Vishay Intertechnology, Inc., its affiliates, agents, and employees, and all persons acting on its or their behalf (collectively, "Vishay"), disclaim any and all liability for any errors, inaccuracies or incompleteness contained in any datasheet or in any other disclosure relating to any product.

Vishay makes no warranty, representation or guarantee regarding the suitability of the products for any particular purpose or the continuing production of any product. To the maximum extent permitted by applicable law, Vishay disclaims (i) any and all liability arising out of the application or use of any product, (ii) any and all liability, including without limitation special, consequential or incidental damages, and (iii) any and all implied warranties, including warranties of fitness for particular purpose, non-infringement and merchantability.

Statements regarding the suitability of products for certain types of applications are based on Vishay's knowledge of typical requirements that are often placed on Vishay products in generic applications. Such statements are not binding statements about the suitability of products for a particular application. It is the customer's responsibility to validate that a particular product with the properties described in the product specification is suitable for use in a particular application. Parameters provided in datasheets and / or specifications may vary in different applications and performance may vary over time. All operating parameters, including typical parameters, must be validated for each customer application by the customer's technical experts. Product specifications do not expand or otherwise modify Vishay's terms and conditions of purchase, including but not limited to the warranty expressed therein.

Except as expressly indicated in writing, Vishay products are not designed for use in medical, life-saving, or life-sustaining applications or for any other application in which the failure of the Vishay product could result in personal injury or death. Customers using or selling Vishay products not expressly indicated for use in such applications do so at their own risk. Please contact authorized Vishay personnel to obtain written terms and conditions regarding products designed for such applications.

No license, express or implied, by estoppel or otherwise, to any intellectual property rights is granted by this document or by any conduct of Vishay. Product names and markings noted herein may be trademarks of their respective owners.