





<b>ABSOLUTE MAXIMUM RATINGS</b> ( $T_{amb} = 25\text{ }^{\circ}\text{C}$ , unless otherwise specified)				
PARAMETER	TEST CONDITION	SYMBOL	VALUE	UNIT
<b>Input</b>				
Peak reverse voltage		$V_R$	6	V
Forward continuous current		$I_F$	40	mA
Power dissipation		$P_{diss}$	75	mW
Derate linearly from 25 °C			1	mW/°C
<b>Output</b>				
Collector emitter breakdown voltage		$BV_{CEO}$	30	V
Emitter collector breakdown voltage		$BV_{ECO}$	7	V
Collector base breakdown voltage		$BV_{CBO}$	70	V
Power dissipation		$P_{diss}$	200	mW
Derate linearly from 25 °C			2.6	mW/°C
<b>Coupler</b>				
Total package dissipation (LED and detector)		$P_{tot}$	260	mW
Derate linearly from 25 °C			3.5	mW/°C
Operating temperature		$T_{amb}$	-55 to +100	°C
Storage temperature		$T_{stg}$	-55 to +150	°C

**Note**

- Stresses in excess of the absolute maximum ratings can cause permanent damage to the device. Functional operation of the device is not implied at these or any other conditions in excess of those given in the operational sections of this document. Exposure to absolute maximum ratings for extended periods of the time can adversely affect reliability

<b>ELECTRICAL CHARACTERISTICS</b> ( $T_{amb} = 25\text{ }^{\circ}\text{C}$ , unless otherwise specified)							
PARAMETER	TEST CONDITION	PART	SYMBOL	MIN.	TYP.	MAX.	UNIT
<b>Input</b>							
Forward voltage	$I_F = 5\text{ mA}$		$V_F$	-	1.2	1.5	V
Reverse voltage	$I_R = 10\text{ }\mu\text{A}$		$V_R$	6	-	-	V
<b>Output</b>							
DC forward current gain	$V_{CE} = 5\text{ V}, I_C = 100\text{ }\mu\text{A}$		$h_{FE}$	100	200	-	
Collector emitter breakdown voltage	$I_C = 100\text{ }\mu\text{A}$		$BV_{CEO}$	30	-	-	V
Emitter collector breakdown voltage	$I_E = 100\text{ }\mu\text{A}$		$BV_{ECO}$	7	-	-	V
Collector base breakdown voltage	$I_E = 10\text{ }\mu\text{A}$		$BV_{CBO}$	70	-	-	V
Collector emitter leakage voltage	$V_{CE} = 10\text{ V}$		$I_{CEO}$	-	5	100	nA
<b>Coupler</b>							
Saturation voltage	$I_F = 1.6\text{ mA}, I_C = 1.6\text{ mA}$	MCT5211	$V_{CEsat}$	-	0.25	0.4	V

**Note**

- Minimum and maximum values are testing requirements. Typical values are characteristics of the device and are the result of engineering evaluation. Typical values are for information only and are not part of the testing requirements

<b>CURRENT TRANSFER RATIO</b> ( $T_{amb} = 25\text{ }^{\circ}\text{C}$ , unless otherwise specified)							
PARAMETER	TEST CONDITION	PART	SYMBOL	MIN.	TYP.	MAX.	UNIT
Current transfer ratio (collector emitter saturated)	$V_{CE} = 0.4\text{ V}, I_F = 1.6\text{ mA}$	MCT5211	$CTR_{CEsat}$	100	200	-	%
	$V_{CE} = 0.4\text{ V}, I_F = 1\text{ mA}$	MCT5211	$CTR_{CEsat}$	75	150	-	%
Current transfer ratio	$V_{CE} = 5\text{ V}, I_F = 1.6\text{ mA}$	MCT5211	CTR	150	300	-	%
	$V_{CE} = 5\text{ V}, I_F = 1\text{ mA}$	MCT5211	CTR	110	225	-	%
Current transfer ratio (collector base)	$V_{CE} = 4.3\text{ V}, I_F = 1.6\text{ mA}$	MCT5211	$CTR_{CB}$	0.3	0.6	-	%
	$V_{CE} = 4.3\text{ V}, I_F = 1\text{ mA}$	MCT5211	$CTR_{CB}$	0.25	0.5	-	%



SWITCHING CHARACTERISTICS ( $T_{amb} = 25\text{ }^{\circ}\text{C}$ , unless otherwise specified)							
PARAMETER	TEST CONDITION	PART	SYMBOL	MIN.	TYP.	MAX.	UNIT
Propagation delay high to low	$R_L = 750\ \Omega, I_F = 1.6\ \text{mA}, V_{CC} = 5\ \text{V}$	MCT5211	$t_{PHL}$	-	20	-	$\mu\text{s}$
	$R_L = 1.5\ \text{k}\Omega, I_F = 1\ \text{mA}, V_{CC} = 5\ \text{V}$	MCT5211	$t_{PHL}$	-	40	-	$\mu\text{s}$
Propagation delay low to high	$R_L = 750\ \Omega, I_F = 1.6\ \text{mA}, V_{CC} = 5\ \text{V}$	MCT5211	$t_{PLH}$	-	20	-	$\mu\text{s}$
	$R_L = 1.5\ \text{k}\Omega, I_F = 1\ \text{mA}, V_{CC} = 5\ \text{V}$	MCT5211	$t_{PLH}$	-	40	-	$\mu\text{s}$

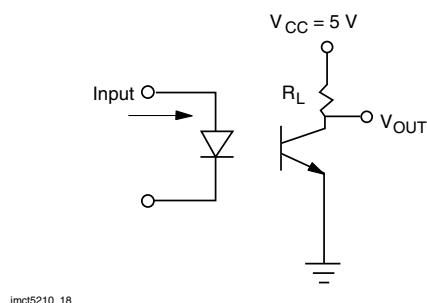

imct5210\_18

Fig. 1 - Switching Schematic

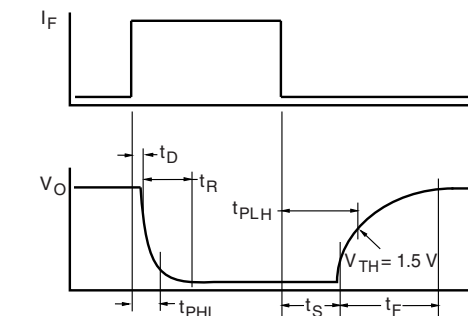

imct5210\_03

Fig. 2 - Switching Waveform

SAFETY AND INSULATION RATINGS				
PARAMETER	TEST CONDITION	SYMBOL	VALUE	UNIT
Climatic classification	According to IEC 68 part 1		55 / 100 / 21	
Comparative tracking index		CTI	175	
Maximum rated withstanding isolation voltage	$t = 1\ \text{min}$	$V_{ISO}$	4420	$V_{RMS}$
Maximum transient isolation voltage		$V_{IOTM}$	10 000	V
Maximum repetitive peak isolation voltage		$V_{IORM}$	890	V
Isolation resistance	$V_{IO} = 500\ \text{V}, T_{amb} = 25\text{ }^{\circ}\text{C}$	$R_{IO}$	$\geq 10^{12}$	$\Omega$
	$V_{IO} = 500\ \text{V}, T_{amb} = 100\text{ }^{\circ}\text{C}$	$R_{IO}$	$\geq 10^{11}$	$\Omega$
Output safety power		$P_{SO}$	400	mW
Input safety current		$I_{SI}$	275	mA
Input safety temperature		$T_{SI}$	175	$^{\circ}\text{C}$
Creepage distance			$\geq 7$	mm
Clearance distance			$\geq 7$	mm
Insulation thickness		DTI	$\geq 0.4$	mm

**Note**

- As per IEC 60747-5-5, § 7.4.3.8.2, this optocoupler is suitable for "safe electrical insulation" only within the safety ratings. Compliance with the safety ratings shall be ensured by means of protective circuits



**TYPICAL CHARACTERISTICS** ( $T_{amb} = 25\text{ }^{\circ}\text{C}$ , unless otherwise specified)

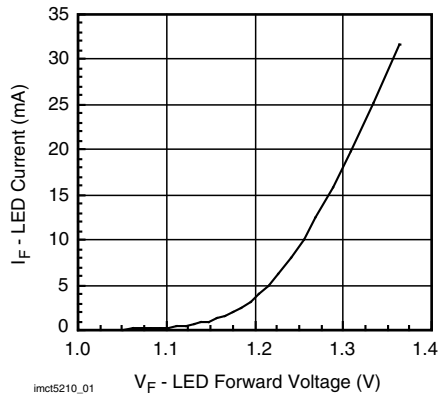

Fig. 1 Forward Current vs. Forward Voltage

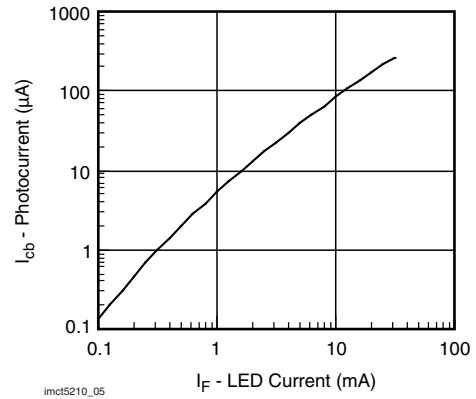

Fig. 5 - Photocurrent vs. LED Current

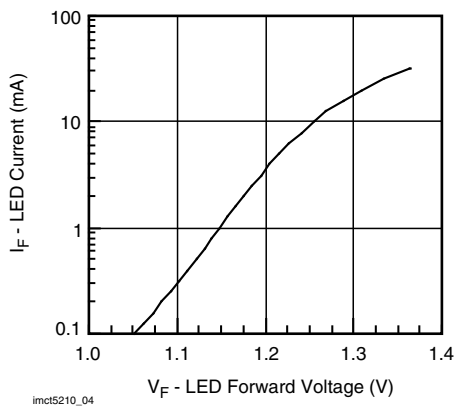

Fig. 3 - LED Forward Current vs. Forward Voltage

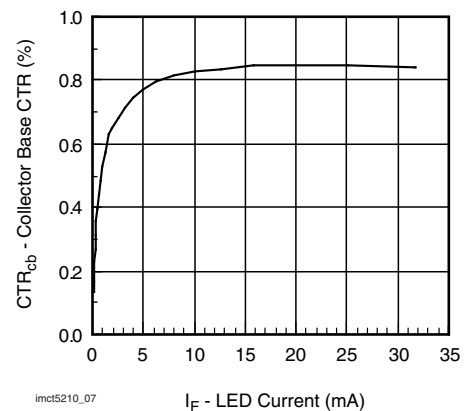

Fig. 6 - Collector Base CTR vs. LED Current

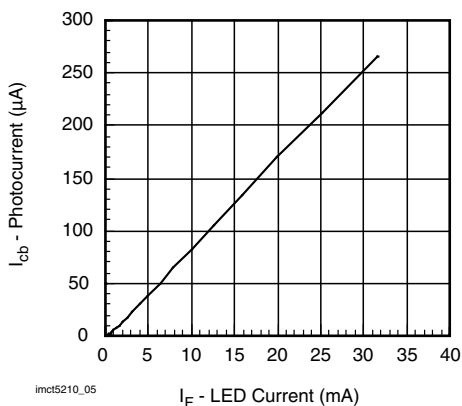

Fig. 4 - Collector Base Photocurrent vs. LED Current

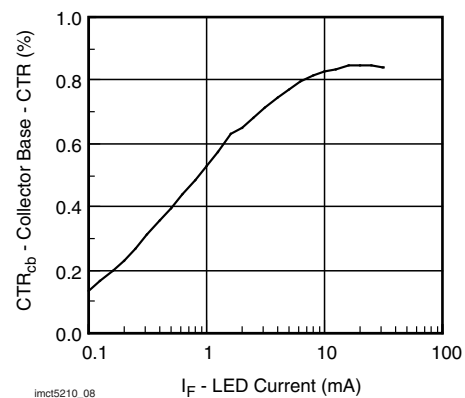

Fig. 7 - Collector Base CTR vs. LED Current

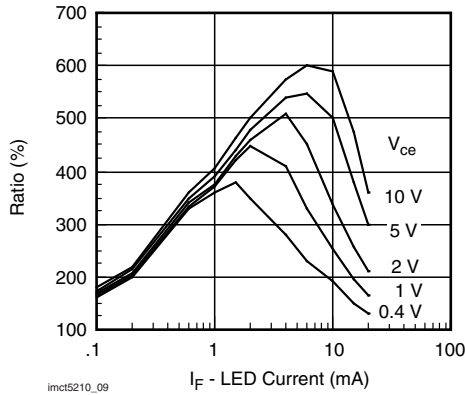

Fig. 8 - CTR vs. LED Current

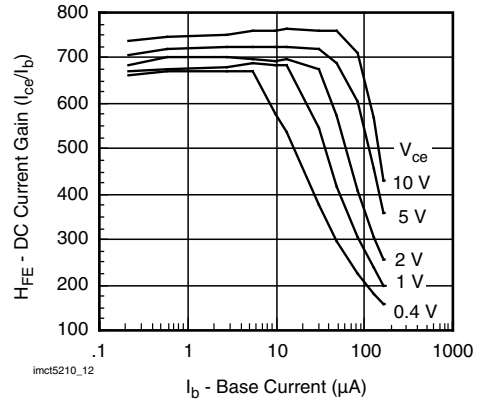

Fig. 11 - Transistor Current Gain vs. Base Current

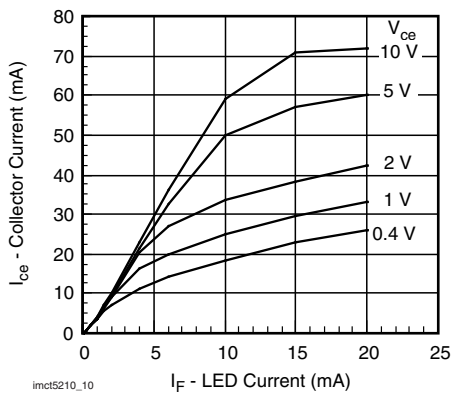

Fig. 9 - Collector Current vs. LED Current

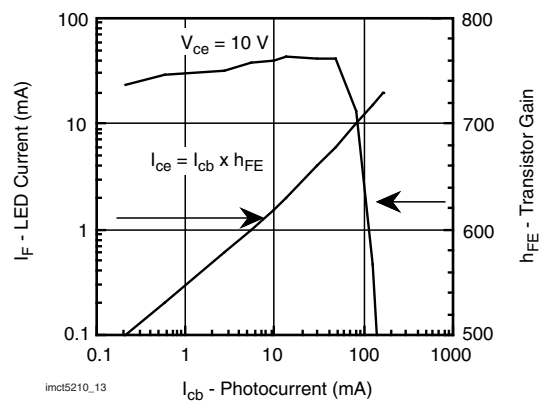

Fig. 12 - Transfer Curve

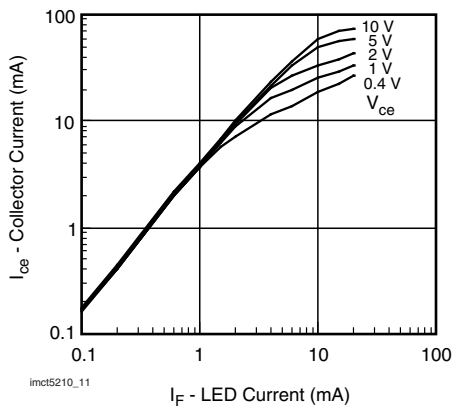

Fig. 10 - Collector Current vs. LED Current

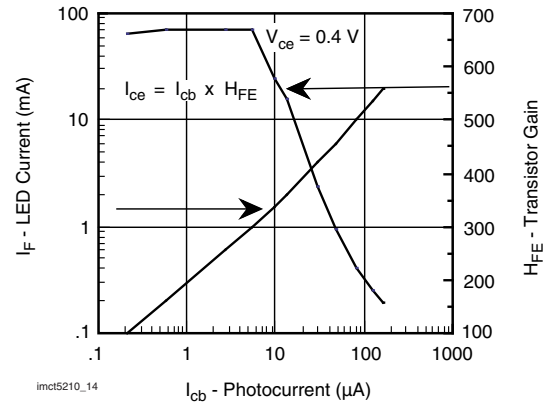

Fig. 13 - Transfer Curve

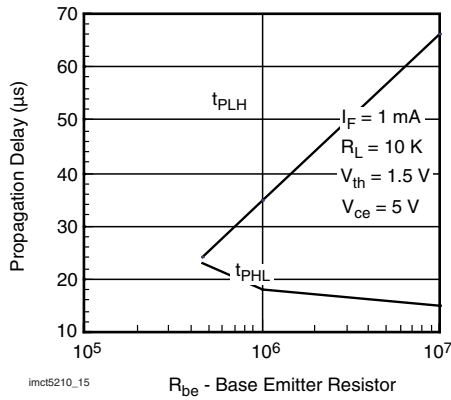

Fig. 14 - Propagation Delay vs. Base Emitter Resistor

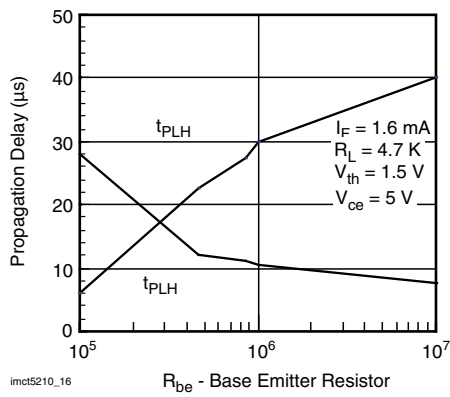

Fig. 15 - Propagation Delay vs. Base Emitter Resistor

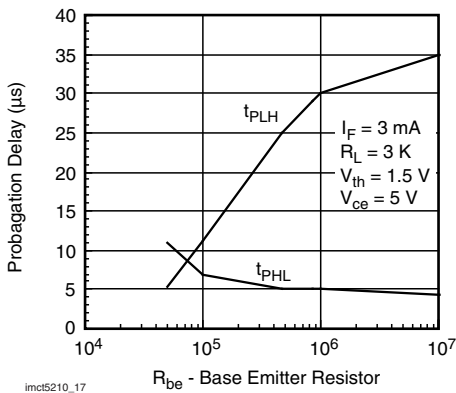
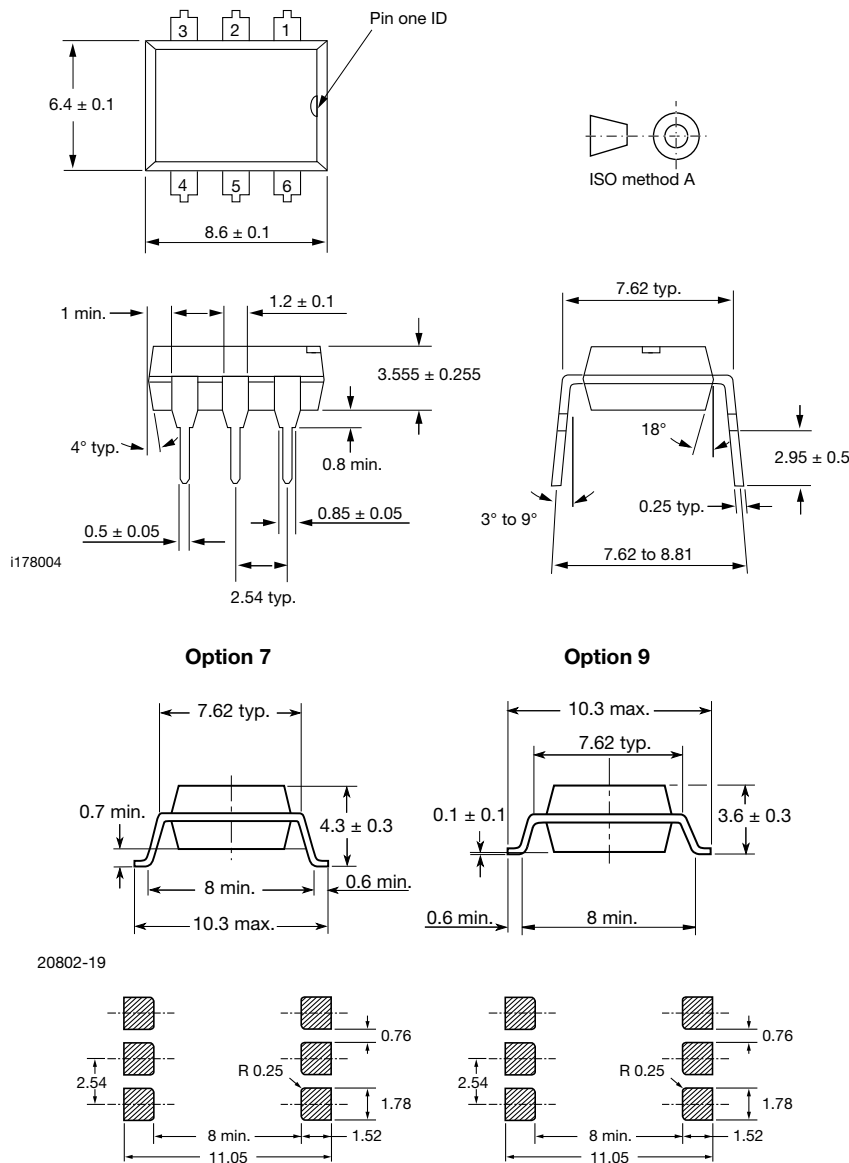

Fig. 16 - Propagation Delay vs. Base Emitter Resistor



**PACKAGE DIMENSIONS** in millimeters



**PACKAGE MARKING** (example)

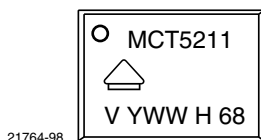

**Notes**

- Only option 7 is reflected in the package marking
- The VDE logo is only marked on option 1 parts
- Tape and reel suffix (T) is not part of the package marking







## **Disclaimer**

ALL PRODUCT, PRODUCT SPECIFICATIONS AND DATA ARE SUBJECT TO CHANGE WITHOUT NOTICE TO IMPROVE RELIABILITY, FUNCTION OR DESIGN OR OTHERWISE.

Vishay Intertechnology, Inc., its affiliates, agents, and employees, and all persons acting on its or their behalf (collectively, "Vishay"), disclaim any and all liability for any errors, inaccuracies or incompleteness contained in any datasheet or in any other disclosure relating to any product.

Vishay makes no warranty, representation or guarantee regarding the suitability of the products for any particular purpose or the continuing production of any product. To the maximum extent permitted by applicable law, Vishay disclaims (i) any and all liability arising out of the application or use of any product, (ii) any and all liability, including without limitation special, consequential or incidental damages, and (iii) any and all implied warranties, including warranties of fitness for particular purpose, non-infringement and merchantability.

Statements regarding the suitability of products for certain types of applications are based on Vishay's knowledge of typical requirements that are often placed on Vishay products in generic applications. Such statements are not binding statements about the suitability of products for a particular application. It is the customer's responsibility to validate that a particular product with the properties described in the product specification is suitable for use in a particular application. Parameters provided in datasheets and / or specifications may vary in different applications and performance may vary over time. All operating parameters, including typical parameters, must be validated for each customer application by the customer's technical experts. Product specifications do not expand or otherwise modify Vishay's terms and conditions of purchase, including but not limited to the warranty expressed therein.

Except as expressly indicated in writing, Vishay products are not designed for use in medical, life-saving, or life-sustaining applications or for any other application in which the failure of the Vishay product could result in personal injury or death. Customers using or selling Vishay products not expressly indicated for use in such applications do so at their own risk. Please contact authorized Vishay personnel to obtain written terms and conditions regarding products designed for such applications.

No license, express or implied, by estoppel or otherwise, to any intellectual property rights is granted by this document or by any conduct of Vishay. Product names and markings noted herein may be trademarks of their respective owners.