

Surface Mount PAR[®] Transient Voltage Suppressors

High Temperature Stability and High Reliability Conditions

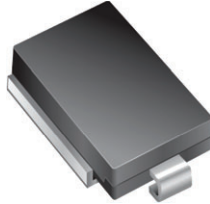

DO-218AB

| PRIMARY CHARACTERISTICS | |
|---------------------------------|------------------|
| V_{BR} | 11.1 V to 52.8 V |
| V_{WM} | 10 V to 43 V |
| P_{PPM} (10 x 1000 μ s) | 6600 W |
| P_{PPM} (10 x 10 000 μ s) | 5200 W |
| P_D | 8 W |
| I_{FSM} | 700 A |
| T_J max. | 175 °C |
| Polarity | Uni-directional |
| Package | DO-218AB |

FEATURES

- Junction passivation optimized design passivated anisotropic rectifier technology
- $T_J = 175$ °C capability suitable for high reliability and automotive requirement
- Available in uni-directional polarity only
- Low leakage current
- Low forward voltage drop
- High surge capability
- Meets ISO7637-2 surge specification (varied by test condition)
- Meets MSL level 1, per J-STD-020, LF maximum peak of 245 °C
- AEC-Q101 qualified
- Material categorization: for definitions of compliance please see www.vishay.com/doc?99912



RoHS
COMPLIANT

TYPICAL APPLICATIONS

Use in sensitive electronics protection against voltage transients induced by inductive load switching and lighting, especially for automotive load dump protection application.

MECHANICAL DATA

Case: DO-218AB

Molding compound meets UL 94 V-0 flammability rating Base P/NHE3_X - RoHS-compliant and AEC-Q101 qualified ("X" denotes revision code e.g. A, B, ...)

Terminals: matte tin plated leads, solderable per J-STD-002 and JESD 22-B102

HE3 suffix meets JESD 201 class 2 whisker test

Polarity: heatsink is anode

| MAXIMUM RATINGS ($T_C = 25$ °C unless otherwise noted) | | | |
|--|--------------------------|---------------------------------|------|
| PARAMETER | SYMBOL | VALUE | UNIT |
| Peak pulse power dissipation | P_{PPM} | with 10/1000 μ s waveform | 6600 |
| | | with 10/10 000 μ s waveform | 5200 |
| Power dissipation on infinite heatsink at $T_C = 25$ °C (fig. 1) | P_D | 8.0 | W |
| Peak pulse current with 10/1000 μ s waveform | I_{PPM} ⁽¹⁾ | See next table | A |
| Peak forward surge current 8.3 ms single half sine-wave | I_{FSM} | 700 | A |
| Operating junction and storage temperature range | T_J, T_{STG} | -55 to +175 | °C |

Note

⁽¹⁾ Non-repetitive current pulse derated above $T_A = 25$ °C



| ELECTRICAL CHARACTERISTICS ($T_C = 25\text{ }^\circ\text{C}$ unless otherwise noted) | | | | | | | | |
|--|--------------------------------|------|-------------------------|--------------------------------|---|---|---|---|
| DEVICE TYPE | BREAKDOWN VOLTAGE V_{BR} (V) | | TEST CURRENT I_T (mA) | STAND-OFF VOLTAGE V_{WM} (V) | MAXIMUM REVERSE LEAKAGE AT V_{WM} I_D (μA) | MAXIMUM REVERSE LEAKAGE AT V_{WM} $T_J = 175\text{ }^\circ\text{C}$ I_D (μA) | MAX. PEAK PULSE CURRENT AT 10/1000 μs WAVEFORM (A) | MAXIMUM CLAMPING VOLTAGE AT I_{PPM} V_C (V) |
| | MIN. | MAX. | | | | | | |
| SM8S10A | 11.1 | 12.3 | 5.0 | 10.0 | 15 | 250 | 388 | 17.0 |
| SM8S11A | 12.2 | 13.5 | 5.0 | 11.0 | 10 | 150 | 363 | 18.2 |
| SM8S12A | 13.3 | 14.7 | 5.0 | 12.0 | 10 | 150 | 332 | 19.9 |
| SM8S13A | 14.4 | 15.9 | 5.0 | 13.0 | 10 | 150 | 307 | 21.5 |
| SM8S14A | 15.6 | 17.2 | 5.0 | 14.0 | 10 | 150 | 284 | 23.2 |
| SM8S15A | 16.7 | 18.5 | 5.0 | 15.0 | 10 | 150 | 270 | 24.4 |
| SM8S16A | 17.8 | 19.7 | 5.0 | 16.0 | 10 | 150 | 254 | 26.0 |
| SM8S17A | 18.9 | 20.9 | 5.0 | 17.0 | 10 | 150 | 239 | 27.6 |
| SM8S18A | 20.0 | 22.1 | 5.0 | 18.0 | 10 | 150 | 226 | 29.2 |
| SM8S20A | 22.2 | 24.5 | 5.0 | 20.0 | 10 | 150 | 204 | 32.4 |
| SM8S22A | 24.4 | 26.9 | 5.0 | 22.0 | 10 | 150 | 186 | 35.5 |
| SM8S24A | 26.7 | 29.5 | 5.0 | 24.0 | 10 | 150 | 170 | 38.9 |
| SM8S26A | 28.9 | 31.9 | 5.0 | 26.0 | 10 | 150 | 157 | 42.1 |
| SM8S28A | 31.1 | 34.4 | 5.0 | 28.0 | 10 | 150 | 145 | 45.4 |
| SM8S30A | 33.3 | 36.8 | 5.0 | 30.0 | 10 | 150 | 136 | 48.4 |
| SM8S33A | 36.7 | 40.6 | 5.0 | 33.0 | 10 | 150 | 124 | 53.3 |
| SM8S36A | 40.0 | 44.2 | 5.0 | 36.0 | 10 | 150 | 114 | 58.1 |
| SM8S40A | 44.4 | 49.1 | 5.0 | 40.0 | 10 | 150 | 102 | 64.5 |
| SM8S43A | 47.8 | 52.8 | 5.0 | 43.0 | 10 | 150 | 95.1 | 69.4 |

Note

- For all types maximum $V_F = 1.8\text{ V}$ at $I_F = 100\text{ A}$ measured on 8.3 ms single half sine-wave or equivalent square wave, duty cycle = 4 pulses per minute maximum

| THERMAL CHARACTERISTICS ($T_C = 25\text{ }^\circ\text{C}$ unless otherwise noted) | | | |
|---|-----------------|-------|--------------------|
| PARAMETER | SYMBOL | VALUE | UNIT |
| Typical thermal resistance, junction to case | $R_{\theta JC}$ | 0.90 | $^\circ\text{C/W}$ |

| ORDERING INFORMATION (Example) | | | | |
|---------------------------------------|-----------------|------------------------|---------------|---|
| PREFERRED P/N | UNIT WEIGHT (g) | PREFERRED PACKAGE CODE | BASE QUANTITY | DELIVERY MODE |
| SM8S10AHE3_A/I ⁽¹⁾ | 2.605 | I | 750 | 13" diameter plastic tape and reel, anode towards the sprocket hole |

Note

- ⁽¹⁾ AEC-Q101 qualified



RATINGS AND CHARACTERISTICS CURVES ($T_A = 25\text{ }^\circ\text{C}$ unless otherwise noted)

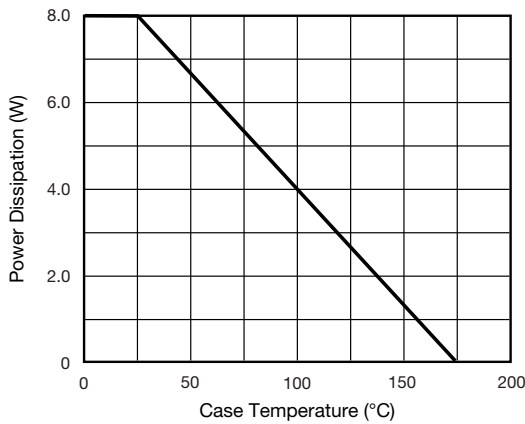

Fig. 1 - Power Derating Curve

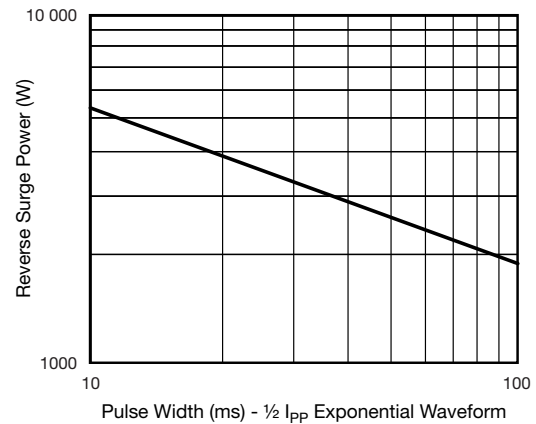

Fig. 4 - Reverse Power Capability

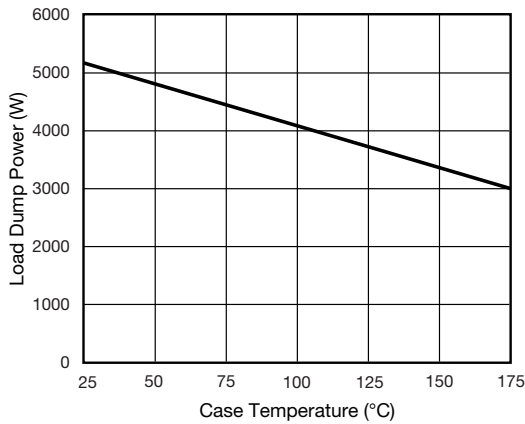

Fig. 2 - Load Dump Power Characteristics (10 ms Exponential Waveform)

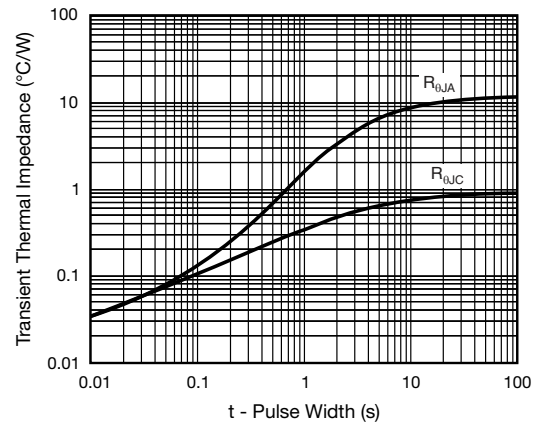

Fig. 5 - Typical Transient Thermal Impedance

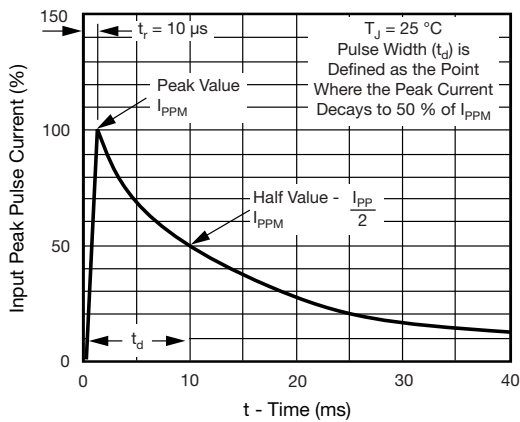

Fig. 3 - Pulse Waveform

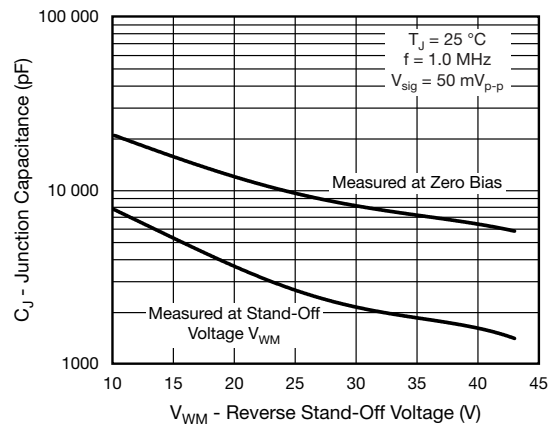
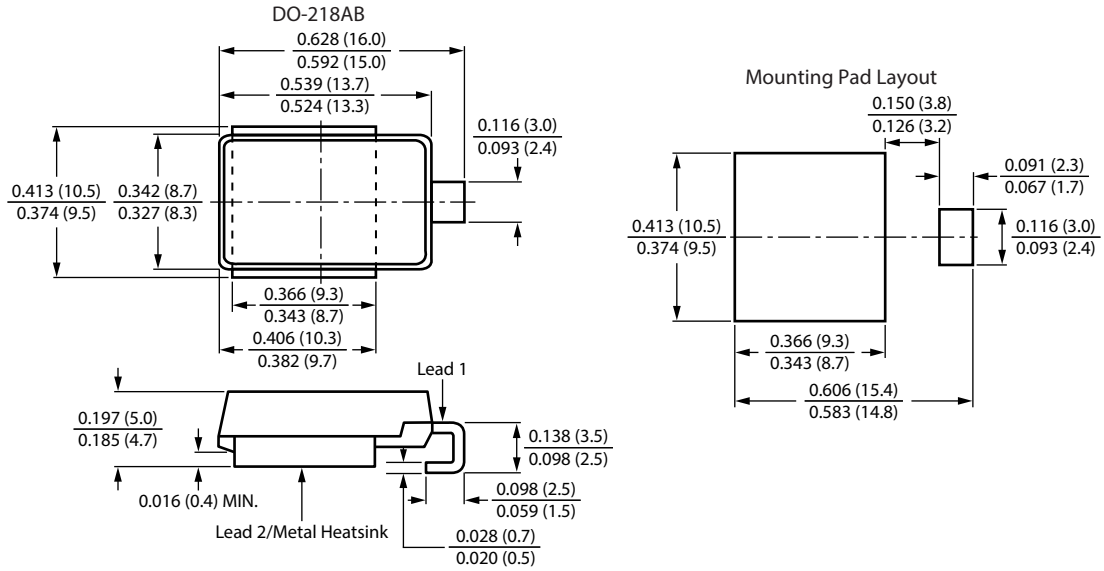

Fig. 6 - Typical Junction Capacitance



PACKAGE OUTLINE DIMENSIONS in inches (millimeters)





Disclaimer

ALL PRODUCT, PRODUCT SPECIFICATIONS AND DATA ARE SUBJECT TO CHANGE WITHOUT NOTICE TO IMPROVE RELIABILITY, FUNCTION OR DESIGN OR OTHERWISE.

Vishay Intertechnology, Inc., its affiliates, agents, and employees, and all persons acting on its or their behalf (collectively, "Vishay"), disclaim any and all liability for any errors, inaccuracies or incompleteness contained in any datasheet or in any other disclosure relating to any product.

Vishay makes no warranty, representation or guarantee regarding the suitability of the products for any particular purpose or the continuing production of any product. To the maximum extent permitted by applicable law, Vishay disclaims (i) any and all liability arising out of the application or use of any product, (ii) any and all liability, including without limitation special, consequential or incidental damages, and (iii) any and all implied warranties, including warranties of fitness for particular purpose, non-infringement and merchantability.

Statements regarding the suitability of products for certain types of applications are based on Vishay's knowledge of typical requirements that are often placed on Vishay products in generic applications. Such statements are not binding statements about the suitability of products for a particular application. It is the customer's responsibility to validate that a particular product with the properties described in the product specification is suitable for use in a particular application. Parameters provided in datasheets and / or specifications may vary in different applications and performance may vary over time. All operating parameters, including typical parameters, must be validated for each customer application by the customer's technical experts. Product specifications do not expand or otherwise modify Vishay's terms and conditions of purchase, including but not limited to the warranty expressed therein.

Except as expressly indicated in writing, Vishay products are not designed for use in medical, life-saving, or life-sustaining applications or for any other application in which the failure of the Vishay product could result in personal injury or death. Customers using or selling Vishay products not expressly indicated for use in such applications do so at their own risk. Please contact authorized Vishay personnel to obtain written terms and conditions regarding products designed for such applications.

No license, express or implied, by estoppel or otherwise, to any intellectual property rights is granted by this document or by any conduct of Vishay. Product names and markings noted herein may be trademarks of their respective owners.