

## Dual 1 Form A Solid-State Relay

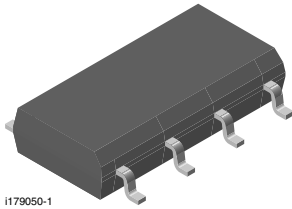

i179050-1

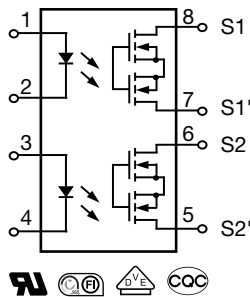

### DESCRIPTION

The LH1532FP is a dual 1 form A (SPST) which can replace electromechanical relays in many applications. They are constructed using a GaAlAs LED for activation control and an integrated monolithic die for the switch output. The die is comprised of a photodiode array, switch control circuitry and MOSFET switches. The SSR features low on-resistance, high breakdown voltage and current-limit circuitry that protects the relay from telephone line induced lightning surges.

### AGENCY APPROVALS

- UL1577, file no. E52744 system code O
- DIN EN 60747-5-5 (VDE 0884)
- FIMKO approval
- CQC GB4943.1-2011 (suitable for installation altitude below 2000 m)

### FEATURES

- Solid-state relay (equivalent to AQW210S)
  - Typical  $R_{ON}$  20  $\Omega$
  - Load voltage 350 V
  - Load current 120 mA
  - Current limit protection
  - High surge capability
  - Clean bounce free switching
  - Low power consumption
  - High reliability monolithic receptor
- Two independent relays in a single package
- Package - flat pak
- Isolation test voltage, 3000  $V_{RMS}$
- Material categorization: For definitions of compliance please see [www.vishay.com/doc?99912](http://www.vishay.com/doc?99912)



RoHS  
COMPLIANT

### APPLICATIONS

- General telecom switching
  - On/off hook control
  - Ring relay
  - Ground start
- Industrial controls
  - Triac predriver
  - Output modules
- Peripherals
  - Transducer driver
- Instrumentation
  - Automatic tuning/balancing
  - Flying capacitor
  - Analog multiplexing

### Note

- See "solid-state relays" (application note 56)

ORDERING INFORMATION	
<div style="display: flex; justify-content: space-around; align-items: center;"> <div style="text-align: center;"> <div style="border: 1px solid black; padding: 2px 5px;">L</div> <div style="border: 1px solid black; padding: 2px 5px;">H</div> <div style="border: 1px solid black; padding: 2px 5px;">1</div> <div style="border: 1px solid black; padding: 2px 5px;">5</div> <div style="border: 1px solid black; padding: 2px 5px;">3</div> <div style="border: 1px solid black; padding: 2px 5px;">2</div> </div> <div style="text-align: center;"> <div style="border: 1px solid black; padding: 2px 5px;">F</div> <div style="border: 1px solid black; padding: 2px 5px;">P</div> </div> <div style="text-align: center;"> <div style="border: 1px solid black; padding: 2px 5px;">T</div> <div style="border: 1px solid black; padding: 2px 5px;">R</div> </div> <div style="text-align: center;"> </div> </div> <p style="text-align: center;">PART NUMBER      PACKAGE CONFIG.      TAPE AND REEL</p>	
<b>PACKAGE</b>	<b>UL, FIMKO</b>
SOP-8, tubes	LH1532FP
SOP-8, tape and reel	LH1532FPTR



<b>ABSOLUTE MAXIMUM RATINGS</b> ( $T_{amb} = 25\text{ }^{\circ}\text{C}$ , unless otherwise specified)				
PARAMETER	TEST CONDITION	SYMBOL	VALUE	UNIT
<b>INPUT</b>				
LED continuous forward current		$I_F$	50	mA
LED reverse voltage	$I_R \leq 10\text{ }\mu\text{A}$	$V_R$	6	V
<b>OUTPUT</b>				
DC or peak AC load voltage	$I_L \leq 50\text{ }\mu\text{A}$	$V_L$	350	V
Continuous DC load current		$I_L$	120	mA
<b>SSR</b>				
Ambient temperature range		$T_{amb}$	- 40 to + 85	$^{\circ}\text{C}$
Storage temperature range		$T_{stg}$	- 40 to + 125	$^{\circ}\text{C}$
Soldering temperature <sup>(1)</sup>	$t = 10\text{ s max.}$	$T_{sld}$	260	$^{\circ}\text{C}$
Isolation test voltage	$t = 1\text{ s}$	$V_{ISO}$	3000	$V_{RMS}$
Isolation resistance	$V_{IO} = 500\text{ V}, T_{amb} = 25\text{ }^{\circ}\text{C}$	$R_{IO}$	$\geq 10^{12}$	$\Omega$
	$V_{IO} = 500\text{ V}, T_{amb} = 100\text{ }^{\circ}\text{C}$	$R_{IO}$	$\geq 10^{11}$	$\Omega$
Total power dissipation		$P_{tot}$	600	mW

**Notes**

- Stresses in excess of the absolute maximum ratings can cause permanent damage to the device. Functional operation of the device is not implied at these or any other conditions in excess of those given in the operational sections of this document. Exposure to absolute maximum ratings for extended periods of the time can adversely affect reliability.
- <sup>(1)</sup> Refer to reflow profile for soldering conditions for surface mounted devices.

<b>ELECTRICAL CHARACTERISTICS</b> ( $T_{amb} = 25\text{ }^{\circ}\text{C}$ , unless otherwise specified)						
PARAMETER	TEST CONDITION	SYMBOL	MIN.	TYP.	MAX.	UNIT
<b>INPUT</b>						
LED forward current, switch turn-on	$I_L = 100\text{ mA}, t = 10\text{ ms}$	$I_{Fon}$		1.2	3	mA
LED forward current, switch turn-off	$V_L = \pm 300\text{ V}$	$I_{Foff}$	0.2			mA
LED forward voltage	$I_F = 10\text{ mA}$	$V_F$	1	1.22	1.5	V
<b>OUTPUT</b>						
On-resistance	$I_F = 5\text{ mA}, I_L = \pm 50\text{ mA}$	$R_{ON}$		20	25	$\Omega$
Off-resistance	$I_F = 0\text{ mA}, V_L = \pm 100\text{ V}$	$R_{OFF}$		5000		G $\Omega$
Current limit	$I_F = 5\text{ mA}, t = 5\text{ ms}$	$I_{Limit}$	170	210	250	mA
Output off-state leakage current	$I_F = 0\text{ mA}, V_L = \pm 100\text{ V}$	$I_O$		0.6	200	nA
	$I_F = 0\text{ mA}, V_L = \pm 350\text{ V}$	$I_O$			1	$\mu\text{A}$
Output capacitance	$I_F = 0\text{ mA}, V_L = \pm 1\text{ V}$	$C_O$		55		pF
Pole-to-pole capacitance (S1 to S2)	$I_F = 5\text{ mA}$			0.5		pF
<b>TRANSFER</b>						
Switch offset	$I_F = 5\text{ mA}$	$V_{OS}$		0.15		$\mu\text{V}$

**Note**

- Minimum and maximum values are testing requirements. Typical values are characteristics of the device and are the result of engineering evaluations. Typical values are for information only and are not part of the testing requirements.

<b>SWITCHING CHARACTERISTICS</b> ( $T_{amb} = 25\text{ }^{\circ}\text{C}$ , unless otherwise specified)						
PARAMETER	TEST CONDITION	SYMBOL	MIN.	TYP.	MAX.	UNIT
Turn-on time	$I_F = 5\text{ mA}, I_L = 50\text{ mA}$	$t_{on}$		1.1	2.5	ms
Turn-off time	$I_F = 5\text{ mA}, I_L = 50\text{ mA}$	$t_{off}$		0.06	2.5	ms

**TYPICAL CHARACTERISTICS** ( $T_{amb} = 25\text{ }^{\circ}\text{C}$ , unless otherwise specified)

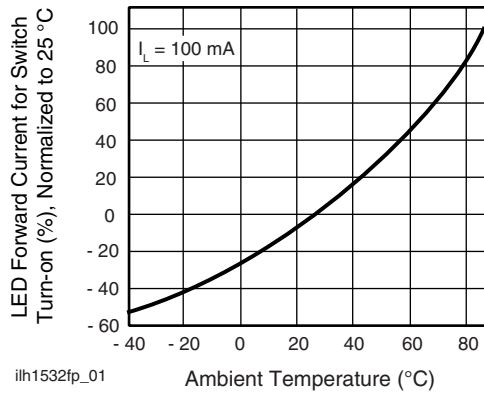

ilh1532fp\_01

Fig. 1 - LED Current for Switch Turn-on vs. Temperature

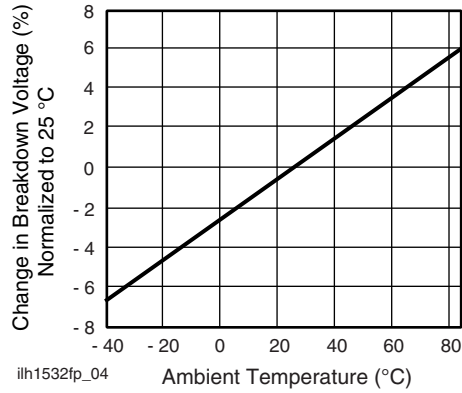

ilh1532fp\_04

Fig. 4 - Switch Breakdown Voltage vs. Temperature

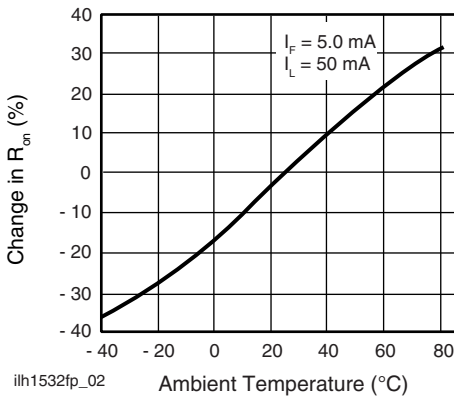

ilh1532fp\_02

Fig. 2 - On-Resistance vs. Temperature

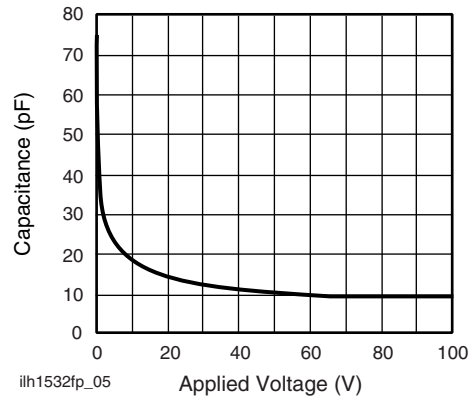

ilh1532fp\_05

Fig. 5 - Switch Capacitance vs. Applied Voltage

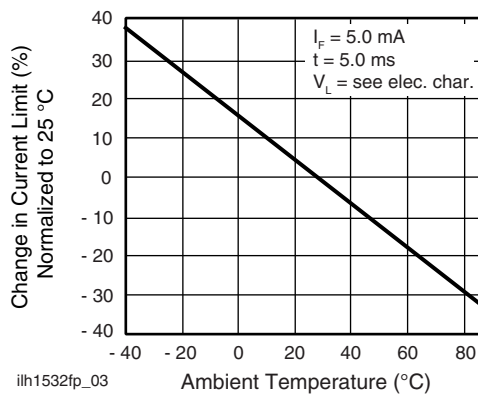

ilh1532fp\_03

Fig. 3 - Current Limit vs. Temperature

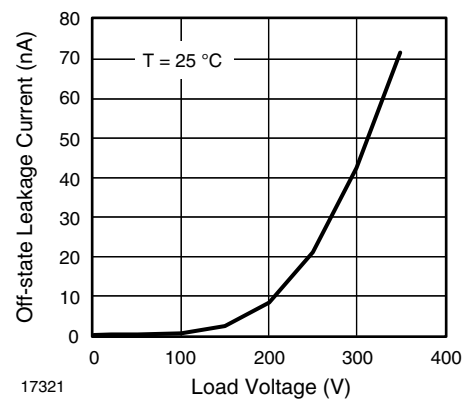

17321

Fig. 6 - Leakage Current vs. Applied Voltage

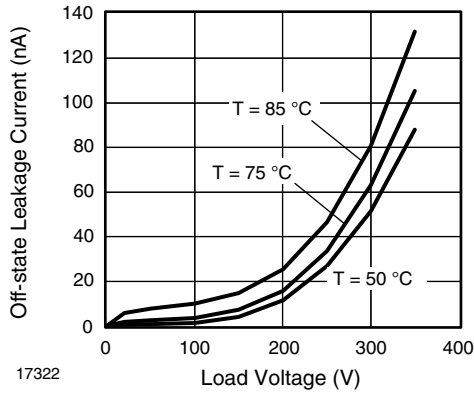

Fig. 7 - Leakage Current vs. Applied Voltage at Elevated Temperatures

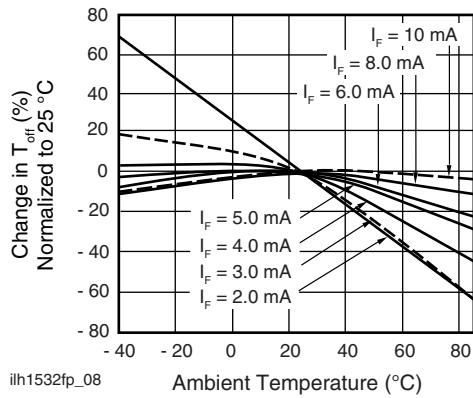

Fig. 8 - Turn-off Time vs. Temperature

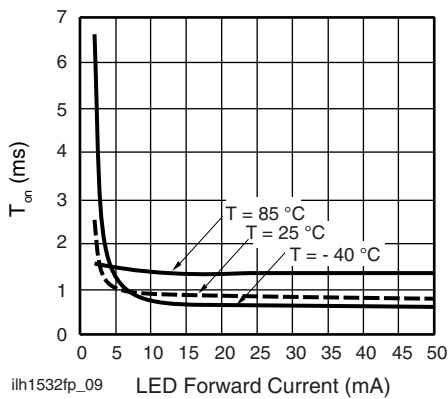
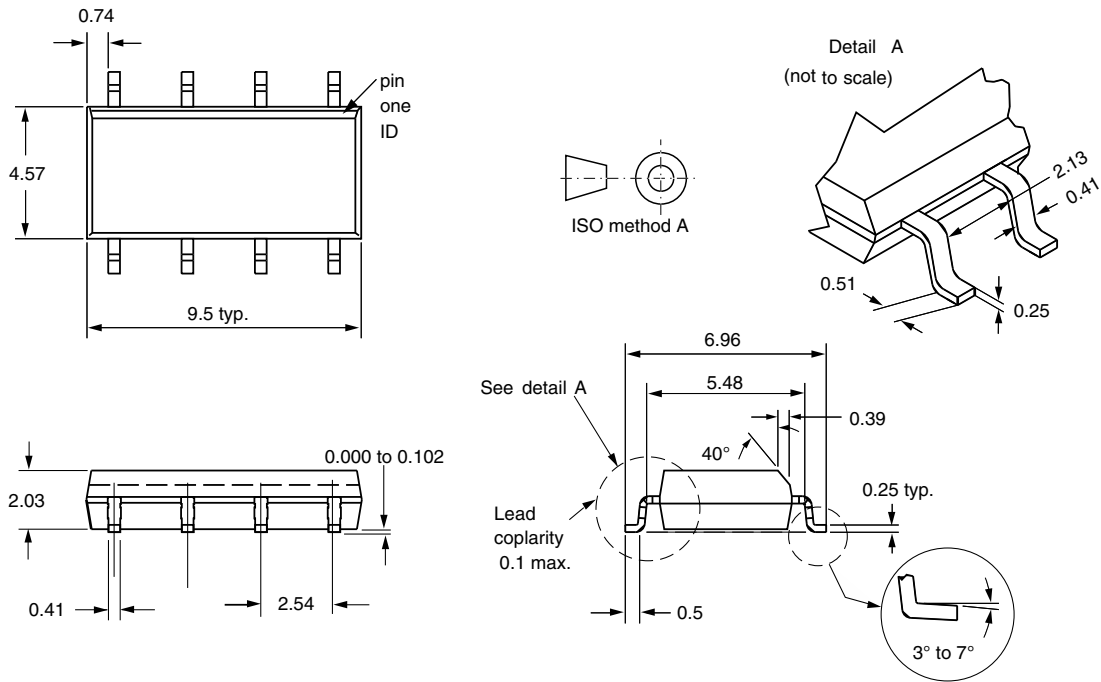

Fig. 9 - Turn-on Time vs. LED Current



### PACKAGE DIMENSIONS in millimeters



i178024

### PACKAGE MARKING (example)

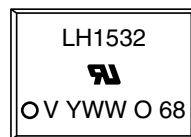

#### Note

- Tape and reel suffix (TR) is not part of the package marking.



## Disclaimer

ALL PRODUCT, PRODUCT SPECIFICATIONS AND DATA ARE SUBJECT TO CHANGE WITHOUT NOTICE TO IMPROVE RELIABILITY, FUNCTION OR DESIGN OR OTHERWISE.

Vishay Intertechnology, Inc., its affiliates, agents, and employees, and all persons acting on its or their behalf (collectively, "Vishay"), disclaim any and all liability for any errors, inaccuracies or incompleteness contained in any datasheet or in any other disclosure relating to any product.

Vishay makes no warranty, representation or guarantee regarding the suitability of the products for any particular purpose or the continuing production of any product. To the maximum extent permitted by applicable law, Vishay disclaims (i) any and all liability arising out of the application or use of any product, (ii) any and all liability, including without limitation special, consequential or incidental damages, and (iii) any and all implied warranties, including warranties of fitness for particular purpose, non-infringement and merchantability.

Statements regarding the suitability of products for certain types of applications are based on Vishay's knowledge of typical requirements that are often placed on Vishay products in generic applications. Such statements are not binding statements about the suitability of products for a particular application. It is the customer's responsibility to validate that a particular product with the properties described in the product specification is suitable for use in a particular application. Parameters provided in datasheets and / or specifications may vary in different applications and performance may vary over time. All operating parameters, including typical parameters, must be validated for each customer application by the customer's technical experts. Product specifications do not expand or otherwise modify Vishay's terms and conditions of purchase, including but not limited to the warranty expressed therein.

Except as expressly indicated in writing, Vishay products are not designed for use in medical, life-saving, or life-sustaining applications or for any other application in which the failure of the Vishay product could result in personal injury or death. Customers using or selling Vishay products not expressly indicated for use in such applications do so at their own risk. Please contact authorized Vishay personnel to obtain written terms and conditions regarding products designed for such applications.

No license, express or implied, by estoppel or otherwise, to any intellectual property rights is granted by this document or by any conduct of Vishay. Product names and markings noted herein may be trademarks of their respective owners.