

Hyperfast Rectifier, 15 A FRED Pt®

TO-220AC

FEATURES

- Hyperfast recovery time
- Low forward voltage drop
- 175 °C operating junction temperature
- Low leakage current
- Designed and qualified according to JEDEC®-JESD 47
- Material categorization:
for definitions of compliance please see www.vishay.com/doc?99912

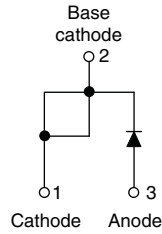

| PRODUCT SUMMARY | |
|-----------------|--------------------|
| Package | TO-220AC |
| $I_{F(AV)}$ | 15 A |
| V_R | 300 V |
| V_F at I_F | 0.85 V |
| t_{rr} typ. | See Recovery table |
| T_J max. | 175 °C |
| Diode variation | Single die |

DESCRIPTION / APPLICATIONS

300 V series are the state of the art hyperfast recovery rectifiers designed with optimized performance of forward voltage drop and hyperfast recovery time.

The planar structure and the platinum doped life time control guarantee the best overall performance, ruggedness and reliability characteristics.

These devices are intended for use in the output rectification stage of SMPS, UPS, DC/DC converters as well as freewheeling diodes in low voltage inverters and chopper motor drives.

Their extremely optimized stored charge and low recovery current minimize the switching losses and reduce over dissipation in the switching element and snubbers.

| ABSOLUTE MAXIMUM RATINGS | | | | |
|---|----------------|-----------------------|-------------|-------|
| PARAMETER | SYMBOL | TEST CONDITIONS | VALUES | UNITS |
| Repetitive peak reverse voltage | V_{RRM} | | 300 | V |
| Average rectified forward current | $I_{F(AV)}$ | $T_C = 142\text{ °C}$ | 15 | A |
| Non-repetitive peak surge current | I_{FSM} | $T_J = 25\text{ °C}$ | 140 | |
| Operating junction and storage temperatures | T_J, T_{Stg} | | -65 to +175 | °C |

| ELECTRICAL SPECIFICATIONS ($T_J = 25\text{ °C}$ unless otherwise specified) | | | | | | |
|--|---------------|--|------|------|------|---------------|
| PARAMETER | SYMBOL | TEST CONDITIONS | MIN. | TYP. | MAX. | UNITS |
| Breakdown voltage, blocking voltage | V_{BR}, V_R | $I_R = 100\ \mu\text{A}$ | 300 | - | - | V |
| | | $I_F = 15\ \text{A}$ | - | 1.05 | 1.25 | |
| Forward voltage | V_F | $I_F = 15\ \text{A}, T_J = 125\text{ °C}$ | - | 0.85 | 1.00 | V |
| | | $V_R = V_R$ rated | - | 0.05 | 40 | |
| Reverse leakage current | I_R | $T_J = 125\text{ °C}, V_R = V_R$ rated | - | 12 | 400 | μA |
| | | $V_R = 300\ \text{V}$ | - | 45 | - | |
| Junction capacitance | C_T | $V_R = 300\ \text{V}$ | - | 45 | - | pF |
| Series inductance | L_S | Measured lead to lead 5 mm from package body | - | 8 | - | nH |



| DYNAMIC RECOVERY CHARACTERISTICS ($T_J = 25\text{ }^\circ\text{C}$ unless otherwise specified) | | | | | | |
|---|-----------|--|------|------|------|-------|
| PARAMETER | SYMBOL | TEST CONDITIONS | MIN. | TYP. | MAX. | UNITS |
| Reverse recovery time | t_{rr} | $I_F = 1.0\text{ A}$, $di_F/dt = 50\text{ A}/\mu\text{s}$, $V_R = 30\text{ V}$ | - | - | 40 | ns |
| | | $T_J = 25\text{ }^\circ\text{C}$ | - | 32 | - | |
| | | $T_J = 125\text{ }^\circ\text{C}$ | - | 45 | - | |
| Peak recovery current | I_{RRM} | $T_J = 25\text{ }^\circ\text{C}$ | - | 2.4 | - | A |
| | | $T_J = 125\text{ }^\circ\text{C}$ | - | 6.1 | - | |
| Reverse recovery charge | Q_{rr} | $T_J = 25\text{ }^\circ\text{C}$ | - | 38 | - | nC |
| | | $T_J = 125\text{ }^\circ\text{C}$ | - | 137 | - | |

| THERMAL - MECHANICAL SPECIFICATIONS ($T_J = 25\text{ }^\circ\text{C}$ unless otherwise noted) | | | | | | |
|--|-------------------|--|--------------|------|------------|---------------------------|
| PARAMETER | SYMBOL | TEST CONDITIONS | MIN. | TYP. | MAX. | UNITS |
| Maximum junction and storage temperature range | T_J , T_{Stg} | | -65 | - | 175 | $^\circ\text{C}$ |
| Thermal resistance, junction to case | R_{thJC} | | - | 1.02 | 2.0 | $^\circ\text{C}/\text{W}$ |
| Thermal resistance, junction to ambient | R_{thJA} | Typical socket mount | - | - | 70 | |
| Thermal resistance, case to heatsink | R_{thCS} | Mounting surface, flat, smooth and greased | - | 0.2 | - | |
| Weight | | | - | 2.0 | - | g |
| | | | - | 0.07 | - | oz. |
| Mounting torque | | | 6.0 (5.0) | - | 12 (10) | kgf · cm (lbf · in) |
| Marking device | | Case style TO-220AC | 15ETH03 | | | |

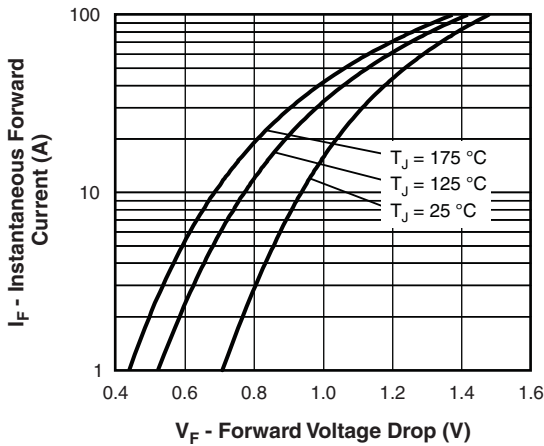

Fig. 1 - Typical Forward Voltage Drop Characteristics

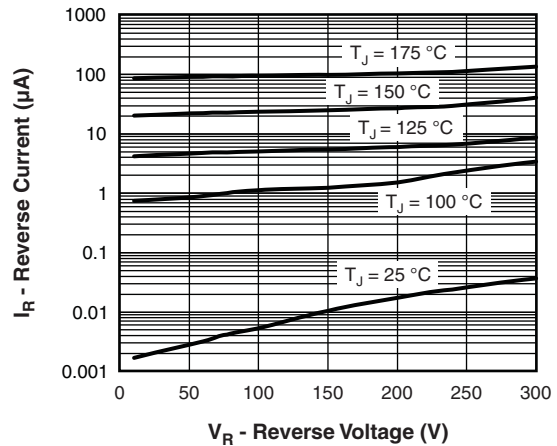

Fig. 2 - Typical Values of Reverse Current vs. Reverse Voltage

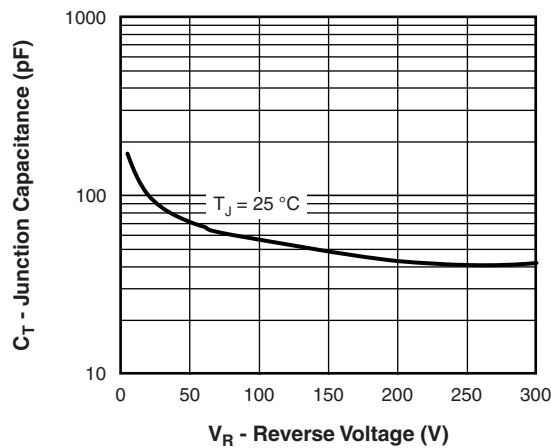

Fig. 3 - Typical Junction Capacitance vs. Reverse Voltage

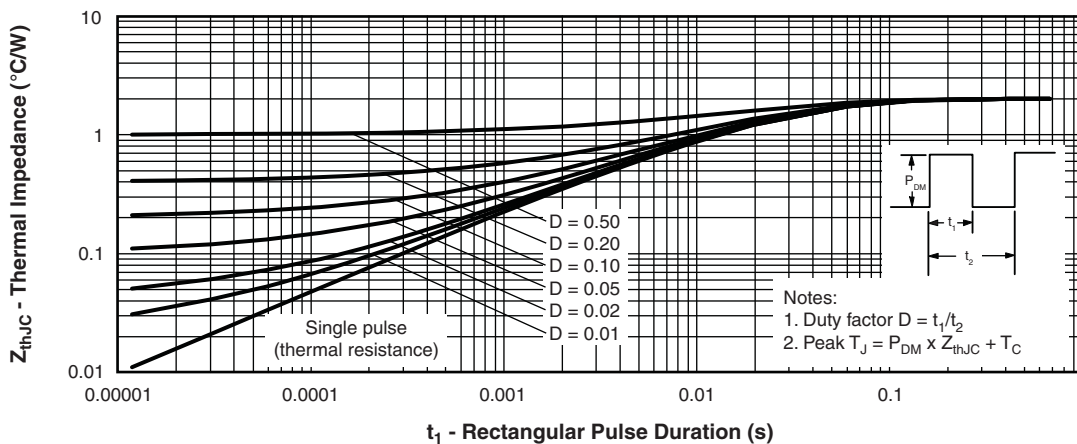

Fig. 4 - Maximum Thermal Impedance Z_{thJC} Characteristics

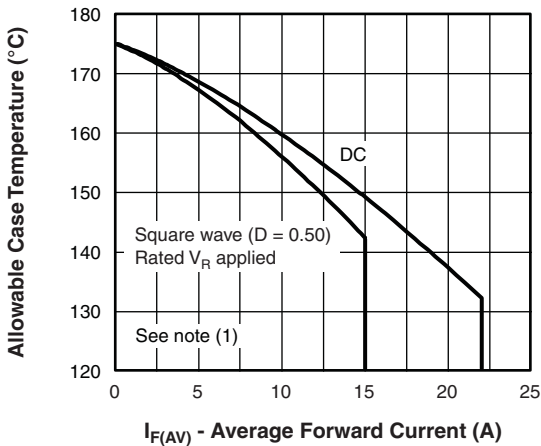

Fig. 5 - Maximum Allowable Case Temperature vs. Average Forward Current

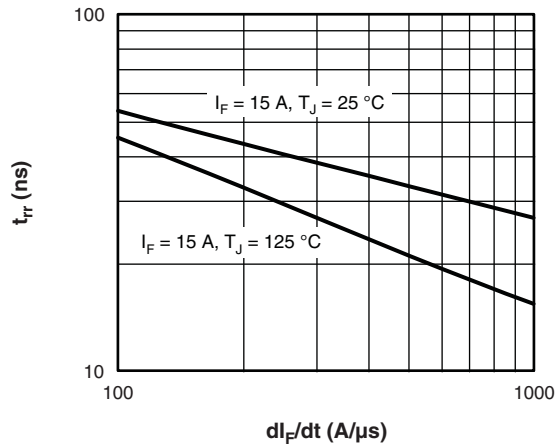

Fig. 7 - Typical Reverse Recovery Time vs. di_F/dt

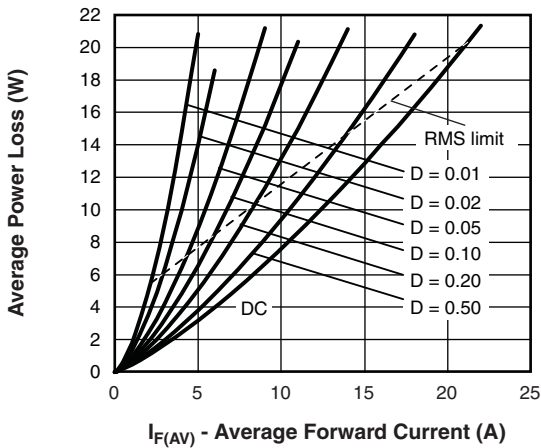

Fig. 6 - Forward Power Loss Characteristics

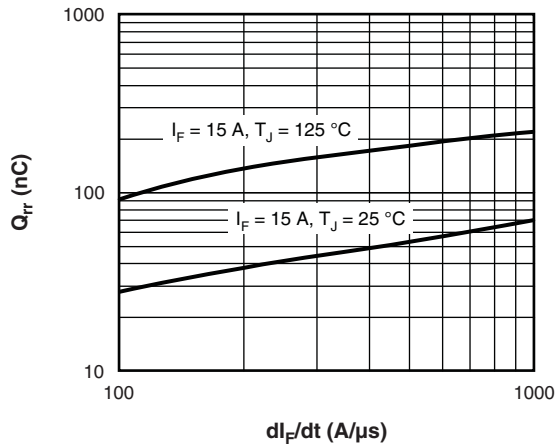

Fig. 8 - Typical Stored Charge vs. di_F/dt

Note

- (1) Formula used: $T_C = T_J - (P_d + P_{d_{REV}}) \times R_{thJC}$;
- P_d = Forward power loss = $I_{F(AV)} \times V_{FM}$ at $(I_{F(AV)}/D)$ (see fig. 6);
- $P_{d_{REV}}$ = Inverse power loss = $V_{R1} \times I_R (1 - D)$; I_R at $V_{R1} = \text{Rated } V_R$

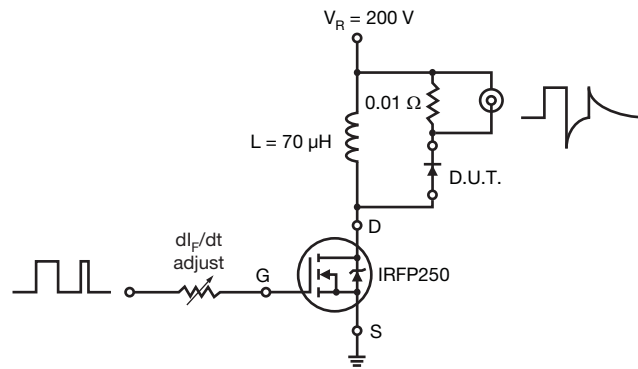
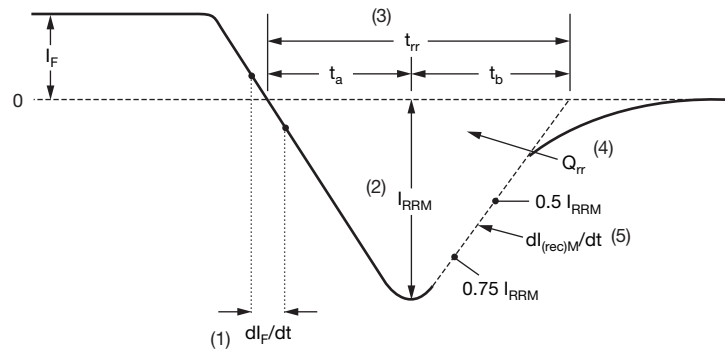

Fig. 9 - Reverse Recovery Parameter Test Circuit



- (1) di_F/dt - rate of change of current through zero crossing
- (2) I_{RRM} - peak reverse recovery current
- (3) t_{rr} - reverse recovery time measured from zero crossing point of negative going I_F to point where a line passing through $0.75 I_{RRM}$ and $0.50 I_{RRM}$ extrapolated to zero current.
- (4) Q_{rr} - area under curve defined by t_{rr} and I_{RRM}
- (5) $di_{(rec)M}/dt$ - peak rate of change of current during t_b portion of t_{rr}

$$Q_{rr} = \frac{t_{rr} \times I_{RRM}}{2}$$

Fig. 10 - Reverse Recovery Waveform and Definitions



ORDERING INFORMATION TABLE

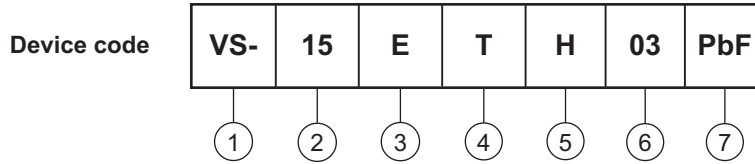

- 1** - Vishay Semiconductors product
- 2** - Current rating (15 = 15 A)
- 3** - E = single diode
- 4** - Package:
T = TO-220
- 5** - H = hyperfast recovery
- 6** - Voltage rating (03 = 300 V)
- 7** - Environmental digit:
PbF = lead (Pb)-free and RoHS compliant
-N3 = halogen-free, RoHS-compliant and totally lead (Pb)-free

| ORDERING INFORMATION (Example) | | | |
|--------------------------------|------------------|------------------------|-------------------------|
| PREFERRED P/N | QUANTITY PER T/R | MINIMUM ORDER QUANTITY | PACKAGING DESCRIPTION |
| VS-15ETH03PbF | 50 | 1000 | Antistatic plastic tube |
| VS-15ETH03-N3 | 50 | 1000 | Antistatic plastic tube |

| LINKS TO RELATED DOCUMENTS | |
|----------------------------|--|
| Dimensions | www.vishay.com/doc?95221 |
| Part marking information | TO-220ACPbF www.vishay.com/doc?95224 |
| | TO-220AC-N3 www.vishay.com/doc?95068 |

TO-220AC

DIMENSIONS in millimeters and inches



| SYMBOL | MILLIMETERS | | INCHES | | NOTES | SYMBOL | MILLIMETERS | | INCHES | | NOTES |
|--------|-------------|-------|--------|-------|-------|--------|-------------|-------|------------|-------|-------|
| | MIN. | MAX. | MIN. | MAX. | | | MIN. | MAX. | MIN. | MAX. | |
| A | 4.25 | 4.65 | 0.167 | 0.183 | | E1 | 6.86 | 8.89 | 0.270 | 0.350 | 6 |
| A1 | 1.14 | 1.40 | 0.045 | 0.055 | | E2 | - | 0.76 | - | 0.030 | 7 |
| A2 | 2.56 | 2.92 | 0.101 | 0.115 | | e | 2.41 | 2.67 | 0.095 | 0.105 | |
| b | 0.69 | 1.01 | 0.027 | 0.040 | | e1 | 4.88 | 5.28 | 0.192 | 0.208 | |
| b1 | 0.38 | 0.97 | 0.015 | 0.038 | 4 | H1 | 6.09 | 6.48 | 0.240 | 0.255 | 6, 7 |
| b2 | 1.20 | 1.73 | 0.047 | 0.068 | | L | 13.52 | 14.02 | 0.532 | 0.552 | |
| b3 | 1.14 | 1.73 | 0.045 | 0.068 | 4 | L1 | 3.32 | 3.82 | 0.131 | 0.150 | 2 |
| c | 0.36 | 0.61 | 0.014 | 0.024 | | L3 | 1.78 | 2.13 | 0.070 | 0.084 | |
| c1 | 0.36 | 0.56 | 0.014 | 0.022 | 4 | L4 | 0.76 | 1.27 | 0.030 | 0.050 | 2 |
| D | 14.85 | 15.25 | 0.585 | 0.600 | 3 | Ø P | 3.54 | 3.73 | 0.139 | 0.147 | |
| D1 | 8.38 | 9.02 | 0.330 | 0.355 | | Q | 2.60 | 3.00 | 0.102 | 0.118 | |
| D2 | 11.68 | 12.88 | 0.460 | 0.507 | 6 | θ | 90° to 93° | | 90° to 93° | | |
| E | 10.11 | 10.51 | 0.398 | 0.414 | 3, 6 | | | | | | |

Notes

- (1) Dimensioning and tolerancing as per ASME Y14.5M-1994
- (2) Lead dimension and finish uncontrolled in L1
- (3) Dimension D, D1 and E do not include mold flash. Mold flash shall not exceed 0.127 mm (0.005") per side. These dimensions are measured at the outermost extremes of the plastic body
- (4) Dimension b1, b3 and c1 apply to base metal only
- (5) Controlling dimension: inches
- (6) Thermal pad contour optional within dimensions E, H1, D2 and E1
- (7) Dimension E2 x H1 define a zone where stamping and singulation irregularities are allowed
- (8) Outline conforms to JEDEC TO-220, D2 (minimum) where dimensions are derived from the actual package outline



Disclaimer

ALL PRODUCT, PRODUCT SPECIFICATIONS AND DATA ARE SUBJECT TO CHANGE WITHOUT NOTICE TO IMPROVE RELIABILITY, FUNCTION OR DESIGN OR OTHERWISE.

Vishay Intertechnology, Inc., its affiliates, agents, and employees, and all persons acting on its or their behalf (collectively, "Vishay"), disclaim any and all liability for any errors, inaccuracies or incompleteness contained in any datasheet or in any other disclosure relating to any product.

Vishay makes no warranty, representation or guarantee regarding the suitability of the products for any particular purpose or the continuing production of any product. To the maximum extent permitted by applicable law, Vishay disclaims (i) any and all liability arising out of the application or use of any product, (ii) any and all liability, including without limitation special, consequential or incidental damages, and (iii) any and all implied warranties, including warranties of fitness for particular purpose, non-infringement and merchantability.

Statements regarding the suitability of products for certain types of applications are based on Vishay's knowledge of typical requirements that are often placed on Vishay products in generic applications. Such statements are not binding statements about the suitability of products for a particular application. It is the customer's responsibility to validate that a particular product with the properties described in the product specification is suitable for use in a particular application. Parameters provided in datasheets and / or specifications may vary in different applications and performance may vary over time. All operating parameters, including typical parameters, must be validated for each customer application by the customer's technical experts. Product specifications do not expand or otherwise modify Vishay's terms and conditions of purchase, including but not limited to the warranty expressed therein.

Except as expressly indicated in writing, Vishay products are not designed for use in medical, life-saving, or life-sustaining applications or for any other application in which the failure of the Vishay product could result in personal injury or death. Customers using or selling Vishay products not expressly indicated for use in such applications do so at their own risk. Please contact authorized Vishay personnel to obtain written terms and conditions regarding products designed for such applications.

No license, express or implied, by estoppel or otherwise, to any intellectual property rights is granted by this document or by any conduct of Vishay. Product names and markings noted herein may be trademarks of their respective owners.