

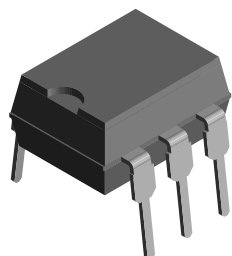

Optocoupler, Phototransistor Output, Low Input Current, With Base Connection

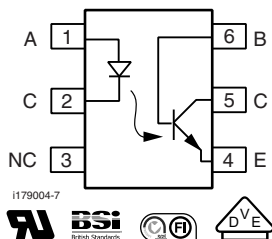

i179004-3



FEATURES

- Saturation CTR - MCT5211, > 100 % at $I_F = 1.6 \text{ mA}$
- High isolation voltage, 5300 V_{RMS}
- Material categorization: for definitions of compliance please see www.vishay.com/doc?99912



RoHS COMPLIANT

AGENCY APPROVALS

- UL1577, file no. E52744 system code H, double protection
- BSI IEC 60950; IEC 60065
- DIN EN 60747-5-2 (VDE 0884) / DIN EN 60747-5-5 (pending), available with option 1
- CSA 93751

DESCRIPTION

The MCT5211 is an optocoupler with a high efficiency AlGaAs LED optically coupled to a NPN phototransistor. The high performance LED makes operation at low input currents practical. The coupler is housed in a six pin DIP package. Isolation test voltage is 5300 V_{RMS} .

Because these parts have guaranteed CTRs at 1 mA and 3 mA, they are ideally suitable for interfacing from CMOS to TTL or LSTTL to TTL. They are also ideal for telecommunications applications such as ring or off-hook detection.

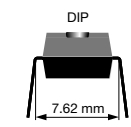
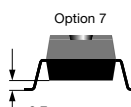
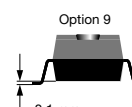
ORDERING INFORMATION	
<div style="display: flex; justify-content: space-around; align-items: center;"> <div style="text-align: center;"> <div style="border: 1px solid black; padding: 2px 5px; margin: 2px;">M</div> <div style="border: 1px solid black; padding: 2px 5px; margin: 2px;">C</div> <div style="border: 1px solid black; padding: 2px 5px; margin: 2px;">T</div> <div style="border: 1px solid black; padding: 2px 5px; margin: 2px;">5</div> <div style="border: 1px solid black; padding: 2px 5px; margin: 2px;">2</div> <div style="border: 1px solid black; padding: 2px 5px; margin: 2px;">1</div> <div style="border: 1px solid black; padding: 2px 5px; margin: 2px;">1</div> <div style="border: 1px solid black; padding: 2px 5px; margin: 2px;">-</div> <div style="border: 1px solid black; padding: 2px 5px; margin: 2px;">X</div> <div style="border: 1px solid black; padding: 2px 5px; margin: 2px;">0</div> <div style="border: 1px solid black; padding: 2px 5px; margin: 2px;">#</div> <div style="border: 1px solid black; padding: 2px 5px; margin: 2px;">#</div> <div style="border: 1px solid black; padding: 2px 5px; margin: 2px;">T</div> </div> <div style="margin-left: 20px;"> <p>PART NUMBER</p> <p>PACKAGE OPTION</p> <p>TAPE AND REEL</p> </div> <div style="margin-left: 20px;">    </div> </div>	
AGENCY CERTIFIED/PACKAGE	CTR (%)
	1 mA
UL, BSI, CSA	> 110
DIP-6	MCT5211
SMD-6, option 7	MCT5211-X007T ⁽¹⁾
SMD-6, option 9	MCT5211-X009T ⁽¹⁾
UL, BSI, CSA, VDE	> 110
SMD-6, option 7	MCT5211-X017T

Notes

- Additional options may be possible, please contact sales office
- ⁽¹⁾ Also available in tubes, do not put T on the end



ABSOLUTE MAXIMUM RATINGS ($T_{amb} = 25\text{ }^{\circ}\text{C}$, unless otherwise specified)				
PARAMETER	TEST CONDITION	SYMBOL	VALUE	UNIT
Input				
Peak reverse voltage		V_R	6	V
Forward continuous current		I_F	40	mA
Power dissipation		P_{diss}	75	mW
Derate linearly from 25 °C			1	mW/°C
Output				
Collector emitter breakdown voltage		BV_{CEO}	30	V
Emitter collector breakdown voltage		BV_{ECO}	7	V
Collector base breakdown voltage		BV_{CBO}	70	V
Power dissipation		P_{diss}	200	mW
Derate linearly from 25 °C			2.6	mW/°C
Coupler				
Total package dissipation (LED and detector)		P_{tot}	260	mW
Derate linearly from 25 °C			3.5	mW/°C
Operating temperature		T_{amb}	-55 to +100	°C
Storage temperature		T_{stg}	-55 to +150	°C

Note

- Stresses in excess of the absolute maximum ratings can cause permanent damage to the device. Functional operation of the device is not implied at these or any other conditions in excess of those given in the operational sections of this document. Exposure to absolute maximum ratings for extended periods of the time can adversely affect reliability

ELECTRICAL CHARACTERISTICS ($T_{amb} = 25\text{ }^{\circ}\text{C}$, unless otherwise specified)							
PARAMETER	TEST CONDITION	PART	SYMBOL	MIN.	TYP.	MAX.	UNIT
Input							
Forward voltage	$I_F = 5\text{ mA}$		V_F	-	1.2	1.5	V
Reverse voltage	$I_R = 10\text{ }\mu\text{A}$		V_R	6	-	-	V
Output							
DC forward current gain	$V_{CE} = 5\text{ V}, I_C = 100\text{ }\mu\text{A}$		h_{FE}	100	200	-	
Collector emitter breakdown voltage	$I_C = 100\text{ }\mu\text{A}$		BV_{CEO}	30	-	-	V
Emitter collector breakdown voltage	$I_E = 100\text{ }\mu\text{A}$		BV_{ECO}	7	-	-	V
Collector base breakdown voltage	$I_E = 10\text{ }\mu\text{A}$		BV_{CBO}	70	-	-	V
Collector emitter leakage voltage	$V_{CE} = 10\text{ V}$		I_{CEO}	-	5	100	nA
Coupler							
Saturation voltage	$I_F = 1.6\text{ mA}, I_C = 1.6\text{ mA}$	MCT5211	V_{CEsat}	-	0.25	0.4	V

Note

- Minimum and maximum values are testing requirements. Typical values are characteristics of the device and are the result of engineering evaluation. Typical values are for information only and are not part of the testing requirements

CURRENT TRANSFER RATIO ($T_{amb} = 25\text{ }^{\circ}\text{C}$, unless otherwise specified)							
PARAMETER	TEST CONDITION	PART	SYMBOL	MIN.	TYP.	MAX.	UNIT
Current transfer ratio (collector emitter saturated)	$V_{CE} = 0.4\text{ V}, I_F = 1.6\text{ mA}$	MCT5211	CTR_{CEsat}	100	200	-	%
	$V_{CE} = 0.4\text{ V}, I_F = 1\text{ mA}$	MCT5211	CTR_{CEsat}	75	150	-	%
Current transfer ratio	$V_{CE} = 5\text{ V}, I_F = 1.6\text{ mA}$	MCT5211	CTR	150	300	-	%
	$V_{CE} = 5\text{ V}, I_F = 1\text{ mA}$	MCT5211	CTR	110	225	-	%
Current transfer ratio (collector base)	$V_{CE} = 4.3\text{ V}, I_F = 1.6\text{ mA}$	MCT5211	CTR_{CB}	0.3	0.6	-	%
	$V_{CE} = 4.3\text{ V}, I_F = 1\text{ mA}$	MCT5211	CTR_{CB}	0.25	0.5	-	%



SWITCHING CHARACTERISTICS ($T_{amb} = 25\text{ }^{\circ}\text{C}$, unless otherwise specified)							
PARAMETER	TEST CONDITION	PART	SYMBOL	MIN.	TYP.	MAX.	UNIT
Propagation delay high to low	$R_L = 750\ \Omega$, $I_F = 1.6\ \text{mA}$, $V_{CC} = 5\ \text{V}$	MCT5211	t_{PHL}	-	20	-	μs
	$R_L = 1.5\ \text{k}\Omega$, $I_F = 1\ \text{mA}$, $V_{CC} = 5\ \text{V}$	MCT5211	t_{PHL}	-	40	-	μs
Propagation delay low to high	$R_L = 750\ \Omega$, $I_F = 1.6\ \text{mA}$, $V_{CC} = 5\ \text{V}$	MCT5211	t_{PLH}	-	20	-	μs
	$R_L = 1.5\ \text{k}\Omega$, $I_F = 1\ \text{mA}$, $V_{CC} = 5\ \text{V}$	MCT5211	t_{PLH}	-	40	-	μs

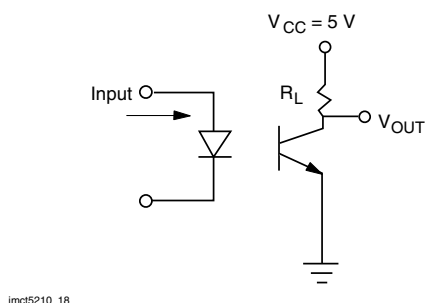

imct5210_18

Fig. 1 - Switching Schematic

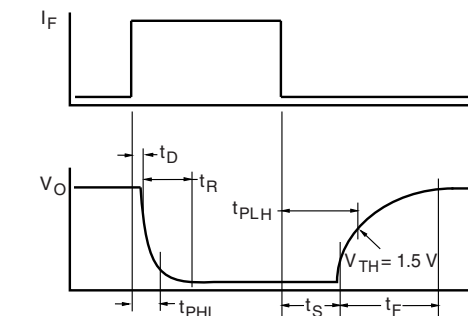

imct5210_03

Fig. 2 - Switching Waveform

SAFETY AND INSULATION RATINGS				
PARAMETER	TEST CONDITION	SYMBOL	VALUE	UNIT
Climatic classification	According to IEC 68 part 1		55 / 100 / 21	
Comparative tracking index		CTI	175	
Maximum rated withstanding isolation voltage	$t = 1\ \text{min}$	V_{ISO}	4420	V_{RMS}
Maximum transient isolation voltage		V_{IOTM}	10 000	V
Maximum repetitive peak isolation voltage		V_{IORM}	890	V
Isolation resistance	$V_{IO} = 500\ \text{V}$, $T_{amb} = 25\text{ }^{\circ}\text{C}$	R_{IO}	$\geq 10^{12}$	Ω
	$V_{IO} = 500\ \text{V}$, $T_{amb} = 100\text{ }^{\circ}\text{C}$	R_{IO}	$\geq 10^{11}$	Ω
Output safety power		P_{SO}	400	mW
Input safety current		I_{SI}	275	mA
Input safety temperature		T_{SI}	175	$^{\circ}\text{C}$
Creepage distance			≥ 7	mm
Clearance distance			≥ 7	mm
Insulation thickness		DTI	≥ 0.4	mm

Note

- As per IEC 60747-5-5, § 7.4.3.8.2, this optocoupler is suitable for "safe electrical insulation" only within the safety ratings. Compliance with the safety ratings shall be ensured by means of protective circuits



TYPICAL CHARACTERISTICS ($T_{amb} = 25\text{ }^{\circ}\text{C}$, unless otherwise specified)

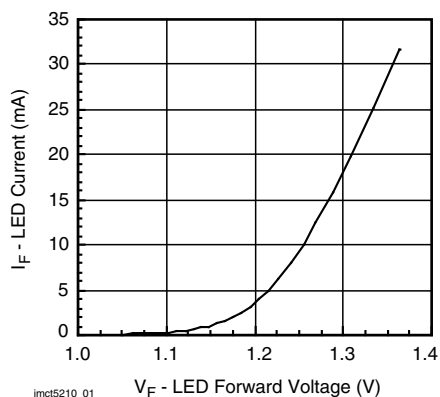

Fig. 1 Forward Current vs. Forward Voltage

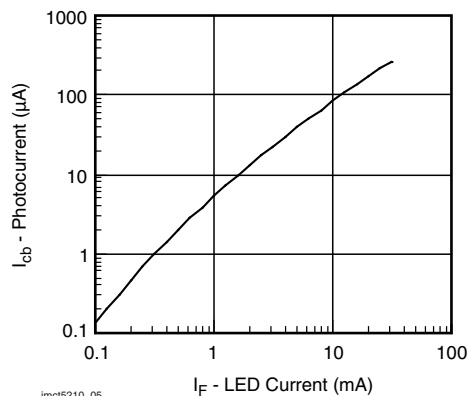

Fig. 5 - Photocurrent vs. LED Current

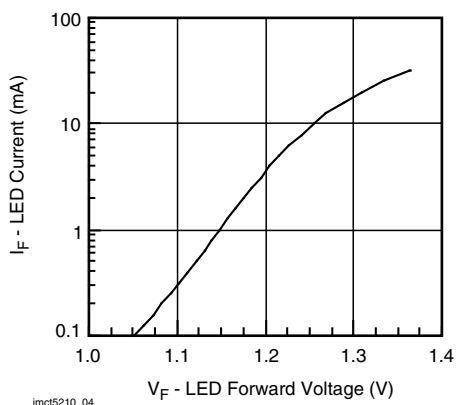

Fig. 3 - LED Forward Current vs. Forward Voltage

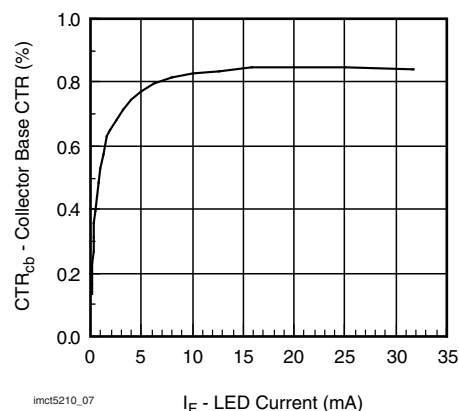

Fig. 6 - Collector Base CTR vs. LED Current

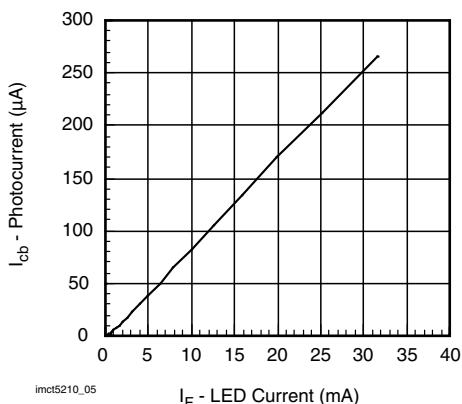

Fig. 4 - Collector Base Photocurrent vs. LED Current

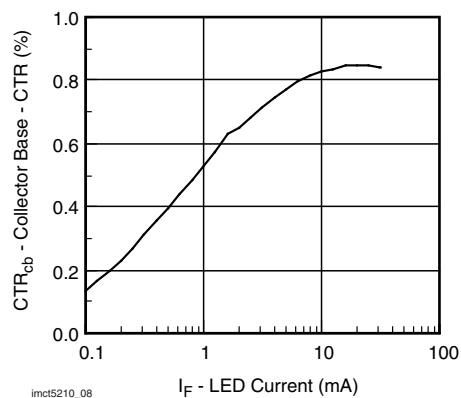

Fig. 7 - Collector Base CTR vs. LED Current

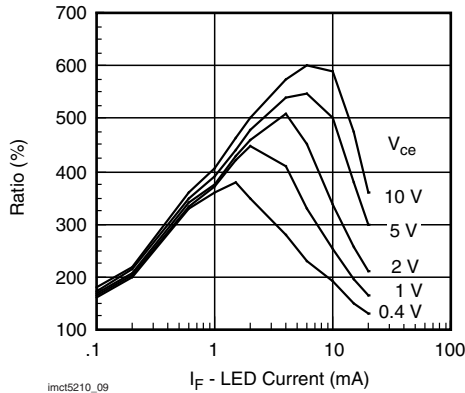

Fig. 8 - CTR vs. LED Current

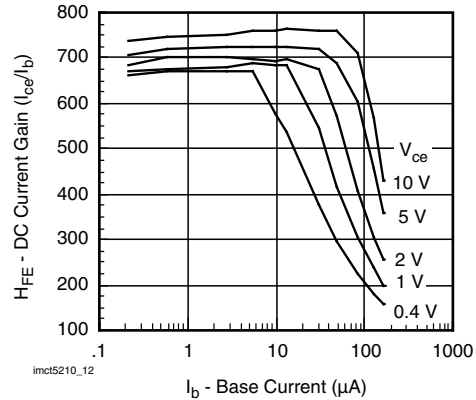

Fig. 11 - Transistor Current Gain vs. Base Current

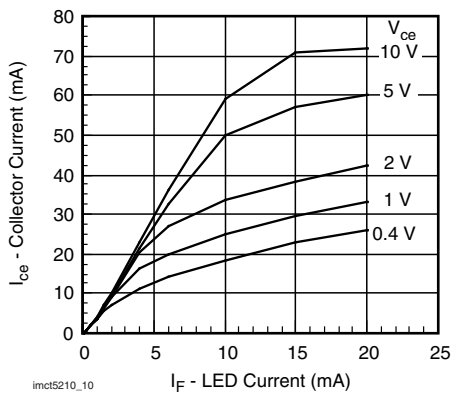

Fig. 9 - Collector Current vs. LED Current

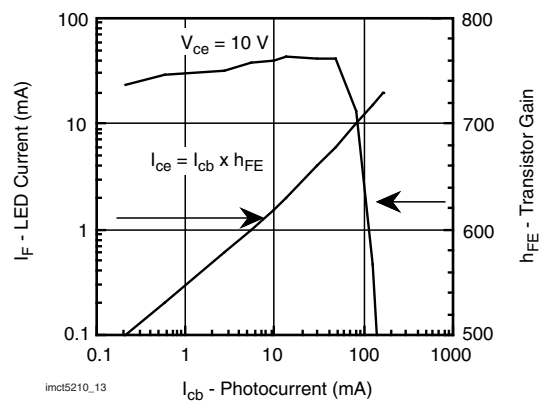

Fig. 12 - Transfer Curve

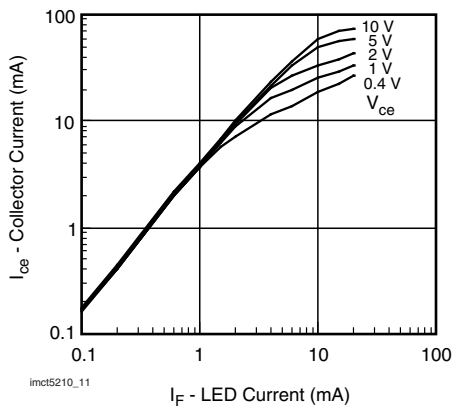

Fig. 10 - Collector Current vs. LED Current

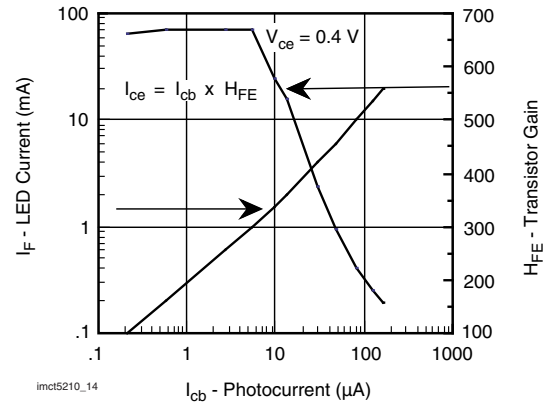

Fig. 13 - Transfer Curve

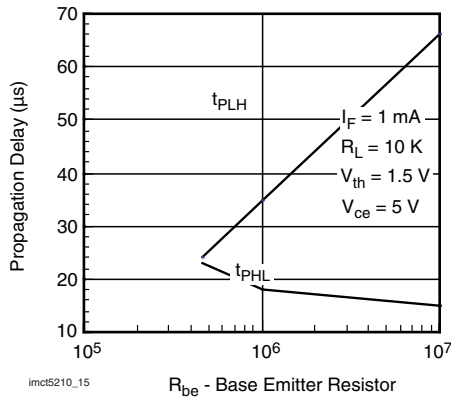

Fig. 14 - Propagation Delay vs. Base Emitter Resistor

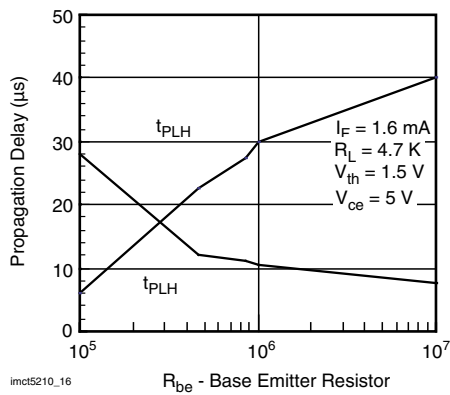

Fig. 15 - Propagation Delay vs. Base Emitter Resistor

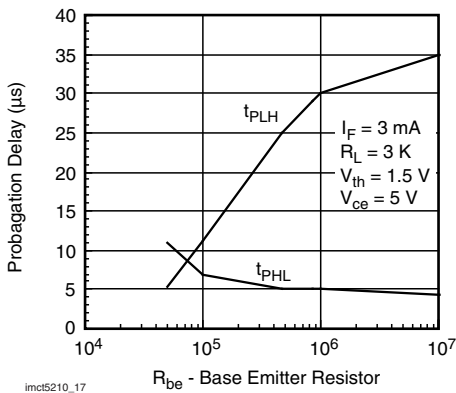
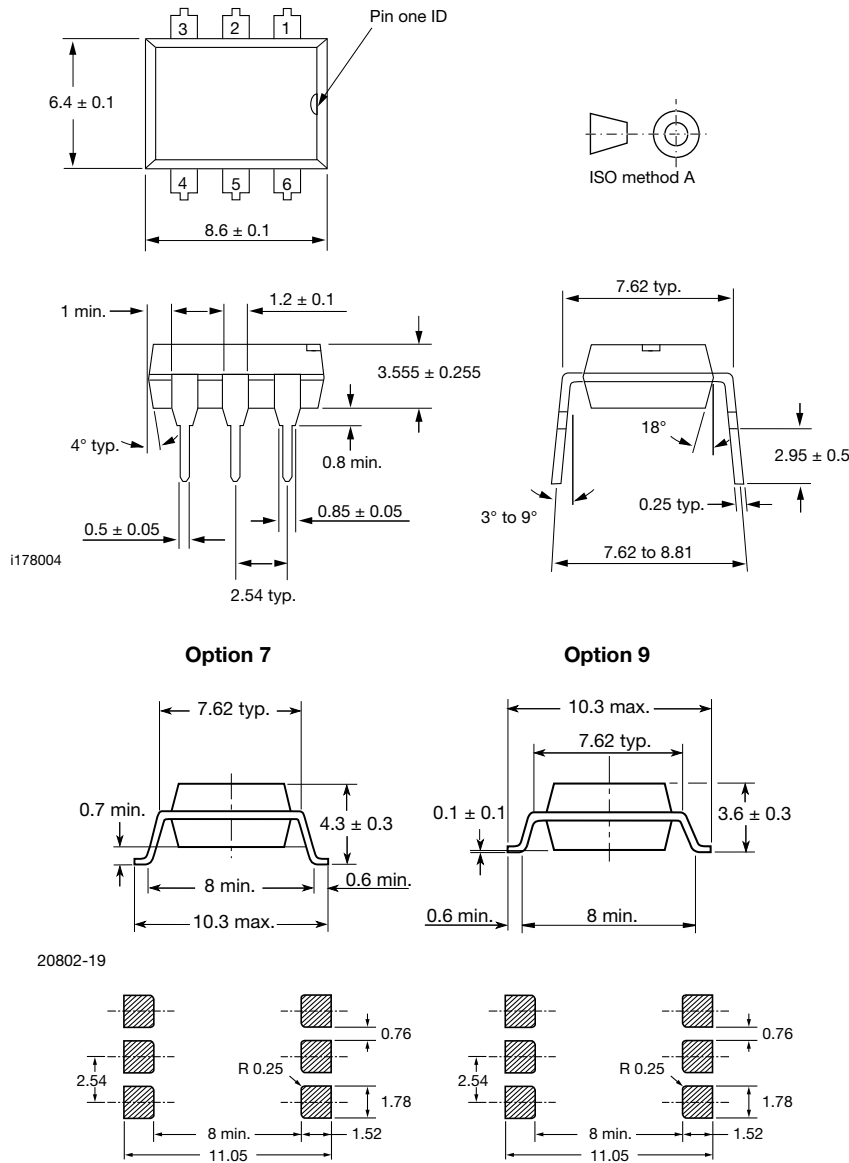

Fig. 16 - Propagation Delay vs. Base Emitter Resistor



PACKAGE DIMENSIONS in millimeters



PACKAGE MARKING (example)

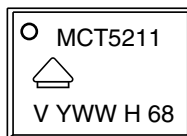

Notes

- Only option 7 is reflected in the package marking
- The VDE logo is only marked on option 1 parts
- Tape and reel suffix (T) is not part of the package marking

DIP-6A

PACKAGE DIMENSIONS in inches (millimeters)

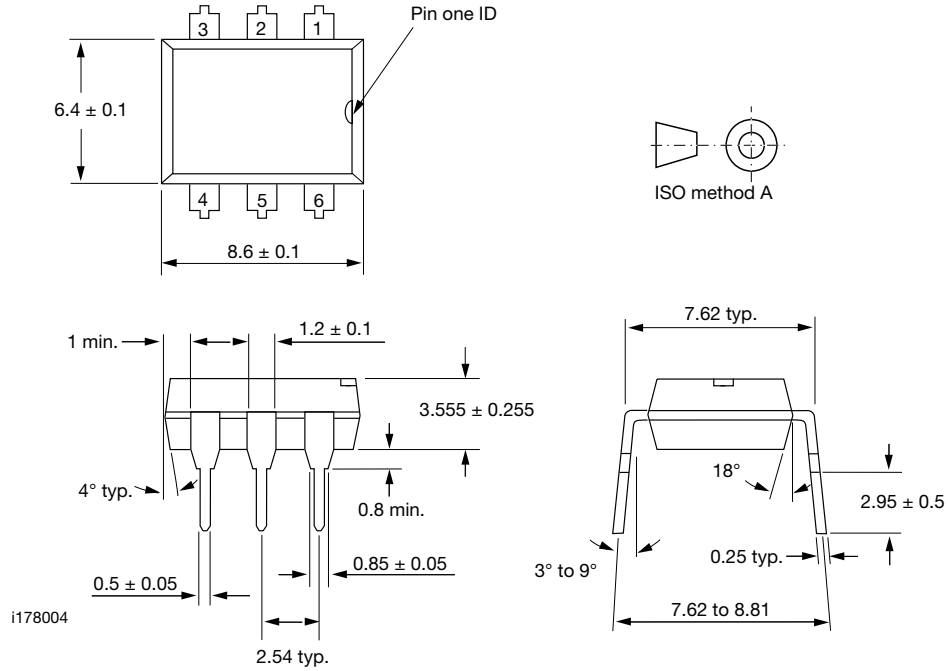

Note

The information in this document provides generic information but for specific information on a product the appropriate product datasheet should be used.



Disclaimer

ALL PRODUCT, PRODUCT SPECIFICATIONS AND DATA ARE SUBJECT TO CHANGE WITHOUT NOTICE TO IMPROVE RELIABILITY, FUNCTION OR DESIGN OR OTHERWISE.

Vishay Intertechnology, Inc., its affiliates, agents, and employees, and all persons acting on its or their behalf (collectively, "Vishay"), disclaim any and all liability for any errors, inaccuracies or incompleteness contained in any datasheet or in any other disclosure relating to any product.

Vishay makes no warranty, representation or guarantee regarding the suitability of the products for any particular purpose or the continuing production of any product. To the maximum extent permitted by applicable law, Vishay disclaims (i) any and all liability arising out of the application or use of any product, (ii) any and all liability, including without limitation special, consequential or incidental damages, and (iii) any and all implied warranties, including warranties of fitness for particular purpose, non-infringement and merchantability.

Statements regarding the suitability of products for certain types of applications are based on Vishay's knowledge of typical requirements that are often placed on Vishay products in generic applications. Such statements are not binding statements about the suitability of products for a particular application. It is the customer's responsibility to validate that a particular product with the properties described in the product specification is suitable for use in a particular application. Parameters provided in datasheets and / or specifications may vary in different applications and performance may vary over time. All operating parameters, including typical parameters, must be validated for each customer application by the customer's technical experts. Product specifications do not expand or otherwise modify Vishay's terms and conditions of purchase, including but not limited to the warranty expressed therein.

Except as expressly indicated in writing, Vishay products are not designed for use in medical, life-saving, or life-sustaining applications or for any other application in which the failure of the Vishay product could result in personal injury or death. Customers using or selling Vishay products not expressly indicated for use in such applications do so at their own risk. Please contact authorized Vishay personnel to obtain written terms and conditions regarding products designed for such applications.

No license, express or implied, by estoppel or otherwise, to any intellectual property rights is granted by this document or by any conduct of Vishay. Product names and markings noted herein may be trademarks of their respective owners.