



12.5 mm Modular Panel Potentiometer Cermet (P11S) or Conductive Plastic Elements (P11A)



FEATURES

- 12.5 mm square single turn panel control
- Five shaft diameters and 29 terminal styles
- Multiple assemblies - up to seven modules
- Tests according to CECC 41000 or IEC 60393-1
- GAM T1
- P11S version for industrial, military, and aeronautics applications
- P11A version for professional audio applications
- Low current compatibility
- Shaft and panel sealed version
- Up to twenty-one indent positions
- Rotary and push/push switch options
- Concentric shafts
- Custom designs on request
- Trimmer version T11 (see document no. 51021)
- Material categorization: For definitions of compliance please see www.vishay.com/doc?99912



RoHS COMPLIANT

VERSATILE	MODULAR	COMPACT	ROBUST
-----------	---------	---------	--------

CONFIGURATION EXAMPLE - Dimensions in millimeters (inches) ± 0.5 mm (± 0.02")

Single module, single shaft, solder lugs, metric bushing and shaft



Single module, single shaft, vertical mounting, PC pins with support plate, metric bushing and shaft



Dual modules, single shaft, PC pins with front support plates, imperial bushing and shaft





GENERAL SPECIFICATIONS

ELECTRICAL (initial)		
	P11A	P11S
Resistive Element	Conductive plastic	Cermet
Electrical Travel	270° ± 10°	270° ± 10°
Resistance Range (1)	Linear Taper	1 kΩ to 1 MΩ
	Non-Linear Taper	470 Ω to 500 kΩ
Tolerance	Standard	± 20 %
	On Request	-
Taper		
Circuit Diagram		
Power Rating at 70 °C	Linear Taper	0.5 W at + 70 °C
	Non-Linear Taper	0.25 W at + 70 °C
	Multiple Assemblies	0.25 W at + 70 °C per module
		0.5 W at + 70 °C per module
Temperature Coefficient (Typical)	± 500 ppm	± 150 ppm
Limiting Element Voltage	350 V	350 V
End Resistance (Typical)	2 Ω	2 Ω
Contact Resistance Variation (Typical)	Linear Taper	1 %
		2 % or 3 Ω
Independent Linearity (Typical)	Linear Taper	± 5 %
Insulation Resistance	10 ⁶ MΩ min.	10 ⁶ MΩ min.
Dielectric Strength	1500 V _{RMS} min.	1500 V _{RMS} min.
Attenuation	90 dB max./0.05 dB min.	-
Mechanical Endurance	50 000 cycles	50 000 cycles

Note

(1) Consult Vishay Sfernice for other ohmic values



MECHANICAL (initial)	
Mechanical Travel	300° ± 5°
Operating Torque (Typical) Single and Dual Assemblies Three to Seven Modules (Per Module)	0.4 Ncm to 1.8 Ncm max. (0.57 oz.-inch to 2.55 oz.-inch max.) 0.2 Ncm to 0.3 Ncm max. (0.28 oz.-inch to 0.42 oz.-inch max.)
End Stop Torque (All Bushing Except G and Concentric Shaft Configuration) 3 mm, 4 mm, and 1/8" Dia. Shafts 6 mm and 1/4" Dia. Shafts	35 Ncm max. (2.9 lb-inch max.) 80 Ncm max. (6.8 lb-inch max.)
End Stop Torque for Bushing G All Shafts Dia.	40 Ncm max. (3.4 lb-inch max.)
End Stop Torque for Concentric Shaft Configuration 3 mm and 1/8" Dia. Shafts 6 mm and 1/4" Dia. Shafts	25 Ncm max. (2.1 lb-inch max.) 80 Ncm max. (6.8 lb-inch max.)
Tightening Torque 6 mm, 7 mm, and 1/4" Dia. Bushings 10 mm and 3/8" Dia. Bushings	150 Ncm max. (13 lb-inch max.) 250 Ncm max. (21 lb-inch max.)
Weight	7 g to 9 g per module (0.25 oz. to 0.32 oz.)

ENVIRONMENTAL		
	P11A	P11S
Operating Temperature Range	- 55 °C to + 125 °C	- 55 °C to + 125 °C
Climatic Category	55/125/21	55/125/56
Sealing	IP64	IP64

MARKING
<ul style="list-style-type: none"> • Potentiometer Module Vishay logo, nominal ohmic value (Ω, kΩ, MΩ), two stars identify P11A version, tolerance in % - variation law, manufacturing date (four digits), "3" for the lead 3 • Switch Module Version, manufacturing date (four digits), "c" for common lead • Indent Module Version, manufacturing date (four digits)

PACKAGING
<ul style="list-style-type: none"> • Box

PERFORMANCES				
TESTS	CONDITIONS	TYPICAL VALUE AND DRIFTS		
			P11S	P11A
Electrical Endurance	1000 h at rated power 90'/30' - ambient temp. 70 °C	$\Delta R_T/R_T$ Contact resistance variation	± 2 % ± 4 %	± 10 % ± 5 %
Change of Temperature	- 55 °C to + 125 °C, 5 cycles	$\Delta R_T/R_T$	± 0.2 %	± 0.5 %
Damp Heat, Steady State	+ 40 °C, 93 % relative humidity P11S: 56 days, P11A: 21 days	$\Delta R_T/R_T$ Insulation resistance	± 2 % > 1000 M Ω	± 5 % > 10 M Ω
Mechanical Endurance	50 000 cycles	$\Delta R_T/R_T$ Contact resistance variation	± 5 % ± 5 %	± 6 % ± 4 %
Climatic Sequence	Dry heat at + 125 °C/damp heat cold - 55 °C/damp heat, 5 cycles	$\Delta R_T/R_T$	± 1 %	-
Shock	50 g's, 11 ms 3 shocks - 3 directions	$\Delta R_T/R_T$ $\Delta R_{1-2}/R_{1-2}$	± 0.2 % ± 0.5 %	± 0.2 % ± 0.5 %
Vibration	10 Hz to 55 Hz 0.75 mm or 10 g's, 6 h	$\Delta R_T/R_T$ $\Delta V_{1-2}/V_{1-3}$	± 0.2 % ± 0.5 %	± 0.2 % ± 0.5 %



ORDERING INFORMATION (part number)																	
P	1	1	S	2	Q	0	E	A	S	Y	0	0	1	0	3	M	A
MODEL	STYLE			NUMBER OF MODULES	BUSHING	LOCATING PEG	SHAFT	SHAFT STYLE	LEADS	RESISTANCE CODE/TOLERANCE/TAPER OR SPECIAL							
P11	S = Cermet element A = Conductive plastic (audio)			1 2 3 4 5 6 7													

STANDARD RESISTANCE ELEMENT DATA												
STANDARD RESISTANCE VALUES	P11S CERMET						P11A CONDUCTIVE PLASTIC					
	LINEAR TAPER			NON-LINEAR TAPER			LINEAR TAPER			NON-LINEAR TAPER		
	MAX. POWER AT 70 °C	MAX. WORKING VOLTAGE	MAX. CUR. THROUGH WIPER	MAX. POWER AT 70 °C	MAX. WORKING VOLTAGE	MAX. CUR. THROUGH WIPER	MAX. POWER AT 70 °C	MAX. WORKING VOLTAGE	MAX. CUR. THROUGH WIPER	MAX. POWER AT 70 °C	MAX. WORKING VOLTAGE	MAX. CUR. THROUGH WIPER
Ω	W	V	mA	W	V	mA	W	V	mA	W	V	mA
22	1	4.69	213									
47	1	6.86	146									
50	1	7.07	141									
100	1	10.0	100	0.5	7.07	70.7						
220	1	14.8	67.4	0.5	10.5	47.7						
470	1	21.7	46.1	0.5	15.3	32.6						
500	1	22.4	44.7	0.5	15.8	31.6				0.25	11.2	22.4
1K	1	31.6	31.6	0.5	22.4	22.4	0.5	22.4	22.4	0.25	15.8	15.8
2.2K	1	46.9	21.3	0.5	33.2	15.1	0.5	33.2	15.1	0.25	23.5	10.7
4.7K	1	63.6	14.5	0.5	48.5	10.3	0.5	48.5	10.3	0.25	34.3	7.29
5K	1	70.7	14.1	0.5	50.0	10.0	0.5	50.0	10.0	0.25	35.4	7.07
10K	1	100	10.0	0.5	70.7	7.07	0.5	70.7	7.07	0.25	50.0	5.00
22K	1	148	6.74	0.5	105	4.77	0.5	105	4.77	0.25	74.2	3.37
47K	1	217	4.61	0.5	153	3.26	0.5	153	3.26	0.25	108	2.31
50K	1	224	4.47	0.5	158	3.16	0.5	158	3.16	0.25	112	2.24
100K	1	316	3.16	0.5	224	2.24	0.5	224	2.24	0.25	158	1.58
220K	0.56	350	1.59	0.5	332	1.51	0.5	332	1.51	0.25	235	1.07
470K	0.26	350	0.75	0.26	349	0.74	0.26	350	0.74	0.25	343	0.73
500K	0.25	350	0.70	0.25	350	0.70	0.25	350	0.70	0.25	350	0.70
1M	0.12	350	0.35	0.12	350	0.35	0.12	350	0.35			
2.2M	0.56	350	0.16	0.056	350	0.16						
4.7M	0.26	350	0.074									
5M	0.25	350	0.070									
10M	0.12	350	0.035									

ORDERING INFORMATION (part number)																																																																	
P	1	1	S	2	Q	0	E	A	S	Y	0	0	1	0	3	M	A																																																
MODEL	STYLE	NUMBER OF MODULES	BUSHING				LOCATING PEG	SHAFT	SHAFT STYLE	LEADS	RESISTANCE CODE/TOLERANCE/TAPER OR SPECIAL																																																						
P11			<table border="1"> <thead> <tr> <th></th><th>Ø</th><th>L</th><th>Old Codes</th></tr> </thead> <tbody> <tr><td>A</td><td>1/4"</td><td>1/4"</td><td>7, 77, 77-3</td></tr> <tr><td>B</td><td>1/4"</td><td>3/8"</td><td>71</td></tr> <tr><td>C</td><td>1/4"</td><td>1/2"</td><td>72</td></tr> <tr><td>D</td><td>1/4"</td><td>3/8"</td><td>71H</td></tr> <tr><td>E</td><td>1/4"</td><td>1/2"</td><td>72H</td></tr> <tr><td>F</td><td>3/8"</td><td>3/8"</td><td>2, 03, 0-</td></tr> <tr><td>G</td><td>8</td><td>8</td><td>TP, QP, VP, 2P, 7P</td></tr> <tr><td>Q</td><td>7</td><td>8</td><td>Q</td></tr> <tr><td>T</td><td>6</td><td>8</td><td>T</td></tr> <tr><td>V</td><td>10</td><td>9.5</td><td>V, CC, CC-3</td></tr> </tbody> </table>					Ø	L	Old Codes	A	1/4"	1/4"	7, 77, 77-3	B	1/4"	3/8"	71	C	1/4"	1/2"	72	D	1/4"	3/8"	71H	E	1/4"	1/2"	72H	F	3/8"	3/8"	2, 03, 0-	G	8	8	TP, QP, VP, 2P, 7P	Q	7	8	Q	T	6	8	T	V	10	9.5	V, CC, CC-3															
	Ø	L	Old Codes																																																														
A	1/4"	1/4"	7, 77, 77-3																																																														
B	1/4"	3/8"	71																																																														
C	1/4"	1/2"	72																																																														
D	1/4"	3/8"	71H																																																														
E	1/4"	1/2"	72H																																																														
F	3/8"	3/8"	2, 03, 0-																																																														
G	8	8	TP, QP, VP, 2P, 7P																																																														
Q	7	8	Q																																																														
T	6	8	T																																																														
V	10	9.5	V, CC, CC-3																																																														



BUSHINGS		Ø	G	T	Q	V	A	B	C	D	E	F		
			DIMENSIONS mm (± 0.5)						DIMENSIONS INCHES (± 0.02)					
A	Shafts	Ø	All Dia.	3	4	6	1/8"	1/8"	1/8"	1/8"	1/8"	1/4"		
B	Bushing	Ø	8	6	7	10	1/4"	1/4"	1/4"	1/4"	1/4"	3/8"		
C		L	8	8	8	9.5	1/4"	3/8"	1/2"	3/8"	1/2"	3/8"		
J	Lead versions X.. Y..		6.7	5	5	7	0.200	0.200	0.200	0.200	0.200	0.278		
K			10.4	9.1	9.1	11.1	0.357	0.357	0.357	0.357	0.357	0.436		
G	Panel		7.2	5.2	6.2	8.2	0.197	0.197	0.197	0.197	0.197	0.323		
H	Cutout	Ø	8.5	6.5	7.5	10.5	0.268	0.268	0.268	0.268	0.268	0.394		
	Thread		0.75						32 threads/inch					
	Wrench nut		12	8	10	12	0.313	0.313	0.313	0.313	0.313	0.500		
	Style									Slotted	Slotted			

- Notes**
- Hardware supplied in separate bags
 - Slotted bushing for locking nut option

ORDERING INFORMATION (part number)

P	1	1	S	2	Q	0	E	A	S	Y	0	0	1	0	3	M	A
MODEL	STYLE	NUMBER OF MODULES	BUSHING	LOCATING PEG		SHAFT	SHAFT STYLE	LEADS	RESISTANCE CODE/TOLERANCE/TAPER OR SPECIAL								
				Old Codes A = B24 B = B30 C = B53 0 = Without peg													

LOCATING PEGS (anti-rotation lug)

The locating peg is provided by a plate mounted on the bushing and positioned by the module sides. Four set positions are available, clock face orientation: 12, 3, 6, 9.

All P11 bushings have a double flat. When panel mounting holes have been punched accordingly, an anti-rotation lug is not necessary.

CODE	VERSION	BUSHING A, B, C, D, E, T, Q	BUSHING F, V	EFFECTIVE HIGH PEG
A	Ø d mm	2	2	0.7
	L mm	6.2	6.2	
B	Ø d mm	2	2	0.7
	L mm	7.75	7.75	
C	Ø d mm	-	3.5	1.1
	L mm	-	13.5	

Locating pegs are supplied in separate bags with nuts and washers

ORDERING INFORMATION (part number)																	
P	1	1	S	2	Q	0	E	A	S	Y	0	0	1	0	3	M	A
MODEL	STYLE	NUMBER OF MODULES	BUSHING	LOCATING PEG	SHAFT						SHAFT STYLE	LEADS	RESISTANCE CODE/TOLERANCE/TAPER OR SPECIAL				
						∅	L	Old Codes									
						AA	3	9.5	K								
						AB	3	12.5	M								
						AJ	3	22	R								
						AP = Custom shaft											
						BA	1/8"	3/8"	CK								
						BB	1/8"	1/2"	CM								
						BG	1/8"	5/8"	CDM								
						BG	1/8"	5/8"	CD								
						BH	1/8"	3/4"	CH								
						BJ	1/8"	7/8"	CR								
						CC = Concentric shaft											
						EA	4	9.5	E								
						EB	4	12.5	F								
						EJ	4	22	G								
						FG	6	16	D								
						FH	6	19	I								
						FL	6	25	N								
						FR	6	50	S								
						GG	1/4"	5/8"	VD								
						GH	1/4"	3/4"	VHM, VH								
						GJ	1/4"	7/8"	VR								
						GL	1/4"	1"	VN								
						GO	1/4"	1.5"	VL								

S = Slotted
 R = Round
 F = Flatted
 K = Knurled/splined
 D = Custom

SHAFTS in millimeters ± 0.5

The shaft length is always measured from the mounting face. Standard shafts are designed by a 3 letters code (3 digits). Shafts slots are aligned to ± 10° of the wiper position. All standard shafts are slotted except flatted and splined, see exceptions for bushing.

BUSHING: Q
SPLINED SHAFT: FHK

FLATTED SHAFT

Bushing: F
 Shaft: GHF

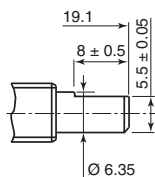

Bushing: A
 Shaft: BGF

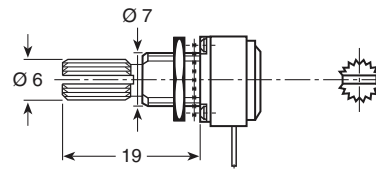
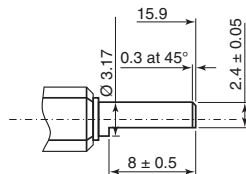

CUSTOM SHAFTS

When special shafts are required - flat, threaded ends, special shaft lengths, etc. a drawing is required.

STANDARD COMBINATION OF SHAFT STYLES AND BUSHINGS

SHAFT DIA.	BUSHING CODE	SHAFT LENGTH AND STYLE AVAILABLE IN STANDARD (others on request)					
		AAS	ABS	AJS	BGS	BHS	BJS
3	T						
3.17	A	BAS	BBS	BGS	BGF	BHS	BJS
3.17	B	BBS	BGS	BHS	BJS		
3.17	C	BGS	BHS	BJS			
4	Q	EAS	EBS	EJS	FHK		
6	V	FGS	FLS	FRS			
6.35	F	GGs	GHS	GJS	GLS	GOS	GHF

ORDERING INFORMATION (part number)																	
P	1	1	S	2	Q	0	E	A	S	Y	0	0	1	0	3	M	A
MODEL	STYLE	NUMBER OF MODULES	BUSHING	LOCATING PEG	SHAFT	SHAFT STYLE	LEADS					RESISTANCE CODE/TOLERANCE/TAPER OR SPECIAL					
							Available leads										
							A00	W00	X00	Y00	Z00						
							A10	W10	X03	Y03	Z03						
							A13	W20	X04	Y04	Z04						
							A14		X10		Z10						
							A20		X13		Z13						
							A23		X14		Z14						
							A24		X20		Z20						
									X23		Z23						
									X24		Z24						

FIRST DIGIT		SECOND DIGIT		THIRD DIGIT	
Y	Soldering lugs	0	Y = 4.65 (0.183") A, X, Z, W = 5.08 (0.200") pin spacing pins section 0.9 x 0.3 (0.035" x 0.012")	0	5.08 (0.200") space between modules
X	PCB pins	1	2.54 (0.100") pin spacing pin section 0.6 x 0.3 (0.024" x 0.012")	3	7.62 (0.300") space between modules
Z	PCB pins with front support plate	2	5.08 (0.200") pin spacing pins section 0.6 x 0.3 (0.024" x 0.012")	4	10.16 (0.400") space between modules
A	PCB pins with front and back support plates				
W	PCB pins - vertical mounting with 2 extra pins - 1 module only				

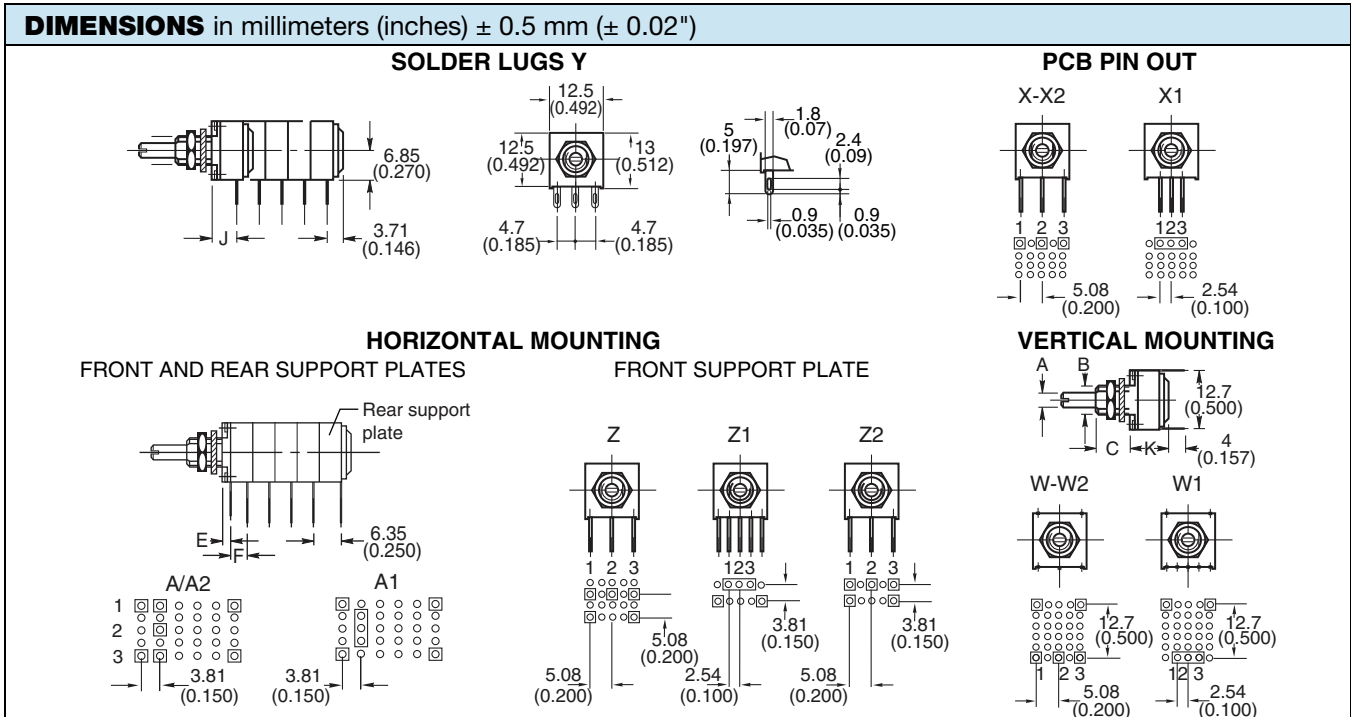

THE POSITION OF EACH MODULE IS FREE

BUSHINGS		G	T	Q	V	A	B	C	D	E	F	
		DIMENSIONS mm (± 0.5)					DIMENSIONS INCHES (± 0.02)					
E	Leads Z00	3.15	1.85	1.85	3.85	0.071	0.071	0.071	0.071	0.071	0.150	
E	Leads Z1. Z2. A..	2.8	1.6	1.6	3.6	0.063	0.063	0.063	0.063	0.063	0.140	
F		Leads Z0.: 5.08 (0.200")					Leads A.. Z1. Z2.: 3.81 (0.150")					
J	Leads X.. Y..	6.7	5	5	7	0.200	0.200	0.200	0.200	0.200	0.278	
E	Leads Z0. with Rotary Switch	1.45	0.15	0.15	2.15	0.006	0.006	0.006	0.006	0.006	0.0846	



ORDERING INFORMATION (part number)																	
P	1	1	S	2	Q	0	E	A	S	Y	0	0	1	0	3	M	A
MODEL	STYLE	NUMBER OF MODULES	BUSHING	LOCATING PEG	SHAFT	SHAFT STYLE	LEADS	RESISTANCE CODE/ TOLERANCE/ TAPER OR SPECIAL									
								From 20 Ω to 10 MΩ see instructions on electrical specifications Resistance code: 200 = 20 Ω to 106 = 10 MΩ Tolerance code: Standard: M = ± 20 % On request: K = ± 10 %, J = ± 5 % (cermet only) Taper: A, L, W, F, S, R or special code given by Vishay									

SPECIAL CODES GIVEN BY VISHAY
Option available: <ul style="list-style-type: none"> • Custom shaft • Custom design on request • Specific linearity • Specific interlinearity • Specific taper • Multiple assemblies with various modules

P11 OPTION: ROTARY SWITCH MODULES

- Rotary switches
- Current up to 2 A
- Actuation CW or CCW position
- Sealing IP60

**MODULES: RS ON/OFF SWITCH
RSI CHANGEOVER SWITCH**

The position of each module is free.

RS and RSI rotary switches are housed in a standard P11 module size 12.7 mm x 12.7 mm x 5.08 mm (0.5" x 0.5" x 0.2"). They have the same terminal styles as the assembled electrical modules.

An assembly can comprise 1 or more switch modules.

Switch actuation is described as seen from the shaft end.

D: Means actuation in maximum CCW position

F: Means actuation in maximum CW position

The switch actuation travel is 25° with a total mechanical travel of 300° ± 5° and electrical travel of electrical modules is 238° ± 10°.

Leads finish: Gold plated

RDS SINGLE POLE SWITCH, NORMALLY OPEN

In full CCW position, the contact between 1 and 3 is open. It is made at the beginning of the travel in CW direction.

RSF SINGLE POLE SWITCH, NORMALLY OPEN

In full CW position, the contact between 1 and 3 is open. It is made at the beginning of the travel in CCW direction.

RSID SINGLE POLE CHANGEOVER

In full CCW position, the contact is made between 3 and 2 and open between 3 and 1. Switch actuation (CW direction) reverses these positions.

RSIF SINGLE POLE CHANGEOVER

In full CW position, the contact is made between 1 and 2 and open between 1 and 3. Switch actuation (CCW direction) reverses these positions.

SWITCH SPECIFICATIONS

Switching Power Maximum	62.5 VA v 15 VA =	
Switching Current Maximum	0.25 A 250 V v 0.5 A 30 V =	
Maximum Current Through Element	2 A	
Contact Resistance	100 mΩ	
Dielectric Strength	Terminal to Terminal	1000 V _{RMS}
	Terminal to Bushing	2000 V _{RMS}
Maximum Voltage Operation	250 V v 30 V =	
Insulation Resistance Between Contacts	10 ⁶ MΩ	
Life at P _{max.}	10 000 actuations	
Minimal Travel	25°	
Operating Temperature	- 40 °C to + 85 °C	

ELECTRICAL DIAGRAM

Note

(1) Common

ORDERING INFORMATION (First order only)

RSID

RSD	SPST: Single pole, open switch in CCW position - 2 pins
RSF	SPST: Single pole, open switch in CW position - 2 pins
RSID	SPDT: Single pole, changeover switch in CCW position - 3 pins
RSIF	SPDT: Single pole, changeover switch in CW position - 3 pins

P11 OPTION: PUSH/PUSH OR MOMENTARY/PUSH SWITCH MODULES

- Push/push or momentary push
- Current up to 2 A
- Sealing IP60

**MODULES: PUSH/PUSH SWITCH RSPP
MOMENTARY/PUSH SWITCH RSMP**

They have to be the last element of potentiometer

Options:

- 2 reversing switches F2 4 reversing switches F4
- 6 reversing switches F6 8 reversing switches F8

Not available with panel sealed option.

Number of modules before the switch limited to 3 modules.

Length of shaft (FMF) 25 mm maximum.

RSPP F2: PUSH/PUSH SWITCH WITH TWO REVERSING SWITCHES

Idle position: The contact is made between 1 and 2 and a and b. It is open between 2 and 3 and b and c.

Pushed position: The contact is made between 2 and 3 and b and c. It is open between 1 and 2 and a and b.

SWITCH SPECIFICATIONS

Switching Power Maximum		50 VA v
Switching Current Maximum		0.5 A v
Maximum Current Through Element		2 A
Contact Resistance		100 mΩ
Dielectric Strength	Terminal to Terminal	1500 V _{RMS}
	Terminal to Bushing	2000 V _{RMS}
Maximum Voltage Operation		250 V v
Insulation Resistance Between Contacts		10 ³ MΩ
Life at P _{max.}		100 000 actuations
Minimal Travel		3.3 mm to 4.7 mm
Operating Temperature		- 40 °C to + 70 °C

ELECTRICAL DIAGRAM

ORDERING INFORMATION (First order only for special code creation)

RSPP

RSPP: Push/push
RSMP: Momentary/push

F2

F2: 2 reversing switches (standard version)
F4: 4 reversing switches
F6: 6 reversing switches
F8: 8 reversing switches

P11 OPTION: CONCENTRIC SHAFTS

The CC concentric shaft versions allies the total flexibility of the P11 modular system to the advantage of having two separate shafts.

The outer 6 mm or 1/4" or 1/8" dia. shaft drives the modules situated immediately behind the panel, before the spacer module.

The inner 3 mm or 1/8" or 0.07" dia. shaft drives the modules situated after the spacer module.

Spacer is available with a choice of two spacer thickness: 5.08 mm designations or 2.54 mm designation. See dimensional drawing



BUSHING CODE	OUTER SHAFT DIAMETER			INNER SHAFT DIAMETER		
	DIAMETER	LENGTH L	SHAFT STYLE	DIAMETER	LENGTH I	SHAFT STYLE
V	6	16	R	3	28.5	R
F	6.35 (1/4")	16	R	3.17 (1/8")	28.5	R
A	3.17 (1/8")	12.7 (1/2")	R	1.8 (0.07")	22.2 (7/8")	R

ORDERING INFORMATION (First order only for special code creation)

5.08

2.54: Mechanical spacer of 2.54 mm

5.08: Mechanical spacer of 5.08 mm

Customer should define witch modules is driven by each shaft (see example of ordering information at the end of the datasheet)

P11 OPTION: DETENT MODULES

The detents mechanism is housed in a standard P11 module. Up to 21 detent positions available.

Count detents as follows: 1 for CCW position, 1 for full CW position, plus the other positions forming equal resistance increments (linear taper) - not equal angles.

Available: CVID - CVIF - CVIM
CV3 - CV11 - CV21

Mechanical endurance: 10 000 cycles

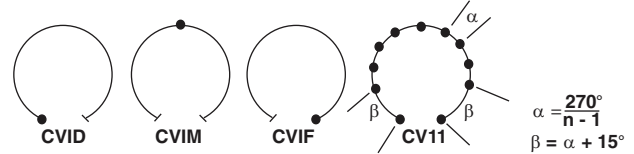
ORDERING INFORMATION (First order only for special code creation)

CV1M

- CV1M** 1 detent at half travel
- CV1M J84** CV1M with accuracy of center point $\pm 2\%$ (all tapers except S)
- CV1D** 1 detent at CCW position
- CV1F** 1 detent at CW position
- CV3** 3 detents
- CV11** 11 detents
- CV21** 21 detents

P11 OPTION: NEUTRAL MODULES "EN"

Neutral or screen module is housed in a standard P11 module. It is used as a screen between two electrical modules.

The leads can be connected to ground.

ORDERING INFORMATION (First order only for special code creation)

EN

EN Neutral module

P11 OPTION: CENTER CURRENT TAP “J”

The extra terminal is a solder lug connected at 50 % of electrical travel and situated in the potentiometer module opposite the terminals.

Center tap presents a short circuit of 11° of travel.



- Sealing IP60

ORDERING INFORMATION (First order only)

J

J Center tap

P11 OPTION: SPECIAL LINEARITY - CONFORMITY

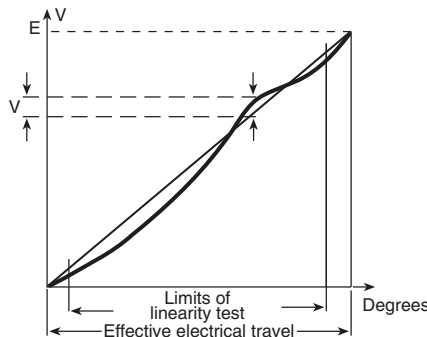

The independent linearity (conformity for the non-linear laws) is the maximum gap ΔV between the actual variation curve and the theoretical variation curve the nearest to it. The linearity and the conformity are expressed in percentage of the total applied voltage E

$$\text{linearity conformity} = \frac{\pm \Delta V_{\text{max.}}}{E}$$

They are measured over 90 % of actual electrical travel (centered).

On request linearity can be guaranteed in linear taper.

ORDERING INFORMATION (First order only)

J123

J123 Independent linearity $\pm 3\%$ (linear law)
J145 Independent linearity $\pm 2\%$ (linear law)

For other request, contact us.

P11 OPTION: SPECIAL INTERLINEARITY - INTERCONFORMITY

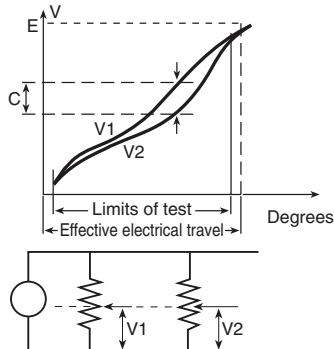

It is the maximum deviation between the actual voltage outputs of 2 or more pot modules in the same assembly. It is expressed as a percentage of the total applied voltage, or in dB attenuation.

Interlinearity is measured between 2 pot modules, over 20 to 90 % of the attenuation.

The interlinearity or interconformity is expressed as a percentage of the total applied voltage:

$$I \% = \frac{|C|}{E}$$

Or in decibels by comparison between outputs V1 and V2

$$I \text{ dB} = 20 \log \frac{V_1}{V_2}$$

ORDERING INFORMATION (First order only)

J44

J44 Interlinearity $\pm 2\%$ (linear taper)

For other request, contact us.



EXAMPLES OF FIRST ORDER INFORMATION

FIRST EXAMPLE: Triple module (switch is counted as a module)



ORDERING INFORMATION:

PART NUMBER	P11S3Q0APSY00.....	
SHAFT AND BUSHING	See drawing of special shaft attached	
MODULE NO. 1	RSID	
MODULE NO. 2	103 M A	J123
MODULE NO. 3	503 M A	J

SECOND EXAMPLE: Concentric shaft with 2 modules on each shaft



ORDERING INFORMATION:

PART NUMBER	P11S5V0CCRY00.....		
SHAFT AND BUSHING			
MODULE NO. 1	CV1M		Driven by outer shaft
MODULE NO. 2	502 K A		Driven by outer shaft
MODULE NO. 3	5.08		Mechanical spacer 5.08 mm
MODULE NO. 4	103 M A	J44	Driven by inner shaft
MODULE NO. 5	103 M A	J44	Driven by inner shaft

PART NUMBER DESCRIPTION (used on some Vishay document or label, for information only)

P11S	2	Q	0	EA	S	Y00	10K	20 %	A			e3
MODEL	MODULES	BUSHING	LOCATING PEG	SHAFT	SHAFT STYLE	LEADS	VALUE	TOL.	TAPER	SPECIAL	SPECIAL	LEAD (Pb)-FREE



Disclaimer

ALL PRODUCT, PRODUCT SPECIFICATIONS AND DATA ARE SUBJECT TO CHANGE WITHOUT NOTICE TO IMPROVE RELIABILITY, FUNCTION OR DESIGN OR OTHERWISE.

Vishay Intertechnology, Inc., its affiliates, agents, and employees, and all persons acting on its or their behalf (collectively, "Vishay"), disclaim any and all liability for any errors, inaccuracies or incompleteness contained in any datasheet or in any other disclosure relating to any product.

Vishay makes no warranty, representation or guarantee regarding the suitability of the products for any particular purpose or the continuing production of any product. To the maximum extent permitted by applicable law, Vishay disclaims (i) any and all liability arising out of the application or use of any product, (ii) any and all liability, including without limitation special, consequential or incidental damages, and (iii) any and all implied warranties, including warranties of fitness for particular purpose, non-infringement and merchantability.

Statements regarding the suitability of products for certain types of applications are based on Vishay's knowledge of typical requirements that are often placed on Vishay products in generic applications. Such statements are not binding statements about the suitability of products for a particular application. It is the customer's responsibility to validate that a particular product with the properties described in the product specification is suitable for use in a particular application. Parameters provided in datasheets and/or specifications may vary in different applications and performance may vary over time. All operating parameters, including typical parameters, must be validated for each customer application by the customer's technical experts. Product specifications do not expand or otherwise modify Vishay's terms and conditions of purchase, including but not limited to the warranty expressed therein.

Except as expressly indicated in writing, Vishay products are not designed for use in medical, life-saving, or life-sustaining applications or for any other application in which the failure of the Vishay product could result in personal injury or death. Customers using or selling Vishay products not expressly indicated for use in such applications do so at their own risk. Please contact authorized Vishay personnel to obtain written terms and conditions regarding products designed for such applications.

No license, express or implied, by estoppel or otherwise, to any intellectual property rights is granted by this document or by any conduct of Vishay. Product names and markings noted herein may be trademarks of their respective owners.

Material Category Policy

Vishay Intertechnology, Inc. hereby certifies that all its products that are identified as RoHS-Compliant fulfill the definitions and restrictions defined under Directive 2011/65/EU of The European Parliament and of the Council of June 8, 2011 on the restriction of the use of certain hazardous substances in electrical and electronic equipment (EEE) - recast, unless otherwise specified as non-compliant.

Please note that some Vishay documentation may still make reference to RoHS Directive 2002/95/EC. We confirm that all the products identified as being compliant to Directive 2002/95/EC conform to Directive 2011/65/EU.

Vishay Intertechnology, Inc. hereby certifies that all its products that are identified as Halogen-Free follow Halogen-Free requirements as per JEDEC JS709A standards. Please note that some Vishay documentation may still make reference to the IEC 61249-2-21 definition. We confirm that all the products identified as being compliant to IEC 61249-2-21 conform to JEDEC JS709A standards.