

# Dual Common Cathode High Voltage Schottky Rectifier

High Barrier Technology for Improved High Temperature Performance

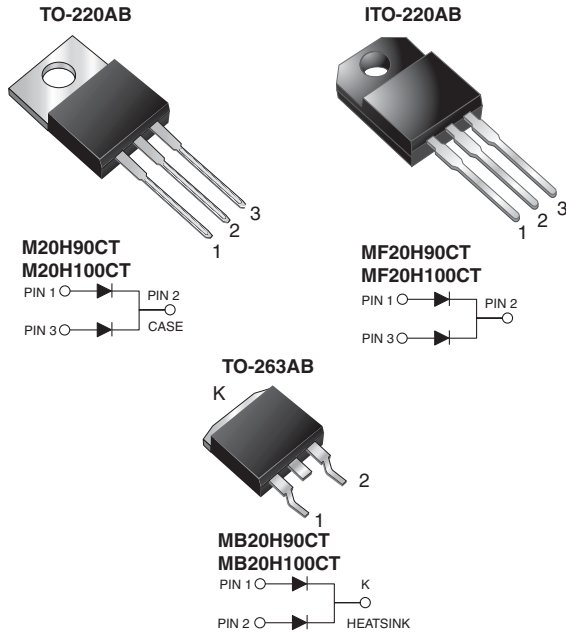

## FEATURES

- Power pack
- Guardring for overvoltage protection
- Low power loss, high efficiency
- Low forward voltage drop
- Low leakage current
- High forward surge capability
- High frequency operation
- Meets MSL level 1, per J-STD-020, LF maximum peak of 245 °C (for TO-263AB package)
- Solder bath temperature 275 °C maximum, 10 s, per JESD 22-B106 (for TO-220AB and ITO-220AB package)
- AEC-Q101 qualified available  
 - Automotive ordering code: base P/NHE3
- Material categorization: for definitions of compliance please see [www.vishay.com/doc?99912](http://www.vishay.com/doc?99912)

**RoHS**  
 COMPLIANT

## TYPICAL APPLICATIONS

For use in high frequency rectifier of switching mode power supplies, freewheeling diodes, DC/DC converters and polarity protection application.

## MECHANICAL DATA

**Case:** TO-220AB, ITO-220AB, TO-263AB

 Molding compound meets UL 94 V-0 flammability rating  
 Base P/N-E3 - RoHS-compliant, commercial grade  
 Base P/NHE3 - RoHS-compliant, AEC-Q101 qualified  
 Base P/NHE3\_X - RoHS-compliant, AEC-Q101 qualified  
 ("\_X" denotes revision code e.g. A, B, ....)

**Terminals:** Matte tin plated leads, solderable per J-STD-002 and JESD 22-B102

E3 suffix meets JESD 201 class 1A whisker test, HE3 suffix meets JESD 201 class 2 whisker test

**Polarity:** As marked

**Mounting Torque:** 10 in-lbs maximum

PRIMARY CHARACTERISTICS	
$I_{F(AV)}$	2 x 10 A
$V_{RRM}$	90 V to 100 V
$I_{FSM}$	250 A
$I_R$	4.5 $\mu$ A
$V_F$	0.64
$T_J$ max.	175 °C
Package	TO-220AB, ITO-220AB, TO-263AB
Diode variations	Dual Common Cathode

MAXIMUM RATINGS ( $T_A = 25$ °C unless otherwise noted)				
PARAMETER	SYMBOL	M20H90CT	M20H100CT	UNIT
Maximum repetitive peak reverse voltage	$V_{RRM}$	90	100	V
Working peak reverse voltage	$V_{RWM}$	90	100	
Maximum DC blocking voltage	$V_{DC}$	90	100	
Maximum average forward rectified current	$I_{F(AV)}$	total device		A
		per diode		
Peak forward surge current 8.3 ms single half sine-wave superimposed on rated load	$I_{FSM}$	250		A
Peak repetitive reverse current per diode at $t_p = 2.0$ $\mu$ s, 1 kHz	$I_{RRM}$	1.0		
Voltage rate of change (rated $V_R$ )	dV/dt	10 000		V/ $\mu$ s
Operating junction and storage temperature range	$T_J, T_{STG}$	-65 to +175		°C
Isolation voltage (ITO-220AB only) from terminal to heatsink $t = 1$ min	$V_{AC}$	1500		V



<b>ELECTRICAL CHARACTERISTICS</b> ( $T_A = 25\text{ }^\circ\text{C}$ unless otherwise noted)					
PARAMETER	SYMBOL	TEST CONDITIONS		VALUE	UNIT
Maximum instantaneous forward voltage per diode	$V_F^{(1)}$	$I_F = 10\text{ A}$	$T_C = 25\text{ }^\circ\text{C}$	0.77	V
		$I_F = 10\text{ A}$	$T_C = 125\text{ }^\circ\text{C}$	0.64	
		$I_F = 20\text{ A}$	$T_C = 25\text{ }^\circ\text{C}$	0.88	
		$I_F = 20\text{ A}$	$T_C = 125\text{ }^\circ\text{C}$	0.73	
Maximum reverse current at working peak reverse voltage per diode	$I_R^{(2)}$	Rated $V_R$	$T_J = 25\text{ }^\circ\text{C}$	4.5	$\mu\text{A}$
			$T_J = 125\text{ }^\circ\text{C}$	6.0	mA

**Notes**(1) Pulse test: 300  $\mu\text{s}$  pulse width, 1 % duty cycle(2) Pulse test: Pulse width  $\leq 40\text{ ms}$ 

<b>THERMAL CHARACTERISTICS</b> ( $T_A = 25\text{ }^\circ\text{C}$ unless otherwise noted)					
PARAMETER	SYMBOL	M	MF	MB	UNIT
Typical thermal resistance per diode	$R_{\theta JC}$	2.0	5.8	2.0	$^\circ\text{C/W}$

<b>ORDERING INFORMATION</b> (Example)					
PACKAGE	PREFERRED P/N	UNIT WEIGHT (g)	PACKAGE CODE	BASE QUANTITY	DELIVERY MODE
TO-220AB	M20H100CT-E3/45	1.85	45	50/tube	Tube
ITO-220AB	MF20H100CT-E3/45	1.99	45	50/tube	Tube
TO-263AB	MB20H100CT-E3/45	1.35	45	50/tube	Tube
TO-263AB	MB20H100CT-E3/81	1.35	81	800/reel	Tape and reel
TO-220AB	M20H100CTHE3/45 <sup>(1)</sup>	1.85	45	50/tube	Tube
ITO-220AB	MF20H100CTHE3/45 <sup>(1)</sup>	1.99	45	50/tube	Tube
TO-263AB	MB20H100CTHE3/45 <sup>(1)</sup>	1.35	45	50/tube	Tube
TO-263AB	MB20H100CTHE3/81 <sup>(1)</sup>	1.35	81	800/reel	Tape and reel
TO-220AB	M20H100CTHE3_A/P <sup>(1)</sup>	1.85	45	50/tube	Tube
ITO-220AB	MF20H100CTHE3_A/P <sup>(1)</sup>	1.99	45	50/tube	Tube

**Note**

(1) AEC-Q101 qualified



### RATINGS AND CHARACTERISTICS CURVES ( $T_A = 25\text{ }^\circ\text{C}$ unless otherwise noted)

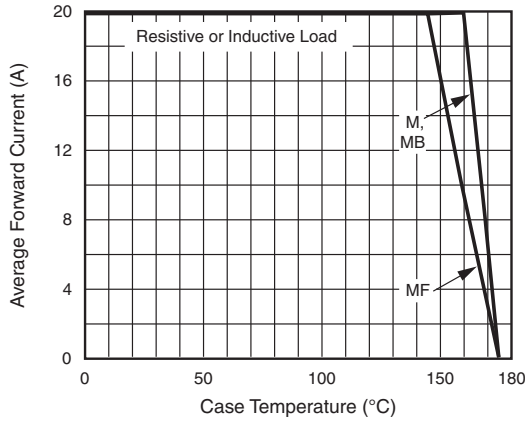

Fig. 1 - Forward Current Derating Curve

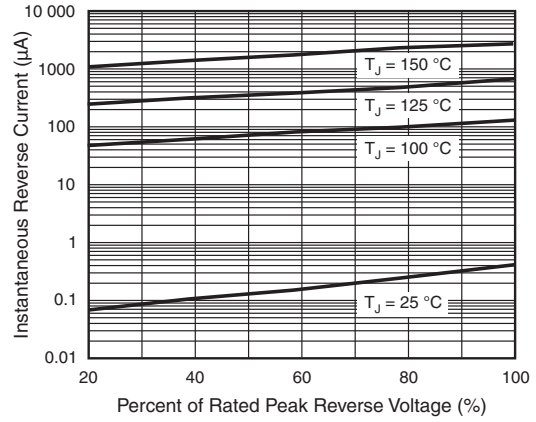

Fig. 4 - Typical Reverse Characteristics Per Diode

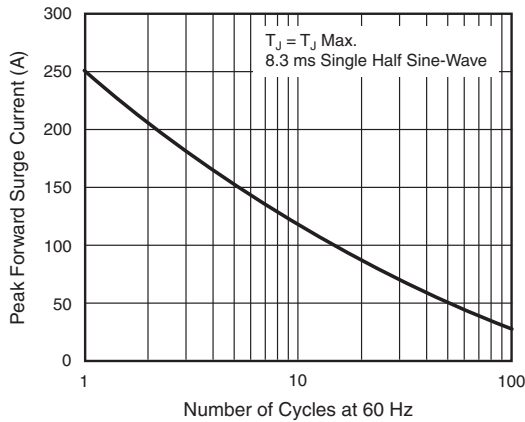

Fig. 2 - Maximum Non-Repetitive Peak Forward Surge Current Per Diode

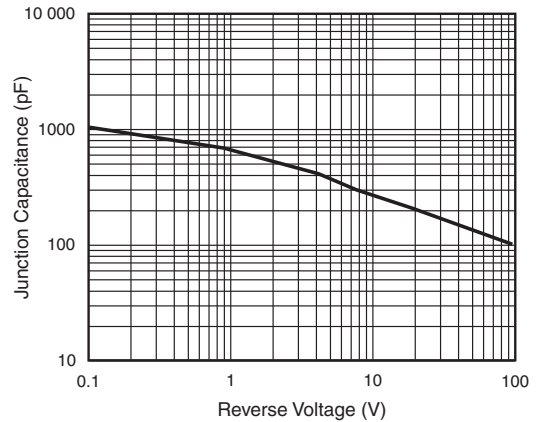

Fig. 5 - Typical Junction Capacitance Per Diode

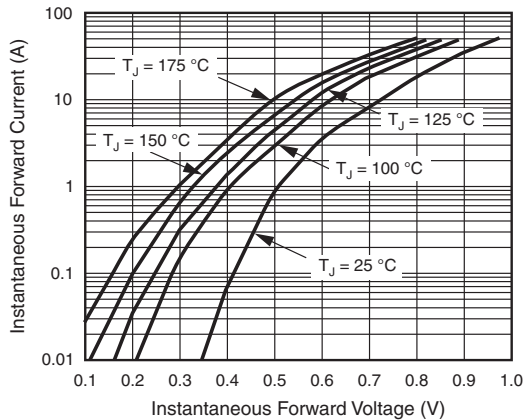

Fig. 3 - Typical Instantaneous Forward Characteristics Per Diode

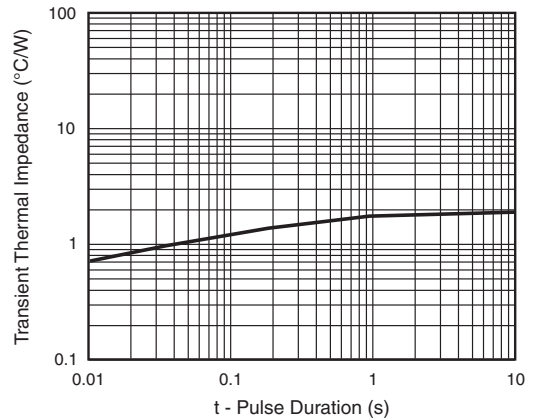
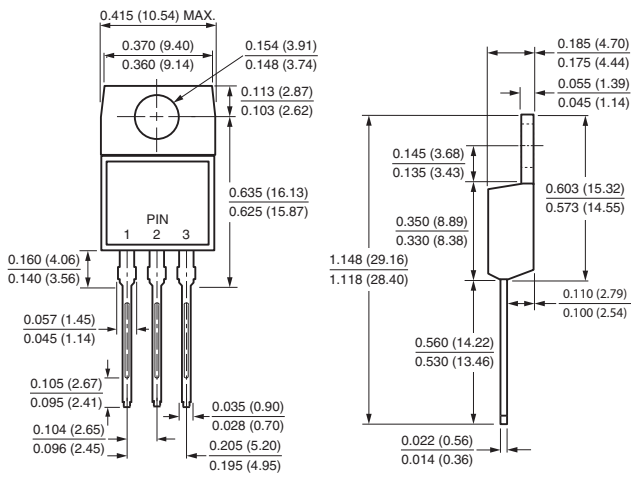

Fig. 6 - Typical Transient Thermal Impedance Per Diode



### PACKAGE OUTLINE DIMENSIONS in inches (millimeters)

#### TO-220AB



#### ITO-220AB

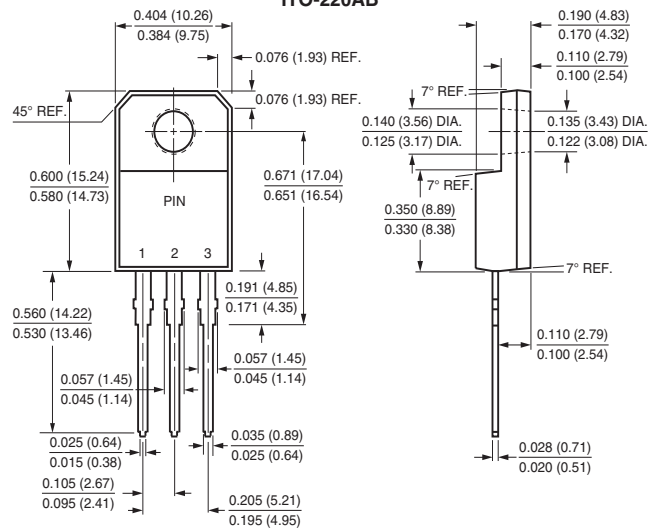

#### TO-263AB

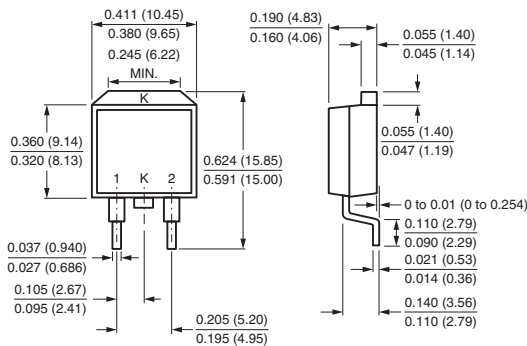

#### Mounting Pad Layout

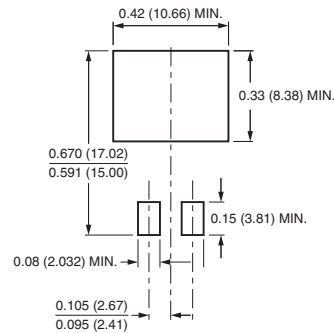



## Disclaimer

ALL PRODUCT, PRODUCT SPECIFICATIONS AND DATA ARE SUBJECT TO CHANGE WITHOUT NOTICE TO IMPROVE RELIABILITY, FUNCTION OR DESIGN OR OTHERWISE.

Vishay Intertechnology, Inc., its affiliates, agents, and employees, and all persons acting on its or their behalf (collectively, "Vishay"), disclaim any and all liability for any errors, inaccuracies or incompleteness contained in any datasheet or in any other disclosure relating to any product.

Vishay makes no warranty, representation or guarantee regarding the suitability of the products for any particular purpose or the continuing production of any product. To the maximum extent permitted by applicable law, Vishay disclaims (i) any and all liability arising out of the application or use of any product, (ii) any and all liability, including without limitation special, consequential or incidental damages, and (iii) any and all implied warranties, including warranties of fitness for particular purpose, non-infringement and merchantability.

Statements regarding the suitability of products for certain types of applications are based on Vishay's knowledge of typical requirements that are often placed on Vishay products in generic applications. Such statements are not binding statements about the suitability of products for a particular application. It is the customer's responsibility to validate that a particular product with the properties described in the product specification is suitable for use in a particular application. Parameters provided in datasheets and/or specifications may vary in different applications and performance may vary over time. All operating parameters, including typical parameters, must be validated for each customer application by the customer's technical experts. Product specifications do not expand or otherwise modify Vishay's terms and conditions of purchase, including but not limited to the warranty expressed therein.

Except as expressly indicated in writing, Vishay products are not designed for use in medical, life-saving, or life-sustaining applications or for any other application in which the failure of the Vishay product could result in personal injury or death. Customers using or selling Vishay products not expressly indicated for use in such applications do so at their own risk. Please contact authorized Vishay personnel to obtain written terms and conditions regarding products designed for such applications.

No license, express or implied, by estoppel or otherwise, to any intellectual property rights is granted by this document or by any conduct of Vishay. Product names and markings noted herein may be trademarks of their respective owners.

## Material Category Policy

**Vishay Intertechnology, Inc. hereby certifies that all its products that are identified as RoHS-Compliant fulfill the definitions and restrictions defined under Directive 2011/65/EU of The European Parliament and of the Council of June 8, 2011 on the restriction of the use of certain hazardous substances in electrical and electronic equipment (EEE) - recast, unless otherwise specified as non-compliant.**

**Please note that some Vishay documentation may still make reference to RoHS Directive 2002/95/EC. We confirm that all the products identified as being compliant to Directive 2002/95/EC conform to Directive 2011/65/EU.**

**Vishay Intertechnology, Inc. hereby certifies that all its products that are identified as Halogen-Free follow Halogen-Free requirements as per JEDEC JS709A standards. Please note that some Vishay documentation may still make reference to the IEC 61249-2-21 definition. We confirm that all the products identified as being compliant to IEC 61249-2-21 conform to JEDEC JS709A standards.**