

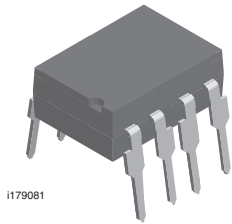

High Speed Optocoupler, 1 MBd, Photodiode with Transistor Output, 110 °C Rated

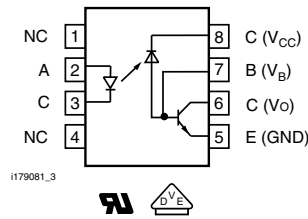

i179081



i179081_3



FEATURES

- Operating temperature from -55 °C to +110 °C
- Isolation test voltages: 5300 V_{RMS}
- TTL compatible
- High bit rates: 1 MBd
- Bandwidth 2 MHz
- Open-collector output
- External base wiring possible
- Material categorization: for definitions of compliance please see www.vishay.com/doc?99912



RoHS
COMPLIANT

DESCRIPTION

The 6N1135 and 6N1136 are 110 °C rated optocouplers with a GaAlAs infrared emitting diode, optically coupled with an integrated photo detector which consists of a photo diode and a high-speed transistor in a DIP-8 plastic package.

Signals can be transmitted between two electrically separated circuits up to frequencies of 2 MHz. The potential difference between the circuits to be coupled should not exceed the maximum permissible reference voltages.

AGENCY APPROVALS

- UL1577 (pending)
- DIN EN 60747-5-5 (VDE 0884) (pending)
- cUL (pending)
- CQC (pending)

ORDERING INFORMATION

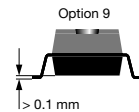
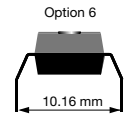
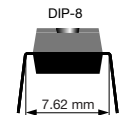
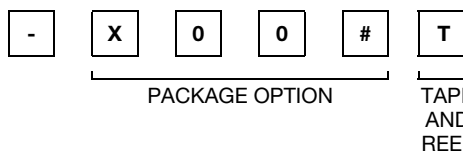
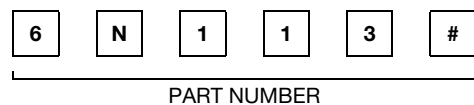

AGENCY CERTIFIED/PACKAGE	CTR (%)	
UL	≥ 7	≥ 19
DIP-8	6N1135	6N1136
DIP-8, 400 mil, option 6	6N1135-X006	6N1136-X006
SMD-8, option 9	6N1135-X009T	6N1136-X009T

ABSOLUTE MAXIMUM RATINGS (T_{amb} = 25 °C, unless otherwise specified)

PARAMETER	TEST CONDITION	SYMBOL	VALUE	UNIT
INPUT				
Reverse voltage		V _R	5	V
Forward current		I _F	25	mA
Peak forward current	t = 1 ms, duty cycle 50 %	I _{FM}	50	mA
Maximum surge forward current	t ≤ 1 μs, 300 pulses/s	I _{FSM}	1	A
Thermal resistance		R _{th}	700	K/W
Power dissipation	T _{amb} = 70 °C	P _{diss}	45	mW
OUTPUT				
Supply voltage		V _{CC}	-0.5 to 15	V
Output voltage		V _O	-0.5 to 15	V
Emitter base voltage		V _{EBO}	5	V
Output current		I _O	8	mA
Maximum Output current			16	mA



ABSOLUTE MAXIMUM RATINGS ($T_{amb} = 25\text{ }^{\circ}\text{C}$, unless otherwise specified)				
PARAMETER	TEST CONDITION	SYMBOL	VALUE	UNIT
OUTPUT				
Base current		I_B	5	mA
Thermal resistance			300	K/W
Power dissipation	$T_{amb} = 70\text{ }^{\circ}\text{C}$	P_{diss}	100	mW
COUPLER				
Isolation test voltage (between emitter and detector climate per DIN 50014 part 2, Nov. 74)	$t = 1\text{ min}$	V_{ISO}	5300	V_{RMS}
Storage temperature range		T_{stg}	-55 to +150	$^{\circ}\text{C}$
Ambient temperature range		T_{amb}	-55 to +100	$^{\circ}\text{C}$
Soldering temperature ⁽¹⁾	Max. $\leq 10\text{ s}$, dip soldering $\geq 0.5\text{ mm}$ from case bottom	T_{slid}	260	$^{\circ}\text{C}$

Notes

- Stresses in excess of the absolute maximum ratings can cause permanent damage to the device. Functional operation of the device is not implied at these or any other conditions in excess of those given in the operational sections of this document. Exposure to absolute maximum ratings for extended periods of the time can adversely affect reliability.
- Refer to reflow profile for soldering conditions for surface mounted devices (SMD). Refer to wave profile for soldering conditions for through hole devices (DIP).

ELECTRICAL CHARACTERISTICS ($T_{amb} = 25\text{ }^{\circ}\text{C}$, unless otherwise specified)							
PARAMETER	TEST CONDITION	PART	SYMBOL	MIN.	TYP.	MAX.	UNIT
INPUT							
Forward voltage	$I_F = 1.6\text{ mA}$		V_F	-	1.6	1.9	V
Breakdown voltage	$I_R = 10\text{ }\mu\text{A}$		V_{BR}	5	-	-	V
Reverse current	$V_R = 5\text{ V}$		I_R	-	0.5	10	μA
Capacitance	$V_R = 0\text{ V}$, $f = 1\text{ MHz}$		C_I	-	125	-	pF
Temperature coefficient, forward voltage	$I_F = 1.6\text{ mA}$		$\Delta V_F/\Delta T_A$	-	- 1.7	-	mV/ $^{\circ}\text{C}$
OUTPUT							
Logic low supply current	$I_F = 1.6\text{ mA}$, $V_O = \text{open}$, $V_{CC} = 15\text{ V}$		I_{CCL}	-	150	-	μA
Logic high supply current	$I_F = 0\text{ mA}$, $V_O = \text{open}$, $V_{CC} = 15\text{ V}$		I_{CCH}	-	0.01	1	μA
Output voltage, output low	$I_F = 16\text{ mA}$, $V_{CC} = 4.5\text{ V}$, $I_O = 1.1\text{ mA}$	6N1135	V_{OL}	-	0.1	0.4	V
	$I_F = 16\text{ mA}$, $V_{CC} = 4.5\text{ V}$, $I_O = 2.4\text{ mA}$	6N1136	V_{OL}	-	0.1	0.4	V
Output current, output high	$I_F = 0\text{ mA}$, $V_O = V_{CC} = 5.5\text{ V}$		I_{OH}	-	3	500	nA
	$I_F = 0\text{ mA}$, $V_O = V_{CC} = 15\text{ V}$		I_{OH}	-	0.01	1	μA
COUPLER							
Capacitance (input to output)	$f = 1\text{ MHz}$		C_{IO}	-	0.6	-	pF

Note

- Minimum and maximum values are testing requirements. Typical values are characteristics of the device and are the result of engineering evaluation. Typical values are for information only and are not part of the testing requirements.

CURRENT TRANSFER RATIO							
PARAMETER	TEST CONDITION	PART	SYMBOL	MIN.	TYP.	MAX.	UNIT
Current transfer ratio	$I_F = 16\text{ mA}$, $V_O = 0.4\text{ V}$, $V_{CC} = 4.5\text{ V}$	6N1135	CTR	7	16	-	%
		6N1136	CTR	19	35	-	%
	$I_F = 16\text{ mA}$, $V_O = 0.5\text{ V}$, $V_{CC} = 4.5\text{ V}$	6N1135	CTR	5	-	-	%
		6N1136	CTR	15	-	-	%



SWITCHING CHARACTERISTICS							
PARAMETER	TEST CONDITION	PART	SYMBOL	MIN.	TYP.	MAX.	UNIT
High to low	$I_F = 16 \text{ mA}$, $V_{CC} = 5 \text{ V}$, $R_L = 4.1 \text{ k}\Omega$	6N1135	t_{PHL}	-	0.3	1.5	μs
	$I_F = 16 \text{ mA}$, $V_{CC} = 5 \text{ V}$, $R_L = 1.9 \text{ k}\Omega$	6N1136	t_{PHL}	-	0.2	0.8	μs
Low to high	$I_F = 16 \text{ mA}$, $V_{CC} = 5 \text{ V}$, $R_L = 4.1 \text{ k}\Omega$	6N1135	t_{PLH}	-	0.3	1.5	μs
	$I_F = 16 \text{ mA}$, $V_{CC} = 5 \text{ V}$, $R_L = 1.9 \text{ k}\Omega$	6N1136	t_{PLH}	-	0.2	0.8	μs

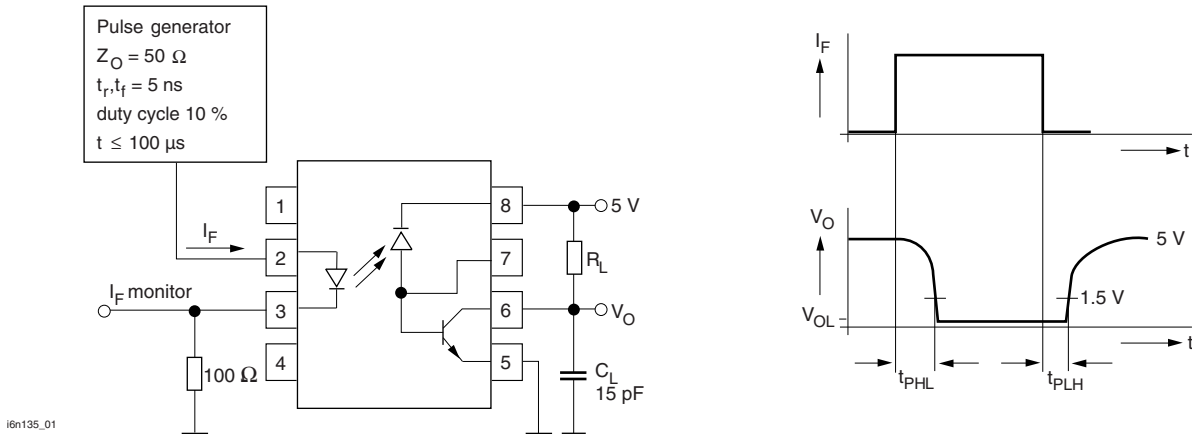

COMMON MODE TRANSIENT IMMUNITY							
PARAMETER	TEST CONDITION	PART	SYMBOL	MIN.	TYP.	MAX.	UNIT
High	$I_F = 0 \text{ mA}$, $V_{CM} = 10 \text{ V}_{P-P}$, $V_{CC} = 5 \text{ V}$, $R_L = 4.1 \text{ k}\Omega$	6N1135	$ CM_H $	-	1000	-	$\text{V}/\mu\text{s}$
	$I_F = 0 \text{ mA}$, $V_{CM} = 10 \text{ V}_{P-P}$, $V_{CC} = 5 \text{ V}$, $R_L = 1.9 \text{ k}\Omega$	6N1136	$ CM_H $	-	1000	-	$\text{V}/\mu\text{s}$
Low	$I_F = 16 \text{ mA}$, $V_{CM} = 10 \text{ V}_{P-P}$, $V_{CC} = 5 \text{ V}$, $R_L = 4.1 \text{ k}\Omega$	6N1135	$ CM_L $	-	1000	-	$\text{V}/\mu\text{s}$
	$I_F = 16 \text{ mA}$, $V_{CM} = 10 \text{ V}_{P-P}$, $V_{CC} = 5 \text{ V}$, $R_L = 1.9 \text{ k}\Omega$	6N1136	$ CM_L $	-	1000	-	$\text{V}/\mu\text{s}$

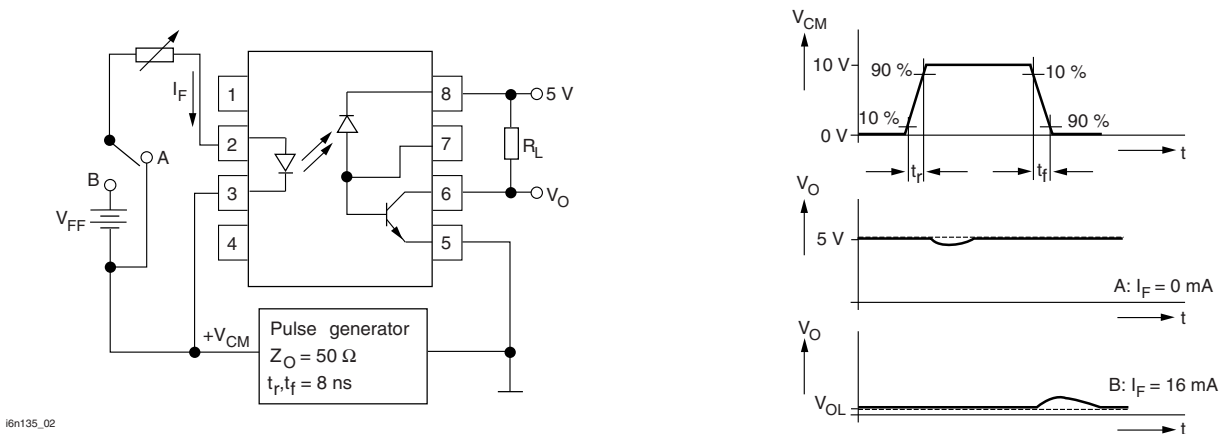



SAFETY AND INSULATION RATINGS						
PARAMETER	TEST CONDITION	SYMBOL	MIN.	TYP.	MAX.	UNIT
Climatic classification	According to IEC 68 part 1		-	55 / 110 / 21	-	
Pollution degree (DIN VDE 0109)			-	2	-	
Comparative tracking index per DIN IEC112/VDE 0303 part 1, group IIIa per DIN VDE 6110		CTI	175	-	399	
V_{IOTM}		V_{IOTM}	8000	-	-	V
V_{IORM}		V_{IORM}	630	-	-	V
Isolation resistance	$V_{IO} = 500 \text{ V}, T_{amb} = 25 \text{ }^\circ\text{C}$	R_{IO}	10^{12}	-	-	Ω
	$V_{IO} = 500 \text{ V}, T_{amb} = 100 \text{ }^\circ\text{C}$	R_{IO}	10^{11}	-	-	Ω
P_{SI}		P_{SI}	-	-	500	mA
I_{SI}		I_{SI}	-	-	300	mW
T_{SI}		T_{SI}	-	-	175	$^\circ\text{C}$
Creepage distance			8	-	-	mm
Clearance distance			7	-	-	mm
Insulation thickness			0.4	-	-	mm

Note

- As per IEC 60747-5-5, §7.4.3.8.1, this optocoupler is suitable for “safe electrical insulation” only within the safety ratings. Compliance with the safety ratings shall be ensured by means of protective circuits.

TYPICAL CHARACTERISTICS ($T_{amb} = 25 \text{ }^\circ\text{C}$, unless otherwise specified)

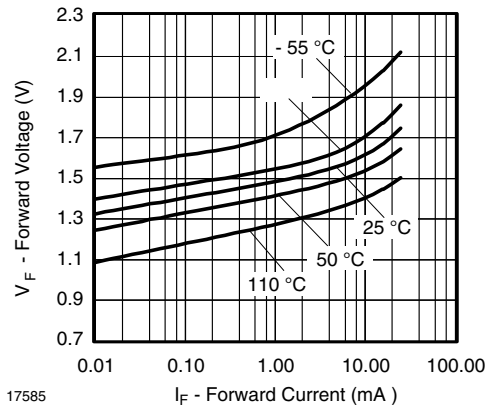

Fig. 3 - Forward Voltage vs. Forward Current

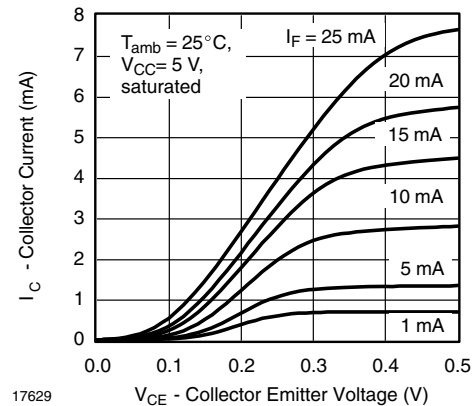

Fig. 5 - Collector Current vs. Collector Emitter Voltage

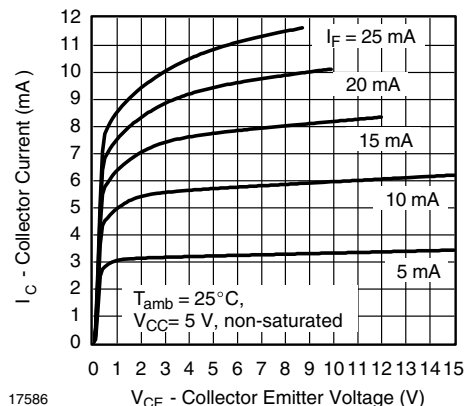

Fig. 4 - Collector Current vs. Collector Emitter Voltage

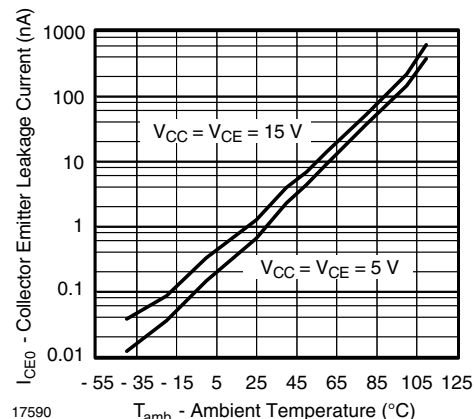

Fig. 6 - Collector Emitter Dark Current vs. Ambient Temperature

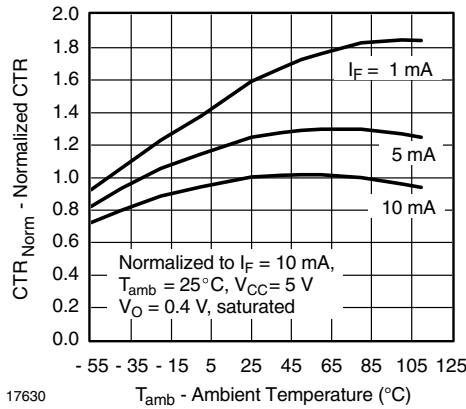

Fig. 7 - Normalized Current Transfer Ratio vs. Ambient Temperature

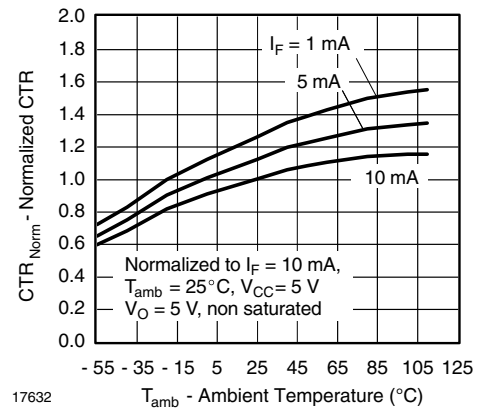

Fig. 10 - Normalized Current Transfer Ratio vs. Ambient Temperature

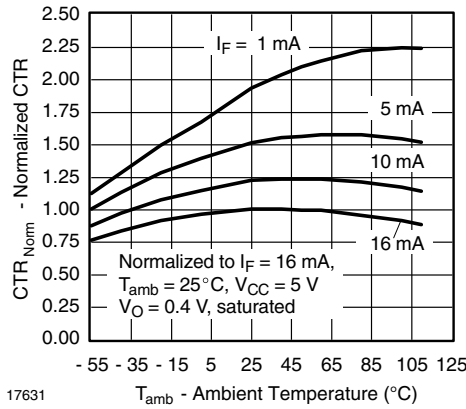

Fig. 8 - Normalized Current Transfer Ratio vs. Ambient Temperature

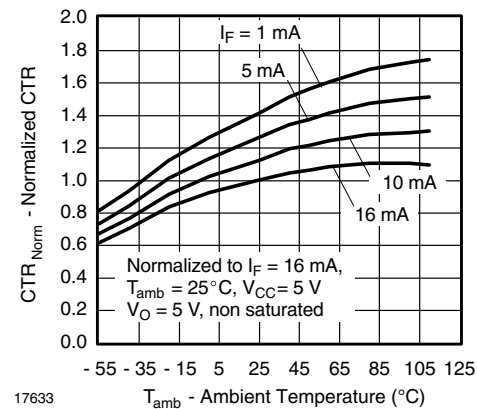

Fig. 11 - Normalized Current Transfer Ratio vs. Ambient Temperature

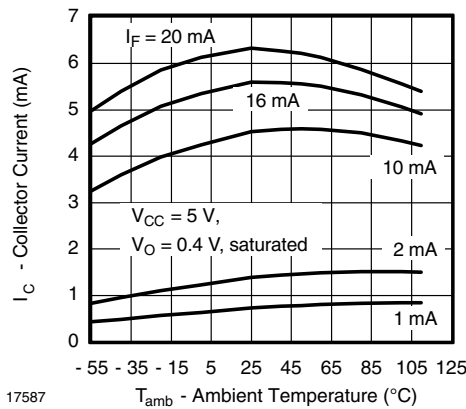

Fig. 9 - Output Current vs. Temperature

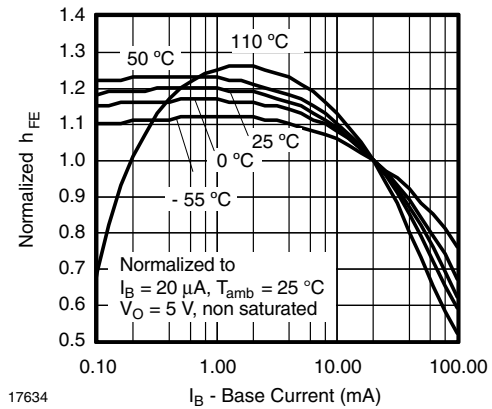
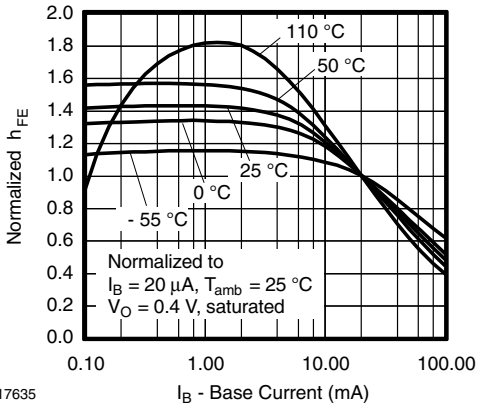
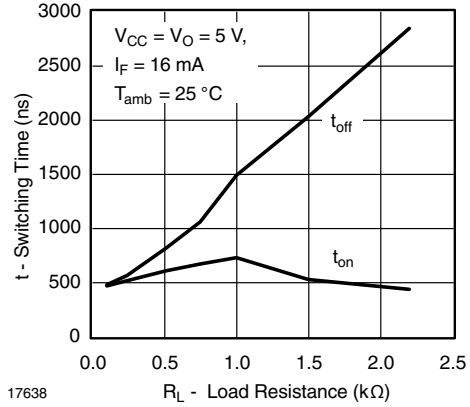

Fig. 12 - Normalized h_{FE} vs. Base Current



17635

Fig. 13 - Normalized h_{FE} vs. Base Current



17638

Fig. 16 - Switching Time vs. Load Resistance

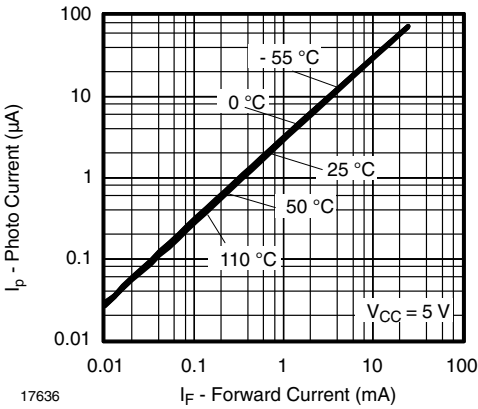

17636

Fig. 14 - Photo Current vs. Forward Current

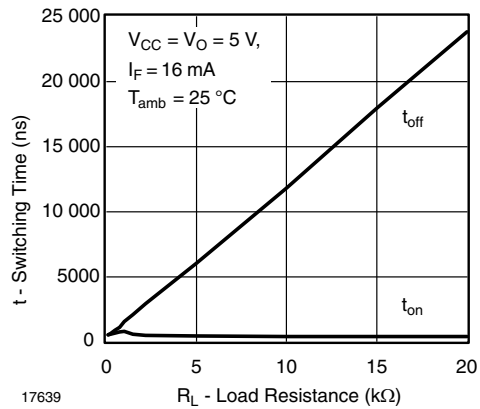

17639

Fig. 17 - Switching Time vs. Load Resistance

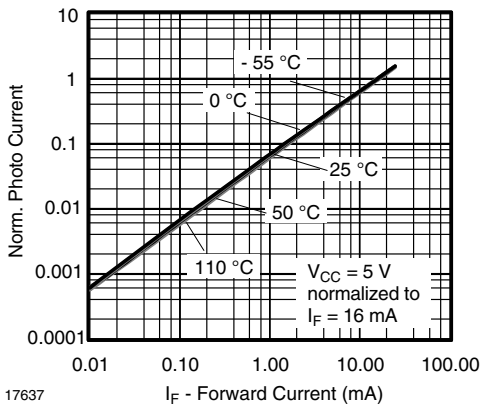

17637

Fig. 15 - Photo Current vs. Forward Current

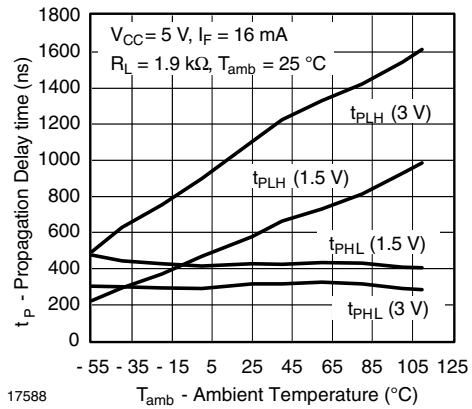

17588

Fig. 18 - Propagation Delay vs. Ambient Temperature

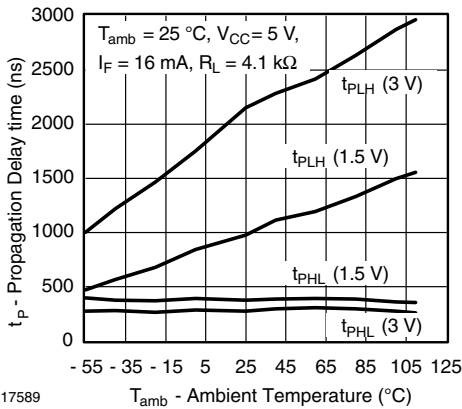

Fig. 19 - Propagation Delay vs. Ambient Temperature

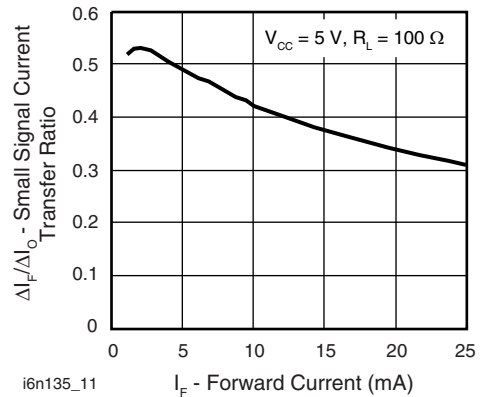

Fig. 21 - Small Signal Current Transfer Ratio vs. Quiescent Input Current

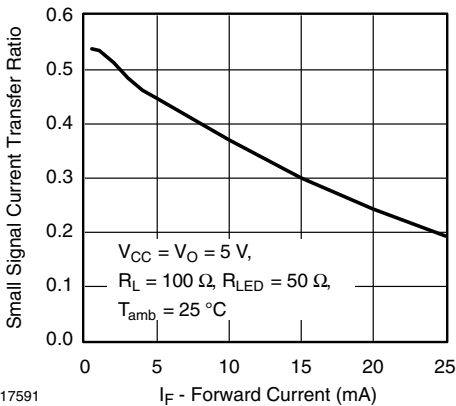
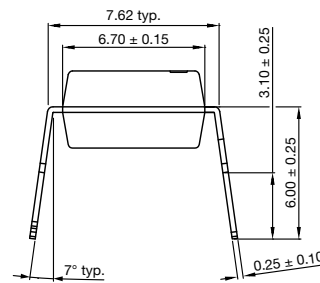
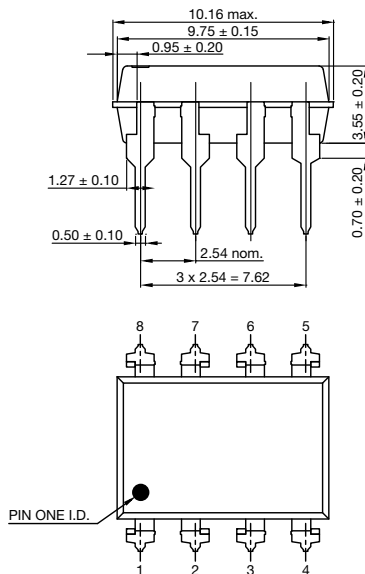

Fig. 20 - Small Signal CTR vs. Forward Current

PACKAGE DIMENSIONS in millimeters

Standard



22672



Option 6

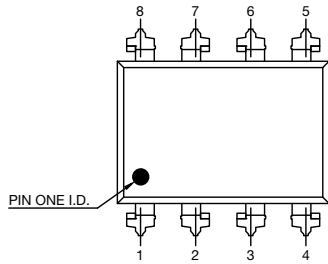
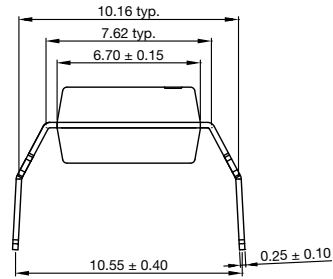
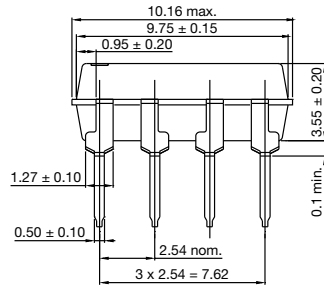

Option 9

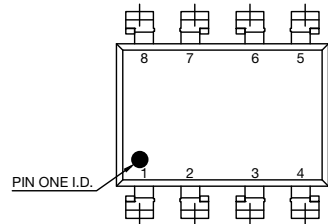
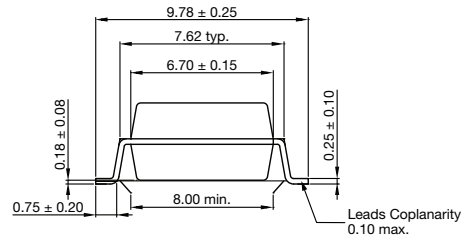
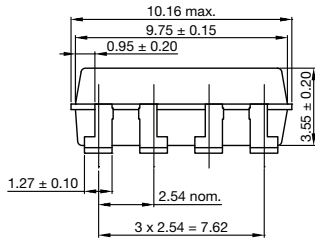

PACKAGE MARKING

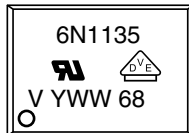

21764-70

22675



Disclaimer

ALL PRODUCT, PRODUCT SPECIFICATIONS AND DATA ARE SUBJECT TO CHANGE WITHOUT NOTICE TO IMPROVE RELIABILITY, FUNCTION OR DESIGN OR OTHERWISE.

Vishay Intertechnology, Inc., its affiliates, agents, and employees, and all persons acting on its or their behalf (collectively, "Vishay"), disclaim any and all liability for any errors, inaccuracies or incompleteness contained in any datasheet or in any other disclosure relating to any product.

Vishay makes no warranty, representation or guarantee regarding the suitability of the products for any particular purpose or the continuing production of any product. To the maximum extent permitted by applicable law, Vishay disclaims (i) any and all liability arising out of the application or use of any product, (ii) any and all liability, including without limitation special, consequential or incidental damages, and (iii) any and all implied warranties, including warranties of fitness for particular purpose, non-infringement and merchantability.

Statements regarding the suitability of products for certain types of applications are based on Vishay's knowledge of typical requirements that are often placed on Vishay products in generic applications. Such statements are not binding statements about the suitability of products for a particular application. It is the customer's responsibility to validate that a particular product with the properties described in the product specification is suitable for use in a particular application. Parameters provided in datasheets and / or specifications may vary in different applications and performance may vary over time. All operating parameters, including typical parameters, must be validated for each customer application by the customer's technical experts. Product specifications do not expand or otherwise modify Vishay's terms and conditions of purchase, including but not limited to the warranty expressed therein.

Except as expressly indicated in writing, Vishay products are not designed for use in medical, life-saving, or life-sustaining applications or for any other application in which the failure of the Vishay product could result in personal injury or death. Customers using or selling Vishay products not expressly indicated for use in such applications do so at their own risk. Please contact authorized Vishay personnel to obtain written terms and conditions regarding products designed for such applications.

No license, express or implied, by estoppel or otherwise, to any intellectual property rights is granted by this document or by any conduct of Vishay. Product names and markings noted herein may be trademarks of their respective owners.