

UV SMD LED with Silicone Lens

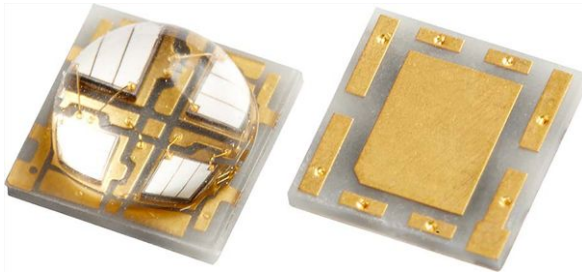

DESCRIPTION

VLMU5200-385-140 is a ceramic based High Power UV LEDs with silicone lens for long life time. The package size is 5.2 mm x 5.2 mm x 3.1 mm, and the radiant power up to 4400 mW at 700 mA, with 4 LED chips connected in series.

PRODUCT GROUP AND PACKAGE DATA

- Product group: LED
- Package: SMD ceramic high power
- Product series: high power UV LED
- Angle of half intensity: $\pm 70^\circ$
- Lead-finishing: Au

SAFETY ADVICES

Depending on the mode of operation, these devices emit highly concentrated non visible ultraviolet light which can be hazardous to the human eye. Products which incorporate these devices have to follow the safety precautions given in IEC 62471 "Photobiological Safety of Lamp and Lamp Systems".

FEATURES

- Ceramic SMT package with silicone lens
- Dimensions (L x W x H) in mm: 5.2 x 5.2 x 3.1
- Forward current: up to 700 mA
- Radiant power (typ.): 2500 mW at 500 mA, 3600 mW at 700 mA
- Materials:
 - Die: InGaN
 - Resin: silicone (water clear)
 - L / F finish: AlN with Au plating
- Grouping parameters:
 - Radiant power
 - Peak wavelength
 - Forward voltage
- Reflow soldering method
- MSL2 according to J-STD-020
- Packaging: 12 mm tape with 100 pieces per reel, \varnothing 180 mm (7")
- Material categorization: for definitions of compliance please see www.vishay.com/doc?99912



APPLICATIONS

- Industrial curing
- Photocatalytic purification
- Poster printing curing
- Counterfeit money detector
- Blood detector
- Nail curing
- Teeth curing

PARTS TABLE

PART	COLOR	RADIANT POWER (mW)			at I _F (mA)	WAVELENGTH (nm)			at I _F (mA)	FORWARD VOLTAGE (V)			at I _F (mA)	TECHNOLOGY
		MIN.	TYP.	MAX.		MIN.	TYP.	MAX.		MIN.	TYP.	MAX.		
VLMU5200-385-140	Ultraviolet	1800	2500	3300	500	380	385	390	500	13	14.5	16	500	InGaN

ABSOLUTE MAXIMUM RATINGS (T_{amb} = 25 °C, unless otherwise specified) VLMU5200-385-140

PARAMETER	TEST CONDITION	SYMBOL	VALUE	UNIT
DC forward current		I _F	700	mA
Power dissipation		P _V	11.2	W
Electrostatic discharge	HBM: MIL-STD-883 C 3B	ESD	2000	V
Junction temperature		T _j	+150	°C
Operating temperature range		T _{amb}	-40 to +85	°C
Storage temperature range		T _{stg}	-40 to +100	°C
Solder temperature		T _{sol}	260	°C
Thermal resistance - junction to solder point		R _{thJS}	3	°C/W

**OPTICAL AND ELECTRICAL CHARACTERISTICS** ($T_{amb} = 25\text{ }^{\circ}\text{C}$, unless otherwise specified)
VLMU5200-385-140, ULTRAVIOLET

PARAMETER	TEST CONDITION	SYMBOL	MIN.	TYP.	MAX.	UNIT
Forward voltage	$I_F = 500\text{ mA}$	V_F	13.0	14.5	16.0	V
Radiant power	$I_F = 350\text{ mA}$	ϕ_e	1300	1950	2350	mW
	$I_F = 500\text{ mA}$		1800	2500	3300	
	$I_F = 700\text{ mA}$		2480	3600	4400	
Radiant intensity	$I_F = 350\text{ mA}$	I_e	-	513	-	mW/sr
	$I_F = 500\text{ mA}$		-	700	-	
	$I_F = 700\text{ mA}$		-	1054	-	
Peak wavelength	$I_F = 500\text{ mA}$	λ_p	380	385	390	nm
Angle of half intensity	$I_F = 500\text{ mA}$	φ	-	± 70	-	deg

Note

- Tolerances: $\pm 11\%$ for ϕ_e , $\pm 0.1\text{ V}$ for V_F , $\pm 2\text{ nm}$ for λ_p .

RADIANT POWER CLASSIFICATION ($I_F = 500\text{ mA}$)

GROUP	MIN.	MAX.	UNIT
PA8	1800	1900	mW
PA9	1900	2000	
PB0	2000	2100	
PB1	2100	2200	
PB2	2200	2300	
PB3	2300	2400	
PB4	2400	2500	
PB5	2500	2600	
PB6	2600	2700	
PB7	2700	2800	
PB8	2800	2900	
PB9	2900	3000	
PC0	3000	3100	
PC1	3100	3200	
PC2	3200	3300	

PEAK WAVELENGTH CLASSIFICATION ($I_F = 500\text{ mA}$)

GROUP	MIN.	MAX.	UNIT
Q380	380	385	nm
Q385	385	390	

FORWARD VOLTAGE CLASSIFICATION ($I_F = 500\text{ mA}$)

GROUP	MIN.	MAX.	UNIT
W1314	13.0	14.0	V
W1415	14.0	15.0	
W1516	15.0	16.0	

Note

- In order to ensure availability, single groups for radiant intensity, wavelength, and forward voltage will not be orderable. Only one group for radiant intensity, wavelength, and forward voltage will be shipped in any one reel.

MARKING EXAMPLE FOR SELECTION CODE ON LABEL

Selection code: PA9Q385W1415

PA9 $\rightarrow \phi_e$ Q385 $\rightarrow \lambda_p$ W1415 $\rightarrow V_F$

TYPICAL CHARACTERISTICS ($T_{amb} = 25\text{ }^{\circ}\text{C}$, unless otherwise specified)

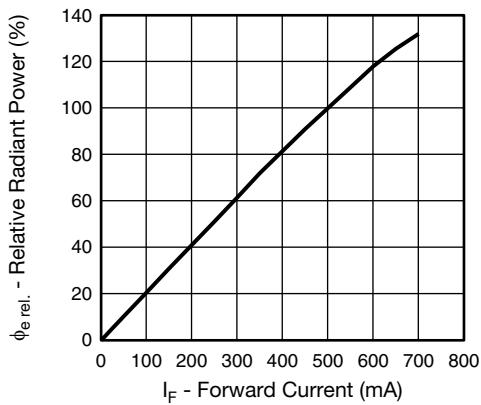

Fig. 1 - Relative Radiant Power vs. Forward Current

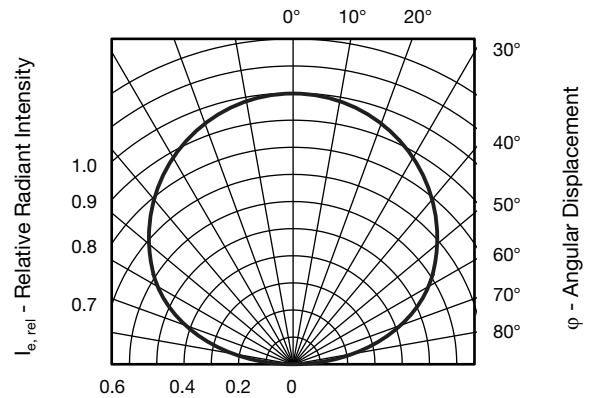

Fig. 4 - Relative Intensity vs. Wavelength

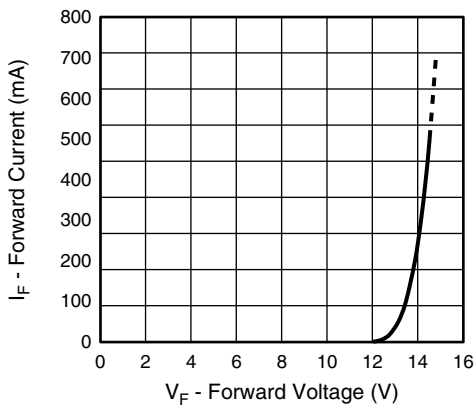

Fig. 2 - Forward Current vs. Forward Voltage

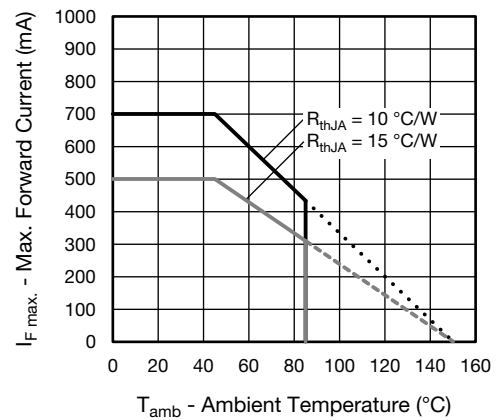

Fig. 5 - Maximum Forward Current vs. Ambient Temperature

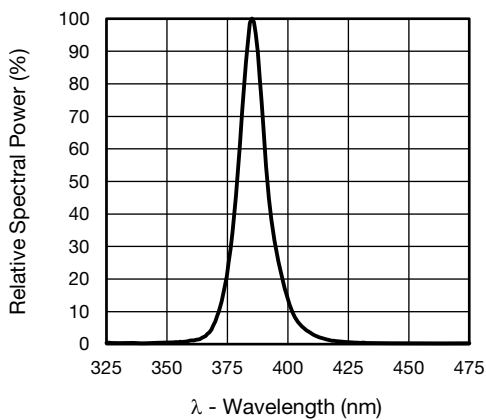
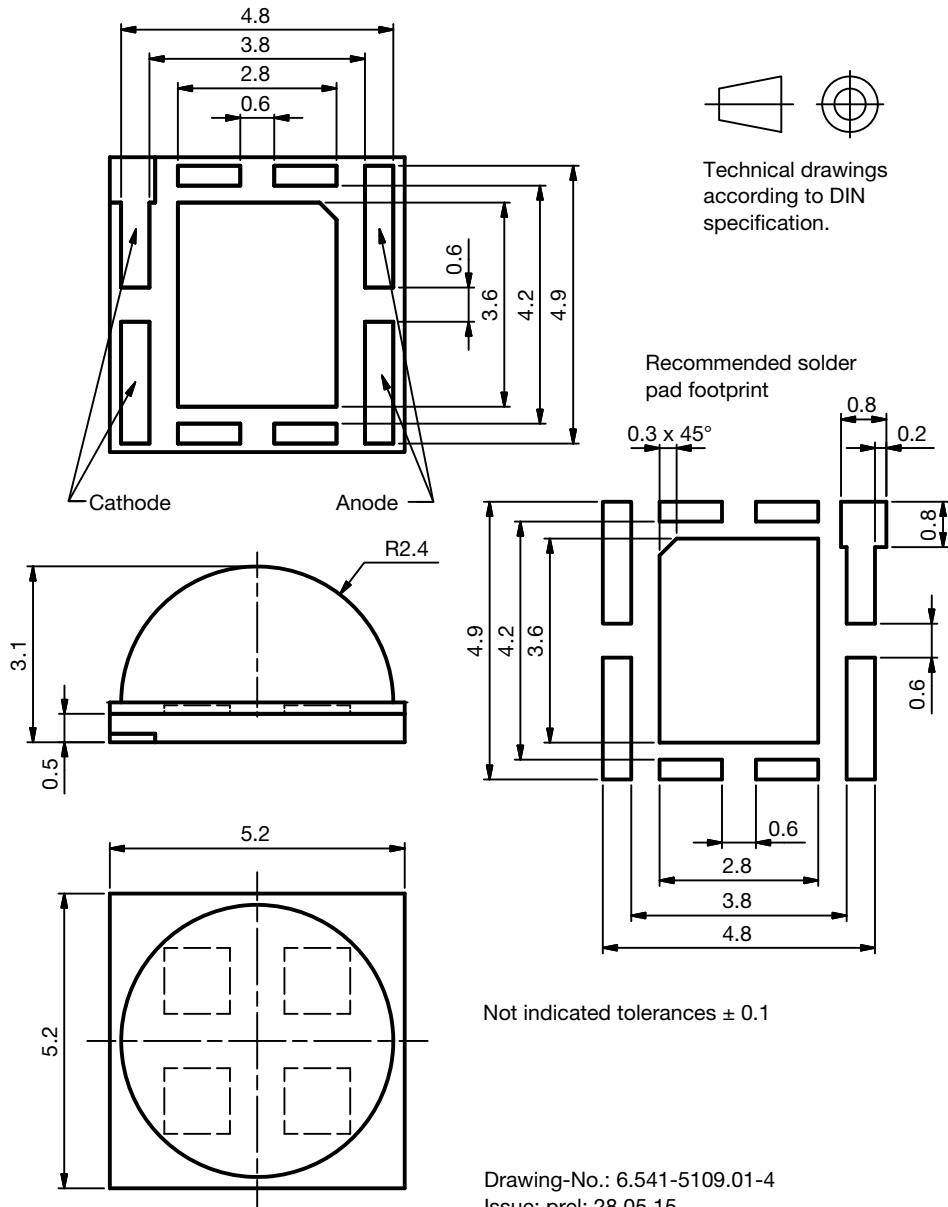

Fig. 3 - Relative Spectral Power vs. Wavelength



PACKAGE DIMENSIONS in millimeters



TAPE AND REEL DIMENSIONS in millimeters

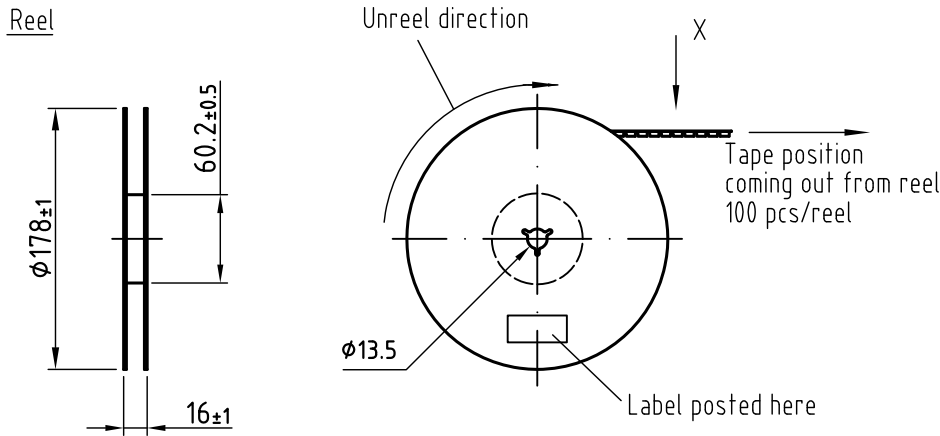

All dimensions in mm

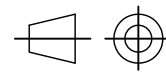

technical drawings according to DIN specifications

Leader and trailer tape:

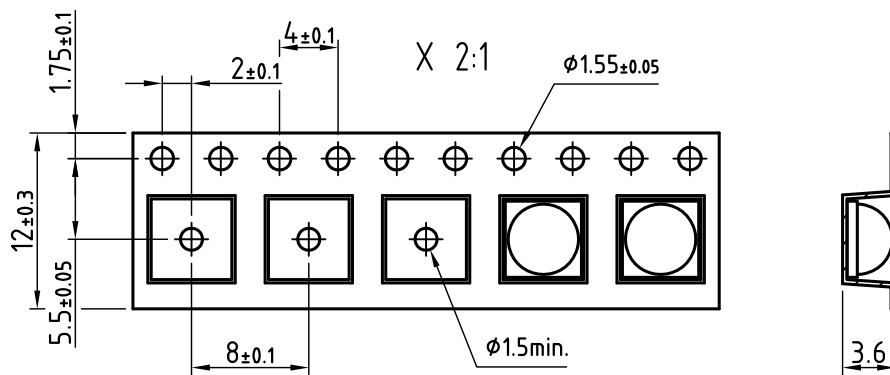
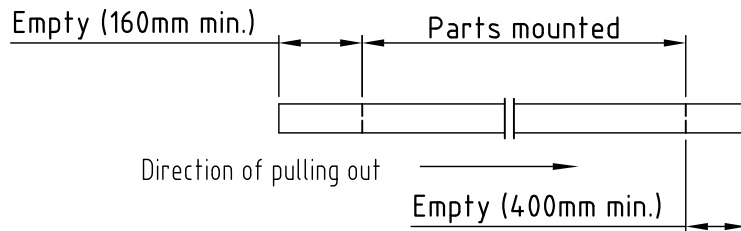

Drawing refers to following types: VLMU5200-385-140
Reel dimensions and tape

Drawing-No.: 9.800-5135.01-4
Issue: prel; 29.05.15

MOQ: 1000 pieces (10 reels each with 100 pieces)

SOLDERING PROFILE

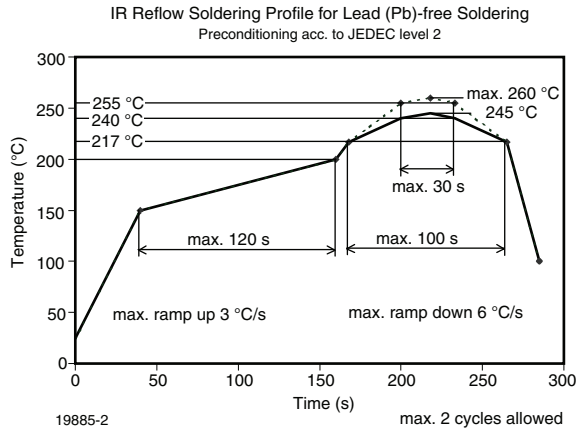
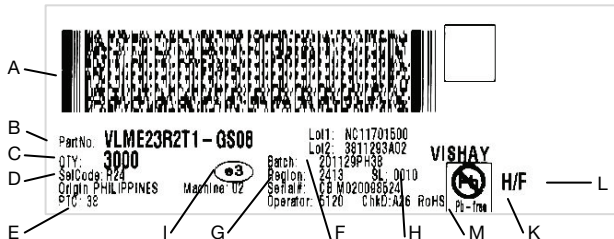

Fig. 6 - Vishay Lead (Pb)-free Reflow Soldering Profile (acc. to J-STD-020C)

BAR CODE PRODUCT LABEL (example only)



- A. 2D barcode
- B. Vishay part number
- C. Quantity
- D. SEL = selection code (binning)
- E. Code of manufacturing plant
- F. Batch = date code: year / week / plant code
- G. Region code
- H. SL = sales location
- I. Terminations finishing
- J. Lead (Pb)-free symbol
- K. Halogen-free symbol
- L. RoHS symbol

DRY PACKING

The reel is packed in an anti-humidity bag to protect the devices from absorbing moisture during transportation and storage.

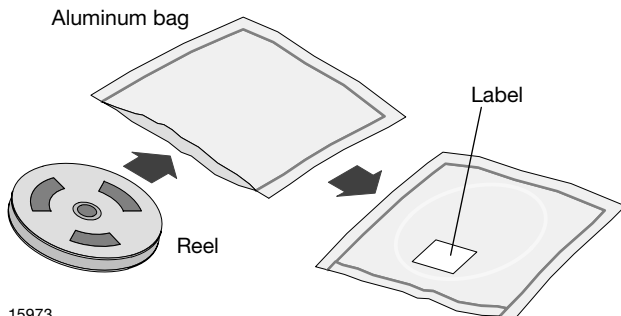

15973

FINAL PACKING

The sealed reel is packed into a cardboard box. A secondary cardboard box is used for shipping purposes.

RECOMMENDED METHOD OF STORAGE

Dry box storage is recommended as soon as the aluminum bag has been opened to prevent moisture absorption. The following conditions should be observed, if dry boxes are not available:

- Storage temperature 10 °C to 30 °C
- Storage humidity ≤ 60 % RH max.

After more than 1 year under these conditions moisture content will be too high for reflow soldering.

In case of moisture absorption, the devices will recover to the former condition by drying under the following condition:

- 192 h at 40 °C + 5 °C / - 0 °C and < 5 % RH (dry air / nitrogen) or
- 96 h at 60 °C + 5 °C and < 5 % RH for all device containers or
- 24 h at 100 °C + 5 °C not suitable for reel or tubes.

An EIA JEDEC® standard JESD22-A112 level 2a label is included on all dry bags.

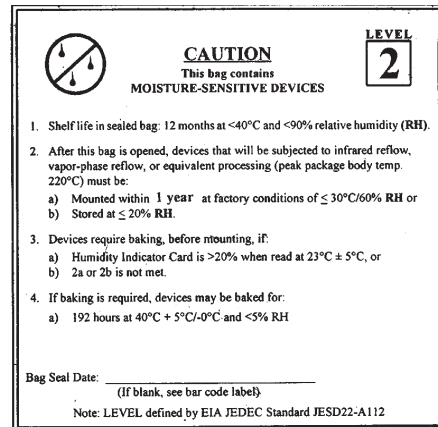

17028

Example of JESD22-A112 level 2 label

ESD PRECAUTION

Proper storage and handling procedures should be followed to prevent ESD damage to the devices especially when they are removed from the antistatic shielding bag. Electrostatic sensitive devices warning labels are on the packaging.

VISHAY SEMICONDUCTORS STANDARD BAR CODE LABELS

The Vishay Semiconductors standard bar code labels are printed at final packing areas. The labels are on each packing unit and contain Vishay Semiconductors specific data.



Disclaimer

ALL PRODUCT, PRODUCT SPECIFICATIONS AND DATA ARE SUBJECT TO CHANGE WITHOUT NOTICE TO IMPROVE RELIABILITY, FUNCTION OR DESIGN OR OTHERWISE.

Vishay Intertechnology, Inc., its affiliates, agents, and employees, and all persons acting on its or their behalf (collectively, "Vishay"), disclaim any and all liability for any errors, inaccuracies or incompleteness contained in any datasheet or in any other disclosure relating to any product.

Vishay makes no warranty, representation or guarantee regarding the suitability of the products for any particular purpose or the continuing production of any product. To the maximum extent permitted by applicable law, Vishay disclaims (i) any and all liability arising out of the application or use of any product, (ii) any and all liability, including without limitation special, consequential or incidental damages, and (iii) any and all implied warranties, including warranties of fitness for particular purpose, non-infringement and merchantability.

Statements regarding the suitability of products for certain types of applications are based on Vishay's knowledge of typical requirements that are often placed on Vishay products in generic applications. Such statements are not binding statements about the suitability of products for a particular application. It is the customer's responsibility to validate that a particular product with the properties described in the product specification is suitable for use in a particular application. Parameters provided in datasheets and/or specifications may vary in different applications and performance may vary over time. All operating parameters, including typical parameters, must be validated for each customer application by the customer's technical experts. Product specifications do not expand or otherwise modify Vishay's terms and conditions of purchase, including but not limited to the warranty expressed therein.

Except as expressly indicated in writing, Vishay products are not designed for use in medical, life-saving, or life-sustaining applications or for any other application in which the failure of the Vishay product could result in personal injury or death. Customers using or selling Vishay products not expressly indicated for use in such applications do so at their own risk. Please contact authorized Vishay personnel to obtain written terms and conditions regarding products designed for such applications.

No license, express or implied, by estoppel or otherwise, to any intellectual property rights is granted by this document or by any conduct of Vishay. Product names and markings noted herein may be trademarks of their respective owners.

Material Category Policy

Vishay Intertechnology, Inc. hereby certifies that all its products that are identified as RoHS-Compliant fulfill the definitions and restrictions defined under Directive 2011/65/EU of The European Parliament and of the Council of June 8, 2011 on the restriction of the use of certain hazardous substances in electrical and electronic equipment (EEE) - recast, unless otherwise specified as non-compliant.

Please note that some Vishay documentation may still make reference to RoHS Directive 2002/95/EC. We confirm that all the products identified as being compliant to Directive 2002/95/EC conform to Directive 2011/65/EU.

Vishay Intertechnology, Inc. hereby certifies that all its products that are identified as Halogen-Free follow Halogen-Free requirements as per JEDEC JS709A standards. Please note that some Vishay documentation may still make reference to the IEC 61249-2-21 definition. We confirm that all the products identified as being compliant to IEC 61249-2-21 conform to JEDEC JS709A standards.