

BOARD LEVEL POWER SEMICONDUCTOR HEAT SINKS



217 SERIES Surface Mount Heat Sinks

D²PAK, TO-220, SOT-223, SOL-20

Compatible with surface mount technology (SMT) automated production techniques for ease of assembly and a variety of soldering methods, these heat sinks allow greater packaging densities and reduction in PC-board area, increasing the power dissipation of surface mount devices (SMDs) while maintaining and improving manufacturers' component thermal specifications.

FEATURES AND BENEFITS:

- No interface material is needed
- Copper with matte tin plating for improved solderability and assembly
- Both the component and the heat sink are installed on the PC-board utilizing standard SMT assembly equipment for "Tape & Reel" and "Tube" formats
- EIA standards and ESD protection are specified
- Can be used with water soluble or no clean SMT solder creams or other pastes

| Standard P/N | Height Above PC Board in. (mm) | Footprint Dimensions in. (mm) | Package Format | Package Quantity | Thermal Performance at Typical Load | |
|--------------|--------------------------------|-------------------------------|----------------|------------------|-------------------------------------|--------------------|
| | | | | | Natural Convection | Forced Convection) |
| 217-36CTE6 | .360 (9.1) | .600 (15.2) x .740 (18.8) | Bulk | 1 | 55°C @ 1W | 16.0°C/W @ 200 LFM |
| 217-36CTTE6 | .360 (9.1) | .600 (15.2) x .740 (18.8) | Tube | 20 | 55°C @ 1W | 16.0°C/W @ 200 LFM |
| 217-36CTRE6 | .360 (9.1) | .600 (15.2) x .740 (18.8) | Tape & Reel | 250 | 55°C @ 1W | 16.0°C/W @ 200 LFM |

Material: Copper, Matte Tin Plated

MECHANICAL DIMENSIONS

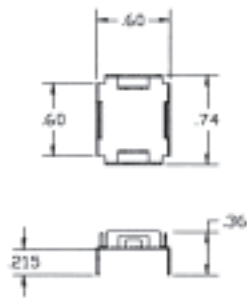

217-36CT6

217 HEAT SINK WITH DDPACK DEVICE

THERMAL PERFORMANCE 6 LAYER BOARD, D²PAK 125°C LEAD, 40°C AMBIENT

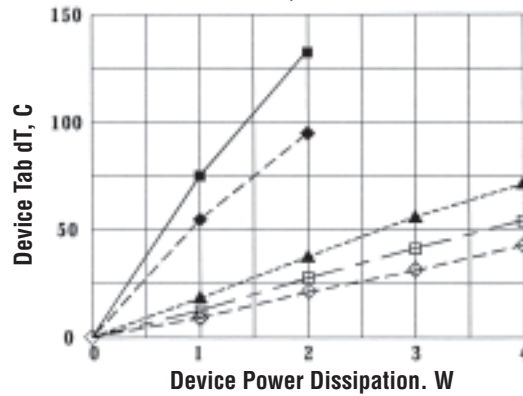

KEY: ■ Device only, NC ◆ Device + HS, NC ▲ Device + HS, 100 lfm □ Device + HS, 200 lfm ◇ Device + HS, 300 lfm

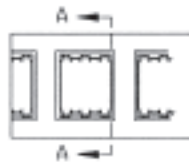

SECTION A-A

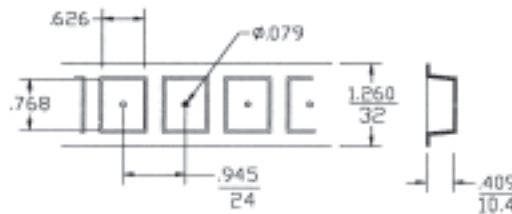

TAPE DETAILS

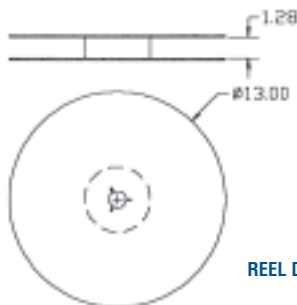

REEL DETAILS

NOTES
1. Material to be "ESD"
2. Approximately 6 Meters per Reel
3. 250 Pieces per Reel.

217-36CTR6

Dimensions: in.

BOARD LEVEL POWER SEMICONDUCTOR HEAT SINKS

217 SERIES

Surface Mount Heat Sinks

D²PAK, TO-220, SOL-20

MECHANICAL DIMENSIONS

217 SERIES

TUBE DETAILS

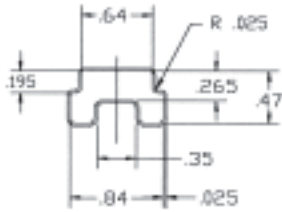

TUBE: 16.25 Inches Long,
Min. ESD Material with Nail
Stops
20 Pieces per Tube

217-36CTT6

Dimensions: in.

BOARD LAYOUT RECOMMENDATIONS

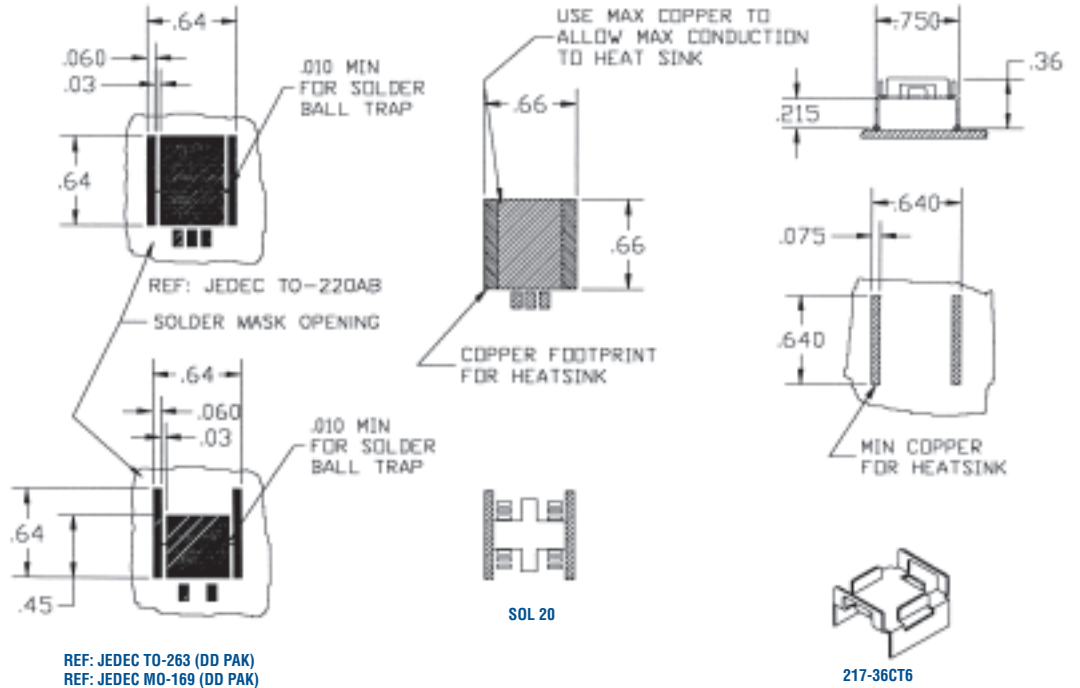

REF: JEDEC TO-263 (DD PAK)
REF: JEDEC MO-169 (DD PAK)

217-36CT6



218 SERIES

Surface Mount Heat Sink

SMT Devices

| Standard P/N | Height Above PC Board in. (mm) | Maximum Footprint in. (mm) | Thermal Performance at Typical Load | |
|--------------|--------------------------------|----------------------------|-------------------------------------|-------------------|
| | | | Natural Convection | Forced Convection |
| 218-40CTE3 | .40 (10.2) | .90 (22.9) x .315 (8.0) | 62°C rise @ 2W | 21°C/W @ 200LFM |
| 218-40CTE5 | .40 (10.2) | 1.03 (26.2) x .50 (12.7) | 62°C rise @ 2W | 21°C/W @ 200LFM |

Material: Copper, Matte Tin Plated

MECHANICAL DIMENSIONS

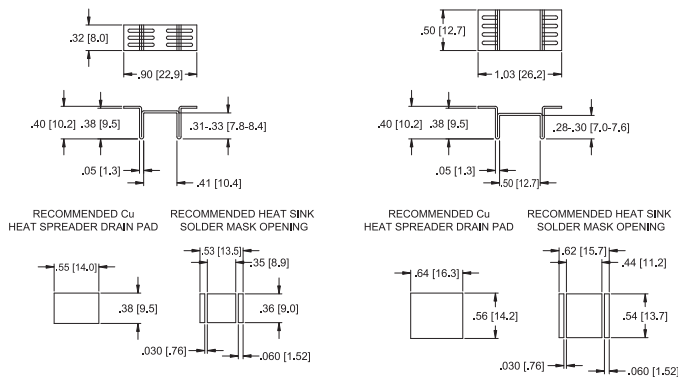

218-40CT3

218-40CT5

NATURAL AND FORCED CONVECTION CHARACTERISTICS

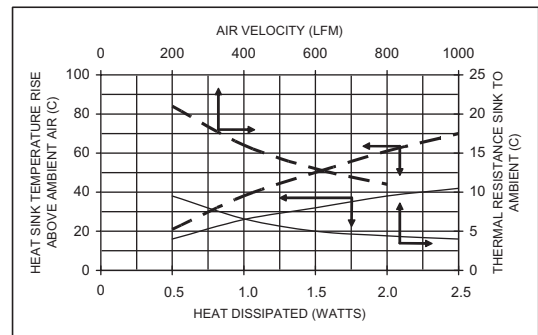

Solid line = 218-40CT5 Dashed Line = 218-40CT3

BOARD LEVEL POWER SEMICONDUCTOR HEAT SINKS



206 SERIES

Vertical Mount Heat Sink

TO-220

| Standard P/N | Height Above PC Board in. (mm) | Maximum Footprint in. (mm) | Thermal Performance at Typical Load | |
|--------------|--------------------------------|----------------------------|-------------------------------------|-------------------|
| | | | Natural Convection | Forced Convection |
| 206-1PABEH | 1.18 (30.0) | 1.00 (25.4) x .50 (12.7) | 56°C rise @ 4W | 7.3°C/W @ 200LFM |

Material: Aluminum, Black Anodized

MECHANICAL DIMENSIONS

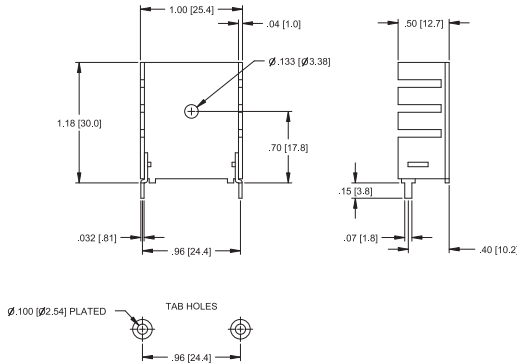

NATURAL AND FORCED CONVECTION CHARACTERISTICS

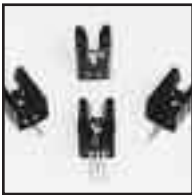
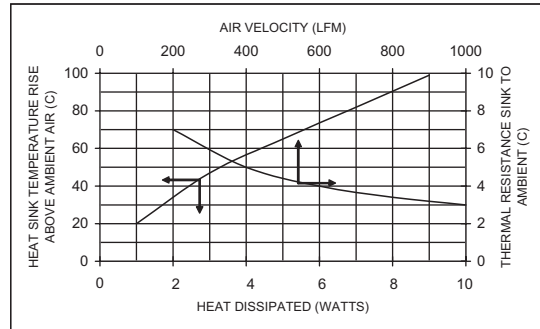

230 & 234 SERIES

Compact, Wavesolderable Low-Profile Self-Locking Heat Sinks

TO-220

| Standard P/N | Height Above PC Board in. (mm) | Footprint Dimensions in. (mm) | Mounting Configuration | Solderable Tab Option | Mounting Style | Thermal Performance at Typical Load | |
|--------------|--------------------------------|-------------------------------|------------------------|-----------------------|----------------|-------------------------------------|-------------------|
| | | | | | | Natural Convection | Forced Convection |
| 230-75AB | .750 (19.1) | .570 (14.5) x .500 (12.7) | Vert./Horiz. | No Tab | Clip/Mtg Hole | 57°C @ 2W | 7.5°C/W @ 400 LFM |
| 230-75ABE-01 | .750 (19.1) | .570 (14.5) x .500 (12.7) | Vertical | 01 | Clip/Mtg Hole | 57°C @ 2W | 7.5°C/W @ 400 LFM |
| 230-75ABE-05 | .500 (12.7) | .750 (19.1) x .570 (14.5) | Horizontal | 05 | Clip/Mtg Hole | 57°C @ 2W | 7.5°C/W @ 400 LFM |
| 230-75ABE-10 | .875 (22.2) | .570 (14.5) x .500 (12.7) | Vertical | 10 | Clip/Mtg Hole | 57°C @ 2W | 7.5°C/W @ 400 LFM |
| 234-75AB | .790 (20.0) | .570 (14.5) x .500 (12.7) | Vert./Horiz. | No Tab | Clip/Mtg Hole | 57°C @ 2W | 7.5°C/W @ 400 LFM |
| 234-75ABE-01 | .790 (20.0) | .570 (14.5) x .500 (12.7) | Vertical | 01 | Clip/Mtg Hole | 57°C @ 2W | 7.5°C/W @ 400 LFM |
| 234-75ABE-05 | .500 (12.7) | .790 (20.0) x .570 (14.5) | Horizontal | 05 | Clip/Mtg Hole | 57°C @ 2W | 7.5°C/W @ 400 LFM |

Material: Aluminum, Black Anodized

MECHANICAL DIMENSIONS

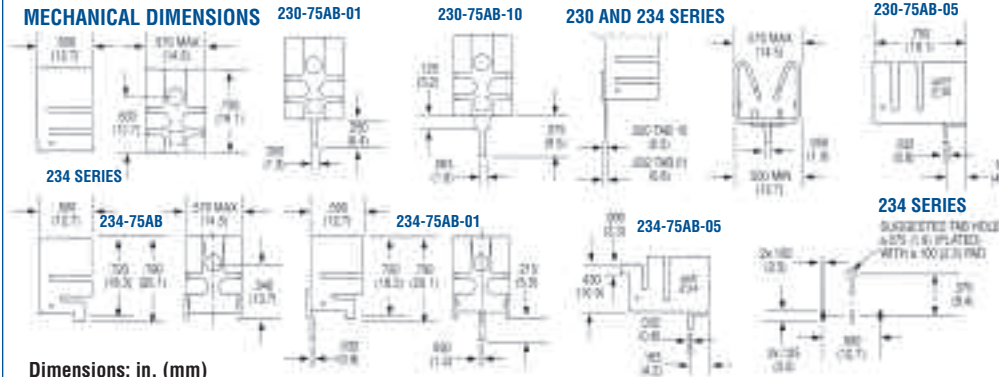

Dimensions: in. (mm)

NATURAL AND FORCED CONVECTION CHARACTERISTICS

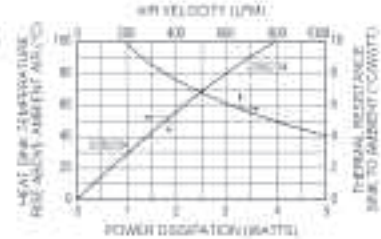

BOARD LEVEL POWER SEMICONDUCTOR HEAT SINKS



241 SERIES Horizontal Mount Heat Sink

TO-220

| Standard P/N | Height Above PC Board in. (mm) | Maximum Footprint in. (mm) | Thermal Performance at Typical Load | |
|--------------|--------------------------------|----------------------------|-------------------------------------|-------------------|
| | | | Natural Convection | Forced Convection |
| 241-69ABE-03 | .39 (9.9) | .86 (21.8) x .69 (17.5) | 77°C rise @ 4W | 12°C/W @ 200LFM |

Material: Aluminum, Black Anodized

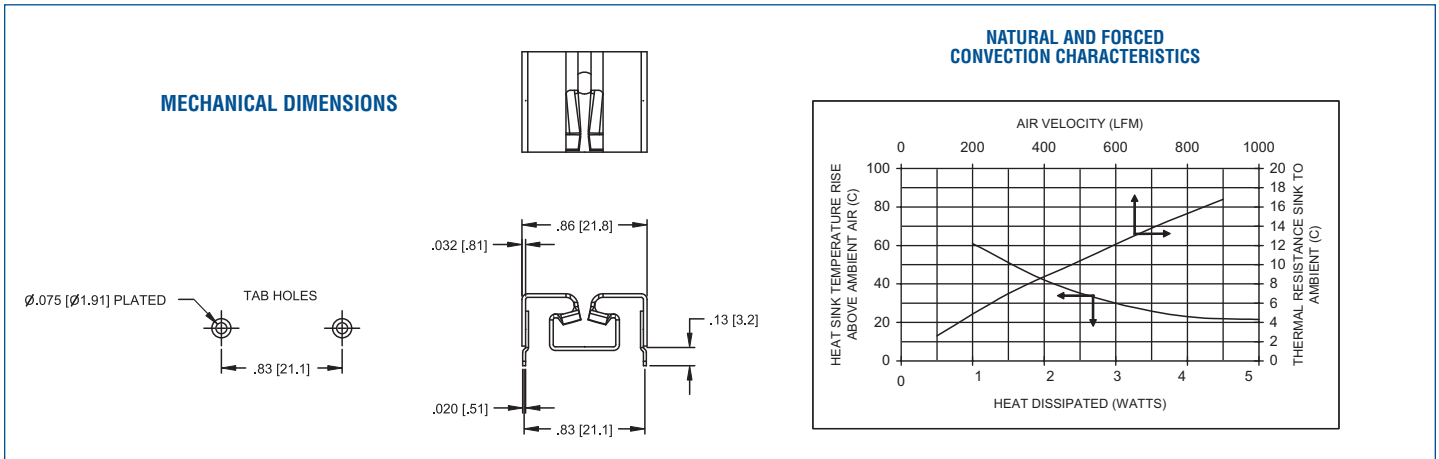

262 SERIES Horizontal and Vertical Mount Heat Sink

TO-220

| Standard P/N | Height Above PC Board in. (mm) | Maximum Footprint in. (mm) | Thermal Performance at Typical Load | |
|--------------|--------------------------------|----------------------------|-------------------------------------|-------------------|
| | | | Natural Convection | Forced Convection |
| 262-75ABE-05 | .53 (13.4) | .75 (19.1) x .50 (12.78) | 80°C rise @ 2W | 10°C/W @ 200LFM |
| 262-75ABE-01 | .75 (19.1) | .53 (13.4) x .50 (12.7) | 80°C rise @ 2W | 10°C/W @ 200LFM |

Material: Aluminum, Black Anodized

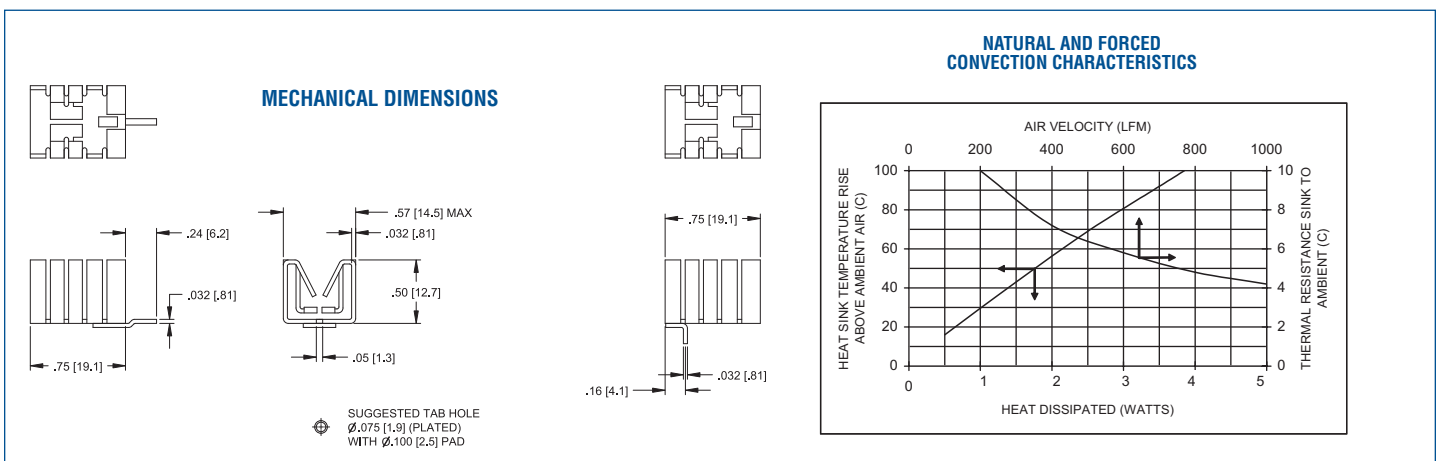

BOARD LEVEL POWER SEMICONDUCTOR HEAT SINKS



233 & 236 SERIES

Self-Locking Wavesolderable Heat Sinks

TO-220

| Standard P/N | Height Above PC Board in. (mm) | Footprint Dimensions in. (mm) | Mounting Configuration | Solderable Tab Options | Mounting Style | Thermal Performance at Typical Load | |
|---------------|--------------------------------|-------------------------------|------------------------|------------------------|----------------|-------------------------------------|--------------------|
| | | | | | | Natural Convection | Forced Convection |
| 233-60AB | .600 (15.2) | .570 (14.5) x .500 (12.7) | Vert./Horiz. | No Tab | Clip/Mtg Hole | 58°C @ 2W | 11.0°C/W @ 400 LFM |
| 233-60ABE-01 | .600 (15.2) | .570 (14.5) x .500 (12.7) | Vertical | 01 | Clip/Mtg Hole | 58°C @ 2W | 11.0°C/W @ 400 LFM |
| 233-60ABE-05 | .500 (12.7) | .600 (15.2) x .570 (14.5) | Horizontal | 05 | Clip/Mtg Hole | 58°C @ 2W | 11.0°C/W @ 400 LFM |
| 233-60ABE-10 | .725 (18.4) | .570 (14.5) x .500 (12.7) | Vertical | 10 | Clip/Mtg Hole | 58°C @ 2W | 11.0°C/W @ 400 LFM |
| 236-150AB | 1.500 (38.1) | .570 (14.5) x .500 (12.7) | Vert./Horiz. | No Tab | Clip/Mtg Hole | 40°C @ 2W | 4.80°C/W @ 400 LFM |
| 236-150ABE-01 | 1.500 (38.1) | .570 (14.5) x .500 (12.7) | Vertical | 01 | Clip/Mtg Hole | 40°C @ 2W | 4.80°C/W @ 400 LFM |
| 236-150ABE-05 | .500 (12.7) | 1.500 (38.1) x .570 (14.5) | Horizontal | 05 | Clip/Mtg Hole | 40°C @ 2W | 4.80°C/W @ 400 LFM |
| 236-150ABE-10 | 1.625 (41.3) | .570 (14.5) x .570 (12.7) | Vertical | 10 | Clip/Mtg Hole | 40°C @ 2W | 4.80°C/W @ 400 LFM |

Material: Aluminum, Black Anodized

MECHANICAL DIMENSIONS 233 AND 236 SERIES

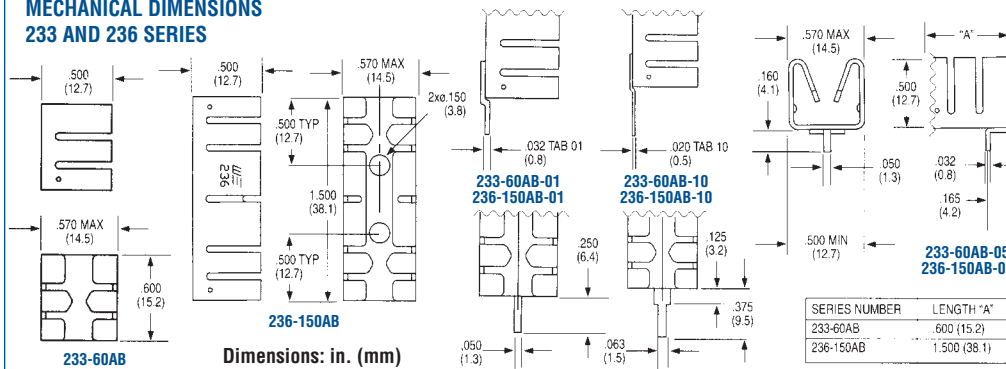

NATURAL AND FORCED CONVECTION CHARACTERISTICS

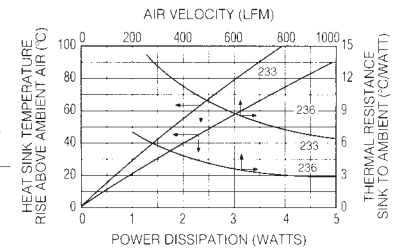

SUGGESTED TAB HOLE =
0.075 (1.9) (PLATED)
WITH 0.100 (2.5) PAD



275 & 231 SERIES

Compact, Stress-Free Labor-Saving Locking-Tab Heat Sinks

TO-220

| Standard P/N | Height Above PC Board in. (mm) | Footprint Dimensions in. (mm) | Mounting Configuration | Solderable Tab Options | Mounting Style | Thermal Performance at Typical Load | |
|-----------------|--------------------------------|-------------------------------|------------------------|------------------------|----------------|-------------------------------------|-------------------|
| | | | | | | Natural Convection | Forced Convection |
| 275-75AB | .750 (19.1) | .835 (21.2) x .400 (12.7) | Vert./Horiz. | No Tab | Clip/Mtg Hole | 44 C @ 2W | 7.9°C/W @ 400 LFM |
| 275-75ABE-01 | .750 (19.1) | .835 (21.2) x .400 (12.7) | Vertical | 01 | Clip/Mtg Hole | 44°C @ 2W | 7.9°C/W @ 400 LFM |
| 275-75ABE-10 | .875 (12.7) | .835 (21.2) x .400 (14.5) | Vertical | 10 | Clip/Mtg Hole | 44°C @ 2W | 7.9°C/W @ 400 LFM |
| 231-69PAB | .690 (18.4) | .835 (21.2) x .400 (12.7) | Vert./Horiz. | No Tab | Clip/Mtg Hole | 45°C @ 2W | 8°C/W @ 400 LFM |
| 231-69PABE | .400 (10.1) | .690 (17.5) x .835 (12.7) | Horizontal | 13H | Clip/Mtg Hole | 45°C @ 2W | 8°C/W @ 400 LFM |
| 231-69PABE-XXX | .690 (17.5) | .835 (21.2) x .400 (12.7) | Vertical | 13V, 14V, 15V | Clip/Mtg Hole | 45°C @ 2W | 8°C/W @ 400 LFM |
| 231-75PAB | .750 (19.1) | .835 (21.2) x .400 (14.5) | Vert./Horiz. | No Tab | Clip/Mtg Hole | 43°C @ 2W | 7.9°C/W @ 400 LFM |
| 231-75PABE | .400 (10.1) | .750 (19.1) x .835 (12.7) | Horizontal | 13H | Clip/Mtg Hole | 43°C @ 2W | 7.9°C/W @ 400 LFM |
| 231-75PABE-XXX | .750 (19.1) | .835 (21.2) x .400 (12.7) | Vertical | 13V, 14V, 15V | Clip/Mtg Hole | 43°C @ 2W | 7.9°C/W @ 400 LFM |
| 231-137PAB | 1.375 (35) | .835 (21.2) x .400 (12.7) | Vert./Horiz. | No Tab | Clip/Mtg Hole | 32°C @ 2W | 5.9°C/W @ 400 LFM |
| 231-137PABE | .400 (10.2) | 1.375 (34.9) x .835 (12.7) | Horizontal | 13H | Clip/Mtg Hole | 32°C @ 2W | 5.9°C/W @ 400 LFM |
| 231-137PABE-XXX | 1.375 (35) | .835 (21.2) x .400 (12.7) | Vertical | 13V, 14V, 15V | Clip/Mtg Hole | 32°C @ 2W | 5.9°C/W @ 400 LFM |

Material: Aluminum, Pre-anodized Black (PAB), Anodized Black (AB)

MECHANICAL DIMENSIONS

Dimple on 231-69, 275-75 Series only

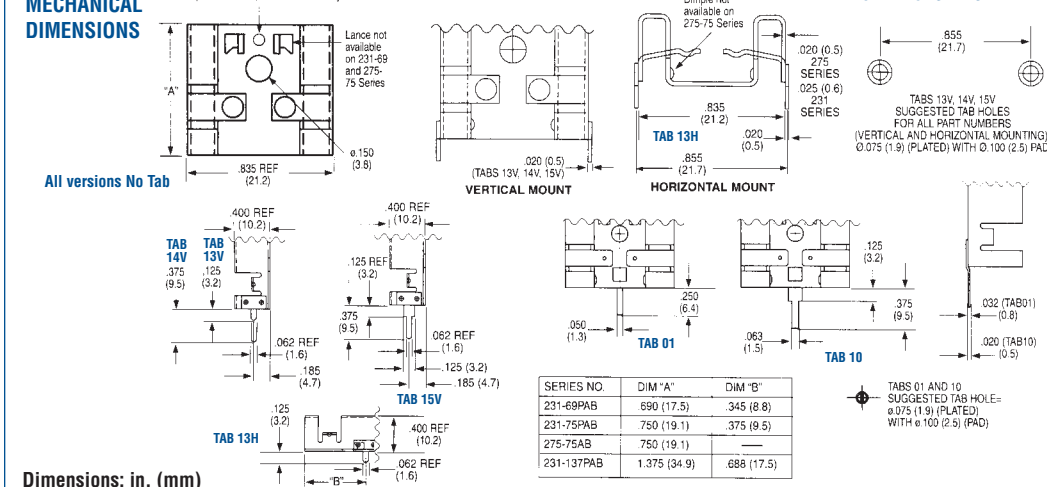

NATURAL AND FORCED CONVECTION CHARACTERISTICS

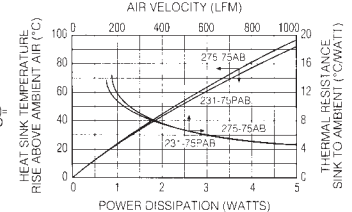

NATURAL AND FORCED CONVECTION CHARACTERISTICS

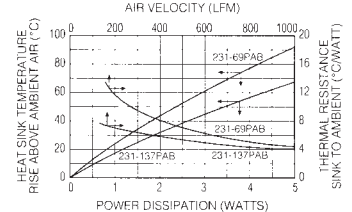

BOARD LEVEL POWER SEMICONDUCTOR HEAT SINKS



PATENT 5381041

235 SERIES

Compact, Stress-Free Labor-Saving Locking-Tab Heat Sinks

TO-220

| Standard P/N | Height Above PC Board in. (mm) | Footprint Dimensions in. (mm) | Mounting Configuration | Solderable Tab Options | Mounting Style | Thermal Performance at Typical Load | |
|--------------|--------------------------------|-------------------------------|------------------------|------------------------|----------------|-------------------------------------|-------------------|
| | | | | | | Natural Convection | Forced Convection |
| 235-85AB | .850 (21.6) | 1.000 (25.4) x .500 (12.7) | Vert./Horiz. | No Tab | Clip/Mtg Hole | 40°C @ 2W | 6.8°C/W @ 400 LFM |
| 235-85ABE-01 | .850 (21.6) | 1.000 (25.4) x .500 (12.7) | Vertical | 01 | Clip/Mtg Hole | 40°C @ 2W | 6.8°C/W @ 400 LFM |
| 235-85ABE-05 | .500 (12.7) | .850 (21.6) x 1.000 (25.4) | Horizontal | 05 | Clip/Mtg Hole | 40°C @ 2W | 6.8°C/W @ 400 LFM |
| 235-85ABE-10 | .975 (24.8) | 1.000 (25.4) x .500 (12.7) | Vertical | 10 | Clip/Mtg Hole | 40°C @ 2W | 6.8°C/W @ 400 LFM |

Material: Aluminum, Black Anodized

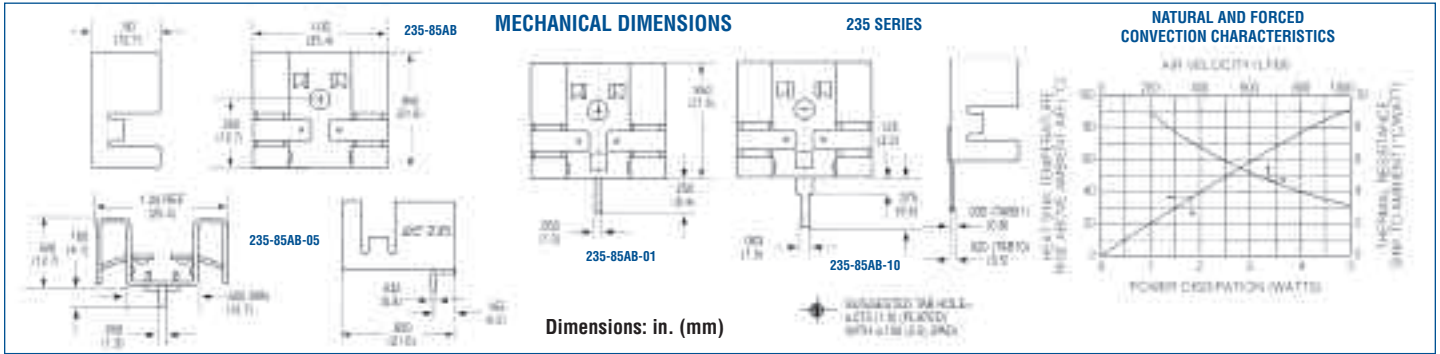

243 SERIES

Labor-Saving Clip-On Heat Sinks

TO-220

| Standard P/N | Height Above PC Board in. (mm) | Footprint Dimensions in. (mm) | Mounting Configuration | Solderable Tab Options | Mounting Style | Thermal Performance at Typical Load | |
|--------------|--------------------------------|-------------------------------|------------------------|------------------------|----------------|-------------------------------------|-------------------|
| | | | | | | Natural Convection | Forced Convection |
| 243-1PAB | 1.000 (25.4) | .800 (20.3) x .270 (6.9) | Vert./Horiz. | No Tab | Clip | 50°C @ 2W | 4.5°C/W @ 400 LFM |
| 243-3PAB | .800 (20.3) | .800 (20.3) x .270 (6.9) | Vert./Horiz. | No Tab | Clip | 78°C @ 2W | 8.2°C/W @ 400 LFM |

Material: Aluminum, Pre-anodized Black

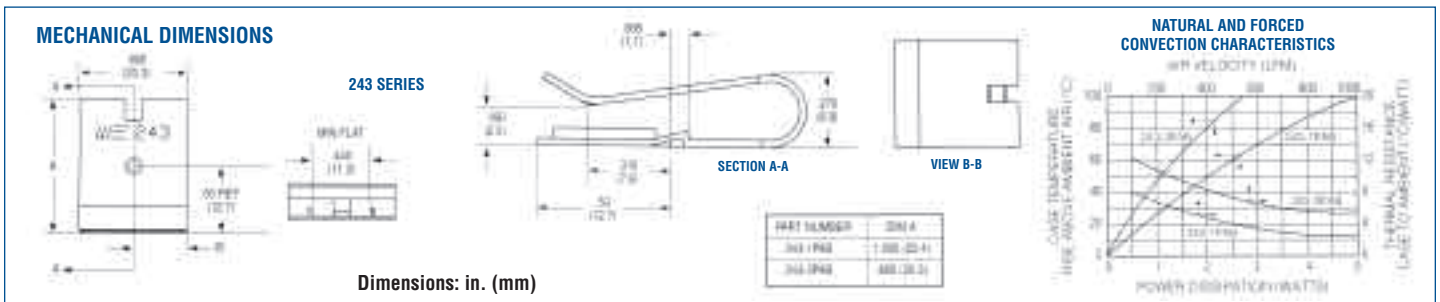

PATENT PENDING

239 SERIES

Snap-Down Self-Locking Heat Sinks

TO-220

| Standard P/N | Height Above PC Board in. (mm) | Footprint Dimensions in. (mm) | Mounting Configuration | Solderable Tab Options | Mounting Style | Thermal Performance at Typical Load | |
|--------------|--------------------------------|-------------------------------|------------------------|------------------------|----------------|-------------------------------------|-------------------|
| | | | | | | Natural Convection | Forced Convection |
| 239-75AB | .750 (19.1) | 1.120 (28.4) x .435 (11.0) | Vert./Horiz | No Tab | Clip/Mtg Hole | 38°C @ 2W | 6°C/W @ 400 LFM |
| 239-75ABE-03 | .750 (19.1) | 1.120 (28.4) x .435 (11.0) | Vertical | 03 | Clip/Mtg Hole | 38°C @ 2W | 6°C/W @ 400 LFM |
| 239-75ABE-04 | .750 (19.1) | 1.120 (28.4) x .435 (11.0) | Vertical | 04 | Clip/Mtg Hole | 38°C @ 2W | 6°C/W @ 400 LFM |

Material: Aluminum, Black Anodized

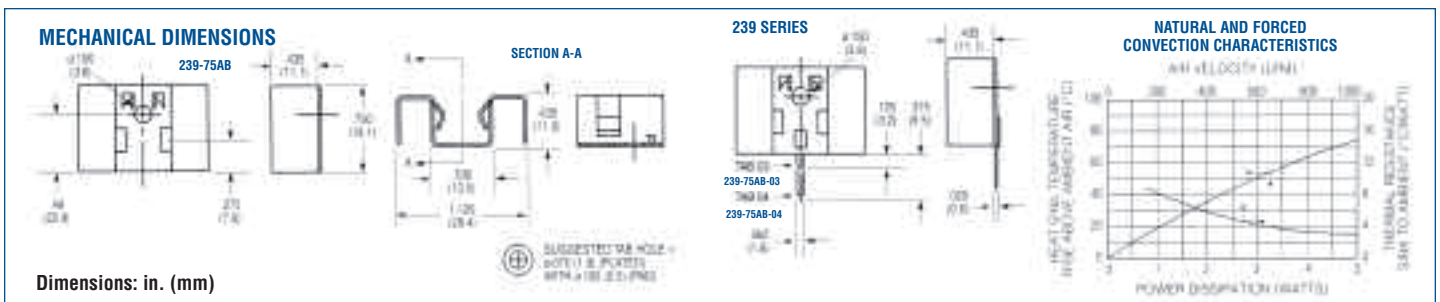

BOARD LEVEL POWER SEMICONDUCTOR HEAT SINKS



265 SERIES

Vertical Mount Heat Sink

TO-220

| Standard P/N | Height Above PC Board in. (mm) | Maximum Footprint in. (mm) | Thermal Performance at Typical Load | |
|----------------|--------------------------------|----------------------------|-------------------------------------|-------------------|
| | | | Natural Convection | Forced Convection |
| 265-118ABHE-22 | 1.18 (30.0) | 1.00 (25.4) x .50 (12.7) | 56°C rise @ 4W | 7.0°C/W @ 200LFM |

Material: Aluminum, Black Anodized

MECHANICAL DIMENSIONS

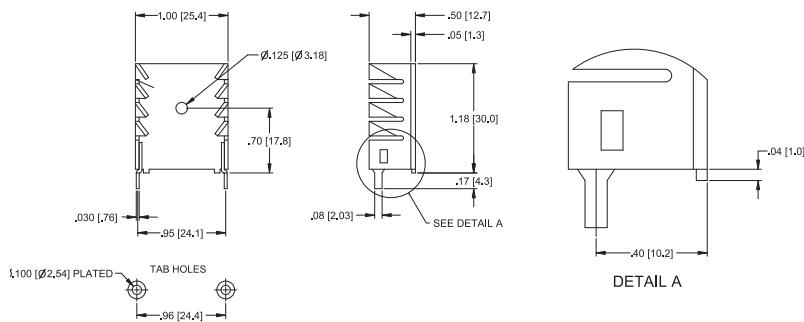

NATURAL AND FORCED CONVECTION CHARACTERISTICS

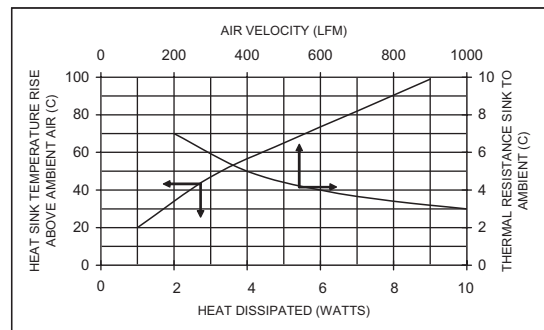

286DB SERIES

Vertical Mount Heat Sink

TO-220

| Standard P/N | Height Above PC Board in. (mm) | Maximum Footprint in. (mm) | Thermal Performance at Typical Load | |
|--------------|--------------------------------|----------------------------|-------------------------------------|-------------------|
| | | | Natural Convection | Forced Convection |
| 286DBE | .95 (24.1) | 1.00 (25.4) x .50 (12.7) | 65°C rise @ 4W | 9.0°C/W @ 200LFM |

Material: Aluminum, Black Anodized

MECHANICAL DIMENSIONS

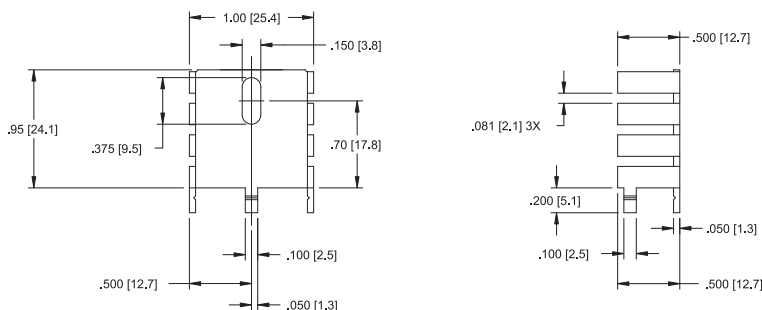

NATURAL AND FORCED CONVECTION CHARACTERISTICS

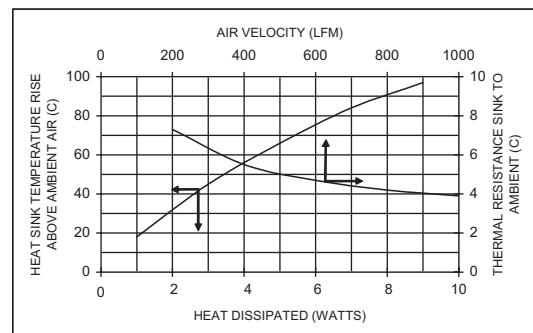

BOARD LEVEL POWER SEMICONDUCTOR HEAT SINKS



273 SERIES Low-Cost, Low-Height Wavesolderable Heat Sinks

TO-218, TO-220

| Standard P/N | Height Above PC Board in. (mm) | Footprint Dimensions in. (mm) | Mounting Configuration | Solderable Tab Options | Mounting Style | Thermal Performance at Typical Load Natural Convection | Thermal Performance at Typical Load Forced Convection |
|--------------|--------------------------------|-------------------------------|------------------------|------------------------|----------------|--|---|
| 273-AB | .375 (9.5) | .750 (19.1) x .750 (19.1) | Vert./Horiz. | No Tab | Mtg Hole | 49°C @ 2W | 7.2°C/W @ 400 LFM |
| 273-ABE-01 | .375 (9.5) | .750 (19.1) x .750 (19.1) | Vertical | 01 | Mtg Hole | 49°C @ 2W | 7.2°C/W @ 400 LFM |
| 273-ABE-02 | .375 (9.5) | .750 (19.1) x .750 (19.1) | Vertical | 02 | Mtg Hole | 49°C @ 2W | 7.2°C/W @ 400 LFM |

Material: Aluminum, Black Anodized

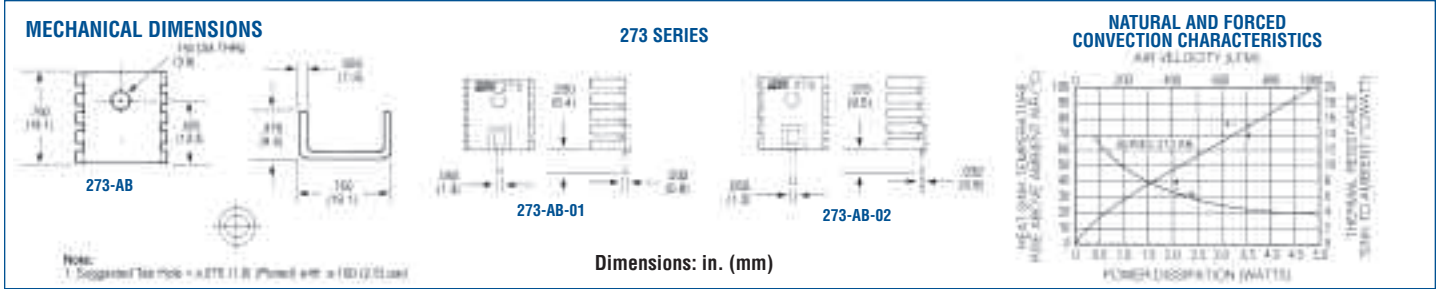

274 & 281 SERIES Low-Cost, Low-Height Wavesolderable Heat Sinks

TO-220

| Standard P/N | Height Above PC Board in. (mm) | Footprint Dimensions in. (mm) | Mounting Configuration | Solderable Tab Options | Mounting Style | Thermal Performance at Typical Load Natural Convection | Thermal Performance at Typical Load Forced Convection |
|--------------|--------------------------------|-------------------------------|------------------------|------------------------|----------------|--|---|
| 274-1AB | .375 (9.5) | .520 (13.2) x .750 (19.1) | Vert./Horiz. | No Tab | Mtg Hole | 56°C @ 2W | 8.0°C/W @ 400 LFM |
| 274-1ABE-01 | .375 (9.5) | .520 (13.2) x .750 (19.1) | Vertical | 01 | Mtg Hole | 56°C @ 2W | 8.0°C/W @ 400 LFM |
| 274-1ABE-02 | .375 (9.5) | .520 (13.2) x .750 (19.1) | Vertical | 02 | Mtg Hole | 56°C @ 2W | 8.0°C/W @ 400 LFM |
| 274-2AB | .500 (12.7) | .520 (13.2) x .750 (19.1) | Vert./Horiz. | No Tab | Mtg Hole | 50°C @ 2W | 7.0°C/W @ 400 LFM |
| 274-2ABE-01 | .500 (12.7) | .520 (13.2) x .750 (19.1) | Vertical | 01 | Mtg Hole | 50°C @ 2W | 7.0°C/W @ 400 LFM |
| 274-2ABE-02 | .500 (12.7) | .520 (13.2) x .750 (19.1) | Vertical | 02 | Mtg Hole | 50°C @ 2W | 7.0°C/W @ 400 LFM |
| 274-3AB | .250 (6.4) | .520 (13.2) x .750 (19.1) | Vert./Horiz. | No Tab | Mtg Hole | 62°C @ 2W | 9.0°C/W @ 400 LFM |
| 274-3ABE-01 | .250 (6.4) | .520 (13.2) x .750 (19.1) | Vertical | 01 | Mtg Hole | 62°C @ 2W | 9.0°C/W @ 400 LFM |
| 274-3ABE-02 | .250 (6.4) | .520 (13.2) x .750 (19.1) | Vertical | 02 | Mtg Hole | 62°C @ 2W | 9.0°C/W @ 400 LFM |
| 281-1AB | .375 (9.5) | .520 (13.2) x .750 (19.1) | Vertical | No Tab | Mtg Hole | 56°C @ 2W | 8.0°C/W @ 400 LFM |
| 281-2AB | .500 (12.7) | .520 (13.2) x .750 (19.1) | Vertical | No Tab | Mtg Hole | 50°C @ 2W | 7.0°C/W @ 400 LFM |

Material: Aluminum, Black Anodized

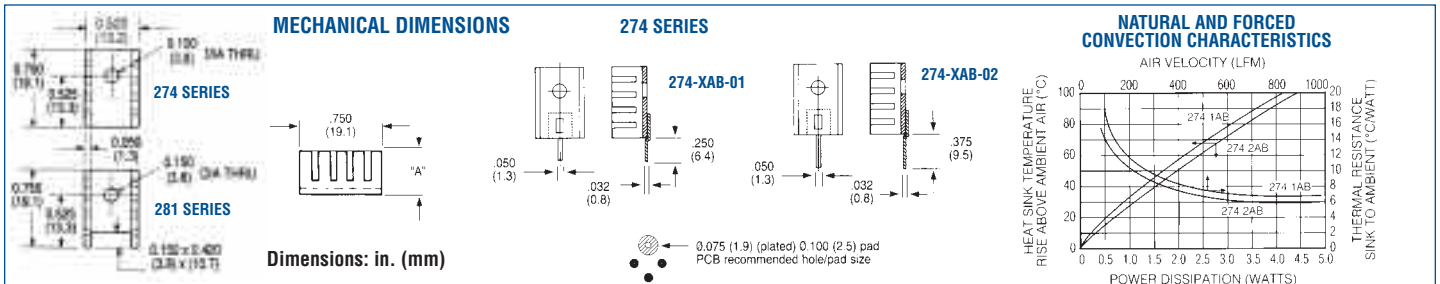

240 SERIES Labor-Saving Twisted Fin Heat Sinks

TO-220

| Standard P/N | Height Above PC Board in. (mm) | Footprint Dimensions in. (mm) | Mounting Configuration | Solderable Tab Options | Mounting Style | Thermal Performance at Typical Load Natural Convection | Thermal Performance at Typical Load Forced Convection |
|----------------|--------------------------------|-------------------------------|------------------------|------------------------|----------------|--|---|
| 240-118ABEH-22 | 1.180 (30.0) | 1.000 (25.4) x .500 (12.7) | Vertical | 22 | Clip/Mtg Hole | 55°C @ 4W | 5.3°C/W @ 400 LFM |
| 240-118ABES-22 | 1.180 (30.0) | 1.000 (25.4) x .500 (12.7) | Vertical | 22 | Clip/Mtg Slot | 55°C @ 4W | 5.3°C/W @ 400 LFM |

Material: Aluminum, Black Anodized

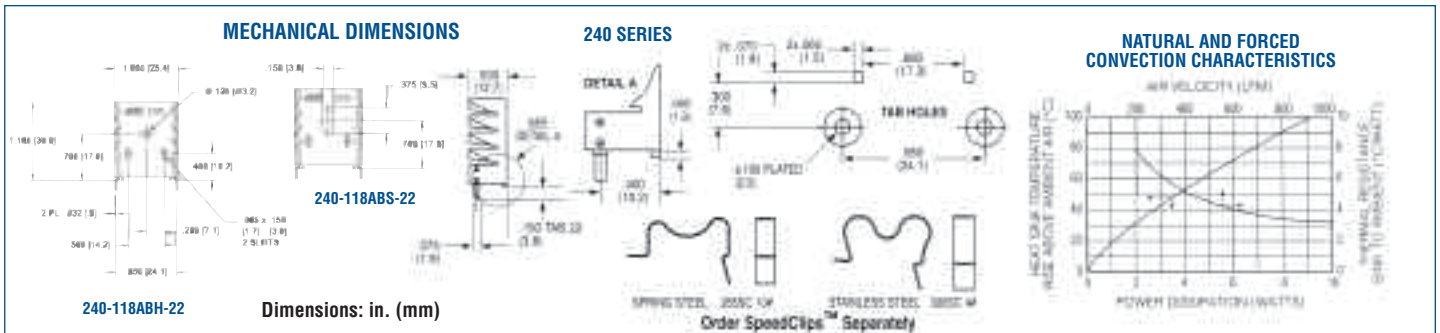

BOARD LEVEL POWER SEMICONDUCTOR HEAT SINKS



242 SERIES

Low-Height, Low-Profile Twisted Fin Heat Sinks

TO-220

| Standard P/N | Height Above PC Board in. (mm) | Footprint Dimensions in. (mm) | Mounting Configuration | Solderable Tab Options | Mounting Style | Thermal Performance at Typical Load | |
|---------------|--------------------------------|-------------------------------|------------------------|------------------------|----------------|-------------------------------------|-------------------|
| | | | | | | Natural Convection | Forced Convection |
| 242-125ABE-22 | 1.285 (32.6) | .875 (22.2) x .250 (6.4) | Vertical | 22 | Mtg Hole | 48°C @ 2W | 6.2°C/W @ 400 LFM |

Material: Aluminum, Black Anodized

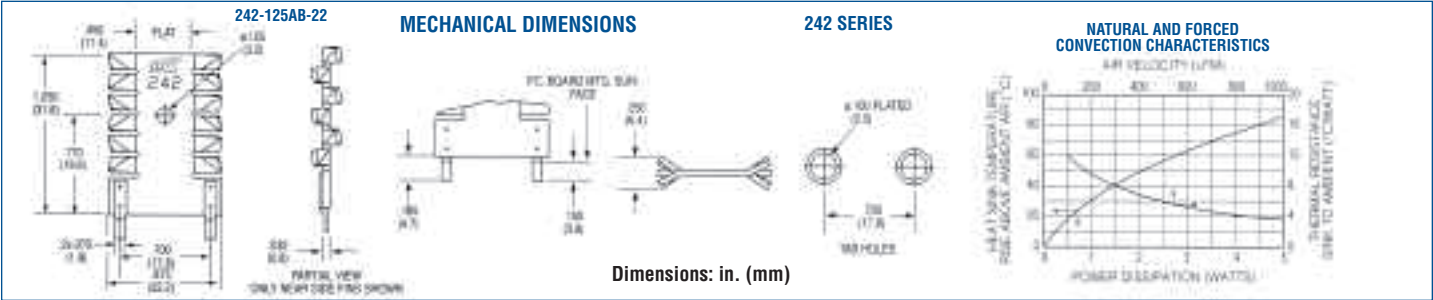

232 & 238 SERIES

Staggered Fin Heat Sinks for Vertical Mounting

TO-202, TO-220

| Standard P/N | Height Above PC Board in. (mm) | Footprint Dimensions in. (mm) | Mounting Configuration | Solderable Tab Options | Mounting Style | Thermal Performance at Typical Load | |
|---------------|--------------------------------|-------------------------------|------------------------|------------------------|----------------|-------------------------------------|-------------------|
| | | | | | | Natural Convection | Forced Convection |
| 232-200AB | 2.000 (50.8) | 1.380 (35.1) x .500 (12.7) | Vertical | 2, Twisted | Clip/Mtg Hole | 48°C @ 4W | 3.3°C/W @ 400 LFM |
| 232-200ABE-23 | 2.000 (50.8) | 1.380 (35.1) x .500 (12.7) | Vertical | 2, Solderable | Clip/Mtg Hole | 48°C @ 4W | 3.3°C/W @ 400 LFM |
| 238-200AB | 2.000 (50.8) | 1.380 (35.1) x .500 (12.7) | Vertical | 2, Twisted | Mtg Slot | 48°C @ 4W | 3.3°C/W @ 400 LFM |
| 238-200ABE-23 | 2.000 (50.8) | 1.380 (35.1) x .500 (12.7) | Vertical | 2, Solderable | Mtg Slot | 48°C @ 4W | 3.3°C/W @ 400 LFM |

Material: Aluminum, Black Anodized

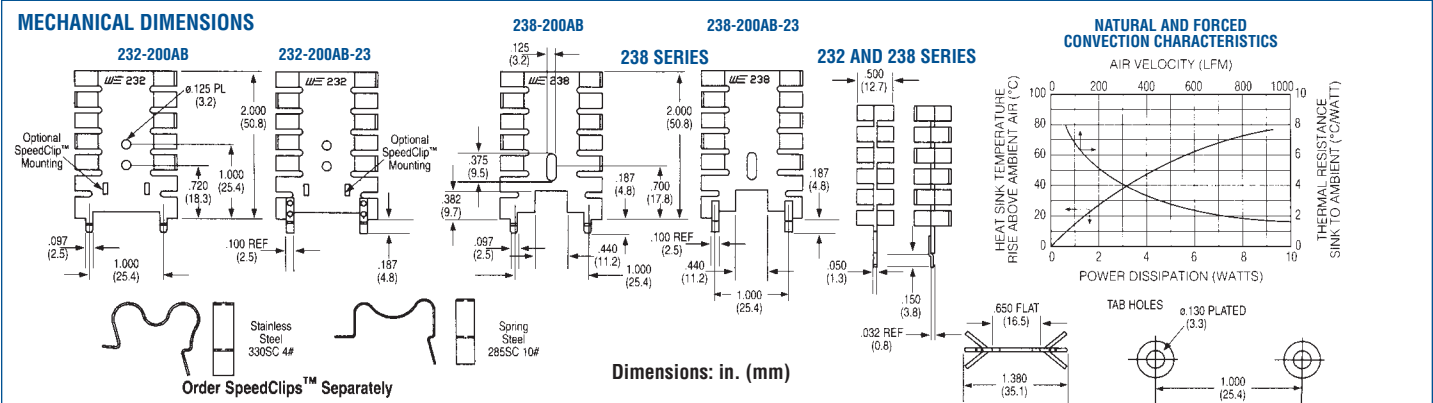

251 SERIES

Slim-Profile Heat Sinks With Integral Clips

15 Lead Multiwat

| Standard P/N | Height Above PC Board in. (mm) | Footprint Dimensions in. (mm) | Mounting Configuration | Solderable Tab Options | Mounting Style | Thermal Performance at Typical Load | |
|--------------|--------------------------------|-------------------------------|------------------------|------------------------|----------------|-------------------------------------|-------------------|
| | | | | | | Natural Convection | Forced Convection |
| 251-62AB | .620 (15.7) | .910 (23.1) x .380 (9.7) | Vert./Horiz. | No Tab | Clip | 66°C @ 3W | 66°C/W @ 400 LFM |
| 251-80AB | .845 (21.5) | .910 (23.1) x .380 (9.7) | Vert./Horiz. | No Tab | Clip | 64°C @ 3W | 66°C/W @ 400 LFM |
| 251-80ABE-19 | .875 (22.2) | .910 (23.1) x .380 (9.7) | Vertical | 19 | Clip | 64°C @ 3W | 66°C/W @ 400 LFM |

Material: Aluminum, Black Anodized

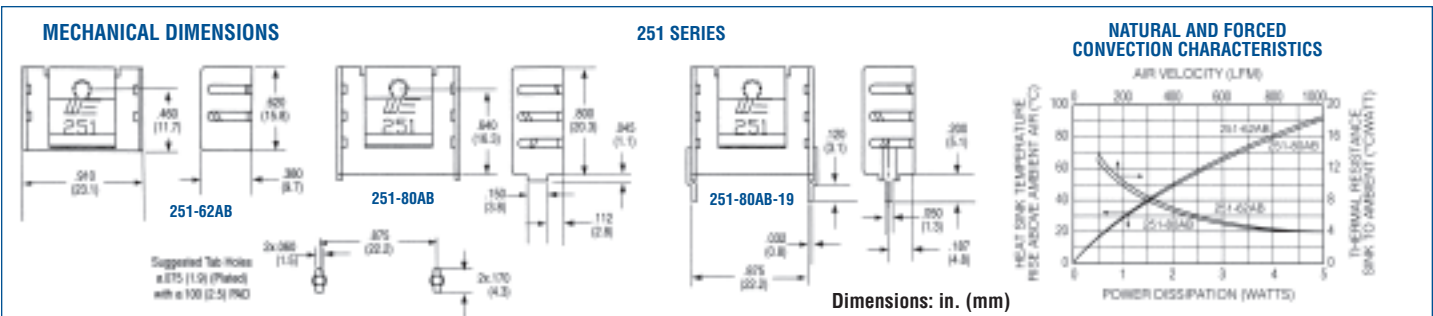

BOARD LEVEL HEAT SINKS FOR TO-220, TO-218 AND MULTIWATT™ COMPONENTS



244 SERIES Low Height, Slim Profile Wavesolderable Folded Fin Heat Sinks

MULTIWATT

| Standard P/N | Height Above PC Board in. (mm) | Footprint Dimensions in. (mm) | Mounting Configuration | Solderable Tab Options | Thermal Performance at Typical Load | | Weight lbs. (grams) |
|---------------|--------------------------------|-------------------------------|------------------------|------------------------|-------------------------------------|-------------------|---------------------|
| | | | | | Natural Convection | Forced Convection | |
| 244-145AB | 1.450 (36.8) | 1.300 (33.0) x 480 (12.1) | Vert./Horiz. | No Tab | 44°C @ 4W | 4.4°C/W @ 400 LFM | .0160 (7.25) |
| 244-145ABE-50 | 1.650 (41.9) | 1.300 (33.0) x 480 (12.1) | Vertical | 50 | 44°C @ 4W | 4.4°C/W @ 400 LFM | .0170 (7.20) |

Material: Aluminum, Black Anodized

MECHANICAL DIMENSIONS

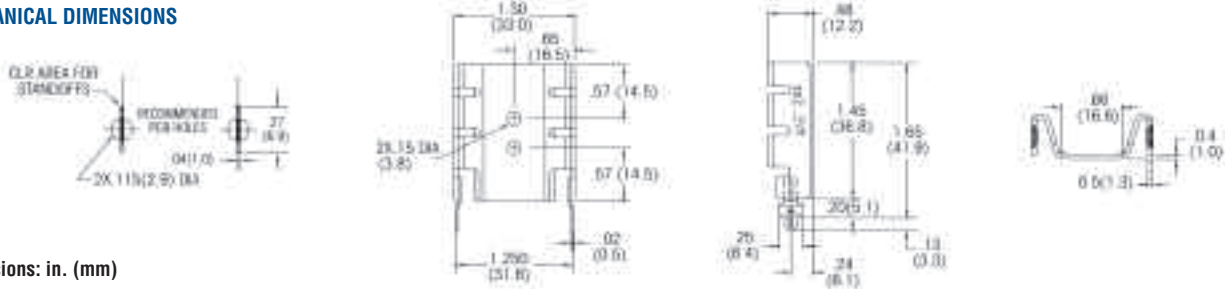

245 SERIES Low Height, Slim Profile Wavesolderable Folded Fin Heat Sinks

MULTIWATT

| Standard P/N | Height Above PC Board in. (mm) | Footprint Dimensions in. (mm) | Mounting Configuration | Solderable Tab Options | Thermal Performance at Typical Load | | Weight lbs. (grams) |
|---------------|--------------------------------|-------------------------------|------------------------|------------------------|-------------------------------------|-------------------|---------------------|
| | | | | | Natural Convection | Forced Convection | |
| 245-145AB | 1.450 (36.8) | 1.750 (44.5) x .380 (9.7) | Vert./Horiz. | No Tab | 38°C @ 4W | 3.2°C/W @ 400 LFM | .0160 (7.25) |
| 245-145ABE-50 | 1.650 (41.9) | 1.750 (44.5) x .380 (9.7) | Vertical | 50 | 38°C @ 4W | 3.2°C/W @ 400 LFM | .0170 (7.20) |

Material: Aluminum, Black Anodized

MECHANICAL DIMENSIONS

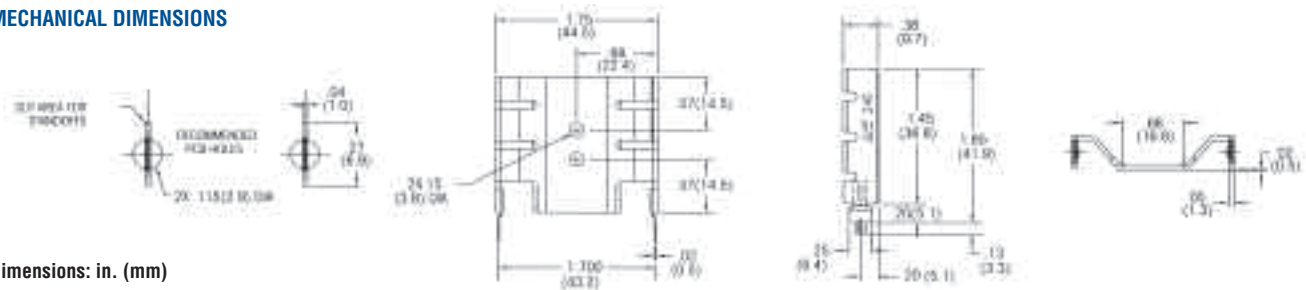

246 SERIES Medium Height, Slim Profile Wavesolderable Folded Fin Heat Sinks

MULTIWATT

| Standard P/N | Height Above PC Board in. (mm) | Footprint Dimensions in. (mm) | Mounting Configuration | Solderable Tab Options | Thermal Performance at Typical Load | | Weight lbs. (grams) |
|---------------|--------------------------------|-------------------------------|------------------------|------------------------|-------------------------------------|-------------------|---------------------|
| | | | | | Natural Convection | Forced Convection | |
| 246-197AB | 1.968 (50.0) | 1.986 (50.4) x 3.75 (9.5) | Vert./Horiz. | No Tab | 35°C @ 4W | 2.8°C/W @ 400 LFM | .0240 (10.90) |
| 246-197ABE-50 | 2.168 (55.1) | 1.986 (50.4) x 3.75 (9.5) | Vertical | 50 | 35°C @ 4W | 2.8°C/W @ 400 LFM | .0250 (11.40) |

Order SpeedClip™ 285SC or 330SC separately. (See 248 Series section).

Material: Aluminum, Black Anodized

MECHANICAL DIMENSIONS

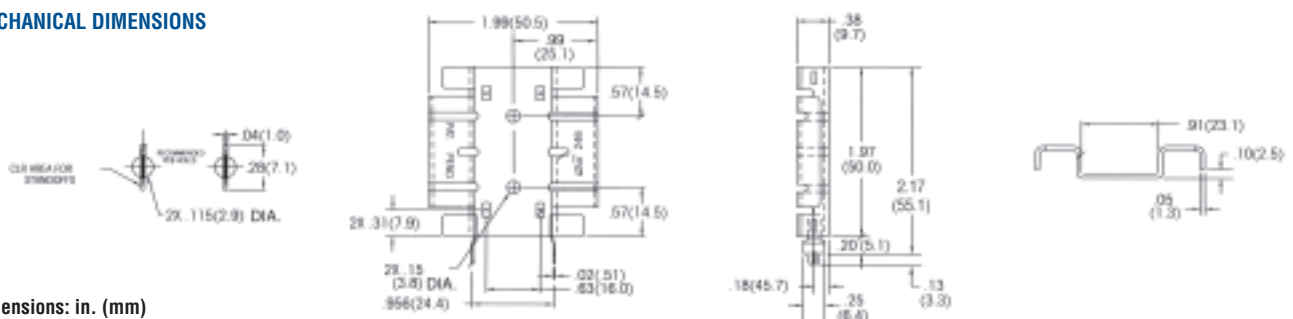

BOARD LEVEL HEAT SINKS FOR TO-220, TO-218 AND MULTIWATT™ COMPONENTS



247 SERIES

Medium Height, Deep Profile Wavesolderable Folded Fin Heat Sinks

MULTIWATT

| Standard P/N | Height Above PC Board in. (mm) | Footprint Dimensions in. (mm) | Mounting Configuration | Solderable Tab Options | Thermal Performance at Typical Load | | Weight lbs. (grams) |
|---------------|--------------------------------|-------------------------------|------------------------|------------------------|-------------------------------------|-------------------|---------------------|
| | | | | | Natural Convection | Forced Convection | |
| 247-195AB | 1.950 (49.5) | 1.900 (48.3) x .950 (24.1) | Vert./Horiz. | No Tab | 25°C@ 4W | 2.4°C/W @ 400 LFM | .0330 (15.10) |
| 247-195ABE-50 | 1.950 (49.5) | 1.900 (48.3) x .950 (24.1) | Vertical | 50 | 25°C@ 4W | 2.4°C/W @ 400 LFM | .0340 (15.60) |

Order SpeedClip™ 285SC or 330SC separately. (See 248 Series section).
Material: Aluminum, Black Anodized

MECHANICAL DIMENSIONS

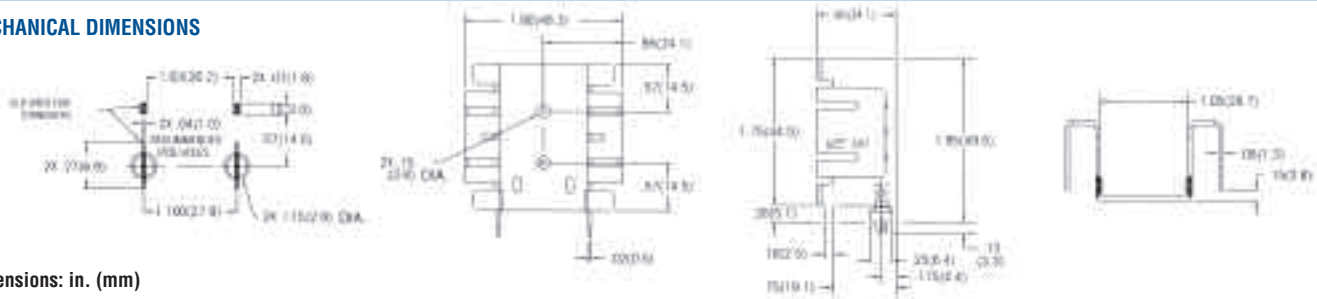

Dimensions: in. (mm)



248 SERIES

Low Height, Medium Profile Wavesolderable Folded Fin Heat Sinks

MULTIWATT

| Standard P/N | Height Above PC Board in. (mm) | Footprint Dimensions in. (mm) | Mounting Configuration | Solderable Tab Options | Thermal Performance at Typical Load | | Weight lbs. (grams) |
|---------------|--------------------------------|-------------------------------|------------------------|------------------------|-------------------------------------|-------------------|---------------------|
| | | | | | Natural Convection | Forced Convection | |
| 248-162AB | 1.620 (41.1) | 2.000 (50.8) x .750 (19.1) | Vert./Horiz. | No Tab | 35°C @ 4W | 2.5°C/W @ 400 LFM | .026 (11.60) |
| 248-162ABE-50 | 1.620 (41.1) | 2.000 (50.8) x .750 (19.1) | Vertical | 50 | 35°C @ 4W | 2.5°C/W @ 400 LFM | .027 (12.20) |

Order SpeedClip™ 285SC or 330SC separately.
Material: Aluminum, Black Anodized

MECHANICAL DIMENSIONS

Order SpeedClips™ separately for use with Series 246, 247, 248 or 249

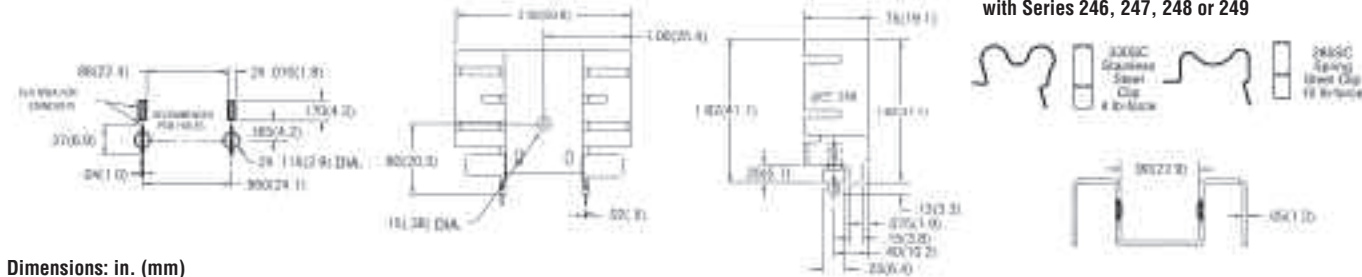

Dimensions: in. (mm)



249 SERIES

Medium Height, Deep Profile Wavesolderable Folded Fin Heat Sinks

MULTIWATT

| Standard P/N | Height Above PC Board in. (mm) | Footprint Dimensions in. (mm) | Mounting Configuration | Solderable Tab Options | Thermal Performance at Typical Load | | Weight lbs. (grams) |
|---------------|--------------------------------|-------------------------------|------------------------|------------------------|-------------------------------------|--------------------|---------------------|
| | | | | | Natural Convection | Forced Convection | |
| 249-113AB | 1.130 (28.7) | 1.900 (48.3) x .950 (24.1) | Vert./Horiz. | No Tab | 35°C@ 4W | 3.29°C/W @ 400 LFM | .020 (8.90) |
| 249-113ABE-50 | 1.130 (28.7) | 1.900 (48.3) x .950 (24.1) | Vertical | 50 | 35°C@ 4W | 3.29°C/W @ 400 LFM | .021 (9.40) |

Order SpeedClip™ 285SC or 330SC separately. (See 248 Series section).
Material: Aluminum, Black Anodized

MECHANICAL DIMENSIONS

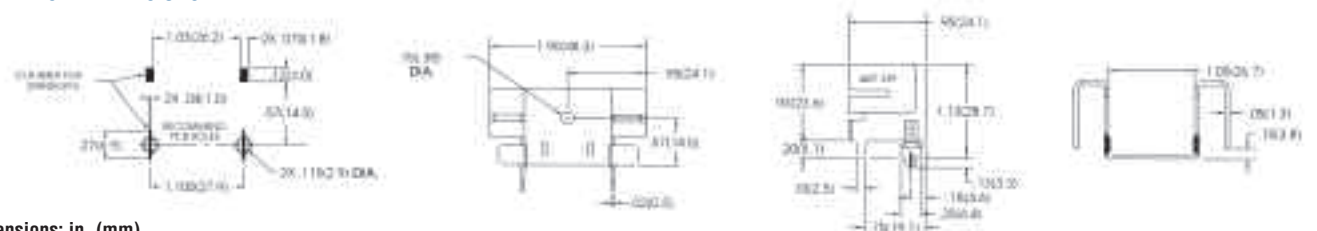

Dimensions: in. (mm)

BOARD LEVEL POWER SEMICONDUCTOR HEAT SINKS

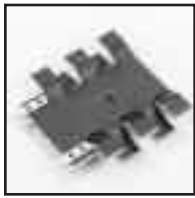

288 SERIES

Compact Wave-Solderable Low-Cost Heat Sinks

TO-220, TO-202

| Standard P/N | Height Above PC Board in. (mm) | Maximum Footprint in. (mm) | Thermal Performance at Typical Load | | Weight lbs. (grams) |
|--------------|--------------------------------|----------------------------|-------------------------------------|-------------------|---------------------|
| | | | Natural Convection | Forced Convection | |
| 288-1ABE | 1.250 (31.8) | 0.875 (22.2) x 0.215 (5.5) | 85°C @ 4W | 12°C/W @ 200 LFM | 0.0057 (2.59) |

Mounting tabs are pre-tinned to ensure excellent wave-solder bond and good electrical connections for vertical mounting of TO-220 and TO-202 semiconductor packages. These heat sinks are designed for use where minimum PC board

space is available. The 288-1AB is a stamped aluminum heat sink, black anodized, designed for applications requiring good heat dissipation from a heat sink occupying minimum space, available at minimum cost.

MECHANICAL DIMENSIONS

288 SERIES

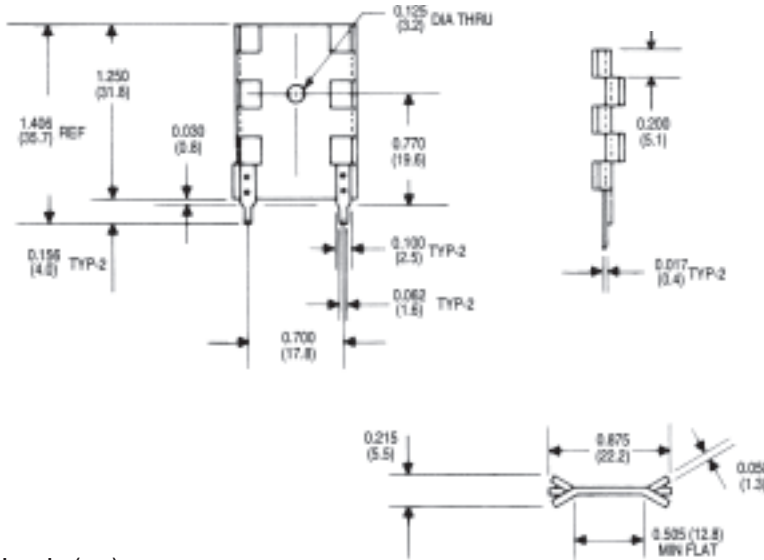

NATURAL AND FORCED CONVECTION CHARACTERISTICS

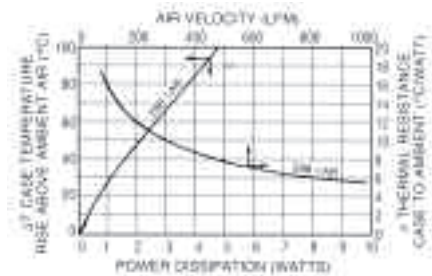

Dimensions: in. (mm)



271 SERIES

Top-Mount Booster Heat Sinks for Use with 270/272/280 Series

TO-220

| Standard P/N | Height Above Semiconductor Case in. (mm) | Horizontal Mounting Footprint Dimensions in. (mm) | Thermal Performance at Typical Load | | Weight lbs. (grams) |
|--------------|--|---|--|---|---------------------|
| | | | Natural Convection | Forced Convection | |
| 271-AB | 0.500 (12.7) | 1.750 (44.5) x 0.700 (17.8) | 62°C @ 4W (NOTE A) 31°C @ 4W (NOTE B) | 5.1°C/W @ 400 LFM 1.8°C/W 400 LFM (NOTE B) | 0.0052 (2.36) |

Material: Aluminum, Black Anodized

This top-hat style booster heat sink can be added to any of the 270, 272, or 280 Series for improved performance.

NOTE A: Thermal resistance with one 271-AB. NOTE B: Thermal resistance (total) as shown with (2) 271-AB types added to (1) 272-AB type.

MECHANICAL DIMENSIONS

271 SERIES

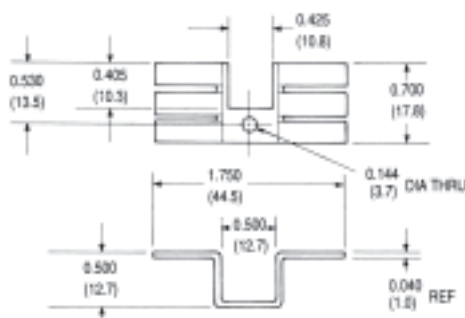

NATURAL AND FORCED CONVECTION CHARACTERISTICS

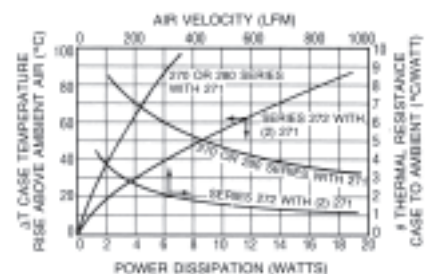

Dimensions: in. (mm)

BOARD LEVEL POWER SEMICONDUCTOR HEAT SINKS



270/272/280 SERIES

Small Footprint Low-Cost Heat Sinks

TO-220, TO-202

| Standard P/N | Height Above PC Board in. (mm) | Horizontal Mounting Maximum Footing in. (mm) | Solderable Tab Options | Thermal Performance at Typical Load | | Weight lbs. (grams) |
|--------------|--------------------------------|--|------------------------|-------------------------------------|-------------------|---------------------|
| | | | | Natural Convection | Forced Convection | |
| 270-AB | 0.375 (9.4) | 1.750 (44.5) x 0.700 (17.8) | — | 70°C @ 4W | 6.0°C/W @ 400 LFM | 0.0052 (2.36) |
| 272-AB | 0.375 (9.4) | 1.750 (44.5) x 1.450 (36.8) | 01,02 | 42°C @ 4W | 3.6°C/W @ 400 LFM | 0.0105 (5.72) |
| 280-AB | 0.375 (9.4) | 1.750 (44.5) x 0.700 (17.8) | — | 70°C @ 4W | 6.0°C/W @ 400 LFM | 0.0048 (2.18) |

Material: Aluminum, Black Anodized

These exceptionally low-cost heat sinks can be mounted horizontally under a TO-220 or TO-202 case style with a maximum height of only 0.375 in. (9.4). For added performance, a 271 Series heat sink can also be used for double-sided heat dissipation.

The 270-AB and 280-AB accept one power semiconductor; the 272-AB is designed for two power semiconductors. Specify solderable tab options for the 272 Series by the addition of suffix "01" or "02" to the standard part number (i.e. 272-AB01 or 272-AB02).

MECHANICAL DIMENSIONS

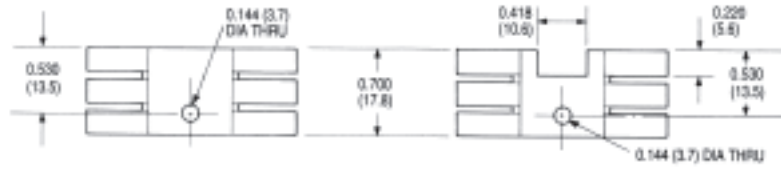

270 SERIES

280 SERIES

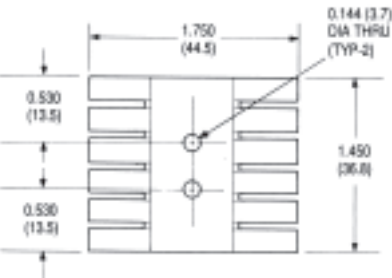

272 SERIES

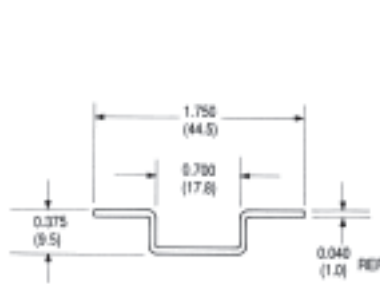

NATURAL AND FORCED CONVECTION CHARACTERISTICS

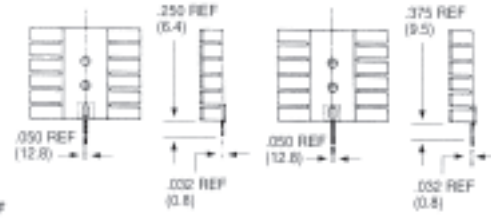
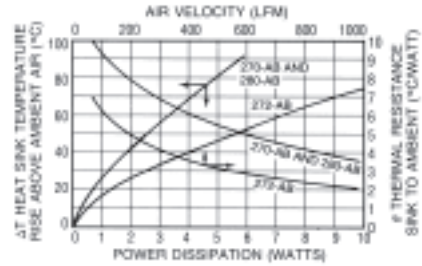

272AB01

272AB02

Dimensions: in. (mm)

Note:
1. Suggested Tab Hole = 0.075 ±0.003 plated with 0.100 pad



289 & 290 SERIES

Low-Cost Single or Dual Package Heat Sinks

TO-218, TO-202, TO-220

| Standard P/N | Height Above PC Board in. (mm) | Horizontal Mounting Maximum Footing in. (mm) | Thermal Performance at Typical Load | | Weight lbs. (grams) |
|--------------|--------------------------------|--|-------------------------------------|-------------------|---------------------|
| | | | Natural Convection | Forced Convection | |
| 289-AB | 0.500 (12.7) | 1.000 (25.4) x 0.710 (18.1) | 50°C @ 2W | 9.0 C/W @ 400 LFM | 0.0055 (2.49) |
| 289-AP | 0.500 (12.7) | 1.000 (25.4) x 0.710 (18.1) | 50°C @ 2W | 9.0 C/W @ 400 LFM | 0.0055 (2.49) |
| 290-1AB | 0.500 (12.7) | 1.000 (25.4) x 1.180 (30.0) | 44°C @ 2W | 7.0 C/W @ 400 LFM | 0.0082 (3.72) |
| 290-2AB | 0.500 (12.7) | 1.000 (25.4) x 1.180 (30.0) | 44°C @ 2W | 7.0 C/W @ 400 LFM | 0.0081 (3.67) |

Material: Aluminum, Black Anodized

Low in cost and compact in overall dimensions, one 289 Series heat sink can accommodate one semiconductor; the 289 Series is available with a black an-

odized finish (289-AB) or with no finish (289-AP). Two semiconductors can be mounted to the 290-2AB style.

289 SERIES

MECHANICAL DIMENSIONS

290 SERIES

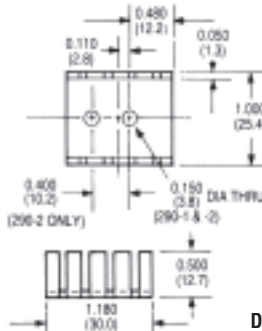
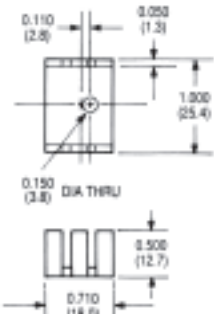

Dimensions: in. (mm)

NATURAL AND FORCED CONVECTION CHARACTERISTICS

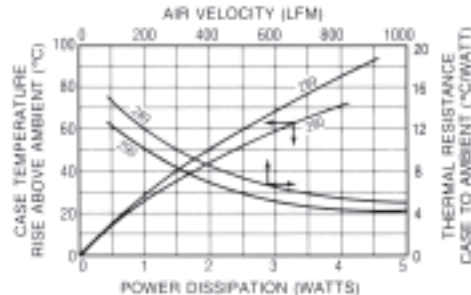

BOARD LEVEL POWER SEMICONDUCTOR HEAT SINKS



250 SERIES

High-Performance Slim Profile Heat Sinks With Integral Clips

MULTIWATT

| Standard P/N | Height Above PC Board in. (mm) | Footprint Dimensions in. (mm) | Mounting Configuration | Solderable Tab Options | Mounting Style | Thermal Performance at Typical Load | |
|---------------|--------------------------------|-------------------------------|------------------------|------------------------|----------------|-------------------------------------|-------------------|
| | | | | | | Natural Convection | Forced Convection |
| 250-122AB | 1.220 (31.0) | 1.000 (25.4) x .500 (12.7) | Vert./Horiz. | No Tab | Clip | 50°C @ 4W | 3.7°C/W @ 400 LFM |
| 250-122ABE-09 | 1.220 (31.0) | 1.000 (25.4) x .500 (12.7) | Vertical | 09 | Clip | 50°C @ 4W | 3.7°C/W @ 400 LFM |
| 250-122ABE-25 | 1.380 (35.1) | 1.000 (25.4) x .500 (12.7) | Vertical | 25 | Clip | 50°C @ 4W | 3.7°C/W @ 400 LFM |

Material: Aluminum, Black Anodized

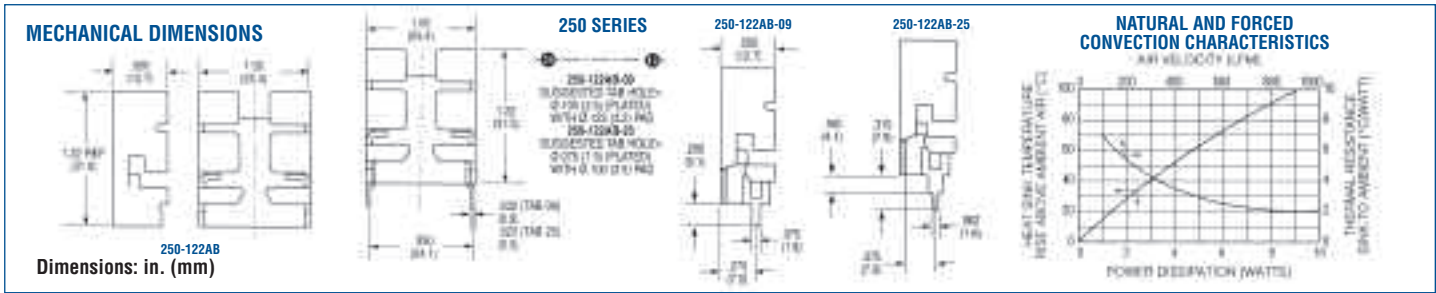

237 & 252 SERIES

High-Performance, High-Power Vertical Mount Heat Sinks

TO-220

| Standard P/N | Height Above PC Board in. (mm) | Footprint Dimensions in. (mm) | Mounting Configuration | Solderable Tab Options | Mounting Style | Thermal Performance at Typical Load | |
|----------------|--------------------------------|-------------------------------|------------------------|------------------------|----------------|-------------------------------------|-------------------|
| | | | | | | Natural Convection | Forced Convection |
| 237-167AB2 | 1.675 (42.5) | 1.000 (25.4) x 1.000 (25.4) | Vertical | 2, Twisted | Clip/Mtg Slot | 46°C @ 4W | 4.5°C/W @ 200 LFM |
| 237-167AB3 | 1.675 (42.5) | 1.000 (25.4) x 1.000 (25.4) | Vertical | 3, Twisted | Clip/Mtg Slot | 46°C @ 4W | 4.5°C/W @ 200 LFM |
| 237-167ABE2-24 | 1.675 (42.5) | 1.000 (25.4) x 1.000 (25.4) | Vertical | 2, Solderable | Clip/Mtg Slot | 46°C @ 4W | 4.5°C/W @ 200 LFM |
| 252-167AB2 | 1.675 (42.5) | 1.000 (25.4) x 1.000 (25.4) | Vertical | 2, Twisted | Clip/Mtg Slot | 40°C @ 4W | 4.5°C/W @ 200 LFM |
| 252-167AB3 | 1.675 (42.5) | 1.000 (25.4) x 1.000 (25.4) | Vertical | 3, Twisted | Clip/Mtg Slot | 40°C @ 4W | 4.5°C/W @ 200 LFM |
| 252-167ABE2-24 | 1.675 (42.5) | 1.000 (25.4) x 1.000 (25.4) | Vertical | 2, Solderable | Clip/Mtg Slot | 40°C @ 4W | 4.5°C/W @ 200 LFM |

Order SpeedClips™ 285SC or 330SC separately for rapid component installation, lowering manufacturing costs. Material: Aluminum, Black Anodized

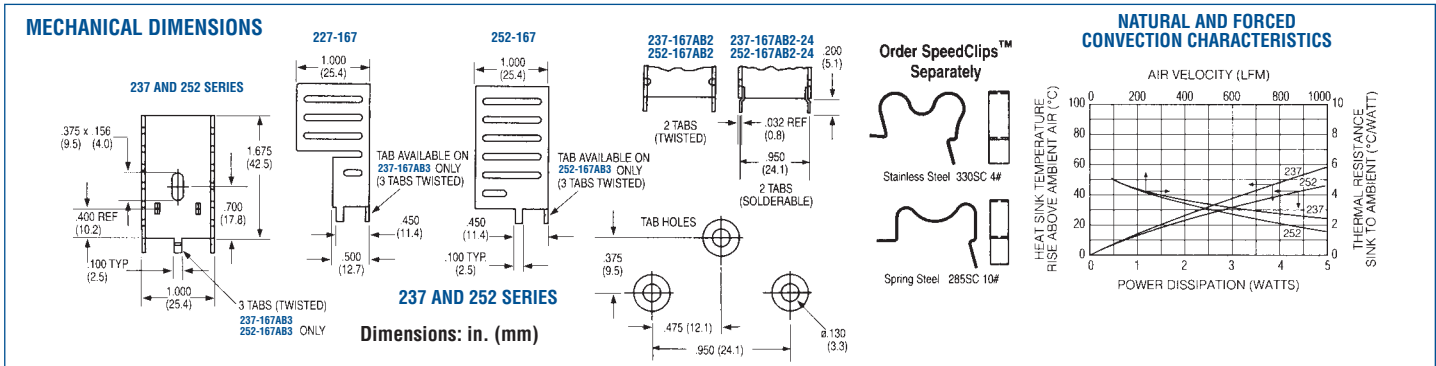

291 SERIES

Labor-Saving Clip-on Heat Sinks

TO-220

| Standard P/N | Height Above PC Board in. (mm) | Vertical Mounting Footprint Dimensions in. (mm) | Mounting Style | Thermal Performance at Typical Load | | Weight lbs. (grams) |
|--------------|--------------------------------|---|--------------------|-------------------------------------|-------------------|---------------------|
| | | | | Natural Convection | Forced Convection | |
| 291-C236AB | 0.860 (21.9) | 1.100 (27.0) x 0.360 (9.1) | TO-220 (Clip) | 80°C @ 2W | 24°C/W @ 600 LFM | 0.0026 (1.18) |
| 291-H36AB | 0.860 (21.9) | 1.100 (27.0) x 0.360 (9.1) | TO-220 (Mtg. Hole) | 68°C @ 2W | 16°C/W @ 600 LFM | 0.0026 (1.18) |

Material: Aluminum, Black Anodized

Designed for mounting horizontally or vertically on a circuit board, 291 Series heat sinks employ a unique clip for attachment of TO-220 case styles.

One type is available with a locking clip and one with a 0.140 in. (3.6) diameter mounting hole only.

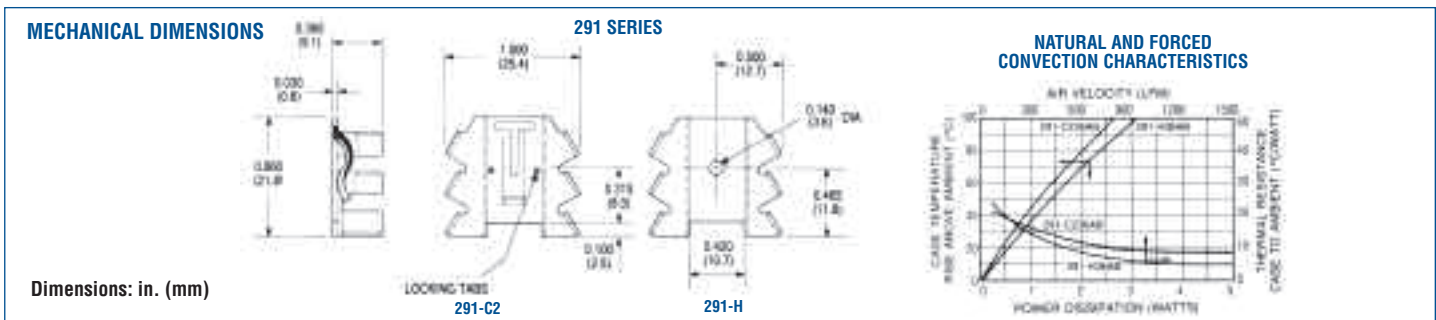

Dimensions: in. (mm)

BOARD LEVEL POWER SEMICONDUCTOR HEAT SINKS



286 SERIES

Aluminum and Copper Low-Cost Wave-Solderable Heat Sinks

See also 286DB Series on Page 7.

TO-220

| Standard P/N | Height Above PC Board in. (mm) | Maximum Footprint in. (mm) | Material | Thermal Performance at Typical Load | | Weight lbs. (grams) |
|--------------|--------------------------------|-----------------------------|--------------------|-------------------------------------|-------------------|---------------------|
| | | | | Natural Convection | Forced Convection | |
| 286-AB | 1.190 (30.2) | 1.000 (25.4) x 0.500 (12.7) | Aluminum, Anodized | 58°C @ 4W | 7.4°CW @ 200 LFM | 0.0085 (3.86) |
| 286-CBTE | 1.190 (30.2) | 1.000 (25.4) x 0.500 (12.7) | Copper, Black | 58°C @ 4W | 7.4°CW @ 200 LFM | 0.0250 (11.34) |
| 286-CTE | 1.190 (30.2) | 1.000 (25.4) x 0.500 (12.7) | Copper, Tinned | 58°C @ 4W | 7.4°CW @ 200 LFM | 0.0250 (11.34) |

Efficient heat removal at low cost can be achieved by inserting the 286 Series directly into pre-drilled circuit boards; scored mounting tabs may be bent after insertion to provide added stability. The 286 Series can be wavesoldered directly to

the board. Material: 286-AB style (aluminum, black anodized), 286-CBT style (copper, black paint tin tabs), and 286-CT style (copper, tinned).

MECHANICAL DIMENSIONS

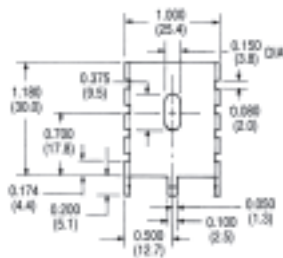

Dimensions: in. (mm)

286 SERIES



NATURAL AND FORCED CONVECTION CHARACTERISTICS

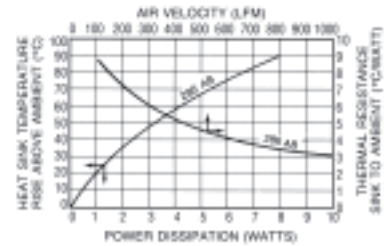

287 SERIES

Wave-Solderable Low-Cost Heat Sinks

TO-220

| Mounting Slot | Standard P/N | Height Above PC Board in. (mm) | Maximum Footprint "A" in. (mm) | Thermal Performance at Typical Load | | Weight lbs. (grams) | |
|---------------|--------------|--------------------------------|--------------------------------|-------------------------------------|-------------------|---------------------|---------------|
| | | | | Natural Convection | Forced Convection | | |
| | 287-1ABE | 287-1ABH | 1.180 (30.0) | 1.000 (25.4) x 0.500 (12.7) | 65°C @ 4W | 7.8°CW @ 200 LFM | 0.0090 (4.08) |
| | 287-2ABE | 287-2ABH | 1.180 (30.0) | 1.000 (25.4) x 1.000 (25.4) | 55°C @ 4W | 6.4°CW @ 200 LFM | 0.0140 (6.35) |

Material: Aluminum, Black Anodized

Mount these cost-effective TO-220 heat sinks vertically into pre-drilled printed circuit boards. Soldered, pre-tinned tabs can be wavesoldered directly to the

board. A 0.375 in. (9.5 mm) mounting slot allows for correct positioning of TO-220 and similar semiconductor packages.

MECHANICAL DIMENSIONS

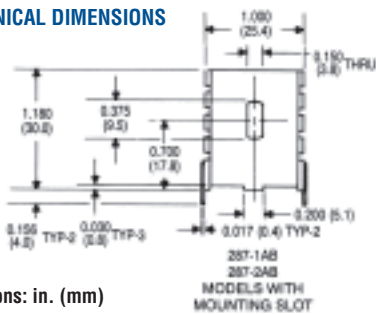

Dimensions: in. (mm)

287 SERIES



| Standard P/N | Dim. "A" |
|--------------|--------------|
| 287-1AB | 0.500 (12.7) |
| 287-2AB | 1.000 (25.4) |
| 287-1ABH | 0.500 (12.7) |
| 287-2ABH | 1.000 (25.4) |

NATURAL AND FORCED CONVECTION CHARACTERISTICS

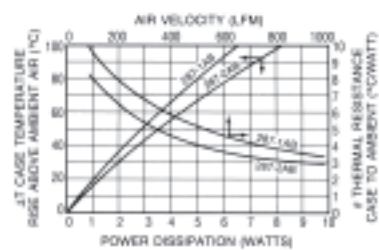

285 & 330 SERIES

285 SC and 330 SC SpeedClips™

| Standard P/N | Nominal Installed Loading Force | For Use With Series | Material | Weight lbs. (grams) |
|--------------|---------------------------------|-------------------------|-----------------|---------------------|
| 285 SC | 10 lbs | 232, 237, 240, 252, 667 | Carbon Steel | 0.00053 (0.24) |
| 330 SC | 4 lbs | 232, 237, 240, 252, 667 | Stainless Steel | 0.00074 (0.34) |

SpeedClips™ employ a locking safety tab for mounting. Must be ordered separately for these heat sink series. Use these SpeedClips™ with our 237, 240, and 252 Series heat sinks for the lowest production assembly time and cost. Order

one SpeedClip™ for each heat sink purchased. Must be purchased with heat sinks.

MECHANICAL DIMENSIONS



Dimensions: in. (mm)

Speed Clip 330 SC
4 lb (17.8N)
Nominal Force Installed



Speed Clip 285 SC
10 lb (44.5N)
Nominal Force Installed

BOARD LEVEL POWER SEMICONDUCTOR HEAT SINKS



695 SERIES
Space-Saving Heat Sinks for Small Stud-Mounted Diodes

STUD-MOUNT

| Standard P/N | Maximum Width in. (mm) | Height in. (mm) | Thermal Performance at Typical Load | | Weight lbs. (grams) |
|--------------|------------------------|-----------------|-------------------------------------|-------------------|---------------------|
| | | | Natural Convection | Forced Convection | |
| 695-1B | 1.330 (33.8) | 0.530 (13.7) | 72°C @ 4.0W | 5.2°C/W @ 400 LFM | 0.008 (4.0) |

Mount and effectively heat sink small stud-mounted diodes with the 695 Series space-saving heat sink type. Each unit is black anodized aluminum with an 0.200 in. (5.1) dia. mounting hole centered in the base. The folded fin design

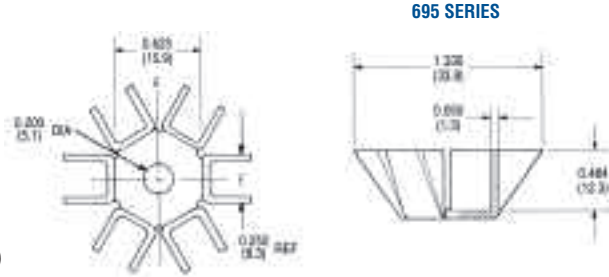
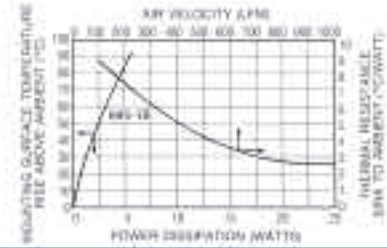
provides good heat dissipation for use where height is limited above the printed circuit board or base plate.

MECHANICAL DIMENSIONS

NATURAL AND FORCED CONVECTION CHARACTERISTICS

260 SERIES
Cup Clips for TO-5 Case Style Semiconductors

TO-5

| Characteristics | TO-5 |
|---|----------|
| Thermal Resistance – Epoxy Insulated | 14° C/W |
| Breakdown Voltage – Epoxy Type (VAC), 60 Hz | 500 |
| Recommended Operating Voltage, AC or DC | |
| Clean Conditions: % Hipot Rating | 50 |
| Dusty Conditions: % Hipot Rating | 30 |
| Dirty Conditions: % Hipot Rating | 10 to 20 |
| Temperature Range — Continuous (C°) | -73/+149 |

| Model | Depth of Tapped Base |
|-----------|----------------------|
| 260-4T5E | 0.093 (2.36) |
| 260-4TH5E | 0.125 (3.18) |

Thread Size: 4 = #4-40 UNC
6 = #6-32 UNC

Mounting Style: T = tapped
S = stud
P = plain

Base Style: H = hex
Semiconductor Case Style: 5 = TO-5
Insulation: E = epoxy

TO-5 CASE STYLE CUP CLIPS — ORDERING GUIDE

| Standard P/N | Insulation Type | Outline Dimension L x W x I.D. in. (mm) | Weight lbs. (grams) | Case Style |
|--------------|-----------------|---|---------------------|------------|
| 260-4T5E | Epoxy Insulated | 0.370 (9.4) x 0.380 (9.7) dia. x 0.290 (7.4) | 0.0024 (1.09) | TO-5 |
| 260-4TH5E | Epoxy Insulated | 0.400 (10.2) x 0.370 (9.4) hex. x 0.290 (7.4) | 0.0031 (1.41) | TO-5 |
| 260-6SH5E | Epoxy Insulated | 0.557 (14.1) x 0.370 (9.4) hex. x 0.290 (7.4) | 0.0037 (1.68) | TO-5 |

Materials and Finish: Cups – beryllium copper, black ebonol "C"; Bases – brass, black ebonol "C"

Base Mounting Configurations — TO-5

Plain Type — Epoxy bonded, or used with #4 pan head screws.

Tapped Base — #4-40 UNC screw (not supplied) fits tapped hole. Care should be taken not to use too long a screw, which could short against the semiconductor case. For correct screw lengths:

Correct Screw Length (L) = $\text{Depth of Base} + \text{Panel Thickness} + \text{Washer Thickness}$

Stud Mounting Base. #6-32 UNC. Nuts and washers not supplied. Stud hole must be slightly countersunk to ensure flat mounting.

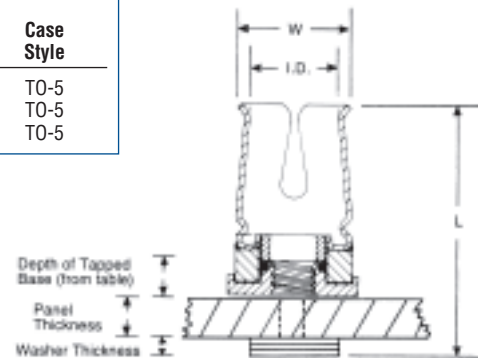

To determine the correct mounting screw lengths, add dimensions as follows:

Correct Screw Length (L) = $\text{Depth of Base} + \text{Panel Thickness} + \text{Washer Thickness}$

BOARD LEVEL POWER SEMICONDUCTOR HEAT SINKS

260 SERIES Epoxy Insulated For TO-5

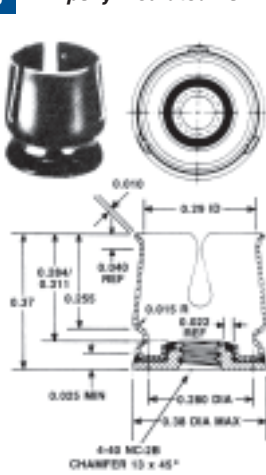

260-4T5E

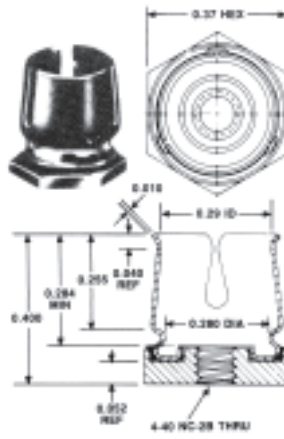

260-4TH5E

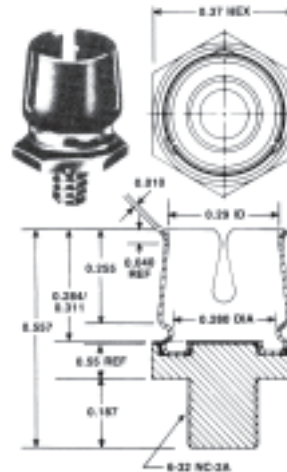

260-6SH5E



258 SERIES Thermal Links for Fused Glass Diodes

DIODES

| Standard P/N | Dimensions in. (mm) | Material | Finish | Weight lbs. (grams) |
|--------------|--|----------|---|---------------------|
| 258 | 0.500 (12.7) x 0.250 (6.4) x 0.340 (8.6) | Aluminum | DeltaCoate™ 151 on all surfaces except solder pads and base | 0.0018 (0.82) |

The thermal resistance from diode leads to chassis or heat sink is 12°C/watt, when unit is mounted with TYPE 120 Joint Compound. If a 10°C/watt chassis or

sink to ambient impedance is available, the thermal resistance from the diode leads to ambient is reduced from about 150°C/watt to 22°C/watt.

MECHANICAL DIMENSIONS

258 SERIES

Dimensions: in. (mm)

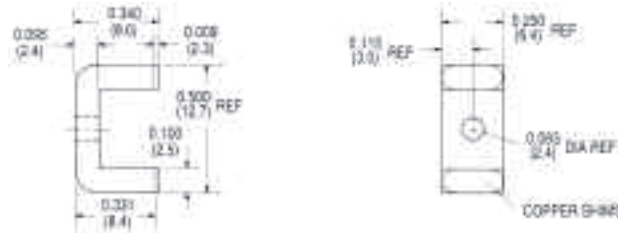

292 SERIES Heat Sink for Single TO-92

TO-92

| Standard P/N | Height Above PC Board in. (mm) | Overall Fin Width in. (mm) | Thermal Performance Natural Convection | Finish | Weight lbs. (grams) |
|--------------|--------------------------------|----------------------------|--|----------------|---------------------|
| 292-AB | 0.750 (19.1) | 0.600 (15.3) | 0.225°C/W @ 0.250 W | Black Anodized | 0.00049 (0.22) |

Power semiconductors packaged in a TO-92 style plastic case can be cooled effectively at little additional cost with the addition of the 292-AB heat sink. The

292-AB is effective over the typical power range of such devices. Material: Aluminum, Black Anodized

MECHANICAL DIMENSIONS

Dimensions: in. (mm)

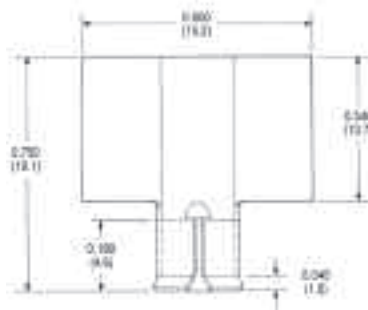

292 SERIES

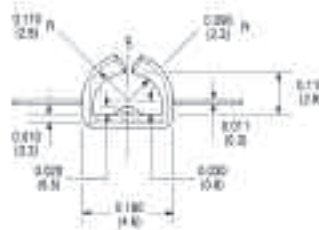

NATURAL AND FORCED CONVECTION CHARACTERISTICS

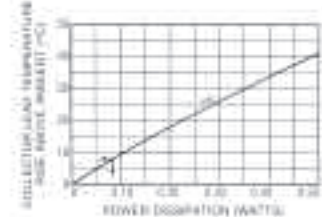

BOARD LEVEL POWER SEMICONDUCTOR HEAT SINKS

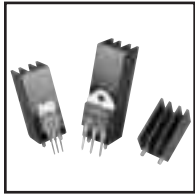
634 SERIES
Slim Profile Unidirectional Fin Vertical Mount Heat Sink

TO-220 and TO-218

| Plain Pin | Standard P/N | | Height Above PC Board in. (mm) | Footprint Dimensions in. (mm) | Weight lbs. (grams) |
|------------|--------------|----------|--------------------------------|-------------------------------|---------------------|
| | Without Pin | With Pin | | | |
| 634-10ABEP | 634-10AB | | 1.000 (25.4) | 0.640 (16.26) x 0.640 (16.26) | 0.016 (7.48) |
| 634-15ABEP | 634-15AB | | 1.500 (38.1) | 0.640 (16.26) x 0.640 (16.26) | 0.025 (11.21) |
| 634-20ABEP | 634-20AB | | 2.000 (50.8) | 0.640 (16.26) x 0.640 (16.26) | 0.033 (14.95) |

Material: Aluminum, Black Anodized.

These slim profile unidirectional fin heat sinks offer users two assembly alternatives for vertically mounting TO-220 and TO-218 components. Models are available with or without wave-

solderable pins on 0.40 in. (10.2) centers, making them ideal for a variety of applications where quick assembly is needed and space is at a premium.

MECHANICAL DIMENSIONS
634 SERIES
Notes:

1. Thermal compound is assumed between device and heat sink.
2. Tab temp with longer heat sink (634-20ABP) will typically be about 15% cooler. Tab temp with shorter heat sink (634-10ABP) will typically be about 25% higher.

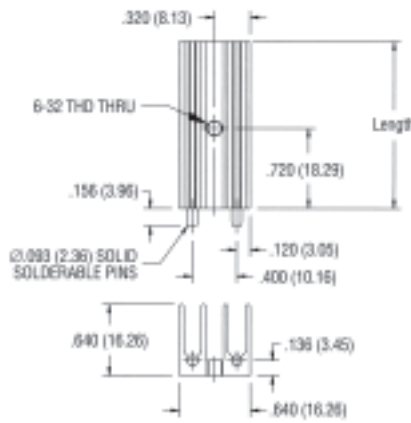

Dimensions: in. (mm)

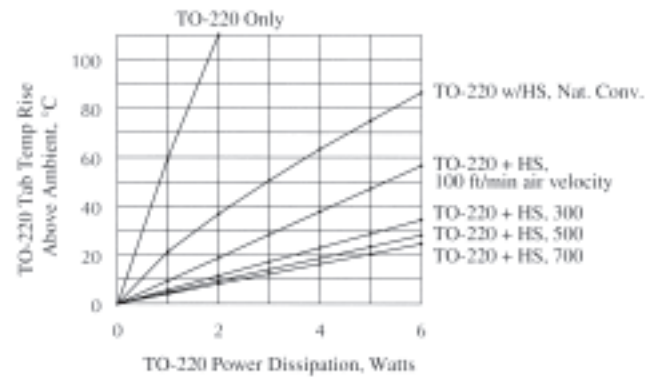
TYPICAL THERMAL PERFORMANCE FOR 634-15ABP

637 SERIES
High-Efficiency Heat Sinks For Vertical Board Mounting

TO-220

| Standard P/N | Height Above PC Board "A" in. (mm) | Maximum Footprint in. (mm) | Thermal Performance at Typical Load | | Weight lbs. (grams) |
|--------------|------------------------------------|-----------------------------|-------------------------------------|-------------------|---------------------|
| | | | Natural Convection | Forced Convection | |
| 637-10ABEP | 1.000 (25.4) | 1.375 (34.9) x 0.500 (12.7) | 76°C @ 6W | 5.8°C/W @ 200 LFM | 0.023 (10.43) |
| 637-15ABEP | 1.500 (38.1) | 1.375 (34.9) x 0.500 (12.7) | 65°C @ 6w | 5.5°C/W @ 200 LFM | 0.035 (15.88) |
| 637-20ABEP | 2.000 (50.8) | 1.375 (34.9) x 0.500 (12.7) | 55°C @ 6W | 4.7°C/W @ 200 LFM | 0.050 (22.68) |
| 637-25ABEP | 2.500 (63.5) | 1.375 (34.9) x 0.500 (12.7) | 48°C @ 6W | 4.2°C/W @ 200 LFM | 0.062 (28.12) |

Material: Aluminum, Black Anodized

Wave-solderable pins on 1 in. centers for vertical mounting on printed circuit boards. Maximum semiconductor package width 0.625 in. (15.9). Use this heat sink where weight and

board space occupied must be minimized. Refer to the Accessory products section for thermal interface materials, thermal compounds, and other accessories products.

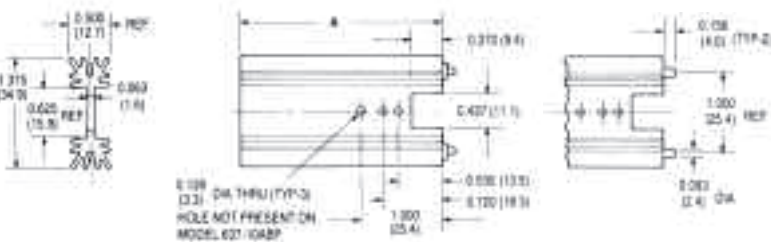
MECHANICAL DIMENSIONS
**637 SERIES
(EXTRUSION PROFILE 5183)**

Dimensions: in. (mm)

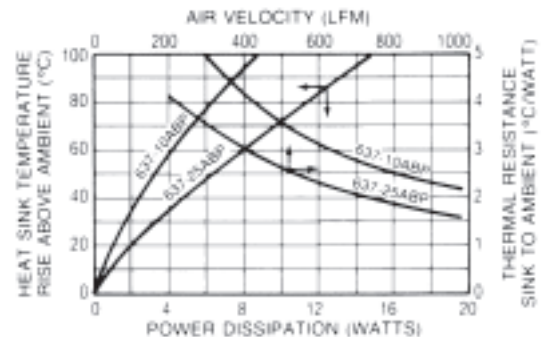
NATURAL AND FORCED CONVECTION CHARACTERISTICS

BOARD LEVEL POWER SEMICONDUCTOR HEAT SINKS



667 SERIES Labor-Saving SpeedClip™ Heat Sinks for Vertical Board Mounting

TO-220

| Standard P/N Standoff Pin | Standard P/N Plain Pin | Height Above PC Board "A" in. (mm) | Maximum Footprint in. (mm) | Thermal Performance at Typical Load | | Weight lbs (grams) |
|------------------------------|---------------------------|--|----------------------------------|-------------------------------------|----------------------|-----------------------|
| | | | | Natural Convection | Forced Convection | |
| 667-10ABESP | 667-10ABPP | 1.000 (25.4) | 1.375 (34.9) x 0.500 (12.7) | 76°C @ 6W | 5.8°C/W @ 200 LFM | 0.0240 (11.0) |
| 667-15ABESP | 667-15ABPP | 1.500 (38.1) | 1.375 (34.9) x 0.500 (12.7) | 66°C @ 6W | 5.5°C/W @ 200 LFM | 0.0340 (15.6) |
| 667-20ABESP | 667-20ABPP | 2.000 (50.8) | 1.375 (34.9) x 0.500 (12.7) | 58°C @ 6W | 4.7°C/W @ 200 LFM | 0.0460 (21.0) |
| 667-25ABESP | 667-25ABPP | 2.500 (63.5) | 1.375 (34.9) x 0.500 (12.7) | 48°C @ 6W | 4.2°C/W @ 200 LFM | 0.0580 (26.2) |

Wave-solderable pins. Material: Aluminum, Black Anodized

Excellent performance, choice of wave-solderable plain pins (PP-Type) or wave-solderable hex-shaped standoff pins (SP-Type), and reduced assembly cost.
Note: Order 330 SC or 285 SC SpeedClip™ separately.

MECHANICAL DIMENSIONS

667 SERIES (EXTRUSION PROFILE 8073)

STANDOFF PINS "SP"
PLAIN PINS "PP"

Dimensions: in. (mm)

NATURAL AND FORCED CONVECTION CHARACTERISTICS

HEAT SINK TEMPERATURE RISE ABOVE AMBIENT (°C)

AIR VELOCITY (FPM)

POWER DISSIPATION (WATTS)

THERMAL RESISTANCE SINK TO AMBIENT (°C/WATT)



626 & 627 SERIES High-Efficiency Heat Sinks for Vertical Board Mounting

TO-218, TO-220

| Standard P/N | Standard P/N | Height Above PC Board "A" in. (mm) | Maximum Footprint in. (mm) | Thermal Performance at Typical Load | |
|--------------|--------------|--|----------------------------------|-------------------------------------|----------------------|
| | | | | Natural Convection | Forced Convection |
| 626-10ABEP | 627-10ABP | 1.000 (25.4) | 1.375 (34.9) x .500 (12.7) | 76°C @ 6W | 5.8°C/W @ 200 LFM |
| 626-15ABEP | 627-15ABP | 1.500 (38.1) | 1.375 (34.9) x .500 (12.7) | 65°C @ 6W | 5.5°C/W @ 200 LFM |
| 626-20ABEP | 627-20ABP | 2.000 (50.8) | 1.375 (34.9) x .500 (12.7) | 55°C @ 6W | 4.7°C/W @ 200 LFM |
| 626-25ABEP | 627-25ABP | 2.500 (63.5) | 1.375 (34.9) x .500 (12.7) | 48°C @ 6W | 4.2°C/M @ 200 LFM |

Wave-solderable pins. Material: Aluminum, Black Anodized

MECHANICAL DIMENSIONS

626 AND 627 SERIES

Dimensions: in. (mm)

NATURAL AND FORCED CONVECTION CHARACTERISTICS

HEAT SINK TEMPERATURE RISE ABOVE AMBIENT AIR (°C)

AIR VELOCITY (LFM)

POWER DISSIPATION (WATTS)

THERMAL RESISTANCE SINK TO AMBIENT (°C/WATT)

| Series | Type Device | Hole Diameter "B" | Hole Height "C" | Webb Width "D" | Notch Width "E" | Extrusion Profile |
|--------|-------------|-------------------|-----------------|----------------|-----------------|-------------------|
| 626 | TO-218 | .144 (3.7) | .890 (21.6) | .680 (16.8) | .540 (13.7) | 8420 |
| 627 | TO-220 | .128 (3.3) | .720 (18.3) | .625 (15.9) | .437 (11.1) | 5183 |

Dimensions: in. (mm)

BOARD LEVEL POWER SEMICONDUCTOR HEAT SINKS



647 SERIES High-Performance Heat Sinks for Vertical Board Mounting

TO-220

| Standard P/N | Height Above PC Board "A" in. (mm) | Maximum Footprint in. (mm) | Thermal Performance at Typical Load | | Weight lbs. (grams) |
|--------------|------------------------------------|-----------------------------|-------------------------------------|-------------------|---------------------|
| | | | Natural Convection | Forced Convection | |
| 647-10ABEP | 1.000 (25.4) | 1.650 (41.9) x 1.000 (25.4) | 42°C @ 6W | 3.8°C/W @ 200 LFM | 0.055 (24.95) |
| 647-15ABEP | 1.500 (38.1) | 1.650 (41.9) x 1.000 (25.4) | 37°C @ 6W | 3.5°C/W @ 200 LFM | 0.075 (34.02) |
| 647-175ABEP | 1.750 (44.5) | 1.650 (41.9) x 1.000 (25.4) | 34°C @ 6W | 3.3°C/W @ 200 LFM | 0.090 (40.82) |
| 647-20ABEP | 2.000 (50.8) | 1.650 (41.9) x 1.000 (25.4) | 31°C @ 6W | 3.1°C/W @ 200 LFM | 0.104 (47.17) |
| 647-25ABEP | 2.500 (63.5) | 1.650 (41.9) x 1.000 (25.4) | 25°C @ 6W | 2.8°C/W @ 200 LFM | 0.125 (56.70) |

Material: Aluminum, Black Anodized

Wave-solderable pins on 1 in. centers for vertical mounting of larger devices on printed circuit boards. Maximum semiconductor package width: 0.625 (15.9). Refer to the Accessory

Products section for thermal interface materials, 126 Series silicone-free thermal compounds, and other accessories products.

MECHANICAL DIMENSIONS

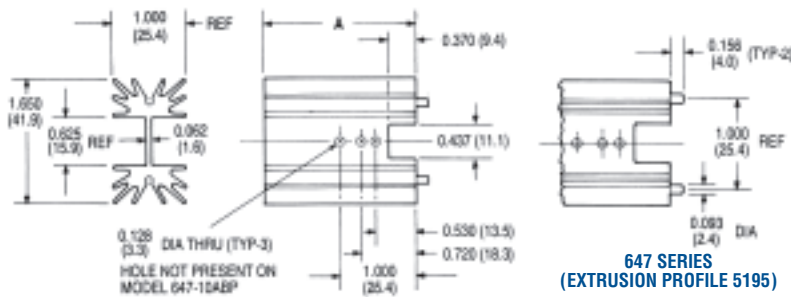

NATURAL AND FORCED CONVECTION CHARACTERISTICS

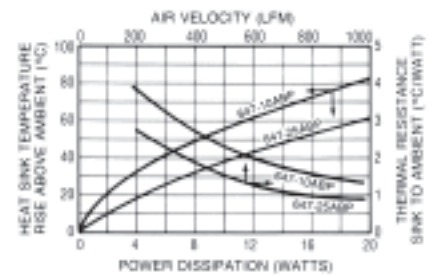

Dimensions: in. (mm)



657 SERIES High-Performance Heat Sinks for Vertical Board Mounting

TO-220, TO-247, TO-218

| Standard P/N | Height Above PC Board "A" in. (mm) | Maximum Footprint in. (mm) | Thermal Performance at Typical Load | | Weight lbs. (grams) |
|--------------|------------------------------------|-----------------------------|-------------------------------------|-------------------|---------------------|
| | | | Natural Convection | Forced Convection | |
| 657-10ABEP | 1.000 (25.4) | 1.650 (41.9) x 1.000 (25.4) | 41°C @ 6W | 3.7°C/W @ 200 LFM | 0.0515 (23.36) |
| 657-15ABEP | 1.500 (38.1) | 1.650 (41.9) x 1.000 (25.4) | 38°C @ 6W | 3.3°C/W @ 200 LFM | 0.0760 (34.60) |
| 657-20ABEP | 2.000 (50.8) | 1.650 (41.9) x 1.000 (25.4) | 32°C @ 6W | 2.9°C/W @ 200 LFM | 0.1030 (47.00) |
| 657-25ABEP | 2.500 (63.5) | 1.650 (41.9) x 1.000 (25.4) | 25°C @ 6W | 2.7°C/W @ 200 LFM | 0.1250 (57.00) |

Wave-solderable pins. Material: Aluminum, Black Anodized

MECHANICAL DIMENSIONS

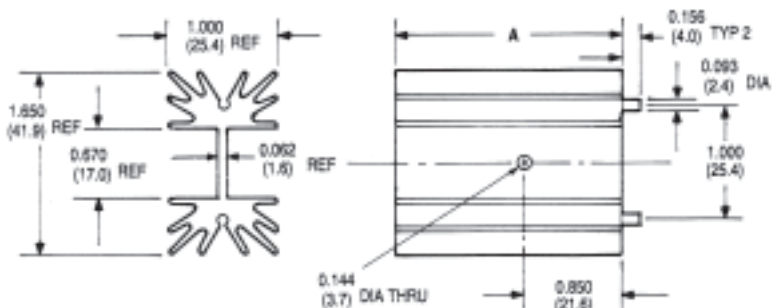

NATURAL AND FORCED CONVECTION CHARACTERISTICS

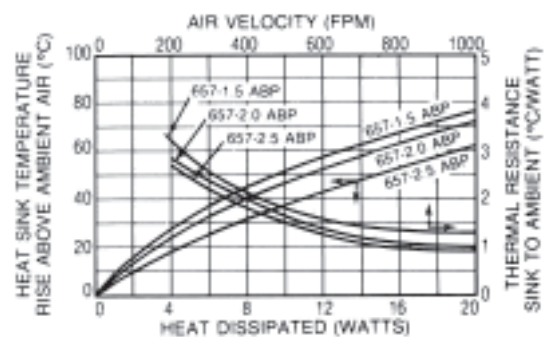

Dimensions: in. (mm)

BOARD LEVEL POWER SEMICONDUCTOR HEAT SINKS



657 SERIES High-Performance Notched Heat Sinks for Vertical Board Mounting

TO-220, TO-247, TO-218

| Standard P/N | Height Above PC Board "A" in. (mm) | Maximum Footprint in. (mm) | Thermal Performance at Typical Load | |
|--------------|------------------------------------|-----------------------------|-------------------------------------|-------------------|
| | | | Natural Convection | Forced Convection |
| 657-10ABEPN | 1.000 (25.4) | 1.650 (41.9) x 1.000 (25.4) | 41°C @ 6W | 3.7°C/W @ 200 LFM |
| 657-15ABEPN | 1.500 (38.1) | 1.650 (41.9) x 1.000 (25.4) | 38°C @ 6W | 3.3°C/W @ 200 LFM |
| 657-20ABEPN | 2.000 (50.8) | 1.650 (41.9) x 1.000 (25.4) | 32°C @ 6W | 2.9°C/W @ 200 LFM |
| 657-25ABEPN | 2.500 (63.5) | 1.650 (41.9) x 1.000 (25.4) | 25°C @ 6W | 2.7°C/W @ 200 LFM |

Wave-solderable pins. Material: Aluminum, Black Anodized

MECHANICAL DIMENSIONS

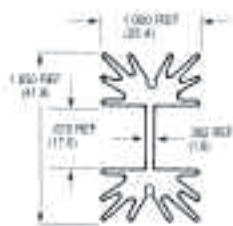

Dimensions: in. (mm)

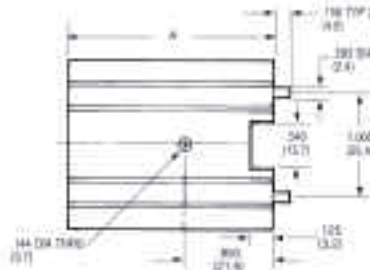

657 SERIES

657 SERIES (EXTRUSION PROFILE 6533)

NATURAL AND FORCED CONVECTION CHARACTERISTICS

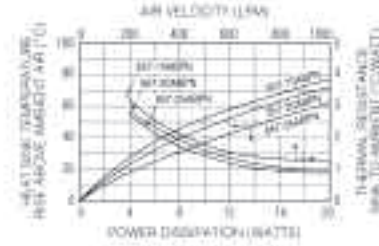

657 SERIES High-Performance Heat Sinks with SpeedClips™ for Vertical Board Mounting

TO-220, TO-247, TO-218

| Standard P/N | Height Above PC Board "A" in. (mm) | Maximum Footprint in. (mm) | Thermal Performance at Typical Load | |
|--------------|------------------------------------|-----------------------------|-------------------------------------|-------------------|
| | | | Natural Convection | Forced Convection |
| 657-10ABEPSC | 1.000 (25.4) | 1.650 (41.9) x 1.000 (25.4) | 41°C @ 6W | 3.7°C/W @ 200 LFM |
| 657-15ABEPSC | 1.500 (38.1) | 1.650 (41.9) x 1.000 (25.4) | 38°C @ 6W | 3.3°C/W @ 200 LFM |
| 657-20ABEPSC | 2.000 (50.8) | 1.650 (41.9) x 1.000 (25.4) | 32°C @ 6W | 2.9°C/W @ 200 LFM |
| 657-25ABEPSC | 2.500 (63.5) | 1.650 (41.9) x 1.000 (25.4) | 25°C @ 6W | 2.7°C/W @ 200 LFM |

Wave-solderable pins. Material: Aluminum, Black Anodized

MECHANICAL DIMENSIONS

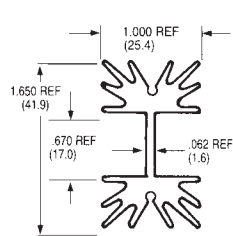

Dimensions: in. (mm)

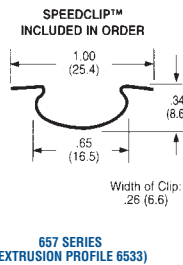
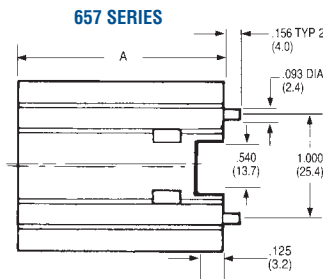

657 SERIES (EXTRUSION PROFILE 6533)

NATURAL AND FORCED CONVECTION CHARACTERISTICS

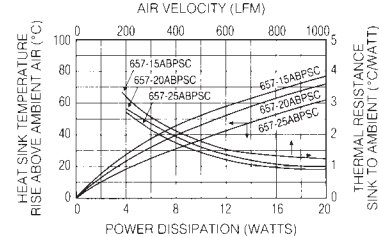

677 SERIES High-Performance, High-Power Heat Sinks for Vertical Board Mounting

TO-218, TO-220, TO-247
15-LEAD Multiwatt

| Standard P/N | Height Above PC Board "A" in. (mm) | Maximum Footprint in. (mm) | Thermal Performance at Typical Load | |
|--------------|------------------------------------|-----------------------------|-------------------------------------|-------------------|
| | | | Natural Convection | Forced Convection |
| 677-10ABEP | 1.000 (25.4) | 1.650 (41.9) x 1.000 (25.4) | 52°C @ 6W | 3.1°C/W @ 200 LFM |
| 677-15ABEP | 1.500 (38.1) | 1.650 (41.9) x 1.000 (25.4) | 46°C @ 6W | 2.8°C/W @ 200 LFM |
| 677-20ABEP | 2.000 (50.8) | 1.650 (41.9) x 1.000 (25.4) | 40°C @ 6W | 2.5°C/W @ 200 LFM |
| 677-25ABEP | 2.500 (63.5) | 1.650 (41.9) x 1.000 (25.4) | 35°C @ 6W | 2.2°C/W @ 200 LFM |

Wave-solderable pins. Material: Aluminum, Black Anodized

MECHANICAL DIMENSIONS

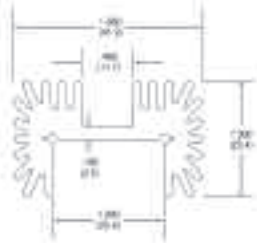

Dimensions: in. (mm)

677 SERIES

677 SERIES (EXTRUSION PROFILE 8719)

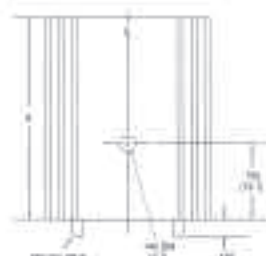

NATURAL AND FORCED CONVECTION CHARACTERISTICS

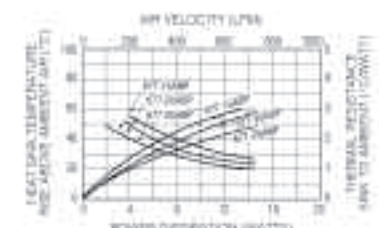

BOARD LEVEL POWER SEMICONDUCTOR HEAT SINKS



690 SERIES Highest Efficiency/Lowest Unit Cost Heat Sinks

TO-3, TO-66, TO-220

| Standard P/N | Height Above PC Board in. (mm) | Outline Dimensions in. (mm) | Thermal Performance at Typical Load | | Semiconductor Mounting Hole Pattern | Weight lbs. (grams) |
|--------------|--------------------------------|-----------------------------|-------------------------------------|-------------------|-------------------------------------|---------------------|
| | | | Natural Convection | Forced Convection | | |
| 690-3B | 1.310 (33.3) | 1.860 (47.2)-sq | 44°C @ 7.5W | 2.0°C/W @ 400 LFM | (1) TO-3 | 0.0700 (31.75) |
| 690-66B | 1.310 (33.3) | 1.860 (47.2)-sq | 44°C @ 7.5W | 2.0°C/W @ 400 LFM | (1) TO-66 | 0.0700 (31.75) |
| 690-220B | 1.310 (33.3) | 1.860 (47.2)-sq | 44°C @ 7.5W | 2.0°C/W @ 400 LFM | (2) TO-220 | 0.0700 (31.75) |

Material: Aluminum, Black Anodized

These low-cost heat sinks provide the most power dissipation at the lowest unit cost and are available in three standard types to mount and cool one TO-3 or TO-66 metal power semiconductor type or two plastic package TO-220 power semiconductor types. For higher power

semiconductors, the 690 Series can dissipate up to 20 watts while maintaining a mounting surface temperature rise above ambient air temperature of no more than 91°C.

MECHANICAL DIMENSIONS

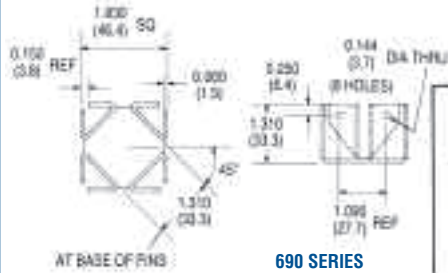

690 SERIES

Dimensions: in. (mm)

SEMICONDUCTOR MOUNTING HOLES

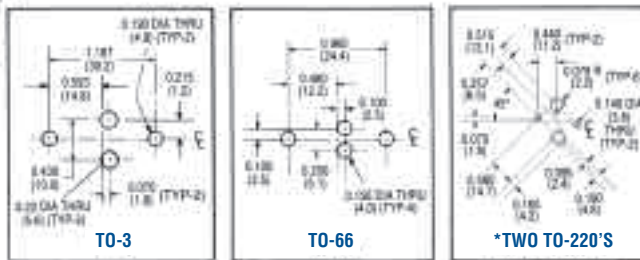

NATURAL AND FORCED CONVECTION CHARACTERISTICS

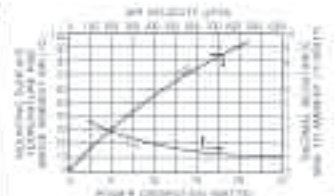

680 SERIES Maximum Efficiency Omnidirectional Heat Sinks

TO-3, TO-220



| Standard P/N | Height Above PC Board "A" in. (mm) | Horizontal Mounting Footprint Dimensions in. (mm) | Thermal Performance at Typical Load | | Semiconductor Mounting Hole Pattern | Weight lbs. (grams) |
|--------------|------------------------------------|---|-------------------------------------|-------------------|-------------------------------------|---------------------|
| | | | Natural Convection | Forced Convection | | |
| 680-5A | 0.500 (12.7) | 1.810 (46.0)-sq | 70°C @ 7.5W | 3.0°C/W @ 400 LFM | (1) TO-3 | 0.0700 (31.75) |
| 680-75A | 0.750 (19.1) | 1.810 (46.0)-sq | 58°C @ 7.5W | 2.4°C/W @ 400 LFM | (1) TO-3 | 0.0900 (40.82) |
| 680-10A | 1.000 (25.4) | 1.810 (46.0)-sq | 52°C @ 7.5W | 2.0°C/W @ 400 LFM | (1) TO-3 | 0.0980 (44.45) |
| 680-125A | 1.250 (31.8) | 1.810 (46.0)-sq | 45°C @ 7.5W | 1.5°C/W @ 400 LFM | (1) TO-3 | 0.1100 (49.90) |
| 680-5220 | 0.500 (12.7) | 1.810 (46.0)-sq | 70°C @ 7.5W | 3.0°C/W @ 400 LFM | (2) TO-220 | 0.0700 (31.75) |
| 680-75220 | 0.750 (19.1) | 1.810 (46.0)-sq | 58°C @ 7.5W | 2.4°C/W @ 400 LFM | (2) TO-220 | 0.0900 (40.82) |
| 680-10220 | 1.000 (25.4) | 1.810 (46.0)-sq | 52°C @ 7.5W | 2.0°C/W @ 400 LFM | (2) TO-220 | 0.0980 (44.45) |
| 680-125220 | 1.250 (31.8) | 1.810 (46.0)-sq | 45°C @ 7.5W | 1.5°C/W @ 400 LFM | (2) TO-220 | 0.1100 (49.90) |

Material: Aluminum, Black Anodized

Achieve optimum natural convection cooling per unit volume occupied above the printed circuit board for TO-3 (one semiconductor package per heat sink) or for two TO-220 style cases, when this low-cost heat sink is used. Any mounting attitude will provide free circulation of air in

natural convection applications. These 680 Series heat sinks can also be specified without any semiconductor mounting hole pattern by specifying suffix "K" (Example: 680-5K).

MECHANICAL DIMENSIONS

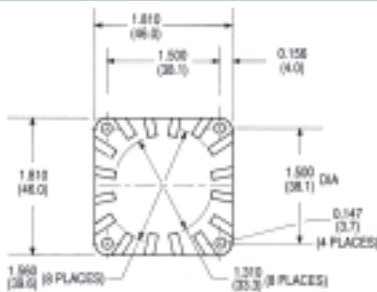

680 SERIES

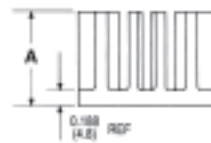

NATURAL AND FORCED CONVECTION CHARACTERISTICS

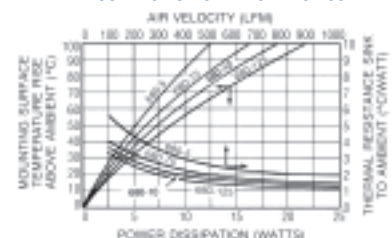

SEMICONDUCTOR MOUNTING HOLES

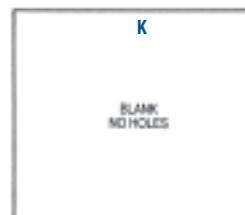
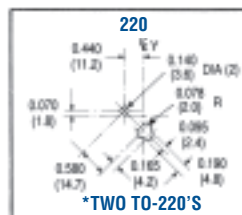
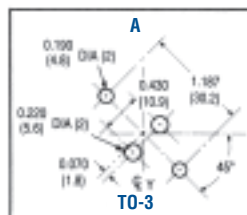

Dimensions: in. (mm)

*Only one hole pattern of two is shown. Hole patterns are symmetrical about the center lines.

BOARD LEVEL POWER SEMICONDUCTOR HEAT SINKS



601 & 603 SERIES Low-Height Heat Sinks

DO-4/DO-5 Diodes

| Standard P/N | Footprint Dimensions in. (mm) | Height in. (mm) | Mounting Hole Dia. in. (mm) | Thermal Performance at Typical Load | | Weight lbs. (grams) |
|--------------|-------------------------------|-----------------|-----------------------------|-------------------------------------|-------------------|---------------------|
| | | | | Natural Convection | Forced Convection | |
| 601E | 2.000 (50.8) x 1.250 (31.8) | 0.562 (14.3) | 0.200 (5.1) | 52°C @ 5.0W | 4.5°C/W @ 175 LFM | 0.0500 (22.68) |
| 601F | 2.000 (50.8) x 1.250 (31.8) | 0.562 (14.3) | 0.270 (6.9) | 52°C @ 5.0W | 4.5°C/W @ 175 LFM | 0.0500 (22.68) |
| 601K | 2.000 (50.8) x 1.250 (31.8) | 0.562 (14.3) | None | 52°C @ 5.0W | 4.5°C/W @ 175 LFM | 0.0500 (22.68) |
| 603K | 2.000 (50.8) x 2.000 (50.8) | 0.562 (14.3) | None | 41°C @ 5.0W | 4.0°C/W @ 175 LFM | 0.0810 (36.74) |

Material: Aluminum Alloy, Black Anodized

Use these low-height heat sinks on printed circuit board applications for TO-66 power semiconductors and DO-4 and DO-5 diodes, where close board-to-board spacing and efficient heat

dissipation are required. The 601 and 603 Series may also be attached to enclosure panels or brackets using isolation hardware where necessary.

MECHANICAL DIMENSIONS

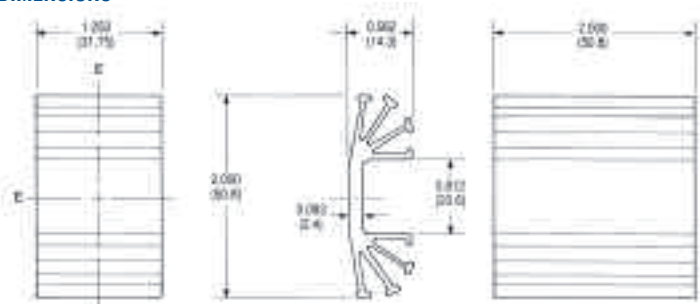

601 SERIES
(EXTRUSION PROFILE 1284)

603 SERIES
(EXTRUSION PROFILE 1284)

NATURAL AND FORCED CONVECTION CHARACTERISTICS

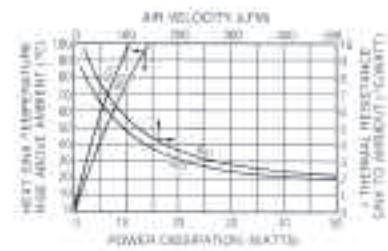

SEMICONDUCTOR MOUNTING HOLES

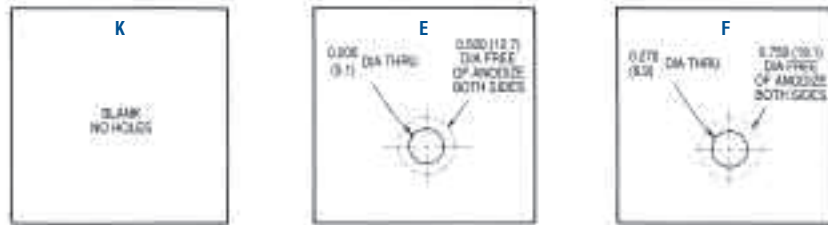

Dimensions: in. (mm)

E&F available on 601 Series only as a standard product.



641 SERIES Maximum Performance Natural Convection Heat Sink for all Metal-Case Semiconductors

TO-3

| Standard P/N | Outline Dimensions in. (mm) | Height in. (mm) | Mounting Hole Pattern | Thermal Performance at Typical Load | | Weight lbs. (grams) |
|--------------|------------------------------|-----------------|-----------------------|-------------------------------------|-------------------|---------------------|
| | | | | Natural Convection | Forced Convection | |
| 641A | 4.125 (104.8) x 3.000 (76.2) | 1.000 (25.4) | (1) TO-3 | 36°C @ 15W | 0.9°C/W @ 250 LFM | 0.2900 (131.54) |
| 641K | 4.125 (104.8) x 3.000 (76.2) | 1.000 (25.4) | None | 36°C @ 15W | 0.9°C/W @ 250 LFM | 0.2900 (131.54) |

Available with a standard TO-3 mounting hole pattern predrilled for cost-effective mounting in limited-height applications, the 641 Series provides maximum performance in natural convection with an optimized heat sink surface area. The 641K type with an open channel area of

1.300 in. (33.0) and no predrilled mounting holes can be adapted to meet mounting requirements for most metal case power semiconductor types. Material: Aluminum Alloy, Black Anodized.

MECHANICAL DIMENSIONS

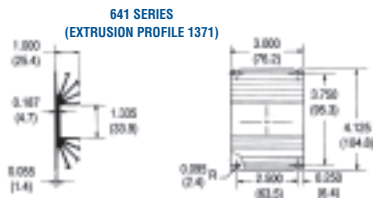

Dimensions: in. (mm)

SEMICONDUCTOR MOUNTING HOLES



NATURAL AND FORCED CONVECTION CHARACTERISTICS

