



















# Complete Hex Program



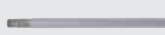



## Professional HEX Tools *Inch & Metric*













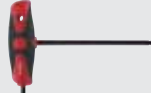

**Wiha Hex Tools Index**

	DESCRIPTION	Page
	T-handles	8
	PocketStar Fold Outs	16
	L-keys - Long/Short Nickel & Black Finish	17-20
	Insulated T-handle	21
	Insulated Hex Drivers	21
	Insulated L-keys	22
	Insulated Sockets	22
	Drive-Loc VI Blades	23
	ESD Safe Precision	26
	Precision	28
	PicoFinish	27
	SYSTEM 4 Blades	29-30
	SYSTEM 4 Micro Bits	31
	Insert/Power Bit Sets	33
	XSelectors	34
	Bit Insert & Power Bits	35-37
	Sockets	38-39

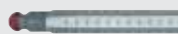







**Wiha Security Hex Index**

	DESCRIPTION	Page
	SYSTEM 4 Micro Bits	31
	Insert Bits	35-37
	Sockets	38-39

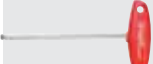



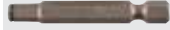

**Wiha Ball End Hex Tools Index**

	DESCRIPTION	Page
	Ball End L-keys & Sets Chrome Finish	5
	Ball End L-keys & Sets Black Finish	6-7
	Stainless Steel L-keys & Set	6
	Soft Grip T-handles Chrome & Black Finish	9-10
	3K Series Screwdrivers	14-15
	Drive-Loc VI Blades	23
	Precision	28-29
	PicoFinish Soft Grip	27
	SYSTEM 4 Blades	30
	Stubby Bit Holder Sets	32
	Ball End Hex Insert Bit	37
	Ball End Hex Socket	39



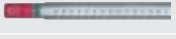

**MagicRing Screw Holding Hex Tools Index**

	DESCRIPTION	Page
	L-keys Screw Holding	4
	T-handles Screw Holding	8
	SoftFinish Screw Holding Cushion Grip	12-13
	PocketStars Screw Holding	16
	Insert Bits Screw Holding	33
	Power Bits Screw Holding	33
	Bit-Selectors Screw Holding Insert & Power Bits	33





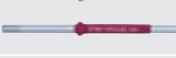

**Wiha Drive-Loc VI Index**

	<b>DESCRIPTION</b>	<b>Page</b>
	Drive-Loc VI Handle SoftFinish® Cushion Grip	23
	Drive-Loc VI Handle ESD Safe Cushion Grip	23
	Drive-Loc VI Handle MicroFinish Non-Slip Grip	23
	Drive-Loc VI Blades	23
	Ball End Hex & Hex Inch/Metric	
	Drive-Loc VI Blade Set	23





**Wiha TorqueControl Tools Index**

	<b>DESCRIPTION</b>	<b>Page</b>
	TorqueFix Handle	24
	TorqueVario Handle	24
	Hex Inch/Metric Blades	24
	T-handle Torque Tools	25
	Hex Inch/Metric Blades	25







**Wiha Bit Sets Index**

	<b>DESCRIPTION</b>	<b>Page</b>
	MicroBit Sets	31
	Stubby Bit Holder Sets	32
	Topra Bit Sets	32
	Bit Selector Sets	33
	Power Bit Belt Packs	34
	XSelectors	34
	PokitPaks	34

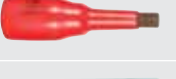
**Wiha Power & Insert Bits Index**

	<b>DESCRIPTION</b>	<b>Page</b>
	MagicRing Hex Inch & Metric Insert/Power Bits	33
	Hex Inch & Metric Insert/Power Bits	35-37
	Security Bits Inch & Metric Insert/Power Bits	36
	Ball End Hex Inch & Metric	37
	Stainless Steel Metric	36

**Wiha Sockets & Sets Index**

	<b>DESCRIPTION</b>	<b>Page</b>
	Insulated Sockets	22
	Hex Bit Sockets 1/4" Drive	38-39
	Hex Bit Sockets 3/8" Drive	39
	Ball End Sockets	39
	6" Bit Sockets 1/4" & 3/8" Drive	38
	Socket Sets	40

### MagicRing Ball End Hex Keys

**Ball End Hex Keys**  
Chamfered ends for easy insertion

**Ball End Hex Keys**  
CVM steel, hardened, hard chromed, screw holding

**ProStar Holder (9-13 pc. Sets)**  
Sliding front detachable

**ProStar Holder**  
Every key can be taken out separately without having to move another key

U.S. Patent 6,302,001 B1

Hard Chrome Finish

### 669 MagicRing Ball End Metric Hex L-key, Long

Blade CVM steel, hardened, hard chrome finish.

Item No.	mm	mm	mm	lbs.	pkg.	
66904*	1.5	90	14	.01	10	No Ring
66908*	2.0	99	16	.01	10	No Ring
66912*	2.5	111	18	.01	10	No Ring
<b>MagicRing</b>						
66916	3.0	125	20	.02	10	
66920	4.0	138	25	.04	10	
66924	5.0	158	28	.07	10	
66928	6.0	178	32	.12	10	
66936	8.0	198	36	.23	10	
66944	10.0	221	40	.40	10	

\* Standard Ball - No Ring

Hard Chrome Finish

### 66990 9 Piece MagicRing Long Metric Ball End Hex L-key Set, In ProStar Holder

Blade CVM steel, hardened, hard chrome finish.

Item No.	mm	mm	mm	mm	mm	lbs.
66990	66904*	1.5	90	66924	5.0	158
	66908*	2.0	99	66928	6.0	178
	66912*	2.5	111	66936	8.0	197
	66916	3.0	125	66944	10.0	221
	66920	4.0	138			

\* Standard Ball - No Ring

# Screw Holding Hex Tools!

Hard Chrome Finish

### 669 MagicRing Ball End Inch Hex L-key, Long

Blade CVM steel, hardened, hard chrome finish.

Item No.	Inch	Inch	Inch	lbs.	pkg.	
66945*	.050	2.8	.5	.01	10	No Ring
66946*	1/16	3.1	.6	.01	10	No Ring
66947*	5/64	3.5	.7	.01	10	No Ring
66950*	3/32	3.9	.7	.01	10	No Ring
66952*	7/64	4.3	.7	.02	10	No Ring
<b>MagicRing</b>						
66953	1/8	4.6	.8	.02	10	
66955	9/64	5.2	.9	.03	10	
66956	5/32	5.7	1.0	.04	10	
66959	3/16	6.2	1.1	.06	10	
66962	7/32	6.7	1.2	.09	10	
66965	1/4	7.3	1.2	.13	10	
66968	5/16	8.0	1.4	.22	10	
66971	3/8	8.8	1.6	.36	10	

\* Standard Ball - No Ring

Hard Chrome Finish

### 66991 13 Piece MagicRing Long Inch Ball End Hex L-key Set, In ProStar Holder

Blade CVM steel, hardened, hard chrome finish.

Item No.	Inch	Inch	Inch	Inch	lbs.
66991	66945*	.050	2.8	66956	5/32 5.7
	66946*	1/16	3.1	66959	3/16 6.2
	66947*	5/64	3.5	66962	7/32 6.7
	66950*	3/32	3.9	66965	1/4 7.3
	66952*	7/64	4.3	66968	5/16 8.0
	66953	1/8	4.6	66971	3/8 8.8
	66955	9/64	5.2		

\* Standard Ball - No Ring

### 66992 22 Piece Combination MagicRing L-key Set, In ProStar Holder

Blade CVM steel, hardened, hard chrome finish.

Item No.	lbs.
66992	Set includes Inch & Metric: 2.21
	66990 Set - 1.5*, 2.0*, 2.5*, 3.0, 4.0, 5.0, 6.0, 8.0, 10.0mm
	66991 Set - .050*, 1/16*, 5/64*, 3/32*, 7/64*, 1/8, 9/64, 5/32, 3/16, 7/32, 1/4, 5/16, 3/8"

\* Standard Ball - No Ring

**Metric Ball End Hex Keys Chrome Finish**

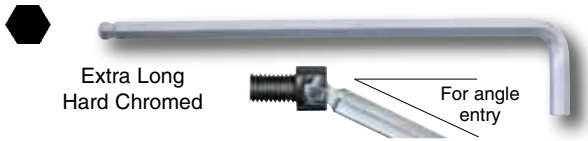

**669 Ball End Metric Hex L-key, Long Arm**  
Blade CVM steel, hardened, hard chrome finish.

Item No.	mm	mm	mm	lbs.	pkg.
66904	1.5	90	14	.004	10
66908	2.0	99	16	.007	10
66912	2.5	111	18	.012	10
66918	3.0	125	20	.019	10
66922	4.0	138	25	.042	10
66926	5.0	158	28	.072	10
66930	6.0	178	32	.12	10
66937	8.0	198	36	.23	10
66938	10.0	221	40	.40	10



**66994 9 Piece Metric Ball End Hex Long L-key Set**

Item No.	Metric: 1.5, 2.0, 2.5, 3.0, 4.0, 5.0, 6.0, 8.0, 10.0mm	lbs. .98
66994		

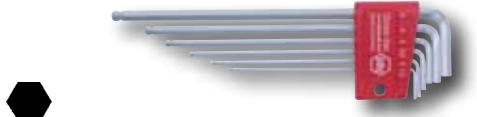

**66995 6 Piece Metric Ball End Hex Long L-key Set**

Item No.	Metric: 1.5, 2.0, 2.5, 3.0, 4.0, 5.0mm	lbs. .21
66995		



**66998 11 Piece Metric Ball End Hex Long L-key Set**

Item No.	Metric: 1.5, 2.0, 2.5, 3.0, 4.0, 5.0, 6.0, 7.0, 8.0, 9.0, 10.0mm	lbs. 1.36
66998		

**Inch Ball End Hex Keys Chrome Finish**

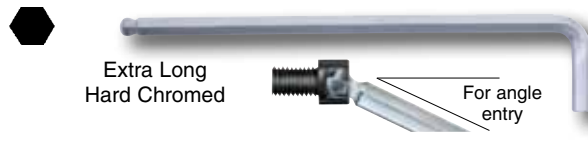

**369 Ball End Inch Hex L-key, Long Arm**  
Blade CVM steel, hardened, hard chrome finish.

Item No.	Inch	Inch	Inch	lbs.	pkg.
36940	.050	2.8	.5	.002	10
36941	1/16	3.1	.6	.004	10
36942	5/64	3.5	.7	.007	10
36943	3/32	3.9	.7	.010	10
36948	7/64	4.3	.7	.016	10
36949	1/8	4.6	.8	.021	10
36951	9/64	5.2	.9	.029	10
36954	5/32	5.7	1.0	.035	10
36957	3/16	6.2	1.1	.059	10
36958	7/32	6.7	1.2	.092	10
36960	1/4	7.3	1.2	.13	10
36961	5/16	8.0	1.4	.22	10
36963	3/8	8.8	1.6	.36	10



**36998 13 Piece Inch Ball End Hex Long L-key Set, In Plastic Holder**  
Blade CVM steel, hardened, hard chrome finish.

Item No.	Inch: .050, 1/16, 5/64, 3/32, 7/64, 1/8, 9/64, 5/32, 3/16, 7/32, 1/4, 5/16, 3/8"	lbs. 1.0
36998		



**66993 2 Pack Inch & Metric Ball End Hex L-key Sets** High alloy CVM steel, hardened, hard chrome finish. In molded Holders

Item No	lbs.
66993	2.0

2 Sets with 22 L-keys include:  
Metric: 1.5, 2.0, 2.5, 3.0, 4.0, 5.0, 6.0, 8.0, 10.0mm  
Inch: .050, 1/16, 5/64, 3/32, 7/64, 1/8, 9/64, 5/32, 3/16, 7/32, 1/4, 5/16, 3/8"

**ErgoStar Ball End Hex Keys Chrome Finish**



Fast Auto Open Key Holder

**66996 9 Piece ErgoStar Metric Ball End Hex Long L-key Set**

Item No.	Metric: 1.5, 2.0, 2.5, 3.0, 4.0, 5.0,	
66996	6.0, 8.0, 10.0mm	lbs. 1.02



Fast Auto Open Key Holder

**66988 13 Piece ErgoStar Inch Ball End Hex Long L-key Set**

Item No.	Inch: .050, 1/16, 5/64, 3/32, 7/64, 1/8,	
66988	9/64, 5/32, 3/16, 7/32, 1/4, 5/16, 3/8"	lbs. 1.08



Fast Auto Open Key Holder

**66982 22 Piece ErgoStar Inch/Metric Ball End Hex Long L-key Set**

Item No.	Inch: .050, 1/16, 5/64, 3/32, 7/64, 1/8,	
66982	9/64, 5/32, 3/16, 7/32, 1/4, 5/16, 3/8"	lbs. 2.10
	Metric: 1.5, 2.0, 2.5, 3.0, 4.0, 5.0,	
	6.0, 8.0, 10.0mm	



**ErgoStar Inch Ball End L-key Set**

- Patented ErgoStar auto open key holder
- Keys of chrome-vanadium-molybdenum steel
- 60HRC through hardened durability
- Hard chrome finish for best wear resistance

**Stainless Steel Metric Ball End Hex Key**



For angle entry

**369 Stainless Steel Ball End Metric Hex L-key, Long Arm**

Blade CVM steel, hardened, hard chrome finish.

Item No.	mm	mm	mm	lbs.	pkg.
36911	1.5	91	14	.004	10
36913	2.0	101	18	.007	10
36914	2.5	113	20	.012	10
36915	3.0	128	23	.020	10
36917	4.0	142	29	.050	10
36918	5.0	163	33	.074	10
36919	6.0	184	38	.13	10
36921	8.0	206	44	.25	10
36922	10.0	231	50	.44	10



**36988 9 Pc. Stainless Steel Ball End L-key Set**

In molded ergo handle

Item No.	Metric: 1.5, 2.0, 2.5, 3.0, 4.0, 5.0mm	
36988	6.0, 8.0, 10.0mm	lbs. .88

**L-keys Black Finish Sets**



Inch & Metric

**36995 2 Pack Inch & Metric Ball End Hex L-key Sets**

High alloy CVM steel, hardened, black finish. Molded ergonomic handle.

Item No	2 Sets with 22 L-keys include:	
36995	1.5, 2.0, 2.5, 3.0, 4.0, 5.0, 6.0, 8.0, 10.0mm	lbs. 2.21
	Sizes: .050, 1/16, 5/64, 3/32, 7/64, 1/8, 9/64, 5/32, 3/16, 7/32, 1/4, 5/16, 3/8"	



Inch & Metric

TORX

**36696 3 Pack Inch & Metric Ball End Hex & TORX L-key Sets**

High alloy CVM steel, hardened, black finish. Molded ergonomic handle.

Item No	3 Sets with Hex & TORX L-keys include:	
36696	1.5, 2.0, 2.5, 3.0, 4.0, 5.0, 6.0, 8.0, 10.0mm	lbs.
	Inch: .050, 1/16, 5/64, 3/32, 7/64, 1/8, 9/64, 5/32, 3/16, 7/32, 1/4, 5/16, 3/8"	
	TORX: T6, T7, T8, T9, T10, T15, T20, T25, T27, T30	

**Metric Ball End Hex Keys Black Finish**



**Ball End Hex Keys**  
Chamfered ends for easy insertion

**Ball End Hex L-keys**  
Working angle up to 30°

See Short Arm L-keys on Page 19 & 20



For angle entry

**369 Ball End Hex Metric L-key, Long Arm**  
Blade CVM steel, hardened, black finish.

Item No.	mm	mm	mm	lbs.	pkg.
36904	1.5	90	14	.004	10
36908	2.0	99	16	.007	10
36912	2.5	111	18	.012	10
36916	3.0	125	20	.019	10
36920	4.0	138	25	.042	10
36924	5.0	158	28	.072	10
36928	6.0	178	32	.12	10
36936	8.0	198	36	.23	10
36944	10.0	221	40	.40	10



**36990 9 Piece Metric Ball End Hex Long L-key Set**  
Blade chrome-vanadium-molybdenum steel, hardened, black finish.

Item No.	mm	mm	mm	mm	lbs.		
36990	36904	1.5	90	36924	5.0	158	.98
	36908	2.0	99	36928	6.0	178	
	36912	2.5	111	36936	8.0	198	
	36916	3.0	125	36944	10.0	221	
	36920	4.0	138				

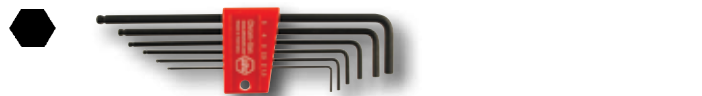

**36992 6 Piece Metric Ball End Long Hex L-key Set**  
Blade chrome-vanadium-molybdenum steel, hardened, black finish.

Item No.	mm	mm	mm	mm	lbs.		
36992	36904	1.5	90	36916	3.0	125	.30
	36908	2.0	99	36920	4.0	138	
	36912	2.5	111	36924	5.0	158	

**Inch Ball End Hex Keys Black Finish**

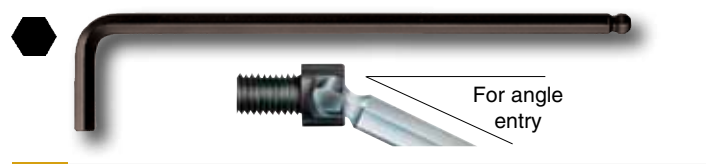

For angle entry

**369 Ball End Hex Inch L-key, Long Arm**  
Blade CVM steel, hardened, black finish.

Item No.	Inch	Inch	Inch	lbs.	pkg.
36945	.050	2.8	.5	.002	10
36946	1/16	3.1	.6	.004	10
36947	5/64	3.5	.7	.007	10
36950	3/32	3.9	.7	.010	10
36952	7/64	4.3	.7	.016	10
36953	1/8	4.6	.8	.021	10
36955	9/64	5.2	.9	.029	10
36956	5/32	5.7	1.0	.035	10
36959	3/16	6.2	1.1	.059	10
36962	7/32	6.7	1.2	.092	10
36965	1/4	7.3	1.2	.13	10
36968	5/16	8.0	1.4	.22	10
36971	3/8	8.8	1.6	.36	10



**36991 13 Piece Inch Ball End Hex Long L-key Set**  
Blade chrome-vanadium-molybdenum steel, hardened, black finish.

Item No.	lbs.
36991	1.0

13 pc. set includes:  
.050, 1/16, 5/64, 3/32, 7/64, 1/8, 9/64, 5/32, 3/16, 7/32, 1/4, 5/16, 3/8"



**36993 8 Piece Inch Ball End Hex Long L-key Set**  
Blade chrome-vanadium-molybdenum steel, hardened, black finish.

Item No.	lbs.
36993	.62

8 pc. set includes:  
5/64, 3/32, 1/8, 5/32, 3/16, 7/32, 1/4, 5/16"

**Wiha MagicRing Screw Holding T-handle**

**Hole for hanging**

**Proportioned ergonomic handle designed for high torque**

**Handle is molded directly onto blade**

**Blade CVM tool steel, hardened, hard chrome finish**

**Smooth edges prevent injuries & eliminate pressure marks**

**Screw Holding Hex Tools**

**540 MagicRing Hex Metric Ball End, With Wiha T-handle**  
Blade CVM steel, hardened, hard chromed. Ball end for easy insertion. Wiha T-handle high quality plastic, impact resistant.

Item No.	mm	mm	mm	mm	Inch	lbs.	pkg.
54040	4.0	150	80	176	6.9	.08	10
54050	5.0	150	100	182	7.1	.14	10
54060	6.0	150	100	182	7.1	.17	10
54080	8.0	200	100	232	9.1	.29	10
54086	10.0	200	120	238	9.3	.49	10

**540 MagicRing Hex Inch Ball End, With Wiha T-handle**  
Blade CVM steel, hardened, hard chromed. Ball end for easy insertion. Wiha T-handle high quality plastic, impact resistant.

Item No.	Inch	Inch	Inch	Inch	lbs.	pkg.
54012	5/32	5.8	2.8	6.9	.08	10
54014	3/16	5.8	4.0	7.2	.14	10
54016	7/32	5.8	4.0	7.2	.16	10
54018	1/4	5.8	4.0	7.2	.19	10
54022	5/16	7.8	4.0	7.2	.29	10
54024	3/8	7.8	4.7	7.5	.45	10



**54090 5 Piece MagicRing Ball End T-handle Set, Metric Sizes**  
Blade chrome-vanadium-molybdenum steel, hardened, hard chromed. Wiha T-handle high quality plastic, impact resistant.

Item No.	mm	mm	mm	mm	lbs.
54090	54040	4.0	150	54080	8.0 200 1.49
	54050	5.0	150	54086	10.0 200
	54060	6.0	150		



**54091 6 Piece MagicRing Ball End T-handle Set, Inch Sizes**  
Blade chrome-vanadium-molybdenum steel, hardened, hard chromed. Wiha T-handle high quality plastic, impact resistant.

Item No.	Inch	Inch	Inch	Inch	lbs.
54091	54012	5/32	5.8	54018	1/4 5.8 1.59
	54014	3/16	5.8	54022	5/16 7.8
	54016	7/32	5.8	54024	3/8 7.8



**Wiha Soft Grip Dual Drive T-handle**

**Two Tools In One!**

Through the handle side torque drive

Ball & Standard Hex In One Powerful Tool

Two component soft grip handle

Ball Hex - Blade CVM tool steel, through hardened durability, hard chrome finish

**Maximum Comfort & Maximum Power**

Hard Chrome Finish

For angle entry

- CVM steel, hardened, hard chrome finish
- Ball tip for speed & easy insertion
- Wiha soft grip are molded on and include through the handle side torque drive.

**540 Soft Grip Ball End Hex Metric Dual Drive T-handle**

Item No.	mm	mm	Tip	lbs.	pkg.
54020	2.0	150	Ball	.06	10
54025	2.5	150	Ball	.06	10
54030	3.0	150	Ball	.07	10
54042	4.0	150	Ball	.09	10
54052	5.0	150	Ball	.18	10
54062	6.0	150	Ball	.21	10
54082	8.0	200	Ball	.35	10
54088	10.0	200	Ball	.55	10

**54095 8 Pc. Ball End Hex Metric Soft Grip T-handle Set- No stand**

Item No.	mm	mm	mm	mm	lbs.		
54095	54020	2.0	150	54052	5.0	150	1.90
	54025	2.5	150	54062	6.0	150	
	54030	3.0	150	54082	8.0	200	
	54042	4.0	150	54088	10.0	200	

**54092 8 Piece Ball End Hex Metric Soft Grip T-handle Set**  
 Blade chrome-vanadium-molybdenum steel, hardened, chrome finish.  
 Wiha soft grips are molded on with through the handle side torque drive.

In metal stand

Item No.	mm	mm	lbs.	
54092	54020	2.0	150	3.34
	54025	2.5	150	
	54030	3.0	150	
	54042	4.0	150	
	54052	5.0	150	
	54062	6.0	150	
	54082	8.0	200	
	54088	10.0	200	

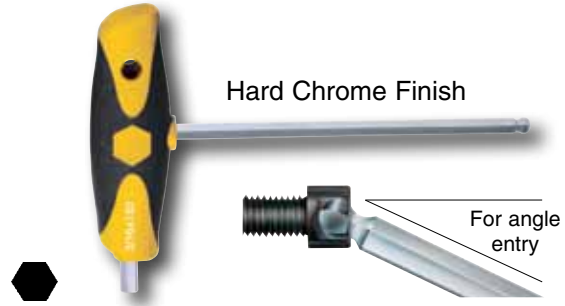

**540 Soft Grip Ball End Hex Inch Dual Drive T-handle** CVM steel, hardened, hard chrome finish. Ball tip for speed & easy insertion. Wiha soft grips are molded on with through the handle side torque drive.

Item No.	Inch	Inch	Tip	lbs.	pkg.
54007	3/32	5.9	Ball	.06	10
54008	7/64	5.9	Ball	.07	10
54009	1/8	5.9	Ball	.08	10
54010	9/64	5.9	Ball	.08	10
54001	5/32	5.9	Ball	.09	10
54002	3/16	5.9	Ball	.17	10
54003	7/32	5.9	Ball	.20	10
54004	1/4	5.9	Ball	.23	10
54005	5/16	7.9	Ball	.35	10
54006	3/8	7.9	Ball	.51	10

**54097 10 Pc. Ball End Hex Inch Soft Grip T-handle Set- No stand**

Item No.	Inch	Inch	Inch	Inch	lbs.		
54097	54007	3/32	5.9	54002	3/16	5.9	2.15
	54008	7/64	5.9	54003	7/32	5.9	
	54009	1/8	5.9	54004	1/4	5.9	
	54010	9/64	5.9	54005	5/16	7.9	
	54001	5/32	5.9	54006	3/8	7.9	



**54094 8 Piece Ball End Hex Inch Soft Grip T-handle Set**  
 Blade chrome-vanadium-molybdenum steel, hardened, chrome finish.  
 Wiha soft grips are molded on with through the handle side torque drive.

Item No.	Inch	Inch	Inch	Inch	lbs.		
54094	54009	1/8	5.9	54003	7/32	5.9	3.37
	54010	9/64	5.9	54004	1/4	5.9	
	54001	5/32	5.9	54005	5/16	5.9	
	54002	3/16	5.9	54006	3/8	7.9	

**Soft Grip Dual Drive T-handle - Black Finish**



Black Finish

**334** **Soft Grip Ball End Hex Metric Dual Drive T-handle** CVM steel, hardened, black finish. Ball tip for speed & easy insertion. Wiha soft grip are molded on with through the handle side torque drive.

Item No.	mm	mm	lbs.	pkg.
33442*	2.0	150	.06	10
33444*	2.5	150	.06	10
33446*	3.0	150	.07	10
33448	4.0	150	.09	10
33450	5.0	150	.18	10
33452	6.0	150	.21	10
33454	8.0	200	.35	10
33458	10.0	200	.55	10

\*No Ball - Standard Hex



**33496 8 Pc. Ball End Hex Metric Soft Grip T-handle Set**

Blade CVM steel, hardened, black finish. Wiha soft grip are molded on with through the handle side torque drive.

Item No.	mm	mm	mm	mm	lbs.		
33496	33442*	2.0	150	33450	5.0	150	2.04
	33444*	2.5	150	33452	6.0	150	
	33446*	3.0	150	33454	8.0	200	
	33448	4.0	150	33458	10.0	200	

\*No Ball - Standard Hex

**33489 8 Piece Ball End Hex Metric Soft Grip T-handle Set**

Blade chrome-vanadium-molybdenum steel, hardened, black finish. Wiha soft grips are molded on with through the handle side torque drive.

Item No.	mm	mm	lbs.	
33489	33442*	2.0	150	3.33
	33444*	2.5	150	
	33446*	3.0	150	
	33448	4.0	150	
	33450	5.0	150	
	33452	6.0	150	
	33454	8.0	200	
	33458	10.0	200	

\*No Ball - Standard Hex

In metal stand

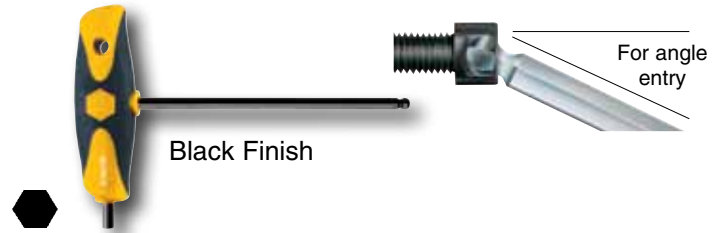

Black Finish

**334** **Soft Grip Ball End Hex Inch Dual Drive T-handle** CVM steel, hardened, black finish. Ball tip for speed & easy insertion. Wiha soft grips are molded on with through the handle side torque drive.

Item No.	Inch	Inch	lbs.	pkg.
33418*	5/64	5.9	.06	10
33420*	3/32	5.9	.06	10
33422*	7/64	5.9	.07	10
33424*	1/8	5.9	.08	10
33426*	9/64	5.9	.08	10
33428	5/32	5.9	.09	10
33430	3/16	5.9	.17	10
33432	7/32	5.9	.20	10
33433	1/4	5.9	.23	10
33439	5/16	7.9	.35	10
33440	3/8	7.9	.51	10

\*No Ball - Standard Hex

**33494 11 Pc. Ball End Hex Inch Soft Grip Dual Drive T-handle Set**

Item No.	Inch	Inch	Inch	Inch	lbs.		
33494	33418*	5/64	5.9	33430	3/16	5.9	2.39
	33420*	3/32	5.9	33432	7/32	5.9	
	33422*	7/64	5.9	33433	1/4	5.9	
	33424*	1/8	5.9	33439	5/16	7.9	
	33426*	9/64	5.9	33440	3/8	7.9	
	33428	5/32	5.9				

\*No Ball - Standard Hex

**33498 8 Piece Ball End Hex Inch Soft Grip T-handle Set**

Item No.	Inch	Inch	Inch	Inch	lbs.		
33498	33424*	1/8	5.9	33432	7/32	5.9	2.15
	33426*	9/64	5.9	33433	1/4	5.9	
	33428	5/32	5.9	33439	5/16	7.9	
	33430	3/16	5.9	33440	3/8	7.9	

\*No Ball - Standard Hex

**33499 8 Piece Ball End Hex Inch Soft Grip T-handle Set**

Blade chrome-vanadium-molybdenum steel, hardened, black finish. Wiha soft grips are molded on with through the handle side torque drive.

Item No.	Inch	Inch	lbs.	
33499	33424*	1/8	5.9	3.46
	33426*	9/64	5.9	
	33428	5/32	5.9	
	33430	3/16	5.9	
	33432	7/32	5.9	
	33433	1/4	5.9	
	33439	5/16	7.9	
	33440	3/8	7.9	

\*No Ball - Standard Hex

In metal stand

## Wiha T-handle Hex Tools

Ergonomic handle design for high torque

Hole for hanging



Handle is molded directly onto blade

Smooth edges prevent injuries & eliminate pressure marks

Blade CVM tool steel, hardened, nickel-plated

Yellow = Inch  
Red = Metric



**33492 10 Piece Hex Driver T-handle Set, Inch Sizes**

Item No.	Hex Size	Length (Inch)	Weight (lbs.)
33453	3/32	6.0	1.74
33456	7/64	6.0	
33459	1/8	6.0	
33462	9/64	6.0	
33465	5/32	6.0	
33468	3/16	6.0	
33471	7/32	6.0	
33474	1/4	6.0	
33477	5/16	6.0	
33480	3/8	6.0	

**334 Hex Inch & Metric Drivers, With Wiha T-handle** Chamfered tip for easy insertion. Wiha-T-handle high quality plastic, impact resistant.

Item No.	Hex Size	Length (Inch)	Length (mm)	Weight (lbs.)	Weight (kg)	Pkg.
33453	3/32	6.0	2.8	7.0	.05	10
33456	7/64	6.0	2.8	7.0	.05	10
33459	1/8	6.0	2.8	7.0	.06	10
33462	9/64	6.0	2.8	7.0	.07	10
33465	5/32	6.0	2.8	7.0	.08	10
33468	3/16	6.0	3.5	7.0	.13	10
33471	7/32	6.0	3.5	7.0	.16	10
33474	1/4	6.0	3.5	7.0	.18	10
33477	5/16	6.0	3.5	7.0	.25	10
33480	3/8	6.0	4.1	7.0	.39	10
33401	2.0	100	80	126	4.9	.05 10
33436	2.0	200	80	226	8.9	.05 10
33402	2.5	100	80	126	4.9	.05 10
33437	2.5	200	80	226	8.9	.08 10
33403	3.0	100	80	126	4.9	.05 10
33404	3.0	150	80	176	6.9	.08 10
33405	3.0	200	80	226	8.9	.09 10
33435	3.0	350	100	382	15.0	.22 10
33406	4.0	100	80	126	4.9	.07 10
33407	4.0	150	80	176	6.9	.10 10
33408	4.0	200	80	226	8.9	.09 10
33438	4.0	350	100	382	15.0	.26 10
33409	5.0	100	100	132	5.2	.13 10
33410	5.0	150	100	182	7.1	.17 10
33411	5.0	200	100	232	9.1	.16 10
33412	5.0	350	100	382	15.0	.26 10
33413	5.0	450	120	488	19.1	.53 10
33414	6.0	100	100	132	5.2	.14 10
33415	6.0	150	100	182	7.1	.18 10
33416	6.0	200	100	232	9.1	.20 10
33417	6.0	350	100	382	15.0	.32 10
33419	7.0	200	100	232	9.1	.22 10
33421	8.0	100	100	132	5.2	.20 10
33423	8.0	200	100	232	9.1	.29 10
33434	8.0	350	100	372	14.6	.48 10
33425	10.0	100	120	138	5.4	.34 10
33427	10.0	200	120	238	9.3	.49 10
33429	12.0	200	120	238	9.3	.58 10



**33493 8 Piece Hex Driver T-handle Set, Metric Sizes**

Item No.	Hex Size (mm)	Length (mm)	Weight (lbs.)
33401	2.0	100	1.64
33402	2.5	100	
33403	3.0	100	
33406	4.0	100	
33409	5.0	100	
33416	6.0	200	
33423	8.0	200	
33427	10.0	200	



**33484 8 Pc. Hex Driver T-handle Set, Inch Sizes - In metal stand**

Item No.	Hex Size	Length (Inch)	Weight (lbs.)
33459	1/8	6.0	3.07
33462	9/64	6.0	
33465	5/32	6.0	
33468	3/16	6.0	
33471	7/32	6.0	
33474	1/4	6.0	
33477	5/16	6.0	
33480	3/8	6.0	

**33488 8 Pc. Hex Driver T-handle Set, Metric Sizes - In metal stand**

Item No.	Hex Size (mm)	Length (mm)	Weight (lbs.)
33401	2.0	100	3.07
33402	2.5	100	
33403	3.0	100	
33406	4.0	100	
33410	5.0	150	
33415	6.0	150	
33423	8.0	200	
33427	10.0	200	



**Wiha MagicRing SoftFinish® Hex Drivers**

**Screw Holding Hex Tools**



Hard Chrome Finish

**367 MagicRing Ball End Hex-Driver Inch, With Wiha-SoftFinish® Handle** Hex blade, high alloy CVM steel, hardened, hard chromed. Wiha-SoftFinish® handle, multi-component, cushion grip.

Item No.	Hex	Inch	Inch	mm	mm	lbs.	pkg.
36710*	Hex	.050	3.1	80	179	.06	10
36713*	Hex	1/16	3.1	80	204	.06	10
36716*	Hex	5/64	3.9	100	204	.07	10
36719*	Hex	3/32	3.9	100	204	.07	10
36723*	Hex	7/64	3.9	100	211	.07	10
<b>With MagicRing</b>							
36726	Hex	1/8	3.9	100	243	.12	10
36728	Hex	9/64	3.9	100	243	.12	10
36732	Hex	5/32	5.0	125	271	.12	10
36734	Hex	3/16	6.0	150	271	.16	10
36736	Hex	7/32	6.0	150	271	.23	10
36738	Hex	1/4	6.0	150	271	.25	10
36742	Hex	5/16	8.0	200	271	.37	10
36744	Hex	3/8	8.0	200	271	.54	10

\* Standard Ball - No Ring

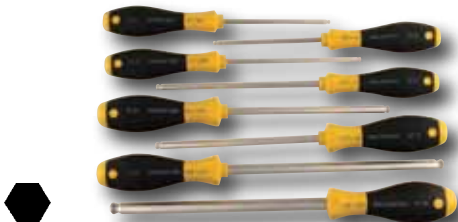

**36793 8 Piece MagicRing Inch Ball End Screwdriver Set** Hex blade chrome-vanadium-molybdenum steel, hardened, hard chromed. Wiha-SoftFinish® handle, multi-component, cushion grip.

Item No.	Hex	Inch	Inch	Hex	Inch	Inch	lbs.	
36793	Hex	36726	1/8	4.0	36736	7/32	6.0	2.25
		36728	9/64	4.0	36738	1/4	6.0	
		36732	5/32	5.0	36742	5/16	8.0	
		36734	3/16	6.0	36744	3/8	8.0	

**Don't Drop That Screw!**  
**Save Valuable Time!**  
**Improve Productivity!**  
**Make The Job Easy!**



**36791 13 Piece MagicRing Inch Ball End Screwdriver Set** Hex blade chrome-vanadium-molybdenum steel, hardened, hard chromed. Wiha-SoftFinish® handle, multi-component, cushion grip.

Item No.	Hex	Inch	Inch	Hex	Inch	Inch	lbs.	
36791	Hex	36710*	.050	3.0	36732	5/32	5.0	2.58
		36713*	1/16	3.0	36734	3/16	6.0	
		36716*	5/64	4.0	36736	7/32	6.0	
		36719*	3/32	4.0	36738	1/4	6.0	
		36723*	7/64	4.0	36742	5/16	8.0	
		36726	1/8	4.0	36744	3/8	8.0	
		36728	9/64	4.0				

\* Standard Ball - No Ring



**36794 6 Piece MagicRing Inch Ball End Screwdriver Set** Hex blade chrome-vanadium-molybdenum steel, hardened, hard chromed. Wiha-SoftFinish® handle, multi-component, cushion grip.

Item No.	Hex	Inch	Inch	Hex	Inch	Inch	lbs.	
36794	Hex	36726	1/8	4.0	36734	3/16	6.0	1.34
		36728	9/64	4.0	36736	7/32	6.0	
		36732	5/32	5.0	36738	1/4	6.0	

**Wiha MagicRing SoftFinish® Hex Drivers**

**Screw Holding Hex Tools**



**Don't Drop That Screw!**  
**Save Valuable Time!**  
**Improve Productivity!**  
**Make The Job Easy!**



**367 MagicRing Ball End Hex Driver Metric, With Wiha-SoftFinish®**

**Handle** Hex blade, high alloy CVM steel, hardened, hard chromed. Wiha-SoftFinish® handle, multi-component, cushion grip.

Item No.	mm	mm	mm	lbs.	pkg.
36715*	1.5	75	179	.06	10
36720*	2.0	100	204	.07	10
36725*	2.5	100	204	.07	10
<b>With MagicRing</b>					
36730	3.0	100	204	.07	10
36740	4.0	125	211	.12	10
36750	5.0	150	243	.16	10
36760	6.0	150	243	.23	10
36780	8.0	200	268	.37	10
36786	10.0	200	271	.54	10

\* Standard Ball - No Ring

Hardened spring steel retaining ring holds screws on

Hard chrome super durable corrosion resistant finish

Precision machined for exact fit

Made from Wiha exclusive CVM hardened tool steel

**36790 9 Piece MagicRing Metric Ball End Hex Screwdriver Set**

Hex blade chrome-vanadium-molybdenum steel, hardened, hard chromed. Wiha-SoftFinish® handle, multi-component, cushion grip.

Item No.	mm	mm	mm	mm	lbs.		
36790	36715*	1.5	75	36750	5.0	150	2.06
	36720*	2.0	100	36760	6.0	150	
	36725*	2.5	100	36780	8.0	200	
	36730	3.0	100	36786	10.0	200	
	36740	4.0	125				

\* Standard Ball - No Ring



**36792 6 Piece MagicRing Metric Ball End Hex Screwdriver Set**

Hex blade chrome-vanadium-molybdenum steel, hardened, hard chromed. Wiha-SoftFinish® handle, multi-component, cushion grip.

Item No.	mm	mm	mm	mm	lbs.		
36792	36730	3.0	100	36760	6.0	150	1.86
	36740	4.0	125	36780	8.0	200	
	36750	5.0	150	36786	10.0	200	

**Wiha Ball End 3K Series Drivers & Sets**

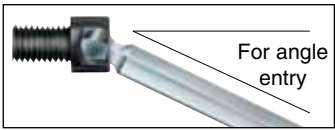

Inch / Soft Grip

**467 Ball End Hex Inch Drivers, With 3K Ergo Soft Grip Handles**

Blades of CVM special steel, hardened, black finish. Molded on Wiha-3K Ergo soft grip handles.

Item No.	Hex	Inch	Inch	lbs.	pkg.
46702	.050	2.9	6.3	.07	10
46704	1/16	2.9	6.3	.07	10
46706	5/64	3.9	7.3	.07	10
46708	3/32	3.9	7.3	.07	10
46710	7/64	3.9	7.3	.07	10
46712	1/8	3.9	7.7	.09	10
46714	9/64	3.9	7.7	.10	10
46716	5/32	3.9	7.7	.11	10
46718	3/16	3.9	7.7	.12	10
46722	7/32	5.9	10.0	.19	10
46724	1/4	5.9	10.0	.22	10
46726	5/16	7.9	12.0	.34	10
46728	3/8	7.9	12.5	.48	10

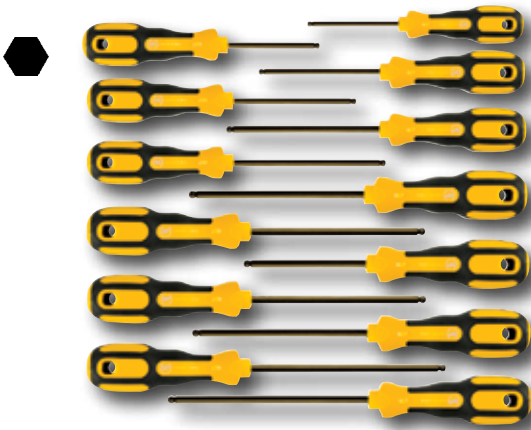

**46797 13 Piece 3K Ergo Inch Ball End Hex Screwdriver Set**

Blades of CVM special steel, hardened, black finish. Molded on Wiha-3k Ergo soft grip handles.

Item No.	Hex	Inch	Inch	Inch	Inch	lbs.
46797	46702	.050	2.9	46716	5/32 3.9	2.40
	46704	1/16	2.9	46718	3/16 2.9	
	46706	5/64	3.9	46722	7/32 5.9	
	46708	3/32	3.9	46724	1/4 5.9	
	46710	7/64	3.9	46726	5/16 7.9	
	46712	1/8	3.9	46728	3/8 7.9	
	46714	9/64	3.9			

- Soft panel grip
- Convenient hang hole
- Hardened CVM tool steel
- Exact fit precision machined tips
- Fast angle entry

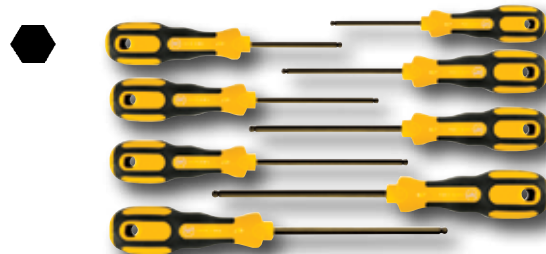



**46793 8 Piece 3K Ergo Inch Ball End Hex Screwdriver Set**

Item No.	Hex	Inch	Inch	Hex	Inch	lbs.
46793	46702	.050	2.9	46710	7/64 3.9	1.19
	46704	1/16	2.9	46712	1/8 3.9	
	46706	5/64	3.9	46714	9/64 3.9	
	46708	3/32	3.9	46716	5/32 3.9	



**46794 6 Piece 3K Ergo Inch Ball End Hex Screwdriver set**

Item No.	Hex	Inch	Inch	Hex	Inch	lbs.
46794	46712	1/8	3.9	46718	3/16 3.9	.97
	46714	9/64	3.9	46722	7/32 5.9	
	46716	5/32	3.9	46724	1/4 5.9	

 Yellow = Inch  
 Red = Metric

**Wiha Ball End 3K Series Drivers & Sets**

- Soft panel grip
- Convenient hang hole
- Hardened CVM tool steel
- Exact fit precision machined tips
- Fast angle entry



**46796 7 Piece Metric Ball End Hex Screwdriver Set**

Blades of CVM special steel, hardened, black finish.

Molded on Wiha-3k Ergo soft grip handles.

Item No.	Hex	Inch	mm	Hex	Inch	mm	Weight
46715	1.5	75	46740	4.0	100	1.15	
46720	2.0	100	46750	5.0	100		
46725	2.5	100	46760	6.0	150		
46730	3.0	100					

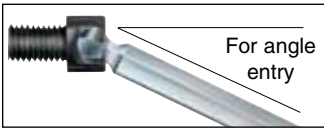

Metric / Soft Grip

**467 Ball End Hex Metric Screwdriver, With Wiha-3K Ergo Handle**

Blades of CVM special steel, hardened, black finish. Molded on Wiha-3K Ergo soft grip handles.

Item No.	Hex	Inch	mm	Weight	Pkg.
46715	1.5	75	161	.07	10
46720	2.0	100	186	.07	10
46725	2.5	100	186	.07	10
46730	3.0	100	186	.07	10
46740	4.0	100	197	.11	10
46750	5.0	100	197	.13	10
46760	6.0	150	257	.21	10
46780	8.0	200	307	.34	10
46786	10.0	200	319	.52	10



**46799 9 Piece Metric Ball End Hex Screwdriver Set**

Blades of CVM special steel, hardened, black finish.

Molded on Wiha-3k Ergo soft grip handles.

Item No.	Hex	Inch	mm	Hex	Inch	mm	Weight
46715	1.5	75	46750	5.0	100	1.93	
46720	2.0	100	46760	6.0	150		
46725	2.5	100	46780	8.0	200		
46730	3.0	100	46786	10.0	200		
46740	4.0	100					

Yellow = Inch  
Red = Metric

**Wiha PocketStar Fold-Ups**



Push button key release

**36997 9 Piece MagicRing Inch PocketStar Fold Outs**  
High alloy CVM steel, hardened, molded ergonomic handle.

<b>Item No.</b>	
36997 PocketStar	lbs. .46
<b>Inch:</b> 5/64*, 3/32*, 7/64*, 1/8, 9/64, 5/32, 3/16, 7/32, 1/4"	

\* Standard Ball - No Ring



Push button key release

**36996 7 Piece MagicRing Metric PocketStar Fold Outs**  
High alloy CVM steel, hardened, molded ergonomic handle.

<b>Item No.</b>	
36996 PocketStar	lbs. .50
<b>Metric:</b> 2.0*, 2.5*, 3.0, 4.0, 5.0, 6.0, 8.0mm	

\* Standard Ball - No Ring



Push button key release

**66997 2 Pack MagicRing PocketStar Fold Outs Inch & Metric**  
High alloy CVM steel, hardened, molded ergonomic handle.

<b>Item No.</b>	
66997 Fold Outs Inch/Metric Includes:	lbs. .98
36996 - 2.0*, 2.5*, 3.0, 4.0, 5.0, 6.0, 8.0mm	
36997 - 5/64*, 3/32*, 7/64*, 1/8, 9/64, 5/32, 3/16, 7/32, 1/4"	

\* Standard Ball - No Ring



#35195

#35196

**35195 7 Piece Metric Hex PocketStar Fold Outs**  
High alloy CVM steel, hardened, molded ergonomic handle.

<b>Item No.</b>	
35195 PocketStar	lbs. .51
<b>Metric:</b> 2.0, 2.5, 3.0, 4.0, 5.0, 6.0, 8.0mm	

**35196 7 Piece Metric Hex PocketStar Fold Outs**  
High alloy CVM steel, hardened, molded ergonomic handle.

<b>Item No.</b>	
35196 PocketStar	lbs. .31
<b>Metric:</b> 1.5, 2.0, 2.5, 3.0, 4.0, 5.0, 6.0mm	



Push button key release

**35197 9 Piece Inch Hex PocketStar Fold Outs**  
High alloy CVM steel, hardened, molded ergonomic handle.

<b>Item No.</b>	
35197 PocketStar	lbs. .47
<b>Inch:</b> 5/64, 3/32, 7/64, 1/8, 9/64, 5/32, 3/16, 7/32, 1/4"	



Push button key release

**35198 6 Pc. Slotted, Phillips & Hex Metric PocketStar Fold Outs**  
High alloy CVM steel, hardened, molded ergonomic handle.

<b>Item No.</b>	
35198 PocketStar	lbs. .35
<b>Slotted:</b> 5.5mm <b>Phillips:</b> #2	
<b>Metric:</b> 3.0, 4.0, 5.0, 6.0mm	









**Nickel-Plated Long Arm Hex L-keys**



Nickel-Plated

- Ideal for use in clean rooms & other environments where non-oxidizing surfaces are specified or required.

**352 Metric L-key Hex, Long Arm** high alloy CVM steel, hardened, nickel plated. Precision machined, burr free chamfered ends.



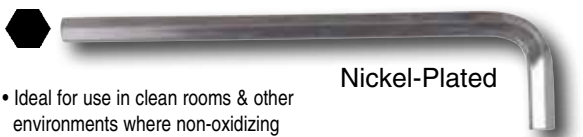

Item							
No.	mm	mm	Inch	mm	Inch	lbs.	pkg.
35201	1.5	89	3.5	14	.6	.01	10
35202	2.0	99	3.9	16	.6	.01	10
35204	2.5	110	4.3	18	.7	.02	10
35206	3.0	124	4.9	20	.8	.02	10
35208	4.0	138	5.4	25	1.0	.04	10
35210	5.0	158	6.2	28	1.1	.07	10
35211	6.0	178	7.0	32	1.3	.12	10
35212	7.0	187	7.4	34	1.3	.17	10
35214	8.0	196	7.7	36	1.4	.23	10
35217	10.0	219	8.6	40	1.6	.40	10
35219	12.0	245	9.6	45	1.8	.77	1
35221	14.0	277	10.9	56	2.2	1.12	1
35223	17.0	316	12.4	63	2.5	1.80	1
35227	19.0	355	14.0	70	2.8	2.46	1



Nickel-Plated

- Ideal for use in clean rooms & other environments where non-oxidizing surfaces are specified or required.



**352 Inch L-key Hex, Long Arm**

Item					
No.	Inch	mm	Inch	lbs.	pkg.
35231	.050	75	3.0	.01	10
35233	1/16	78	3.1	.01	10
35235	5/64	82	3.2	.01	10
35237	3/32	85	3.3	.01	10
35239	7/64	92	3.6	.01	10
35241	1/8	95	3.7	.02	10
35243	9/64	100	3.9	.03	10
35251	5/32	105	4.1	.03	10
35252	3/16	113	4.4	.05	10
35253	7/32	122	4.8	.07	10
35254	1/4	135	5.3	.10	10
35255	5/16	152	6.0	.18	10
35256	3/8	173	6.8	.30	10
35257	1/2	209	8.2	.77	1
35258	9/16	230	9.1	1.04	1
35259	5/8	245	9.6	1.27	1
35261	3/4	286	11.3	2.01	1



**35297 9 Piece Metric Hex L-key Set, In Plastic Holder**

Equipped with 1.5, 2.0, 2.5, 3.0, 4.0, 5.0, 6.0, 8.0, 10.0mm

Item		
No.	lbs.	pkg.
35297	1.00	1



**35295 13 Piece Inch Hex L-key Set, In Plastic Holder**

Equipped with .050, 1/16, 5/64, 3/32, 7/64, 1/8, 9/64, 5/32, 3/16, 7/32, 1/4, 5/16, 3/8"

Item		
No.	lbs.	pkg.
35295	.90	1



**Black Finish Long Arm Hex L-keys**



Black Finish



**35290 9 Piece Metric Hex L-key Set, In Plastic Holder**

Equipped with 1.5, 2.0, 2.5, 3.0, 4.0, 5.0, 6.0, 8.0, 10.0mm

Item	lbs.	pkg.
35290	.97	1

**352 Metric L-key Hex Metric, Long Arm**, high alloy CVM steel, hardened, black finish. Precision machined, burr free chamfered ends.

Item No.	mm	mm	Inch	mm	Inch	lbs.	pkg.
35200	0.7	66	2.6	5	.2	.01	10
35203	0.9	68	2.7	8	.3	.01	10
35205	1.3	72	2.8	12	.5	.01	10
35215	1.5	76	3.5	14	.6	.01	10
35220	2.0	99	3.9	16	.6	.01	10
35225	2.5	110	4.3	18	.7	.02	10
35230	3.0	124	4.9	20	.8	.02	10
35240	4.0	138	5.4	25	1.0	.04	10
35250	5.0	158	6.2	28	1.1	.07	10
35260	6.0	178	7.0	32	1.3	.12	10
35270	7.0	187	7.4	34	1.3	.18	10
35280	8.0	196	7.7	36	1.4	.24	10
35282	10.0	219	8.6	40	1.6	.40	10
35284	12.0	245	9.6	45	1.8	.77	1
35285	14.0	277	10.9	56	2.2	1.13	1
35286	17.0	316	12.4	63	2.5	1.80	1
35288	19.0	355	14.0	70	2.8	2.45	1



Black Finish



**35291 13 Piece Inch Hex L-key Set, In Plastic Holder**

Equipped with .050, 1/16, 5/64, 3/32, 7/64, 1/8, 9/64, 5/32, 3/16, 7/32, 1/4, 5/16, 3/8"

Item	lbs.	pkg.
35291	.98	1

**352 Inch L-key Hex, Long Arm**

Item No.	Inch	mm	Inch	lbs.	pkg.
35200	.028	67	2.6	.01	10
35203	.035	69	2.7	.01	10
35213	.050	75	3.0	.01	10
35216	1/16	78	3.1	.01	10
35218	5/64	82	3.2	.01	10
35222	3/32	85	3.3	.01	10
35224	7/64	92	3.6	.02	10
35226	1/8	95	3.7	.02	10
35228	9/64	100	3.9	.03	10
35232	5/32	105	4.1	.04	10
35234	3/16	113	4.4	.05	10
35236	7/32	122	4.8	.07	10
35238	1/4	135	5.3	.10	10
35242	5/16	152	6.0	.18	10
35244	3/8	173	6.8	.30	10
35245	1/2	209	8.2	.75	1
35246	9/16	230	9.1	.99	1
35247	5/8	245	9.6	1.26	1
35248	3/4	286	11.3	2.02	1
35249	1"	359	14.1	4.38	1

**Short Arm Hex L-keys Nickel Finish**



• Ideal for use in clean rooms & other environments where non-oxidizing surfaces are specified or required.

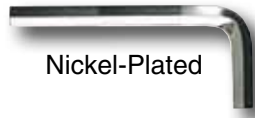

Nickel-Plated

**351 Metric L-key Hex Metric, Short Arm** high alloy CVM steel, hardened, nickel plated. Precision machined, burr free chamfered ends.

Item No.	mm	mm	Inch	mm	Inch	lbs.	pkg.
35104	1.5	45	1.8	14	.6	.01	10
35108	2.0	49	1.9	16	.6	.01	10
35112	2.5	55	2.2	18	.7	.01	10
35116	3.0	61	2.4	20	.8	.02	10
35120	4.0	68	2.7	25	1.0	.03	10
35124	5.0	78	3.1	28	1.1	.04	10
35128	6.0	88	3.5	32	1.3	.07	10
35132	7.0	92	3.6	34	1.3	.10	10
35136	8.0	97	3.8	36	1.4	.13	10
35140	9.0	103	4.1	38	1.5	.18	10
35144	10.0	109	4.3	40	1.6	.23	10
35145	12.0	122	4.8	45	1.8	.40	1
35175	14.0	137	5.4	56	2.2	.61	1
35177	17.0	156	6.1	63	2.5	1.02	1
35179	19.0	176	6.9	70	2.8	1.40	1



• Ideal for use in clean rooms & other environments where non-oxidizing surfaces are specified or required.

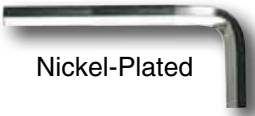

Nickel-Plated

**351 Inch L-key Hex, Short Arm** Nickel-plated

Item No.	Inch	mm	Inch	mm	Inch	lbs.	pkg.
35143	.050	40	1.6	10	.39	.01	10
35146	1/16	46	1.8	14	.55	.01	10
35147	5/64	50	2.0	16	.63	.01	10
35150	3/32	52	2.1	19	.75	.01	10
35152	7/64	54	2.1	19	.75	.01	10
35153	1/8	58	2.3	21	.83	.02	10
35155	9/64	62	2.4	23	.91	.02	10
35156	5/32	68	2.7	25	.99	.02	10
35159	3/16	70	2.8	26	1.0	.04	10
35162	7/32	77	3.1	29	1.2	.05	10
35165	1/4	88	3.5	31	1.2	.08	10
35168	5/16	98	3.9	36	1.4	.13	10
35171	3/8	107	4.2	38	1.5	.20	10
35174	1/2	133	5.2	44	1.7	.46	1
35176	9/16	158	6.2	64	2.5	.64	1
35178	5/8	175	6.9	71	2.8	.85	1
35180	3/4	198	7.8	89	3.5	1.40	1



**35191 9 Piece Metric Hex L-key Set, In Plastic Holder**

Equipped with 1.5, 2.0, 2.5, 3.0, 4.0, 5.0, 6.0, 8.0, 10.0mm

↔ lbs. .59    📦 pkg. 1



**35193 6 Piece Metric Hex L-key Set, In Plastic Holder**

Equipped with 1.5, 2.0, 2.5, 3.0, 4.0, 5.0mm

↔ lbs. .20    📦 pkg. 1



**35192 8 Piece Inch Hex L-key Set, In Plastic Holder**

Equipped with 5/64, 3/32, 1/8, 5/32, 3/16, 7/32, 1/4, 5/16"

↔ lbs. .41    📦 pkg. 1



**35194 13 Piece Inch Hex L-key Set, In Plastic Holder**

Equipped with .050 - 3/8"

↔ lbs. .72    📦 pkg. 1

**Short Arm Hex L-keys Black Finish**



**353 Metric L-key Hex Metric, Short Arm** high alloy CVM steel, hardened, black finish. Precision machined, burr free chamfered ends.

Item No.	mm	mm	Inch	mm	Inch	lbs.	pkg.
35301	0.7	31	1.2	-	-	.01	10
35302	0.9	31	1.2	-	-	.01	10
35303	1.3	40	1.6	12	.5	.01	10
35304	1.5	45	1.8	14	.6	.01	10
35305	2.0	49	1.9	16	.6	.01	10
35306	2.5	55	2.2	18	.7	.01	10
35307	3.0	61	2.4	20	.8	.02	10
35308	4.0	68	2.7	25	1.0	.03	10
35309	5.0	78	3.1	28	1.1	.04	10
35310	6.0	88	3.5	32	1.3	.07	10
35311	7.0	92	3.6	34	1.3	.10	10
35312	8.0	97	3.8	36	1.4	.13	10
35313	9.0	103	4.1	38	1.5	.17	10
35314	10.0	109	4.3	40	1.6	.23	10
35316	11.0	115	4.5	42	1.7	.29	10
35317	12.0	122	4.8	45	1.8	.40	1
35318	14.0	137	5.4	56	2.2	.61	1
35319	17.0	156	6.1	63	2.5	1.03	1
35320	19.0	176	6.9	70	2.8	1.40	1
35321	22.0	195	7.7	80	3.1	2.17	1



**353 Inch L-key Hex Inch, Short Arm** black finish

Item No.	Inch	mm	Inch	mm	Inch	lbs.	pkg.
35301	.028	31	1.2	-	-	.01	10
35302	.035	31	1.2	-	-	.01	10
35330	.050	40	1.6	10	.4	.01	10
35331	1/16	46	1.8	14	.6	.01	10
35332	5/64	50	2.0	16	.6	.01	10
35333	3/32	52	2.1	19	.8	.01	10
35334	7/64	54	2.1	19	.8	.01	10
35335	1/8	58	2.3	21	.8	.02	10
35336	9/64	62	2.4	23	.9	.02	10
35337	5/32	68	2.7	25	1.0	.02	10
35338	3/16	70	2.8	26	1.0	.05	10
35339	7/32	77	3.1	29	1.2	.07	10
35340	1/4	88	3.5	31	1.2	.07	10
35341	5/16	98	3.9	36	1.4	.13	10
35342	3/8	107	4.2	38	1.5	.20	10
35343	1/2	133	5.2	44	1.7	.49	1
35345	9/16	158	6.2	64	2.5	.66	1
35346	5/8	175	6.9	71	2.8	.86	1
35347	3/4	198	7.8	89	3.5	1.45	1
35348	1"	220	8.7	91	3.6	3.14	1



**35390 9 Piece Metric Hex L-key Set, In Plastic Holder**  
Equipped with 1.5, 2.0, 2.5, 3.0, 4.0, 5.0, 6.0, 8.0, 10.0mm  
lbs. .59 pkg. 1

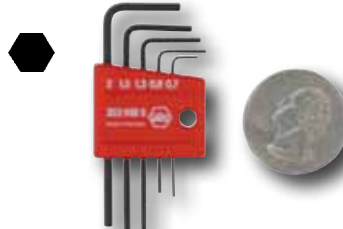

**35392 5 Piece Mini Metric Hex L-key Set, In Plastic Holder**  
Equipped with 0.7, 0.9, 1.3, 1.5, 2.0mm  
lbs. .03 pkg. 1

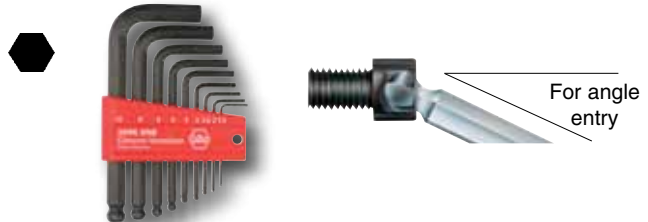

**36989 9 Piece Short Arm Metric Ball End Hex L-key Set, In Plastic Holder**  
Equipped with 1.5, 2.0, 2.5, 3.0, 4.0, 5.0, 6.0, 8.0, 10.0mm  
lbs. .59 pkg. 1



**35391 13 Piece Inch Hex L-key Set, In Plastic Holder**  
Equipped with .050, 1/16, 5/64, 3/32, 7/64, 1/8, 9/64, 5/32, 3/16, 7/32, 1/4, 5/16, 3/8"  
lbs. .64 pkg. 1

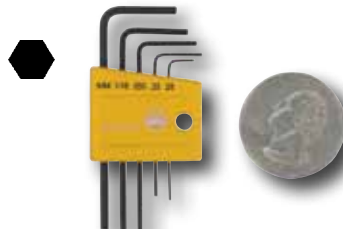

**35393 5 Piece Mini Inch Hex L-key Set, In Plastic Holder**  
Equipped with .028, .035, .050, 1/16, 5/64"  
lbs. .03 pkg. 1

**Wiha Insulated T-handles**

**Insulation Test Standards:**

Insulation according to EN/IEC 60900, ASTM F-1505-01, VDE 0682/part 201, DIN 7437, NFPA70E, CSA

Responds to OSHA's use specification 29 CFR1910

**Insulation**

Molded directly onto blade for permanent bonding

Each tool individually tested to 10,000 volts and certified to 1000 Volt ac or 1500 Volt dc

Blade CVM tool steel, hardened to average 58/60RC

**1000V**



**1000Volt**

**334 Inch T-handle, With Wiha-Molded Handle Insulation According to ASTM F-1505-01, New VDE Specification 0682/part 201, EN/IEC 60900, NFPA70E and CSA, up to 1000 Volt. Individually Tested.**

Blade CVM steel, hardened. Insulation molded directly onto blade.

Wiha-SoftFinish® handle, multi-component.

Item	Hex	Inch	Inch	Inch	mm	lbs.	pkg.
33481	5/32	5.9	6.9	176	.09	10	
33482	3/16	5.9	6.9	176	.15	10	
33483	7/32	5.9	6.9	176	.19	10	
33485	1/4	6.9	6.9	176	.20	10	
33486	5/16	6.9	6.9	176	.26	10	
33487	3/8	6.9	6.9	176	.44	10	



**1000Volt**

**33490 6 Piece Hex Inch T-handle Set**

Item	Hex	Inch	lbs.
33490	5/32, 3/16, 7/32, 1/4, 5/16, 3/8"		1.66



**1000Volt**

**334 Metric T-handle, With Wiha-Molded Handle. Insulation According to ASTM, VDE, EN/IEC, NFPA70E and CSA, up to 1000 Volt. Individually Tested.**

Item	Hex	mm	Inch	mm	Inch	lbs.	pkg.
33441	4.0	150	5.9	176	6.9	.09	10
33443	5.0	150	5.9	176	6.9	.15	10
33445	6.0	150	5.9	176	6.9	.18	10
33447	8.0	150	5.9	176	6.9	.26	10
33449	10.0	150	5.9	176	6.9	.46	10



**1000Volt**

**33478 5 Piece Hex Metric T-handle Set**

Item	Hex Metric	lbs.
33478	4.0, 5.0, 6.0, 8.0, 10.0mm	1.20

**Wiha Insulated Hex Metric Screwdrivers**



**1000Volt**

**323 Hex Metric Screwdriver, With Wiha-SoftFinish® Handle Insulation According to ASTM F-1505-01, New VDE Specification 0682/part 201 and EN/IEC 60900, NFPA70E & CSA, up to 1000 Volt. Individually Tested.** Blade high alloy CVM steel, hardened, black finish. Insulation molded directly onto blade. Wiha-SoftFinish® handle, multi-component, cushion grip.

Item	Hex	mm	Inch	mm	Inch	lbs.	pkg.
32302	2.5	75	3.0	179	7.0	.06	10
32303	3.0	75	3.0	179	7.0	.08	10
32304	4.0	75	3.0	186	7.3	.12	10
32305	5.0	75	3.0	186	7.3	.15	10
32306	6.0	100	3.9	218	8.6	.21	10
32308	8.0	100	3.9	218	8.6	.34	10

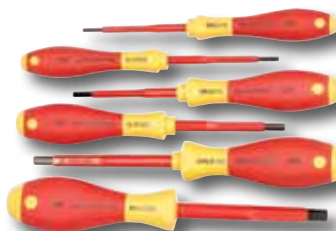

**1000Volt**

**32366 6 Piece Insulated Hex Metric Screwdriver Set**

Item No.	Hex Metric	lbs.
32366	2.5, 3.0, 4.0, 5.0, 6.0, 8.0mm	1.06

**Wiha Insulated Hex L-keys**

**Insulation Test Standards:**  
Insulation according to ASTM,  
F-1505-01, EN/IEC 60900  
and CSA



**Insulation**  
Applied directly  
onto blade for  
permanent  
bonding

 **1000V**

**Each tool individually  
tested to 10,000 volts  
and certified to 1000  
Volt ac or 1500 Volt dc**



 **1000V**

**136 Inch Insulated Hex L-keys, With Insulated Handle**

Insulation According to IEC 60900 specification, up to 1000 Volt.  
Individually Tested. Blade chrome-vanadium steel, hardened.

Item No.	ØMM	OAL	OAL	↔	⊞
No.	Inch	mm	Inch	lbs.	pkg.
13670	1/16	79	3.1	.05	1
13671	5/64	84	3.3	.05	1
13672	3/32	89	3.5	.05	1
13673	7/64	94	3.7	.06	1
13663	1/8	104	4.1	.06	1
13665	5/32	104	4.1	.06	1
13666	3/16	134	5.3	.10	1
13667	7/32	134	5.3	.12	1
13668	1/4	134	5.3	.16	1
13669	5/16	144	5.7	.24	1
13662	3/8	234	9.2	.51	1
13664	1/2	234	9.2	.77	1



 **1000V**

**136 Metric Insulated Hex L-keys, With Insulated Handle**

Insulation According to IEC 60900 specification, up to 1000 Volt.  
Individually Tested. Blade chrome-vanadium steel, hardened.

Item No.	ØMM	OAL	OAL	↔	⊞
No.	mm	mm	Inch	lbs.	pkg.
13650	1.5	100	3.9	.09	1
13651	2.0	105	4.1	.09	1
13652	2.5	115	4.5	.09	1
13653	3.0	130	5.1	.10	1
13654	4.0	120	4.7	.10	1
13655	5.0	140	5.5	.10	1
13656	6.0	140	5.5	.13	1
13658	8.0	150	5.9	.24	1
13659	10.0	220	8.7	.51	1
13657	12.0	260	10.2	.77	1



#13691

 **1000Volt**



#13690

**13690 8 Piece Insulated Hex L-key Set - Inch**

Item No.	↔	⊞
13690	1/8, 5/32, 3/16, 7/32, 1/4, 5/16, 3/8, 1/2"	lbs. 2.17

**13691 7 Piece Insulated Hex L-key Set - Metric**

Item No.	↔	⊞
13691	3.0, 4.0, 5.0, 6.0, 8.0, 10.0, 12.0mm	lbs. 2.07



 **1000Volt**

**13693 10 Piece Insulated Hex L-key Set - Metric**

Item No.	↔	⊞
13693	1.5, 2.0, 2.5, 3.0, 4.0, 5.0, 6.0, 8.0, 10.0, 12.0mm	lbs. 2.26

**13694 12 Piece Insulated Hex L-key Set - Inch**

Item No.	↔	⊞
13694	1/16, 5/64, 3/32, 7/64, 1/8, 5/32, 3/16, 7/32, 1/4, 5/16, 3/8, 1/2"	lbs. 2.40

**Wiha Insulated 3/8" Bit Sockets & Set**



 **1000Volt**

**318 Insulated 3/8" Drive Sockets - Insulation according to EN/IEC 60900, DIN 7448 specification, up to 1000 Volt.**

Individually Tested. Chrome-vanadium steel, forged, oil-hardened.

Item No.	↔	⊞		
No.	Inch	OAL	lbs.	pkg.
31805	3/16	3.1"	.13	1
31807	7/32	3.1"	.14	1
31809	1/4	3.1"	.14	1
31811	5/16	3.1"	.16	1
31813	3/8	3.1"	.18	1
31815	7/16	3.1"	.20	1
31817	1/2	3.1"	.22	1

\*Sockets must be used with insulated ratchets & extensions



 **1000Volt**

**31890 7 Piece Insulated 3/8" Drive Socket Set - Inch**

CV steel, forged, oil-hardened sockets. Insulated to EN/IEC 60900.

Item No.	↔	⊞
31890	Set includes the following:	
↔ lbs. 1.7	3/16, 7/32, 1/4, 5/16, 3/8, 7/16, 1/2"	

**Wiha Drive-Loc VI Handles**



Allows adjustable blade lengths 1.7" to 4.7" in 1/8" increments

**28488 Drive-Loc VI Cushion Grip Handle**

Wiha-SoftFinish® impact resistant, with roll off protection.

**Advantages:**

Ergonomic cushion grip, Drive-Loc mechanism guarantees a secure hold and rapid blade exchange.

Item						
No.	mm	mm	Inch	mm	Inch	lbs.
28488	6.0	115	4.5	36.0	1.41	.26



Allows adjustable blade lengths 1.7" to 4.7" in 1/8" increments

**28486 ESD Safe Drive-Loc VI Cushion Grip Handle**

Wiha-SoftFinish® impact resistant, with roll off protection.

**Advantages:**

Ergonomic cushion grip, Drive-Loc mechanism guarantees a secure hold and rapid blade exchange. Static Dissipative.

Item						
No.	mm	mm	Inch	mm	Inch	lbs.
28486	6.0	115	4.5	36.0	1.41	.21



Allows adjustable blade lengths 1.7" to 4.7" in 1/8" increments

**28487 Drive-Loc VI MicroFinish Non-Slip Grip Handle**

Wiha-MicroFinish handle, won't peel, crack or deteriorate when exposed to petroleum solvents. Ideal for Hex, TORX® & Nut Drivers.

**Advantages:**

Ergonomic handle shape for maximum comfort, Drive-Loc mechanism guarantees a secure hold and rapid blade exchange.

Item						
No.	mm	mm	Inch	mm	Inch	lbs.
28487	6.0	115	4.5	36.0	1.41	.20



**Wiha Drive-Loc VI Blades**



**281 Ball End Hex & Hex Metric Drive-Loc VI Interchangeable Blade**

High alloy CVM steel, through hardened, hard chrome finish. Ball end enables the user to work at angles up to 25°. Over all blade length 150mm/5.9". Blades fit all Drive-Loc VI handles.

Item				
No.	mm + mm	lbs.	pkg.	
28116	2.5 2.5	.10	1	
28117	3 3	.10	1	
28118	4 4	.10	1	
28119	5 5	.10	1	
28120	6 6	.10	1	



**281 Hex Metric Drive-Loc VI Interchangeable Blade**

High alloy CVM steel, through hardened, hard chrome finish. Over all blade length 150mm/5.9". Blades fit all Drive-Loc VI handles.

Item				
No.	mm + mm	lbs.	pkg.	
28149	2.0 2.5	.09	1	
28150	3.0 4.0	.10	1	
28151	5.0 6.0	.10	1	



**281 Hex Inch Drive-Loc VI Interchangeable Blade**

High alloy CVM steel, through hardened, hard chrome finish. Over all blade length 150mm/5.9". Blades fit all Drive-Loc VI handles.

Item				
No.	Inch + Inch	lbs.	pkg.	
28122	3/32 7/64	.10	1	
28123	1/8 9/64	.10	1	
28124	5/32 3/16	.10	1	



**28192 7 Piece Hex Inch & Metric Drive-Loc VI Blade Set**

Blade CVM steel, hardened, hard chromed. In storage pouch

Item		
No. 28192		lbs.
Inch: 3/32 x 7/64, 1/8 x 9/64, 5/32 x 3/16		.74
Metric: 2.0 x 2.5, 3.0 x 4.0, 5.0 x 6.0		
Wiha SoftFinish® Cushion Grip Handle		

**TorqueControl Tools**



+/-6% accuracy tolerance  
Certificate of calibration



+/-6% accuracy tolerance  
Certificate of calibration

**285 TorqueFix, With Wiha-SoftFinish® Handle**

Fixed Torque value pre-set. Tested in accordance with EN ISO 6798, BS EN 26789, ASME B107.14M, tolerance +/- 6%. Audible and perceptible click when pre-set torque has been attained.

Automatically resets for next torque cycle; 50% greater reverse torque.

Item No.	Pre-Sets		Nm	mm		Inch		lbs.	pkg.
	oz.	lbs.							
28503	80	5	0.56	112	4.4	.16	1		
28505	120	7.5	0.84	112	4.4	.15	1		
28507	160	10	1.12	119	4.7	.28	1		
28509	200	12.5	1.41	119	4.7	.27	1		
28511	240	15	1.69	119	4.7	.27	1		
28513	320	20	2.25	119	4.7	.28	1		
28515	400	25	2.82	126	4.9	.37	1		
28517	480	30	3.39	126	4.9	.37	1		
28518	560	35	3.95	126	4.9	.37	1		
28519	640	40	4.52	126	4.9	.37	1		
28521	800	50	5.65	132	5.2	.52	1		
28523	960	60	6.78	132	5.2	.52	1		
28525	1120	70	7.91	132	5.2	.52	1		

**285 Adjustable TorqueVario-S Handle - In Newton Meter Scale**

EN ISO 6798, BS EN 26789, ASME B107.14M. Ergonomic molded multi-component handle, light and compact. Handle sizes proportioned to optimize torque range. Audible and perceptible click when the torque setting has been attained, automatically resets for next torque cycle.

Item No.	Newton Meter Scale		Increments	mm		lbs.	pkg.
28550*	0.1 - 0.6Nm	.02 Nm		122 - 127	.35	1	
28551	0.4 - 1.0Nm	.05 Nm		122 - 127	.35	1	
28552	0.8 - 2.0Nm	.05 Nm		126 - 131	.45	1	
28553	1.0 - 5.0Nm	.20 Nm		133 - 138	.55	1	
28554	2.0 - 8.0Nm	.25 Nm		137 - 142	.70	1	

\* +/- 10% (This unit only)  
\* (1 Nm = 8.8507)



**285 Hex Metric Interchangeable Blades For TorqueFix & TorqueVario**

Hex tip blades on narrow 5/32 Hex shafts. High alloy CVM steel, hardened, satin hard chrome finish.

Item No.	mm	mm	lbs.	Max. Torque		pkg.
				Nm		
28545	1.5	175	.07	0.9		1
28546	2.0	175	.07	1.8		1
28547	2.5	175	.07	3.8		1
28548	3.0	175	.07	8.0		1
28549	4.0	175	.07	8.0		1

Direct Reading Scale



+/-6% accuracy tolerance  
Certificate of calibration

**285 Adjustable TorqueVario With Direct Reading Scale**

EN ISO 6798, BS EN 26789, ASME B107.14M. Ergonomic molded multi-component handle, light and compact. Handle sizes proportioned to optimize torque range. Audible and perceptible click when the torque setting has been attained, automatically resets for next torque cycle.

Item No.	Range		Increments	mm		lbs.	pkg.
	Inch	lbs.					
28501*	15 - 80(in/oz)	2.5 Inch oz		122 - 127	.22	1	
28502	5 - 10	.5 Inch lbs		122 - 127	.41	1	
28504	7.5 - 20	.5 Inch lbs		126 - 131	.50	1	
28506	10 - 50	2 Inch lbs		133 - 138	.59	1	
28508	20 - 70	2 Inch lbs		137 - 142	.74	1	

Above includes Micro Bit Holder 28583

See 4mm Micro Bits on Page 30

\* +/- 10% (This unit only)

\* (1 Nm = 8.8507)



**285 Hex Inch Interchangeable Blades For TorqueFix & TorqueVario**

Hex tip blades on narrow 5/32 Hex shafts. High alloy CVM steel, hardened, satin hard chrome finish.

Item No.	Inch	mm	lbs.	Max. Torque		pkg.
				Nm		
28555	.050	175	.07	.4		1
28556	1/16	175	.07	.9		1
28557	5/64	175	.07	1.8		1
28558	3/32	175	.07	1.8		1
28559	7/64	175	.07	3.8		1
28560	1/8	175	.07	3.8		1
28587	9/64	175	.07	8.0		1
28588	5/32	175	.07	8.0		1



**T-handle TorqueControl Tools**



Includes Calibration Certificate

**289 TorqueFix T-handle**

EN ISO 6798, BS EN 26789, ASME B107.14M, +/- 6% Accuracy  
Ergonomic multi-component handle, light and compact.  
With Certificate of calibration.

Item No.	Torque In-lbs.	Torque Nm	mm x mm	lbs.	pkg.
28931	53.1	6	56 x 120	.81	1
28933	70.8	8	56 x 120	.82	1
28935	88.5	10	56 x 120	.79	1
28937	106.2	12	56 x 120	.79	1
28938	110.6	12.5	56 x 120	.80	1
28939	123.9	14	56 x 120	.80	1

**Each TorqueFix T-handle has unique serial number and certificate of calibration**



**289 Hex Metric Interchangeable Blades For TorqueFix T-handle**

Hex tip blades on 6mm Hex shafts. High alloy CVM steel, hardened, satin hard chrome finish.

Item No.	mm	mm	Inch	lbs.	pkg.
28916	3.0	130	5.1	.11	1
28917	4.0	130	5.1	.11	1
28918	5.0	130	5.1	.11	1
28919	6.0	130	5.1	.11	1



Includes Calibration Certificate

**28940 Adjustable TorqueVario STplus T-handle**

EN ISO 6798, BS EN 26789, ASME B107.14M, +/- 6% Accuracy  
Ergonomic multi-component handle, light and compact.

Item No.	Torque In-lbs.	Torque Nm	mm x mm	lbs.	pkg.
28940	44.3-123.9	5-14	56 x 120	.81	1



**289 Hex Inch Interchangeable Blades For TorqueFix T-handle**

Hex tip blades on 6mm Hex shafts. High alloy CVM steel, hardened, satin hard chrome finish.

Item No.	Inch	mm	Inch	lbs.	pkg.
28920	1/8	130	5.1	.11	1
28921	9/64	130	5.1	.11	1
28922	5/32	130	5.1	.11	1
28923	3/16	130	5.1	.11	1
28924	7/32	130	5.1	.11	1

\* (1 Nm 8.8507)



Adjustable from Nm 5-14 or In-lbs. 44.3-123.9



**Wiha Precision ESD Safe Hex Drivers**

Wiha Precision ESD Static Dissipative Screwdrivers meet the requirements for tools used in static sensitive areas.



**Rotating cap** for precise turning & control with fingertip

**Molded Precision handle** of impact resistant dissipative material

**Tapered handle** allows rapid rotation

**Blade, CVM steel, hardened, hard chrome finish**

**Tip, precision ground for exact fit, Wiha Chromtop finish**

ESD Standard IEC 61340-5-1

Surface resistance of handles is 10<sup>6</sup> - 10<sup>9</sup> Ohms



**275 Inch Hex Driver, With Precision ESD Safe Dissipative**

**Handle** Blade high alloy chrome-vanadium-molybdenum steel. Hard chrome finished. Handle manufactured from impact resistant, dissipative material. ESD standard IEC 61340-5-1

Item	Hex	Flat	Flat	Flat	Flat	Flat	Flat
No.	Inch	mm	Inch	mm	Inch	lbs.	pkg.
27505	.028	40	1.6	120	4.7	.02	10
27510	.035	40	1.6	120	4.7	.02	10
27513	.050	40	1.6	120	4.7	.02	10
27537	1/16	50	2.0	145	5.7	.03	10
27539	5/64	50	2.0	145	5.7	.03	10
27541	3/32	60	2.4	170	6.7	.04	10
27543	7/64	60	2.4	170	6.7	.04	10
27545	1/8	60	2.4	170	6.7	.04	10
27547	9/64	60	2.4	170	6.7	.05	10
27549	5/32	60	2.4	170	6.7	.05	10

\*Metric dimensions actual - Inch dimensions approximate



**275 Metric Hex Metric Driver, With Precision ESD Safe**

**Dissipative Handle** Blade high alloy chrome-vanadium-molybdenum steel. Hard chrome finished. Handle manufactured from impact resistant, dissipative material. ESD standard IEC 61340-5-1

Item	Hex	Flat	Flat	Flat	Flat	Flat	Flat
No.	mm	mm	Inch	mm	Inch	lbs.	pkg.
27507	.71	40	1.6	120	4.7	.02	10
27509	.89	40	1.6	120	4.7	.02	10
27513	1.27	40	1.6	120	4.7	.03	10
27515	1.5	50	2.0	145	5.7	.03	10
27520	2.0	50	2.0	145	5.7	.04	10
27525	2.5	60	2.4	170	6.7	.05	10
27530	3.0	60	2.4	170	6.7	.05	10
27535	4.0	60	2.4	170	6.7	.05	10

\*Metric dimensions actual - Inch dimensions approximate



ESD standard IEC 61340-5-1

**27590 Set 8 Pcs. Hex Metric Precision ESD Safe Dissipative**

**Handle** Blade CVM steel, hardened, hard chromed. Handle impact resistant, dissipative material. In storage pouch

Item	Hex	Flat	Flat	Flat	Flat	Flat	
No.	mm	mm	mm	mm	mm	lbs.	
27590	27507	.71	40	27520	2.0	50	.53
	27509	.89	40	27525	2.5	60	
	27513	1.27	40	27530	3.0	60	
	27515	1.5	50	27535	4.0	60	



ESD standard IEC 61340-5-1

**27591 8 Piece Hex Inch Precision Set, ESD Safe Dissipative**

**Handle** Blade CVM steel, hardened, hard chromed. Handle impact resistant, dissipative material. In storage pouch

Item	Hex	Flat	Flat	Flat	Flat	Flat	
No.	Inch	Inch	Inch	Inch	Inch	lbs.	
27591	27513	.050	1.6	27543	7/64	2.4	.57
	27537	1/16	2.0	27545	1/8	2.4	
	27539	5/64	2.0	27547	9/64	2.4	
	27541	3/32	2.4	27549	5/32	2.4	



**91118 Rugged Polyester Canvas Storage Pouch**







Holds 8 Precision Tools up to 170mm in length. Folding pouch. Has security flaps and velcro closer.

Item	Flat	Flat
No.	Size	lbs. pkg.
91118	14 1/2" W x 7 3/4" L	.13 1

**Pico Soft Grip Ball End Inch & Metric**











**264 Ball End Hex Inch Screwdriver, With Precision Soft PicoFinish Handle** Blade high alloy chrome-vanadium-molybdenum tool steel, hardened, hard chrome finish.

Item							
No.	Inch	Inch	mm	Inch	mm	Inch	mm
26455	1/16	2.0	50	5.9	150	10	
26457	5/64	2.0	50	5.9	150	10	
26459	3/32	2.0	50	5.9	150	10	
26461	7/64	2.4	60	6.3	160	10	
26463	1/8	2.4	60	6.3	160	10	
26465	9/64	2.4	60	6.3	160	10	
26467	5/32	2.4	60	6.3	160	10	

\*Metric dimensions actual - Inch dimensions approximate









**26493 7 Piece Inch Ball End Hex Precision Driver Set, With Soft PicoFinish Handle** Blade high alloy CVM steel, hardened, hard chromed. ChromTop finish on tip for a perfect fit. In storage pouch

Item								
No.	Inch	Inch	Inch	Inch	Inch	Inch	Inch	lbs.
26493	26455	1/16	2.0	26463	1/8	2.4		.27
	26457	5/64	2.0	26465	9/64	2.4		
	26459	3/32	2.0	26467	5/32	2.4		
	26461	7/64	2.4					



**264 Ball End Hex Metric Screwdriver, With Precision Soft PicoFinish Handle.** Blade high alloy chrome-vanadium-molybdenum tool steel, hardened, hard chrome finish.







Item							
No.	mm	mm	Inch	mm	Inch	mm	mm
26441	1.27	40	1.6	134	5.3	10	
26443	1.5	50	2.0	150	5.9	10	
26445	2.0	50	2.0	150	5.9	10	
26447	2.5	60	2.4	160	6.3	10	
26449	3.0	60	2.4	160	6.3	10	

\*Metric dimensions actual - Inch dimensions approximate

**Pico Soft Grip Hex Inch & Metric**



**263 Hex Inch Screwdriver, With Precision Soft PicoFinish Handle** Blade high alloy CVM tool steel, hardened, hard chrome finish.









Item							
No.	Inch	mm	Inch	mm	Inch	mm	pkg.
26341	.028(.71)	40	1.6	134	5.3	10	
26343	.035(.89)	40	1.6	134	5.3	10	
26345	.050(1.27)	40	1.6	134	5.3	10	
26349	5/64(2.0)	50	2.0	150	5.9	10	
26363	1/16	50	2.0	144	5.7	10	
26367	3/32	60	2.4	160	6.3	10	
26369	7/64	60	2.4	160	6.3	10	
26371	1/8	60	2.4	160	6.3	10	

\*Metric dimensions actual - Inch dimensions approximate









In storage pouch

**26392 8 Piece Hex Inch Precision Driver Set**

Item								
No.	Inch	Inch	Inch	Inch	Inch	Inch	lbs.	lbs.
26392	26341	.028	1.6	26363	1/16	2.0		.24
	26343	.035	1.6	26367	3/32	2.4		
	26345	.050	1.6	26369	7/64	2.4		
	26349	5/64	2.0	26371	1/8	2.4		



**263 Hex Metric Driver, With Precision Soft PicoFinish Handle** Blade high alloy CVM tool steel, hardened, hard chrome finish.









Item							
No.	mm	mm	Inch	mm	Inch	mm	mm
26341	.71(.028)	40	1.6	134	5.3	10	
26343	.89(.035)	40	1.6	134	5.3	10	
26345	1.27(.050)	40	1.6	134	5.3	10	
26347	1.5	50	2.0	144	5.7	10	
26349	2.0(5/64)	50	2.0	150	5.9	10	
26351	2.5	60	2.4	160	6.3	10	
26353	3.0	60	2.4	160	6.3	10	

\*Metric dimensions actual - Inch dimensions approximate



In storage pouch

**26393 7 Pc. Hex Metric Precision Driver Set**

Item								
No.	mm	mm	mm	mm	mm	mm	mm	lbs.
26393	26341	.71	40	26349	2.0	50		.22
	26343	.89	40	26351	2.5	60		
	26345	1.27	40	26353	3.0	60		
	26347	1.5	50					

**Wiha Hex Precision Series**



**263 Metric Metric Hex Driver, With Precision Handle**

Metric sizes. Blade high alloy chrome-vanadium-molybdenum steel.

Item								
No.	mm	Inch	mm	Inch	mm	Inch	lbs.	pkg.
26307	.71	.028	40	1.6	120	4.7	.02	10
26309	.89	.035	40	1.6	120	4.7	.02	10
26313	1.27	.050	40	1.6	120	4.7	.02	10
26315	1.5	-	50	2.0	145	5.7	.03	10
26320	2.0	5/64	50	2.0	145	5.7	.03	10
26325	2.5	-	60	2.4	170	6.7	.04	10
26330	3.0	-	60	2.4	170	6.7	.04	10
26340	4.0	-	60	2.4	170	6.7	.05	10

\*Metric dimensions actual - Inch dimensions approximate



**26390 7 Pc. Precision Hex Driver Set - Metric**

Blade high alloy chrome-vanadium-molybdenum steel.

Item			
No.	Inch	Inch	lbs.
26390	26307	.71	1.6
	26309	.89	1.6
	26313	1.27	1.6
	26315	1.5	2.0
	26320	2.0	2.0
	26325	2.5	2.4
	26330	3.0	2.4



**26399 8 Piece Precision Hex Driver Set - Inch**

Blade high alloy chrome-vanadium-molybdenum steel. Hard chrome finished. In canvas storage pouch

Item						
No.	Inch	Inch	Inch	Inch	Inch	lbs.
26399	26307	.028	1.6	26320	5/64	2.0
	26309	.035	1.6	26323	3/32	2.4
	26313	.050	1.6	26327	7/64	2.4
	26316	1/16	2.0	26331	1/8	2.4



**263 Inch Inch Hex Driver, With Precision Handle**

Inch sizes. Blade high alloy chrome-vanadium-molybdenum steel.

Item								
No.	Inch	mm	mm	Inch	mm	Inch	lbs.	pkg.
26307	.028	.71	40	1.6	120	4.7	.02	10
26309	.035	.89	40	1.6	120	4.7	.02	10
26313	.050	1.27	40	1.6	120	4.7	.02	10
26316	1/16	-	50	2.0	145	5.7	.03	10
26320	5/64	2.0	50	2.0	145	5.7	.03	10
26323	3/32	-	60	2.4	170	6.7	.04	10
26327	7/64	-	60	2.4	170	6.7	.04	10
26331	1/8	-	60	2.4	170	6.7	.04	10
26333	9/64	-	60	2.4	170	6.7	.05	10
26336	5/32	-	60	2.4	170	6.7	.05	10

\*Metric dimensions actual - Inch dimensions approximate



**26391 8 Pc. Precision Hex Driver Set - Inch**

Blade high alloy CVM steel.

Item			
No.	Inch	Inch	lbs.
26391	26307	.028	1.6
	26309	.035	1.6
	26313	.050	1.6
	26316	1/16	2.0
	26320	5/64	2.0
	26323	3/32	2.4
	26327	7/64	2.4
	26331	1/8	2.4

**Wiha Ball End Precision Series**

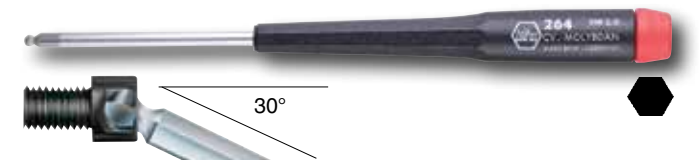

**264 Metric Ball End Hex Metric Screwdriver With Precision Handle**

Angle entry up to 30°. Blade high alloy CVM steel.

Item								
No.	mm	Inch	mm	Inch	mm	Inch	lbs.	pkg.
26413	1.27	.050	40	1.6	120	4.7	.02	10
26415	1.5	-	50	2.0	145	5.7	.03	10
26420	2.0	-	50	2.0	145	5.7	.03	10
26425	2.5	-	60	2.4	170	6.7	.04	10
26430	3.0	-	60	2.4	170	6.7	.05	10
26440	4.0	-	60	2.4	170	6.7	.05	10

\*Metric dimensions actual - Inch dimensions approximate



**26491 5 Piece Ball End Hex Driver Set - Metric**

Angle entry up to 30°.

Blade high alloy CVM steel.

Item			
No.	mm	mm	lbs.
26491	26413	1.27	40
	26415	1.5	50
	26420	2.0	50
	26425	2.5	60
	26430	3.0	60

**Wiha Ball End Precision Series**

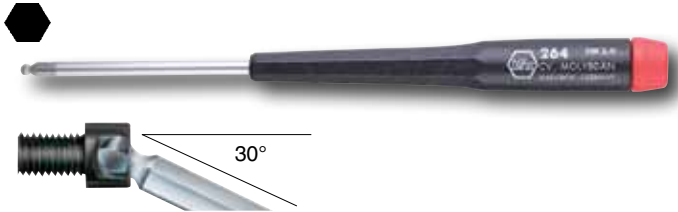

**264 Inch Ball End Hex Inch Screwdriver With Precision Handle**  
 Angle entry up to 30°. Blade high alloy chrome-vanadium-molybdenum steel. Hard chrome finish.

Item								
No.	Inch	mm	Inch	mm	Inch	lbs.	pkg.	
26413	.050	40	1.6	120	4.7	.02	10	
26416	1/16	50	2.0	145	5.7	.03	10	
26419	5/64	50	2.0	145	5.7	.03	10	
26423	3/32	50	2.0	145	5.7	.03	10	
26427	7/64	60	2.4	170	6.7	.03	10	
26431	1/8	60	2.4	170	6.7	.05	10	
26436	9/64	60	2.4	170	6.7	.05	10	
26439	5/32	60	2.4	170	6.7	.05	10	

\*Metric dimensions actual - Inch dimensions approximate

**Wiha Ball End Precision Series**



**62995 22 Piece Slotted/Phillips/TORX®/Ball End Hex Inch & Metric Tech Pack** Wiha Proturm precision ball retainer handle & 21 Wiha interchangeable blades. Set in canvas storage pouch

**62995 Set includes the following blades:**  
 † **Slotted:** 1.5, 2.0, 3.0, 4.0 **Phillips:** #000, #00, #0, #1  
**TORX®:** T6, T7, T8, T9, T10, T15, T20  
**Hex Inch:** .050, 1/16, 5/64, 3/32, 7/64, 1/8, 9/64, 5/32"  
**Hex Metric:** 1.5, 2.0, 2.5, 3.0, 4.0mm  
**lbs.** .87

**62994 14 Piece Inch/Metric Ball End Hex Work Tech Pack**  
 Proturm precision ball retainer handle & 13 Wiha interchangeable blades.

**62994 Set includes the following blades:**  
**Hex Inch:** .050, 1/16, 5/64, 3/32, 7/64, 1/8, 9/64, 5/32"  
**Hex Metric:** 1.5, 2.0, 2.5, 3.0, 4.0mm  
**lbs.** .66 Set in canvas storage pouch

**26490 8 Piece Ball End Hex Driver Set - Inch** Angle entry up to 30°.

Blade high alloy chrome-vanadium-molybdenum steel.



Item				
No.	Inch	Inch	lbs.	
26490	26413	.050	1.6	.40
	26416	1/16	2.0	
	26419	5/64	2.0	
	26423	3/32	2.0	
	26427	7/64	2.4	
	26431	1/8	2.4	
	26436	9/64	2.4	
	26439	5/32	2.4	

**SYS 4 Drive-Loc Precision Locking Tools**



**26961 ESD Safe Dissipative Precision Drive-Loc Handle**  
 Surface resistant 10<sup>6</sup>-10<sup>9</sup> Ohms. 4 mm hex retainer for all SYSTEM 4 interchangeable blades. Ball retainer hold. 105mm/4.13" OAL

Item					
No.	mm	Inch	mm	Inch	lbs.
26961	4.0	.1574	23	.91	.08



**280 SYSTEM 4 Metric Hex Drive-Loc Reversible Locking Blades**  
 On 4mm Hex blades

Item			
No.	mm	mm	lbs.
28003	1.3	+ 1.3	.02
28004	1.5	+ 1.5	.02
28005	2.0	+ 2.0	.02
28006	2.5	+ 2.5	.02
28007	3.0	+ 3.0	.02
28008	4.0	+ 4.0	.02

**26499 8 Piece Ball End Hex Driver Set - Inch**

Blade high alloy chrome-vanadium-molybdenum steel. Hard chrome finished. In canvas storage pouch



Item						
No.	Inch	Inch	Inch	Inch	lbs.	
26499	26413	.050	1.6	26427	7/64	2.4
	26416	1/16	2.0	26431	1/8	2.4
	26419	5/64	2.0	26436	9/64	2.4
	26423	3/32	2.0	26439	5/32	2.4



**Rotating Cap** for precise turning and control

**Precision Handle** high quality plastic, cadmium free. ESD Safe or Standard styles

**Tapered Handle** allows rapid rotation, requires less clearance

**Tips** exact fit, precision machined

**Blades** CVM steel, hardened, hard chromed

Collet Lock Handle adjustable blade length from 15 to 95mm/.6" to 3.75"



**26900 SYS 4 Standard Precision Handle**, with rotating control cap. Accepts all SYSTEM 4 interchangeable blades. Wiha Precision handle, tapered, impact resistant. Ball retainer hold. 110mm/4.3" OAL

Item				
No.	mm	Inch	mm	Inch lbs.
26900	4.0	.1574	14.0	.55 .04



**26901 SYSTEM 4 Standard Precision Adjustable handle** with rotating control cap.

- Allows adjustable blade from 15 to 95mm.
- Collet lock allows for quick & easy adjustment.
- Holds blade securely in place. Accepts all SYSTEM 4 blades. 110mm/4.3" OAL

Item				
No.	mm	Inch	mm	Inch lbs.
26901	4.0	.1574	14.0	.55 .06



**269 SYSTEM 4 Metric Ball End & Standard Hex, Reversible Blade**

Wiha vapor Chrome-Top finish on tips. One side hex, other side ball end hex.

Item					
No.	mm	mm	mm	Inch	lbs.
26932	1.27+1.27	120	4.7	.05	
26933	1.5 + 1.5	120	4.7	.05	
26934	2.0 + 2.0	120	4.7	.06	
26935	2.5 + 2.5	120	4.7	.06	
26936	3.0 + 3.0	120	4.7	.06	
26937	4.0 + 4.0	120	4.7	.06	

**28000 ESD Safe Dissipative Precision Handle** with rotating control cap. Surface resistant 10<sup>6</sup>-10<sup>9</sup> Ohms. 4 mm hex retainer for all SYSTEM 4 interchangeable blades. Tapered handle, high quality plastic, impact resistant. Ball retainer hold. 110mm/4.3" OAL

Item				
No.	mm	Inch	mm	Inch lbs.
28000	4.0	.1574	14.0	.55 .04

**28001 ESD Safe Dissipative Precision Adjustable Handle** with rotating control cap.

**Advantages:**

- Use in ESD sensitive applications. Surface resistant 10<sup>6</sup>-10<sup>9</sup> Ohms.
- Collet lock allows for quick & easy adjustment.
- Holds blade securely in place. Accepts all SYSTEM 4 blades. 110mm/4.3" OAL

Item				
No.	mm	Inch	mm	Inch lbs.
28001	4.0	.1574	14.0	.55 .04



**280 SYSTEM 4 Metric Ball End Hex Interchangeable Blade** Ball end works at 30° angle entry for easy access to fasteners.

Item					
No.	mm	mm	Inch	lbs.	pkg.
28033	1.5	120	4.7	.06	1
28034	2.0	120	4.7	.06	1
28035	2.5	120	4.7	.06	1
28036	3.0	120	4.7	.06	1
28037	4.0	120	4.7	.06	1

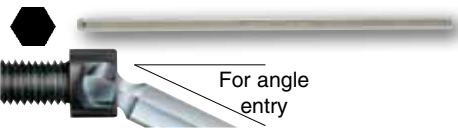

**280 SYSTEM 4 Inch Ball End Hex Interchangeable Blade** Ball end works at 30° angle entry for easy access to fasteners.

Item					
No.	Inch	mm	Inch	lbs.	
28021	.050	120	4.7	.06	
28023	1/16	120	4.7	.06	
28024	5/64	120	4.7	.06	
28025	3/32	120	4.7	.06	
28026	7/64	120	4.7	.06	
28027	1/8	120	4.7	.06	
28028	9/64	120	4.7	.06	
28029	5/32	120	4.7	.06	



**280 SYSTEM 4 Inch Ball End Hex Interchangeable Blade** Ball end works at 30° angle entry for easy access to fasteners.

Item					
No.	Inch	mm	Inch	lbs.	
28021	.050	120	4.7	.06	
28023	1/16	120	4.7	.06	
28024	5/64	120	4.7	.06	
28025	3/32	120	4.7	.06	
28026	7/64	120	4.7	.06	
28027	1/8	120	4.7	.06	
28028	9/64	120	4.7	.06	
28029	5/32	120	4.7	.06	

**269 SYSTEM 4 Metric Hex, Interchangeable Blade** High alloy CVM steel, hardened, corrosion protected.

Item				
No.	mm	mm	Inch	lbs.
26913	.71	120	4.7	.06
26914	.89	120	4.7	.06
26915	1.27	120	4.7	.06
26916	1.5	120	4.7	.06
26917	2.0	120	4.7	.06
26918	2.5	120	4.7	.06
26919	3.0	120	4.7	.06
26920	4.0	120	4.7	.06

**269 SYSTEM 4 Inch Hex, Interchangeable Blade** High alloy CVM steel, hardened, corrosion protected.

Item				
No.	Inch	mm	Inch	lbs.
26921	.050	120	4.7	.06
26923	1/16	120	4.7	.06
26924	5/64	120	4.7	.06
26925	3/32	120	4.7	.06
26926	7/64	120	4.7	.06
26927	1/8	120	4.7	.06
26928	9/64	120	4.7	.06
26929	5/32	120	4.7	.06

**26999 9 Pc. Hex Metric Precision Blade Set** Set includes the following blades:

- Hex Metric:** .71, .89, 1.27, 1.5, 2.0, 2.5, 3.0, 4.0mm
- lbs.** .66

Wiha ESD Safe Precision Collet Lock handle and 8 Wiha interchangeable blades

**26999 9 Pc. Hex Metric Precision Blade Set** Set includes the following blades:

- Hex Metric:** .71, .89, 1.27, 1.5, 2.0, 2.5, 3.0, 4.0mm
- lbs.** .66

**26989 9 Pc. Hex Inch Precision Blade Set** Set includes the following blades:

- Hex Inch:** .050, 1/16, 5/64, 3/32, 7/64, 1/8, 9/64, 5/32"
- lbs.** .64

Wiha ESD Safe Precision Collet Lock handle and 8 Wiha interchangeable blades

**26989 9 Pc. Hex Inch Precision Blade Set** Set includes the following blades:



- Hex Inch:** .050, 1/16, 5/64, 3/32, 7/64, 1/8, 9/64, 5/32"
- lbs.** .64

**Wiha SYSTEM 4 Micro Bits & Compact Bit Sets**





18 Pc. Set

**75395 18 Piece SYSTEM 4 Hex Inch & Metric Precision Interchangeable Bit Set, In Compact Fold Out Box**  
Wiha precision handle, bit extension & 16 Wiha interchangeable bits.

Item No.	Combination Bit Set
75395	Set with Standard Precision Handle
<b>Set includes the following bits:</b>	
	<b>Hex Metric:</b> .71, .89, 1.27, 1.5, 2.0, 2.5, 3.0, 4.0mm
	<b>Hex Inch:</b> .050, 1/16, 5/64, 3/32, 7/64, 1/8, 9/64, 5/32"
	<b>100mm Bit Extension</b>
	<b>lbs.</b> .58

**75096 16 Piece Precision Micro Bit Hex Inch & Metric Sets**  
ESD Safe precision handle, Bit Extension and 14 CVM steel Micro Bits.

**Set includes the following Micro Bits:**

	<b>Inch:</b> 0.89/0.35", 1.27/.050", 1/16, 5/64, 3/32, 7/64, 1/8, 9/64, 5/32"
	<b>Metric:</b> 1.5, 2.0, 2.5, 3.0, 4.0mm
	<b>lbs.</b> .14



**75983 Micro Bit Handle Storage Hex Inch Bit Set, 7 Pcs.** Wiha precision storage handle & 6 interchangeable bits.

Item No.	Precision Storage Handle Set
75983	<b>Hex Inch:</b> .050, 1/16, 5/64, 3/32, 7/64, 1/8"
	<b>lbs.</b> .08

**SYSTEM 4 Handles & Micro Bits**

**Tips** exact fit, precision machined

**Rotating Cap** for precise turning and control

**Tapered Handle** allows rapid rotation, requires less clearance





**Bits** CVM steel, hardened

Use bits directly in handle or with 4" bit extension



110mm/4.3" OAL

**75800 SYSTEM 4 Standard Precision Bit Handle** with rotating control cap. Tapered, high quality plastic, impact resistant, ball retainer. Accepts all SYSTEM 4 Series bits.





Item					
No.	mm	Inch	mm	Inch	lbs.
75800	4.0	.1574	14.0	.55	.06







110mm/4.3" OAL

**75801 SYSTEM 4 ESD Safe Dissipative Precision Bit Handle** with rotating control cap. Tapered, high quality plastic, impact resistant. **Advantages:**





- For working in ESD sensitive applications Surface resistant 10<sup>6</sup>-10<sup>9</sup> Ohms
- Ball retainer holds bits securely in place
- Accepts all SYSTEM 4 Series bits

Item					
No.	mm	Inch	mm	Inch	lbs.
75801	4.0	.1574	14.0	.55	.06





**75901 Magnetic Bit Extension Blade For SYSTEM 4 Micro Bits** Shaft CVM steel, hardened. Magnetic bit holder.

Item				
No.	Size	mm	mm	lbs.
75901	4.0	100	4.0	.04





**75900 Extension Blade For SYSTEM 4 Micro Bits** Shaft CVM steel, hardened, corrosion protected. Ball retainer bit extension for 4 mm bits.

Item				
No.	Size	mm	mm	lbs.
75900	4.0	100	4.0	.07





**753 SYSTEM 4 Hex Metric Bits** High alloy CVM steel, hardened, on 4 mm hex stock.

Item				
No.	mm	mm	Inch	lbs.
75307	.71	28	1.1	.01
75309	.89	28	1.1	.01
75313	1.27	28	1.1	.01
75315	1.5	28	1.1	.01
75320	2.0	28	1.1	.01
75325	2.5	28	1.1	.01
75330	3.0	28	1.1	.01
75340	4.0	28	1.1	.01





**753 SYSTEM 4 Hex Inch Bits** High alloy CVM steel, hardened, on 4 mm hex stock.

Item				
No.	Inch	mm	Inch	lbs.
75307	.028	28	1.1	.01
75309	.035	28	1.1	.01
75313	.050	28	1.1	.01
75350	1/16	28	1.1	.01
75352	5/64	28	1.1	.01
75354	3/32	28	1.1	.01
75356	7/64	28	1.1	.01
75358	1/8	28	1.1	.01
75360	9/64	28	1.1	.01
75340	5/32	28	1.1	.01

**753 SYSTEM 4 Metric Security Hex Bits** High alloy CVM steel, hardened, on 4 mm hex stock.

Item				
No.	mm	mm	Inch	lbs.
75322	2.0	28	1.1	.01
75327	2.5	28	1.1	.01
75332	3.0	28	1.1	.01
75342	4.0	28	1.1	.01

**753 SYSTEM 4 Security Hex Inch Bits** High alloy CVM steel, hardened, on 4 mm hex stock.

Item				
No.	Inch	mm	Inch	lbs.
75362	5/64	28	1.1	.01
75364	3/32	28	1.1	.01
75366	7/64	28	1.1	.01
75368	1/8	28	1.1	.01
75370	9/64	28	1.1	.01
75372	5/32	28	1.1	.01

**Wiha Cushion Grip Stubby Bit Holder**

**Stubby 6 in 1 Multi-Bit Driver Sets**



**38056** Ball End Hex SoftFinish® CushionGrip Stubby Bit Holder with Wiha cushion grip handle and CVM tool steel shaft.

Set includes the following 1/4" bits:

● Ball End Hex Inch: 1/8, 9/64, 5/32,	lbs.
3/16, 7/32, 1/4"	.21



**38057** Hex Metric SoftFinish® CushionGrip Stubby Bit Holder with Wiha cushion grip handle and CVM tool steel shaft.

Set includes the following 1/4" bits:

● Hex Metric: 2.0, 2.5, 3.0	lbs.
4.0, 5.0, 6.0mm	.18



**38058** Hex Inch SoftFinish® CushionGrip Stubby Bit Holder with Wiha cushion grip handle and CVM tool steel shaft.

Set includes the following 1/4" bits:

● Hex Inch: 3/32, 7/64, 1/8,	lbs.
9/64, 5/32, 3/16"	.18

**Wiha Torque Ratchet Bit Sets**

**Smooth, high torque, silent ratchet handle**

**Pistol Grip Handle** ergonomic design with free running mechanism. Instant clutch engagement allows constant turning pressure on the fastener.

**Hex Retainer** for bit holder blades



**No release** of handle is needed, change of direction can be made with index finger and thumb.  
**Allows for** quick adjustment to right, left or fixed turning.

**Opens a new generation of easier torque transmission**

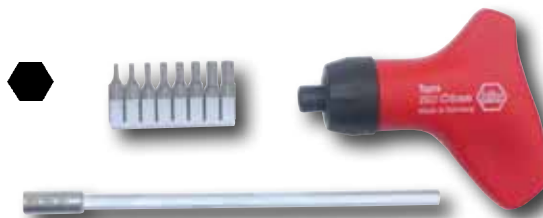

**28298** 12 Piece Hex Inch Topra Ratchet Bit Set

Set includes Topra Handle, Magnetic bit holder and the following bits:

● Hex Inch:	lbs.
1/16, 5/64, 3/32, 7/64, 1/8,	.65
9/64, 5/32, 3/16, 7/32, 1/4"	

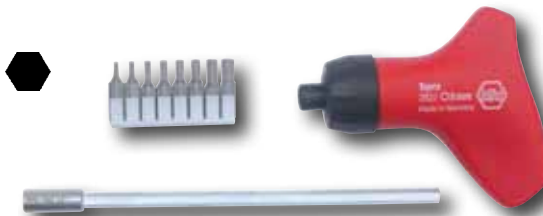

**28299** 10 Piece Hex Metric Topra Ratchet Bit Set

Set includes Topra Handle, Magnetic bit holder and the following bits:

● Hex Metric:	lbs.
1.5, 2.0, 2.5, 3.0, 4.0, 5.0, 6.0, 8.0mm	



### Wiha Bit Selectors

Compact size and easy bit selection make the Bit Selector an ideal maintenance tool



Plastic storage box is compact, durable and light weight

Slide out drawer allows quick bit access and secure storage



Molded hex cavity in box end Magnetic adapter fits into opening so tool case can be used as a handle on quick fastening jobs

1/4" Magnetic Adapter fits all standard 1/4" bits

#### 792 Sets Bit-Selector Sets

These handy sets include 10 hardened bits of chrome-vanadium-molybdenum steel. 1/4" magnetic bit holder can be used in power tools. Plastic storage box is compact, durable and light weight. Molded hex cavity turns box into handle for quick fastening jobs. Quick bit access with slide out drawer. Packaged in clear blister pack.



#### 79276 Bit-Selector With Ball End Hex Inch Bits. Set Includes Magnetic 1/4" Bit Holder & The Following 8 Bits:

Ball End Hex Inch: 3/32, 7/64, 1/8, 9/64, 5/32, 3/16, 7/32, 1/4" lbs. .30



Item #79246

#### 79246 Bit-Selector With Hex Metric Bits. Set Includes Magnetic 1/4" Bit Holder & The Following 10 Bits:

Hex Inch: 1/16, 5/64, 3/32, 7/64, 1/8, 9/64, 5/32, 3/16, 7/32, 1/4" lbs. .32

#### 79256 Bit-Selector With Hex Metric Bits. Set Includes Magnetic 1/4" Bit Holder & The Following 8 Bits:

Hex Metric: 1.5, 2.0, 2.5, 3.0, 4.0, 5.0, 6.0, 8.0mm lbs. .30



#### 79266 Bit-Selector With Security Hex Inch Bits. Set Includes Magnetic 1/4" Bit Holder & The Following 9 Bits:

Hex Inch: 5/64, 3/32, 7/64, 1/8, 9/64, 5/32, 3/16, 7/32, 1/4" lbs. .31

### Screw Holding



### MagicRing



#### 71399 Bit-Selector With Metric & Inch MagicRing Insert 1/4" Bits Set Includes Magnetic 1/4" Bit Holder & The Following 10 Bits:

No Ball End lbs. .46  
Hex Metric: 3.0, 4.0, 5.0, 6.0mm  
Hex Inch: 1/8, 9/64, 5/32, 3/16, 7/32, 1/4"

### Wiha MagicRing Insert Bits

#### Screw Holding Hex Bits



#### 713 MagicRing Metric Insert Bits, 1/4"

Item	Hex	Flat	Ball	Ball
No.	mm	mm	pkg.	lbs.
71304	3.0	25	1	.01
71307	4.0	25	1	.01
71310	5.0	25	1	.01
71311	6.0	25	1	.01

#### 713 MagicRing Inch Insert Bits, 1/4"

Item	Hex	Flat	Ball	Ball
No.	Inch	mm	pkg.	lbs.
71343	1/8	25	1	.01
71346	9/64	25	1	.01
71349	5/32	25	1	.01
71352	3/16	25	1	.01
71354	7/32	25	1	.01
71358	1/4	25	1	.01

### Wiha MagicRing Power Bits

#### Screw Holding Hex Bits



#### 743 MagicRing Metric Power Bits, 1/4"

Item	Hex	Flat	Ball	Ball
No.	mm	mm	pkg.	lbs.
74301	3.0	50	1	.02
74305	4.0	50	1	.02
74307	5.0	50	1	.03
74319	6.0	50	1	.03

#### 743 MagicRing Inch Power Bits, 1/4"

Item	Hex	Flat	Ball	Ball
No.	mm	mm	pkg.	lbs.
74369	1/8	50	1	.02
74371	9/64	50	1	.02
74373	5/32	50	1	.02
74375	3/16	50	1	.03
74377	7/32	50	1	.03
74379	1/4	50	1	.03

### Wiha XSelector Bit Sets

Compact size and easy bit selection make the Wiha XSelector an ideal maintenance tool

Easy bit access with hinged cover



XSelector Pocket Sized  
3-1/8" x 2-1/8" x 1/2"

Sets include Clicfix quick release holder

#### 794 Sets XSelector Bit Sets

These handy sets include 10 hardened bits of chrome-vanadium-molybdenum steel. 1/4" Quick Release holder can be used in power tools. Quick bit access through integrated bit-clip.



#### 79446 XSelector Bit Set With Hex Inch Bits

Set Includes Quick Release Holder  lbs. and the following 10 bits: .27

- Hex Inch: 1/16, 5/64, 3/32, 7/64, 1/8, 9/64, 5/32, 3/16, 7/32, 1/4"

### Wiha Security Hex Inch & Metric PokitPaks



#### 71998 PokitPak - Security Hex Inch Insert Bits In Molded Case - Set includes 6 - 1/4" Insert Bits

Hex Inch Security Hex:  lbs. 3/32, 7/64, 1/8, 9/64, 5/32, 3/16" .12



#### 71995 PokitPak - Security Hex Insert Bits In Molded Case - Set includes 6 - 1/4" Insert Bits

Metric Security Hex:  lbs. 2.5, 3.0, 4.0, 5.0, 6.0, 8.0mm .31

### Wiha Power Bit Belt Packs



#### 74986 Power Bit Belt Pack With Inch & Metric Hex Bits

Set includes the following 10 bits:  lbs.

- Inch: 1/8, 9/64, 5/32, 3/16, 7/32, 1/4"
- Metric: 3.0, 4.0, 5.0, 6.0mm .34



#### Screw Holding Hex Bits

#### 74989 Power Bit Belt Pack With Screw Holding Hex MagicRing Bits

Set includes the following 10 bits:  lbs.

- Inch: 1/8, 9/64, 5/32, 3/16, 7/32, 1/4"
- Metric: 3.0, 4.0, 5.0, 6.0mm .34



#### Screw Holding Hex Bits

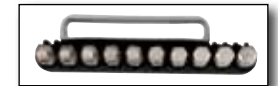

#### 74999 Power Bit Belt Pack With Screw Holding Inch & Metric

Ball End Hex MagicRing Bits

Set includes the following 10 bits:  lbs.

- Inch: 1/8, 9/64, 5/32, 3/16, 7/32, 1/4"
- Metric: 3.0, 4.0, 5.0, 6.0mm .37

### Wiha Security Hex Inch Multi Bit Set



#### 38014 Security Hex Inch Multi-Bit Screwdriver, 6 Pc. Set

With Wiha Powerhandle & CVM steel, hardened shaft.

Set includes the following 1/4" bits:  lbs.

Security Hex: 3/32, 1/8, 5/32, 3/16, 7/32" lbs. .39

# Hex Bits

The ideal multi-purpose bits for all around quality & performance

Made in Germany - Production Quality

Highly resistant to wear and tear for a long tool life



Impact resistant modified CVM, tool steel, hardened

Suitable for all applications for both manual & machine Hardness HRC 59-61

## Wiha Hex Inch & Metric Insert Bits



### 713 Hex Metric Insert Bits, 1/4"

Item No.	mm	mm	pkg.	lbs.
71303	1.5	25	10	.12
71306	2.0	25	10	.12
71308	2.5	25	10	.12
71309	3.0	25	10	.12
71312	4.0	25	10	.12
71315	5.0	25	10	.14
71318	6.0	25	10	.14
71321	8.0	25	10	.20
71324	10.0	25	10	.27



### 713 Hex Inch Insert Bits, 1/4"

Item No.	Inch	mm	pkg.	lbs.
71329	.050	25	10	.12
71326	1/16	25	10	.12
71328	5/64	25	10	.12
71330	3/32	25	10	.12
71333	7/64	25	10	.12
71336	1/8	25	10	.12
71339	9/64	25	10	.12
71342	5/32	25	10	.12
71345	3/16	25	10	.13
71348	7/32	25	10	.13
71351	1/4	25	10	.13
71353	5/16	25	10	.20
71356	3/8	25	10	.25

## Wiha Hex Inch & Metric Insert Bit Packs



2 bit pack

### 713 Hex Inch Insert Bit Packs, 1"

CVM S2 modified tool steel.

Item No.	Inch	mm	lbs.
71359	.050	25	.03
71360	1/16	25	.03
71361	5/64	25	.03
71362	3/32	25	.03
71363	7/64	25	.03
71364	1/8	25	.03
71365	9/64	25	.03
71366	5/32	25	.04
71367	3/16	25	.04
71368	7/32	25	.04
71369	1/4	25	.04
71373	5/16	25	.05
71387	3/8	25	.06

### 733 Hex Metric Insert Bit Packs, 1"

CVM S2 modified tool steel.

Item No.	mm	mm	lbs.
73301	1.5	25	.03
73302	2.0	25	.03
73303	2.5	25	.03
73304	3.0	25	.03
73305	4.0	25	.03
73306	5.0	25	.03
73307	6.0	25	.04
73308	8.0	25	.05
73309	10.0	25	.06



### 71396 Hex Inch Insert Bit Packs, 1" CVM

S2 modified tool steel. Extra hard with natural finish. Exact fit machined tips. 6 pc. bit pack.

71396 Set includes the following bits:

Hex Inch:	Hex Metric:
1/16, 3/32, 1/8, 5/32	2.0, 2.5, 3.0, 4.0, 5.0, 6.0
wt. .13	3/16, 1/4" x 1" (25mm)

### 71397 Hex Metric Insert Bit Packs, 1" CVM

S2 modified tool steel. Extra hard with natural finish. Exact fit machined tips. 6 pc. bit pack.

71397 Set includes the following bits:

Hex Metric:
2.0, 2.5, 3.0, 4.0, 5.0, 6.0
wt. .21

## Wiha Security Hex Insert Bits



### 719 Security Hex In Insert Bits, 1/4"

Item No.	Inch	mm	pkg.	lbs.
71930	5/64	25	10	.12
71932	3/32	25	10	.12
71934	7/64	25	10	.12
71936	1/8	25	10	.12
71938	9/64	25	10	.12
71940	5/32	25	10	.12
71955	3/16	25	10	.13
71956	7/32	25	10	.14
71960	1/4	25	10	.15



### 719 Security Hex Metric Insert Bits, 1/4"

Item No.	mm	mm	pkg.	lbs.
71939	2.0	25	10	.12
71941	2.5	25	10	.12
71942	3.0	25	10	.12
71943	4.0	25	10	.12
71944	5.0	25	10	.15
71945	6.0	25	10	.15
71946	8.0	25	10	.20



2 bit pack

### 719 Security Hex Inch Insert Bit Packs, 1"

CVM S2 modified tool steel.

Item No.	Inch	mm	lbs.
71970	5/64	25	.03
71971	3/32	25	.03
71972	7/64	25	.03
71973	1/8	25	.03
71974	9/64	25	.03
71975	5/32	25	.03
71976	3/16	25	.04
71977	7/32	25	.04
71978	1/4	25	.04

### 719 Security Hex Metric Insert Bit Packs, 1"





CVM S2 modified tool steel.

Item No.	mm	mm	lbs.
71979	2.0	25	.03
71980	2.5	25	.03
71981	3.0	25	.03
71982	4.0	25	.03
71983	5.0	25	.04
71984	6.0	25	.04
71985	8.0	25	.05

**Wiha Hex Inch & Metric Power Bits**







**743 Hex Inch Power Bits**  
1/4" Hex Drive, Length 2.0"/50mm

Item				
No.	Inch	mm	pkg.	lbs.
74311	3/32	50	10	.30
74312	7/64	50	10	.30
74313	1/8	50	10	.30
74314	9/64	50	10	.30
74315	5/32	50	10	.30
74316	3/16	50	10	.30
74317	7/32	50	10	.30
74318	1/4	50	10	.30







**743 Hex Inch Power Bits**  
1/4" Hex Drive, Length 2.75"/70mm

Item				
No.	Inch	mm	pkg.	lbs.
74341	5/64	70	1	.36
74342	3/32	70	1	.36
74343	7/64	70	1	.36
74344	1/8	70	1	.36
74345	9/64	70	1	.36
74346	5/32	70	1	.36
74347	3/16	70	1	.36
74348	7/32	70	1	.36
74349	1/4	70	1	.36







**743 Hex Metric Power Bits**  
1/4" Hex Drive, Length 2.0"/50mm

Item				
No.	mm	mm	pkg.	lbs.
74325	2.5	50	10	.25
74330	3.0	50	10	.25
74340	4.0	50	10	.25
74350	5.0	50	10	.25
74360	6.0	50	10	.25
74380	8.0	50	10	.38







**743 Hex Metric Power Bits**  
1/4" Hex Drive, Length 2.75"/70mm

Item				
No.	mm	mm	pkg.	lbs.
74351	2.0	70	1	.36
74352	2.5	70	1	.36
74353	3.0	70	1	.36
74354	4.0	70	1	.36
74355	5.0	70	1	.36
74356	6.0	70	1	.36
74357	8.0	70	1	.36







2 bit pack

**743 Hex Inch Power Bit Packs, 2"**

Item				
No.	Inch	mm	lbs.	
74381	3/32	50	.07	
74382	7/64	50	.07	
74383	1/8	50	.07	
74384	9/64	50	.07	
74385	5/32	50	.07	
74386	3/16	50	.07	
74387	7/32	50	.07	
74388	1/4	50	.07	





**743 Hex Metric Power Bit Packs, 2"**

Item				
No.	mm	mm	lbs.	
74361	2.5	50	.07	
74362	3.0	50	.07	
74363	4.0	50	.07	
74364	5.0	50	.07	
74365	6.0	50	.07	
74366	8.0	50	.09	

**Hex MetricLong Insert Bit On 5/16"**





**72388 Hex Metric Bit On 5/16" Stock**

Item				
No.	mm	mm	pkg.	lbs.
72388	12.0	75	10	.14

**Stainless Steel Hex Metric Bits**







**701 Stainless Steel Hex Metric Insert Bits**

Item			
No.	mm	mm	pkg.
70170	1.5	25	10
70171	2.0	25	10
70172	2.5	25	10
70173	3.0	25	10
70174	4.0	25	10
70175	5.0	25	10
70176	6.0	25	10

**Wiha Ball End Hex Inch Insert Bits**







**717 Ball End Hex Inch Insert Bits, 1/4"**

Item				
No.	Inch	mm	pkg.	lbs.
71701	3/32	25	10	.12
71702	7/64	25	10	.12
71703	1/8	25	10	.12
71704	9/64	25	10	.12
71705	5/32	25	10	.12
71706	3/16	25	10	.13
71707	7/32	25	10	.13
71708	1/4	25	10	.13



2 bit pack

**717 Ball End Hex Inch Insert Bit Packs, 1"**



Item				
No.	Inch	mm	lbs.	
71711	3/32	25	.03	
71712	7/64	25	.03	
71713	1/8	25	.03	
71714	9/64	25	.03	
71715	5/32	25	.04	
71716	3/16	25	.04	
71717	7/32	25	.04	
71718	1/4	25	.04	

**Ball End Hex Metric Power Bits**

2 pc. bit pack!



**717 Ball End Hex Metric Power Bits**

Item			
No.	mm	mm	pkg.
71719	1.5	38	1
71720	2.0	38	1
71721	2.5	38	1
71722	3.0	38	1
71723	4.0	38	1
71724	5.0	38	1
71725	6.0	38	1

**Wiha Terminator Hex Inch & Metric Impact Bits - Insert & Power**

**Up To 30X  
Performance Over  
Standard  
Screwdriver Bits**



Impact rated bits for long life in impact applications

Provide up to 30 times impact performance over standard bits

Standard 1/4" drive - No special adaptor required

Wiha enhanced bi-material torsion zone

Precision machined exact fit tips

Wiha exclusive CVM tool steel

Guaranteed to out perform impact imposters



**765 Hex Inch Terminator Impact Bits, 1/4" Insert - 10 bit pack**

Item	Hex	Insert	Power
No.	Inch	mm	pkg.
76530	1/8	29	10
76531	9/64	29	10
76532	5/32	29	10
76533	3/16	29	10
76534	7/32	29	10
76535	1/4	29	10



**765 Hex Metric Terminator Impact Bits, 1/4" Insert - 10 bit pack**

Item	Hex	Insert	Power
No.	Inch	mm	pkg.
76523	3.0	29	10
76524	4.0	29	10
76525	5.0	29	10
76526	6.0	29	10

**768 Hex Inch Terminator Impact Bits, 1/4" Insert - 2 bit pack**

Item	Hex	Insert	Power
No.	Inch	mm	pkg.
76830	1/8	29	2
76831	9/64	29	2
76832	5/32	29	2
76833	3/16	29	2
76834	7/32	29	2
76835	1/4	29	2

**768 Hex Metric Terminator Impact Bits, 1/4" Insert - 2 bit pack**

Item	Hex	Insert	Power
No.	Inch	mm	pkg.
76823	3.0	29	2
76824	4.0	29	2
76825	5.0	29	2
76826	6.0	29	2



**765 Hex Inch Terminator Impact Bits, 1/4" Power - 10 bit pack**

Item	Hex	Insert	Power
No.	Inch	mm	pkg.
76570	1/8	49	10
76571	9/64	49	10
76572	5/32	49	10
76573	3/16	49	10
76574	7/32	49	10
76575	1/4	49	10

**768 Hex Inch Terminator Impact Bits, 1/4" Power - 2 bit pack**

Item	Hex	Insert	Power
No.	Inch	mm	pkg.
76870	1/8	49	2
76871	9/64	49	2
76872	5/32	49	2
76873	3/16	49	2
76874	7/32	49	2
76875	1/4	49	2



**765 Hex Metric Terminator Impact Bits, 1/4" Power - 10 bit pack**

Item	Hex	Insert	Power
No.	Inch	mm	pkg.
76563	3.0	49	10
76564	4.0	49	10
76565	5.0	49	10
76566	6.0	49	10

**768 Hex Metric Terminator Impact Bits, 1/4" Power - 2 bit pack**

Item	Hex	Insert	Power
No.	Inch	mm	pkg.
76863	3.0	49	2
76864	4.0	49	2
76865	5.0	49	2
76866	6.0	49	2

**1/4" Drive Insert & Power Bits**

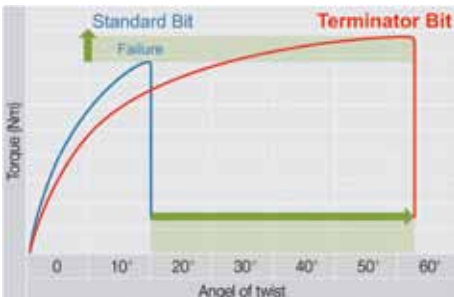

**Up To 30X Performance  
Over Standard Screwdriver Bits**



**76893 7 Pc. Bit Buddy Set With Terminator Impact Insert Bits - 29mm**

- 76893 Set includes the following bits:
- Hex Inch: 5/32, 3/16, 7/32, 1/4"
  - Hex Metric: 4, 5, 6mm



**76894 7 Pc. Bit Buddy Set With Terminator Impact Power Bits - 49mm**

- 76894 Set includes the following bits:
- Hex Inch: 5/32, 3/16, 7/32, 1/4"
  - Hex Metric: 4, 5, 6mm

**91247 Empty Bit Buddy Case Holds Terminator Impact Insert Bits**

91247 Holds 7 Impact Bits

**91313 Empty Bit Buddy Case Holds Terminator Impact Power Bits**

91313 Holds 7 Impact Bits

### Wiha Bit Holders

#### Quick Release



#### 714 ClicFix Bit Holder, Magnetic, For Insert Bits

Item				
No.	Size	Size	mm	Inch
71490	1/4"	1/4"	60	2.4
71491	1/4"	1/4"	75	2.9

#### Quick Release

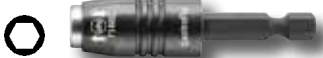

#### 714 CentroFix Bit Holder For Power Bits

Item				
No.	Size	Size	mm	Inch
71480	1/4"	1/4"	60	2.3

### Wiha Impact Bit Holding Sockets



#### 720 Impact Bit Holding Socket With Retaining Ring

For 1/4" drive bits.

Item				
No.	Bit	mm	Drive	lbs.
72001	1/4	25	1/4"	.05
72002	1/4	30	3/8"	.10
72003	1/4	35	1/2"	.21

#### 72090 3 Piece Bit Holding Socket Set

for use with 1/4" Insert bits

Drive:		lbs.
1/4", 3/8", 1/2"		.40

### Long Blade Sockets & Sets



#### 771 Hex Metric Sockets

1/4" Drive 6" Long Bit Socket

Item			
No.	Size	Inch	lbs.
77140	2.5	6.0	.13
77142	3.0	6.0	.13
77144	4.0	6.0	.13
77146	5.0	6.0	.13
77148	6.0	6.0	.13

#### 77192 5 Pc. Hex Metric Socket Blade Set

Metric: 2.5, 3.0, 4.0, 5.0, 6.0mm

lbs. .70

### Long Blade Sockets & Sets



#### 771 Hex Inch Sockets 1/4" Drive 6" Long Bit Socket

Item			
No.	Size	Inch	lbs.
77128	3/32	6.0	.12
77130	7/64	6.0	.12
77132	1/8	6.0	.12
77134	9/64	6.0	.12
77136	5/32	6.0	.12
77138	3/16	6.0	.12
77139	7/32	6.0	.12
77141	1/4	6.0	.12

#### 77191 8 Piece Hex Inch Socket Blade Set

Inch: 3/32, 7/64, 1/8, 9/64, 5/32,

3/16, 7/32, 1/4" wt. .97



#### 771 Hex Inch Sockets 3/8" Drive 6" Long Bit Socket

Item			
No.	Size	Inch	lbs.
77165	3/32	6.0	.18
77167	7/64	6.0	.18
77169	1/8	6.0	.18
77171	9/64	6.0	.18
77173	5/32	6.0	.18
77175	3/16	6.0	.18
77177	7/32	6.0	.18
77179	1/4	6.0	.18



#### 77198 22 Piece Hex & TORX® Long Blade Socket Set, 1/4" Drive

Inch Hex: 3/32, 7/64, 1/8, 9/64, 5/32,

3/16, 7/32, 1/4"

Metric Hex: 2.5, 3.0, 4.0, 5.0, 6.0mm

TORX®: T8, T9, T10, T15, T20, T25, T27, T30, T40

lbs. 2.82

### Wiha Sockets



#### 713 Hex Sockets 1/4" Square drive socket. Replaceable bit.



1/4" bits CVM steel.

Item			
No.	Inch	mm	lbs.
71371	1/16	38	.05
71370	5/64	38	.05
71372	3/32	38	.05
71374	7/64	38	.05
71376	1/8	38	.05
71378	9/64	38	.05
71380	5/32	38	.05
71382	3/16	38	.05
71384	7/32	38	.05
71386	1/4	38	.05

**Wiha Sockets**





**713 Hex Sockets** 3/8" Square drive socket. Replaceable bit.  
1/4" bits CVM tool steel.

Item			
No.	Inch	mm	lbs.
71375	1/8	42	.09
71377	9/64	42	.09
71379	5/32	42	.09
71381	3/16	42	.09
71383	7/32	42	.09
71385	1/4	42	.09
71388	5/16	42	.10
71390	3/8	42	.10





**713 Hex Metric Sockets** 1/4" Square drive socket. Replaceable bit. 1/4" bits CVM steel.

Item			
No.	mm	mm	lbs.
71301	1.5	38	.04
71302	2.0	38	.04
71305	2.5	38	.04
71313	3.0	38	.04
71314	4.0	38	.04
71317	5.0	38	.05
71319	6.0	38	.05
71327	8.0	38	.05
71340	10.0	38	.05





**713 Hex Metric Sockets** 3/8" Square drive socket. Replaceable bit.  
1/4" bits CVM steel.

Item			
No.	mm	mm	lbs.
71300	2.0	42	.09
71316	2.5	42	.09
71341	3.0	42	.09
71331	4.0	42	.09
71323	5.0	42	.09
71325	6.0	42	.09
71320	8.0	42	.10
71322	10.0	42	.11





**713 Hex Metric Sockets** 3/8" Square drive socket. Replaceable bit.  
5/16" bits CVM steel.

Item			
No.	mm	mm	lbs.
71332	12.0	75	.22





Replaceable bit

**761 Security Hex Inch Sockets**  
3/8" Square drive socket. 1/4" bits CVM steel.



Item			
No.	Inch	mm	lbs.
76164	5/64	42	.09
76165	3/32	42	.09
76166	7/64	42	.09
76167	1/8	42	.09
76168	9/64	42	.09
76169	5/32	42	.09
76170	3/16	42	.09
76171	7/32	42	.09
76172	1/4	42	.09

**761 Security Hex Metric Sockets**  
3/8" Square drive socket. 1/4" bits CVM steel.

Item			
No.	mm	mm	lbs.
76132	2.0	42	.09
76133	2.5	42	.09
76134	3.0	42	.09
76135	4.0	42	.09
76136	5.0	42	.09
76137	6.0	42	.09
76138	8.0	42	.09





**717 Ball End Hex Sockets** 1/4" Square drive socket. Replaceable bit.  
1/4" bits CVM steel.

Item			
No.	Inch	mm	lbs.
71761	3/32	38	.09
71762	7/64	38	.09
71763	1/8	38	.09
71764	9/64	38	.09
71765	5/32	38	.09
71766	3/16	38	.09
71767	7/32	38	.09
71768	1/4	38	.09



**717 Ball End Hex Metric Sockets**  
1/4" Square drive socket. Replaceable bit.  
1/4" bits CVM steel.

Item			
No.	mm	mm	lbs.
71771	1.5	51	.11
71772	2.0	51	.11
71773	2.5	51	.11
71774	3.0	51	.11
71775	4.0	51	.11
71776	5.0	51	.12
71777	6.0	51	.12

## Wiha Socket Sets On Molded Rails

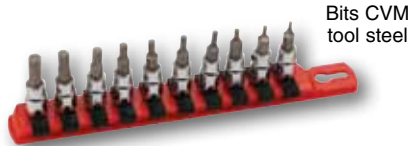

### 71391 10 Piece Hex Inch Socket Set

1/4" Square drive replaceable bit socket.

Item No. 

<b>71391</b>	lbs.	<b>Set includes the following:</b>
.48		1/16, 5/64, 3/32, 7/64, 1/8
		9/64, 5/32, 3/16, 7/32, 1/4"

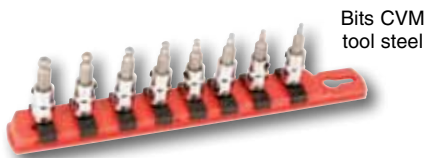

### 71798 8 Pc. Ball End Hex Inch Socket Set

1/4" Square Drive Replaceable Bit Socket.

Item No. 

<b>71798</b>	lbs.	<b>Set includes the following:</b>
.72		3/32, 7/64, 1/8, 9/64, 5/32, 3/16, 7/32, 1/4"

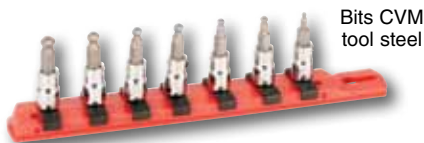

### 71398 7 Pc. Ball End Hex Inch Socket Set

1/4" Square Drive Replaceable Bit Socket.

Item No. 

<b>71398</b>	lbs.	<b>Set includes the following:</b>
.48		3/32, 1/8, 9/64, 5/32,
		3/16, 7/32, 1/4"

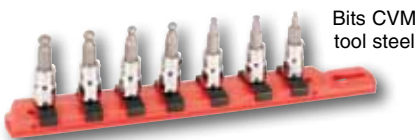

### 71797 7 Pc. Ball End Hex Metric Sockets

1/4" Square Drive Replaceable Bit Socket.

Item No. 

<b>71797</b>	lbs.	<b>Set includes the following:</b>
.72		Hex Metric: 1.5, 2.0, 2.5,
		3.0, 4.0, 5.0, 6.0mm



### 71392 8 Piece Hex Inch Socket Set

3/8" Square Drive Replaceable Bit Socket.

Item No. 

<b>71392</b>	lbs.	<b>Set includes the following:</b>
.78		1/8, 9/64, 5/32, 3/16, 7/32,
		1/4, 5/16, 3/8"

Bits CVM tool steel



### 71393 5 Piece Hex Inch Socket Set

3/8" Square Drive Replaceable Bit Socket.

Item No. 

<b>71393</b>	lbs.	<b>Set includes the following:</b>
.54		Hex Inch: 1/8, 3/16,
		1/4, 5/16, 3/8"

Bits CVM tool steel



### 71394 5 Piece Hex Metric Socket Set

3/8" Square Drive Replaceable Bit Socket.

Item No. 

<b>71394</b>	lbs.	<b>Set includes the following:</b>
.56		Hex Metric: 4.0, 5.0, 6.0,
		8.0, 10.0mm

Bits CVM tool steel



### 71996 9 Piece Hex Metric Socket Set

1/4" & 3/8" Sq. Dr. Replaceable Bit Socket

Item No. 

<b>71996</b>	lbs.	<b>Set includes the following:</b>
.66		1/4": 1.5, 2.0, 2.5, 3.0, 4.0mm
		3/8": 5.0, 6.0, 8.0, 10.0mm

Bits CVM tool steel

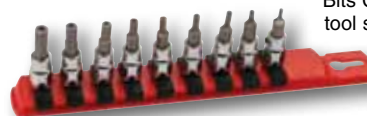

### 71999 9 Pc. Security Hex Inch Socket Set

3/8" Square Drive Replaceable Bit Socket.

Item No. 

<b>71999</b>	lbs.	<b>Set includes the following:</b>
.86		5/64, 3/32, 7/64, 1/8,
		9/64, 5/32, 3/16, 7/32, 1/4"

Bits CVM tool steel



### 71989 7 Pc. Security Hex Metric Sockets

3/8" Square Drive Replaceable Bit Socket.

Item No. 

<b>71989</b>	lbs.	<b>Set includes the following:</b>
.74		2.0, 2.5, 3.0, 4.0, 5.0,
		6.0, 8.0mm



Item No.	Page	Item No.	Page	Item No.	Page	Item No.	Page	Item No.	Page	Item No.	Page
13650	22	26415	28	27509	26	28503	24	31890	22	33452	10
13651	22	26416	29	27510	26	28504	24	32302	21	33453	11
13652	22	26419	29	27513	26	28505	24	32303	21	33454	10
13653	22	26420	28	27515	26	28506	24	32304	21	33456	11
13654	22	26423	29	27520	26	28507	24	32305	21	33458	10
13655	22	26425	28	27525	26	28508	24	32306	21	33459	11
13656	22	26427	29	27530	26	28509	24	32308	21	33462	11
13657	22	26430	28	27535	26	28511	24	32366	21	33465	11
13658	22	26431	29	27537	26	28513	24	33401	11	33468	11
13659	22	26436	29	27539	26	28515	24	33402	11	33471	11
13662	22	26439	29	27541	26	28517	24	33403	11	33474	11
13663	22	26440	28	27543	26	28518	24	33404	11	33477	11
13664	22	26441	27	27545	26	28519	24	33405	11	33478	21
13665	22	26443	27	27547	26	28521	24	33406	11	33480	11
13666	22	26445	27	27549	26	28523	24	33407	11	33481	21
13667	22	26447	27	27590	26	28525	24	33408	11	33482	21
13668	22	26449	27	27591	26	28545	24	33409	11	33483	21
13669	22	26455	27	28000	30	28546	24	33410	11	33484	11
13670	22	26457	27	28001	30	28547	24	33411	11	33485	21
13671	22	26459	27	28003	27	28548	24	33412	11	33486	21
13672	22	26461	27	28004	27	28549	24	33413	11	33487	21
13673	22	26463	27	28005	27	28550	24	33414	11	33488	11
13690	22	26465	27	28006	27	28551	24	33415	11	33489	10
13691	22	26467	27	28007	27	28552	24	33416	11	33490	21
13693	22	26490	29	28008	27	28553	24	33417	11	33492	11
13694	22	26491	28	28021	30	28554	24	33418	10	33493	11
26307	28	26493	27	28023	30	28555	24	33419	11	33494	10
26309	28	26499	29	28024	30	28556	24	33420	10	33496	10
26313	28	26900	30	28025	30	28557	24	33421	11	33498	10
26315	28	26901	30	28026	30	28558	24	33422	10	33499	10
26316	28	26913	30	28027	30	28559	24	33423	11	35104	19
26320	28	26914	30	28028	30	28560	24	33424	10	35108	19
26323	28	26915	30	28029	30	28587	24	33425	11	35112	19
26325	28	26916	30	28033	30	28588	24	33426	10	35116	19
26327	28	26917	30	28034	30	28916	25	33427	11	35120	19
26330	28	26918	30	28035	30	28917	25	33428	10	35124	19
26331	28	26919	30	28036	30	28918	25	33429	11	35128	19
26333	28	26920	30	28037	30	28919	25	33430	10	35132	19
26336	28	26921	30	28116	23	28920	25	33432	10	35136	19
26340	28	26923	30	28117	23	28921	25	33433	10	35140	19
26341	27	26924	30	28118	23	28922	25	33434	11	35143	19
26343	27	26925	30	28119	23	28923	25	33435	11	35144	19
26345	27	26926	30	28120	23	28924	25	33436	11	35145	19
26347	27	26927	30	28122	23	28931	25	33437	11	35146	19
26349	27	26928	30	28123	23	28933	25	33438	11	35147	19
26351	27	26929	30	28124	23	28935	25	33439	10	35150	19
26353	27	26932	30	28149	23	28937	25	33440	10	35152	19
26363	27	26933	30	28150	23	28938	25	33441	21	35153	19
26367	27	26934	30	28151	23	28939	25	33442	10	35155	19
26369	27	26935	30	28192	23	28940	25	33443	21	35156	19
26371	27	26936	30	28298	32	31805	22	33444	10	35159	19
26390	28	26937	30	28299	32	31807	22	33445	21	35162	19
26391	28	26961	27	28486	23	31809	22	33446	10	35165	19
26392	27	26989	30	28487	23	31811	22	33447	21	35168	19
26393	27	26999	30	28488	23	31813	22	33448	10	35171	19
26399	28	27505	26	28501	24	31815	22	33449	21	35174	19
26413	28	27507	26	28502	24	31817	22	33450	10	35175	19



Item No.	Page	Item No.	Page	Item No.	Page	Item No.	Page	Item No.	Page	Item No.	Page
35176	19	35247	18	35341	20	36941	5	46740	15	66930	5
35177	19	35248	18	35342	20	36942	5	46750	15	66936	4
35178	19	35249	18	35343	20	36943	5	46760	15	66937	5
35179	19	35250	18	35345	20	36944	7	46780	15	66938	5
35180	19	35251	17	35346	20	36945	7	46786	15	66944	4
35191	19	35252	17	35347	20	36946	7	46793	14	66945	4
35192	19	35253	17	35348	20	36947	7	46794	14	66946	4
35193	19	35254	17	35390	20	36948	5	46796	15	66947	4
35194	19	35255	17	35391	20	36949	5	46797	14	66950	4
35195	16	35256	17	35392	20	36950	7	46799	15	66952	4
35196	16	35257	17	35393	20	36951	5	54001	9	66953	4
35197	16	35258	17	36696	6	36952	7	54002	9	66954	4
35198	16	35259	17	36710	12	36953	7	54003	9	66956	4
35200	18	35260	18	36713	12	36954	5	54004	9	66959	4
35201	17	35261	17	36715	13	36955	7	54005	9	66962	4
35202	17	35270	18	36716	12	36956	7	54006	9	66965	4
35203	18	35280	18	36719	12	36957	5	54007	9	66968	4
35204	17	35282	18	36720	13	36958	5	54008	9	66971	4
35205	18	35284	18	36723	12	36959	7	54009	9	66982	6
35206	17	35285	18	36725	13	36960	5	54010	9	66988	6
35208	17	35286	18	36726	12	36961	5	54012	8	66990	4
35210	17	35288	18	36728	12	36962	7	54014	8	66991	4
35211	17	35290	18	36730	13	36963	5	54016	8	66992	4
35212	17	35291	18	36732	12	36965	7	54018	8	66993	5
35213	18	35295	17	36734	12	36968	7	54020	9	66994	5
35214	17	35297	17	36736	12	36971	7	54022	8	66995	5
35215	18	35301	20	36738	12	36988	6	54024	8	66996	6
35216	18	35302	20	36740	13	36989	20	54025	9	66997	16
35217	17	35303	20	36742	12	36990	7	54030	9	66998	5
35218	18	35304	20	36744	12	36991	7	54040	8	70170	36
35219	17	35305	20	36750	13	36992	7	54042	9	70171	36
35220	18	35306	20	36760	13	36993	7	54050	8	70172	36
35221	17	35307	20	36780	13	36995	6	54052	9	70173	36
35222	18	35308	20	36786	13	36996	16	54060	8	70174	36
35223	17	35309	20	36790	13	36997	16	54062	9	70175	36
35224	18	35310	20	36791	12	36998	5	54080	8	70176	36
35225	18	35311	20	36792	13	38014	34	54082	9	71300	39
35226	18	35312	20	36793	12	38056	32	54086	8	71301	39
35227	17	35313	20	36794	12	38057	32	54088	9	71302	39
35228	18	35314	20	36904	7	38058	32	54090	8	71303	35
35230	18	35316	20	36908	7	46702	14	54091	8	71304	33
35231	17	35317	20	36911	6	46704	14	54092	9	71305	39
35232	18	35318	20	36912	7	46706	14	54094	9	71306	35
35233	17	35319	20	36913	6	46708	14	54095	9	71307	33
35234	18	35320	20	36914	6	46710	14	54097	9	71308	35
35235	17	35321	20	36915	6	46712	14	62994	29	71309	35
35236	18	35330	20	36916	7	46714	14	62995	29	71310	33
35237	17	35331	20	36917	6	46715	15	66904	4,5	71311	33
35238	18	35332	20	36918	6	46716	14	66908	4,5	71312	35
35239	17	35333	20	36919	6	46718	14	66912	4,5	71313	39
35240	18	35334	20	36920	7	46720	15	66916	4	71314	39
35241	17	35335	20	36921	6	46722	14	66918	5	71315	35
35242	18	35336	20	36922	6	46724	14	66920	4	71316	39
35243	17	35337	20	36924	7	46725	15	66922	5	71317	39
35244	18	35338	20	36928	7	46726	14	66924	4	71318	35
35245	18	35339	20	36936	7	46728	14	66926	5	71319	39
35246	18	35340	20	36940	5	46730	15	66928	4	71320	39

Item No.	Page	Item No.	Page	Item No.	Page	Item No.	Page	Item No.	Page	Item No.	Page
71321	35	71387	35	71936	36	74317	36	75330	31	76574	37
71322	39	71388	39	71938	36	74318	36	75332	31	76575	37
71323	39	71390	39	71939	36	74319	33	75340	31	76823	37
71324	35	71391	40	71940	36	74325	36	75342	31	76824	37
71325	39	71392	40	71941	36	74330	36	75350	31	76825	37
71326	35	71393	40	71942	36	74340	36	75352	31	76826	37
71327	39	71394	40	71943	36	74341	36	75354	31	76830	37
71328	35	71396	35	71944	36	74342	36	75356	31	76831	37
71329	35	71397	35	71945	36	74343	36	75358	31	76832	37
71330	35	71398	40	71946	36	74344	36	75360	31	76833	37
71331	39	71399	33	71955	36	74345	36	75362	31	76834	37
71332	39	71480	38	71956	36	74346	36	75364	31	76835	37
71333	35	71490	38	71960	36	74347	36	75366	31	76863	37
71336	35	71491	38	71970	36	74348	36	75368	31	76864	37
71339	35	71701	37	71971	36	74349	36	75370	31	76865	37
71340	39	71702	37	71972	36	74350	36	75372	31	76866	37
71341	39	71703	37	71973	36	74351	36	75395	31	76870	37
71342	35	71704	37	71974	36	74352	36	75800	31	76871	37
71343	33	71705	37	71975	36	74353	36	75801	31	76872	37
71345	35	71706	37	71976	36	74354	36	75900	31	76873	37
71346	33	71707	37	71977	36	74355	36	75901	31	76874	37
71348	35	71708	37	71978	36	74356	36	75983	31	76875	37
71349	33	71711	37	71979	36	74357	36	76132	39	76893	37
71351	35	71712	37	71980	36	74360	36	76133	39	76894	37
71352	33	71713	37	71981	36	74361	36	76134	39	77128	38
71353	35	71714	37	71982	36	74362	36	76135	39	77130	38
71354	33	71715	37	71983	36	74363	36	76136	39	77132	38
71356	35	71716	37	71984	36	74364	36	76137	39	77134	38
71358	33	71717	37	71985	36	74365	36	76138	39	77136	38
71359	35	71718	37	71989	40	74366	36	76164	39	77138	38
71360	35	71719	37	71995	34	74369	33	76165	39	77139	38
71361	35	71720	37	71996	40	74371	33	76166	39	77140	38
71362	35	71721	37	71998	34	74373	33	76167	39	77141	38
71363	35	71722	37	71999	40	74375	33	76168	39	77142	38
71364	35	71723	37	72001	38	74377	33	76169	39	77144	38
71365	35	71724	37	72002	38	74379	33	76170	39	77146	38
71366	35	71725	37	72003	38	74380	36	76171	39	77148	38
71367	35	71761	39	72090	38	74381	36	76172	39	77165	38
71368	35	71762	39	72388	36	74382	36	76523	37	77167	38
71369	35	71763	39	73301	35	74383	36	76524	37	77169	38
71370	38	71764	39	73302	35	74384	36	76525	37	77171	38
71371	38	71765	39	73303	35	74385	36	76526	37	77173	38
71372	38	71766	39	73304	35	74386	36	76530	37	77175	38
71373	35	71767	39	73305	35	74387	36	76531	37	77177	38
71374	38	71768	39	73306	35	74388	36	76532	37	77179	38
71375	39	71771	39	73307	35	74986	34	76533	37	77191	38
71376	38	71772	39	73308	35	74989	34	76534	37	77192	38
71377	39	71773	39	73309	35	74999	34	76535	37	77198	38
71378	38	71774	39	74301	33	75096	31	76563	37	79246	33
71379	39	71775	39	74305	33	75307	31	76563	37	79256	33
71380	38	71776	39	74307	33	75309	31	76564	37	79266	33
71381	39	71777	39	74311	36	75313	31	76565	37	79276	33
71382	38	71797	40	74312	36	75315	31	76566	37	79446	34
71383	39	71798	40	74313	36	75320	31	76570	37	91118	26
71384	38	71930	36	74314	36	75322	31	76571	37	91247	37
71385	39	71932	36	74315	36	75325	31	76572	37	91256	37
71386	38	71934	36	74316	36	75327	31	76573	37		