



Wiremold

500[®] & 700[®] Series Steel Raceway

One-Piece Steel Surface Raceway



Wiremold[®] 500[®] and 700[®] Series Raceway is ideal for surface mounting small amounts of electrical wiring or communication cables. These rugged raceways offer a low profile appearance which blend with any decor. 500[®] and 700[®] Series Raceway all come with our exclusive ScuffCoat[™] finish for increased durability and scratch-resistance.



500 and 700 Series Raceway profiles.

500 Series Raceway and components used in a ceiling fan installation.

FEATURES & BENEFITS

- **Low-profile, unobtrusive appearance.** Blends with any decor or setting. Excellent for low-voltage wiring.
- **ScuffCoat finish.** Tough, durable, scratch-resistant finish which can be overpainted with latex paint.
- **Surface mounting.** Eliminates disturbing the building structure or wall finish to make renovations easy.
- **V5748-3 Device Box accommodates wireless.** Designed for use with Ortronics[®] Wi-Jack[™] Wireless Access Points.
- **Full line of fittings.** Provides unlimited wiring solutions and interconnection between raceway systems.
- **More choice of colors.** 700 Series Raceway and Fittings are available in ivory and white.
- **Fittings have removable covers.** Allows easy access to wiring for changes and additions.
- **Raceway cutters with replaceable blades.** Cuts raceway cleanly, reduces labor, and installation time.
- **Datacom connectivity options.** Accepts industry standard and proprietary devices from a wide range of manufacturers to provide a seamless and aesthetically pleasing interface for voice, data, audio, and video applications at the point of use.
- **UL5 and ADA compliant.** Raceway and fittings meet UL5 specifications and can be installed in conformance with ADA requirements.
- **UL and cUL Listed component raceways.** File E4376 Guide RJBT, Fittings: File E41751 Guide RJPR. Meets Article 386 of NEC and meets Section 12-600 of CEC.



Typical applications for 500 & 700 Series Raceway.

500 & 700 Series System Product Applications

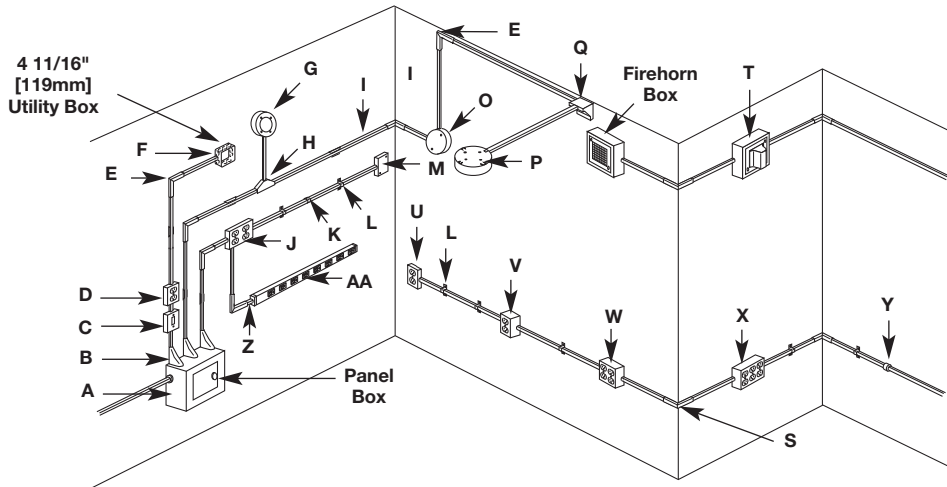

- | | | |
|---------------------------------------|----------------------------------|--|
| A — 5781A 3/4" [19.1mm] Box Connector | J — 5747-2 Shallow Device Box | S — V718 External Elbow |
| B — V5786 Adjustable Offset Connector | K — V706 Cover Clip | T — R5753 Extra Deep Alarm Device Box |
| C — V57240 Single Pole Switch and Box | L — V704 Mounting Strap | U — V5747S Shallow Device Box |
| D — V57243G Duplex Receptacle and Box | M — V57242 Utility Box | V — V5744 Extra Deep Device Box |
| E — V711 Flat Elbow | N — V717 Internal Elbow | W — V5748-2 Device Box |
| F — V5785 Combination Connector | O — V5734A Utility Box | X — V5748-3 Device Box |
| G — V5738 Fixture Box Solid Base | P — V5739 Fixture Box Solid Base | Y — 5782 1/2" [12.7mm] Conduit Connector |
| H — V5715 Tee Fitting | Q — V5719 Corner Box | Z — V2089E Reducing Fitting |
| I — V5703 Supporting Clip | R — R5752 Alarm Device Box | AA — Plugmold Multioutlet System |

V500 & V700 Series Wire Fill Capacity Charts

V500/V700 Series Raceway Wire Fill Capacities for Power

WIRE SIZE THHN/THWN	O.D.		NUMBER OF CONDUCTORS 40% FILL	
	inches	[mm]	V500 SERIES	V700 SERIES
14 AWG	0.111	[2.8]	7	10
12 AWG	0.130	[3.3]	5	7
10 AWG	0.164	[4.2]	3	4



V500/V700 Series Raceway Wire Fill Capacities for Communications

	CABLE/WIRE SIZE	O.D.		V500 SERIES		V700 SERIES	
		inches	[mm]	20% FILL*	40% FILL**	20% FILL*	40% FILL**
UNSHIELDED TWISTED PAIR	4-pair, 24 AWG, Cat 3	0.190	[4.8]	1	2	1	3
	4-pair, 24 AWG, Cat 5e	0.210	[5.3]	1	2	1	3
	4-pair, 24 AWG, Cat 6	0.250	[6.3]	0	1	1	2
TELEPHONE	2-pair, 24 AWG	0.140	[3.6]	2	4	3	6
	3-pair, 24 AWG	0.150	[3.8]	2	4	2	5
	4-pair, 24 AWG	0.190	[4.8]	1	2	1	3
	25-pair, 24 AWG	0.410	[10.4]	0	0	0	0
COAXIAL	RG58/U	0.195	[5.0]	1	2	1	3
	RG59/U	0.242	[6.1]	0	1	1	2
	RG62/U	0.242	[6.1]	0	1	1	2
	RG6/U	0.270	[6.9]	0	1	0	1
TWINAXIAL	100 Ohm	0.330	[8.4]	0	0	0	1
SHIELDED TWISTED PAIR	TYPE 1	0.390	[9.9]	0	0	0	0
	TYPE 2	0.465	[11.8]	0	0	0	0
	TYPE 3	0.245	[6.2]	0	1	0	1
FIBER	Mini ZipCord	0.079 x 0.157	[2 x 4]	3	6	4	8
	ZipCord	0.118 x 0.236	[3 x 6]	1	2	1	3
	Round 4 Strand Fiber	0.187	[4.8]	1	2	1	3
	Round 6 Strand Fiber	0.256	[6.5]	0	1	1	2

* 20% cable fill is calculated to approximate reduction in cable capacity due to connectors mounted within raceway and fittings that may restrict cross sectional area.

** 40% cable fill is the maximum designed cable fill based on a proposed revision to TIA/EIA 569-A.

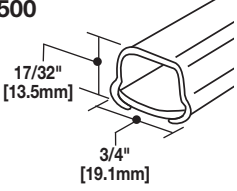
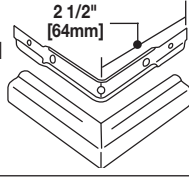
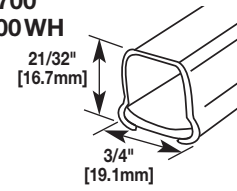
500 & 700 Series Raceway & Fittings Ordering Information

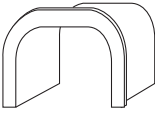
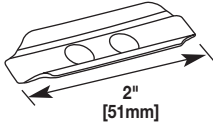
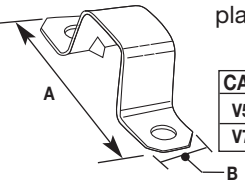
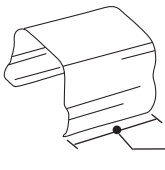
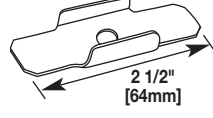
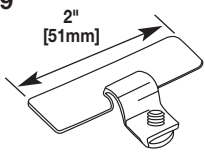
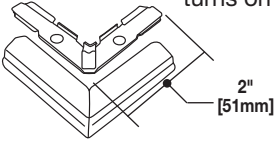
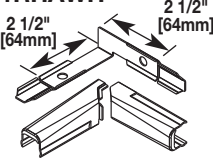
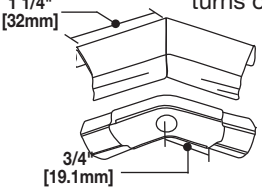
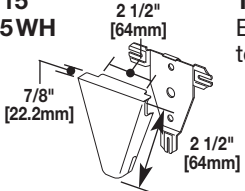
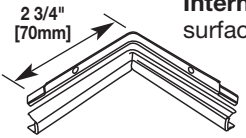
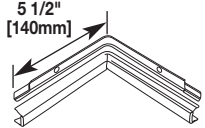
Catalog No./Item	Description/Specifications	Catalog No./Item	Description/Specifications									
V500 	Raceway – .040" [1.0mm] steel. Comes in 10 ft. [3.05mm] lengths, one 5701 Coupling furnished with each length. Five ft. [1.525m] lengths available, order V500-5.	V518 V718 718WH 	External Elbow – For outside surfaces at right angles.									
V700 700WH 	Raceway – .040" [1.0mm] steel. Comes in 10 ft. [3.05mm] lengths, one 5701 Coupling furnished with each length. Five ft. [1.525m] lengths available, order V700-5.	V5700F 	Flexible Section – For getting around difficult angles. End fittings and bulk conduit lengths available. Maximum painted length 3' [915mm] longer lengths furnished unpainted, consult factory for availability.									
502 702 	Bushing – Protects wires from abrasion. Bushing slips into open end of raceway where it enters a fitting.	5701 	Coupling – For joining and supporting lengths of V500 or 700 Series raceway. One coupling supplied with each length.									
V504 V704 704WH 	Mounting Strap (1- or 2-Hole) – Convert to one-hole by breaking off at score. Lanced tab holds strap in place while fastening to surface.	<table border="1" style="margin-left: auto; margin-right: auto;"> <thead> <tr> <th>CAT. #</th> <th>A</th> <th>B</th> </tr> </thead> <tbody> <tr> <td>V504</td> <td>1 7/8" [47mm]</td> <td>1/2" [12.7mm]</td> </tr> <tr> <td>V704</td> <td>1 7/8" [47mm]</td> <td>5/8" [15.4mm]</td> </tr> </tbody> </table>	CAT. #	A	B	V504	1 7/8" [47mm]	1/2" [12.7mm]	V704	1 7/8" [47mm]	5/8" [15.4mm]	
CAT. #	A	B										
V504	1 7/8" [47mm]	1/2" [12.7mm]										
V704	1 7/8" [47mm]	5/8" [15.4mm]										
V506 V706 706WH 	Connection Cover – To cover openings where lengths of V500 or 700 Series, not squarely cut, come together.	V5703 	Supporting Clip – For supporting lengths of V500 or 700 Series raceway at any point desired.									
V509 			Ground Clamp – Provides additional grounding or to ground remotely located devices. Attach ground wire to screw as required by NEC. Insert into V500 or 700 Series raceway before installing.									
V511 V711 711WH 	90° Flat Elbow – For right angle turns on same surface.	V5711LH A V5711RHA 5711LHAWH 5711RHAWH 	Internal Twisted Elbows – For 90° twist with 90° turn including a flat run on sidewall to a flat run on ceiling or on door edge or window trim. Break out crescent twistout in cover to use with 700 Series.									
V512 V712 	45° Flat Elbow – For diagonal 45° turns on same surface.	V5715 5715WH 	Tee – For branches at right angles. Break out crescent twistout in cover to use with V700.									
V517 V717 717WH 	Internal Elbow – For inside surfaces at right angles.	V5717A 	Internal Pull Elbow – For inside surfaces at right angles. Provides more space to simplify wire pulling. Break out crescent twistout in corner to use with V700.									

NOTE: Use #6 flat head screws with all fittings requiring screws except V504/V704, and V57200 Series; with V504/V704 use #8 pan head screws; with V57200 Series use #8 flat head screws.

500 & 700 Series Raceway Fittings Ordering Information

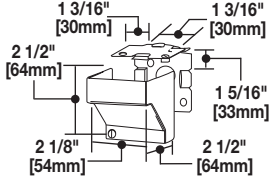
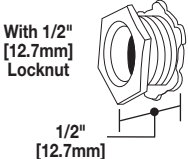
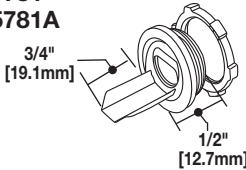
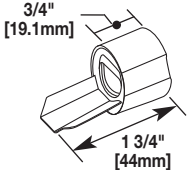
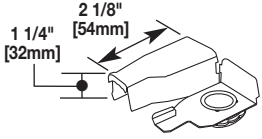
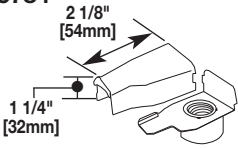
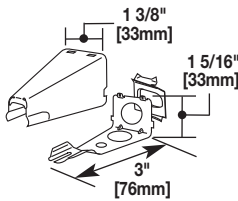
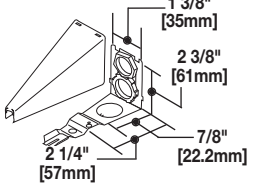
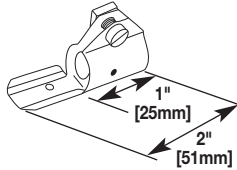
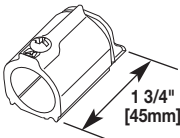
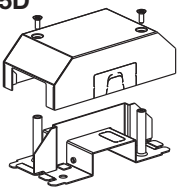
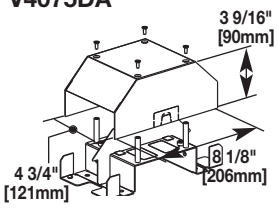
Catalog No./Item	Description/Specifications
V5719 	Corner Box – Allows ample splice room. Each leg of base has 1/2" trade size KO.
5780 	Special Nipple (Galvanized) – Has female 3/8" [9.5mm] pipe thread inside and male 1/2" [12.7mm] pipe thread outside. For hanging 3/8" [9.5mm] or 1/2" [12.7mm] fixtures to Wiremold fittings with 1/2" trade size KOs.
5781 5781A 	Box Connector (Galvanized) – For connecting raceway to conduit boxes, panel boxes, etc., having a KO for conduit. May also be used with conduit type fittings. Break out crescent twistout to use with V700. 1/2" [12.7mm] Male (5781) 3/4" [19.1mm] Male (5781A)
5782A 	Conduit Connector (Galvanized) – For connecting raceway to conduit. Break out crescent twistout to use with V700. 1/2" [12.7mm] Male (5782) 3/4" [19.1mm] Male (5782A)
V5783 	Elbow Box Connector – For connecting raceway at right angles to conduit boxes, panel boxes, etc., having a KO for 1/2" [12.7mm] conduit. Break out crescent twistout in cover to use with V700. 1/2" [12.7mm] Male
V5784 	Elbow Conduit Connector – For connecting raceway at right angles to 1/2" [12.7mm] conduit or armored cable connectors. Break out crescent twistout in cover to use with V700. 1/2" [12.7mm] Female
V5785 5785WH 	Combination Connector – For connecting raceway, without offsetting, to any 3 1/4" [83mm] or 4" [102mm] outlet box mounted on the surface with a KO for 1/2" [12.7mm] conduit. The base end and bottom has two 1/2" trade size KOs. Break off cover extension to use with 700 Series. Spring steel bushing included for end connection to box, eliminating conduit nipple and locknut.
V5786 V5786WH 	Adjustable Offset Connector – Eliminates offsetting raceway when connecting to surface type panel boxes. The adjustment from surface to center of bushings is 5/8" [15.9mm] minimum to 1 3/8" [35mm] maximum. Break out crescent twistout in cover to use with 700 Series. 1/2" [12.7mm] chase nipple and locknut furnished.
5790B 	Armored Cable Connector (Galvanized) – For connecting 14/2, 14/3, 12/2, and 12/3 armored cable to Wiremold fittings. Use a short piece of V500/V700 raceway (1 5/8" [41mm] min.) between this connector and fitting. Not for connection to 1/2" [12.7mm] Flex Conduit.
5791 	5700 Series Box EMT Connector – Joins 1/2" [12.7mm] EMT directly into any V5700 Series Wiremold box.
V2475D 	2400 Series Raceway Bridge Fitting – For allowing 2400 Series Raceway to bridge over existing installations of V500/V700 Series Raceway
V4075DA 	4000 Series Raceway Bridge Fitting – For allowing 4000 Series Raceway to bridge over existing installations of V500/V700 Series Raceway.

NOTE: Use #6 flat head screws with all fittings requiring screws except V504/V704, and V57200 Series; with V504/V704 use #8 pan head screws; with V57200 Series use #8 flat head screws.

500 & 700 Series Raceway Device Boxes Ordering Information

Catalog No./Item	Description/Specifications	Catalog No./Item	Description/Specifications																												
V57240	15A, 125V Single Pole Switch and Box – Accommodates other standard single-gang switches in place of furnished standard single pole switch. Cover has twistouts for V500 or V700 on each end. Twistout on ends permits running raceway close to interior trim. Base has 1/2" trade size KO's.	V5744S 5744SWH	Deep Switch and Receptacle Box – For installing signal system alarm wiring and communication devices. Base has 1/2" trade size and rectangular single-gang KO's. <table border="1" style="margin-top: 10px; width: 100%; border-collapse: collapse;"> <thead> <tr> <th>CAT NO.</th> <th>L</th> <th>W</th> <th>GANG #</th> </tr> </thead> <tbody> <tr> <td>V5744, WH </td> <td>4 5/8" [118mm]</td> <td>2 7/8" [73mm]</td> <td>1</td> </tr> <tr> <td>V5744-2, WH </td> <td>4 3/4" [121mm]</td> <td>4 3/4" [121mm]</td> <td>2*</td> </tr> <tr> <td>V5744-3 </td> <td>4 5/8" [118mm]</td> <td>6 1/2" [165mm]</td> <td>3</td> </tr> </tbody> </table>	CAT NO.	L	W	GANG #	V5744, WH	4 5/8" [118mm]	2 7/8" [73mm]	1	V5744-2, WH	4 3/4" [121mm]	4 3/4" [121mm]	2*	V5744-3	4 5/8" [118mm]	6 1/2" [165mm]	3												
CAT NO.	L	W	GANG #																												
V5744, WH	4 5/8" [118mm]	2 7/8" [73mm]	1																												
V5744-2, WH	4 3/4" [121mm]	4 3/4" [121mm]	2*																												
V5744-3	4 5/8" [118mm]	6 1/2" [165mm]	3																												
V57242	Utility Box – For use as tee, cross, pull box, junction box, blank box, etc. Cover has 1/2" trade size KO and twistouts for V500 and V700 on each end and side. End twistouts permit running raceway close to interior trim. Base has 1/2" trade size KO's.	V5745 5745WH	Combination Device Box – For connecting surface runs of 1/2" [12.7mm] conduit, etc. Cover has two raceway twistouts on one end and three on opposite end; also two 1/2" trade size KO's and a raceway twistout on each side. Base has two 1/2" trade size KO's.																												
V57243G	15A, 125V Duplex Grounding Receptacle (Nema 5-15R) and Box – Accommodates other standard 15A (NEMA 5-15R) or 20A (NEMA 5-20R) duplex devices in place of furnished duplex grounding receptacle. Cover has twistouts for V500 and V700 on each end and side. End twistouts permit running raceway close to interior trim. Base has 1/2" trade size KO's.	V5747 5747WH	Shallow Device Box – For standard shallow switches, receptacles, communication devices, and single-gang combination devices. Base has two 1/2" trade size KO's. <table border="1" style="margin-top: 10px; width: 100%; border-collapse: collapse;"> <thead> <tr> <th>CAT NO.</th> <th>L</th> <th>W</th> <th>GANG #</th> </tr> </thead> <tbody> <tr> <td>V5747, WH </td> <td>4 5/8" [118mm]</td> <td>2 7/8" [73mm]</td> <td>1</td> </tr> <tr> <td>V5747-2, WH </td> <td>4 3/4" [121mm]</td> <td>4 3/4" [121mm]</td> <td>2*</td> </tr> <tr> <td>V5747-3 </td> <td>4 5/8" [118mm]</td> <td>6 1/2" [165mm]</td> <td>3</td> </tr> </tbody> </table>	CAT NO.	L	W	GANG #	V5747, WH	4 5/8" [118mm]	2 7/8" [73mm]	1	V5747-2, WH	4 3/4" [121mm]	4 3/4" [121mm]	2*	V5747-3	4 5/8" [118mm]	6 1/2" [165mm]	3												
CAT NO.	L	W	GANG #																												
V5747, WH	4 5/8" [118mm]	2 7/8" [73mm]	1																												
V5747-2, WH	4 3/4" [121mm]	4 3/4" [121mm]	2*																												
V5747-3	4 5/8" [118mm]	6 1/2" [165mm]	3																												
V5741 5741WH	Device Box – For shallow type switches (three-way, single, and double pole) and receptacles, (three-wire locking receptacles and single-gang combination devices). Base has 1/2" trade size KO. End twistout permits running raceway close to interior trim.	V5748 5748WH	Device Box – For deep switches, receptacles and communication devices. Base has two 1/2" trade size KO's. <table border="1" style="margin-top: 10px; width: 100%; border-collapse: collapse;"> <thead> <tr> <th>CAT NO.</th> <th>L</th> <th>W</th> <th>GANG #</th> </tr> </thead> <tbody> <tr> <td>V5748, WH </td> <td>4 5/8" [118mm]</td> <td>2 7/8" [73mm]</td> <td>1</td> </tr> <tr> <td>V5748-2, WH </td> <td>4 3/4" [121mm]</td> <td>4 3/4" [121mm]</td> <td>2*</td> </tr> <tr> <td>V5748-3 </td> <td>4 5/8" [118mm]</td> <td>6 1/2" [165mm]</td> <td>3</td> </tr> <tr> <td>V5748-4 </td> <td>4 5/8" [118mm]</td> <td>8 11/32" [212mm]</td> <td>1</td> </tr> <tr> <td>V5748-5 </td> <td>4 3/4" [121mm]</td> <td>10 5/32" [212mm]</td> <td>2*</td> </tr> <tr> <td>V5748-6 </td> <td>4 5/8" [118mm]</td> <td>11 31/32" [165mm]</td> <td>3</td> </tr> </tbody> </table>	CAT NO.	L	W	GANG #	V5748, WH	4 5/8" [118mm]	2 7/8" [73mm]	1	V5748-2, WH	4 3/4" [121mm]	4 3/4" [121mm]	2*	V5748-3	4 5/8" [118mm]	6 1/2" [165mm]	3	V5748-4	4 5/8" [118mm]	8 11/32" [212mm]	1	V5748-5	4 3/4" [121mm]	10 5/32" [212mm]	2*	V5748-6	4 5/8" [118mm]	11 31/32" [165mm]	3
CAT NO.	L	W	GANG #																												
V5748, WH	4 5/8" [118mm]	2 7/8" [73mm]	1																												
V5748-2, WH	4 3/4" [121mm]	4 3/4" [121mm]	2*																												
V5748-3	4 5/8" [118mm]	6 1/2" [165mm]	3																												
V5748-4	4 5/8" [118mm]	8 11/32" [212mm]	1																												
V5748-5	4 3/4" [121mm]	10 5/32" [212mm]	2*																												
V5748-6	4 5/8" [118mm]	11 31/32" [165mm]	3																												
V5744 5744WH	Extra Deep Device Box – Designed for deep devices – momentary contact, and remote control switches, hospital signaling system devices, and deep communication devices. Base has 1/2" trade size KO's. <table border="1" style="margin-top: 10px; width: 100%; border-collapse: collapse;"> <thead> <tr> <th>CAT NO.</th> <th>L</th> <th>W</th> <th>GANG #</th> </tr> </thead> <tbody> <tr> <td>V5744, WH </td> <td>4 5/8" [118mm]</td> <td>2 7/8" [73mm]</td> <td>1</td> </tr> <tr> <td>V5744-2, WH </td> <td>4 3/4" [121mm]</td> <td>4 3/4" [121mm]</td> <td>2*</td> </tr> <tr> <td>V5744-3 </td> <td>4 5/8" [118mm]</td> <td>6 1/2" [165mm]</td> <td>3</td> </tr> </tbody> </table>	CAT NO.	L	W	GANG #	V5744, WH	4 5/8" [118mm]	2 7/8" [73mm]	1	V5744-2, WH	4 3/4" [121mm]	4 3/4" [121mm]	2*	V5744-3	4 5/8" [118mm]	6 1/2" [165mm]	3														
CAT NO.	L	W	GANG #																												
V5744, WH	4 5/8" [118mm]	2 7/8" [73mm]	1																												
V5744-2, WH	4 3/4" [121mm]	4 3/4" [121mm]	2*																												
V5744-3	4 5/8" [118mm]	6 1/2" [165mm]	3																												

NOTES: Covers on this page have double twistouts. Break out lower twistout for use with V500, and both twistouts for use with V700.

* V5744-2 and V5744S-2 Base and V5747-2 and V5748-2 Base have 1/2" and 1" concentric trade size KO's and a 1 13/16" x 2 7/8" [47mm x 73mm] rectangular KO to permit mounting on a one-gang in-wall outlet box.

Replace V with VC or WH with WHC to denote Canadian version — Agency approved for sale in Canada.

† Larger gangs available, consult factory.

500 & 700 Series Raceway Device Boxes Ordering Information (continued)

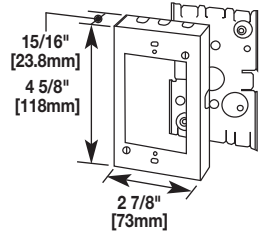
Catalog No./Item	Description/Specifications
V5748S 5748SWH 	Shallow Switch and Receptacle Box – For duplex receptacles (shallow type). Base has 1/2" trade size KOs.

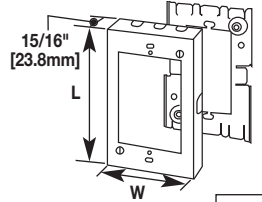
V5751 5751 WH 	Flush-Type Extension Adapter – For extensions from existing flush wall boxes. Larger gangs available, consult factory.																
<table border="1" style="margin: auto; border-collapse: collapse;"> <thead> <tr> <th>CAT NO.</th> <th>L</th> <th>W</th> <th>GANG #</th> </tr> </thead> <tbody> <tr> <td>V5751, WH</td> <td>4 5/8" [118mm]</td> <td>2 7/8" [73mm]</td> <td>1</td> </tr> <tr> <td>V5751-2, WH</td> <td>4 3/4" [121mm]</td> <td>4 3/4" [121mm]</td> <td>2*</td> </tr> <tr> <td>V5751-3</td> <td>4 5/8" [118mm]</td> <td>6 1/2" [165mm]</td> <td>3</td> </tr> </tbody> </table>		CAT NO.	L	W	GANG #	V5751, WH	4 5/8" [118mm]	2 7/8" [73mm]	1	V5751-2, WH	4 3/4" [121mm]	4 3/4" [121mm]	2*	V5751-3	4 5/8" [118mm]	6 1/2" [165mm]	3
CAT NO.	L	W	GANG #														
V5751, WH	4 5/8" [118mm]	2 7/8" [73mm]	1														
V5751-2, WH	4 3/4" [121mm]	4 3/4" [121mm]	2*														
V5751-3	4 5/8" [118mm]	6 1/2" [165mm]	3														

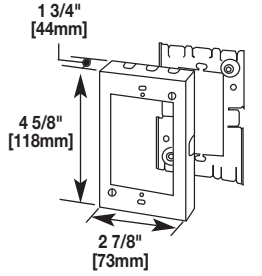
V5751A 5751AWH 	Deep Flush-Type Extension Adapter – For deep extensions from existing flush wall boxes.
--	--

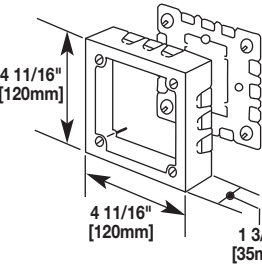
R5752 (Red) V5752 (Ivory) 	Two-Gang Alarm Device Box – For surface mounting alarm devices and safety signals designed to fit 4" [102mm] square back boxes. Cover has three raceway twistouts on each side. Base has 1/2" and 1" trade size concentric and single-gang box KOs.
---	--

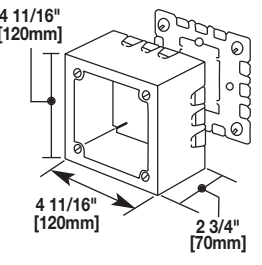
R5753 (Red) V5753 (Ivory) 	Two-Gang Extra Deep Alarm Device Box – For surface mounting alarm devices and safety signals designed to fit 4" [102mm] square back boxes. Cover is 2 3/4" [70mm] deep and has three raceway twistouts on each side. Base has 1/2" and 1" trade size concentric and single-gang box KOs.
---	---

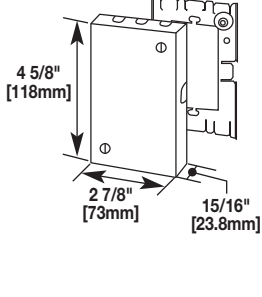
V5760 	Blank Extension Box – For extending from existing flush switch and receptacle boxes to blank original outlet. Closed base available, consult factory.
--	--

NOTES: Covers on this page have double twistouts. Break out lower twistout for use with V500, and both twistouts for use with V700.

* V5744-2 and V5744S-2 Base and V5747-2 and V5748-2 Base have 1/2" and 1" concentric trade size KOs and a 1 13/16" x 2 7/8" [47mm x 73mm] rectangular KO to permit mounting on a one-gang in-wall outlet box.

Replace V with VC or WH with WHC to denote Canadian version — Agency approved for sale in Canada.

† Larger gangs available, consult factory.

500 & 700 Series Raceway Round Fixture Boxes Ordering Information

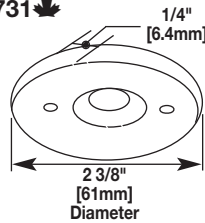
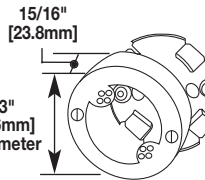
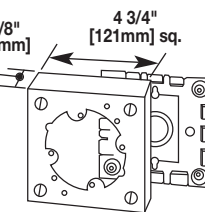
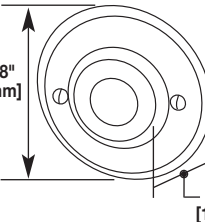
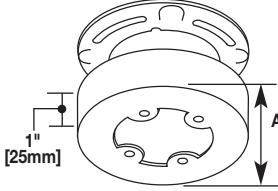
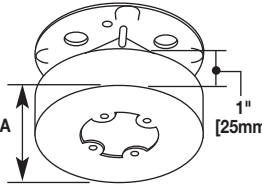
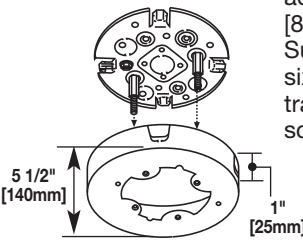
Catalog No./Item	Description/Specifications								
<p>V5731 </p>  <p style="text-align: center;">2 3/8" [61mm] Diameter</p>	<p>Blank Cover – Use with V5733 to convert into a pull or junction box. Has 1/2" trade size KO in center.</p>								
<p>V5733 </p>  <p style="text-align: center;">3" [76mm] Diameter</p>	<p>Outlet Box – Designed for devices with mounting screw centers of 1 15/32", 1 5/8", 1 22/32", or 1 27/32" [37mm, 41mm, 60mm, or 45mm]. Accepts any device that mounts on G or H type conduit fittings.</p>								
<p>V5735 </p>  <p style="text-align: center;">1 3/8" [121mm]</p> <p style="text-align: center;">4 3/4" [121mm] sq.</p>	<p>Distribution Box – Each side accepts three parallel raceway runs. Base has 1/2" and 1" concentric trade size KOs and a 1 13/16" x 2 7/8" trade size KO to mount on a one-gang in-wall outlet box. Cover takes devices with mounting screw centers of 2 3/4", 3 1/2", and 4 1/16" [70mm, 89mm, and 104mm], and canopy fixtures 4 5/8" [118mm] diameter or smaller. Used as a pull or junction box with V5736.</p>								
<p>V5736</p>  <p style="text-align: center;">4 3/8" [35mm]</p> <p style="text-align: center;">7/16" [11.1mm]</p>	<p>Blank Cover – Use with V5735, V5737, V5737A, V5738, V5738A, V5739, or V5739A, or V2135 converting them to pull or junction boxes and for hanging lightweight pendant fixtures having 1/2" [12.7mm] pipe stems, etc. Has 1/2" trade size KO.</p>								
<p>V5737 V5737A V5739A 5737 WH 5737 AWH </p>  <p style="text-align: center;">1" [25mm]</p> <p style="text-align: center;">A</p>	<p>Extension Box/Open Base – For mounting on 3 1/4" [83mm], 4" [102mm] conduit boxes, or other recessed outlets. Cover takes devices with mounting screw centers of 2 3/4", 3 1/2", or 4 1/16" [70mm, 89mm, or 104mm]. Use as a pull or junction box with V5736.</p> <table border="1" style="width: 100%; margin-top: 10px;"> <thead> <tr> <th>CAT. NO.</th> <th>DIA. A.</th> </tr> </thead> <tbody> <tr> <td>V5737, WH</td> <td>4 3/4" [121mm]</td> </tr> <tr> <td>V5737A, WH</td> <td>5 1/2" [140mm]</td> </tr> <tr> <td>V5739A</td> <td>6 3/8" [162mm]</td> </tr> </tbody> </table>	CAT. NO.	DIA. A.	V5737, WH	4 3/4" [121mm]	V5737A, WH	5 1/2" [140mm]	V5739A	6 3/8" [162mm]
CAT. NO.	DIA. A.								
V5737, WH	4 3/4" [121mm]								
V5737A, WH	5 1/2" [140mm]								
V5739A	6 3/8" [162mm]								
<p>V5738 V57378A V5739 5738 WH 5738 AWH </p>  <p style="text-align: center;">1" [25mm]</p> <p style="text-align: center;">A</p>	<p>Fixture Box/Solid Base – For hanging fixtures. Cover takes devices with mounting screw centers of 2 3/4", 3 1/2", or 4 1/16" [70mm, 89mm, or 104mm]. Base has four holes for fixture studs; five 1/2" trade size KOs and raised section for no-bolt fixture-stud. Use as a junction or pull box with V5736.</p> <table border="1" style="width: 100%; margin-top: 10px;"> <thead> <tr> <th>CAT. NO.</th> <th>DIA. A.</th> </tr> </thead> <tbody> <tr> <td>V5738, WH</td> <td>4 3/4" [121mm]</td> </tr> <tr> <td>V5738A, WH</td> <td>5 1/2" [140mm]</td> </tr> <tr> <td>V5739</td> <td>6 3/8" [162mm]</td> </tr> </tbody> </table>	CAT. NO.	DIA. A.	V5738, WH	4 3/4" [121mm]	V5738A, WH	5 1/2" [140mm]	V5739	6 3/8" [162mm]
CAT. NO.	DIA. A.								
V5738, WH	4 3/4" [121mm]								
V5738A, WH	5 1/2" [140mm]								
V5739	6 3/8" [162mm]								
<p>V5738AF 5738AFWH </p>  <p style="text-align: center;">5 1/2" [140mm]</p> <p style="text-align: center;">1" [25mm]</p>	<p>Fan Box/Solid Base – UL approved fixture box for ceiling fans. Cover accepts fan brackets with 3.2" [82mm] mounting centers. Supports up to 50 lbs. Base has six mounting holes and four 1/2" trade size KOs. #10 mounting screws provided.</p>								

NOTE: Covers have double twistouts; Lower twistout for V500, and both twistouts for V700.

Replace V with VC or WH with WHC to denote Canadian version — Agency approved for sale in Canada.

* These boxes are not designed to support ceiling fans. For fan applications, use V5738AF.

500 & 700 Series Raceway Tools Ordering Information

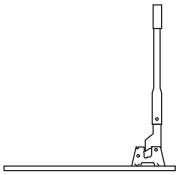
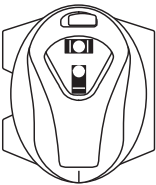
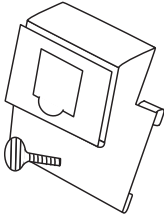
Catalog No./Item	Description/Specifications	Catalog No./Item	Description/Specifications
605 607	 <p>V500 Raceway Cutter 700 Series Raceway Cutter – Single action portable cutter.</p>	5700LL	 <p>Laser Level for 500/700 Series Raceway – Attaches to outlet box base and raceway fittings for perfect alignment of runs of raceway.</p>
605K 607K	<p>Replacement blade for 605 and 607 cutters – Replacement case-hardened steel blades cut clean and square.</p>	5700CG	 <p>Cutting Guide for 500/700 Series Raceway – Attaches to step ladder and holds raceway channel securely for accurate cuts.</p>



Wiremold

WIREMOLD

U.S. and International:

60 Woodlawn Street • West Hartford, CT 06110
1-800-621-0049 • FAX 860-232-2062 • Outside U.S. 860-233-6251

Canada:

570 Applewood Crescent • Vaughan, Ontario L4K 4B4
1-800-723-5175 • FAX 905-738-9721

ED532R14 - Updated October 2010 - For latest specs visit www.legrand.us/wiremold

