

# DATA SHEET

## SURFACE-MOUNT CERAMIC MULTILAYER CAPACITORS

High-Voltage

NP0/X7R

1 KV TO 3 KV

0.47 pF to 33 nF

RoHS compliant & Halogen Free



SCOPE

This specification describes High-Voltage NP0/X7R series chip capacitors with lead-free terminations.

APPLICATIONS

- PCs, Hard disk, Game PCs
- Power supplies
- LCD panel
- ADSL, Modem

FEATURES

- Supplied in tape on reel
- Nickel-barrier end termination
- RoHS compliant
- Halogen Free compliant

ORDERING INFORMATION-GLOBAL PART NUMBER, PHYCOMP

CTC & I2NC

All part numbers are identified by the series, size, tolerance, TC material, packing style, voltage, process code, termination and capacitance value.

**YAGEO BRAND ordering code**

**GLOBAL PART NUMBER (PREFERRED)**

**CC** xxxx x x xxx x **B** x xxx  
 (1) (2) (3) (4) (5) (6) (7)

---

**(1) SIZE – INCH BASED (METRIC)**

0805 (2012) / 1206 (3216) / 1210 (3225) / 1808 (4520) / 1812 (4532)

---

**(2) TOLERANCE**

C = ±0.25 pF  
 D = ±0.5 pF  
 G = ±2%  
 J = ±5%  
 K = ±10%

---

**(3) PACKING STYLE**

R = Paper/PE taping reel; Reel 7 inch  
 K = Blister taping reel; Reel 7 inch  
 P = Paper/PE taping reel; Reel 13 inch  
 F = Blister taping reel; Reel 13 inch  
 C = Bulk case

---

**(4) TC MATERIAL**

NPO  
 X7R

---

**(5) RATED VOLTAGE**

C = 1 KV  
 D = 2 KV  
 E = 3 KV

---

**(6) PROCESS**

N = NP0  
 B = Class 2 MLCC

---

**(7) CAPACITANCE VALUE**

2 significant digits+number of zeros  
 The 3rd digit signifies the multiplying factor, and letter R is decimal point  
 Example: 121 = 12 × 10<sup>1</sup> = 120 pF

---

**PHYCOMP BRAND ordering codes**

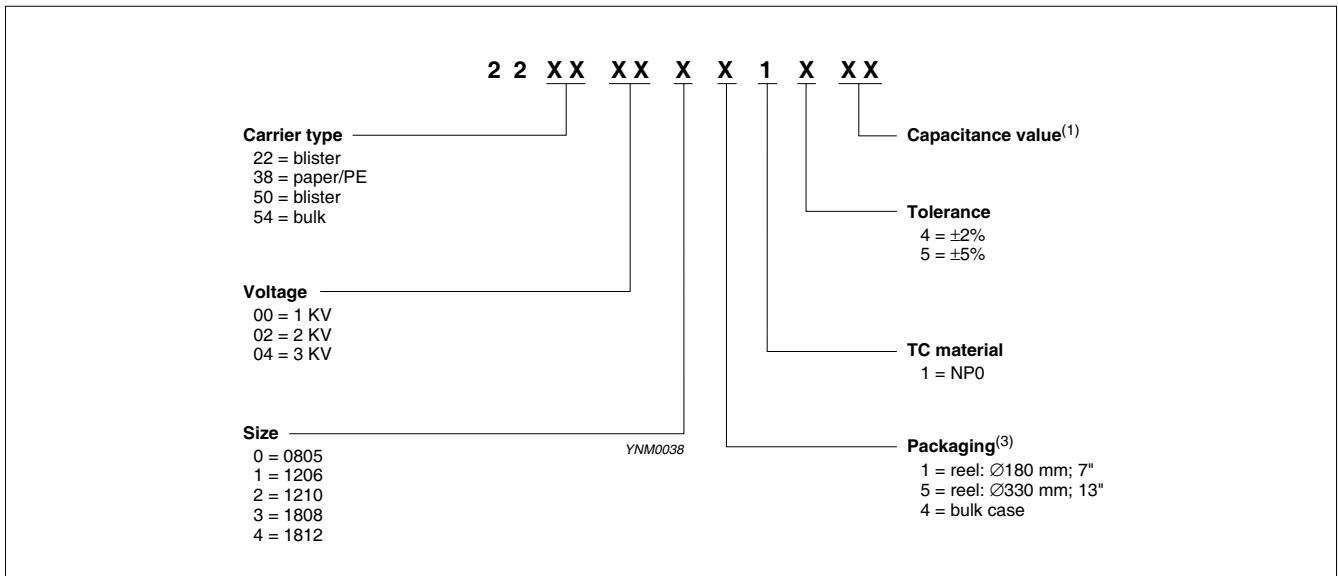
GLOBAL PART NUMBER (preferred), PHYCOMP CTC (for North America) and I2NC (traditional) codes are acceptable to order Phycomp brand products.

**GLOBAL PART NUMBER (PREFERRED)**

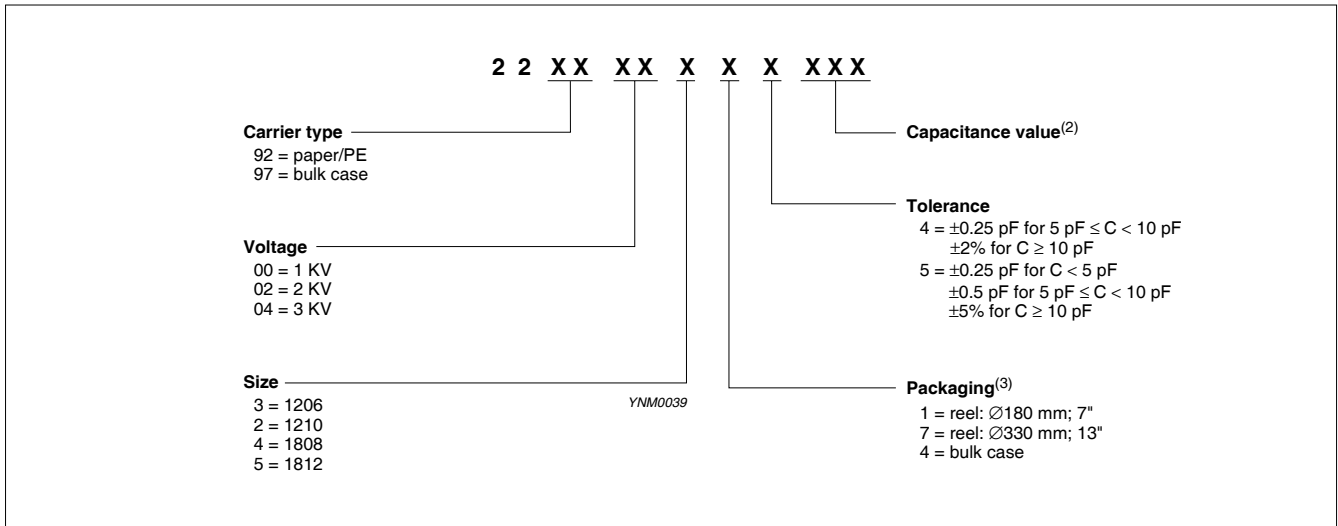
For detailed information of GLOBAL PART NUMBER and ordering example, please refer to page 2.

**I2NC CODE**

Ordering information for NP0 1 KV to 3 KV, C ≥ 10 pF

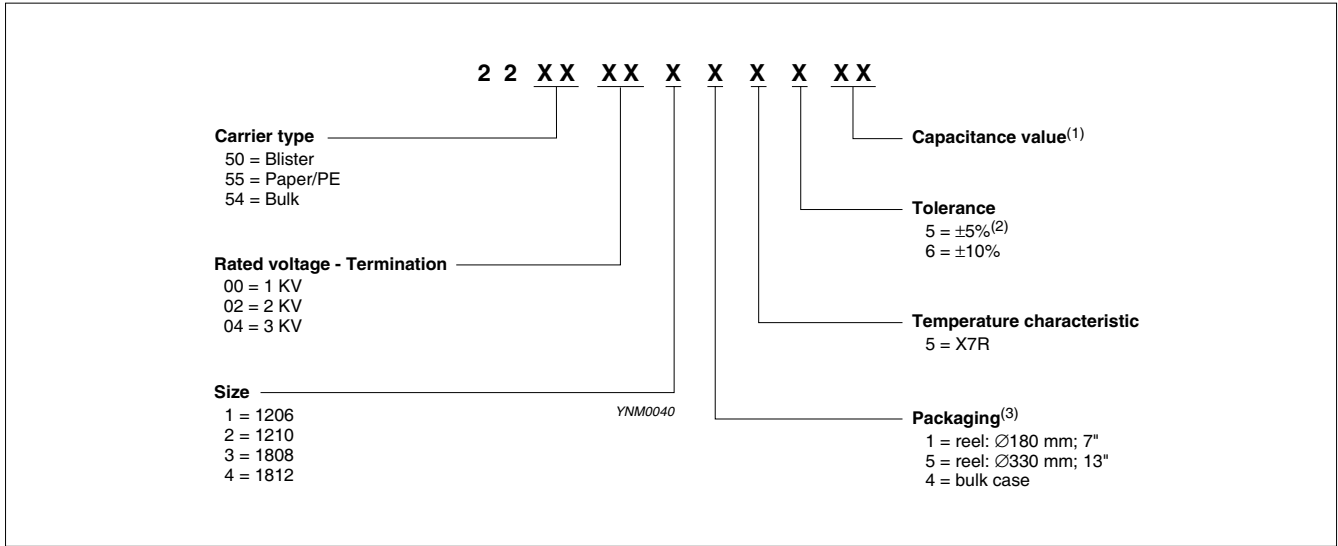


Ordering information for NP0 1 KV to 3 KV, C < 10 pF



(1) Please refer to "Last 2-digit of I2NC" in "CAPACITANCE RANGE & THICKNESS FOR NP0"  
 (2) Please refer to "Last 3-digit of I2NC" in "CAPACITANCE RANGE & THICKNESS FOR NP0"  
 (3) Quantity on reel depends on thickness classification; see table 5

Ordering information for X7R 1 KV to 3 KV



- (1) Please refer to "Last 2-digit of I2NC" in "CAPACITANCE RANGE & THICKNESS FOR X7R"
- (2) Tolerance ±5% is not available for full product range, please contact local sales force before ordering
- (3) Quantity on reel depends on thickness classification; see table 5

**PHYCOMP CTC CODE (FOR NORTH AMERICA)**

🔗 Example: I2I02R102KFBB00

1210	2R	102	K	F	B	B	0	0
Size code	Temp. Char.	Capacitance in pF	Tolerance	Voltage	Termination	Packing	Marking	Range identifier
0805	CG = NP0	101 = 100 pF;	C = ±0.25 pF	E = 1 KV	B = NiSn	2 = 180 mm	0 = no marking	0 = conv. Ceramic
1206	2R = X7R	the third digit signifies the multiplying factor:	D = ±0.5 pF	F = 2 KV		7" Paper/PE		D = Class 2 MLCC
1210		8 = × 0.01	G = ±2%	G = 3 KV		3 = 330 mm		
1808		9 = × 0.1	J = ±5%			13" Paper/PE		
1812		0 = × 1	K = ±10%			B = 180 mm		
		1 = × 10				7" Blister		
		2 = × 100				F = 330 mm		
		3 = × 1,000				13" Blister		
						P = Bulk case		

**CONSTRUCTION**

The capacitor consists of a rectangular block of ceramic dielectric in which a number of interleaved metal electrodes are contained. This structure gives rise to a high capacitance per unit volume.

The inner electrodes are connected to the two end terminations and finally covered with a layer of plated tin (NiSn). The terminations are lead-free. A cross section of the structure is shown in Fig.1.

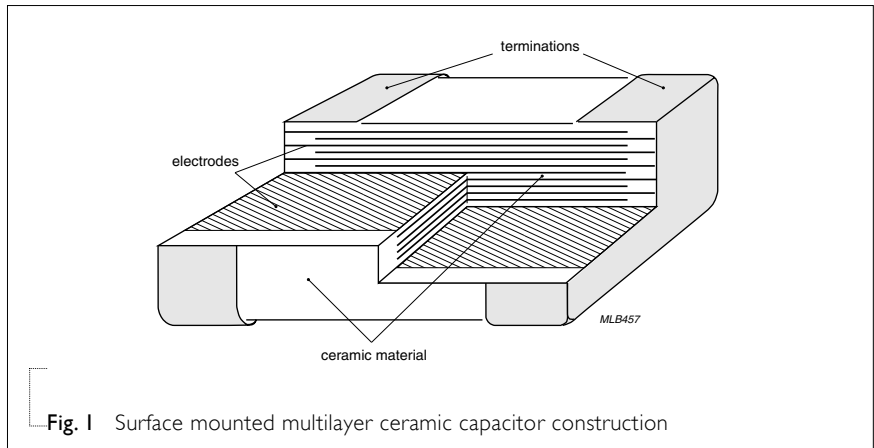


Fig. 1 Surface mounted multilayer ceramic capacitor construction

**DIMENSION**

Table I For outlines see fig. 2

TYPE	L <sub>1</sub> (mm)	W (mm)	T (MM)	L <sub>2</sub> / L <sub>3</sub> (mm)		L <sub>4</sub> (mm)
				min.	max.	min.
0805	2.0 ±0.20	1.25 ±0.20	Refer to table 2 to 4	0.25	0.75	0.55
1206	3.2 ±0.30	1.6 ±0.20		0.25	0.75	1.40
1210	3.2 ±0.30	2.5 ±0.20		0.25	0.75	1.40
1808	4.5 ±0.40	2.0 ±0.30		0.25	0.75	2.20
1812	4.5 ±0.40	3.2 ±0.20		0.25	0.75	2.20

**OUTLINES**

For dimension see Table I

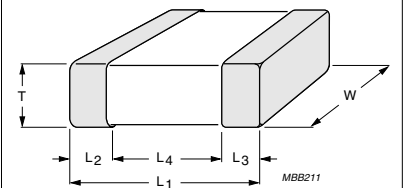


Fig. 2 Surface mounted multilayer ceramic capacitor dimension

**CAPACITANCE RANGE & THICKNESS FOR NP0**

**Table 2** Sizes from 1206 to 1808

CAP.	Last 3-digit of I2NC	1206		1210		1808		
		1 KV	2 KV	1 KV	2 KV	1 KV	2 KV	3 KV
0.47 pF	477							
0.56 pF	567							
0.68 pF	687							
0.82 pF	827							
1.0 pF	108							
1.2 pF	128							
1.5 pF	158							
1.8 pF	188							
2.2 pF	228	0.85±0.1	0.85±0.1	1.25±0.2	1.25±0.2	1.25±0.2	1.25±0.2	1.6±0.2
2.7 pF	278							
3.3 pF	338							
3.9 pF	398							
4.7 pF	478							
5.6 pF	568							
6.8 pF	688							
8.2 pF	828							

**NOTE**

1. Values in shaded cells indicate thickness class in mm
2. Capacitance value of non E-12 series is on request

**CAPACITANCE RANGE & THICKNESS FOR NP0**

Table 3 Sizes from 0805 to 1812

CAP.	Last 2-digit of	0805			1206		1210		1808			1812		
		12NC	1 KV	1 KV	2 KV	1 KV	2 KV	1 KV	2 KV	3 KV	1 KV	2 KV	3 KV	
10 pF	23													
12 pF	24													
15 pF	25													
18 pF	26													
22 pF	27		1.0±0.1											
27 pF	28													
33 pF	29													
39 pF	31													
47 pF	32				1.25±0.2									
56 pF	33													
68 pF	34						1.25±0.2		1.25±0.2					
82 pF	35													
100 pF	36			1.25±0.2		1.25±0.2						1.25±0.2		
120 pF	37							1.25±0.2						
150 pF	38													
180 pF	39													
220 pF	41									2.0±0.2	1.25±0.2			
270 pF	42													
330 pF	43													
390 pF	44												1.6±0.2	
470 pF	45													
560 pF	46													
680 pF	47													
820 pF	48												2.0±0.2	
1.0 nF	49													
1.2 nF	51													
1.5 nF	52													
1.8 nF	53													
2.2 nF	54													
2.7 nF	55											1.6±0.2		
3.3 nF	56													

**NOTE**

1. Values in shaded cells indicate thickness class in mm
2. Capacitance value of non E-12 series is on request

**CAPACITANCE RANGE & THICKNESS FOR X7R**

**Table 4** Sizes from 0805 to 1812

CAP.	Last 2-digit of	0805		1206			1210		1808			1812		
		I2NC	1 KV	1 KV	2 KV	1 KV	2 KV	1 KV	2 KV	3 KV	1 KV	2 KV	3 KV	
100 pF	09													
150 pF	12													
220 pF	14													
330 pF	16									1.6±0.2				
470 pF	18				1.25±0.2									
680 pF	21								1.35±0.15					
1.0 nF	23			1.25±0.2						2.0±0.2			1.6±0.2	
1.5 nF	25						1.25±0.2		1.35±0.15				1.35±0.15	
2.2 nF	27							1.6±0.2		1.6±0.2			2.0±0.2	
3.3 nF	29													
4.7 nF	32					1.25±0.2						1.35±0.15		
6.8 nF	34								1.6±0.2				1.6±0.2	
10 nF	36												2.0±0.2	
15 nF	38													
22 nF	41						1.6±0.2							
33 nF	43							2.0±0.2				1.6±0.2		
47 nF	45													
68 nF	47													
100 nF	49													

**NOTE**

1. Values in shaded cells indicate thickness class in mm
2. Capacitance value of non E-6 series is on request
3. For products with 5% tolerance, please contact local sales force before ordering



**THICKNESS CLASSES AND PACKING QUANTITY**

Table 5

SIZE CODE	THICKNESS CLASSIFICATION	TAPE WIDTH QUANTITY PER REEL	Ø180 MM / 7 INCH		Ø330 MM / 13 INCH		QUANTITY PER BULK CASE
			Paper	Blister	Paper	Blister	
0201	0.3 ±0.03 mm	8 mm	15,000	---	50,000	---	---
0402	0.5 ±0.05 mm	8 mm	10,000	---	50,000	---	50,000
0603	0.8 ±0.1 mm	8 mm	4,000	---	15,000	---	15,000
0805	0.6 ±0.1 mm	8 mm	4,000	---	20,000	---	10,000
	0.8 / 0.85 ±0.1 mm	8 mm	4,000	---	15,000	---	8,000
	1.00 ±0.1 mm	8 mm	---	3,000	---	10,000	---
	1.25 ±0.2 mm	8 mm	---	3,000	---	10,000	5,000
1206	0.6 ±0.1 mm	8 mm	4,000	---	20,000	---	---
	0.8 / 0.85 ±0.1 mm	8 mm	4,000	---	15,000	---	---
	1.00 / 1.15 ±0.1 mm	8 mm	---	3,000	---	10,000	---
	1.25 ±0.2 mm	8 mm	---	3,000	---	10,000	---
	1.6 ±0.15 mm	8 mm	---	2,500	---	10,000	---
	1.6 ±0.2 mm	8 mm	---	2,000	---	10,000	---
1210	0.6 / 0.7 ±0.1 mm	8 mm	---	4,000	---	15,000	---
	0.85 ±0.1 mm	8 mm	---	4,000	---	10,000	---
	1.15 ±0.1 mm	8 mm	---	3,000	---	10,000	---
	1.15 ±0.15 mm	8 mm	---	3,000	---	10,000	---
	1.25 ±0.2 mm	8 mm	---	3,000	---	---	---
	1.5 ±0.1 mm	8 mm	---	2,000	---	---	---
	1.6 / 1.9 ±0.2 mm	8 mm	---	2,000	---	---	---
	2.0 ±0.2 mm	8 mm	---	2,000 1,000	---	---	---
	2.5 ±0.2 mm	8 mm	---	1,000 500	---	---	---
1808	1.15 ±0.15 mm	12 mm	---	3,000	---	---	---
	1.25 ±0.2 mm	12 mm	---	3,000	---	---	---
	1.35 ±0.15 mm	12 mm	---	2,000	---	---	---
	1.5 ±0.1 mm	12 mm	---	2,000	---	---	---
	1.6 ±0.2 mm	12 mm	---	2,000	---	---	---
	2.0 ±0.2 mm	12 mm	---	2,000	---	---	---
1812	0.6 / 0.85 ±0.1 mm	12 mm	---	2,000	---	---	---
	1.15 ±0.1 mm	12 mm	---	1,000	---	---	---
	1.15 ±0.15 mm	12 mm	---	1,000	---	---	---
	1.25 ±0.2 mm	12 mm	---	1,000	---	---	---
	1.35 ±0.15 mm	12 mm	---	1,000	---	---	---
	1.5 ±0.1 mm	12 mm	---	1,000	---	---	---
	1.6 ±0.2 mm	12 mm	---	1,000	---	---	---
	2.0 ±0.2 mm	12 mm	---	1,000	---	---	---
2.5 ±0.2 mm	12 mm	---	500	---	---	---	

ELECTRICAL CHARACTERISTICS

**NP0/X7R DIELECTRIC CAPACITORS; NISN TERMINATIONS**

Unless otherwise stated all electrical values apply at an ambient temperature of 20±1 °C, an atmospheric pressure of 86 to 106 kPa, and a relative humidity of 63 to 67%.

Table 6

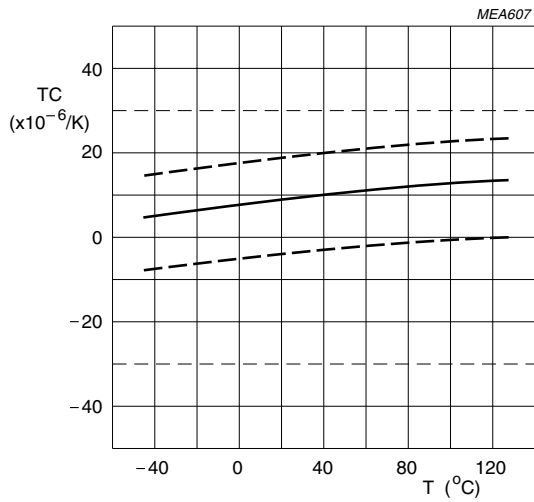
DESCRIPTION		VALUE
Capacitance range		0.47 pF to 33 nF
Capacitance tolerance		
NP0	C < 10 pF	±0.25 pF, ±0.5 pF
	C ≥ 10 pF	±2%, ±5%
X7R		±5% <sup>(1)</sup> , ±10%
Dissipation factor (D.F.)		
NP0	C < 30 pF	≤ 1 / ( 400 + 20C )
	C ≥ 30 pF	≤ 0.1 %
X7R		≤ 2.5 %
Insulation resistance after 1 minute at U <sub>r</sub> (DC)		R <sub>ins</sub> ≥ 10 GΩ or R <sub>ins</sub> × C ≥ 500 seconds whichever is less
Maximum capacitance change as a function of temperature (temperature characteristic/coefficient):		
NP0		±30 ppm/°C
X7R		±15%
Operating temperature range:		
NP0/X7R		-55 °C to +125 °C

**NOTE**

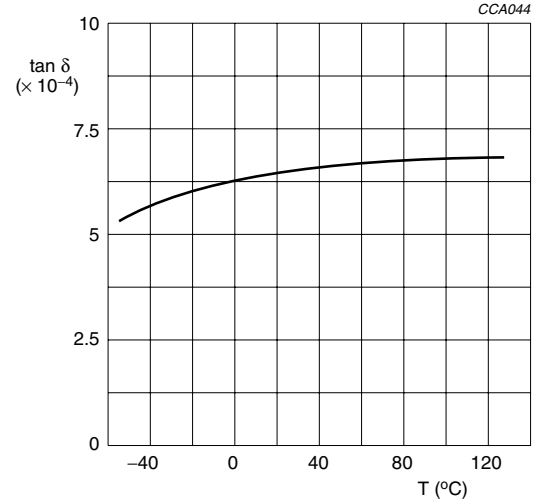
1. ±5% tolerance of capacitance value isn't available for X7R full product range, please contact local sales force before ordering

**HIGH-VOLTAGE NP0**

Sample limits (broken lines).  
Requirement levels (dotted lines)

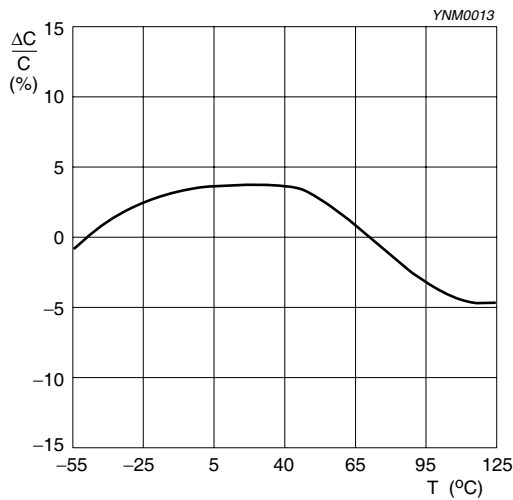


**Fig. 3** Typical temperature coefficient as a function of temperature

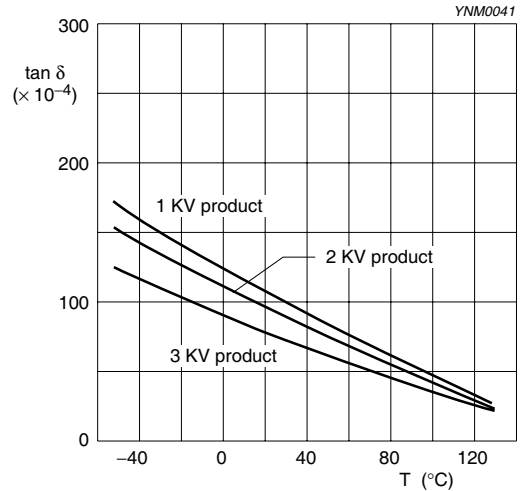


**Fig. 4** Typical tan δ as a function of temperature

**HIGH-VOLTAGE X7R**



**Fig. 5** Typical capacitance change as a function of temperature



**Fig. 6** Typical tan δ as a function of temperature

**SOLDERING RECOMMENDATION**

Table 7

SOLDERING METHOD	SIZE				
	0402	0603	0805	1206	≥ 1210
Reflow	≥ 0.1 μF	≥ 1.0 μF	≥ 2.2 μF	≥ 4.7 μF	Reflow only
Reflow/Wave	< 0.1 μF	< 1.0 μF	< 2.2 μF	< 4.7 μF	---

**TESTS AND REQUIREMENTS**

Table 8 Test procedures and requirements

TEST	TEST METHOD	PROCEDURE	REQUIREMENTS
Mounting	IEC 60384-21/22 4.3	The capacitors may be mounted on printed-circuit boards or ceramic substrates	No visible damage
Visual Inspection and Dimension Check	4.4	Any applicable method using × 10 magnification	In accordance with specification
Capacitance	4.5.1	Class 1: f = 1 MHz for C ≤ 1 nF, measuring at voltage 1 V <sub>rms</sub> at 20 °C f = 1 KHz for C > 1 nF, measuring at voltage 1 V <sub>rms</sub> at 20 °C Class 2: f = 1 KHz for C ≤ 10 μF, measuring at voltage 1 V <sub>rms</sub> at 20 °C	Within specified tolerance
Dissipation Factor (D.F.)	4.5.2	Class 1: f = 1 MHz for C ≤ 1 nF, measuring at voltage 1 V <sub>rms</sub> at 20 °C f = 1 KHz for C > 1 nF, measuring at voltage 1 V <sub>rms</sub> at 20 °C Class 2: f = 1 KHz for C ≤ 10 μF, measuring at voltage 1 V <sub>rms</sub> at 20 °C	In accordance with specification
Insulation Resistance	4.5.3	U <sub>r</sub> ≤ 500 V: At U <sub>r</sub> for 1 minute U <sub>r</sub> > 500 V: At 500 V for 1 minute	In accordance with specification
Temperature Coefficient	4.6	Class 1: Between minimum and maximum temperature NP0: -55 °C to +125 °C Normal Temperature: 20 °C	ΔC/C: Class 1: NP0: ±30 ppm/°C
Temperature Characteristic		Class 2: Between minimum and maximum temperature X7R: -55 °C to +125 °C Normal Temperature: 20 °C	Class 2 X7R: ±15%

TEST	TEST METHOD	PROCEDURE	REQUIREMENTS
Adhesion	IEC 60384-21/22 4.7	A force applied for 10 seconds to the line joining the terminations and in a plane parallel to the substrate	Force size $\geq$ 0603: 5N
Bond Strength of Plating on End Face	4.8	Mounting in accordance with IEC 60384-22 paragraph 4.3  Conditions: bending 1 mm at a rate of 1 mm/s, radius jig 340 mm	No visible damage  $\Delta C/C$ Class 1: NP0: within $\pm 1\%$ or 0.5 pF, whichever is greater Class2: X7R: $\pm 10\%$
Resistance to Soldering Heat	4.9	Precondition: 150 $\pm 10$ °C for 1 hour, then keep for 24 $\pm$ 1 hours at room temperature Preheating: for size $\leq$ 1206: 120 °C to 150 °C for 1 minute Preheating: for size $>$ 1206: 100 °C to 120 °C for 1 minute and 170 °C to 200 °C for 1 minute Solder bath temperature: 260 $\pm$ 5 °C Dipping time: 10 $\pm$ 0.5 seconds Recovery time: 24 $\pm$ 2 hours	Dissolution of the end face plating shall not exceed 25% of the length of the edge concerned  $\Delta C/C$ Class 1: NP0: within $\pm 0.5\%$ or 0.5 pF, whichever is greater Class2: X7R: $\pm 10\%$  D.F. within initial specified value $R_{ins}$ within initial specified value
Solderability	4.10	Preheated to a temperature of 80 °C to 140 °C and maintained for 30 seconds to 60 seconds.  Test conditions for lead containing solder alloy Temperature: 235 $\pm$ 5 °C Dipping time: 2 $\pm$ 0.2 seconds Depth of immersion: 10 mm Alloy Composition: 60/40 Sn/Pb Number of immersions: 1  Test conditions for lead-free containing solder alloy Temperature: 245 $\pm$ 5 °C Dipping time: 3 $\pm$ 0.3 seconds Depth of immersion: 10 mm Alloy Composition: SAC305 Number of immersions: 1	The solder should cover over 95% of the critical area of each termination

TEST	TEST METHOD	PROCEDURE	REQUIREMENTS
Rapid Change of Temperature	IEC 60384-21/22 4.11	<p>Preconditioning: 150 +0/-10 °C for 1 hour, then keep for 24 ± 1 hours at room temperature</p> <p>5 cycles with following detail: 30 minutes at lower category temperature 30 minutes at upper category temperature</p> <p>Recovery time 24 ± 2 hours</p>	<p>No visual damage</p> <hr/> <p><math>\Delta C/C</math> Class 1: NP0: within ±1% or 1 pF, whichever is greater Class2: X7R: ±15%</p> <hr/> <p>D.F. meet initial specified value <math>R_{ins}</math> meet initial specified value</p>
Damp Heat	4.13	<ol style="list-style-type: none"> <li>Preconditioning, class 2 only: 150 +0/-10 °C /1 hour, then keep for 24 ± 1 hour at room temp</li> <li>Initial measure: Spec: refer to initial spec C, D, IR</li> <li>Damp heat test: 500 ± 12 hours at 40 ± 2 °C; 90 to 95% R.H.</li> <li>Recovery: Class 1: 6 to 24 hours Class 2: 24 ± 2 hours</li> <li>Final measure: C, D, IR</li> </ol> <p>P.S. If the capacitance value is less than the minimum value permitted, then after the other measurements have been made the capacitor shall be preconditioned according to "IEC 60384 4.1" and then the requirement shall be met.</p>	<p>No visual damage after recovery</p> <hr/> <p><math>\Delta C/C</math> Class 1: NP0: within ±2% or 1 pF, whichever is greater Class2: X7R: ±15%</p> <p>D.F. Class 1: NP0: ≤ 2 × specified value Class2: X7R: ≥ 25 V: ≤ 5%</p> <p><math>R_{ins}</math> Class 1: NP0: ≥ 2,500 MΩ or <math>R_{ins} \times C_r \geq 25s</math> whichever is less Class2: X7R: ≥ 500 MΩ or <math>R_{ins} \times C_r \geq 25s</math> whichever is less</p>

TEST	TEST METHOD	PROCEDURE	REQUIREMENTS
<b>Endurance</b>	IEC 60384-21/22 4.14	<ol style="list-style-type: none"> <li>Preconditioning, class 2 only: 150 +0/-10 °C /1 hour, then keep for 24 ±1 hour at room temp</li> <li>Initial measure: Spec: refer to initial spec C, D, IR</li> <li>Endurance test: Temperature: NP0/X7R: 125 °C Specified stress voltage applied for 1,000 hours. High-Voltage series follows the stress conditions below: Applied 2.0 × U<sub>r</sub> for &lt; 500 V series Applied 1.3 × U<sub>r</sub> for 500 V, 630 V series Applied 1.2 × U<sub>r</sub> for 1 KV, 2 KV, 3 KV series</li> <li>Recovery time: 24 ±2 hours</li> <li>Final measure: C, D, IR</li> </ol> <p>P.S. If the capacitance value is less than the minimum value permitted, then after the other measurements have been made the capacitor shall be preconditioned according to "IEC 60384 4.1" and then the requirement shall be met.</p>	<p>No visual damage</p> <hr/> <p>ΔC/C</p> <p><b>Class1:</b> NP0: within ±2% or 1 pF, whichever is greater</p> <p><b>Class2:</b> X7R: ±15%</p> <p>D.F.</p> <p><b>Class1:</b> NP0: ≤ 2 × specified value</p> <p><b>Class2:</b> X7R: ≥ 25 V: ≤ 5%</p> <p>R<sub>ins</sub></p> <p><b>Class1:</b> NP0: ≥ 4,000 MΩ or R<sub>ins</sub> × C<sub>r</sub> ≥ 40s whichever is less</p> <p><b>Class2:</b> X7R: ≥ 1,000 MΩ or R<sub>ins</sub> × C<sub>r</sub> ≥ 50s whichever is less</p>
<b>Voltage Proof</b>	IEC 60384-1 4.6	<p>Specified stress voltage applied for 1 minute</p> <p>U<sub>r</sub> ≤ 100 V: series applied 2.5 U<sub>r</sub></p> <p>100 V &lt; U<sub>r</sub> ≤ 200 V series applied (1.5 U<sub>r</sub> + 100)</p> <p>200 V &lt; U<sub>r</sub> ≤ 500 V series applied (1.3 U<sub>r</sub> + 100)</p> <p>U<sub>r</sub> &gt; 500 V: 1.3 U<sub>r</sub></p> <p>I: 7.5 mA</p>	No breakdown or flashover

REVISION HISTORY

REVISION	DATE	CHANGE NOTIFICATION	DESCRIPTION
Version 4	Aug 08, 2011	-	- Product range updated
Version 3	Jan 19, 2011	-	- Dimension updated - Add NP0 0805 1KV
Version 2	Feb 02, 2010	-	- Change to dual brand datasheet that describe High-Voltage NP0/X7R series with RoHS compliant - Replace the high voltage part of pdf files: UP-NP0X7R_HV_1K-to-4KV_I and UY-NP0X7R_HV_1K-to-4KV_I - Description of "Halogen Free compliant" added - Product range updated - Define global part number - Test method and procedure updated
Version 1	Sep 30, 2005	-	- Thickness revised
Version 0	Sep 12, 2005	-	- New