

DATA SHEET

WIRELESS COMPONENTS
Ceramic Patch Antenna
ANT2525B00BT1575A
GPS
SMD 25*25*4mm



FEATURES

- High radiation efficiency
- Reflow process compatible
- RoHS compliant

APPLICATIONS

- Navigation device
- Telematics box
- Fleet management

ORDERING INFORMATION

All part numbers are identified by the series, packing type, material, size, antenna type, working frequency and packing quantity.

PART NUMBER

ANT 2525 B 00B T 1575A
 (1) (2) (3) (4) (5) (6)

(1) PRODUCT

ANT = Antenna

(2) SIZE

2525 = 25 × 25 mm

(3) ANTENNA TYPE

B = Bulk Antenna

(4) SERIAL NO.

00B

(5) PACKING STYLE

T = Tray

(6) WORKING FREQUENCY

1575 = 1.575GHz

PHYCOMP CTC

CAN43134250B1581B

I2NC

43134250B158

SPECIFICATION

Table 1

DESCRIPTION	VALUE
Centre Frequency	1580 ± 2 MHz
Bandwidth	20 MHz (Typ.)
Gain	5.5 dBic (Typ.)
VSWR	2.0 Max
Polarization	Right Hand Circular Polarization
Axis Ratio	≤ 3dB
Beam Width	> 120 degrees
Impedance	50Ω
Operating Temperature	-40~105 °C

NOTE

1. Based on 70* 70 mm² square ground plane.
2. Central frequency will be offset to working frequency while changes of customer's housing and ground plane.
3. Please contact local sales if you need customized design to gain optimum antenna performance.

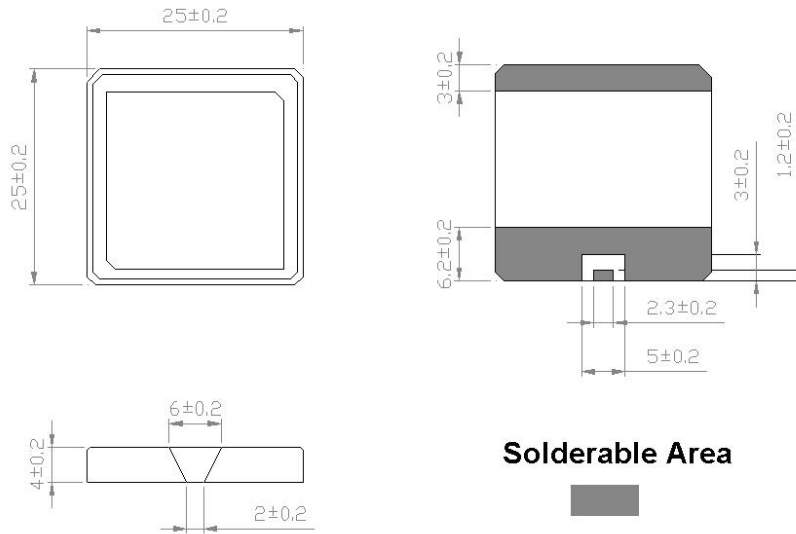

Fig. 1 Mechanical data

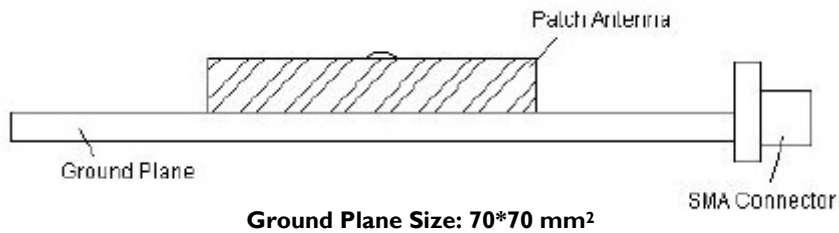

Fig. 2 Evaluation Board

ELECTRICAL PERFORMANCES

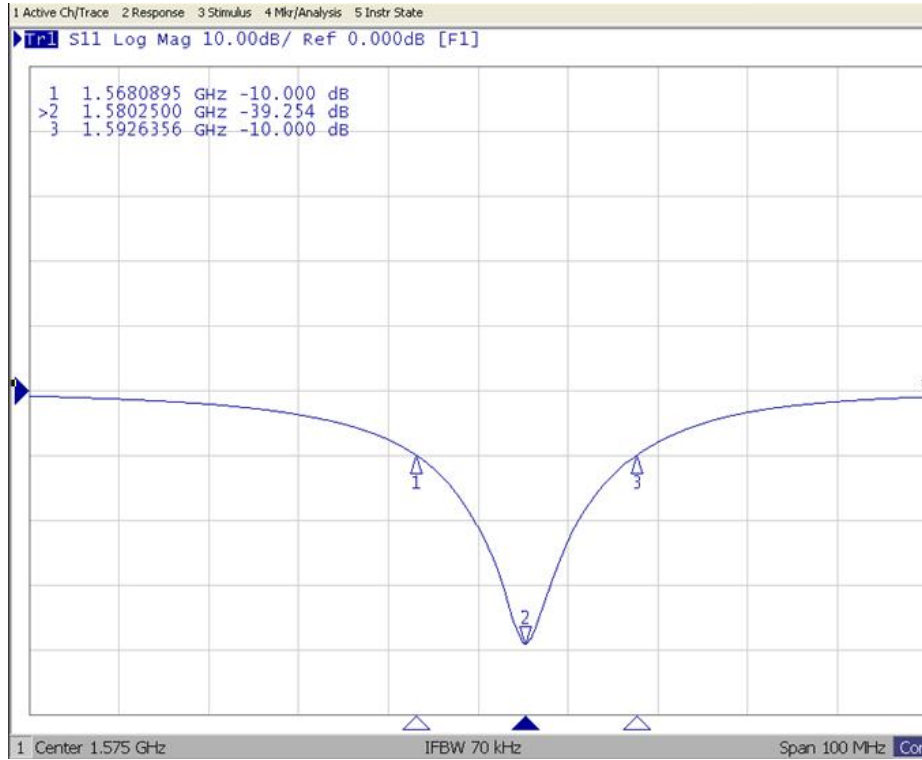

Fig. 3 Return loss

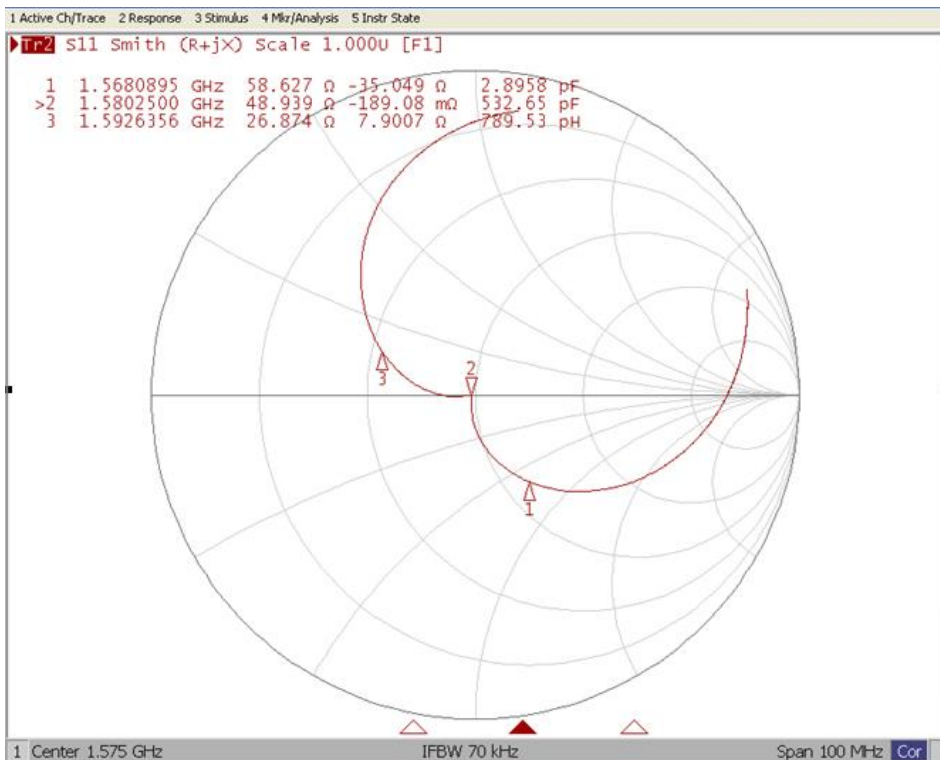

Fig. 4 Smith Chart

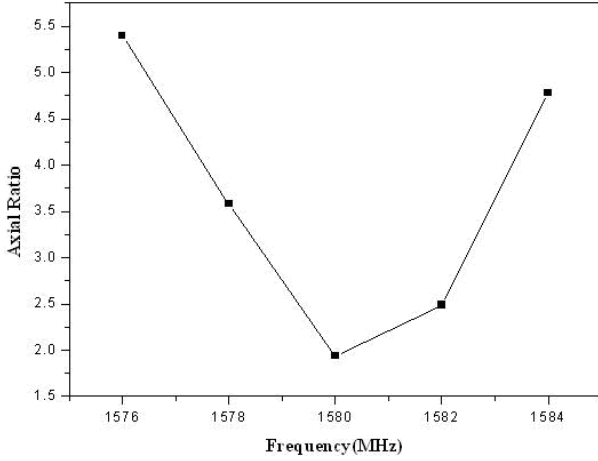

Fig. 5 Axial Ratio measurement

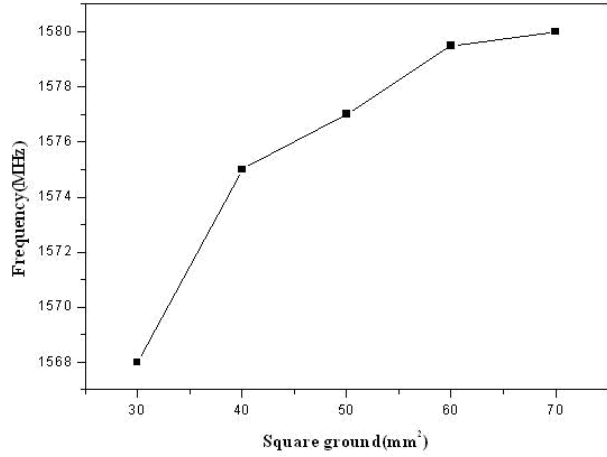

Fig. 6 Center Frequency V.S. Ground Plane

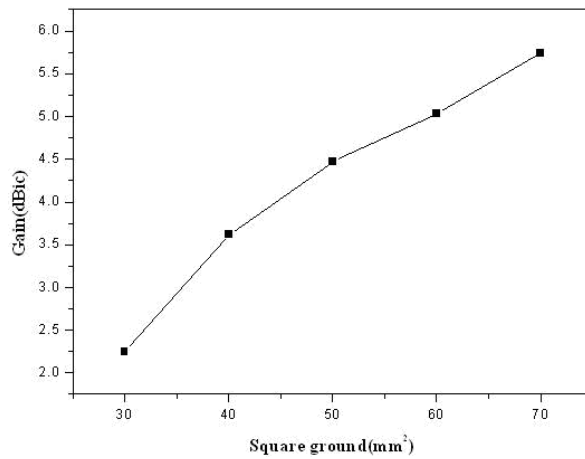
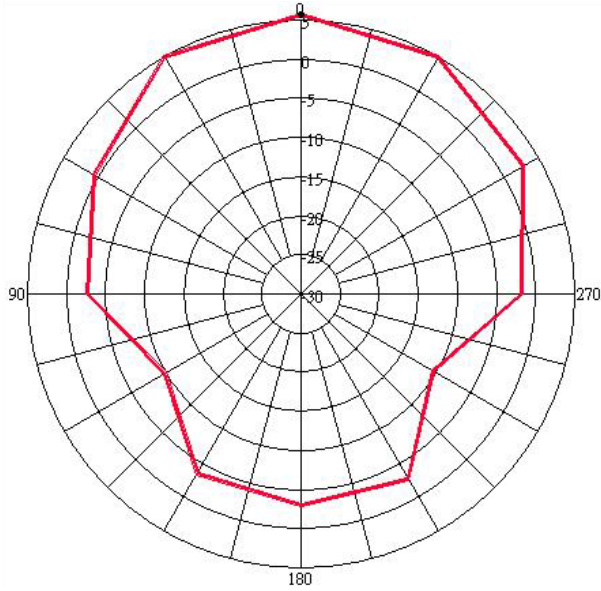
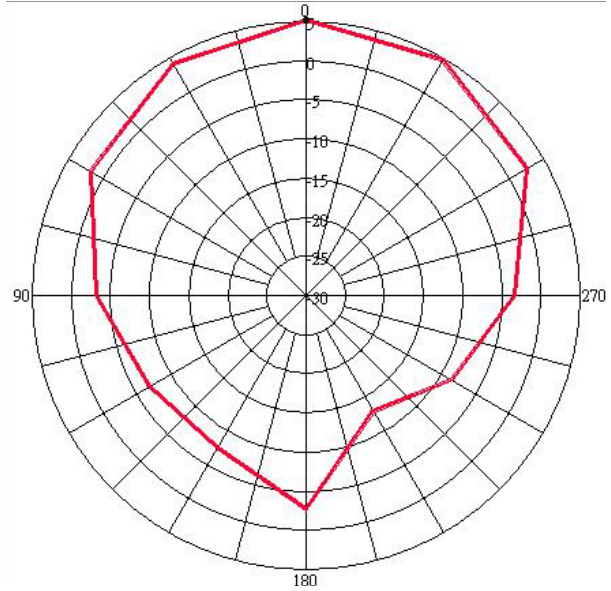

Fig. 7 Antenna Gain V.S. Ground Plane



2D x-z plane pattern



2D y-z plane pattern

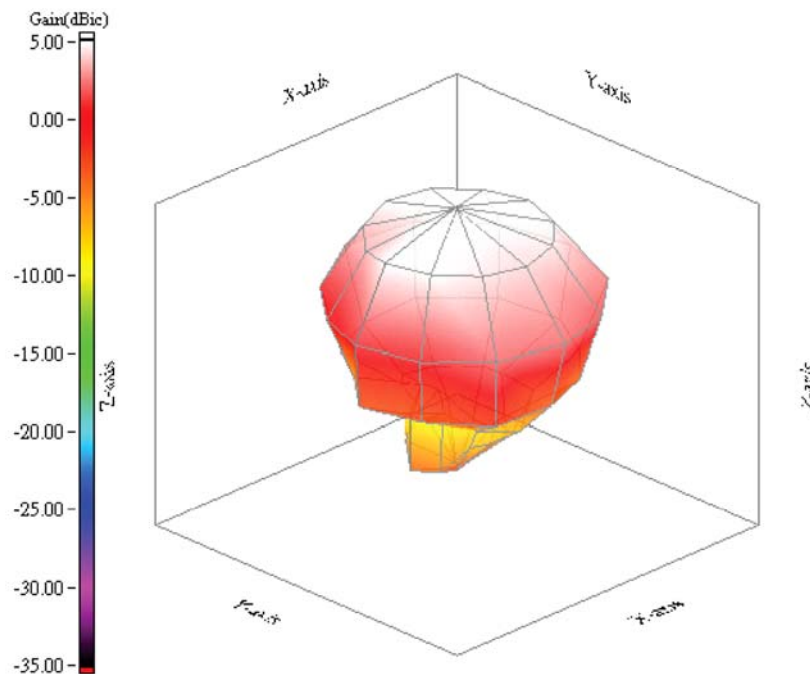

3D radiation pattern

Fig. 8 Radiation Pattern (Frequency = 1580MHz)

REVISION HISTORY

REVISION	DATE	CHANGE NOTIFICATION	DESCRIPTION
Version 0	Feb. 05, 2013	-	- New datasheet for Patch antenna, SMD Feed size 25*25*4 mm