

DATA SHEET

SURFACE-MOUNT CERAMIC MULTILAYER CAPACITORS

General Purpose & High Capacitance

Class 2, X7R

6.3 V TO 50 V

100 pF to 22 μ F

RoHS compliant & Halogen Free



SCOPE

This specification describes X7R series chip capacitors with lead-free terminations.

APPLICATIONS

- PCs, Hard disk, Game PCs
- DVDs, Video cameras
- Mobile phones
- Data processing

FEATURES

- Supplied in tape on reel
- Nickel-barrier end termination
- RoHS compliant
- Halogen Free compliant

ORDERING INFORMATION-GLOBAL PART NUMBER, PHYCOMP

CTC & I2NC

All part numbers are identified by the series, size, tolerance, TC material, packing style, voltage, process code, termination and capacitance value.

YAGEO BRAND ordering code

GLOBAL PART NUMBER (PREFERRED)

CC XXXX X X **X7R** X **BB** XXX
 (1) (2) (3) (4) (5)

(1) SIZE – INCH BASED (METRIC)

- 0201 (0603)
- 0402 (1005)
- 0603 (1608)
- 0805 (2012)
- 1206 (3216)
- 1210 (3225)
- 1812 (4532)

(2) TOLERANCE

- J = ±5% ⁽¹⁾
- K = ±10%
- M = ±20%

(3) PACKING STYLE

- R = Paper/PE taping reel; Reel 7 inch
- K = Blister taping reel; Reel 7 inch
- P = Paper/PE taping reel; Reel 13 inch
- F = Blister taping reel; Reel 13 inch
- C = Bulk case

(4) RATED VOLTAGE

- 5 = 6.3 V
- 6 = 10 V
- 7 = 16 V
- 8 = 25 V
- 9 = 50 V

(5) CAPACITANCE VALUE

2 significant digits+number of zeros
 The 3rd digit signifies the multiplying factor, and letter R is decimal point
 Example: 103 = 10 × 10³ = 10,000 pF = 10 nF

NOTE

I. Tolerance ±5% is not available for full product range, please contact local sales force before ordering

PHYCOMP BRAND ordering codes

GLOBAL PART NUMBER (preferred), PHYCOMP CTC (for North America) and I2NC (traditional) codes are acceptable to order Phycomp brand products.

GLOBAL PART NUMBER (PREFERRED)

For detailed information of GLOBAL PART NUMBER and ordering example, please refer to page 2.

I2NC CODE

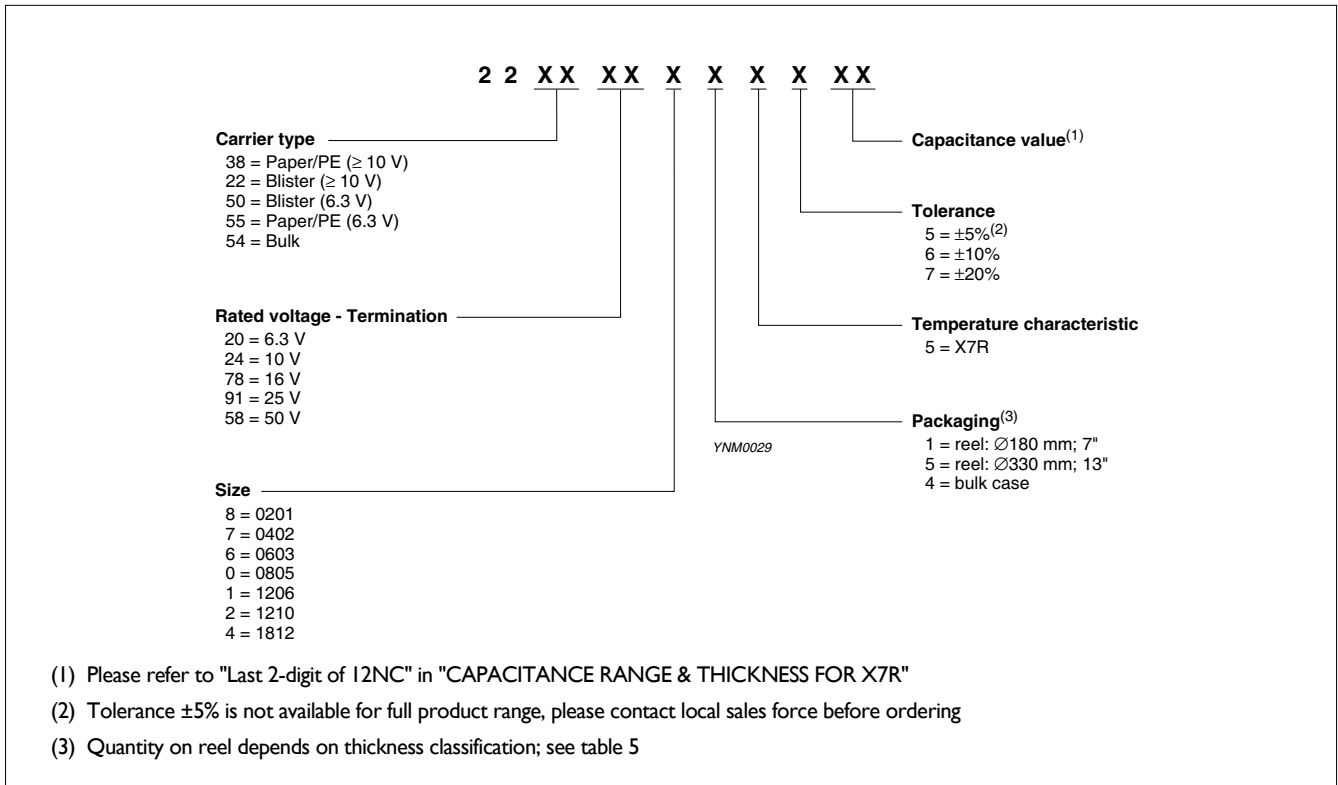

PHYCOMP CTC CODE (FOR NORTH AMERICA)

🔗 Example: 02012R102K8B20D

0201	2R	102	K	8	B	2	0	D
Size code	Temp. Char.	Capacitance in pF	Tolerance	Voltage	Termination	Packing	Marking	Range identifier
0201	2R = X7R	101 = 100 pF;	J = ±5% ⁽¹⁾	5 = 6.3 V	B = NiSn	2 = 180 mm	0 = no marking	D = Class 2 MLCC
0402		the third digit	K = ±10%	6 = 10 V		7" Paper/PE		
0603		signifies the	M = ±20%	7 = 16 V		3 = 330 mm		
0805		multiplying factor:		8 = 25 V		13" Paper/PE		
1206		0 = × 1		9 = 50 V		B = 180 mm		
1210		1 = × 10				7" Blister		
1812		2 = × 100				F = 330 mm		
		3 = × 1,000				13" Blister		
						P = Bulk case		

NOTE

I. Tolerance ±5% is not available for full product range, please contact local sales force before ordering

CONSTRUCTION

The capacitor consists of a rectangular block of ceramic dielectric in which a number of interleaved metal electrodes are contained. This structure gives rise to a high capacitance per unit volume.

The inner electrodes are connected to the two end terminations and finally covered with a layer of plated tin (NiSn). The terminations are lead-free. A cross section of the structure is shown in Fig.1.

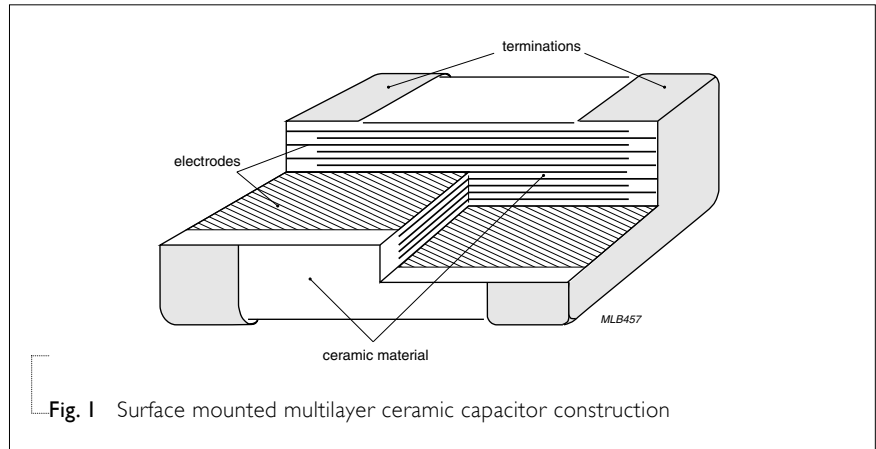

Fig. 1 Surface mounted multilayer ceramic capacitor construction

DIMENSION

Table I For outlines see fig. 2

TYPE	L ₁ (mm)	W (mm)	T (MM)	L ₂ / L ₃ (mm)		L ₄ (mm)
				min.	max.	min.
0201	0.6 ±0.03	0.3 ±0.03	Refer to table 2 to 4	0.10	0.20	0.20
0402	1.0 ±0.05	0.5 ±0.05		0.15	0.30	0.40
0603	1.6 ±0.10 ⁽¹⁾	0.8 ±0.10 ⁽¹⁾		0.20	0.60	0.40
	1.6 ±0.15 ⁽²⁾	0.8 ±0.15 ⁽²⁾				
0805	2.0 ±0.10 ⁽¹⁾	1.25 ±0.10 ⁽¹⁾		0.25	0.75	0.55
	2.0 ±0.20 ⁽²⁾	1.25 ±0.20 ⁽²⁾				
1206	3.2 ±0.15 ⁽¹⁾	1.6 ±0.15 ⁽¹⁾		0.25	0.75	1.40
	3.2 ±0.30 ⁽²⁾	1.6 ±0.20 ⁽²⁾				
1210	3.2 ±0.20 ⁽¹⁾	2.5 ±0.20 ⁽¹⁾		0.25	0.75	1.40
	3.2 ±0.40 ⁽²⁾	2.5 ±0.30 ⁽²⁾				
1812	4.5 ±0.20 ⁽¹⁾	3.2 ±0.20 ⁽¹⁾		0.25	0.75	2.20
	4.5 ±0.40 ⁽²⁾	3.2 ±0.40 ⁽²⁾				

OUTLINES

For dimension see Table I

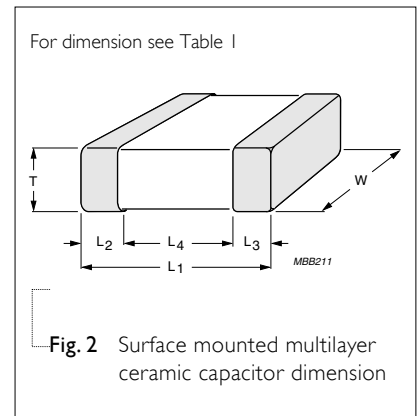

Fig. 2 Surface mounted multilayer ceramic capacitor dimension

NOTE

1. Dimension for size 0603, C < 10 µF; 0805 to 1812, C ≤ 100nF
2. Dimension for size 0603, C ≥ 10 µF; 0805 to 1812, C > 100 nF

CAPACITANCE RANGE & THICKNESS FOR X7R

Table 2 Sizes from 0201 to 0402

CAP.	Last 2-digit of	0201					0402					
		12NC	6.3 V	10 V	16 V	25 V	50 V	6.3 V	10 V	16 V	25 V	50 V
100 pF	09											
150 pF	12											
220 pF	14											
330 pF	16					0.3±0.03						
470 pF	18											
680 pF	21											
1.0 nF	23	0.3±0.03	0.3±0.03	0.3±0.03								0.5±0.05
1.5 nF	25											
2.2 nF	27											
3.3 nF	29							0.5±0.05	0.5±0.05	0.5±0.05	0.5±0.05	
4.7 nF	32											
6.8 nF	34											
10 nF	36											
15 nF	38											
22 nF	41											
33 nF	43											
47 nF	45											
68 nF	47											
100 nF	49											
150 nF	52											
220 nF	54							0.5±0.05	0.5±0.05	0.5±0.05		
330 nF	56											
470 nF	58							0.5±0.05				
680 nF	61											
1.0 µF	63											
2.2 µF	67											
4.7 µF	72											
10 µF	76											
22 µF	81											

NOTE

1. Values in shaded cells indicate thickness class in mm
2. Capacitance value of non E-6 series is on request
3. For product with 5% tolerance, please contact local sales force before ordering

CAPACITANCE RANGE & THICKNESS FOR X7R

Table 3 Sizes from 0603 to 0805

CAP.	Last 2-digit of	0603					0805					
		12NC	6.3 V	10 V	16 V	25 V	50 V	6.3 V	10 V	16 V	25 V	50 V
100 pF	09											
150 pF	12											
220 pF	14											
330 pF	16											
470 pF	18											
680 pF	21											
1.0 nF	23											
1.5 nF	25											
2.2 nF	27										0.6±0.1	0.6±0.1
3.3 nF	29						0.8±0.1					
4.7 nF	32											
6.8 nF	34											
10 nF	36					0.8±0.1						
15 nF	38	0.8±0.1	0.8±0.1	0.8±0.1	0.8±0.1							
22 nF	41											
33 nF	43											
47 nF	45											
68 nF	47											
100 nF	49						0.85±0.1	0.85±0.1	0.85±0.1	0.85±0.1	0.85±0.1	
150 nF	52											
220 nF	54											
330 nF	56											
470 nF	58											1.25±0.2
680 nF	61											
1.0 μF	63						1.25±0.2	1.25±0.2				
2.2 μF	67											
4.7 μF	72											
10 μF	76											
22 μF	81											

NOTE

1. Values in shaded cells indicate thickness class in mm
2. Capacitance value of non E-6 series is on request
3. For product with 5% tolerance, please contact local sales force before ordering

CAPACITANCE RANGE & THICKNESS FOR X7R

Table 4 Size 1206

CAP.	Last 2-digit of I2NC	I206 6.3 V	10 V	16 V	25 V	50 V
100 pF	09					
150 pF	12					
220 pF	14					
330 pF	16					
470 pF	18					
680 pF	21					
1.0 nF	23					
1.5 nF	25					
2.2 nF	27					
3.3 nF	29					
4.7 nF	32					0.85±0.1
6.8 nF	34					
10 nF	36				0.85±0.1	
15 nF	38					
22 nF	41					
33 nF	43					
47 nF	45					
68 nF	47					
100 nF	49					
150 nF	52					1.15±0.1
220 nF	54					
330 nF	56			0.85±0.1		
470 nF	58					1.0±0.1
680 nF	61					
1.0 µF	63	1.15±0.1	1.15±0.1	1.15±0.1	1.15±0.1	1.6±0.2
2.2 µF	67					
4.7 µF	72		1.6±0.2	1.6±0.2	1.6±0.2	
10 µF	76	1.6±0.2				
22 µF	81					
47 µF	85					

NOTE

1. Values in shaded cells indicate thickness class in mm
2. Capacitance value of non E-6 series is on request
3. For product with 5% tolerance, please contact local sales force before ordering
4. Please contact local sales force for special ordering code before ordering

CAPACITANCE RANGE & THICKNESS FOR X7R

Table 5 Sizes from 1210 to 1812

CAP.	Last 2-digit of I2NC	1210					1812	
		6.3 V	10 V	16 V	25 V	50 V	50 V	
100 pF	09							
150 pF	12							
220 pF	14							
330 pF	16							
470 pF	18							
680 pF	21							
1.0 nF	23							
1.5 nF	25							
2.2 nF	27							
3.3 nF	29							
4.7 nF	32							
6.8 nF	34							
10 nF	36							
15 nF	38						0.85±0.1	0.85±0.1
22 nF	41							
33 nF	43							
47 nF	45							
68 nF	47							
100 nF	49							
150 nF	52							
220 nF	54				0.85±0.1	1.15±0.1	1.15±0.1	1.15±0.1
330 nF	56							
470 nF	58				1.15±0.1	1.25±0.2	1.25±0.2	1.6±0.2
680 nF	61							
1.0 µF	63				1.25±0.2			
2.2 µF	67					1.9±0.2	1.9±0.2	
4.7 µF	72		1.9±0.2	1.9±0.2	1.9±0.2			
10 µF	76							
22 µF	81		2.5±0.2	2.5±0.2				
47 µF	85		2.5±0.2					

NOTE

1. Values in shaded cells indicate thickness class in mm
2. Capacitance value of non E-6 series is on request
3. For product with 5% tolerance, please contact local sales force before ordering
4. Please contact local sales force for special ordering code before ordering

THICKNESS CLASSES AND PACKING QUANTITY

Table 6

SIZE CODE	THICKNESS CLASSIFICATION	TAPE WIDTH QUANTITY PER REEL	Ø180 MM / 7 INCH		Ø330 MM / 13 INCH		QUANTITY PER BULK CASE
			Paper	Blister	Paper	Blister	
0201	0.3 ±0.03 mm	8 mm	15,000	---	50,000	---	---
0402	0.5 ±0.05 mm	8 mm	10,000	---	50,000	---	50,000
0603	0.8 ±0.1 mm	8 mm	4,000	---	15,000	---	15,000
0805	0.6 ±0.1 mm	8 mm	4,000	---	20,000	---	10,000
	0.85 ±0.1 mm	8 mm	4,000	---	15,000	---	8,000
	1.25 ±0.2 mm	8 mm	---	3,000	---	10,000	5,000
1206	0.6 ±0.1 mm	8 mm	4,000	---	20,000	---	---
	0.85 ±0.1 mm	8 mm	4,000	---	15,000	---	---
	1.00 / 1.15 ±0.1 mm	8 mm	---	3,000	---	10,000	---
	1.25 ±0.2 mm	8 mm	---	3,000	---	10,000	---
	1.6 ±0.15 mm	8 mm	---	2,500	---	10,000	---
1210	1.6 ±0.2 mm	8 mm	---	2,000	---	10,000	---
	0.6 / 0.7 ±0.1 mm	8 mm	---	4,000	---	15,000	---
	0.85 ±0.1 mm	8 mm	---	4,000	---	10,000	---
	1.15 ±0.1 mm	8 mm	---	3,000	---	10,000	---
	1.15 ±0.15 mm	8 mm	---	3,000	---	10,000	---
	1.25 ±0.2 mm	8 mm	---	3,000	---	---	---
	1.5 ±0.1 mm	8 mm	---	2,000	---	---	---
	1.6 / 1.9 ±0.2 mm	8 mm	---	2,000	---	---	---
1808	2.0 ±0.2 mm	8 mm	---	2,000 1,000	---	---	---
	2.5 ±0.2 mm	8 mm	---	1,000 500	---	---	---
	1.15 ±0.15 mm	12 mm	---	3,000	---	---	---
	1.25 ±0.2 mm	12 mm	---	3,000	---	---	---
	1.35 ±0.15 mm	12 mm	---	2,000	---	---	---
	1.5 ±0.1 mm	12 mm	---	2,000	---	---	---
1812	1.6 ±0.2 mm	12 mm	---	2,000	---	8,000	---
	2.0 ±0.2 mm	12 mm	---	2,000	---	---	---
	0.6 / 0.85 ±0.1 mm	12 mm	---	2,000	---	---	---
	1.15 ±0.1 mm	12 mm	---	1,000	---	---	---
	1.25 ±0.2 mm	12 mm	---	1,000	---	---	---
	1.5 ±0.1 mm	12 mm	---	1,000	---	---	---
	1.6 ±0.2 mm	12 mm	---	1,000	---	---	---
2.0 ±0.2 mm	12 mm	---	1,000	---	---	---	
2.5 ±0.2 mm	12 mm	---	500	---	---	---	

ELECTRICAL CHARACTERISTICS

X7R DIELECTRIC CAPACITORS; NISN TERMINATIONS

Unless otherwise specified, all test and measurements shall be made under standard atmospheric conditions for testing as given in 5.3 of IEC 60068-1:

- Temperature: 15 °C to 35 °C
- Relative humidity: 25% to 75%
- Air pressure: 86 kPa to 106 kPa

Before the measurements are made, the capacitor shall be stored at the measuring temperature for a time sufficient to allow the entire capacitor to reach this temperature.

The period as prescribed for recovery at the end of a test is normally sufficient for this purpose.

Table 7

DESCRIPTION	VALUE
Capacitance range	100 pF to 22 μF
Capacitance tolerance	±5%, ±10%, ±20%
Dissipation factor (D.F.)	
≤ 10 V	≤ 5%
Exception: 0201 ≥ 12 nF; 0603 ≥ 2.2 μF; 0805 ≥ 4.7 μF;	≤ 10%
1210 ≥ 4.7 μF	
0805 ≥ 10 μF; 1206 ≥ 10 μF	≤ 15%
16 V	≤ 3.5%
Exception: 0201 ≥ 1.5 nF; 0402 ≥ 27 nF; 0603 ≥ 220 nF;	≤ 5%
0805 ≥ 680 nF; 1206 ≥ 2.2 μF; 1210 ≥ 10 μF	
1206 ≥ 10 μF; 1210 ≥ 22 μF	≤ 10%
25 V	≤ 2.5%
Exception: 0402 ≥ 10 nF; 0603 ≥ 47 nF; 0805 ≥ 220 nF;	≤ 3.5%
1206 ≥ 1 μF; 1210 ≥ 4.7 μF	
0201 ≥ 560 pF; 0402 ≥ 56 nF; 0603 ≥ 1 μF;	≤ 5%
0805 ≥ 680 nF; 1206 ≥ 2.2 μF; 1210 ≥ 10 μF	
1206 ≥ 4.7 μF	≤ 10%
≥ 50 V	≤ 2.5%
Exception: 0201 ≥ 47 pF; 1206 ≥ 1 μF	≤ 3.5%
0603 ≥ 47 nF	≤ 3.0%
Insulation resistance after 1 minute at U _r (DC)	R _{ins} ≥ 10 GΩ or R _{ins} × C _r ≥ 500 seconds whichever is less
Maximum capacitance change as a function of temperature (temperature characteristic/coefficient):	±15%
Operating temperature range:	-55 °C to +125 °C

NOTE

Capacitance tolerance ±5% is not available for full product range, please contact local sales force before ordering

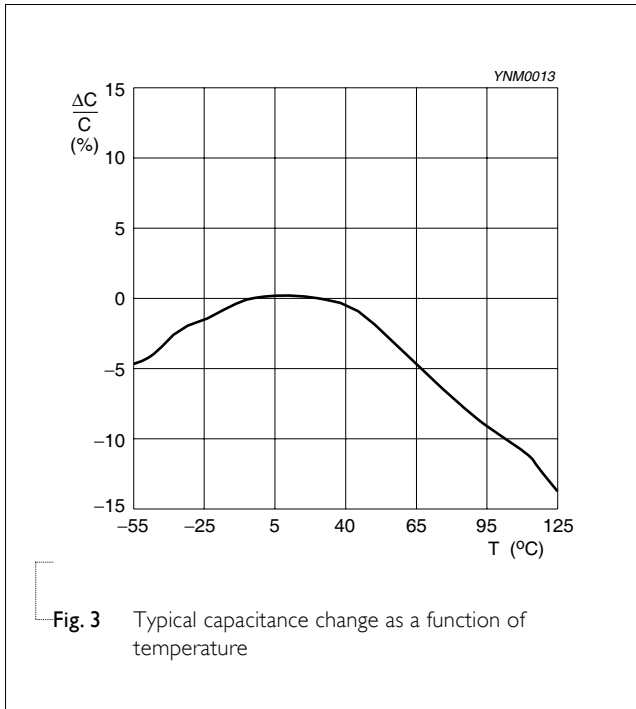

Size 0201 10 nF / 16 V
Solid lines: Impedance / Dotted lines: ESR

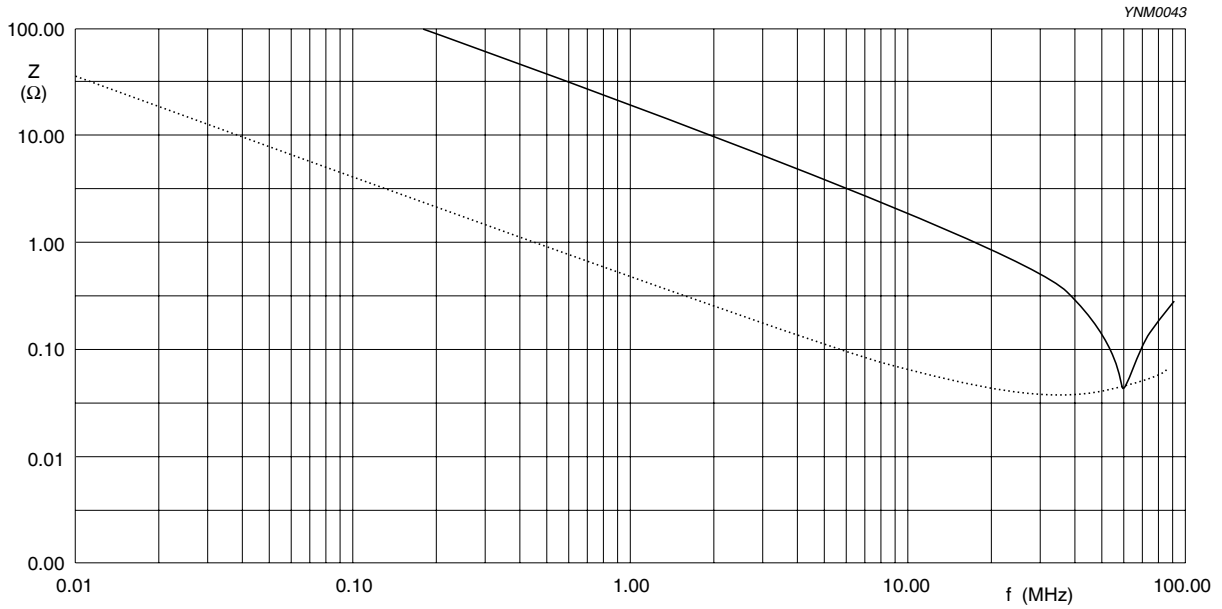

Fig. 4 Impedance ESR vs. frequency characteristics for multilayer chip capacitors

Size 0402 100 nF / 16 V
Solid lines: Impedance / Dotted lines: ESR

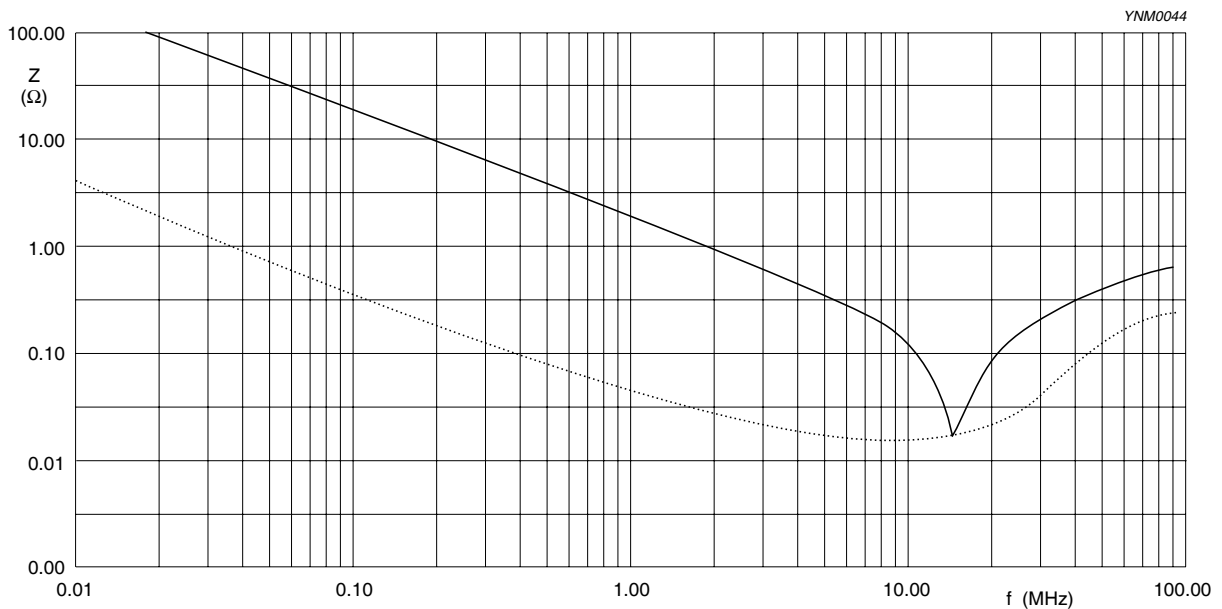

Fig. 5 Impedance ESR vs. frequency characteristics for multilayer chip capacitors

Size 0603 1 μ F / 16 V
Solid lines: Impedance / Dotted lines: ESR

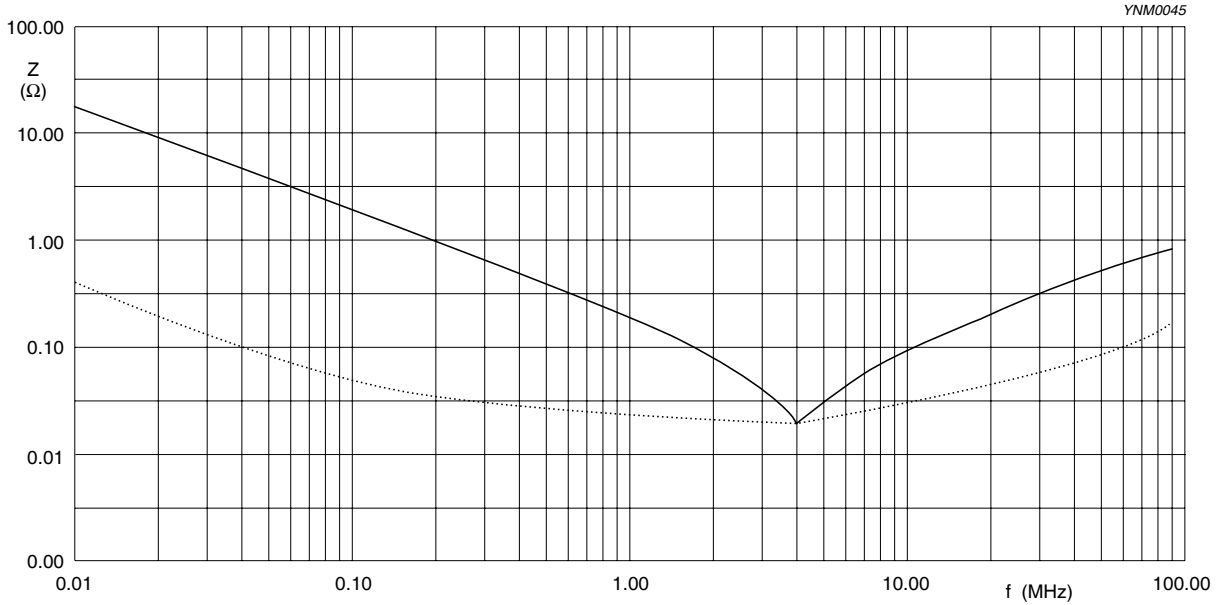

Fig. 6 Impedance ESR vs. frequency characteristics for multilayer chip capacitors

Size 0805 1 μ F / 16 V
Solid lines: Impedance / Dotted lines: ESR

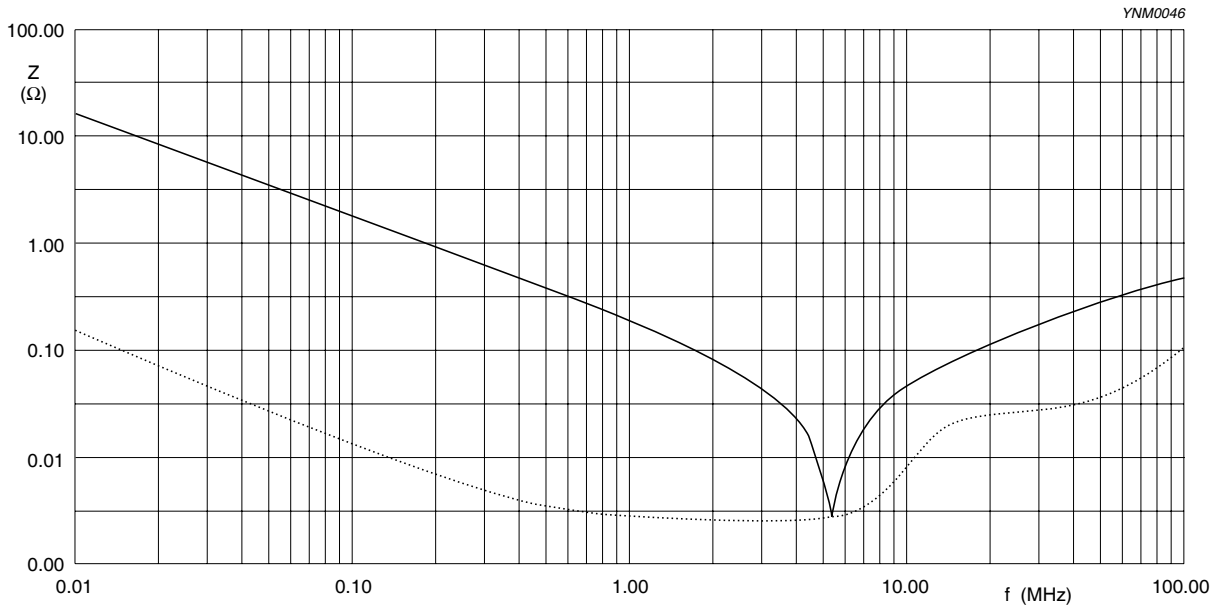

Fig. 7 Impedance ESR vs. frequency characteristics for multilayer chip capacitors

Size 1206 1 μ F / 25 V
Solid lines: Impedance / Dotted lines: ESR

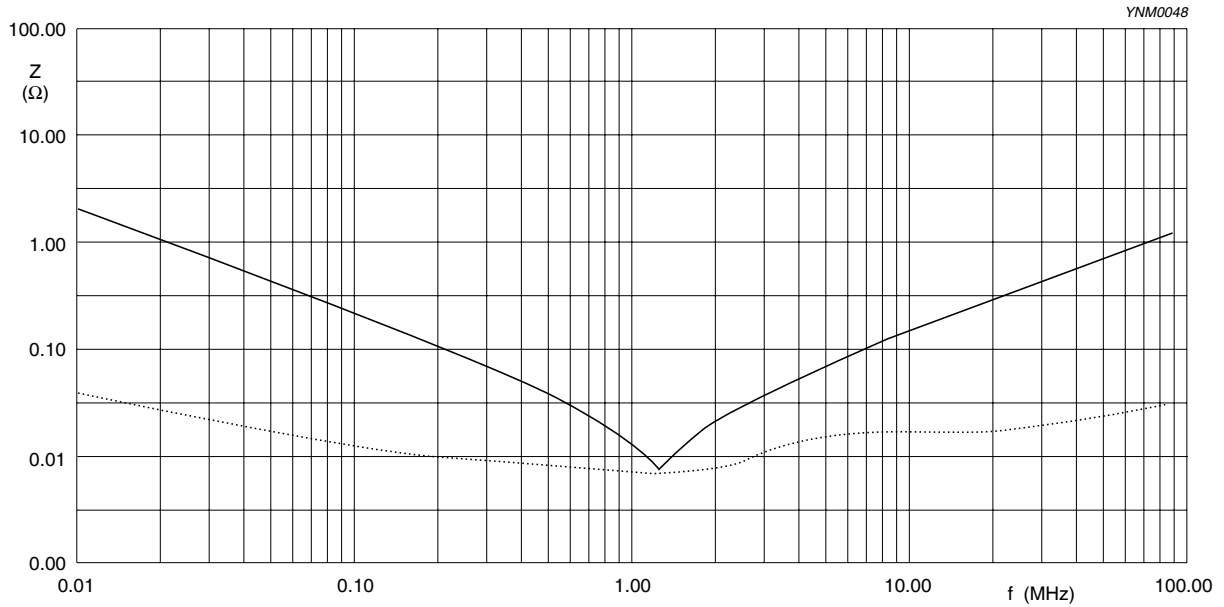

Fig. 8 Impedance ESR vs. frequency characteristics for multilayer chip capacitors

Size 1206 10 μ F / 10 V
Solid lines: Impedance / Dotted lines: ESR

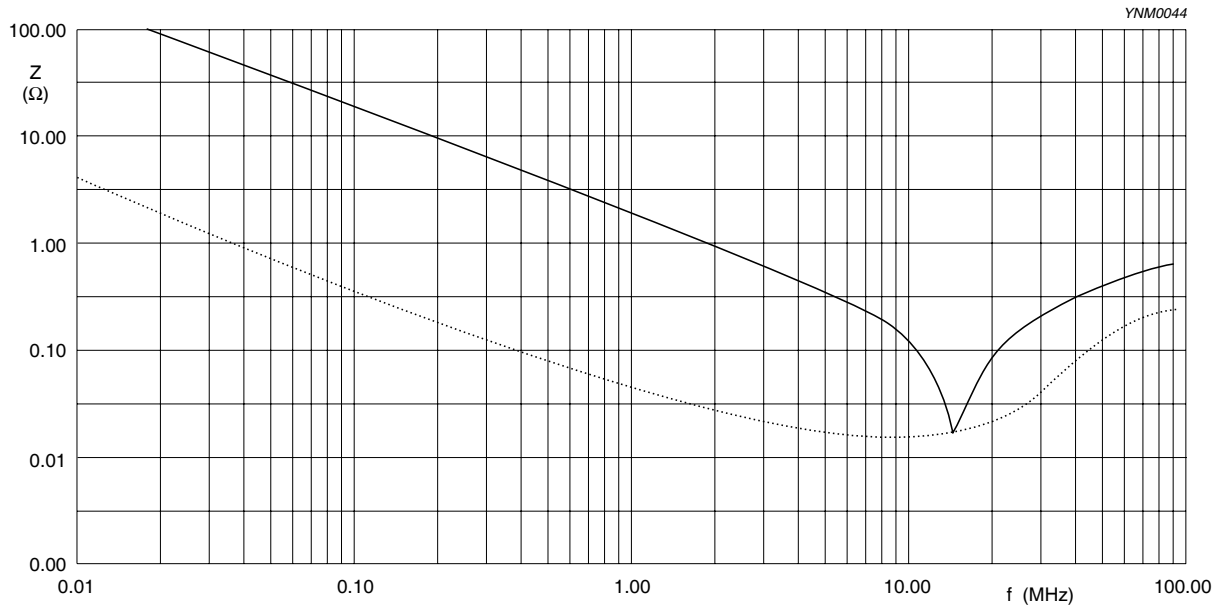

Fig. 9 Impedance ESR vs. frequency characteristics for multilayer chip capacitors

SOLDERING RECOMMENDATION

Table 8

SOLDERING METHOD	SIZE				
	0402	0603	0805	1206	≥ 1210
Reflow	≥ 0.1 μF	≥ 1.0 μF	≥ 2.2 μF	≥ 4.7 μF	Reflow only
Reflow/Wave	< 0.1 μF	< 1.0 μF	< 2.2 μF	< 4.7 μF	---

TESTS AND REQUIREMENTS

Table 9 Test procedures and requirements

TEST	TEST METHOD	PROCEDURE	REQUIREMENTS
Mounting	IEC 60384-21/22	4.3 The capacitors may be mounted on printed-circuit boards or ceramic substrates	No visible damage
Visual Inspection and Dimension Check	4.4	Any applicable method using × 10 magnification	In accordance with specification
Capacitance ⁽¹⁾	4.5.1	Class 2: At 20 °C, 24 hrs after annealing f = 1 KHz for C ≤ 10 μF, rated voltage > 6.3 V, measuring at voltage 1 V _{rms} at 20 °C f = 1 KHz, for C ≤ 10 μF, rated voltage ≤ 6.3 V, measuring at voltage 0.5 V _{rms} at 20 °C f = 120 Hz for C > 10 μF, measuring at voltage 0.5 V _{rms} at 20 °C	Within specified tolerance
Dissipation Factor (D.F.) ⁽¹⁾	4.5.2	Class 2: At 20 °C, 24 hrs after annealing f = 1 KHz for C ≤ 10 μF, rated voltage > 6.3 V, measuring at voltage 1 V _{rms} at 20 °C f = 1 KHz, for C ≤ 10 μF, rated voltage ≤ 6.3 V, measuring at voltage 0.5 V _{rms} at 20 °C f = 120 Hz for C > 10 μF, measuring at voltage 0.5 V _{rms} at 20 °C	In accordance with specification
Insulation Resistance	4.5.3	At U _r (DC) for 1 minute	In accordance with specification

NOTE:

1. For individual product specification, please contact local sales.

TEST	TEST METHOD	PROCEDURE	REQUIREMENTS
Temperature Characteristic	IEC 60384-21/22 4.6	Class 2: Between minimum and maximum temperature X7R: -55 °C to +125 °C Normal Temperature: 20 °C	<p><General Purpose series> ΔC/C Class 2: X7R: ±15%</p> <p><High Capacitance series> ΔC/C Class 2: X7R: ±15%</p>
Adhesion	4.7	A force applied for 10 seconds to the line joining the terminations and in a plane parallel to the substrate	Force size ≥ 0603: 5N size = 0402: 2.5N size = 0201: 1N
Bond Strength of Plating on End Face	4.8	Mounting in accordance with IEC 60384-22 paragraph 4.3 Conditions: bending 1 mm at a rate of 1 mm/s, radius jig 340 mm	<p>No visible damage</p> <hr/> <p><General Purpose series> ΔC/C Class2: X7R: ±10%</p> <p><High Capacitance series> ΔC/C Class2: X7R: ±10%</p>
Resistance to Soldering Heat	4.9	Precondition: 150 +0/-10 °C for 1 hour, then keep for 24 ± 1 hours at room temperature Preheating: for size ≤ 1206: 120 °C to 150 °C for 1 minute Preheating: for size >1206: 100 °C to 120 °C for 1 minute and 170 °C to 200 °C for 1 minute Solder bath temperature: 260 ± 5 °C Dipping time: 10 ± 0.5 seconds Recovery time: 24 ± 2 hours	<p>Dissolution of the end face plating shall not exceed 25% of the length of the edge concerned</p> <hr/> <p><General Purpose series> ΔC/C Class2: X7R: ±10%</p> <p><High Capacitance series> ΔC/C Class2: X7R: ±10%</p> <hr/> <p>D.F. within initial specified value R_{ins} within initial specified value</p>

TEST	TEST METHOD	PROCEDURE	REQUIREMENTS
Solderability	IEC 60384-21/22 4.10	<p>Preheated to a temperature of 80 °C to 140 °C and maintained for 30 seconds to 60 seconds.</p> <p>Test conditions for lead containing solder alloy Temperature: 235 ±5 °C Dipping time: 2 ±0.2 seconds Depth of immersion: 10 mm Alloy Composition: 60/40 Sn/Pb Number of immersions: 1</p> <p>Test conditions for lead-free containing solder alloy Temperature: 245 ±5 °C Dipping time: 3 ±0.3 seconds Depth of immersion: 10 mm Alloy Composition: SAC305 Number of immersions: 1</p>	The solder should cover over 95% of the critical area of each termination
Rapid Change of Temperature	4.11	<p>Preconditioning: 150 +0/-10 °C for 1 hour, then keep for 24 ±1 hours at room temperature</p> <p>5 cycles with following detail: 30 minutes at lower category temperature 30 minutes at upper category temperature</p> <p>Recovery time 24 ±2 hours</p>	<p>No visual damage</p> <hr/> <p><General Purpose series> ΔC/C Class2: X7R: ±15%</p> <p><High Capacitance series> ΔC/C Class2: X7R: ±15%</p> <hr/> <p>D.F. meet initial specified value R_{1ns} meet initial specified value</p>

TEST	TEST METHOD	PROCEDURE	REQUIREMENTS
Damp Heat with U_r Load	IEC 60384-21/22 4.13	<ol style="list-style-type: none"> 1. Preconditioning, class 2 only: 150 \pm0/-10 °C /1 hour, then keep for 24 \pm1 hour at room temp 2. Initial measure: Spec: refer to initial spec C, D, IR 3. Damp heat test: 500 \pm12 hours at 40 \pm2 °C; 90 to 95% R.H. 1.0 U_r applied 4. Recovery: Class 2: 24 \pm2 hours 5. Final measure: C, D, IR <p>P.S. If the capacitance value is less than the minimum value permitted, then after the other measurements have been made the capacitor shall be preconditioned according to "IEC 60384 4.1" and then the requirement shall be met.</p>	<p>No visual damage after recovery</p> <hr/> <p><General Purpose series> $\Delta C/C$ Class2: X7R: \pm15% D.F. Class2: X7R: \leq 16V: \leq 7% \geq 25V: \leq 5%</p> <p>R_{ins} Class2: X7R: \geq 500 MΩ or $R_{ins} \times C_r \geq$ 25s whichever is less</p> <p><High Capacitance series> $\Delta C/C$ Class2: X7R: \pm20% D.F. Class2: X7R: 2 x initial value max</p> <p>R_{ins} Class2: X7R: 500 MΩ or $R_{ins} \times C_r \geq$ 25s whichever is less</p>

TEST	TEST METHOD	PROCEDURE	REQUIREMENTS
Endurance	IEC 60384- 21/22 4.14	1. Preconditioning, class 2 only: 150 +0/-10 °C /1 hour, then keep for 24 ±1 hour at room temp 2. Initial measure: Spec: refer to initial spec C, D, IR 3. Endurance test: Temperature: X7R: 125 °C Specified stress voltage applied for 1,000 hours: Applied 2.0 × U _r for general products Applied 1.5 × U _r for high cap. products 4. Recovery time: 24 ±2 hours 5. Final measure: C, D, IR P.S. If the capacitance value is less than the minimum value permitted, then after the other measurements have been made the capacitor shall be preconditioned according to "IEC 60384 4.1" and then the requirement shall be met.	No visual damage <hr/> <General Purpose series> ΔC/C Class2: X7R: ±15% D.F. Class2: X7R: ≤ 16V: ≤ 7% ≥ 25V: ≤ 5% R _{ins} Class2: X7R: ≥ 1,000 MΩ or R _{ins} × C _r ≥ 50s whichever is less <High Capacitance series> ΔC/C Class 2: X7R: ±20% D.F. Class 2: X7R: 2 × initial value max R _{ins} Class 2: X7R: 1,000 MΩ or R _{ins} × C _r ≥ 50s whichever is less
		Specified stress voltage applied for 1 minute U _r ≤ 100 V: series applied 2.5 U _r 100 V < U _r ≤ 200 V series applied (1.5 U _r + 100) 200 V < U _r ≤ 500 V series applied (1.3 U _r + 100) U _r > 500 V: 1.3 U _r I: 7.5 mA	No breakdown or flashover

REVISION HISTORY

REVISION	DATE	CHANGE NOTIFICATION	DESCRIPTION
Version 8	Oct 13, 2011	-	- Dimension updated
Version 7	Jan 13, 2011	-	- Dimension updated
Version 6	Oct 13, 2010	-	- Rated voltage of 0201 extend to 50 V - Capacitance range of 0201 X7R 6.3V to 16V extend to 100 pF - Capacitance range of 0805 X7R 10V extend to 10 μF - Capacitance range of 0805 X7R 50V extend to 1 μF - Capacitance range of 1210 X7R 10V extend to 22 μF - Figures of impedance ESR updated
Version 5	Jul 27, 2010	-	- Dimension on 0603 and 1206 case size updated
Version 4	Apr 21, 2010	-	- The statement of "Halogen Free" on the cover added - Dimension updated
Version 3	Oct 26, 2009	-	- Capacitance range of 0402 X7R 25 V extend to 100 nF
Version 2	May 11, 2009	-	- Product range updated
Version 1	Apr 24, 2009	-	- Ordering code updated
Version 0	Apr 15, 2009	-	- New datasheet for general purpose and high capacitance X7R series with RoHS compliant - Replace the "6.3V to 50V" part of pdf files: X7R_10V_9, X7R_16V-to-100V_9, X7R_16-to-500V_9, UP-X5R_X7R_HighCaps_6.3-to-25V_11, UY-X5R_X7R_HighCaps_6.3-to-25V_11 - Combine 0201 from pdf files: UP-NP0X5RX7RY5V_0201_6.3-to-50V_2 and UY-NPOX5RX7RY5V_0201_6.3-to-50V_2 - Define global part number - Description of "Halogen Free compliant" added - Test method and procedure updated