

Specifications

Insulation Resistance: 1,000MΩ min. at 500V DC
 Withstanding Voltage: 1,000V AC rms for 1 minute
 Contact Resistance: 30mΩ max. at 10mA
 Current Rating: 1A
 Operating Temp. Range: -20°C to +105°C
 Soldering Temperature: 260°C / 10 sec.

Materials and Finish

Housing: PBT, glass filled UL94V-0 rated
 Latch: PA, glass filled UL94V-0 rated
 Contacts: Phosphor Bronze
 Plating: Contacts - Au over Nickel
 Solder Terminals - Flash Au over Nickel

Features

- 2.54 mm contact pitch connectors for MIL standard
- Variations include latch header plugs, box header plugs, and flat cable sockets
- Two types (short latch and middle latch) available

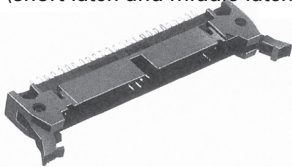

Outline Dimensions

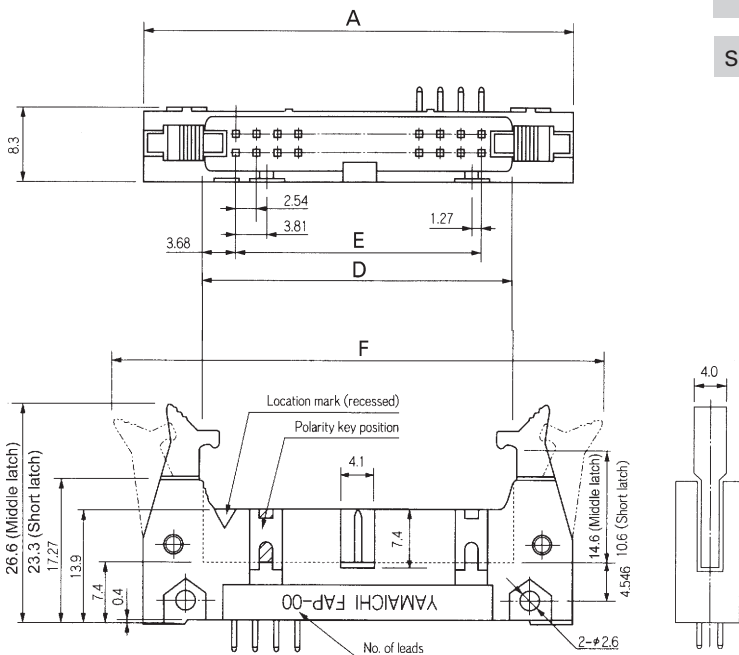

Part Number (Details)

FAP - 3401 - 1 1 0 * - 2 - 0 * F

Series (plug)

No. of Leads

Housing Types:
 1 = MIL Standard key slot
 (plus central key slot on 16 or more leads)
 2 = Central key slot (10 leads only)

Latch Types:
 1 = Short Latches (Height = 23.3mm, mating socket is without strain relief)
 2 = Middle Latches (Height = 26.6mm, mating socket is with strain relief)

Terminal Types:
 2 = Right Angle Solder Dip
 4 = Straight Solder Dip

Housing Colour: 1 = Black, 2 = Blue (Standard)

0 = Mating Cables (1.27 pitch):
 AWG 28 Stranded Wire or AWG 30 Solid Wire

Contact Plating: A = Gold (0.76µm over Ni 2.5~4.5µm)
 B = Gold (0.3µm over Ni 2.5~4.5µm)

Solder Terminal Plating: F = Flash Au over Ni

Contact Details and Terminal Types

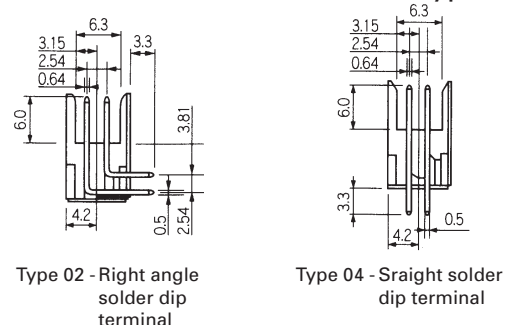

Recommended PCB Layout

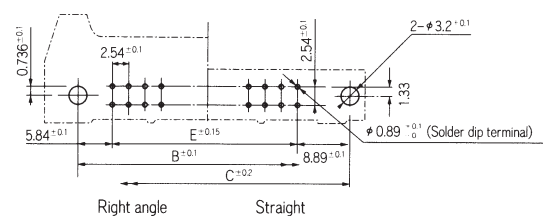

Standard types see table.

For other versions please contact Yamaichi, minimum order quantity may be required

Part Number	No. of Leads	A	B	C	D	E	F (max.)
FAP-1001-2104-2-0AF	10	32.00	21.84	27.94	17.52	10.16	48.52
FAP-1001-2104-2-0BF	10	32.00	21.84	27.94	17.52	10.16	48.52
FAP-1001-2202-2-0AF	10	32.00	21.84	27.94	17.52	10.16	48.52
FAP-1001-2202-2-0BF	10	32.00	21.84	27.94	17.52	10.16	48.52
FAP-1001-2204-2-0AF	10	32.00	21.84	27.94	17.52	10.16	48.52

Cont'd

Series FAP

MIL Std. Latch Header Plug, (2.54mm Pitch)

Part Numbers (cont'd)

Part Number	No. of Leads	A	B	C	D	E	F (max.)
FAP-1001-2204-2-0BF	10	32.00	21.84	27.94	17.52	10.16	48.52
FAP-1401-1104-2-0AF	14	37.20	26.84	32.12	23.34	15.24	52.24
FAP-1401-1202-2-0BF	14	37.20	26.84	32.12	23.34	15.24	52.24
FAP-1401-1204-2-0AF	14	37.20	26.84	32.12	23.34	15.24	52.24
FAP-1401-1204-2-0BF	14	37.20	26.84	32.12	23.34	15.24	52.24
FAP-1601-1104-2-0AF	16	39.62	29.46	35.56	25.14	17.78	56.14
FAP-1601-1104-1-0BF	16	39.62	29.46	35.56	25.14	17.78	56.14
FAP-1601-1104-2-0AF	16	39.62	29.46	35.56	25.14	17.78	56.14
FAP-1601-1104-2-0BF	16	39.62	29.46	35.56	25.14	17.78	56.14
FAP-1601-1202-2-0AF	16	39.62	29.46	35.56	25.14	17.78	56.14
FAP-1601-1202-2-0BF	16	39.62	29.46	35.56	25.14	17.78	56.14
FAP-1601-1204-1-0BF	16	39.62	29.46	35.56	25.14	17.78	56.14
FAP-1601-1204-2-0BF	16	39.62	29.46	35.56	25.14	17.78	56.14
FAP-2001-1102-1-0BF	20	44.70	34.54	40.64	30.22	22.86	61.22
FAP-2001-1104-2-0AF	20	44.70	34.54	40.64	30.22	22.86	61.22
FAP-2001-1104-2-0BF	20	44.70	34.54	40.64	30.22	22.86	61.22
FAP-2001-1202-2-0AF	20	44.70	34.54	40.64	30.22	22.86	61.22
FAP-2001-1202-2-0BF	20	44.70	34.54	40.64	30.22	22.86	61.22
FAP-2001-1204-2-0AF	20	44.70	34.54	40.64	30.22	22.86	61.22
FAP-2001-1204-2-0BF	20	44.70	34.54	40.64	30.22	22.86	61.22
FAP-2601-1102-2-0AF	26	52.32	42.16	48.26	37.84	30.48	68.84
FAP-2601-1104-2-0AF	26	52.32	42.16	48.26	37.84	30.48	68.84
FAP-2601-1104-2-0BF	26	52.32	42.16	48.26	37.84	30.48	68.84
FAP-2601-1202-2-0AF	26	52.32	42.16	48.26	37.84	30.48	68.84
FAP-2601-1202-2-0BF	26	52.32	42.16	48.26	37.84	30.48	68.84
FAP-2601-1204-2-0AF	26	52.32	42.16	48.26	37.84	30.48	68.84
FAP-2601-1204-2-0BF	26	52.32	42.16	48.26	37.84	30.48	68.84
FAP-3001-1202-2-0BF	30	57.40	47.24	53.42	42.92	35.56	73.92
FAP-3401-1102-2-0AF	34	62.48	52.32	58.42	48.00	40.64	79.00
FAP-3401-1102-2-0BF	34	62.48	52.32	58.42	48.00	40.64	79.00
FAP-3401-1104-2-0AF	34	62.48	52.32	58.42	48.00	40.64	79.00
FAP-3401-1202-2-0AF	34	62.48	52.32	58.42	48.00	40.64	79.00
FAP-3401-1202-2-0BF	34	62.48	52.32	58.42	48.00	40.64	79.00
FAP-3401-1204-2-0AF	34	62.48	52.32	58.42	48.00	40.64	79.00
FAP-3401-1204-2-0BF	34	62.48	52.32	58.42	48.00	40.64	79.00
FAP-4001-1102-2-0AF	40	70.10	59.94	66.04	55.62	48.26	86.62
FAP-4001-1102-2-0BF	40	70.10	59.94	66.04	55.62	48.26	86.62
FAP-4001-1104-2-0AF	40	70.10	59.94	66.04	55.62	48.26	86.62
FAP-4001-1202-2-0AF	40	70.10	59.94	66.04	55.62	48.26	86.62
FAP-4001-1202-2-0BF	40	70.10	59.94	66.04	55.62	48.26	86.62
FAP-4001-1204-2-0AF	40	70.10	59.94	66.04	55.62	48.26	86.62
FAP-5001-1104-2-0AF	50	82.80	72.64	78.74	68.32	60.96	99.32
FAP-5001-1202-2-0AF	50	82.80	72.64	78.74	68.32	60.96	99.32
FAP-5001-1202-2-0BF	50	82.80	72.64	78.74	68.32	60.96	99.32
FAP-5001-1204-2-0AF	50	82.80	72.64	78.74	68.32	60.96	99.32
FAP-5001-1204-2-0BF	50	82.80	72.64	78.74	68.32	60.96	99.32
FAP-6001-1202-2-0BF	60	95.50	85.34	91.44	81.02	73.66	112.02
FAP-6001-1204-2-0AF	60	95.50	85.34	91.44	81.02	73.66	112.02
FAP-6001-1204-2-0BF	60	95.50	85.34	91.44	81.02	73.66	112.02
FAP-6401-1102-2-0AF	64	100.60	90.42	96.52	86.10	78.74	117.10
FAP-6401-1104-1-0BF	64	100.60	90.42	96.52	86.10	78.74	117.10
FAP-6401-1104-2-0AF	64	100.60	90.42	96.52	86.10	78.74	117.10
FAP-6401-1202-2-0AF	64	100.60	90.42	96.52	86.10	78.74	117.10
FAP-6401-1202-2-0BF	64	100.60	90.42	96.52	86.10	78.74	117.10
FAP-6401-1204-1-0BF	64	100.60	90.42	96.52	86.10	78.74	117.10
FAP-6401-1204-2-0AF	64	100.60	90.42	96.52	86.10	78.74	117.10

2.54mm Board-to-Cable Connectors

Specifications

Insulation Resistance: 1,000MΩ min. at 500V DC
 Withstanding Voltage: 1,000V AC rms for 1 minute
 Contact Resistance: 30mΩ max. at 10mA
 Current Rating: 1A
 Operating Temp. Range: -20°C to +105°C
 Soldering Temperature: 260°C / 10 sec.



Materials and Finish

Housing: PBT, glass filled UL94V-0 rated
 Contacts: Copper Alloy
 Plating: Contacts - Gold over Nickel
 Solder Terminals - Flash Au over Ni



Features

- 2.54mm contact pitch connectors for MIL standard
- Variations include latch header plugs, box header plugs, and flat cable sockets

Part Number (Details)

FAP - 34 - 08 - * - 1 - 0 * F

Series (plug)	
No. of Leads	
Terminal Type:	
2 = Right Angle Solder Dip	
4 = Straight Solder Dip	
Housing Colour: 1 = Black, 2 = Blue	
Contact Plating:	
A = Gold (0.76μm over Nickel 2.5-4.5μm)	
B = Gold (0.3μm over Nickel 2.5-4.5μm)	
F = Flash Au over Ni	

Outline Dimensions

Straight Solder Dip Type

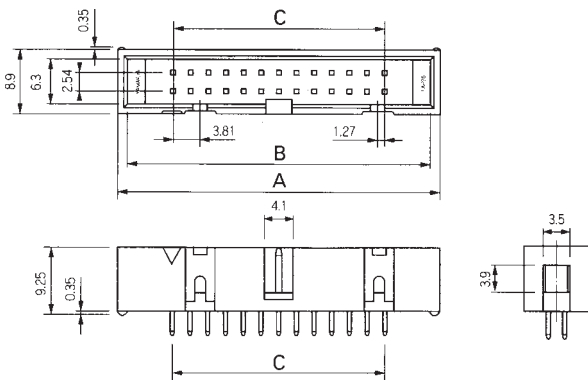

Outline Dimensions

Right Angle Solder Dip Type

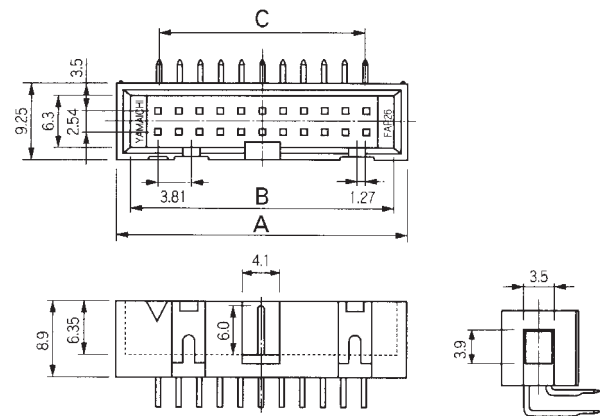

Contact Details

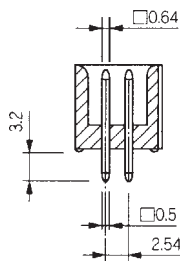

Contact Details

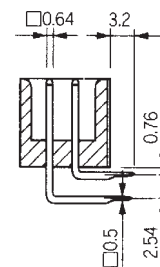

Recommended PCB Layout

Top View from Plug

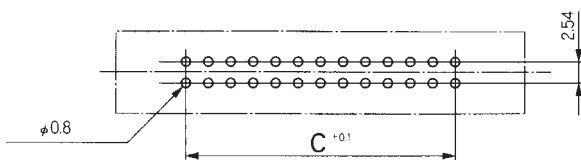

Recommended PCB Layout

Top View from Plug

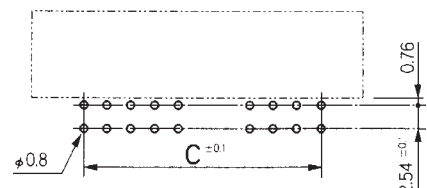

Standard types see table.

For other versions please contact Yamaichi, minimum order quantity may be required

Part Numbers

Part No.	No. of Leads	A	B	C
FAP-10-08-2-1-0BF	10	20.30	17.90	10.16
FAP-10-08-2-2-0AF	10	20.30	17.90	10.16
FAP-10-08-2-2-0BF	10	20.30	17.90	10.16
FAP-10-08-4-1-0BF	10	20.30	17.90	10.16
FAP-10-08-4-2-0AF	10	20.30	17.90	10.16
FAP-10-08-4-2-0BF	10	20.30	17.90	10.16
FAP-14-08-2-2-0AF	14	25.40	23.00	15.24
FAP-14-08-2-2-0BF	14	25.40	23.00	15.24
FAP-14-08-2-2-0BF	14	25.40	23.00	15.24
FAP-14-08-4-1-0BF	14	25.40	23.00	15.24
FAP-14-08-4-2-0AF	14	25.40	23.00	15.24
FAP-14-08-4-2-0BF	14	25.40	23.00	15.24
FAP-16-08-2-1-0BF	16	27.90	25.50	17.78
FAP-16-08-2-2-0AF	16	27.90	25.50	17.78
FAP-16-08-2-2-0BF	16	27.90	25.50	17.78
FAP-16-08-4-1-0BF	16	27.90	25.50	17.78
FAP-16-08-4-2-0AF	16	27.90	25.50	17.78
FAP-16-08-4-2-0BF	16	27.90	25.50	17.78
FAP-20-08-2-2-0AF	20	33.00	30.60	22.86
FAP-20-08-2-2-0BF	20	33.00	30.60	22.86
FAP-20-08-4-2-0AF	20	33.00	30.60	22.86
FAP-20-08-4-2-0BF	20	33.00	30.60	22.86
FAP-26-08-2-2-0AF	26	40.60	38.20	30.48
FAP-26-08-2-2-0BF	26	40.60	38.20	30.48
FAP-26-08-4-1-0BF	26	40.60	38.20	30.48
FAP-26-08-4-2-0AF	26	40.60	38.20	30.48
FAP-26-08-4-2-0BF	26	40.60	38.20	30.48
FAP-34-08-2-2-0AF	34	50.80	48.40	40.64
FAP-34-08-2-2-0BF	34	50.80	48.40	40.64
FAP-34-08-4-2-0AF	34	50.80	48.40	40.64
FAP-34-08-4-2-0BF	34	50.80	48.40	40.64
FAP-40-08-2-2-0AF	40	58.40	56.00	48.26
FAP-40-08-2-2-0BF	40	58.40	56.00	48.26
FAP-40-08-4-2-0AF	40	58.40	56.00	48.26
FAP-40-08-4-2-0BF	40	58.40	56.00	48.26
FAP-50-08-2-2-0BF	50	71.10	68.70	60.96
FAP-50-08-4-2-0AF	50	71.10	68.70	60.96
FAP-50-08-4-2-0BF	50	71.10	68.70	60.96
FAP-64-08-4-2-0AF	64	88.90	86.50	78.74