

Quick start guide UP² Chassis - EP-CHUPSMTVAUPS



Parts List

- Top cover with Logo Plate 1pc
- Middle Case 1pc
- Bottom Base 1pc
- Vesa Mount Plate 1pc
- Hex Standoff 4pcs
- Screw 10pcs

Not included with the kit, you may need to prepare:

- UP squared board.
- Small screwdriver.

bridge
the gap

**As always, go check out up-community.org
for support and more information about your UP board**

Assembly step

1. Depart the top cover and middle case in the **diagonal direction**.

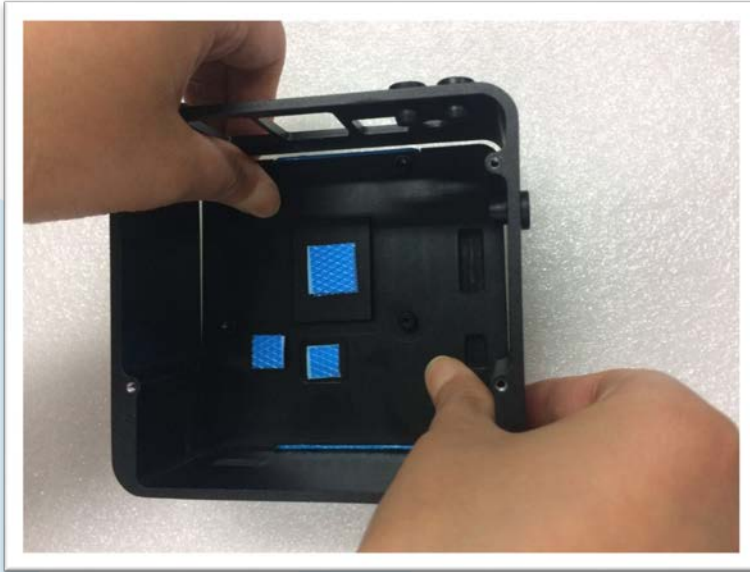

2. Put the top cover on the operation desk

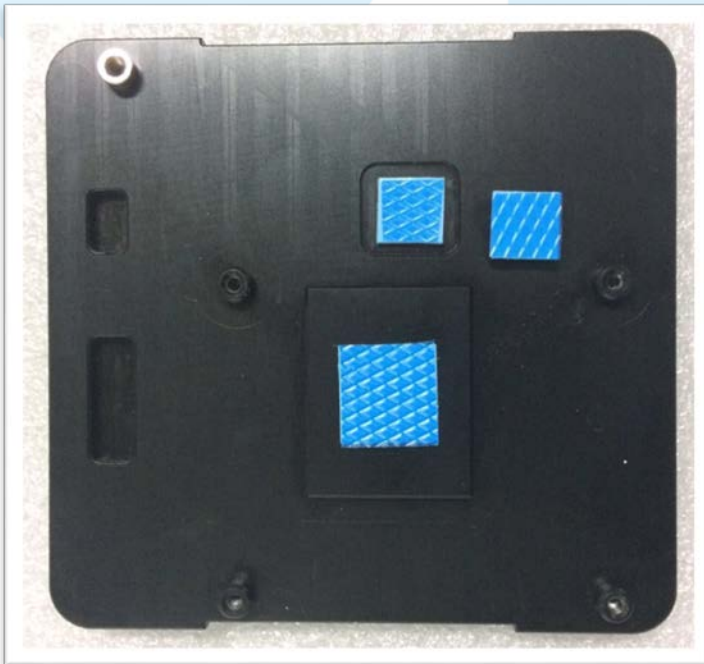

3. Peel of the blue protection film of thermal pad

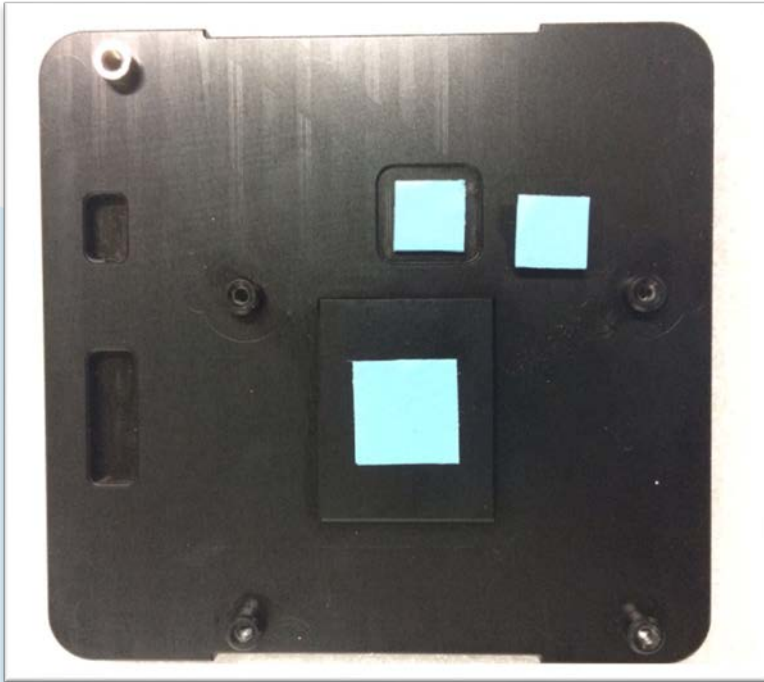

4. Remove the 4 screws to release the heatsink from the UP2 board

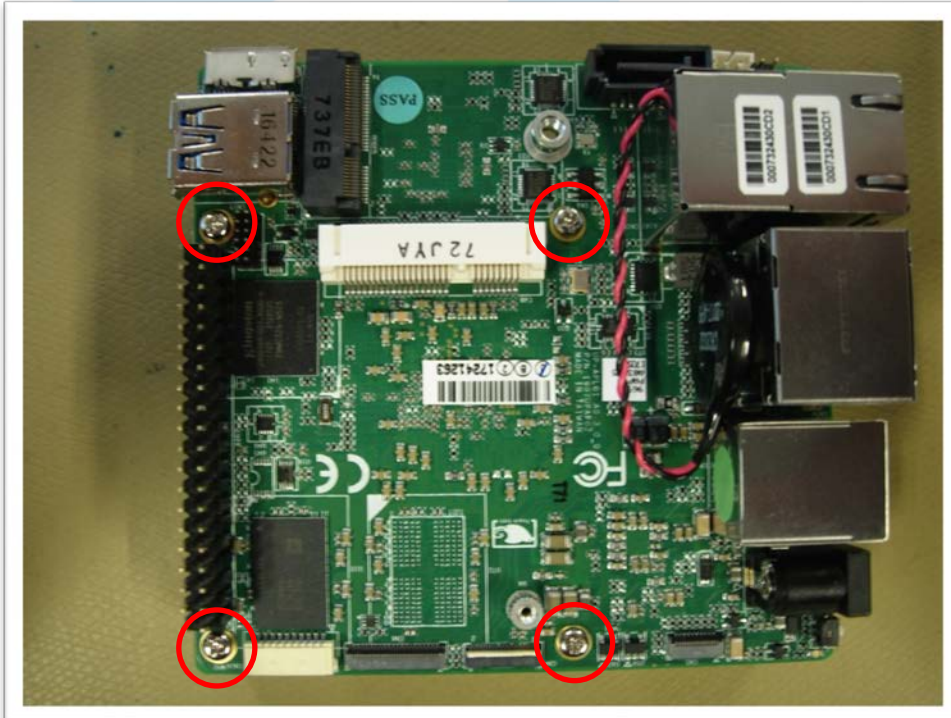

5. Carefully pull the cooler from the board

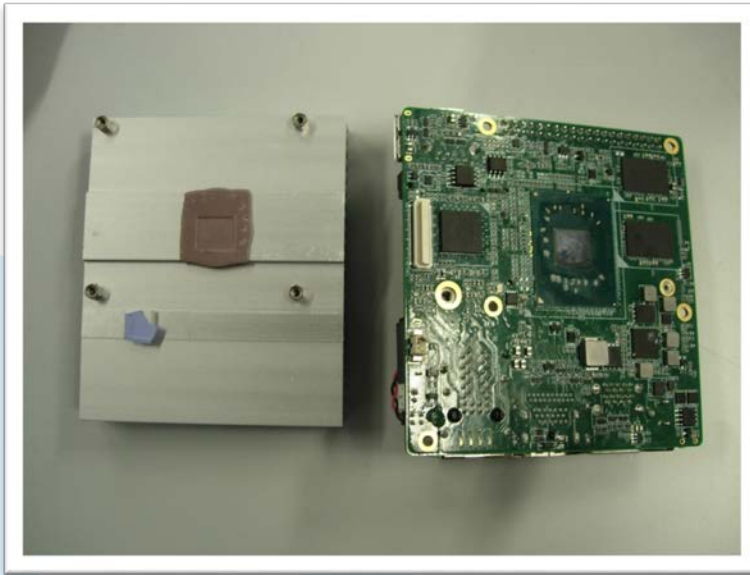

6. Start to screw 4 Hex Stand-offs on the PCB.



7. Fasten the PCB with top cover by the hex standoffs through the threads nut on the top cover.

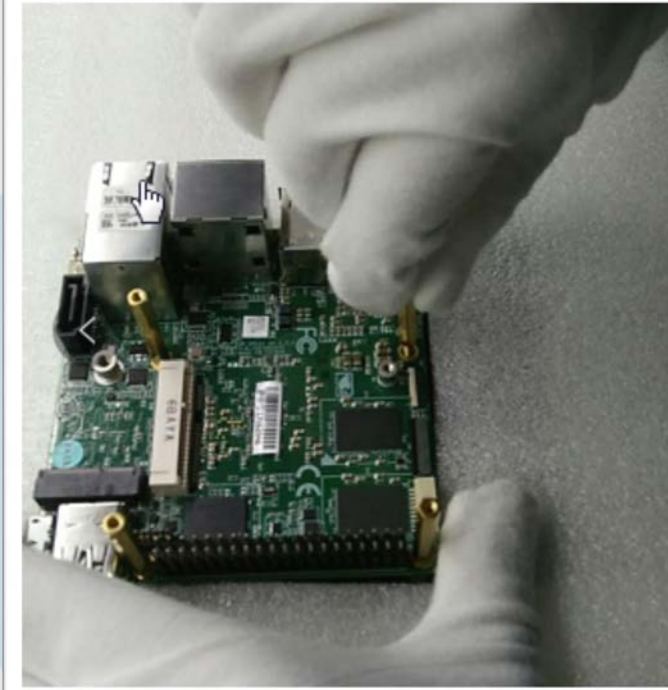

8. Place the board into the middle case, check well with the 4 sides exactly that match the IO sides.



9. Fasten the bottom plate with PCB by screws x 4pcs

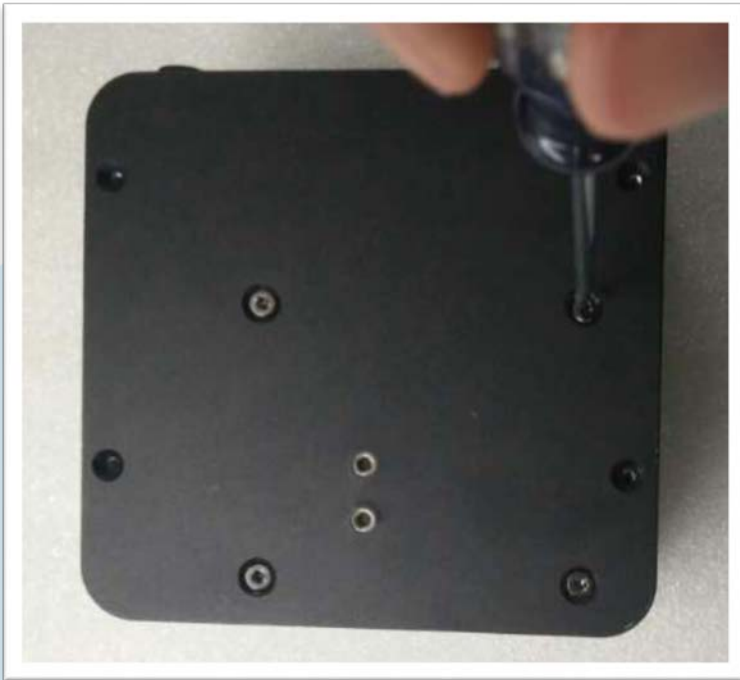

10. Fasten the bottom plate with top cover by screws x 4pcs



11. Fasten the Vesa Mount with pre-assembled case by screws x 2pcs



Exploded view including all components

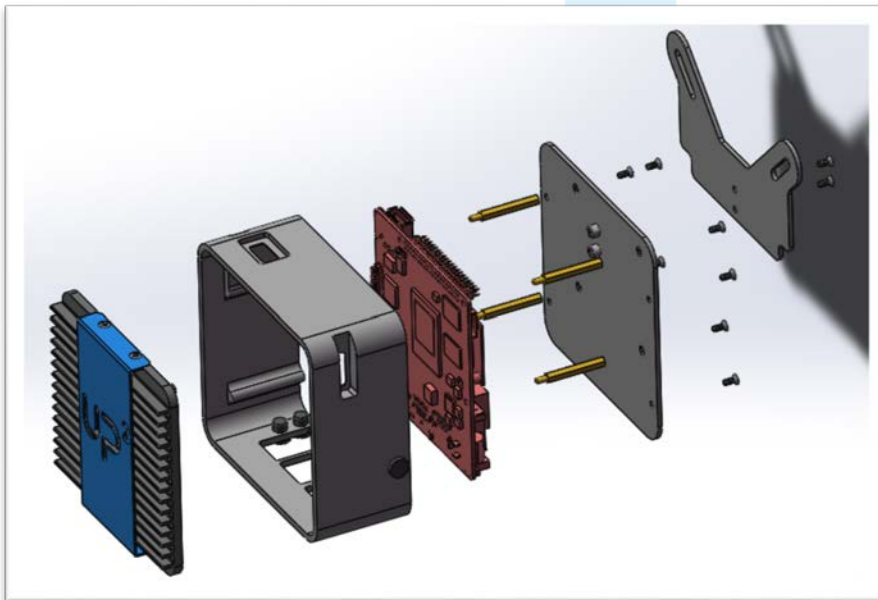

ge
gap

X-ON Electronics

Largest Supplier of Electrical and Electronic Components

Click to view similar products for [Modules Accessories](#) category:

Click to view products by [Aaeon](#) manufacturer:

Other Similar products are found below :

[7010-0001](#) [AX98219](#) [A1UL8RISER](#) [F1UJPMICRISER](#) [FHW1U16RISER](#) [20-101-0440](#) [MBCDROM](#) [AX61221TM](#) [VM-105](#) [EA](#)
[CARREDIPTFT02](#) [RK-210E-B](#) [E226171106](#) [88606200030E](#) [SI-HDMI-EDID-EM](#) [MIC-75M13-00A1E](#) [FPM-1000T-SMKE](#) [AMK-R004E](#)
[96FMCF-ST2ADAPTER1](#) [AHWKPTP12GBGB](#) [AXXSTCPUCAR](#) [FPK-07-R10](#) [Mini Din 6P to 6P HARNESS](#) [FPF1320 POWER](#)
[MULTIPLEXER CARRIER](#) [881261510A0E](#) [AXXP3SWX08080](#) [conga-B7XD/CSP-Cu-B](#) [881281021A0E](#) [HFT for mounting KIT](#)
[FN928X_FN929X](#) [BB-MH112-1A](#) [15100600](#) [9-5000-1116](#) [BKCMCR1ABB](#) [70763](#) [98R3612003E](#) [881261910A0E](#) [106897](#) [48222R](#) [4D](#)
[ARDUINO ADAPTOR SHIELD II](#) [20926110901](#) [PYCASE GREEN](#) [PYCASE BLUE](#) [FP15072_ZORYA-SC-HEKLA](#) [20952000004](#)
[20953000007](#) [DP-DVI-R10](#) [575-BBIS](#) [RACK-220GW/A130B](#) [492-BBKM](#) [IP411](#) [70760](#)