

UPC-PLUS CPU Board Quick Installation Guide

CN REVISION HISTORY

Revision	Date	Comments
A0.1	2018/01/08	Initial Version
A0.2	2018/04/16	Add CN14 description
A0.3	2018/08/23	Change Pin11 to BUF_PLT_RST# of DOCKING I (CN10) Change Pin9 Pin10 to NC of DOCKING II (CN12) Change Pin11 to DDI0_HPD of DOCKING II (CN12) Change Pin92 to PMU_RSTBTN_N of DOCKING II (CN12) ※Change on A0.4 board version or late version
A0.4	2018/10/12	Change Pin85 to GPIO_2 of DOCKING I (CN10) Change Pin87 to GPIO_3 of DOCKING I (CN10) ※Change on A0.4 board version or late version
A0.5	2018/10/17	Correction CN12.44 pin define
A0.6	2018/10/29	Modify signal level of CN10 and CN12.
A0.7	2019/03/08	1.Modify CN1 FAN pin define. 2.Modify CN3 CN7 connector functional description.
A0.8	2019/03/14	Modify CN12.93 pin define.
A0.9	2019/03/20	Correct the Docking I II pin define.
A1.0	2019/07/12	1.Update Board Layout 2.Correct define of DP pin14 3.Modify HDMI1_CEC_D voltage level 4.Correct CN11 pin define

Table of Content

1. UPC-PLUS Board Layout	-4-
2. Connector References	-5-
3. Connector Pin Assignments.....	-6-

1. UPC-PLUS Board Layout

Top side

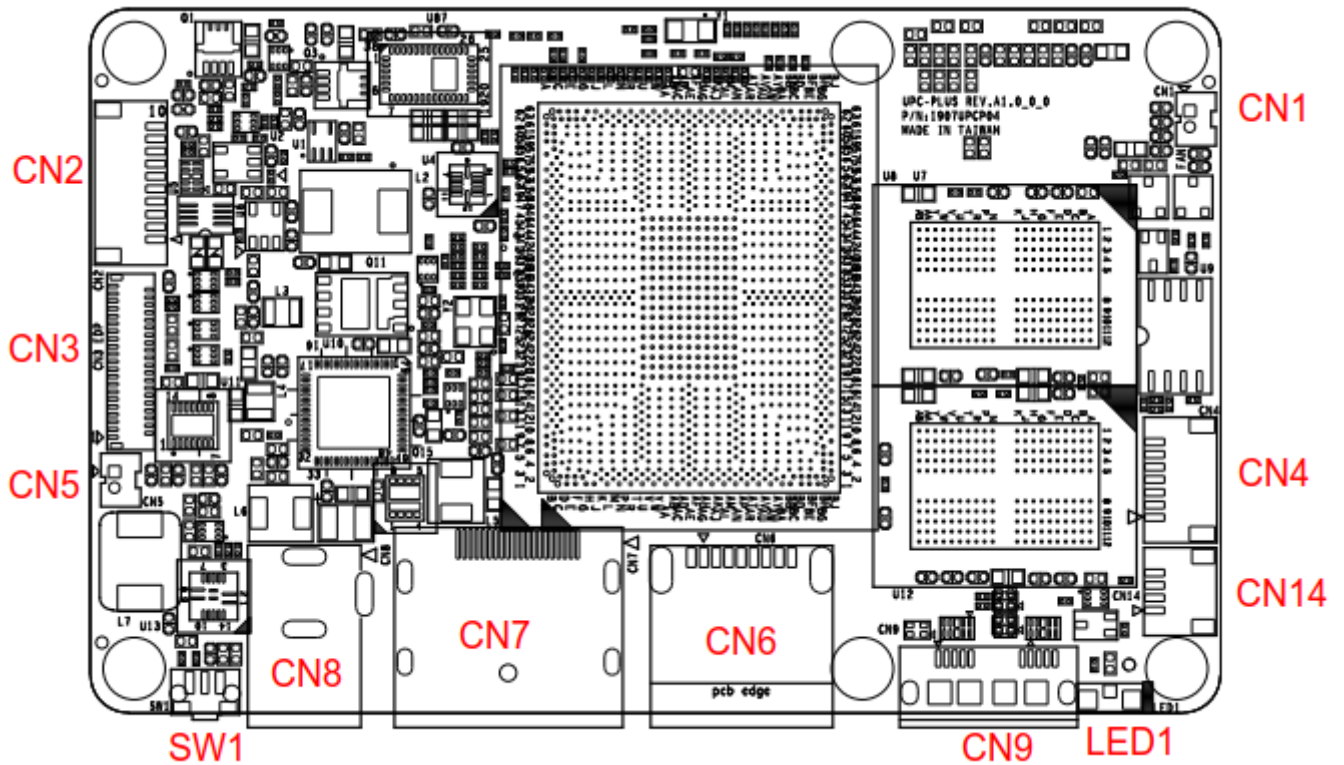

Bottom side

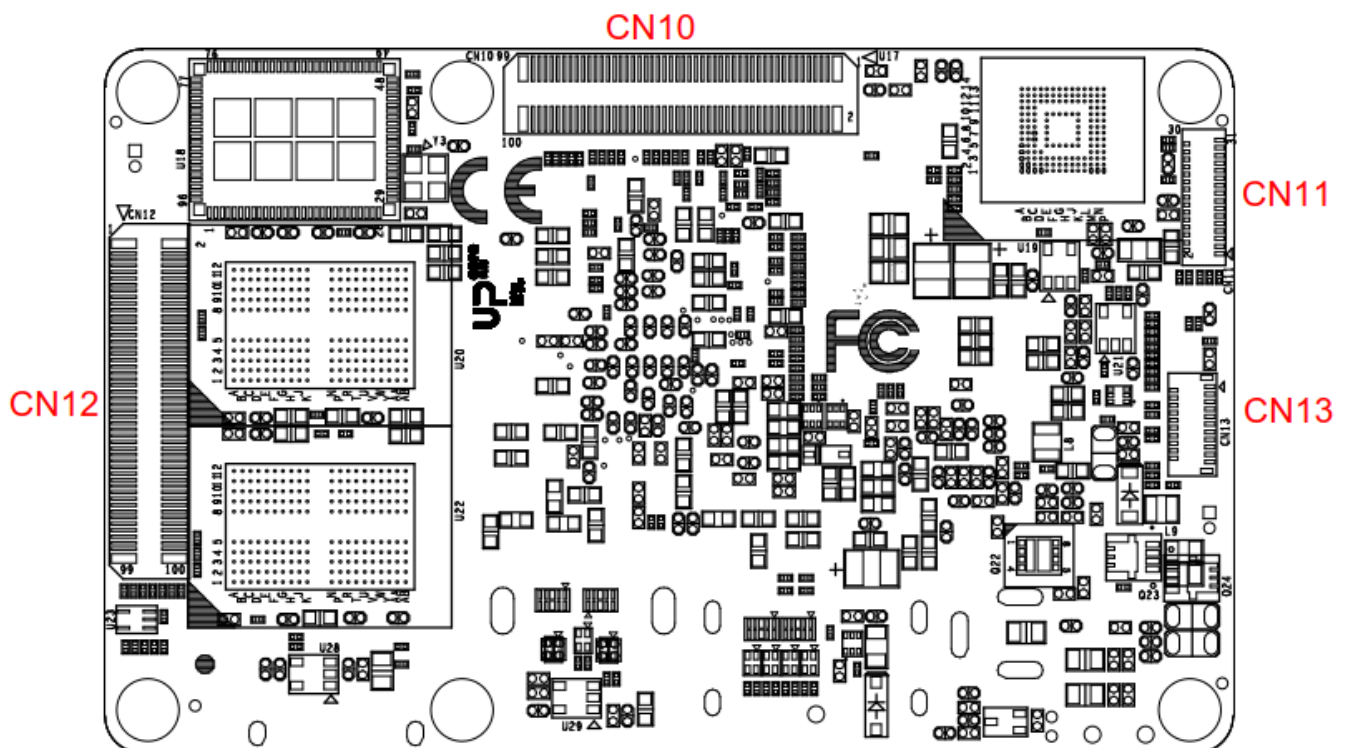

2. Connector References

Connector Index

Reference Designation	Functional Description	Connector Type
SW1	PWR button	(TF)Push Button Switch.3P.12VDC.50mA.500mohm.Black.SMD.HCH.PTS-099
CN1	FAN	(TF)WAFER BOX.2P.180D(M).DIP.1.25mm.PINREX.712-71-02TW01
CN2	Internal USB UART	(TF)Wafer Box.10P.90D(M).SMD.1.0mm.PINREX.710-74-10TWR6
CN3	eDP	(TF)FPC/FFC Conn.41P.90D(F).SMD.0.6mm.Hirose.FH35C-41S-0.3SHW(50)
CN4	BIOS PROGRAM	(TF)WAFER BOX.7P.180D(M).SMD.1.0mm.W/Cap.PINREX.710-73-07TWE6
CN5	RTC	(TF)WAFER BOX.2P.180D(M).DIP.1.25mm.PINREX.712-71-02TW01
CN6	USB3.0	(TF)USB3.0 Connector.Single Port. Type A.9P.90D(F).SMD.Trontek.930-00406-A91-21
CN7	DP	(TF)DisplayPort CON.20P.90D.(F).SMD.FOXCONN.3VD51203-D7JJ-7H
CN8	Power Input	(TF)DC Power Jack.3P.90D(M).DIP.2.0mm.COXOC.416AEWTJ02004PA
CN9	Micro USB3.0	(TF)Micro USB 3.0 Conn..10P.90D(M).SMD.B-type.ATTEND.209E-BE01
CN10	DOCKING I	(TF)Board-Board Connector.100P.180D(M).Pitch=0.5mm.H=5.3mm.SMD.Panasonic.AXK6S00647YG
CN11	MIPI CSI	(TF)FPC/FFC Conn..31P.90D(F).SMD.0.3mm.Dual Contact.Panasonic.AYF333135
CN12	DOCKING II	(TF)Board-Board Connector.100P.180D(M).Pitch=0.5mm.H=5.3mm.SMD.Panasonic.AXK6S00647YG
CN13	MIPI CSI 2CH	(TF)FPC/FFC Conn.21P.90D(F).SMD.0.6mm.Hirose.FH35C-21S-0.3SHW(50)
CN14	PWR Button Pin Header	(TF)WAFER BOX.2P.90D(M).SMD.1.0mm.W/Cap.PINREX.710-74-02TWR6
LED1	SYSTEM Indicator	(TF)LED.3.0*1.0*1.0mm. Blue.SMD.LITEON. LTST-S320TBKT

3. Connector Pin Assignments

SW1: PWR button

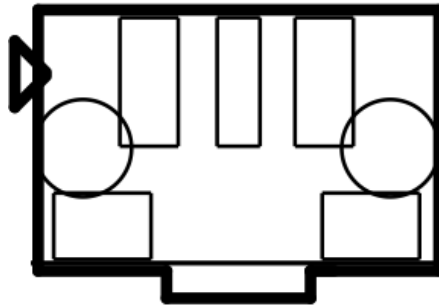

Pin	Signal Description	Pin	Signal Description	Pin	Signal Description
1	GND	2	PMU_PWRBTN_N	3	GND

CN1: FAN

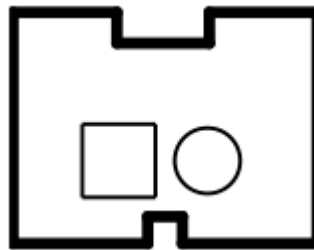

Pin	Signal Description	Pin	Signal Description
1	FAN_PWR(5V)	2	GND

CN2: Internal USB UART

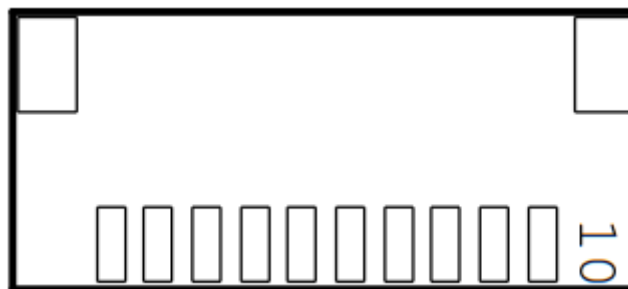

Pin	Signal Description	Pin	Signal Description
1	+5V	2	USB2_DN6
3	USB2_DP6	4	GND
5	+5V	6	USB2_DN7
7	USB2_DP7	8	GND
9	UART0_RXD_3V3	10	UART0_TXD_3V3

CN3: eDP

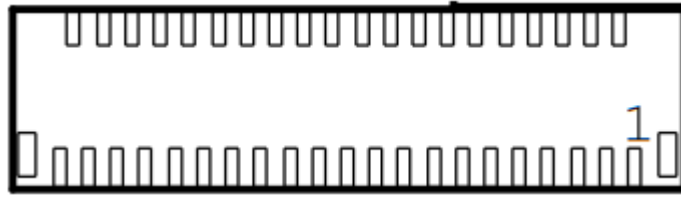

Pin	Signal Description	Pin	Signal Description
1	NC	2	NC
3	GND	4	NC
5	NC	6	GND
7	NC	8	NC
9	GND	10	NC
11	NC	12	GND
13	NC	14	NC
15	GND	16	EDP_TXP_0
17	EDP_TXN_0	18	GND
19	EDP_TXP_1	20	EDP_TXN_1
21	GND	22	EDP_TXP_2
23	EDP_TXN_2	24	GND
25	EDP_TXP_3	26	EDP_TXN_3
27	GND	28	EDP_AUXP
29	EDP_AUXN	30	GND
31	EDP_HPD_CONN	32	DDI0_BKLT_CTRL
33	DDI0_VDD_EN	34	DDI0_BKLT_EN
35	I2C_3V3_SCL7	36	I2C_3V3_SDA7
37	+3.3V	38	+3.3V
39	+3.3V	40	+3.3V
41	+3.3V		

CN4: BIOS PROGRAM

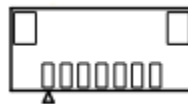

Pin	Signal Description	Pin	Signal Description
1	SPI_MISO	2	GND
3	SPI_CLK	4	+VCC_SPI
5	SPI_MOSI	6	SPI_CS0#
7	NC		

CN5: RTC

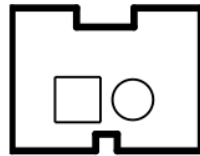

Pin	Signal Description	Pin	Signal Description
1	RTC_VCC	2	GND

CN6: USB3.0

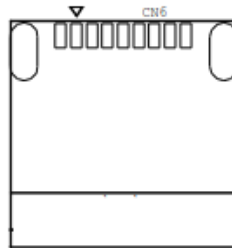

Pin	Signal Description	Pin	Signal Description
1	+V5P0_USB_1	2	USB2_C_DN1
3	USB2_C_DP1	4	GND
5	USB3_RXN_CON_P1	6	USB3_RXP_CON_P1
7	GND	8	USB3_TXN_CON_P1
9	USB3_TXP_CON_P1		

CN7: DP connector

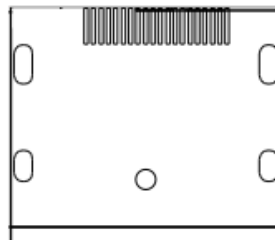

Pin	Signal Description	Pin	Signal Description
1	DDI1_TXP_DP_0	2	GND
3	DDI1_TXN_DP_0	4	DDI1_TXP_DP_1
5	GND	6	DDI1_TXN_DP_1
7	DDI1_TXP_DP_2	8	GND
9	DDI1_TXN_DP_2	10	DDI1_TXP_DP_3
11	GND	12	DDI1_TXN_DP_3
13	GND	14	GND
15	DDI1_AUXP_C	16	GND
17	DDI1_AUXN_C	18	DDI1_HPD
19	GND	20	+3.3V

CN8: Power input

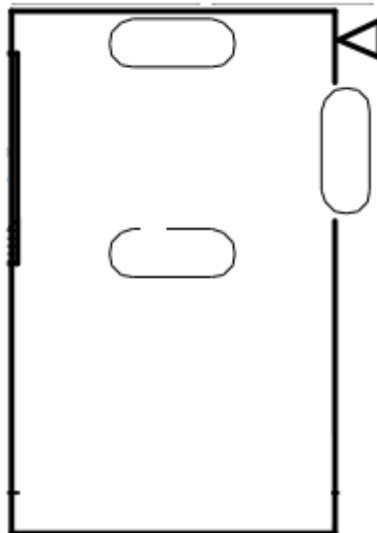

Pin	Signal Description	Pin	Signal Description	Pin	Signal Description
1	+12V	2	GND	3	GND

CN9: Micro USB3.0

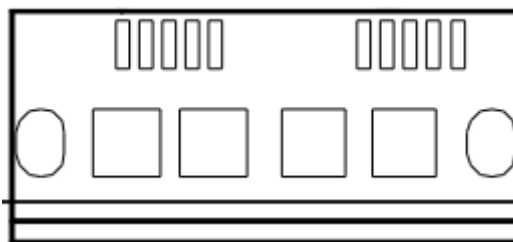

Pin	Signal Description	Pin	Signal Description	Pin	Signal Description
1	+V5P0_USB_OTG	2	USB2_C_DN0	3	USB2_C_DP0
4	USB_OTG_R_ID	5	GND	6	USB3_RXN_CON_P0
7	USB3_RXP_CON_P0	8	GND	9	USB3_TXN_CON_P0
10	USB3_TXP_CON_P0				

CN10: DOCKING I

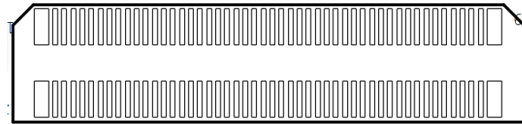

00T

Pin	Signal Description	Signal Level	Pin	Signal Description	Signal Level
1	+V5A		2	+V5A	
3	+V5A		4	+V5A	
5	+V5A		6	+V5A	
7	+V5A		8	+V5A	
9	GND		10	GND	
11	PMU_PLT_RST#	3.3V,PU10K	12	LPSS_UART1_RTS	1.8V,PU10K
13	PMU_PWRBTN_N	3.3V,PU10K	14	LPSS_UART1_CTS	1.8V
15	PM_SLP_S3#_3P3	3.3V	16	LPSS_UART1_TXD	1.8V,PD10K
17	PCIE_CLKREQ3#	1.8V,PU10K	18	LPSS_UART1_RXD	1.8V
19	PCIE_WAKE3_N	1.8V,PU4.7K	20	GND	
21	GND		22	CPU_prog_JTAG_TDO	1.8V
23	SIO_SPI_0_TXD	1.8V,PU10K	24	CPU_prog_JTAG_TMS	1.8V
25	SIO_SPI_0_RXD	1.8V	26	HDMI1_CEC_D	3.3V,PU27K
27	SIO_SPI_0_CLK	1.8V,PD10K	28	CPU_prog_JTAG_TCK	1.8V
29	SIO_SPI_0_FS0	1.8V,PD10K	30	CPU_prog_JTAG_TDI	1.8V
31	SIO_SPI_0_FS1	1.8V,PU10K	32	ISH_GPIO_0	1.8V
33	GND		34	ISH_GPIO_1	1.8V
35	LPC_R_AD0	1.8V	36	ISH_GPIO_2	1.8V
37	LPC_R_AD1	1.8V	38	ISH_GPIO_3	1.8V
39	LPC_R_AD2	1.8V	40	ISH_GPIO_4	1.8V
41	LPC_R_AD3	1.8V,PU10K	42	ISH_GPIO_5	1.8V
43	GND		44	ISH_GPIO_6	1.8V
45	AVS_I2S2_MCLK	1.8V	46	PWM0	1.8V,PD10K
47	AVS_I2S2_WS_SYNC	1.8V	48	PWM1	1.8V,PD10K
49	AVS_I2S2_SDI	1.8V	50	GND	
51	AVS_I2S2_SDO	1.8V,PD4.7K	52	I2C_SDA6	1.8V,PU10K
53	GND		54	I2C_SCL6	1.8V,PU10K
55	PCIE_P5_USB3_P2_TXP		56	GND	
57	PCIE_P5_USB3_P2_TXN		58	AVS_I2S2_BCLK	1.8V
59	GND		60	BT_HOST_WAKE	1.8V
61	PCIE_P5_USB3_P2_RXP		62	GND	

63	PCIE_P5_USB3_P2_RXN		64	USB2_DP2	
65	GND		66	USB2_DN2	
67	PCIE_REFCLK3_P		68	GND	
69	PCIE_REFCLK3_N		70	nSTATUS	1.8V
71	GND		72	GND	
73	I2C_SDA0	1.8V,PU10K	74	ISH_GPIO_7	1.8V
75	I2C_SCL0	1.8V,PU10K	76	ISH_GPIO_8	1.8V
77	GND		78	ISH_GPIO_9	1.8V
79	I2C_SDA1	1.8V,PU10K	80	ISH_GPIO_10	1.8V
81	I2C_SCL1	1.8V,PU10K	82	ISH_GPIO_11	1.8V
83	GND		84	ISH_GPIO_12	1.8V
85	GPIO_2	1.8V	86	ISH_GPIO_13	1.8V
87	GPIO_3	1.8V	88	ISH_GPIO_14	1.8V
89	GND		90	PMIC_IRQ_N	1.8V
91	LPC_FRAME_N	1.8V	92	FPGA_CLR	1.8V
93	LPC_R_CLKOUT0	1.8V	94	GND	
95	LPC_CLKRU_N	1.8V	96	GPIO217/FPGA_OE	1.8V
97	LPC_SERIRQ	1.8V	98	GPIO216/FPGA_RST	1.8V
99	CONFIG_SEL	1.8V	100	FPGA_fw_reload	1.8V

CN11: MIPI CSI

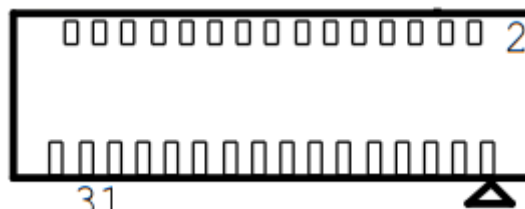

Pin	Signal Description	Pin	Signal Description	Pin	Signal Description
1	GND	2	CAM1_RST_N	3	NC
4	I2C_SDA4	5	I2C_SCL4	6	GND
7	OSC_CLK_OUT_2	8	GND	9	MCSI_RX_DATAN_0
10	MCSI_RX_DATAP_0	11	GND	12	MCSI_RX_DATAN_1
13	MCSI_RX_DATAP_1	14	GND	15	MCSI_RX_CLKN_0
16	MCSI_RX_CLKP_0	17	GND	18	MCSI_RX_DATAN_2
19	MCSI_RX_DATAP_2	20	GND	21	MCSI_RX_DATAN_3
22	MCSI_RX_DATAP_3	23	GND	24	+AVDD_CAM
25	GND_CAM	26	+V1P2_CAM	27	+V1P8_CAM
28	GND	29	+V2P8_CAM	30	+V2P8_CAM
31	GND				

CN12: DOCKING II

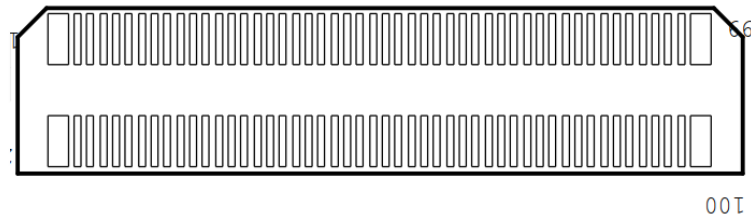

Pin	Signal Description	Signal Level	Pin	Signal Description	Signal Level
1	+12V		2	+12V	
3	+12V		4	+12V	
5	+12V		6	+12V	
7	+12V		8	+12V	
9	NC		10	NC	
11	DDIO_HPD		12	GND	
13	DDIO_TXP_1		14	DDIO_TXP_0	
15	DDIO_TXN_1		16	DDIO_TXN_0	
17	GND		18	GND	
19	DDIO_TXP_2		20	DDIO_TXP_3	
21	DDIO_TXN_2		22	DDIO_TXN_3	
23	GND		24	GND	
25	DDIO_AUXP		26	DDIO_DDCCLK	
27	DDIO_AUXN		28	DDIO_DDCDATA	
29	GND		30	GND	
31	PCIE_REFCLK0_P		32	PCIE_REFCLK1_P	
33	PCIE_REFCLK0_N		34	PCIE_REFCLK1_N	
35	GND		36	GND	
37	PCIE_RXP0		38	PCIE_RXP1	
39	PCIE_RXN0		40	PCIE_RXN1	
41	GND		42	GND	
43	PCIE_TXP0		44	PCIE_TXP1	
45	PCIE_TXN0		46	PCIE_TXN1	
47	GND		48	GND	
49	PCIE_REFCLK2_P		50	PCIE_P3_USB3_P4_TXP	
51	PCIE_REFCLK2_N		52	PCIE_P3_USB3_P4_TXN	
53	GND		54	GND	
55	PCIE_TXP2		56	PCIE_P3_USB3_P4_RXP	
57	PCIE_TXN2		58	PCIE_P3_USB3_P4_RXN	

59	GND		60	GND	
61	PCIE_RXP2		62	SATA_P1_USB3_P5_RXN	
63	PCIE_RXN2		64	SATA_P1_USB3_P5_RXP	
65	GND		66	GND	
67	PCIE_P4_USB3_P3_TXP		68	SATA_P1_USB3_P5_TXN	
69	PCIE_P4_USB3_P3_TXN		70	SATA_P1_USB3_P5_TXP	
71	GND		72	GND	
73	PCIE_P4_USB3_P3_RXP		74	SATA_RXN0	
75	PCIE_P4_USB3_P3_RXN		76	SATA_RXP0	
77	GND		78	GND	
79	USB2_DP3		80	SATA_TXP0	
81	USB2_DN3		82	SATA_TXN0	
83	GND		84	GND	
85	USB2_DP4		86	USB2_DP5	
87	USB2_DN4		88	USB2_DN5	
89	GND		90	GND	
91	PWRON/PNLVDDEN	3.3V,PU10K	92	SATA_LED_N	1.8V
93	PLTRST/PNLBKLEN	3.3V,PU10K	94	DDIO_BKLTCTL	1.8V
95	PCIE_WAKE0_N	1.8V,PU4.7K	96	PCIE_CLKREQ0#	1.8V,PU10K
97	PCIE_WAKE1_N	1.8V,PU4.7K	98	PCIE_CLKREQ1#	1.8V,PU10K
99	PCIE_WAKE2_N	1.8V,PU4.7K	100	PCIE_CLKREQ2#	1.8V,PU10K

CN13: MIPI CSI 2CH

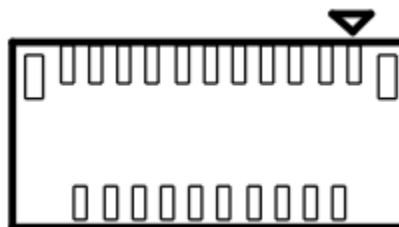

Pin	Signal Description	Pin	Signal Description	Pin	Signal Description
1	GND	2	MCSI_DN_1	3	MCSI_DP_1
4	GND	5	MCSI_CLKN_0	6	MCSI_CLKP_0
7	GND	8	MCSI_DN_0	9	MCSI_DP_0

10	GND	11	+V1P2_CAM	12	+V1P8_CAM
13	GND	14	OSC_CLK_OUT_3	15	GND
16	I2C_SCL4	17	I2C_SDA4	18	CAM2_RST_N
19	FLASH_RESET_N	20	+V2P8_CAM	21	GND_CAM

CN14: PWR Button Pin Header

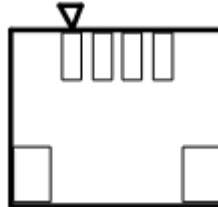

Pin	Signal Description	Pin	Signal Description
1	PWRBTN_N	2	GND
3	RSTBTN_N	4	GND

X-ON Electronics

Largest Supplier of Electrical and Electronic Components

Click to view similar products for [Single Board Computers](#) category:

Click to view products by [Aaeon](#) manufacturer:

Other Similar products are found below :

[MANO882VPGGA-H81](#) [SSD3200W-S-SLC-INN](#) [AmITX-SL-G-Q170](#) [IB100](#) [MVME61006E-2173R](#) [20-101-0738](#) [PCE-4128G2-00A1E](#)
[RSB-4220CS-MCA1E](#) [SHB230DGGA-RC](#) [IB909AF-5650](#) [AmITX-BT-I-E3815](#) [PICO841VGA-E3827](#) [IMB210VGGA](#) [MI981AF](#) [RSB-](#)
[4221CS-MCA1E](#) [PCE-9228G2I-00A1E](#) [IB915F-3955](#) [IB909F-5010](#) [MI958F-16C](#) [UPS-P-8G-64GB-PACK](#) [S2600WFT](#) [IB915AF-6300](#)
[S2600STB](#) [BBS2600BPS](#) [IB915F-6100](#) [Nit6QP_MAX](#) [MI990VF-X28-E](#) [MI990VF-6820](#) [MI991AF-C236](#) [94AC6636](#) [BANANA PI BPI-M4](#)
[BLKNUC7I3DNHNC1978015](#) [BLKNUC7I5DNK1E 960791](#) [IOT-LS1012A-OXALIS](#) [NITX-300-ET-DVI](#) [94AC6633](#) [A33-OLINUXINO-](#)
[N8G](#) [A64-OLINUXINO-1GE16GW](#) [A20-SOM-E16GS16M](#) [A20-SOM204-1G-M](#) [EMB-APL1-A10-3350-F1-LV](#) [PICO-APL1-A10-F001](#)
[PICO-APL4-A10-F003](#) [ODYSSEY - STM32MP157C BOARD WITH SOM](#) [BEAGLEBONE GREEN GATEWAY DEV BOARD](#) [ODYSSEY](#)
[- X86J4105864 8GB RAM 64GB EMMC](#) [ODYSSEY -X86J4105864 8GB/64GB ENTERPRISE](#) [VISIONDK-STM32MP1 V.1.0](#) [VISIONDK-](#)
[6ULL V.2.0](#) [VISIONDK-8MMINI V.1.0](#)