

# Circuit breakers for transformer protection

## MS132-T / MS132-KT



Circuit breakers for transformer protection are electromechanical protection devices specially designed to protect control transformers on the primary side. They allow protection against overload and short-circuit saving space and cost and ensuring a quick reaction under short-circuit condition by switching off the transformer within milliseconds. The short-circuit current setting is fixed to 20 times the operational current to handle the high inrush current generated by transformers. The device allows manual connection and disconnection of the transformer from the mains.

### Description

- Short-circuit current protection
- Overload protection – trip class 10
- Adjustable current setting for overload protection
- Disconnect function
- Temperature compensation from -25 ... +60 °C
- Trip-free mechanism
- Clear switch position indication ON/OFF/TRIP
- Rotary lockable handle
- Magnetic trip indication
- Screw or Push-in Spring terminals

### Order data

Setting range	MS132-T screw terminal			MS132-KT Push-in Spring terminal		
	Type	Order code	Weight Pkg (1 pce) kg	Type	Order code	Weight Pkg (1 pce) kg
A						
0.10...0.16	MS132-0.16T	1SAM340000R1001	0.215	MS132-0.16KT	1SAM340010R1001	0.256
0.16...0.25	MS132-0.25T	1SAM340000R1002	0.215	MS132-0.25KT	1SAM340010R1002	0.256
0.25...0.40	MS132-0.4T	1SAM340000R1003	0.215	MS132-0.4KT	1SAM340010R1003	0.256
0.40...0.63	MS132-0.63T	1SAM340000R1004	0.215	MS132-0.63KT	1SAM340010R1004	0.256
0.63...1.00	MS132-1.0T	1SAM340000R1005	0.215	MS132-1.0KT	1SAM340010R1005	0.256
1.00...1.60	MS132-1.6T	1SAM340000R1006	0.265	MS132-1.6KT	1SAM340010R1006	0.298
1.60...2.50	MS132-2.5T	1SAM340000R1007	0.265	MS132-2.5KT	1SAM340010R1007	0.280
2.50...4.00	MS132-4.0T	1SAM340000R1008	0.265	MS132-4.0KT	1SAM340010R1008	0.286
4.00...6.30	MS132-6.3T	1SAM340000R1009	0.265	MS132-6.3KT	1SAM340010R1009	0.289
6.30...10.0	MS132-10T	1SAM340000R1010	0.265	MS132-10KT	1SAM340010R1010	0.296
8.00...12.0	MS132-12T	1SAM340000R1012	0.310	-	-	-
10.0...16.0	MS132-16T	1SAM340000R1011	0.310	MS132-16KT	1SAM340010R1011	0.316
16.0...20.0	MS132-20T	1SAM340000R1013	0.310	MS132-20KT	1SAM340010R1013	0.317
20.0...25.0	MS132-25T	1SAM340000R1014	0.310	MS132-25KT	1SAM340010R1014	0.317

Note: Circuit breakers for transformer protection should always be selected so that the actual nominal current is within the setting range.

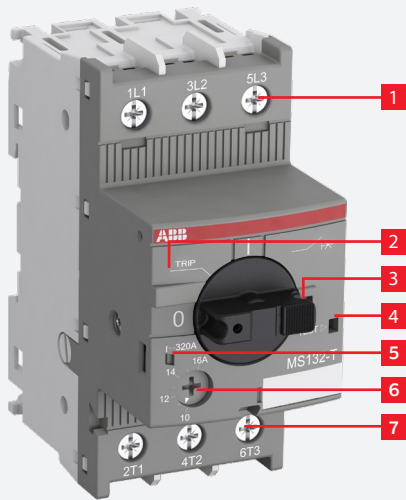

### Functional description

1. Terminals 1L1, 3L2, 5L3
2. Switch position TRIP
3. Lockable handle
4. Test function
5. Status indication for short-circuit
6. Current setting range / Adjustable current setting for overload protection
7. Terminals 2T1, 4T2, 6T3

### Application

Circuit breakers for transformer protection protect transformers and the installation against short-circuit and overload. They are protection devices with thermal tripping elements for overload protection and electromagnetic tripping elements for short-circuit protection. Furthermore, they provide a disconnect function for safety isolation of the installation and the supply. They can be used for manual switching of loads.

Circuit breakers for transformer protection have a setting scale in amperes, which allows the direct adjustment of the device without any additional calculation. In compliance with international standards, the setting current is the rated current and not the tripping current (no tripping at  $1.05 \times I$ , tripping at  $1.2 \times I$ ;  $I =$  setting current).

### Operation mode

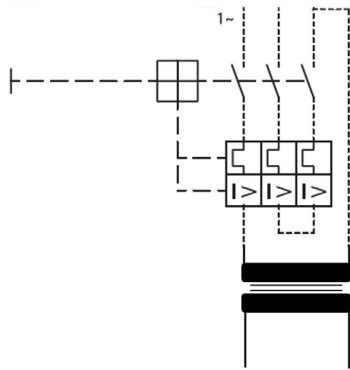

Single-phase operation

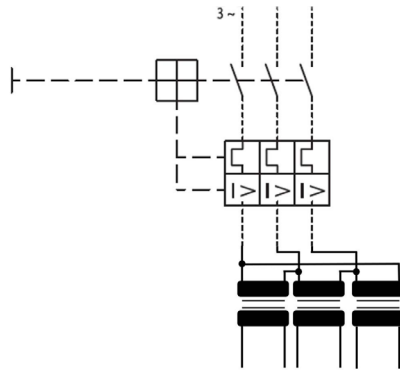

Three-phase operation (Delta)

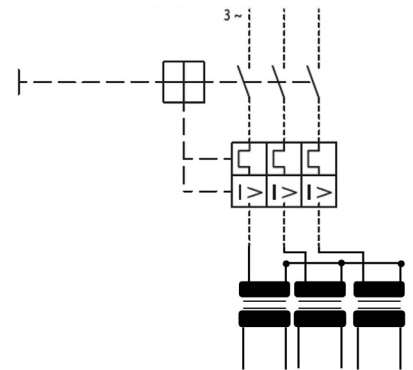

Three-phase operation (Star)

### Wiring diagram

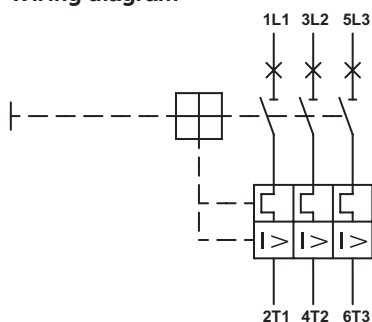

**Resistance and power loss per pole and short-circuit protective devices**

Type	Setting range		Resistance per pole Ω	Power loss per pole	
	lower value A	upper value A		at lower value W	at upper value W
MS132-0.16(K)T	0.10	0.16	58.923	0.6	1.5
MS132-0.25(K)T	0.16	0.25	23.393	0.6	1.5
MS132-0.4(K)T	0.25	0.40	9.201	0.6	1.5
MS132-0.63(K)T	0.40	0.63	3.820	0.6	1.5
MS132-1.0(K)T	0.63	1.00	1.498	0.6	1.5
MS132-1.6(K)T	1.00	1.60	0.603	0.6	1.5
MS132-2.5(K)T	1.60	2.50	0.253	0.6	1.6
MS132-4.0(K)T	2.50	4.00	0.099	0.6	1.6
MS132-6.3(K)T	4.00	6.30	0.049	0.8	1.9
MS132-10(K)T	6.30	10.00	0.020	0.8	2.0
MS132-12T	8.00	12.00	0.015	1.0	2.2
MS132-16(K)T	10.00	16.00	0.010	1.0	2.6
MS132-20(K)T	16.00	20.00	0.005	1.4	2.2
MS132-25(K)T	20.00	25.00	0.004	1.7	2.7

**Main dimensions**  
in mm / inches

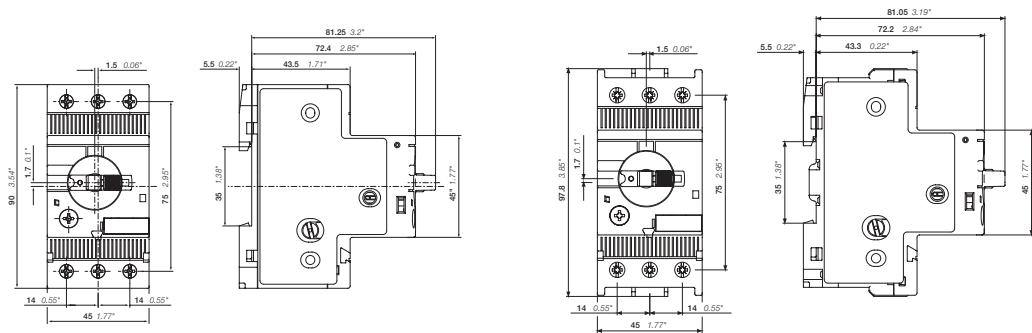

MS132-T ≤ 10 A

MS132-T > 10 A

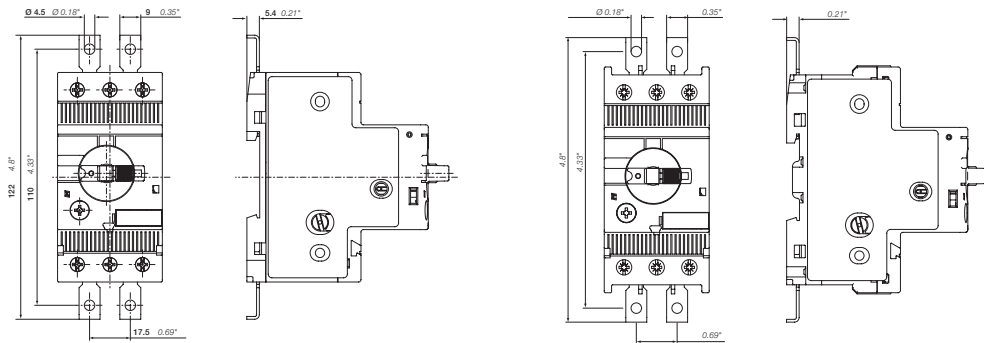

MS132-T ≤ 10 A with screw fixing kit FS116 (accessory)

MS132-T > 10 A with screw fixing kit FS116 (accessory)

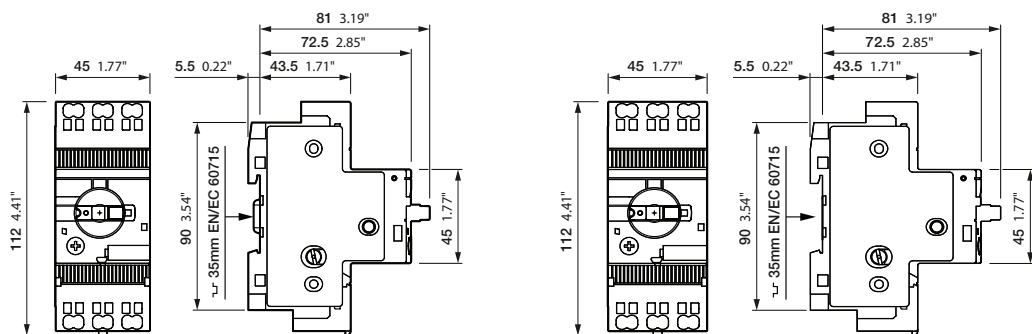

MS132-KT ≤ 10 A

MS132-KT > 10 A





**Technical data IEC/EN**





Data at Ta = 40 °C and at rated values, if nothing else indicated

**Main circuit**

Terminal marking	1L1-3L2-5L3 2T1-4T2-6T3
Rated operational voltage Ue	690 V AC
Setting range - electronic overload protection	see table "Order data" on page 1
Rated operational current Ie	see table below
Rated operational current DC-5 Ie 3 conducting paths in series up to 250 V	-
Rated instantaneous short-circuit current setting Ii	see table below
Rated service short-circuit breaking capacity Ics	see table "Short-circuit breaking capacity and back-up fuses" on page 6
Rated ultimate short-circuit breaking capacity Icu	
Rated service short-circuit breaking capacity DC Ics 3 conducting paths in series up to 250 V	-
Trip class	see table "Order data" on page 1
Rated frequency	50/60 Hz
Number of poles	3
Resistance per pole	see table "Resistance and power loss per pole"
Power loss per pole	on page 3

**Electrical connection**

Type	MS132T ≤ 10 A	MS132T > 10 A
 solid	1/2 x 1 ... 4 mm <sup>2</sup>	1/2 x 1 ... 2.5 mm <sup>2</sup> 1/2 x 2.5 ... 6 mm <sup>2</sup>
 stranded	1/2 x 1 ... 4 mm <sup>2</sup>	1/2 x 1 ... 2.5 mm <sup>2</sup> 1/2 x 2.5 ... 6 mm <sup>2</sup>
 flexible with ferrule	1/2 x 0.75 ... 2.5 mm <sup>2</sup>	1/2 x 0.75 ... 6 mm <sup>2</sup>
 flexible with ferrule insulated	1/2 x 0.75 ... 2.5 mm <sup>2</sup>	1/2 x 0.75 ... 6 mm <sup>2</sup>
 flexible without ferrule	1/2 x 0.75 ... 2.5 mm <sup>2</sup>	1/2 x 1 ... 2.5 mm <sup>2</sup> 1/2 x 2.5 ... 6 mm <sup>2</sup>
Stripping length	9 mm	10 mm
Tightening torques	0.8 ... 1.2 Nm	2 Nm
Recommended screwdriver	Pozidriv 2	Pozidriv 2

Type	MS132-KT with Push-in Spring terminals
 solid	1/2 x 1 ... 2.5 mm <sup>2</sup>
 stranded	1/2 x 1 ... 6 mm <sup>2</sup>
 flexible with ferrule	1/2 x 1 (push-in) / 0.5 (spring) ... 4 mm <sup>2</sup>
 flexible with ferrule insulated	1 x 1 (push-in) / 0.5 (spring) ... 4 mm <sup>2</sup> 1/2 x 1 (push-in) / 0.5 (spring) ... 2.5 mm <sup>2</sup>
 flexible without ferrule	1/2 x 0.5 (spring) ... 4 mm <sup>2</sup>
Stripping length	12 mm
Recommended screwdriver	Flat Ø 3 mm x 0.5 mm

Type	Rated instantaneous short-circuit current setting Ii A	Rated operational current Ie A
MS132-0.16(K)T	3.20	0.16
MS132-0.25(K)T	5.00	0.25
MS132-0.4(K)T	8.00	0.40
MS132-0.63(K)T	13.0	0.63
MS132-1.0(K)T	20.0	1.00
MS132-1.6(K)T	32.0	1.60
MS132-2.5(K)T	50.0	2.50
MS132-4.0(K)T	80.0	4.00
MS132-6.3(K)T	126	6.30
MS132-10(K)T	200	10.0
MS132-12T	240	12.0
MS132-16(K)T	320	16.0
MS132-20(K)T	400	20.0
MS132-25(K)T	500	25.0

**General data**

Mechanical durability		100 000
Electrical durability		50 000
Duty time		100 %
Operating frequency without early tripping		-
Dimensions (W x H x D)		see drawing "Dimensions" on page 3
Weight		see table "Order data" on page 1
Mounting		TH35-15 (35 x 15 mm Mounting Rail) acc. to IEC 60715 TH35-7.5 (35 x 7.5 mm Mounting Rail) acc. to IEC 60715
Mounting position		position 1-6 (optional for single mounting)
Group mounting		-
Minimum distance to other units same type	horizontal	0 mm
	vertical	150 mm
Minimum distance to electrical conductive board	horizontal, up to 400 V	0 mm
	horizontal, up to 690 V	> 1.5 mm
	vertical	75 mm
Degree of protection	housing	IP20
	main circuit terminals	IP10 for screw terminals, IP20 for Push-in Spring terminals
Utilization category		A
Maximum operating altitude		up to 2000 m
Maximum operating frequency		170 cycles/h

**Environmental data**

Ambient air temperature		
Operation	open - compensated	-25 ... +60 °C
	open	-25 ... +70 °C
	enclosed (IB132)	0 ... +40 °C
Storage		-50 ... +80 °C
Ambient air temperature compensation		acc. to IEC/EN 60947-4-1
Vibration (sinusoidal) acc. to IEC/EN 60068-2-6 (Fc)		5g / 3 ... 150 Hz
Shock (half-sine) acc. to IEC/EN 60068-2-27 (Ea)		25g / 11 ms

**Standards / directives**

Standards	IEC/EN 60947-1 IEC/EN 60947-2 IEC/EN 60947-4-1 UL 60947-1 UL 60947-4-1 CSA-C22.2 No 60947-1 CSA-C22.2 No 60947-4-1
Low Voltage Directive	2014/35/EU
RoHS Directive	2011/65/EU

### Short-circuit breaking capacity and back-up fuses

Ics Rated service short-circuit breaking capacity

Icu Rated ultimate short-circuit breaking capacity

- No back-up fuse required, because short-circuit proof up to 100 kA



Type	230 V AC			400 V AC			440 V AC			500 V AC			690 V AC		
	Ics kA	Icu kA	gG A	Ics kA	Icu kA	gG A	Ics kA	Icu kA	gG A	Ics kA	Icu kA	gG A	Ics kA	Icu kA	gG A
MS132-0.16(K)T	100	100	-	100	100	-	100	100	-	100	100	-	100	100	-
MS132-0.25(K)T	100	100	-	100	100	-	100	100	-	100	100	-	100	100	-
MS132-0.4(K)T	100	100	-	100	100	-	100	100	-	100	100	-	100	100	-
MS132-0.63(K)T	100	100	-	100	100	-	100	100	-	100	100	-	100	100	-
MS132-1.0(K)T	100	100	-	100	100	-	100	100	-	100	100	-	100	100	-
MS132-1.6(K)T	100	100	-	100	100	-	100	100	-	100	100	-	100	100	-
MS132-2.5(K)T	100	100	-	100	100	-	100	100	-	100	100	-	100	100	-
MS132-4.0(K)T	100	100	-	100	100	-	30	30	35	20	20	35	3	3	32
MS132-6.3(K)T	100	100	-	100	100	-	30	30	63	20	20	63	3	3	50
MS132-10(K)T	100	100	-	100	100	-	30	30	100	20	20	100	3	3	50
MS132-12T	100	100	-	100	100	-	30	30	100	20	20	100	3	3	63
MS132-16(K)T	100	100	-	100	100	-	30	30	125	20	20	125	3	3	63
MS132-20(K)T	100	100	-	100	100	-	30	30	125	20	20	125	3	3	80
MS132-25(K)T	50	50	125	50	50	125	30	30	125	10	10	125	3	3	100

### Technical data UL/CSA

#### Main circuit

Maximum operational voltage	600 V
Ratings	Locked rotor amps (LRA) see table below

#### Electrical connection

Type	MS132-T ≤ 10 A	MS132-T ≥ 12 A
 stranded	1/2 x AWG 16 ... 12	1/2 x AWG 16 ... 8
 flexible without ferrule	1/2 x AWG 16 ... 12	1/2 x AWG 16 ... 8
Stripping length	9 mm	10 mm
Tightening torque	10 ... 12 lb-in	18 lb-In
Recommended screwdriver	Pozidriv 2	Pozidriv 2

Type	MS132-KT with Push-in Spring terminals
 Stranded acc. to UL/CSA	1/2 AWG 18 ... AWG 10 (push-in) / AWG 18 ... AWG 8 (spring) 1 x AWG 8
Stripping length	12 mm
Recommended screwdriver	Flat Ø 3 mm x 0.5 mm

**UL current ratings, single-phase**

Type	120 V AC	220 ... 240 V AC
	FLA	FLA
MS132-0.16(K)T	0.16	0.16
MS132-0.25(K)T	0.25	0.25
MS132-0.4(K)T	0.4	0.4
MS132-0.63(K)T	0.63	0.63
MS132-1.0(K)T	1	1
MS132-1.6(K)T	1.6	1.6
MS132-2.5(K)T	2.5	2.5
MS132-4.0(K)T	4	4
MS132-6.3(K)T	6.3	6.3
MS132-10(K)T	9.8	10
MS132-12T	9.8	12
MS132-16(K)T	16	12
MS132-20(K)T	20	17
MS132-25(K)T	24	17

**Manual controller for tap conductor protection and for control transformers**

Type	Max. short-circuit current rating	
	480Y / 277 V kA	600Y / 347 V kA
MS132-0.16(K)T	65	47
MS132-0.25(K)T	65	47
MS132-0.4(K)T	65	47
MS132-0.63(K)T	65	47
MS132-1.0(K)T	65	47
MS132-1.6(K)T	65	47
MS132-2.5(K)T	65	47
MS132-4.0(K)T	65	47
MS132-6.3(K)T	65	18
MS132-10(K)T	65	18
MS132-12T	30	18
MS132-16(K)T	30	18
MS132-20(K)T	30	18
MS132-25(K)T	30	18



---

**ABB STOTZ-KONTAKT GmbH**  
Eppelheimer Straße 82  
69123 Heidelberg, Germany  
Phone: +49 (0) 6221 7 01-0  
Fax: +49 (0) 6221 7 01-13 25  
E-Mail: [info.desto@de.abb.com](mailto:info.desto@de.abb.com)

[abb.com/contacts](http://abb.com/contacts)

We reserve the right to make technical changes or modify the contents of this document without prior notice. With regards to purchase orders, the agreed particulars shall prevail. ABB AG does not accept any responsibility whatsoever for potential errors or possible lack of information in this document.

We reserve all rights in this document and in the subject matter and illustrations contained therein. Any reproduction, disclosure to third parties or utilization of its contents – in whole or in parts – is forbidden without prior written consent of ABB AG.

Copyright© 2021 ABB - All rights reserved



## X-ON Electronics

Largest Supplier of Electrical and Electronic Components

*Click to view similar products for [Contactors - Electromechanical category](#):*

*Click to view products by [ABB manufacturer](#):*

Other Similar products are found below :

[686-120111](#) [70-901](#) [70-914](#) [MB-3D-6](#) [MC-22A/4-AC120V](#) [8-1616943-9](#) [8-1672124-5](#) [A701U](#) [AVR743D](#) [B6-40-00-84](#) [B7-40-00-84](#)  
[1616017-5](#) [HP-11D-24](#) [P25-E5019-1](#) [P40P47D13P1-24-01](#) [CA7-72-00-24Z](#) [90-162](#) [9-1393132-2](#) [2NC4F0222](#) [ACC338UMM20](#)  
[AF80-30-11-13](#) [SZ-B1](#) [3GC2H0M22](#) [3NC0T0A22](#) [3NC1Q0A22](#) [42AF35AG](#) [42AF35AH](#) [42CF35AE](#) [42CF35AL](#) [42FE35AFR](#)  
[45CG10AFA](#) [45CG10AJA](#) [45CG10EJA](#) [45CG20AF](#) [45CG20AL](#) [45CG20EF](#) [45CG20EG](#) [45CG20EL](#) [45DG10AFA](#) [45DG10AGA](#)  
[45DG10AJA](#) [45DG10ALA](#) [45DG10ELA](#) [45DG20AG](#) [45DG20AL](#) [45EG10AFA](#) [45EG10AJA](#) [45EG10ALA](#) [45EG20AL](#) [45FG10AFA](#)