



Short form catalog

Motor protection and control

Manual motor starters, contactors and overload relays

Motor rated operational powers and currents

The currents given below concern standard three-phase four-pole cage motors (1500 r.p.m. at 50 Hz 1800 r.p.m. at 60 Hz). These values are given for guidance and may vary according to the motor manufacturer and depending on the number of poles.

IEC	Motor nominal current: standardized values in blue colour (according to IEC 60947-4-1 Annex G)									
Motor power kW	220 V A	230 V A	240 V A	380 V A	400 V A	415 V A	440 V A	500 V A	660 V A	690 V A
0.06	0.37	0.35	0.34	0.21	0.2	0.19	0.18	0.16	0.13	0.12
0.09	0.54	0.52	0.50	0.32	0.3	0.29	0.26	0.24	0.18	0.17
0.12	0.73	0.7	0.67	0.46	0.44	0.42	0.39	0.32	0.24	0.23
0.18	1	1	1	0.63	0.6	0.58	0.53	0.48	0.37	0.35
0.25	1.6	1.5	1.4	0.9	0.85	0.82	0.74	0.68	0.51	0.49
0.37	2.0	1.9	1.8	1.2	1.1	1.1	1	0.88	0.67	0.64
0.55	2.7	2.6	2.5	1.6	1.5	1.4	1.3	1.2	0.91	0.87
0.75	3.5	3.3	3.2	2.0	1.9	1.8	1.7	1.5	1.15	1.1
1.1	4.9	4.7	4.5	2.8	2.7	2.6	2.4	2.2	1.7	1.6
1.5	6.6	6.3	6	3.8	3.6	3.5	3.2	2.9	2.2	2.1
2.2	8.9	8.5	8.1	5.2	4.9	4.7	4.3	3.9	2.9	2.8
3	11.8	11.3	10.8	6.8	6.5	6.3	5.7	5.2	4	3.8
4	15.7	15	14.4	8.9	8.5	8.2	7.4	6.8	5.1	4.9
5.5	20.9	20	19.2	12.1	11.5	11.1	10.1	9.2	7	6.7
7.5	28.2	27	25.9	16.3	15.5	14.9	13.6	12.4	9.3	8.9
11	39.7	38	36.4	23.2	22	21.2	19.3	17.6	13.4	12.8
15	53.3	51	48.9	30.5	29	28	25.4	23	17.8	17
18.5	63.8	61	58.5	36.8	35	33.7	30.7	28	22	21
22	75.3	72	69	43.2	41	39.5	35.9	33	25.1	24
30	100	96	92	57.9	55	53	48.2	44	33.5	32
37	120	115	110	69	66	64	58	53	40.8	39
45	146	140	134	84	80	77	70	64	49.1	47
55	177	169	162	102	97	93	85	78	59.6	57
75	240	230	220	139	132	127	116	106	81	77
90	291	278	266	168	160	154	140	128	97	93
110	355	340	326	205	195	188	171	156	118	113
132	418	400	383	242	230	222	202	184	140	134
160	509	487	467	295	280	270	245	224	169	162
200	637	609	584	368	350	337	307	280	212	203
250	782	748	717	453	430	414	377	344	261	250
315	983	940	901	568	540	520	473	432	327	313
355	1109	1061	1017	642	610	588	535	488	370	354
400	1255	1200	1150	726	690	665	605	552	418	400
500	1545	1478	1416	895	850	819	745	680	515	493
560	1727	1652	1583	1000	950	916	832	760	576	551
630	1928	1844	1767	1116	1060	1022	929	848	643	615
710	2164	2070	1984	1253	1190	1147	1043	952	721	690
800	2446	2340	2243	1417	1346	1297	1179	1076	815	780
900	2760	2640	2530	1598	1518	1463	1330	1214	920	880
1000	3042	2910	2789	1761	1673	1613	1466	1339	1014	970

UL / CSA	Motor nominal current: standardized values (according to IEC 60947-4-1 Annex G and UL 508)				
Motor power hp	208 V A	220-240 V A	380-415 V A	440-480 V A	550-600 V A
1/2	2.4	2.2	1.3	1.1	0.9
3/4	3.5	3.2	1.8	1.6	1.3
1	4.6	4.2	2.3	2.1	1.7
1-1/2	6.6	6	3.3	3	2.4
2	7.5	6.8	4.3	3.4	2.7
3	10.6	9.6	6.1	4.8	3.9
5	16.7	15.2	9.7	7.6	6.1
7-1/2	24.2	22	14	11	9
10	30.8	28	18	14	11
15	46.2	42	27	21	17
20	59.4	54	34	27	22
25	74.8	68	44	34	27
30	88	80	51	40	32
40	114	104	66	52	41
50	143	130	83	65	52
60	169	154	103	77	62
75	211	192	128	96	77
100	273	248	165	124	99
125	343	312	208	156	125
150	396	360	240	180	144
200	528	480	320	240	192
250	-	604	403	302	242
300	-	722	482	361	289
350	-	828	560	414	336
400	-	954	636	477	382
450	-	1030	-	515	412
500	-	1180	786	590	472

Motor protection and control

Manual motor starters, contactors and overload relays

Overview	1
Manual motor starters	2
B mini contactors	3
AS contactors with screw terminals	4
AF and EK contactors with screw terminals	5
Overload relays	6
DRAS and DRAF enclosed starters	7
R contactors	8
Certifications and approvals	9
Index	10
Marketing material	11



More product information and technical data available in main catalog 1SBC100192C0203

For direct product details information, use product type or order code, ex:
www.abb.com/productdetails/AF09-30-10-13 or www.abb.com/productdetails/1SBL137001R1310

ABB sets a new standard in motor control and power switching

1

Featuring AF technology as standard, the latest range of ABB's contactors establishes a new industry benchmark. The electronically controlled coil offers multiple benefits over conventional alternatives, and together with ABB's wide product offering – an optimal configuration, every time.



Access Global Support

The contactor and motor protection range from ABB is compatible with all major national and international standards and is available worldwide via a global distribution network. One contactor coil now handles 100 V – 250 V, AC / DC for use in Europe or Asia as well as North America.



Simplify design

By reducing contactor coil energy consumption by up to 80 %, panels can be built smaller and transformers more compact. All the features of the AF technology, along with access to drawings and coordination tables online, simplifies your design and assembly process.



Optimize logistics

With its contactor and motor protection range, ABB has managed to reduce the number of contactor coils to just four. The total number of product variants has been reduced by up to 90 %. This simplifies the customers' logistics and cuts administration costs.

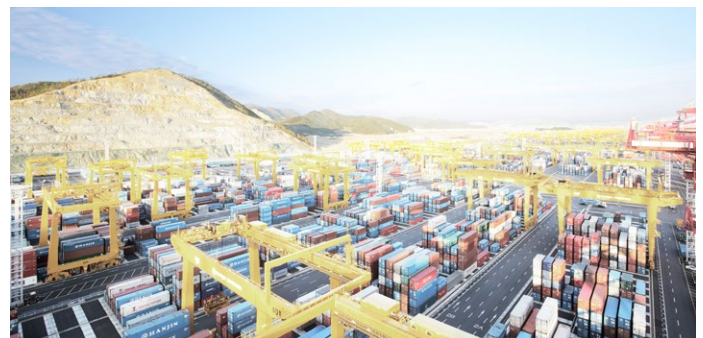

Secure uptime

Time to prevent stoppages caused by voltage fluctuations. The AF contactor ensures distinct operation in unstable networks and signifies a major advance in motor control and power switching. Voltage sags, dips and surges pose no threat. The AF contactor secures your uptime.



MacGregor. Keeping turnarounds brief.

Until the AF range was installed, voltage sags were affecting MacGregor's deck cranes. Conventional contactors welded shut, leading to several stoppages a week. No longer. Known for superior quality and an ability to operate in the most hostile environments, MacGregor deck cranes enjoy a global reputation for reliability. A small but vital component, the AF contactor helps maintain this reputation.

To keep things moving, you need Control. Connect to Control.

Explore all our case studies at www.abb.com/connecttocontrol

SSAB
Making certainty
standard

Gamesa
Taming the wind

LKAB
Providing fresh air

Contactors and motor protection

For a wide variety of segments

1

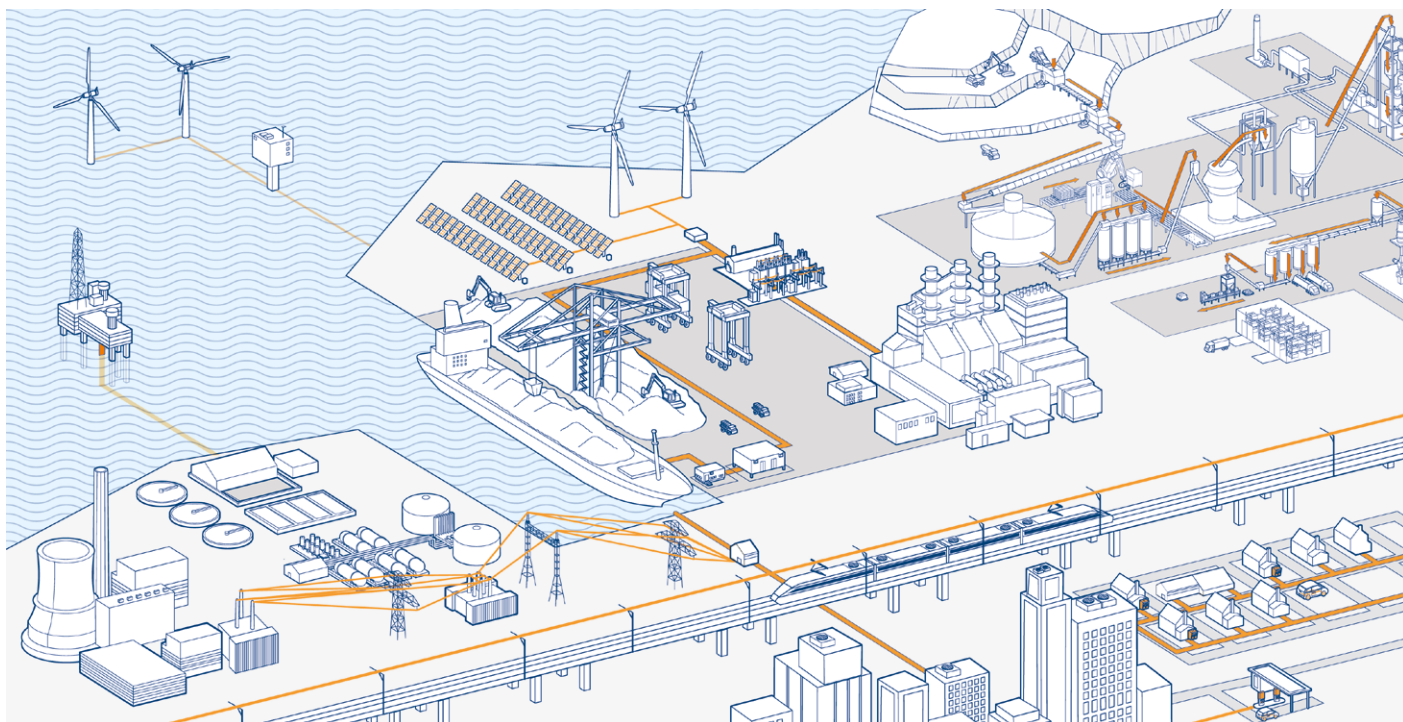

HVAC, General Machinery, Rail, Critical Power, Wind, Solar, Marine and Water & Wastewater

Contactors for any use

The AF contactor range covers small motor starting solutions from 4 kW / 5 hp up to big power switching solutions with our unique AF2650, the biggest single case block contactor in the world.

The contactor and motor protection range is part of one of the widest product offerings on the market meaning that ABB not only can provide the contactor but the full solution.

In addition to the standard product range ABB also offer products for special needs such as Bar contactors, GAF and contactors for capacitor switching.

Cooperating with customers

ABB cooperates closely with its customers to ensure that products meet requirements from their specific segments and applications. With over 100 years' experience in motor control and power switching ABB knows how to create efficient solutions for its customers.

AF technology

Benefits



Reliable in all networks

The electronic system within the AF contactor rectifies the AC or DC control circuit voltage to a DC control voltage that is applied on the coil. The contactor is safely operated in an always optimized condition making it virtually noise free.

Four coils for the entire voltage range

The AF contactor features both AC and DC support. With the complete AF contactor range, functionality is improved. Still, the total number of product variants compared to a conventional range is reduced by 90 %. Only four coils are required to cover 24 V AC, 20 V DC - 500 V AC / DC.

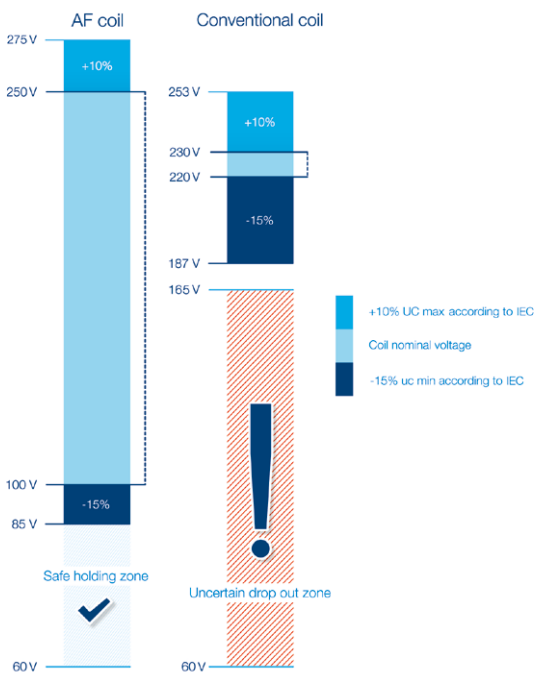

Wide control voltage range

With conventional contactor technology, different contactors were needed for different network voltages. Thanks to the wide operating range of the AF contactor it can operate just as well in Europe as in Asia or North America. The core coil of the AF contactor range covers 100-250 V AC / DC 50/60 Hz.

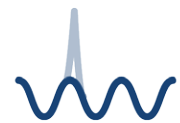

Built-in surge suppression

With conventional contactor technology it is recommended to use an external surge suppressor, an accessory that could cost as much as half the contactor itself. With the AF technology the surges are handled by the contactor itself and the surge never reaches the control circuit. Neither the surge suppressor nor the actual surge has to be considered anymore. One less product and one less complication to worry about.

Contactors and motor protection

Advanced but simple

1

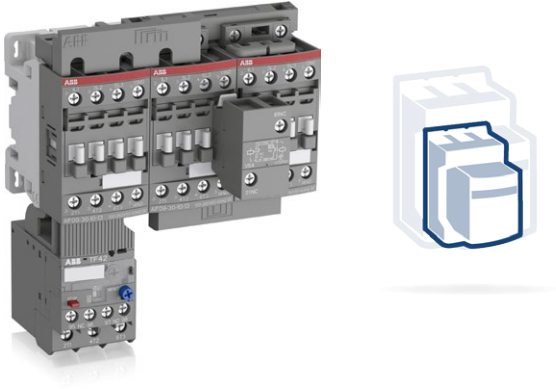

The AF contactor is compact

The AF contactor is compact in size and has had its width reduced by up to 30 % thanks to an 80 % reduction of the coil's energy consumption.



The AF contactor is flexible

AF09 ... AF370 is perfect for motor starting applications and for solutions where space is limited. Interlocked reversing pairs require no spacing between contactors meaning you can fit more functionality into cabinets or other small enclosures.



Coil terminal access in the front

The AF contactor has its coil terminals accessible from the front. The cables or bars do not have to be disconnected in order to perform voltage measurement or servicing work.

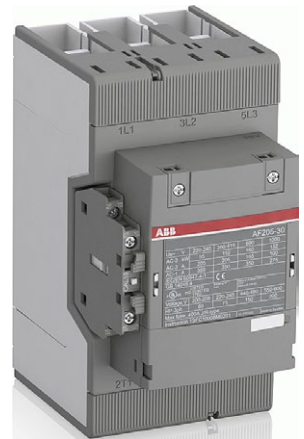
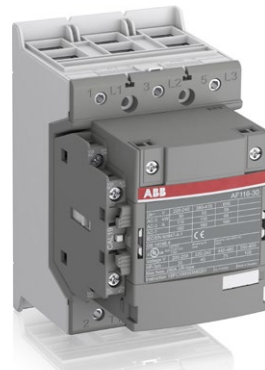

More functionality without adding width

The AF116 ... AF2650 can take up to 2 side mounted auxiliary contact blocks without adding to its width and are delivered with 1 N.O. + 1 N.C. as standard.

Contactors and motor protection

Mechanical features

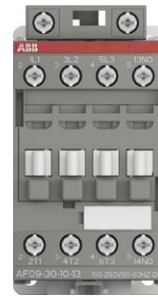
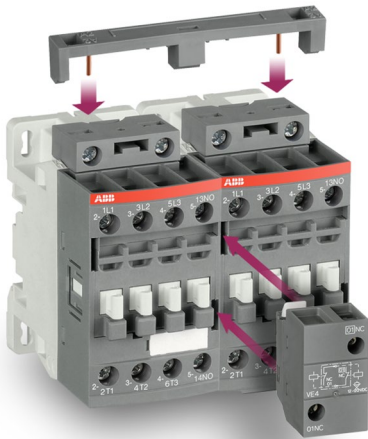

Top-mounted

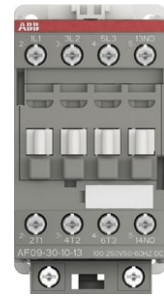

Bottom-mounted

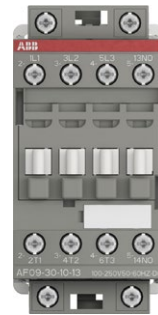

Additional LDC4
coil terminal block



Front-mounted

Easy-to-use accessories

Contactors up to 96 A offer free choice of coil terminal access and can take side and front mounted auxiliary contact blocks. All the accessories: Coil connection terminals, mechanical and electrical interlocks and electronic timers are easily connected through the snap-to-connect function.



Safe control circuit with:

- Mirror contact according to IEC 60947-4-1
- Mechanically linked contacts according to IEC 60947-5-1
- Sealable and transparent protective covers on AF09 ... AF96 and overload relays TF/EF

3-pole contactors

Mini contactors

Contactors for motor control and

1



IEC (1)	AC-3 Rated operational power	$\theta \leq 60^\circ\text{C}$ (2), 400 V	kW	4	5.5
UL/CSA	3-phase motor rating	480 V	hp	3	5
AC / DC Control supply		Type	—	—	—
AC Control supply		Type	B6	B7	—
DC Control supply		Type	BC6	BC7	—
IEC	AC-3 Rated operational current	$\theta \leq 60^\circ\text{C}$ (2), 400 V	A	8.5	11.5
	AC-1 Rated operational current	$\theta \leq 40^\circ\text{C}$, 690 V	A	20 (400 V)	20 (400 V)
UL/CSA	General use rating	600 V	A	12 (300 V)	16
NEMA	NEMA Size			—	—

4	5.5	7.5	4	5.5	7.5	11	15	18.5
5	7.5	10	5	7.5	10	15	20	25
—	—	—	AF09	AF12	AF16	AF26	AF30	AF38
AS09	AS12	AS16	AF09	AF12	AF16	AF26	AF30	AF38
ASL09	ASL12	ASL16	AF09	AF12	AF16	AF26	AF30	AF38
9	12	15.5	9	12	18	26	32	38
22	24	24	25	28	30	45	50	50
20	20	20	25	28	30	45	50	50
00	00	0	00	0	—	1	—	—

(1) 1000 V IEC ratings available for AF80, AF96 and AF146 ... AF2650 contactors.
 (2) $\theta \leq 55^\circ\text{C}$ for mini contactors and AF400 ... AF2650 contactors.

Main accessories

Auxiliary contact blocks	Front mounting	CAF6
	Side mounting	CA6
Timers	Electronic	
Interlocking units (3)	Mechanical	
	Mechanical / Electrical	
Connection sets	For reversing contactors	BSM6-30
Surge suppressors	Varistor (AC/DC)	RV-BC6
	RC type (AC)	
	Transil diode (DC)	RD7

CA3-10 (1 x N.O.)	CA4-10 (1 x N.O.)	
CA3-01 (1 x N.C.)	CA4-01 (1 x N.C.)	
	CAL4-11 (1 x N.O. + 1 x N.C.)	
TEF3-ON	TEF4-ON	
TEF3-OFF	TEF4-OFF	
VM3	VM4	
	VEM4	
BER16C-3	BER16-4	BER38-4
RV5 (24...440 V)	Built-in surge protection	
RC5-1 (24...440 V)		
RT5 (12...264 V)		

(3) See available reversing contactors VB6, VB7 and VAS09 ... VAS16.

Overload relays

Thermal relays	Class 10 (Class 10A for TF140, TA200DU)	T16 (0.10...16 A)
Electronic relays	Class 10E, 20E, 30E	E16DU (0.10...18.9 A)

T16 (0.10...16 A)	TF42 (0.10...38 A)		
	EF19 (0.10...18.9 A)	EF19 (0.10...18.9 A)	EF45 (9...45 A)

Manual motor starters

	Thermal / magnetic protection Class 10	MS116 (0.10...32 A) lcs up to 50 kA for class 10A
		MS132 (0.10...32 A) lcs up to 100 kA
	Magnetic only types	MO132 (0.16...32 A)

MS116 (0.10...32 A) lcs up to 50 kA for class 10A	MS165 (4) (10...65 A) lcs up to 100 kA
MS132 (0.10...32 A) lcs up to 100 kA	MS497 (22...100 A) lcs up to 100 kA
MO132 (0.16...32 A) lcs up to 100 kA	MO165 (4) (16...65 A) lcs up to 100 kA

Accessories	For contactor mounting	BEA7/132
-------------	------------------------	----------

BEA16-3	BEA16-4	BEA38-4
---------	---------	---------

(4) MS165/MO165 are suitable for use with AF09 ... AF30 for North american applications.
 (5) BEA65-4 suitable for MS165 and MO165 only.

power switching

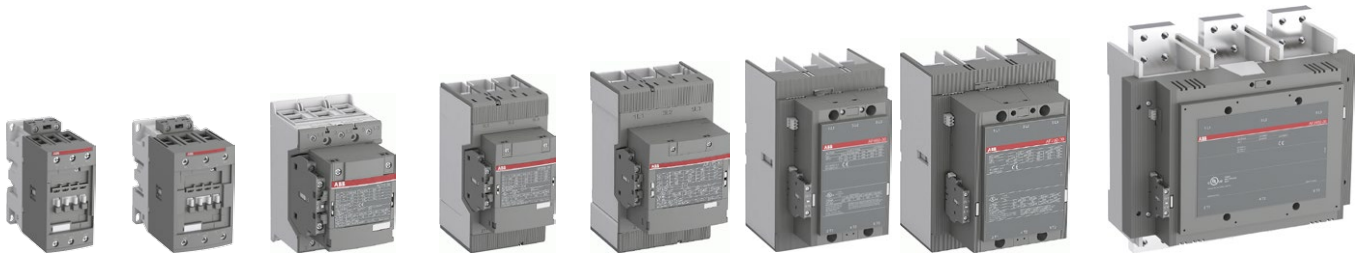

1

18.5	22	30	37	45	55	75	75	90	110	132	160	200	200	250	315	400	—	475	560	—	—																														
30	40	50	60	60	75	100	100	125	150	200	250	300	350	400	500	600	—	800	900	—	—																														
AF40		AF52		AF65		AF80		AF96		AF116		AF140		AF146		AF190		AF205		AF265		AF305		AF370		AF400		AF460		AF580		AF750		AF1250		AF1350				AF1650				AF2050				AF2650			
AF40		AF52		AF65		AF80		AF96		AF116		AF140		AF146		AF190		AF205		AF265		AF305		AF370		AF400		AF460		AF580		AF750		AF1250		AF1350				AF1650				AF2050				AF2650			
AF40		AF52		AF65		AF80		AF96		AF116		AF140		AF146		AF190		AF205		AF265		AF305		AF370		AF400		AF460		AF580		AF750		AF1250		AF1350				AF1650				AF2050				AF2650			
40	53	65	80	96	116	140	146	190	205	265	305	370	400	460	580	750	—	860	1060	—	—																														
70	100	105	125	130	160	200	225	275	350	400	500	600	600	700	800	1050	1260	1350	1650	2050	2650																														
60	80	90	105	115	160	200	200	250	300	350	400	520	550	650	750	900	1210	1350	1650	2100	2700																														
2	—	—	3	—	—	4	—	—	—	5	—	—	—	6	—	7	—	—	8	—	—																														

										CAL19-11 (1 x N.O. + 1 x N.C.)					CAL18-11 (1 x N.O. + 1 x N.C.)				
VM96-4				VM19 (for same size contactors)								VM750H VM750V				VM1650H			
BER65-4		BER96-4		BER140-4		BER205-4		BER370-4		BEM460-30		BEM750-30							

TF65 (22...67 A)	TF96 (40...96 A)	TF140DU (66...142 A) $\theta \leq 55^\circ\text{C}$	TA200DU (66...200 A) $\theta \leq 55^\circ\text{C}$				
EF65 (20...70 A)	EF96 (36...100 A)	EF146 (54...150 A)	EF205 (63...210 A)	EF370 (115...380 A)	EF460 (150...500 A)	EF750 (250...800 A)	E1250DU (375...1250 A)

Short-circuit protection devices

MS5100 (40...100 A) Ics up to 50 kA	MCCB and switch-fuses
MS495 (45...100 A) Ics up to 50 kA	
MO5100 (70...100 A) Ics up to 36 kA	
MO496 (32...100 A) Ics up to 100 kA	
MO495 (63...100 A) Ics up to 50 kA	
BEA65-4 (5)	



18BC101753S0201

4-pole contactors

1

Mini contactors



IEC	AC-1 Rated operational current	$\theta \leq 40^\circ\text{C}$, 690 V	A	16	20
UL/CSA	General use rating	600 V	A	12 (300 V)	16
AC / DC Control supply			Type	—	—
AC Control supply			Type	B6	B7
DC Control supply			Type	BC6	BC7

Contactor relays

Mini contactor relays



IEC	AC-15 Rated operational current	400 V	A	3
UL/CSA	Pilot duty			A600
AC Control supply			Type	K6-22Z K6-31Z K6-40E
DC Control supply			Type	KC6-22Z KC6-31Z KC6-40E
AC / DC Control supply			Type	— — —

R contactors

DC Circuit switching



DC-1 Rated current up to 5000 A
 DC-3/DC-5 Rated current up to 2000 A
 1500 V with poles in series

IOR.. 63-...-CC to IOR.. 5100-...-CC

Specific contactors

DC Circuit switching



100 A, 440 V, DC-1
GA75, GAE75 types



275 to 2050 A, 1000 V, DC-1
GAF185 to GAF2050 types

Contactors



25	30	45	55	70	100	125	160	200	275	350	400	500	525	800	1000
25	30	45	55	60	80	105	160	175	230	250	300	350	420	540	—
AF09	AF16	AF26	AF38	AF40	AF52	AF80	AF116	AF140	AF190	AF205	AF265	AF305	AF370	—	—
AF09	AF16	AF26	AF38	AF40	AF52	AF80	AF116	AF140	AF190	AF205	AF265	AF305	AF370	EK550	EK1000
AF09	AF16	AF26	AF38	AF40	AF52	AF80	AF116	AF140	AF190	AF205	AF265	AF305	AF370	EK550	EK1000

Contactor relays



3			3		
A600, Q300			A600, Q600		
NS22E	NS31E	NS40E	NF22E	NF31E	NF40E
NSL22E	NSL31E	NSL40E	NF22E	NF31E	NF40E
—	—	—	NF22E	NF31E	NF40E

AC Circuit switching

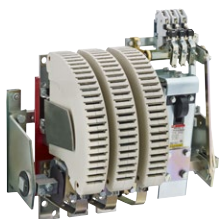

AC-1 Rated current up to 5000 A
AC-3 Rated power up to 1500 kW
(1520 A - 440 V)

IOR.. 63-...-MT to IOR.. 5100-...-MT

Special versions

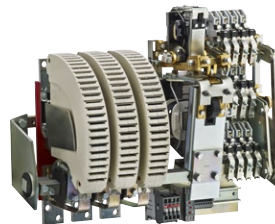

AC/DC Coupling: LOR.. contactors
Slip ring motor control: FOR .. contactors
Field discharge: AM(F)-CC-JORE contactors
AC/DC Switching (N.C./N.O. main poles):
NOR & JOR contactors
Latching contactors for energy saving
and safety requirements: AMA or AME contactors

Capacitor switching



12.5 to 80 kvar
UA16..RA to UA110..RA types
UA16 to UA110 types

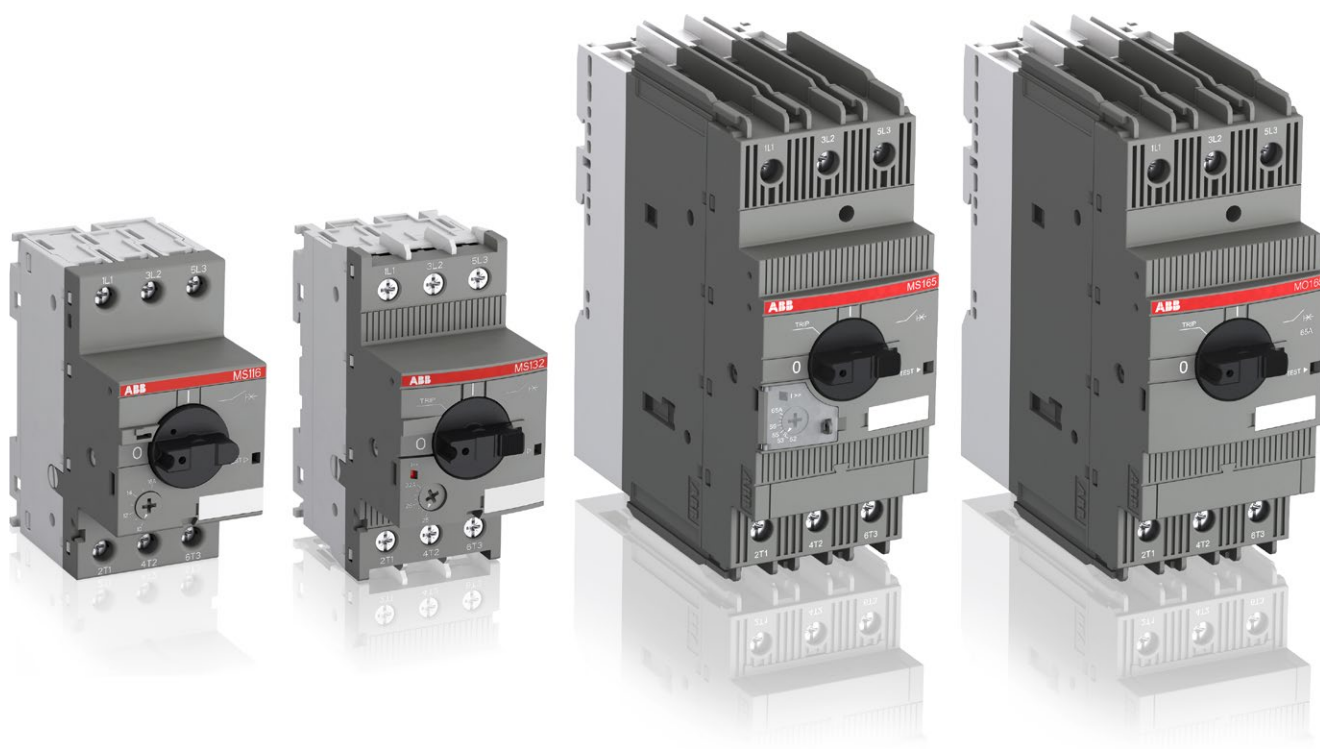

Manual motor starters

Overview

Benefits	2/2
Features	2/3
Overview	2/4

Ordering details – 0.10 to 65 A – with thermal and electromagnetic protection

MS116 manual motor starters	2/6
MS132 manual motor starters	2/7
MS165 manual motor starters	2/8

Ordering details – 0.16 to 65 A – with electromagnetic protection

MO132 manual motor starters magnetic only	2/9
MO165 manual motor starters magnetic only	2/10

Ordering details – 0.10 to 25 A – with thermal and electromagnetic protection

MS132-T circuit breakers for transformer protection	2/11
---	------

Main accessories 2/12

Ordering details – 22 to 100 A – with thermal and electromagnetic protection

MS5100, MS495, MS497 manual motor starters	2/19
--	------

Ordering details – 32 to 100 A – with electromagnetic protection

MO5100, MO495, MO496 manual motor starters magnetic only	2/20
--	------

Main accessories 2/21

General accessories 2/24

For direct product details information, use product type or order code, ex:
www.abb.com/productdetails/AF09-30-10-13 or www.abb.com/productdetails/1SBL137001R1310

Manual motor starters

Benefits

2

Manual motor starters (MMS) are protection devices for the main circuit. They combine motor control and protection in a single device. MMS are used mainly to switch motors manually ON/OFF and protect them and the installation fuse-less against short-circuit, overload and phase failures. Fuse-less protection with a manual motor starter saves costs, space and ensures a quick reaction under short-circuit condition, by switching off the motor within milliseconds.

Safe, compact, and cost-saving solution

Various motor protection functions in one device

- Overload
- Short-circuit
- Phase loss sensitivity

Efficient planning and installation perfectly matching the ABB contactor family, leads to high flexibility and increased exchangeability. Simple connecting links ensure the electrical and mechanical connection.

Products range for different applications available

- Short-circuit breaking capacity up to 100 kA
- Magnetic-only devices (only short-circuit protection)
- Selected types are certified according to ATEX
- Special version for transformer protection

The manual motor starter range is compatible with all major national and international standards.

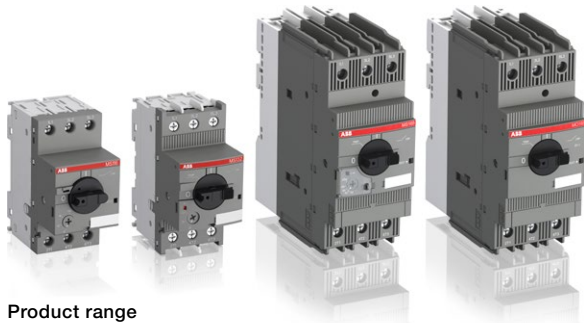

Product range

Comprehensive accessory range

Manual motor starters can be equipped with busbars, auxiliary contacts, signalling contacts, undervoltage releases and shunt trips. Moreover it is possible to order IP65 (UL/CSA Type 12) door mounting kits, IP65 (UL/CSA Type 12) enclosures and shafts for doors.

MS116, MS132, MS165, MO132, MO165 and MS132-T share almost the same accessory range. Customers can optimize administration costs and inventory costs through reduced number of order codes by benefiting from a compatible range of accessories.



Manual motor starters with busbar connection



Accessory range



Direct-on-line starters



Door mounting kits

Manual motor starters

Features

Features

- Manual control
- Disconnect function
- Handle can be locked in the off position
- Remote control via undervoltage release or shunt trip
- Trip indication
- Temperature compensation
- Adjustable current setting

- Magnetic trip indication for several types available (MS132, MS165, and MS132-T)
- One product family in 45 mm width (MS116, MS132, MO132, and MS132-T)
- Variants from 0.1 up to 100 A available
- Short-circuit service breaking capacity I_{CS} up to 100 kA

- 1 Terminals (1L1, 3L2, 5L3)
- 2 Switch position TRIP
- 3 Lockable handle
- 4 Test function
- 5 Status indication for short-circuit
- 6 Current setting range
- 7 Terminals 2T1, 4T2, 6T3

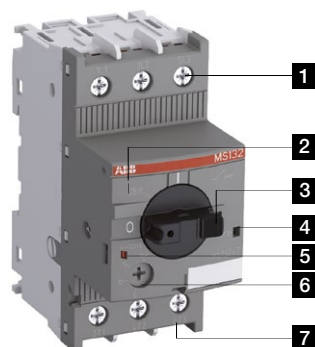

Features of type MS132

- 1 Clear trip indication
- 2 Handle in TRIP position
- 3 Optical indication for short-circuit
- 4 Easy locking

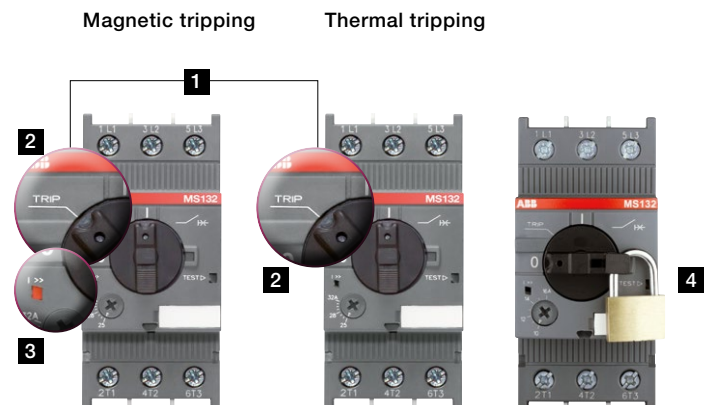

TRIP indication

Manual motor starters

Overview

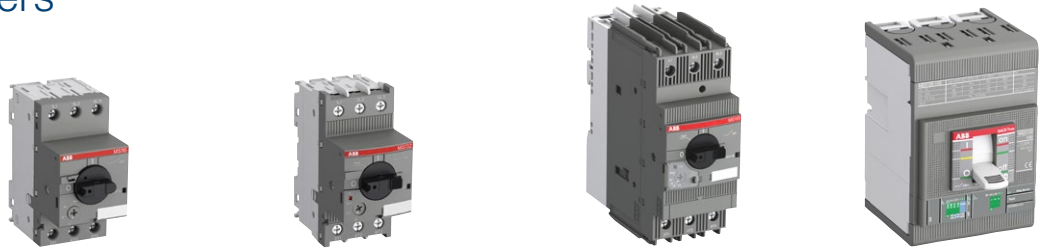

Type	MS116	MS132	MS165	MS5100
Thermal and electromagnetic protection	Yes	Yes	Yes	Yes
Electromagnetic protection	-	-	-	-
Phase loss sensitivity	Yes	Yes	Yes	-
Switch position	ON/OFF	ON/OFF/TRIP	ON/OFF/TRIP	ON/OFF/TRIP
Magnetic trip indication	-	Yes	Yes	-
Lockable handle without accessories	-	Yes	Yes	Yes
Disconnecting feature	Yes	Yes	Yes	Yes
Width	45 mm	45 mm	55 mm	90 mm
Rated operational current I_n	0.16 ... 32 A	0.16 ... 32 A	16 ... 65 A	100 A
Setting range	0.1 ... 32 A	0.1 ... 32 A	10 ... 65 A	40 ... 100 A
Ambient air temperature	-25 ... +55 °C ¹⁾	-25 ... +60 °C ¹⁾	-20 ... +60 °C ¹⁾	-25 ... +70 °C

¹⁾ Compensated

Accessories

Auxiliary contact	HKF1, HK1		AUX
Signalling contact for tripped alarm	SK1		-
Signalling contact for short-circuit alarm	-	CK1	-
Shunt trip	AA1		SOR-C
Undervoltage release	UA1		UVR-C

Table for short-circuit ratings for 400/415 V

Rated operational power	Setting range for thermal release	Type	Standard range MS116		Performance range MS132, MS165, MS5100		
			I_{CU}	I_{CS}	Type	I_{CU}	I_{CS}
0.03 kW ¹⁾	0.1 ... 0.16 A	MS116-0.16	50 kA	50 kA	MS132-0.16	100 kA	100 kA
0.06 kW	0.16 ... 0.25 A	MS116-0.25	50 kA	50 kA	MS132-0.25	100 kA	100 kA
0.09 kW	0.25 ... 0.4 A	MS116-0.4	50 kA	50 kA	MS132-0.4	100 kA	100 kA
0.18 kW	0.4 ... 0.63 A	MS116-0.63	50 kA	50 kA	MS132-0.63	100 kA	100 kA
0.25 kW	0.63 ... 1.0 A	MS116-1.0	50 kA	50 kA	MS132-1.0	100 kA	100 kA
0.55 kW	1.0 ... 1.6 A	MS116-1.6	50 kA	50 kA	MS132-1.6	100 kA	100 kA
0.75 kW	1.6 ... 2.5 A	MS116-2.5	50 kA	50 kA	MS132-2.5	100 kA	100 kA
1.5 kW	2.5 ... 4.0 A	MS116-4.0	50 kA	50 kA	MS132-4.0	100 kA	100 kA
2.2 kW	4.0 ... 6.3 A	MS116-6.3	50 kA	50 kA	MS132-6.3	100 kA	100 kA
4.0 kW	6.3 ... 10 A	MS116-10	50 kA	50 kA	MS132-10	100 kA	100 kA
5.5 kW	8 ... 12 A	MS116-12	25 kA	25 kA	MS132-12	100 kA	100 kA
7.5 kW	10 ... 16 A	MS116-16	16 kA	16 kA	MS132-16 / MS165-16	100 kA	100 kA
7.5 kW	14 ... 20 A				MS165-20	100 kA	100 kA
7.5 kW	16 ... 20 A	MS116-20	15 kA	10 kA	MS132-20	100 kA	100 kA
11 kW	18 ... 25 A				MS165-25	100 kA	100 kA
11 kW	20 ... 25 A	MS116-25	15 kA	10 kA	MS132-25	50 kA	50 kA
15 kW	25 ... 32 A	MS116-32	10 kA	10 kA	MS132-32	50 kA	25 kA
15 kW	23 ... 32 A				MS165-32	100 kA	75 kA
22 kW	30 ... 42 A				MS165-42	50 kA	25 kA
22 kW	40 ... 54 A				MS165-54	50 kA	25 kA
25 kW	-						
30 kW	52 ... 65 A				MS165-65	50 kA	25 kA
30 kW	-						
45 kW	40 ... 100 A				MS5100-100	70 kA	70 kA

¹⁾ 690 V



MO132	MO165	MO5100	MS132-T
-	-	-	Yes
Yes	Yes	Yes	-
-	-	-	Yes
ON/OFF/TRIP	ON/OFF/TRIP	ON/OFF/TRIP	ON/OFF/TRIP
-	-	-	Yes
Yes	Yes	Yes	Yes
Yes	Yes	Yes	Yes
45 mm	55 mm	76.2 mm	45 mm
0.16 ... 32 A	16 ... 65 A	70 ... 100 A	0.16 ... 32 A
-	-	-	0.1 ... 25 A
-25 ... +60 °C	-25 ... +60 °C	-25 ... +70 °C	-25 ... +60 °C ¹⁾

HKF1, HK1	AUX	HKF1
SK1	-	SK1
-	-	CK1
AA1	SOR-C	AA1
UA1	UVR-C	UA1

Standard range MO132	Performance range MO132, MO165, MO5100	Transformer protection MS132-T
-------------------------	---	-----------------------------------

Type	Short-circuit breaking capacity		Type	Short-circuit breaking capacity		Type	Short-circuit breaking capacity
	I _{cu}	I _{cs}		I _{cu}	I _{cs}		I _{cu} / I _{cs}
MO132-0.16	100 kA	100 kA	MO132-0.16	100 kA	100 kA	MS132-0.16T	100 kA
MO132-0.25	100 kA	100 kA	MO132-0.25	100 kA	100 kA	MS132-0.25T	100 kA
MO132-0.4	100 kA	100 kA	MO132-0.4	100 kA	100 kA	MS132-0.4T	100 kA
MO132-0.63	100 kA	100 kA	MO132-0.63	100 kA	100 kA	MS132-0.63T	100 kA
MO132-1.0	100 kA	100 kA	MO132-1.0	100 kA	100 kA	MS132-1.0T	100 kA
MO132-1.6	100 kA	100 kA	MO132-1.6	100 kA	100 kA	MS132-1.6T	100 kA
MO132-2.5	100 kA	100 kA	MO132-2.5	100 kA	100 kA	MS132-2.5T	100 kA
MO132-4.0	100 kA	100 kA	MO132-4.0	100 kA	100 kA	MS132-4.0T	100 kA
MO132-6.3	100 kA	100 kA	MO132-6.3	100 kA	100 kA	MS132-6.3T	100 kA
MO132-10	100 kA	100 kA	MO132-10	100 kA	100 kA	MS132-10T	100 kA
MO132-12	100 kA	100 kA	MO132-12	100 kA	100 kA	MS132-12T	100 kA
MO132-16	100 kA	100 kA	MO132-16 / MO165-16	100 kA	100 kA	MS132-16T	100 kA
			MO165-20	100 kA	100 kA		
MO132-20	100 kA	100 kA	MO132-20	100 kA	100 kA	MS132-20T	100 kA
MO132-25	50 kA	50 kA	MO132-25 / MO165-25	50 kA / 100 kA	50 kA / 100 kA	MS132-25T	50 kA
MO132-32	50 kA	25 kA	MO132-32	50 kA	25 kA	Transformer protection: The instantaneous short-circuit current setting is 20 times the rated operational current.	
			MO165-32	100 kA	50 kA		
			MO165-42	50 kA	25 kA		
			MO165-54	50 kA	25 kA		
			MO5100-70	36 kA	36 kA		
			MO165-65	50 kA	25 kA		
			MO5100-80	36 kA	36 kA		
			MO5100-100	36 kA	36 kA		

MS116 manual motor starters

0.10 to 32 A – with thermal and electromagnetic protection

2



2CDC241010F0011

MS116-16



2CDC241001F0011

MS116-25



2CDC241013F0011

MS116-0.16-HKF1-11



2CDC241012F0011

MS116-32-HKF1-11

Description

MS116 is a compact and economic range for motor protection up to 15 kW (400 V) / 32 A in width of 45 mm. Further features are the build-in disconnect function, temperature compensation, trip-free mechanism and a rotary handle with a clear switch position indication. The manual motor starter is suitable for three- and single-phase applications. Auxiliary contacts, signaling contacts, undervoltage releases, shunt trips, power in-feed blocks and locking devices for protection against unauthorized changes are available as accessory. These are suitable throughout the MS116/MS132/MS165-range.

Ordering details

Rated operational power 400 V AC-3 kW	Setting range A	Short-circuit breaking capacity I_{cs} at 400 V AC kA	Rated instantaneous short-circuit current setting I_i A	Type	Order code	Weight (1 pc) kg
0.03 ²⁾	0.10 ... 0.16	50	2.00 ¹⁾	MS116-0.16	1SAM250000R1001	0.225
0.06	0.16 ... 0.25	50	3.10 ¹⁾	MS116-0.25	1SAM250000R1002	0.225
0.09	0.25 ... 0.40	50	5.00 ¹⁾	MS116-0.4	1SAM250000R1003	0.225
0.18	0.40 ... 0.63	50	7.90 ¹⁾	MS116-0.63	1SAM250000R1004	0.225
0.25	0.63 ... 1.00	50	12.5 ¹⁾	MS116-1.0	1SAM250000R1005	0.225
0.55	1.00 ... 1.60	50	20.0 ¹⁾	MS116-1.6	1SAM250000R1006	0.265
0.75	1.60 ... 2.50	50	31.3 ¹⁾	MS116-2.5	1SAM250000R1007	0.265
1.50	2.50 ... 4.00	50	50.0	MS116-4.0	1SAM250000R1008	0.265
2.20	4.00 ... 6.30	50	78.8	MS116-6.3	1SAM250000R1009	0.265
4.00	6.30 ... 10.0	50	150	MS116-10	1SAM250000R1010	0.265
5.50	8.00 ... 12.0	25	180	MS116-12	1SAM250000R1012	0.265
7.50	10.0 ... 16.0	16	240	MS116-16	1SAM250000R1011	0.265
7.50	16.0 ... 20.0	10	300	MS116-20	1SAM250000R1013	0.310
11.0	20.0 ... 25.0	10	375	MS116-25	1SAM250000R1014	0.310
15.0	25.0 ... 32.0	10	480	MS116-32	1SAM250000R1015	0.310
0.03 ²⁾	0.10 ... 0.16	50	2.00 ¹⁾	MS116-0.16-HKF1-11	1SAM250005R1001	0.240
0.06	0.16 ... 0.25	50	3.10 ¹⁾	MS116-0.25-HKF1-11	1SAM250005R1002	0.240
0.09	0.25 ... 0.40	50	5.00 ¹⁾	MS116-0.4-HKF1-11	1SAM250005R1003	0.240
0.18	0.40 ... 0.63	50	7.90 ¹⁾	MS116-0.63-HKF1-11	1SAM250005R1004	0.240
0.25	0.63 ... 1.00	50	12.5 ¹⁾	MS116-1.0-HKF1-11	1SAM250005R1005	0.240
0.55	1.00 ... 1.60	50	20.0 ¹⁾	MS116-1.6-HKF1-11	1SAM250005R1006	0.280
0.75	1.60 ... 2.50	50	31.3 ¹⁾	MS116-2.5-HKF1-11	1SAM250005R1007	0.280
1.50	2.50 ... 4.00	50	50.0	MS116-4.0-HKF1-11	1SAM250005R1008	0.280
2.20	4.00 ... 6.30	50	78.8	MS116-6.3-HKF1-11	1SAM250005R1009	0.280
4.00	6.30 ... 10.0	50	150	MS116-10.0-HKF1-11	1SAM250005R1010	0.280
5.50	8.00 ... 12.0	25	180	MS116-12.0-HKF1-11	1SAM250005R1012	0.280
7.50	10.0 ... 16.0	16	240	MS116-16.0-HKF1-11	1SAM250005R1011	0.280
7.50	16.0 ... 20.0	10	300	MS116-20-HKF1-11	1SAM250005R1013	0.326
11.0	20.0 ... 25.0	10	375	MS116-25-HKF1-11	1SAM250005R1014	0.326
15.0	25.0 ... 32.0	10	480	MS116-32-HKF1-11	1SAM250005R1015	0.326

Note: Manual motor starters should always be selected so that the actual motor current is within the setting range.

¹⁾ The data is valid for products, produced after week 34, 2014.

²⁾ 690 V

Main dimensions mm, inches

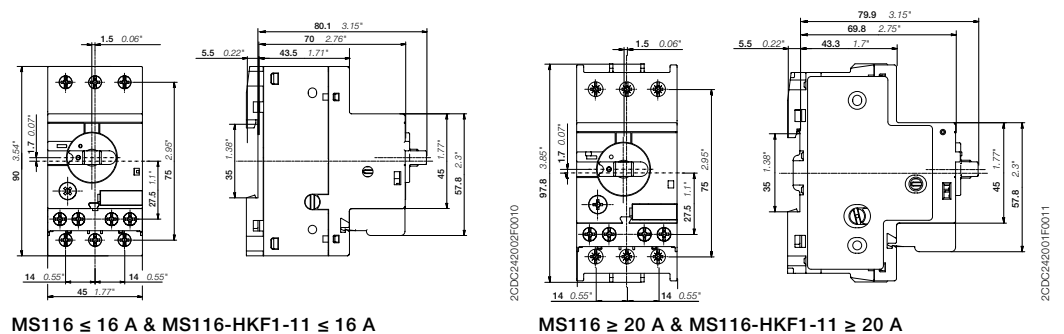

MS132 manual motor starters

0.10 to 32 A – with thermal and electromagnetic protection



1SEB101232F0010

MS132-10



2CDC241001F0011

MS132-32



2CDC241014F0011

MS132-0.16-HKF1-11



2CDC241015F0011

MS132-32-HKF1-11

Description

MS132 is a compact and powerful range for motor protection up to 15 kW (400 V) / 32 A in width of 45 mm. This type has also a clear and reliable indication of fault in a separate window in the event of short-circuit tripping. Further features are the build-in disconnect function, temperature compensation, trip-free mechanism and a rotary handle with a clear switch position indication. The manual motor starter is suitable for three- and single-phase applications. The handle is lockable to protect against unauthorized changes. Auxiliary contacts, signaling contacts, undervoltage releases, shunt trips, power in-feed blocks are available as accessory. These are suitable throughout the MS116/MS132/MS165-range.

Ordering details

Rated operational power 400 V AC-3	Setting range	Short-circuit breaking capacity I_{cs} at 400 V AC	Rated instantaneous short-circuit current setting I_i	Type	Order code	Weight (1 pc)
0.03 ²⁾	0.10 ... 0.16	100	2.00 ¹⁾	MS132-0.16	1SAM350000R1001	0.215
0.06	0.16 ... 0.25	100	3.10 ¹⁾	MS132-0.25	1SAM350000R1002	0.215
0.09	0.25 ... 0.40	100	5.00 ¹⁾	MS132-0.4	1SAM350000R1003	0.215
0.18	0.40 ... 0.63	100	7.90 ¹⁾	MS132-0.63	1SAM350000R1004	0.215
0.25	0.63 ... 1.00	100	12.5 ¹⁾	MS132-1.0	1SAM350000R1005	0.215
0.55	1.00 ... 1.60	100	20.0 ¹⁾	MS132-1.6	1SAM350000R1006	0.265
0.75	1.60 ... 2.50	100	31.3 ¹⁾	MS132-2.5	1SAM350000R1007	0.265
1.50	2.50 ... 4.00	100	50.0	MS132-4.0	1SAM350000R1008	0.265
2.20	4.00 ... 6.30	100	78.8	MS132-6.3	1SAM350000R1009	0.265
4.00	6.30 ... 10.0	100	150	MS132-10	1SAM350000R1010	0.265
5.50	8.00 ... 12.0	100	180	MS132-12	1SAM350000R1012	0.310
7.50	10.0 ... 16.0	100	240	MS132-16	1SAM350000R1011	0.310
7.50	16.0 ... 20.0	100	300	MS132-20	1SAM350000R1013	0.310
11.0	20.0 ... 25.0	50	375	MS132-25	1SAM350000R1014	0.310
15.0	25.0 ... 32.0	25	480	MS132-32	1SAM350000R1015	0.310
0.03 ²⁾	0.10 ... 0.16	100	2.00 ¹⁾	MS132-0.16-HKF1-11	1SAM350005R1001	0.231
0.06	0.16 ... 0.25	100	3.10 ¹⁾	MS132-0.25-HKF1-11	1SAM350005R1002	0.231
0.09	0.25 ... 0.40	100	5.00 ¹⁾	MS132-0.4-HKF1-11	1SAM350005R1003	0.231
0.18	0.40 ... 0.63	100	7.90 ¹⁾	MS132-0.63-HKF1-11	1SAM350005R1004	0.231
0.25	0.63 ... 1.00	100	12.5 ¹⁾	MS132-1.0-HKF1-11	1SAM350005R1005	0.231
0.55	1.00 ... 1.60	100	20.0 ¹⁾	MS132-1.6-HKF1-11	1SAM350005R1006	0.281
0.75	1.60 ... 2.50	100	31.3 ¹⁾	MS132-2.5-HKF1-11	1SAM350005R1007	0.281
1.50	2.50 ... 4.00	100	50.0	MS132-4.0-HKF1-11	1SAM350005R1008	0.281
2.20	4.00 ... 6.30	100	78.8	MS132-6.3-HKF1-11	1SAM350005R1009	0.281
4.00	6.30 ... 10.0	100	150	MS132-10.0-HKF1-11	1SAM350005R1010	0.281
5.50	8.00 ... 12.0	100	180	MS132-12.0-HKF1-11	1SAM350005R1012	0.326
7.50	10.0 ... 16.0	100	240	MS132-16.0-HKF1-11	1SAM350005R1011	0.326
7.50	16.0 ... 20.0	100	300	MS132-20-HKF1-11	1SAM350005R1013	0.326
11.0	20.0 ... 25.0	50	375	MS132-25-HKF1-11	1SAM350005R1014	0.326
15.0	25.0 ... 32.0	25	480	MS132-32-HKF1-11	1SAM350005R1015	0.326

Note: Manual motor starters should always be selected so that the actual motor current is within the setting range.

¹⁾ The data is valid for products, produced after week 34, 2014.

²⁾ 690 V

Main dimensions mm, inches

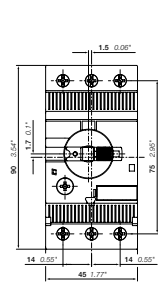

MS132 ≤ 10 A

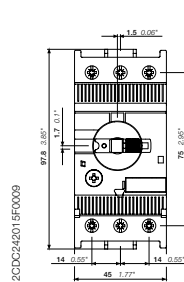
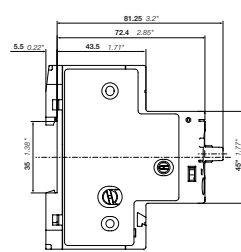

MS132 ≥ 12 A

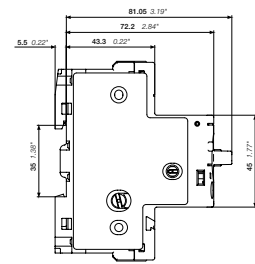

MS165 manual motor starters

10 to 65 A – with thermal and electromagnetic protection

2



MS165-65

2CDC241004V0015

Description

MS165 is a compact and powerful range for motor protection up to 30 kW (400 V) / 65 A in width of 55 mm. This type has also a clear and reliable indication of fault in a separate window in the event of short-circuit tripping. Further features are the build-in disconnect function, temperature compensation, trip-free mechanism and a rotary handle with a clear switch position indication. The manual motor starter is suitable for three- and single-phase applications. The handle is lockable to protect against unauthorized changes. Auxiliary contacts, signaling contacts, undervoltage releases, shunt trips, power in-feed blocks are available as accessory. These are suitable throughout the MS116/MS132/MS165-range.

Ordering details

Rated operational power 400 V AC-3	Setting range	Short-circuit breaking capacity I_{cs} at 400 V AC	Rated instantaneous short-circuit current setting I_i	Type	Order code	Weight (1 pc)
kW	A	kA	A			kg
7.5	10 ... 16	100	240	MS165-16	1SAM451000R1011	0.950
7.5	14 ... 20	100	300	MS165-20	1SAM451000R1012	0.950
11	18 ... 25	100	375	MS165-25	1SAM451000R1013	0.960
15	23 ... 32	75	480	MS165-32	1SAM451000R1014	0.970
22	30 ... 42	25	630	MS165-42	1SAM451000R1015	0.970
22	40 ... 54	25	810	MS165-54	1SAM451000R1016	0.970
30	52 ... 65	25	975	MS165-65	1SAM451000R1017	0.980

Note: Manual motor starters should always be selected so that the actual motor current is within the setting range.

Main dimensions mm, inches

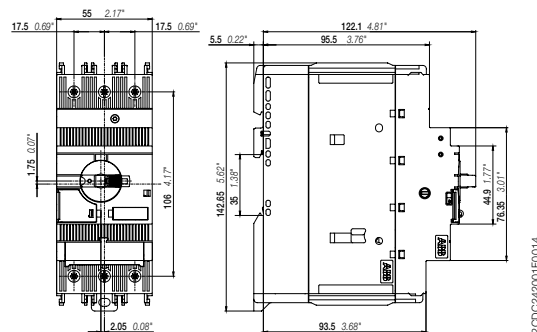

MS165

2CDC242001F0014

2CDC131062C0201a

MO132 manual motor starters magnetic only 0.16 to 32 A – with electromagnetic protection



MO132-6.3

2CDC241008F0011



MO132-32

2CDC241008F0011

Description

Manual motor starters magnetic only are electromechanical protection devices for the main circuit. They are used mainly to switch motors manually ON/OFF and protect them fuse-less against short-circuit.

Fuse-less protection with a manual motor starter saves costs, space and ensures a quick reaction under short-circuit condition, by switching off the motor within milliseconds. Fuse-less starter combinations are setup together with contactors and overload relays.

Ordering details

Rated operational power 400 V AC-3 ¹⁾	Rated operational current	Short-circuit breaking capacity I_{cs} at 400 V AC	Rated instantaneous short-circuit current setting I_i	Type	Order code	Weight (1 pc)
kW	A	kA	A			kg
0.03 ³⁾	0.16	100	2.00 ²⁾	MO132-0.16	1SAM360000R1001	0.215
0.06	0.25	100	3.10 ²⁾	MO132-0.25	1SAM360000R1002	0.215
0.09	0.40	100	5.00 ²⁾	MO132-0.4	1SAM360000R1003	0.215
0.12	0.63	100	7.90 ²⁾	MO132-0.63	1SAM360000R1004	0.215
0.25	1.0	100	12.5 ²⁾	MO132-1.0	1SAM360000R1005	0.215
0.55	1.6	100	20.0 ²⁾	MO132-1.6	1SAM360000R1006	0.265
0.75	2.5	100	31.3 ²⁾	MO132-2.5	1SAM360000R1007	0.265
1.5	4.0	100	50.0	MO132-4.0	1SAM360000R1008	0.265
2.2	6.3	100	78.8	MO132-6.3	1SAM360000R1009	0.265
4.0	10	100	125	MO132-10	1SAM360000R1010	0.265
5.5	12	100	150	MO132-12	1SAM360000R1012	0.310
7.5	16	100	200	MO132-16	1SAM360000R1011	0.310
7.5	20	100	250	MO132-20	1SAM360000R1013	0.310
11	25	50	313	MO132-25	1SAM360000R1014	0.310
15	32	25	400	MO132-32	1SAM360000R1015	0.310

¹⁾ For overload protection of motors, an appropriate thermal or electronic overload relay must be used

²⁾ The data is valid for products, produced after week 34, 2014.

³⁾ 690 V

Main dimensions mm, inches

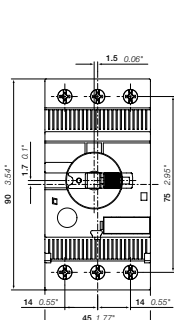

MO132 ≤ 10 A

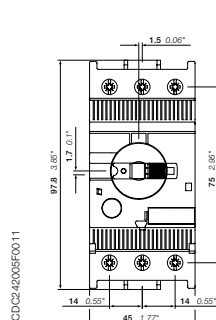
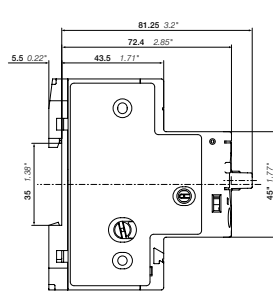

MO132 ≥ 12 A

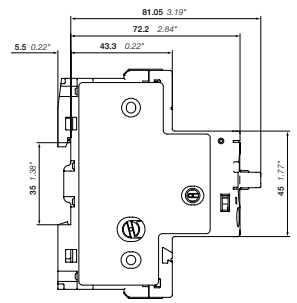

2CDC242008F0011

2CDC131062C0201a

MO165 manual motor starters magnetic only 16 to 65 A – with electromagnetic protection

2



MO165-65

2CDC241005V0015

Description

Manual motor starters magnetic only are electromechanical protection devices for the main circuit. They are used mainly to switch motors manually ON/OFF and protect them fuse-less against short-circuit. Fuse-less protection with a manual motor starter saves costs, space and ensures a quick reaction under short-circuit condition, by switching off the motor within milliseconds. Fuse-less starter combinations are setup together with contactors and overload relays.

Ordering details

Rated operational power 400 V AC-3 kW	Rated operational current A	Short-circuit breaking capacity I_{cs} at 400 V AC kA	Rated instantaneous short-circuit current setting I_i A	Type	Order code	Weight (1 pc) kg
7.5	16	100	240	MO165-16	1SAM461000R1011	0.950
7.5	20	100	300	MO165-20	1SAM461000R1012	0.950
11	25	100	375	MO165-25	1SAM461000R1013	0.960
15	32	50	480	MO165-32	1SAM461000R1014	0.970
22	42	25	630	MO165-42	1SAM461000R1015	0.970
22	54	25	810	MO165-54	1SAM461000R1016	0.970
30	65	25	975	MO165-65	1SAM461000R1017	0.980

Main dimensions mm, inches

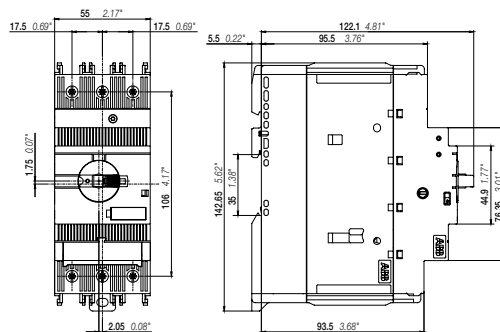

MO165

2CDC24002F0014

2CDC131062C0201a

MS132-T circuit breakers for transformer protection

0.10 to 25 A – with thermal and electromagnetic protection



MS132-10T



MS132-25T

Description

Circuit breakers for transformer protection are electro mechanical protection devices specially designed to protect control transformers on the primary side. They allow fuse-less protection against overload and short-circuit, saving space and cost and ensuring a quick reaction under short-circuit condition by switching off the transformer within milliseconds. The short-circuit current setting is fixed to 20 times the operating current to handle the high inrush current generated by transformers. The device allows manual connection and disconnection of the transformer from the mains.

MS132-T is a 45 mm (width) compact and powerful range for transformer protection up to 12.5 kW (400 V) / 25 A. This type has also a clear and reliable indication of fault in a separate window in the event of short-circuit tripping. Further features are the build-in disconnect function, temperature compensation, trip-free mechanism and a rotary handle with a clear switch position indication. The handle is lockable to protect against unauthorized changes. Auxiliary contacts, signaling contacts, undervoltage releases, shunt trips, power in-feed blocks are available as accessory. These are suitable throughout the MS116/MS132/MS165-range. Moreover ABB offers special accessories for fast single-phase setup.

Ordering details

Setting range A	Short-circuit breaking capacity I_{cs} at 400 V AC kA	Rated instantaneous short-circuit current setting I_i A	Type	Order code	Weight (1 pc) kg
0.10 ... 0.16	100	3.2	MS132-0.16T	1SAM340000R1001	0.215
0.16 ... 0.25	100	5	MS132-0.25T	1SAM340000R1002	0.215
0.25 ... 0.40	100	8	MS132-0.4T	1SAM340000R1003	0.215
0.40 ... 0.63	100	12.6	MS132-0.63T	1SAM340000R1004	0.215
0.63 ... 1.00	100	20	MS132-1.0T	1SAM340000R1005	0.215
1.00 ... 1.60	100	32	MS132-1.6T	1SAM340000R1006	0.265
1.60 ... 2.50	100	50	MS132-2.5T	1SAM340000R1007	0.265
2.50 ... 4.00	100	80	MS132-4.0T	1SAM340000R1008	0.265
4.00 ... 6.30	100	126	MS132-6.3T	1SAM340000R1009	0.265
6.30 ... 10.0	100	200	MS132-10T	1SAM340000R1010	0.265
8.00 ... 12.0	100	240	MS132-12T	1SAM340000R1012	0.310
10.0 ... 16.0	100	320	MS132-16T	1SAM340000R1011	0.310
16.0 ... 20.0	100	400	MS132-20T	1SAM340000R1013	0.310
20.0 ... 25.0	50	500	MS132-25T	1SAM340000R1014	0.310

Please check for single-phase equipment chapter Main accessories.

Main dimensions mm, inches

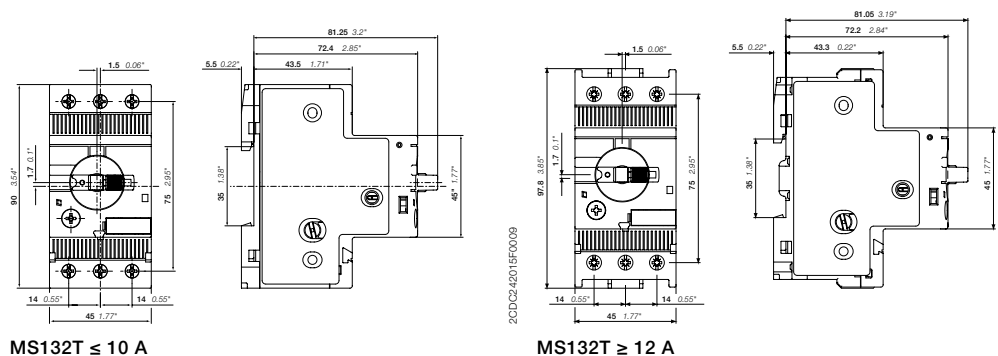

Main accessories

MS116, MS132, MS165, MO132, MO165, MS132-T

Manual motor starters with accessories (MS116, MO132, MO165)

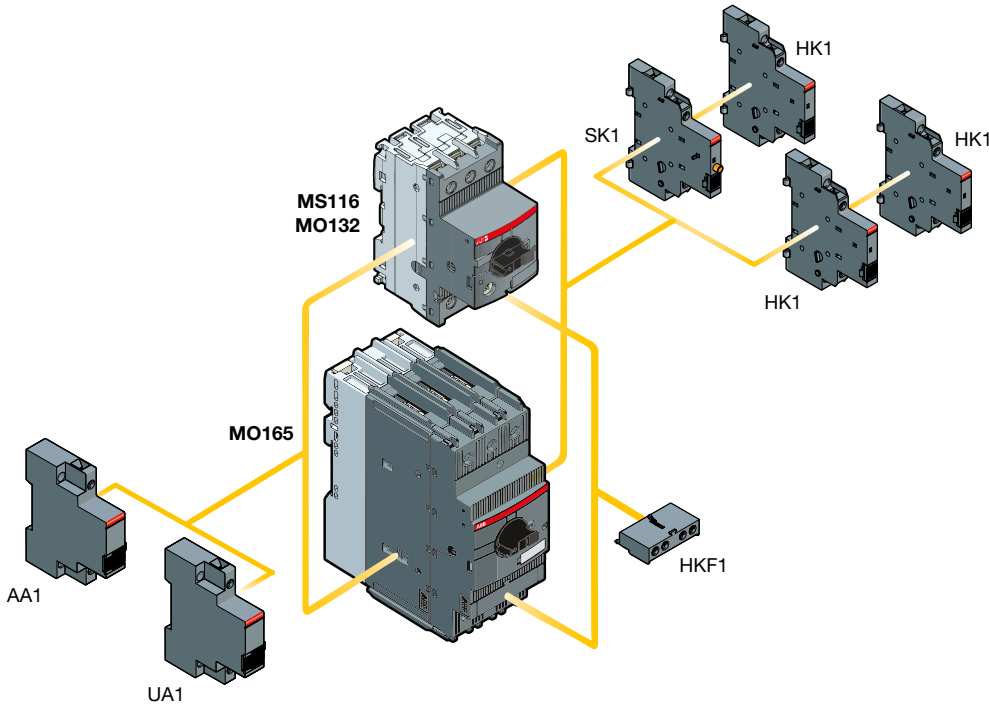

2CDC242001F0015

Manual motor starters with accessories (MS132, MS165) and circuit breaker for transformer protection (MS132-T)

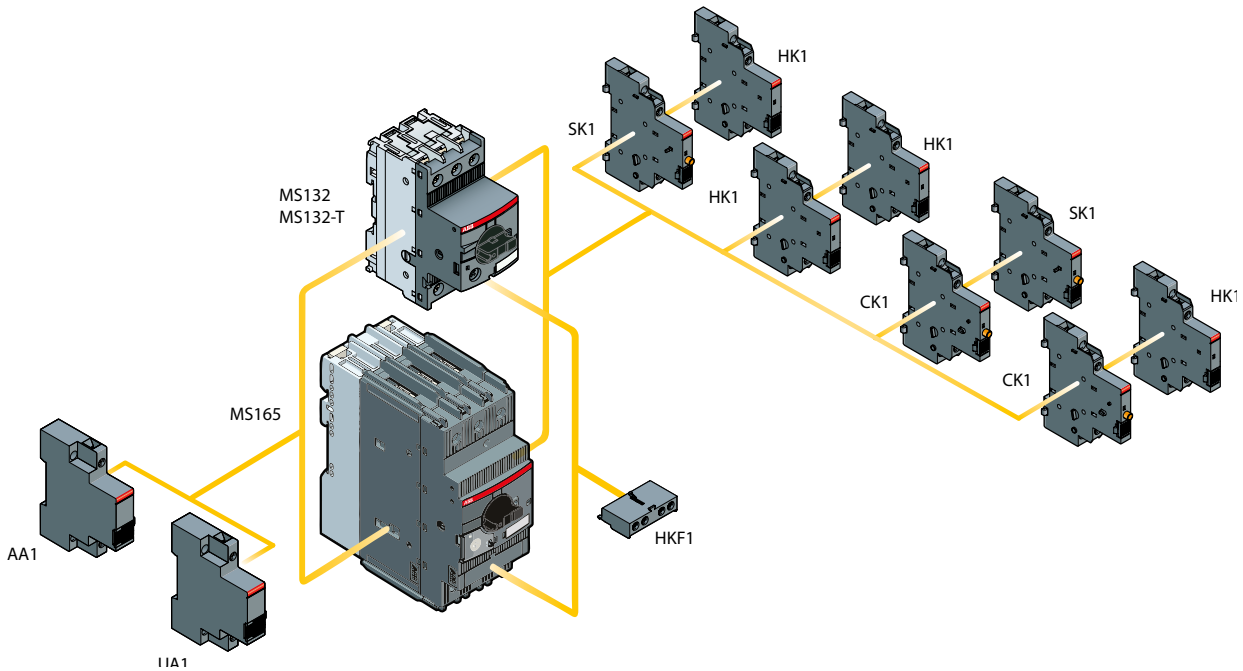

2CDC242001F0015

2CDC131050C0201a

Main accessories

MS116, MS132, MS165, MO132, MO165, MS132-T



HKF1-11

1SBC101208F0014



HK1-11

1SBC101208F0014



SK1-11

1SBC101210F0014



CK1-11

1SBC101288F0014

Description

MMS and MS132-T can be equipped with auxiliary contacts for lateral/front mounting, signaling contacts for lateral mounting, undervoltage releases and shunt trips. Two different signaling contacts are available. The accessories can be fitted wiring free and without tools. A variety of combinations is possible as required for the application. The auxiliary contacts change position with the main contacts. The signaling contact SK signals tripping regardless if it was caused by short-circuit or overload. The signaling contact CK signals tripping in case it was caused by short-circuit. Undervoltage releases are used for remote tripping of the manual motor starters especially for emergency stop circuits. Shunt trips release the MMS used for remote tripping. These main accessories are suitable throughout the MS116/MS132/MS165-range.

Ordering details

Suitable for	Auxiliary contacts N.O.	Auxiliary contacts N.C.	Description	Type	Order code	Pkg qty	Weight (1 pc)
						pcs	kg
Auxiliary contacts – mountable on the front							
MS116,	1	1		HKF1-11	1SAM201901R1001	10	0.015
MS132, MS165	1	0		HKF1-10	1SAM201901R1003	10	0.013
MO132, MO165	0	1		HKF1-01	1SAM201901R1004	10	0.013
MS132-T	2	0		HKF1-20	1SAM201901R1002	10	0.015
Auxiliary contacts – mountable on the right							
MS116,	1	1	max. 2 pieces	HK1-11	1SAM201902R1001	2	0.035
MS132, MS165	2	0	max. 2 pieces	HK1-20	1SAM201902R1002	2	0.035
MO132, MO165	0	2	max. 2 pieces	HK1-02	1SAM201902R1003	2	0.035
MS132-T	2	0	with lead contacts	HK1-20L	1SAM201902R1004	2	0.035
Signaling contacts – mountable on the right							
MS116,	1	1	for tripped alarm, max. 2 pieces	SK1-11	1SAM201903R1001	2	0.035
MS132, MS165	2	0	for tripped alarm, max. 2 pieces	SK1-20	1SAM201903R1002	2	0.035
MO132, MO165	0	2	for tripped alarm, max. 2 pieces	SK1-02	1SAM201903R1003	2	0.035
MS132-T	2	0	for tripped alarm, max. 2 pieces	SK1-20L	1SAM201903R1004	2	0.035
MS132, MS165,	1	1	for short-circuit alarm, max. 2 pieces	CK1-11	1SAM301901R1001	2	0.035
MS132-T	2	0	for short-circuit alarm, max. 2 pieces	CK1-20	1SAM301901R1002	2	0.035
	0	2	for short-circuit alarm, max. 2 pieces	CK1-02	1SAM301901R1003	2	0.035

Main dimensions mm, inches

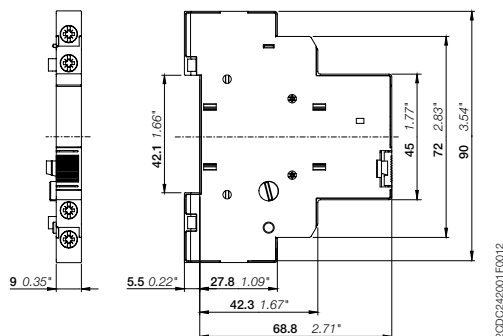

HK1

2CDC242001F0012

2CDC131050C0201a

Main accessories

MS116, MS132, MS165, MO132, MO165, MS132-T

2



AA1-24

1SBC101211F0014



UA1-24

1SBC101212F0014

Ordering details

Suitable for	Rated control supply voltage		Type	Order code	Pkg qty	Weight (1 pc)
	50 Hz V AC	60 Hz V AC				
Shunt trips – mountable on the left						
MS116, MS132, MS165, MO132, MO165, MS132-T	20 ... 24	20 ... 24	AA1-24	1SAM201910R1001	1	0.100
	110	110	AA1-110	1SAM201910R1002	1	0.100
	200 ... 240	200 ... 240	AA1-230	1SAM201910R1003	1	0.100
	350 ... 415	350 ... 415	AA1-400	1SAM201910R1004	1	0.100
Undervoltage releases – mountable on the left						
MS116, MS132, MS165, MO132, MO165, MS132-T	20	24	UA1-20	1SAM201904R1010	1	0.100
	24	-	UA1-24	1SAM201904R1001	1	0.100
	48	-	UA1-48	1SAM201904R1002	1	0.100
	60	-	UA1-60	1SAM201904R1003	1	0.100
	110	120	UA1-110	1SAM201904R1004	1	0.100
	-	208	UA1-208	1SAM201904R1008	1	0.100
	230	240	UA1-230	1SAM201904R1005	1	0.100
	400	-	UA1-400	1SAM201904R1006	1	0.100
	415	480	UA1-415	1SAM201904R1007	1	0.100
	-	575	UA1-575	1SAM201904R1009	1	0.100

Main dimensions mm, inches

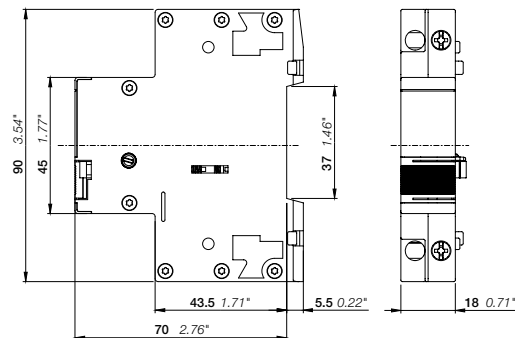

AA1, UA1

2DCDC242002F0012

2CDC131050C0201a

Main accessories

MS116, MS132, MS165, MO132, MO165

Manual motor starter with three-phase busbar systems (MS116, MS132, MO132)

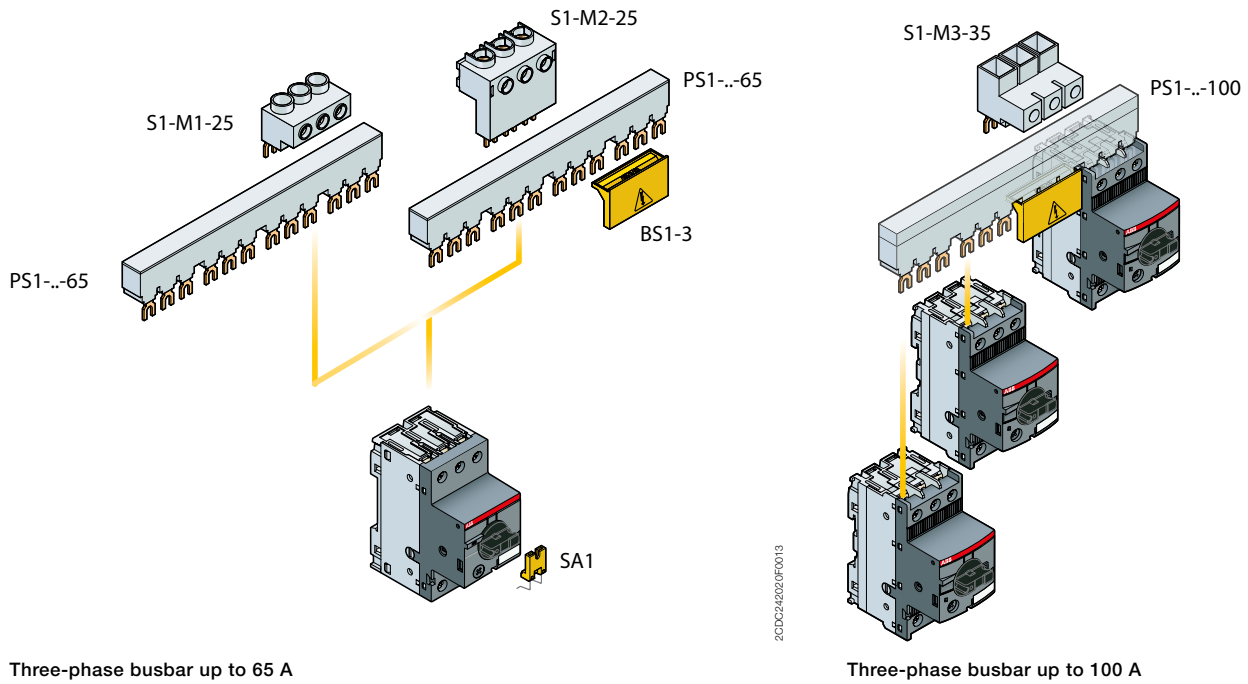

Manual motor starter with three-phase busbar systems (MS165, MO165)

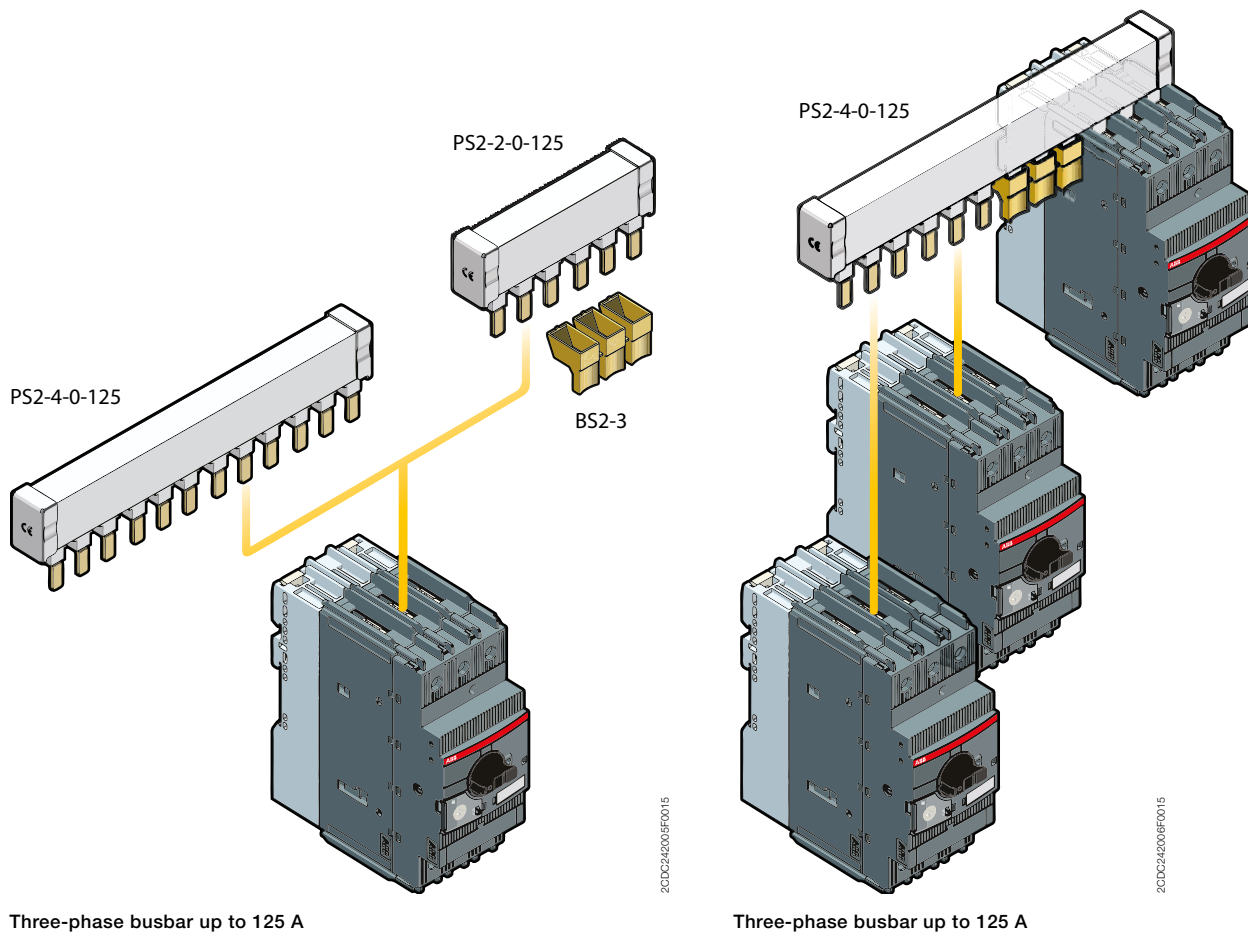

Main accessories

MS116, MS132, MO132, MS132-T

2

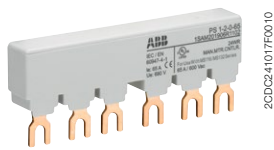

PS1-2-0-65

2CDC241017F0010

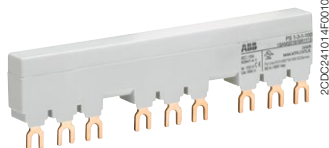

PS1-3-1-100

2CDC241014F0010

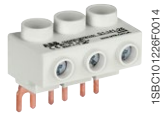

S1-M1-25

1SBC101226F0014



S1-M2-25

1SBC101266F0014



SA2

2CDC241023F0013



SA1

SK0108B91



PB1-1-32

2CDC241004R0014



S1-PB1-25

2CDC241005S0014

Description

Three-phase busbars ensure a quick and safe connection and are therefore a cost effective solution. A variety of different three-phase busbars up to 100 A are in the assortment. Between 2 and 5 manual motor starters with none, one or two lateral auxiliary contacts can be connected. Different three-phase feeder terminals are available according to the application.

Phase connecting links and phase power infeed blocks are also available for single-phase applications.

Ordering details

Suitable for	Rated operational current	Number of MMS	Number of lateral aux.	Type	Order code	Pkg qty	Weight (1 pc)
	A					pcs	kg
Three-phase busbars							
MS116, MS132, MO132	65	2	0	PS1-2-0-65	1SAM201906R1102	10	0.034
	65	3	0	PS1-3-0-65	1SAM201906R1103	10	0.055
	65	4	0	PS1-4-0-65	1SAM201906R1104	10	0.077
	65	5	0	PS1-5-0-65	1SAM201906R1105	10	0.098
	65	2	1	PS1-2-1-65	1SAM201906R1112	10	0.036
	65	3	1	PS1-3-1-65	1SAM201906R1113	10	0.060
	65	4	1	PS1-4-1-65	1SAM201906R1114	10	0.087
	65	5	1	PS1-5-1-65	1SAM201906R1115	10	0.108
	65	2	2	PS1-2-2-65	1SAM201906R1122	10	0.040
	65	3	2	PS1-3-2-65	1SAM201906R1123	10	0.067
	65	4	2	PS1-4-2-65	1SAM201906R1124	10	0.095
	65	5	2	PS1-5-2-65	1SAM201906R1125	10	0.122
MS116, MS132, MO132	100	3	0	PS1-3-0-100	1SAM201916R1103	10	0.084
	100	4	0	PS1-4-0-100	1SAM201916R1104	10	0.117
	100	5	0	PS1-5-0-100	1SAM201916R1105	10	0.154
	100	3	1	PS1-3-1-100	1SAM201916R1113	10	0.094
	100	4	1	PS1-4-1-100	1SAM201916R1114	10	0.134
	100	5	1	PS1-5-1-100	1SAM201916R1115	10	0.172
	100	3	2	PS1-3-2-100	1SAM201916R1123	10	0.105

Suitable for	Rated operational current	Rated cross section	Mounting form	Type	Order code	Pkg qty	Weight (1 pc)
	A	mm ²				pcs	kg
Three-phase feeder terminals							
MS116, MS132, MO132	65	25	Flat	S1-M1-25	1SAM201907R1101	10	0.038
	65	25	High	S1-M2-25	1SAM201907R1102	10	0.051
	65	25	UL/CSA Type E/F and IEC	S1-M3-25	1SAM201907R1103	10	0.042
	100	35	UL/CSA Type E/F and IEC	S1-M3-35	1SAM201913R1103	10	0.060

Suitable for	Description	Type	Order code	Pkg qty	Weight (1 pc)
				pcs	kg
MS116, MS132, MO132	Protection cover for busbars	BS1-3	1SAM201908R1001	50	0.003
MS116, MS132, MO132, MS132-T	Screw fixing kit	FS116	1SAM201909R1001	1	0.020
	Padlock + two keys	SA2	GJF1101903R0002	10	0.020
MS116	Lock handle	SA1	GJF1101903R0001	10	0.003
	Lock handle box SA1/SA2	SA3	GJF1101903R0003	10	0.050

Accessories for single-phase connection (IEC only)

MS116, MS132, MO132, MS132-T	Phase connecting link	PB1-1-32	1SAM201914R1001	1	0.009
	Phase power infeed block	S1-PB1-25	1SAM201914R1002	1	0.013

Main accessories

MS165, MO165

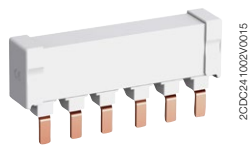

PS2-2-0-125

2CDC241002V0015

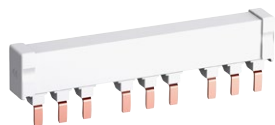

PS2-3-0-125

2CDC241003V0015



KA165

2CDC241010V0014



BS2-3

2CDC241001V0015



SA2

2CDC241023F0013

Description

Three-phase busbars ensure a quick and safe connection and are therefore a cost effective solution. A variety of different three-phase busbars up to 125 A are in the assortment. Between 2 and 5 manual motor starters with none, one or two lateral auxiliary contacts can be connected.

Ordering details

Suitable for	Rated operational current A	Number of MMS	Number of lateral aux.	Type	Order code	Pkg qty pcs	Weight (1 pc) kg
Three-phase busbars							
MS165,	125	2	0	PS2-2-0-125	1SAM401920R1002	10	0.100
	125	3	0	PS2-3-0-125	1SAM401920R1003	10	0.162
MO165	125	4	0	PS2-4-0-125	1SAM401920R1004	10	0.226
	125	2	2	PS2-2-2-125	1SAM401920R1022	10	0.117
	125	3	2	PS2-3-2-125	1SAM401920R1023	10	0.197
	125	4	2	PS2-4-2-125	1SAM401920R1024	10	0.277

Other busbar types on request.

Suitable for	Description	Type	Order code	Pkg qty pcs	Weight (1 pc) kg
MS165, MO165	Terminal shroud	KA165	1SAM401922R1001	10	0.025
	Protection cover for busbars	BS2-3	1SAM401921R1001	50	0.005
	Padlock + two keys	SA2	GJF1101903R0002	10	0.020

Main accessories

MS116, MS132, MO132

2



2CDC241004F0010

IB132-Y



2CDC241003F0010

IB132-G



2CDC241002F0010

DMS132-Y



2CDC241001F0010

DMS132-G

Description

IB132 are IP65 (UL/CSA Type 12) enclosures for single MMS installation. Additional mounting of auxiliary and signaling contacts, shunt trips and undervoltage release is possible. The handle is lockable in OFF position. For detailed specification see installation instruction.

DMS132 are IP65 (UL/CSA Type 12) door mounting kits for MMS installation in any enclosure. Additional mounting of auxiliary, signaling, shunt trips and undervoltage release is possible. The handle is lockable in OFF position. For detailed specification see installation instruction.

Ordering details

Suitable for	Description	Color	Type	Order code	Pkg qty	Weight (1 pc)
					pcs	kg
IP65 enclosures (UL/CSA Type 12)						
MS116, MS132, MO132	Padlockable max. 3 padlocks with bail diameter 4 ... 6.5 mm	Yellow/red	IB132-Y	1SAM201911R1011	1	0.370
		Grey/black	IB132-G	1SAM201911R1010	1	0.370
IP65 door mounting kits (UL/CSA Type 12)						
MS116, MS132, MO132	Padlockable max. 3 padlocks with bail diameter 4 ... 6.5 mm	Yellow/red	DMS132-Y	1SAM201912R1011	1	0.170
		Grey/black	DMS132-G	1SAM201912R1010	1	0.170

Indication I-O-T and ON-OFF-T

Please check for further equipment chapter General accessories.

Main dimensions mm, inches

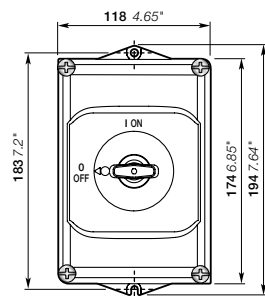

IB132

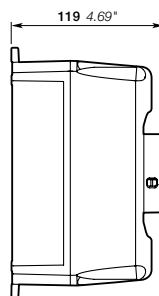

2CDC242011F0011

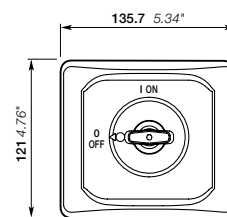

DMS132

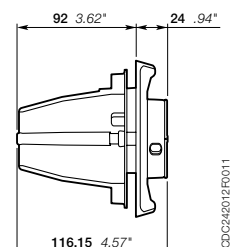

2CDC242012F0011

2CDC131050C0201a

MS5100, MS495, MS497 manual motor starters

22 to 100 A – with thermal and electromagnetic protection



MS5100-100



MS495-40



MS497-100

Description

Manual motor starters (MMS) are protection devices for the main circuit. They combine motor control and protection in a single device. MMS are used mainly to switch motors manually ON/OFF and protect them and the installation fuse-less against short-circuit, overload and phase failures ¹⁾. Fuse-less protection with a manual motor starter saves costs, space and ensures a quick reaction under short-circuit condition, by switching off the motor within milliseconds.

Ordering details

Rated operational power 400 V AC-3 kW	Setting range A	Short-circuit breaking capacity I_{cs} at 400 V AC kA	Rated instantaneous short-circuit current setting I_t A	Type	Order code	Weight (1 pc) kg
MS5100 manual motor starters						
45	40 ... 100	70	600 ... 1300	MS5100-100	1SDA082034R1	1.200
MS495 manual motor starters						
30	45 ... 63	25	819	MS495-63	1SAM550000R1007	2.247
37	57 ... 75	25	975	MS495-75	1SAM550000R1008	2.253
45	70 ... 90	25	1170	MS495-90	1SAM550000R1009	2.280
55	80 ... 100	25	1235	MS495-100	1SAM550000R1010	2.295
MS497 manual motor starters						
15	22 ... 32	50	416	MS497-32	1SAM580000R1004	2.222
18.5	28 ... 40	50	520	MS497-40	1SAM580000R1005	2.203
22	36 ... 50	50	650	MS497-50	1SAM580000R1006	2.230
30	45 ... 63	50	819	MS497-63	1SAM580000R1007	2.255
37	57 ... 75	50	975	MS497-75	1SAM580000R1008	2.266
45	70 ... 90	50	1170	MS497-90	1SAM580000R1009	2.268
55	80 ... 100	50	1235	MS497-100	1SAM580000R1010	2.275

¹⁾ The MS49x range offers phase loss sensitivity

Main dimensions mm, inches

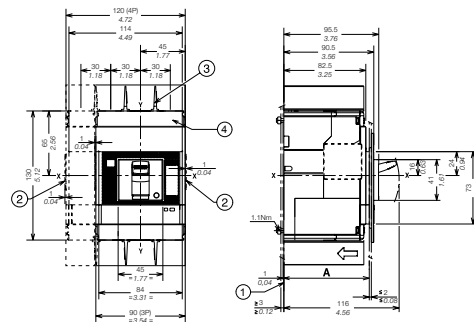

MS5100

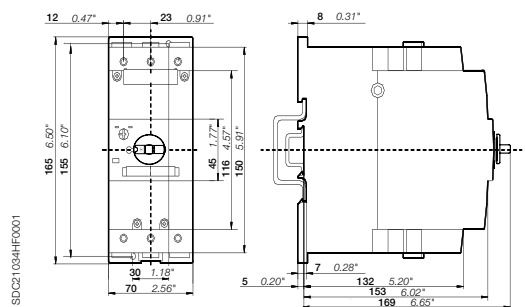

MS495, MS497

MO5100, MO495, MO496 manual motor starters magnetic only 32 to 100 A – with electromagnetic protection

2



MO5100-100 no mirror

MO5100-100



STO2801

MO495-75



2CDC241021F0011

MO496-100

Description

The manual motor starter magnetic only is used to manually switch on and off motors and to protect them reliably and without the need for a fuse from short-circuits.

Ordering details

Rated operational power 400 V AC-3 ¹⁾ kW	Rated operational current A	Short-circuit breaking capacity I_{cs} at 400 V AC kA	Rated instantaneous short-circuit current setting I_i A	Type	Order code	Weight (1 pc) kg
MO5100 manual motor starter magnetic only						
25	70	36 ²⁾	210 ... 770	MO5100-70	1SDA082031R1	1.100
30	80	36 ²⁾	240 ... 880	MO5100-80	1SDA082032R1	1.100
45	100	36 ²⁾	300 ... 1100	MO5100-100	1SDA082033R1	1.100
MO495 manual motor starter magnetic only						
30	63	25	819	MO495-63	1SAM560000R1007	2.244
37	75	25	975	MO495-75	1SAM560000R1008	2.247
45	90	25	1170	MO495-90	1SAM560000R1009	2.269
55	100	25	1235	MO495-100	1SAM560000R1010	2.292
MO496 manual motor starter magnetic only						
15	32	50	416	MO496-32	1SAM590000R1004	2.208
18.5	40	50	520	MO496-40	1SAM590000R1005	2.218
22	50	50	650	MO496-50	1SAM590000R1006	2.218
30	63	50	819	MO496-63	1SAM590000R1007	2.248
37	75	50	975	MO496-75	1SAM590000R1008	2.278
45	90	50	1170	MO496-90	1SAM590000R1009	2.266
55	100	50	1235	MO496-100	1SAM590000R1010	2.293

¹⁾ For overload protection of motors, an appropriate thermal or electronic overload relay must be used

²⁾ I_{cs} at 415 V AC

Main dimensions mm, inches

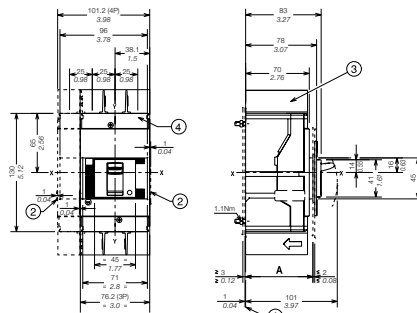

MO5100

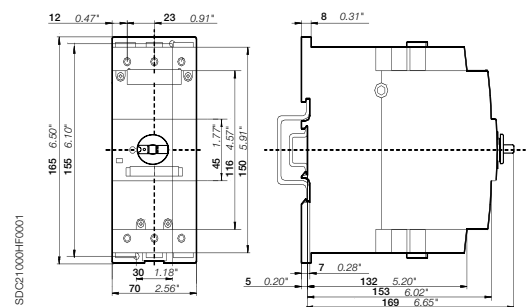

MO495, MO496

Main accessories

MS5100, MO5100 manual motor starters



XT AUX-Con cable/01



XT SOR-Con cable/01



1SDCA1026E0001

Description

Manual motor starters can be equipped with auxiliary contacts, undervoltage release and shunt trips. Undervoltage release are used for remote tripping of the manual motor starter especially for emergency stop circuits. Shunt trips release the MMS used for remote tripping. For this manual motor starter range we also offer key lock solutions for customer applications.

Ordering details

Suitable for	Auxiliary contacts N.O.	Auxiliary contacts N.C.	Description	Type	Order code	Pkg qty	Weight (1 pc)
						pcs	kg

Auxiliary contacts - mountable inside the breaker on the left slot (cabled version)

MS5100			Changeover	AUX-C 1Q+1SY 250V AC	1SDA066431R1	2	0.06
MO5100			Changeover	AUX-C 2Q+1SY 250V AC	1SDA066433R1	3	0.09
MS5100			Changeover	AUX-C 2Q+2SY+1SA 250V AC	1SDA066438R1	5	0.15
			Changeover	AUX-C 3Q+1SY 250V AC	1SDA066434R1	4	0.12
MO5100			Changeover	AUX-C 3Q+2SY 250V AC	1SDA066436R1	5	0.15
			Changeover	AUX-C 1Q+1SY 24V DC	1SDA066446R1	2	0.06

Suitable for	Rated control supply voltage V	Description	Type	Order code	Pkg qty	Weight (1 pc)
					pcs	kg

Shunt trips units - mountable inside the breaker on the left slot (cabled version)

MS5100		Normally NON energized	SOR-C 12V DC	1SDA066321R1	1	0.14
MO5100		Normally NON energized	SOR-C 24-30V AC/DC	1SDA066322R1	1	0.14
		Normally NON energized	SOR-C 48-60V AC/DC	1SDA066323R1	1	0.14
		Normally NON energized	SOR-C 110-127V AC / 110-125V DC	1SDA066324R1	1	0.14
		Normally NON energized	SOR-C 220-240V AC / 220-250V DC	1SDA066325R1	1	0.14
		Normally NON energized	SOR-C 380-440V AC	1SDA066326R1	1	0.14
		Normally NON energized	SOR-C 480-525V AC	1SDA066327R1	1	0.14

Undervoltages releases - mountable inside the breaker on the left slot (cabled version)

MS5100		Normally energized	UVR-C 24-30V AC/DC	1SDA066396R1	1	0.14
MO5100		Normally energized	UVR-C 48V AC/DC	1SDA060965R1	1	0.14
		Normally energized	UVR-C 60V AC/DC	1SDA066397R1	1	0.14
		Normally energized	UVR-C 110-127V AC / 110-125V DC	1SDA066398R1	1	0.14
		Normally energized	UVR-C 220-240V AC / 220-250V DC	1SDA066399R1	1	0.14
		Normally energized	UVR-C 380-440V AC	1SDA066400R1	1	0.14
		Normally energized	UVR-C 480-525V AC	1SDA066401R1	1	0.14

Suitable for	Description	Type	Order code	Pkg qty	Weight (1 pc)
				pcs	kg

Key locks

MS5100	Key lock on the circuit breaker, different keys, removable in open position	KLC Ronis ¹⁾	1SDA066599R1	1	NA
MO5100	Key lock on the circuit breaker, different keys, removable in open position	KLC Ronis ¹⁾	1SDA066593R1	1	NA

¹⁾ UL Listed

Main accessories

MS49x, MO49x manual motor starters

Manual motor starter MS49x with accessories

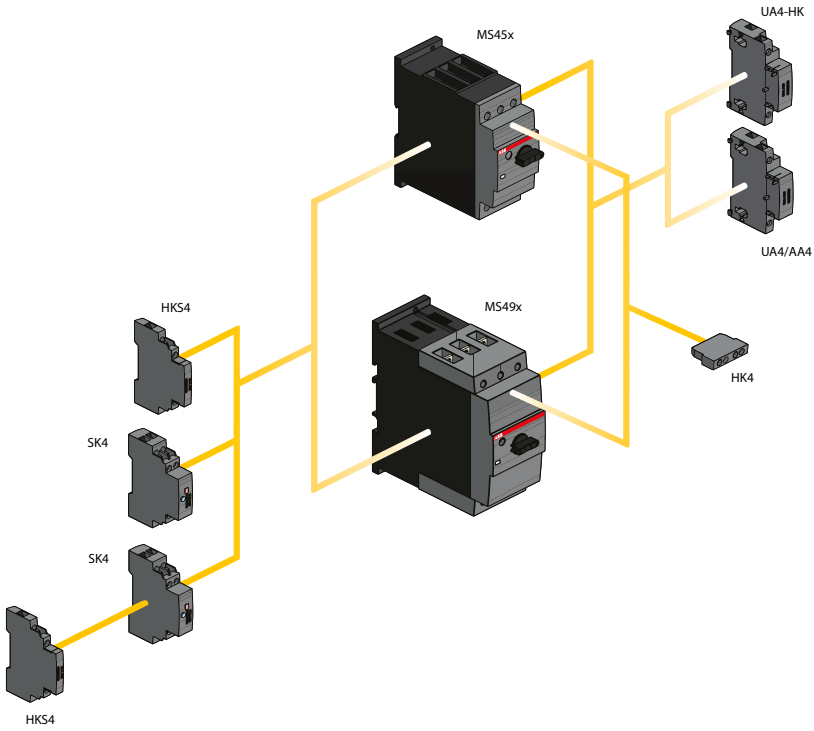

Manual motor starter MO49x with accessories

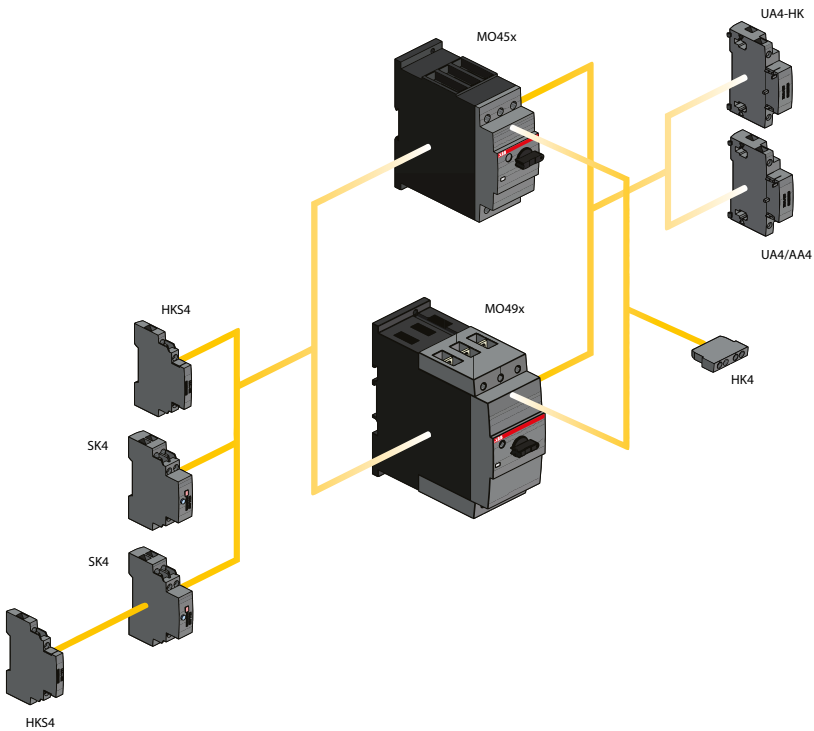

Main accessories

MS49x, MO49x manual motor starters



2CDC241023F0011

HK4-11



2CDC241023F0011

HKS4-20



2CDC241023F0011

SK4-11



2CDC241023F0011

AA4-24



2CDC241023F0011

UA4-110



2CDC241023F0013

SA2

Description

Manual motor starters can be equipped with auxiliary contacts for lateral/front mounting, signalling contact for lateral mounting, undervoltage release and shunt trips. The accessories can be fitted wiring free and without tools. A variety of combinations is possible as required for the application. The auxiliary contacts change position with the main contacts. Undervoltage release are used for remote tripping of the manual motor starter especially for emergency stop circuits. Shunt trips release the MMS used for remote tripping. For this manual motor starter range we offer terminal shrouds, terminal insulation barriers and different lock/key solutions for customer solutions.

Ordering details

Suitable for	Auxiliary con- tacts N.O.	Auxiliary con- tacts N.C.	Description	Type	Order code	Pkg qty	Weight (1 pc)
						pcs	kg

Auxiliary contacts – mountable on the front

MS49x,	1	1		HK4-11	1SAM401901R1001	10	0.017
MO49x			Changeover	HK4-W	1SAM401901R1002	10	0.015

Auxiliary contacts – mountable on the left

MS49x,	1	1	Max. 1 piece	HKS4-11	1SAM401902R1001	2	0.045
MO49x	2	0	Max. 1 piece	HKS4-20	1SAM401902R1002	2	0.045
	0	2	Max. 1 piece	HKS4-02	1SAM401902R1003	2	0.045

Signalling contacts – mountable on the left

MS49x, MO49x	2	2	Separate signalling acc. UL508E 1 N.O. + 1 N.C. for short circuit alarm and 1 N.O. + 1 N.C. for tripped alarm, max. 1x SK4-11 + 1 x HKS4-xx	SK4-11	1SAM401904R1001	1	0.093
-----------------	---	---	--	--------	-----------------	---	-------

Suitable for	Rated control supply voltage	Frequency	Type	Order code	Pkg qty	Weight (1 pc)
	V	Hz			pcs	kg

Shunt trip units – mountable on the right

MS49x,	20 ... 24	50/60	AA4-24	1SAM401907R1001	1	0.135
MO49x	90 ... 110	50/60	AA4-110	1SAM401907R1002	1	0.135
	200 ... 240	50/60	AA4-230	1SAM401907R1003	1	0.128
	350 ... 415	50/60	AA4-400	1SAM401907R1004	1	0.125

Undervoltage releases – mountable on the right

MS49x,	24	50/60	UA4-24	1SAM401905R1004	1	0.134
MO49x	110/120	50/60	UA4-110	1SAM401905R1001	1	0.134
	230/240	50/60	UA4-230	1SAM401905R1002	1	0.131
	400/440	50/60	UA4-400	1SAM401905R1003	1	0.129
	230/240	50/60	UA4-HK-230	1SAM401906R1001	1	0.140
	400/440	50/60	UA4-HK-400	1SAM401906R1002	1	0.137

Suitable for	Description	Type	Order code	Pkg qty	Weight (1 pc)
				pcs	kg

MS495, MS497, MO495, MO496	Terminal shroud	KA495	1SAM501901R1001	10	0.018
	Terminal shroud	KA495C ¹⁾	1SAM501902R1001	10	0.038
	Terminal insulation barrier for UL508E	DX495	1SAM401912R1001	1	0.154
MS495, MS497, MO495, MO496	Padlock + two keys	SA2	GJF1101903R0002	10	0.020

¹⁾ Is plugged onto the housing after removing the box terminals, if using cable lugs.

General accessories

MS116, MS132, MO132, MS5100, MO5100, MS49x, MO49x

2



MSHD-LB

2CDC241003F0011



MSHD-LY

2CDC241002S0011



MSMN

2CDC241004F0011



MSH-AR

2CDC241001F0012

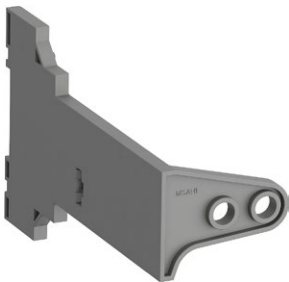

MSAH1

2CDC241017V0013



RHD Normal Direct Handle

RHD-01

Description

With this solution of door coupling rotary mechanism it is possible to operate a manual motor starter in the back of a switch cabinet from outside. The door coupling mechanism prevents opening of the door of a switch cabinet with the manual motor starter in ON position.

The complete mechanism includes handle, shaft, driver, shaft alignment ring and shaft supporter.

Most accessories fit for 6 mm shafts with a maximum length of 180 mm. The degree of protection for handles MSHD is IP64 (UL/CSA Type 1, 3R, 12).

Ordering details

Suitable for	Description	Shaft length mm	Color	Type	Order code	Pkg qty pcs	Weight (1 pc) kg
Shafts							
MS116, MS132, MO132, MS4xx, MO4xx	For MSHD handles. Shaft diameter 6 mm. Shaft extension for door coupling driver.	85 105 130 180		OXS6X85 OXS6X105 OXS6X130 OXS6X180	1SCA101647R1001 1SCA108043R1001 1SCA101655R1001 1SCA101659R1001	1 1 1 1	0.020 0.020 0.030 0.040
IP64 handles (UL/CSA Type 1, 3R, 12)							
MS116, MS132, MO132, MS4xx, MO4xx	Padlockable max. 3 padlocks with bail diameter 5 ... 8 mm, door interlock in ON position defeatable, for use with 6 mm OXS6...types up to 180 mm or driver shafts MSOX.		Black Yellow Black Yellow	MSHD-LB ¹⁾ MSHD-LY ¹⁾ MSHD-LTB ²⁾ MSHD-LTY ²⁾	1SAM201920R1001 1SAM201920R1002 1SAM201920R1011 1SAM201920R1012	1 1 1 1	0.065 0.065 0.065 0.065
Driver							
MS116, MS132, MO132, MS4xx, MO4xx	Coupling driver for use with 6 mm OXS6... types up to 180 mm.			MSMN ³⁾ MSMNO ⁴⁾	1SAM101923R0002 1SAM101923R0012	1 1	0.002 0.002
Shaft alignment ring							
MS116, MS132, MO132, MS4xx, MO4xx	The MSH-AR supports the long shafts for alignment to the handle inlet. It makes closing panel doors more easy. Use for OXS6X > 105 mm.			MSH-AR	1SAM201920R1000	1	0.010
Shaft supporter							
MS116, MS132, MO132	With the MSAH1 it is possible to support the shaft in the extension of handle (MSHD). It is mandatory for the usage of shafts >130 mm.			MSAH1	1SAM201909R1021	1	0.035
Rotary handle operating mechanism							
MS5100	Rotary handle operating mechanism			RHD Normal Direct Handle ⁵⁾	1SDA069053R1	1	0.4
MO5100	Rotary handle operating mechanism			RHD Normal Direct Handle ⁵⁾	1SDA066475R1	1	0.4

¹⁾ Indication I-O and ON-OFF (recommended for MS116, MS4xx, MO4xx)

²⁾ Indication I-O and ON-OFF + Trip indication

³⁾ Coded - Positioning of ON indication dependent from mounting orientation of the MMS

⁴⁾ Uncoded - Positioning of ON indication dependent from mounting orientation of the MMS

⁵⁾ UL Listed

General accessories

MS116, MS132, MO132, MS4xx, MO4xx

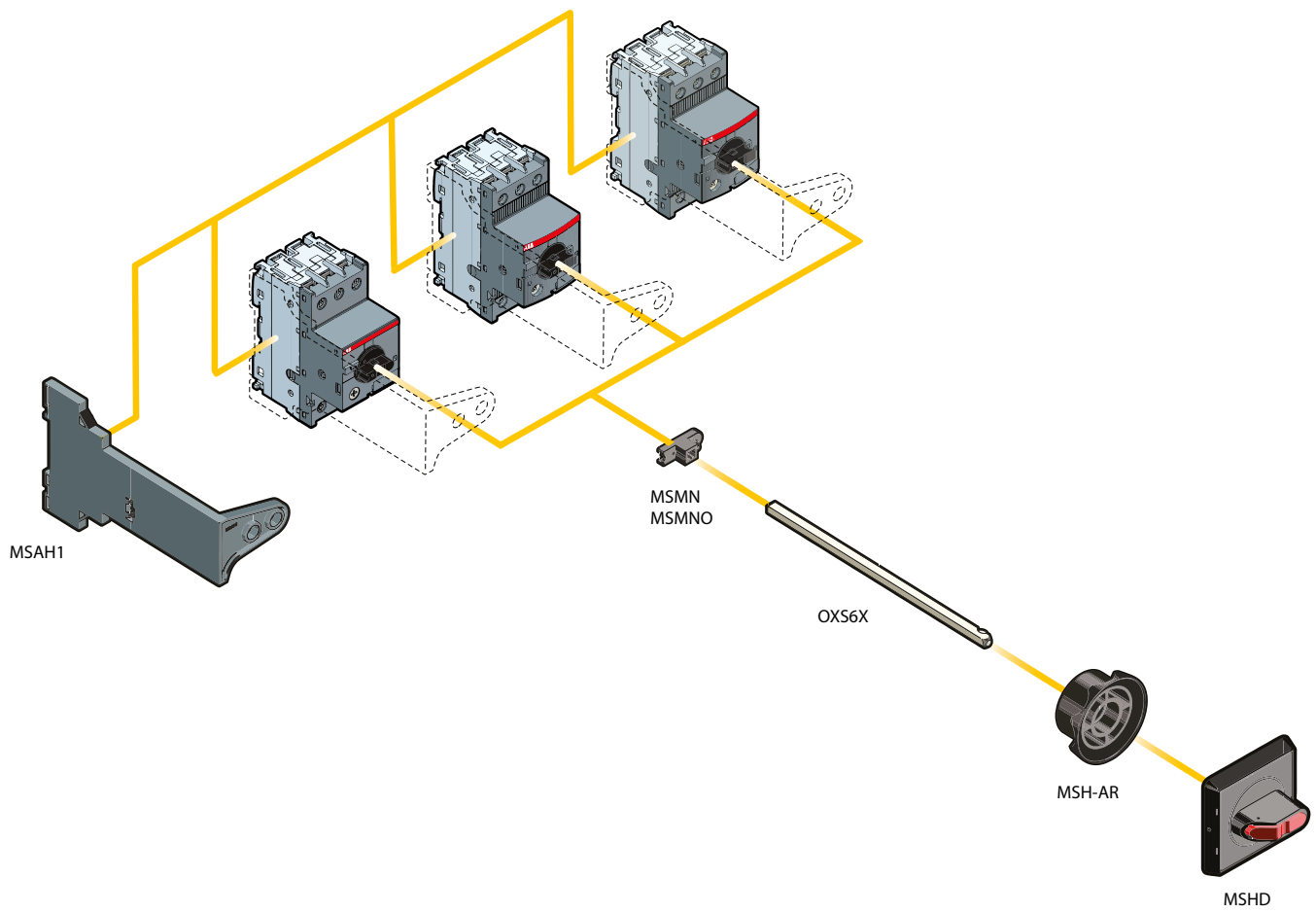

2CDC24002F0013



B mini contactors

K mini contactor relays

With screw terminals

3-pole contactors

B6, B7 AC operated	3/4
BC6, BC7, B7D DC operated	3/5

3-pole reversing contactors

VB6, VB7 AC operated	3/6
VBC6, VBC7 DC operated	3/7

3-pole interface contactors

BC6, BC7 DC operated	3/8
3-pole contactors - large coil voltage range	
TBC7 DC operated	3/9

4-pole contactors

B6, B7 AC operated	3/10
BC6, B7D DC operated	3/11
4-pole contactors - large coil voltage range	
TBC7 DC operated	3/12

Contactors relays

K6 AC operated	3/13
KC6 DC operated	3/14

Interface contactor relays

KC6 DC operated	3/15
-----------------	------

Contactors relays - large coil voltage range

TKC6 DC operated	3/16
------------------	------



Accessories

3/17

For direct product details information, use product type or order code, ex:
www.abb.com/productdetails/AF09-30-10-13 or www.abb.com/productdetails/1SBL137001R1310

Mini contactors



			Screw terminals			
AC Control supply 						
3-pole contactors	Coil consumption 3.5 W	Type	B6	B7	-	-
3-pole reversing contactors	Coil consumption 3.5 W	Type	-	-	VB6 VB6A²⁾	VB7 VB7A²⁾
4-pole contactors	Coil consumption 3.5 W	Type	B6	B7	-	-
DC Control supply 						
3-pole contactors	Coil consumption 3.5 W	Type	BC6	BC7 B7D¹⁾	-	-
3-pole interface contactors	Coil consumption 1.4 ... 2.4 W	Type	BC6	BC7	-	-
3-pole reversing contactors	Coil consumption 3.5 W	Type	-	-	VBC6 VBC6A²⁾	VBC7 VBC7A²⁾
4-pole contactors	Coil consumption 3.5 W	Type	BC6	B7D	-	-
Wide range types	Extended coil voltage and temperature	Type	-	TBC7	-	-
PLC types	Coil consumption 1.7 W	Type	B6S¹⁾	B7S¹⁾	-	-
IEC Rated operational power AC-3	220-230-240 V	kW	2.2	3	2.2	3
	380-400 V	kW	4	5.5	4	5.5
Rated operational current AC-1	400 V, $\theta \leq 40^\circ\text{C}$	A	20	20	20	20
UL/CSA 3-phase motor rating	220-240 V AC	hp	2	3	2	3
	440-480 V AC	hp	3	5	3	5
General use rating		A	12 (300 V)	16 (600 V)	12 (300 V)	16 (600 V)

¹⁾ With integrated surge suppressor

²⁾ With safety blocking function

Main accessories

Auxiliary contact blocks	Front mounting	CAF6
	Side mounting	CA6
Connection sets	For reversing contactors	BSM6-30
Surge suppressors	Varistor (AC/DC)	RV-BC6

Overload relays



Thermal overload relays	Class 10	T16
Thermal and phase failure protection, with single setup possible		
Electronic overload relays	Class 10E, 20E, 30E	E16DU
With single setup possible		

Manual motor starters

Thermal / magnetic protection	Class 10	MS116, MS132
Magnetic only types		MO132
Connecting link to manual motor starters		BEA7/132

Contactor relays



			Screw terminals			
AC Control supply 						
4-pole contactor relays	Coil consumption 3.5 W	Type	K6			
DC Control supply 						
4-pole contactor relays	Coil consumption 3.5 W	Type	KC6			
4-pole interface contactor relays	Coil consumption 1.4 ... 2.4 W	Type	KC6			
Wide range types	Extended coil voltage and temperature	Type	TKC6			
IEC Rated operational current AC-15	220-230-240 V	A	4			
	380-400 V	A	3			
Rated operational current DC-13	24 V	A	2.5			

Main accessories

Auxiliary contact blocks	Front mounting	CAF6
	Side mounting	CA6-11K



Soldering pins				Flat pins			
B6...P	B7...P	-	-	B6...F	B7...F	-	-
-	-	VB6...P	VB7...P	-	-	VB6...F	VB7...F
-	-	VB6A...P ²⁾	VB7A...P ²⁾	-	-	VB6A...F ²⁾	VB7A...F ²⁾
BC6...P	BC7...P	-	-	BC6...F	BC7...F	-	-
BC6...P	B7D...P ¹⁾	-	-	BC6...F	B7D...F ¹⁾	-	-
-	BC7...P	-	-	BC6...F	BC7...F	-	-
-	-	VBC6...P	VBC7...P	-	-	VBC6...F	VBC7...F
-	-	VBC6A...P ²⁾	VBC7A...P ²⁾	-	-	VBC6A...F ²⁾	VBC7A...F ²⁾
2.2	3	2.2	3	2.2	3	2.2	3
4	5.5	4	5.5	4	5.5	4	5.5
12	12	12	12	20	20	20	20
2	3	2	3	2	3	2	3
3	5	3	5	3	5	3	5
12 (300 V)	16 (600 V)	12 (300 V)	16 (600 V)	12 (300 V)	16 (600 V)	12 (300 V)	16 (600 V)

-	CA6-11K-P	-	CA6-11K-F
-	-	-	-
-	-	-	-

-	-	-	-
-	-	-	-

MS116, MS132	MS116, MS132
MO132	MO132
-	-



Soldering pins		Flat pins	
K6...P		K6...F	
KC6...P		KC6...F	
KC6...P		KC6...F	
4		4	
3		3	
2.5		2.5	
-	CA6-11K-P	-	CA6-11K-F

B6, B7 3-pole mini contactors – with screw terminals

4 to 5.5 kW

AC operated



2CDC211001R0010

B6-30-10



2CDC211014R0011

B7-30-10

Description

B6, B7 3-pole mini contactors are compact control products mainly used for switching resistive or motor loads up to 690 V AC.

These contactors are designed with:

- 3 main poles and one built-in auxiliary contact
- control circuit: AC operated
 - low coil consumption (3.5 VA at pull-in and at holding)
- add-on auxiliary contact blocks for front or side mounting and a wide range of accessories
- hum-free coil
- designed for rail or wall mounting

Ordering details

IEC	UL/CSA	Rated control circuit voltage U_c		Auxiliary contacts fitted	Type	Order code	Pkg qty	Weight (1 pce)
Rated operational power	3-phase motor rating	50 Hz	60 Hz					kg
AC-3	General use rating	V AC	V AC					
400 V	480 V							
AC-1								
kW	hp							

B6 mini contactors

4	20	3	300 V / 12 A	24	24	1 0	B6-30-10-01	GJL1211001R0101	10	0.175
						0 1	B6-30-01-01	GJL1211001R0011	10	0.175
				42	42	1 0	B6-30-10-02	GJL1211001R0102	10	0.175
						0 1	B6-30-01-02	GJL1211001R0012	10	0.175
				48	48	1 0	B6-30-10-03	GJL1211001R0103	10	0.175
						0 1	B6-30-01-03	GJL1211001R0013	10	0.175
				110 ... 127	110 ... 127	1 0	B6-30-10-84	GJL1211001R8104	10	0.175
						0 1	B6-30-01-84	GJL1211001R8014	10	0.175
				220 ... 240	220 ... 240	1 0	B6-30-10-80	GJL1211001R8100	10	0.175
						0 1	B6-30-01-80	GJL1211001R8010	10	0.175
				380 ... 415	380 ... 415	1 0	B6-30-10-85	GJL1211001R8105	10	0.175
						0 1	B6-30-01-85	GJL1211001R8015	10	0.175

B7 mini contactors

5.5	20	5	600 V / 16 A	24	24	1 0	B7-30-10-01	GJL1311001R0101	10	0.175
						0 1	B7-30-01-01	GJL1311001R0011	10	0.175
				42	42	1 0	B7-30-10-02	GJL1311001R0102	10	0.175
						0 1	B7-30-01-02	GJL1311001R0012	10	0.175
				48	48	1 0	B7-30-10-03	GJL1311001R0103	10	0.175
						0 1	B7-30-01-03	GJL1311001R0013	10	0.175
				110 ... 127	110 ... 127	1 0	B7-30-10-84	GJL1311001R8104	10	0.175
						0 1	B7-30-01-84	GJL1311001R8014	10	0.175
				220 ... 240	220 ... 240	1 0	B7-30-10-80	GJL1311001R8100	10	0.175
						0 1	B7-30-01-80	GJL1311001R8010	10	0.175
				380 ... 415	380 ... 415	1 0	B7-30-10-85	GJL1311001R8105	10	0.175
						0 1	B7-30-01-85	GJL1311001R8015	10	0.175

Other types on request

Main dimensions mm, inches

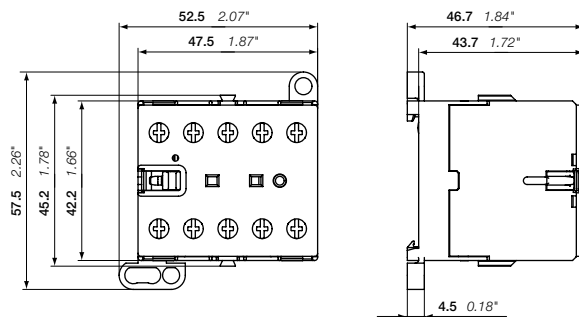

B6, B7

2CDC212001R0011

2CDC102008G0201

BC6, BC7, B7D 3-pole mini contactors – with screw terminals

4 to 5.5 kW

DC operated



BC6-30-10

2CDC21104RF0011



BC7-30-10

2CDC211019F0011

Description

BC6, BC7, B7D 3-pole mini contactors are compact control products mainly used for switching resistive or motor loads up to 690 V AC.

These contactors are designed with:

- 3 main poles and one built-in auxiliary contact
- control circuit: DC operated, low consumption (3.5 W at pull-in and at holding)
- hum-free coil
- add-on auxiliary contact blocks for front or side mounting and a wide range of accessories
- designed for rail or wall mounting

Ordering details

IEC	UL/CSA	Rated control circuit voltage: U_c	Auxiliary contacts fitted	Type	Order code	Pkg qty	Weight (1 pce)
Rated operational power 400 V AC-3 kW	3-phase motor rating $\theta \leq 40^\circ\text{C}$ AC-1 A hp 480 V	General use rating V DC					kg

BC6 mini contactors

Rated operational power (kW)	UL/CSA (AC-1 A)	3-phase motor rating (hp)	General use rating (V DC)	Rated control circuit voltage (U_c)	Auxiliary contacts fitted	Type	Order code	Pkg qty	Weight (1 pce) (kg)
4	20	3	300 V / 12 A	12	1 0	BC6-30-10-07	GJL1213001R0107	10	0.175
					0 1	BC6-30-01-07	GJL1213001R0017	10	0.175
				24	1 0	BC6-30-10-01	GJL1213001R0101	10	0.175
					0 1	BC6-30-01-01	GJL1213001R0011	10	0.175
				48	1 0	BC6-30-10-16	GJL1213001R1106	10	0.175
					0 1	BC6-30-01-16	GJL1213001R1016	10	0.175
				60	1 0	BC6-30-10-03	GJL1213001R0103	10	0.175
					0 1	BC6-30-01-03	GJL1213001R0013	10	0.175
				110 ... 125	1 0	BC6-30-10-04	GJL1213001R0104	10	0.175
					0 1	BC6-30-01-04	GJL1213001R0014	10	0.175
				220 ... 240	1 0	BC6-30-10-05	GJL1213001R0105	10	0.175
					0 1	BC6-30-01-05	GJL1213001R0015	10	0.175

BC7 mini contactors

Rated operational power (kW)	UL/CSA (AC-1 A)	3-phase motor rating (hp)	General use rating (V DC)	Rated control circuit voltage (U_c)	Auxiliary contacts fitted	Type	Order code	Pkg qty	Weight (1 pce) (kg)
5.5	20	5	600 V / 16 A	12	1 0	BC7-30-10-07	GJL1313001R0107	10	0.175
					0 1	BC7-30-01-07	GJL1313001R0017	10	0.175
				24	1 0	BC7-30-10-01	GJL1313001R0101	10	0.175
					0 1	BC7-30-01-01	GJL1313001R0011	10	0.175
				48	1 0	BC7-30-10-16	GJL1313001R1106	10	0.175
					0 1	BC7-30-01-16	GJL1313001R1016	10	0.175
				60	1 0	BC7-30-10-03	GJL1313001R1103	10	0.175
					0 1	BC7-30-01-03	GJL1313001R0013	10	0.175
				110 ... 125	1 0	BC7-30-10-04	GJL1313001R0104	10	0.175
					0 1	BC7-30-01-04	GJL1313001R0014	10	0.175
				220 ... 240	1 0	BC7-30-10-05	GJL1313001R0105	10	0.175
					0 1	BC7-30-01-05	GJL1313001R0015	10	0.175

B7D mini contactors with integrated suppressor diode

Rated operational power (kW)	UL/CSA (AC-1 A)	3-phase motor rating (hp)	General use rating (V DC)	Rated control circuit voltage (U_c)	Auxiliary contacts fitted	Type	Order code	Pkg qty	Weight (1 pce) (kg)
5.5	20	5	600 V / 16 A	24	1 0	B7D-30-10-01	GJL1317001R0101	10	0.175
					0 1	B7D-30-01-01	GJL1317001R0011	10	0.175
				220	1 0	B7D-30-10-05	GJL1317001R0105	10	0.175
					0 1	B7D-30-01-05	GJL1317001R0015	10	0.175

Other types on request

Main dimensions mm, inches

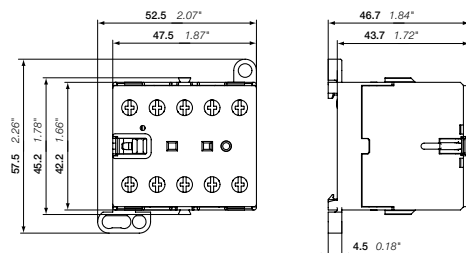

BC6, BC7, B7D

2CDC212001F0011

2CDC102015C0201

VB6, VB7 3-pole mini reversing contactors – with screw terminals

4 to 5.5 kW

AC operated



2CDC211005F0011

3

VB7-30-10

Description

VB6, VB7 3-pole compact design reversing contactors are space optimized control products mainly used for switching resistive or motor loads up to 690 V AC.

These reversing contactors are designed with:

- built-in mechanical interlock. The coils must be mutually interlocked electrically and coils must be de-energised for 50 ms at least to prevent phase to phase short circuit on the arc.
- control circuit: AC operated
 - low coil consumption (3.5 VA at pull-in and at holding)
 - hum-free coil
- add-on auxiliary contact blocks for front mounting
- designed for rail or wall mounting

Ordering details

IEC Rated power 400 V AC-3 kW	operational current $\theta \leq 40^\circ\text{C}$ AC-1 A	UL/CSA		Rated control circuit voltage U_c		Auxiliary contacts fitted 	Type	Order code	Pkg qty	Weight (1 pce) kg					
		3-phase motor rating 480 V hp	General use rating	50 Hz V AC	60 Hz V AC										
VB6 mini reversing contactors															
4	20	3	300 V / 12 A	24	24	1 0	VB6-30-10-01	GJL1211901R0101	5	0.355					
					42	42	0 1	VB6-30-01-01	GJL1211901R0011	5	0.355				
					48	48	1 0	VB6-30-10-02	GJL1211901R0102	5	0.355				
							0 1	VB6-30-01-02	GJL1211901R0012	5	0.355				
					110 ... 127	110 ... 127	1 0	VB6-30-10-03	GJL1211901R0103	5	0.355				
							0 1	VB6-30-01-03	GJL1211901R0013	5	0.355				
					220 ... 240	220 ... 240	1 0	VB6-30-10-84	GJL1211901R8104	5	0.355				
							0 1	VB6-30-01-84	GJL1211901R8014	5	0.355				
					380 ... 415	380 ... 415	1 0	VB6-30-10-80	GJL1211901R8100	5	0.355				
							0 1	VB6-30-01-80	GJL1211901R8010	5	0.355				
					380 ... 415	380 ... 415	1 0	VB6-30-10-85	GJL1211901R8105	5	0.355				
							0 1	VB6-30-01-85	GJL1211901R8015	5	0.355				
					VB7 mini reversing contactors										
					5.5	20	5	600 V / 16 A	24	24	1 0	VB7-30-10-01	GJL1311901R0101	5	0.355
42	42	0 1	VB7-30-01-01	GJL1311901R0011					5	0.355					
48	48	1 0	VB7-30-10-02	GJL1311901R0102					5	0.355					
		0 1	VB7-30-01-02	GJL1311901R0012					5	0.355					
110 ... 127	110 ... 127	1 0	VB7-30-10-03	GJL1311901R0103					5	0.355					
		0 1	VB7-30-01-03	GJL1311901R0013					5	0.355					
220 ... 240	220 ... 240	1 0	VB7-30-10-84	GJL1311901R8104					5	0.355					
		0 1	VB7-30-01-84	GJL1311901R8014					5	0.355					
380 ... 415	380 ... 415	1 0	VB7-30-10-80	GJL1311901R8100					5	0.355					
		0 1	VB7-30-01-80	GJL1311901R8010					5	0.355					
380 ... 415	380 ... 415	1 0	VB7-30-10-85	GJL1311901R8105					5	0.355					
		0 1	VB7-30-01-85	GJL1311901R8015					5	0.355					

Other types on request

Main dimensions mm, inches

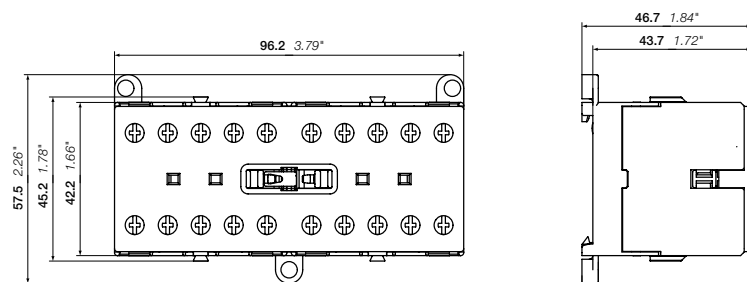

VB6, VB7

2CDC212005F0011

2CDC102016C0201

VBC6, VBC7 3-pole mini reversing contactors – with screw terminals

4 to 5.5 kW

DC operated



VBC6-30-10

2CDC211049R0011



VBC7-30-10

2CDC211001R0011

Description

VBC6, VBC7 3-pole compact design reversing contactors are space optimized control products mainly used for switching resistive or motor loads up to 690 V AC.

These reversing contactors are designed with:

- built-in mechanical interlock. The coils must be mutually interlocked electrically and coils must be de-energised for 50 ms at least to prevent phase to phase short circuit on the arc.
- control circuit: DC operated
 - low coil consumption (3.5 W at pull-in and at holding)
- hum-free coil
- add-on auxiliary contact blocks for front mounting
- designed for rail or wall mounting

Ordering details

IEC	UL/CSA	Rated control circuit voltage: U _c	Auxiliary contacts fitted	Type	Order code	Pkg qty	Weight (1 pce)
Rated operational power	3-phase motor rating	General use rating					kg
400 V AC-3 kW	AC-1 A	480 V hp	V DC				

VBC6 mini reversing contactors

Rated operational power	3-phase motor rating	General use rating	Rated control circuit voltage: U _c	Auxiliary contacts fitted	Type	Order code	Pkg qty	Weight (1 pce)	
4	20	3	300 V / 12 A	1 0	VBC6-30-10-07	GJL1213901R0107	5	0.355	
						0 1	VBC6-30-01-07	GJL1213901R0017	5
				24	1 0	VBC6-30-10-01	GJL1213901R0101	5	0.355
							0 1	VBC6-30-01-01	GJL1213901R0011
				48	1 0	VBC6-30-10-16	GJL1213901R1106	5	0.355
							0 1	VBC6-30-01-16	GJL1213901R1016
				60	1 0	VBC6-30-10-03	GJL1213901R0103	5	0.355
							0 1	VBC6-30-01-03	GJL1213901R0013
				110 ... 125	1 0	VBC6-30-10-04	GJL1213901R0104	5	0.355
							0 1	VBC6-30-01-04	GJL1213901R0014
				220 ... 240	1 0	VBC6-30-10-05	GJL1213901R0105	5	0.355
							0 1	VBC6-30-01-05	GJL1213901R0015

VBC7 mini reversing contactors

Rated operational power	3-phase motor rating	General use rating	Rated control circuit voltage: U _c	Auxiliary contacts fitted	Type	Order code	Pkg qty	Weight (1 pce)	
5.5	20	5	600 V / 16 A	1 0	VBC7-30-10-07	GJL1313901R0107	5	0.355	
						0 1	VBC7-30-01-07	GJL1313901R0017	5
				24	1 0	VBC7-30-10-01	GJL1313901R0101	5	0.355
							0 1	VBC7-30-01-01	GJL1313901R0011
				48	1 0	VBC7-30-10-16	GJL1313901R1106	5	0.355
							0 1	VBC7-30-01-16	GJL1313901R1016
				60	1 0	VBC7-30-10-03	GJL1313901R0103	5	0.355
							0 1	VBC7-30-01-03	GJL1313901R0013
				110 ... 125	1 0	VBC7-30-10-04	GJL1313901R0104	5	0.355
							0 1	VBC7-30-01-04	GJL1313901R0014
				220 ... 240	1 0	VBC7-30-10-05	GJL1313901R0105	5	0.355
							0 1	VBC7-30-01-05	GJL1313901R0015

Other types on request

Main dimensions mm, inches

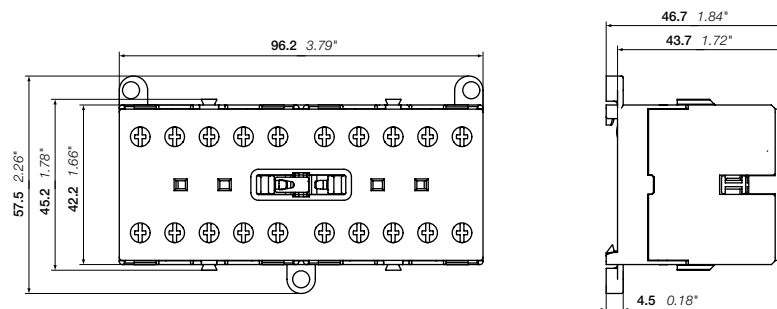

VBC6, VBC7

2CDC212005R0011

2CDC102017C0201

BC6, BC7 3-pole interface mini contactors – with screw terminals

4 to 5.5 kW

DC operated



2CDC21104P0011

BC6-30-10



2CDC21109P0011

BC7-30-10

Description

BC6, BC7 3-pole interface mini contactors are compact control products mainly used for switching resistive or motor loads up to 690 V AC.

These contactors are designed with:

- 3 main poles and one built-in auxiliary contact
- control circuit: DC operated, very low coil consumption. Suitable for direct control by PLC outputs
- hum-free coil
- no auxiliary contact block permitted for mounting
- designed for rail or wall mounting

Ordering details

IEC	UL/CSA	Rated control circuit voltage U_c	Auxiliary contacts fitted	Type	Order code	Pkg qty	Weight (1 pce)	
Rated operational power	3-phase: motor rating General use rating							
400 V AC-3 kW	$\theta \leq 40^\circ\text{C}$ AC-1 A hp	V DC					kg	
DC operation 24 V / 1.4 W								
4	20	3	300 V / 12 A	24	1 0 BC6-30-10-1.4-81 0 1 BC6-30-01-1.4-81	GJL1213001R8101 GJL1213001R8011	10 10	0.175 0.175
5.5	20	5	600 V / 16 A	24	1 0 BC7-30-10-1.4-81 0 1 BC7-30-01-1.4-81	GJL1313001R8101 GJL1313001R8011	10 10	0.175 0.175
DC operation 17 ... 32 V / 2.4 W								
4	20	3	300 V / 12 A	17 ... 32	1 0 BC6-30-10-2.4-51 0 1 BC6-30-01-2.4-51	GJL1213001R5101 GJL1213001R5011	10 10	0.175 0.175
5.5	20	5	600 V / 16 A	17 ... 32	1 0 BC7-30-10-2.4-51 0 1 BC7-30-01-2.4-51	GJL1313001R5101 GJL1313001R5011	10 10	0.175 0.175

Connection to PLCs with integrated protective circuit

DC operation 24 V / 1.7 W								
4	20	3	300 V / 12 A	24	1 0 B6S-30-10-1.7-71 0 1 B6S-30-01-1.7-71	GJL1213001R7101 GJL1213001R7011	10 10	0.175 0.175
5.5	20	5	600 V / 16 A	24	1 0 B7S-30-10-1.7-71 0 1 B7S-30-01-1.7-71	GJL1313001R7101 GJL1313001R7011	10 10	0.175 0.175
DC operation 17 ... 32 V / 2.8 W								
4	20	3	300 V / 12 A	17 ... 32	1 0 B6S-30-10-2.8-72 0 1 B6S-30-01-2.8-72	GJL1213001R7102 GJL1213001R7012	10 10	0.175 0.175
5.5	20	5	600 V / 16 A	17 ... 32	1 0 B7S-30-10-2.8-72 0 1 B7S-30-01-2.8-72	GJL1313001R7102 GJL1313001R7012	10 10	0.175 0.175

Other types on request

Main dimensions mm, inches

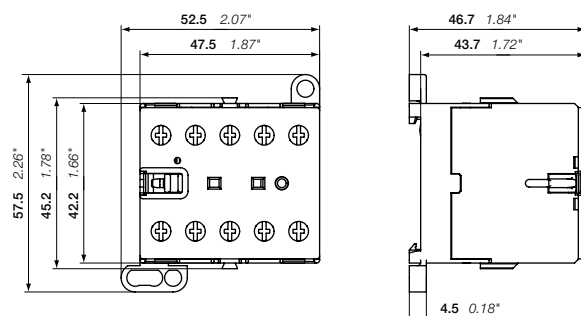

BC6, BC7

2CDC212001P0011

2CDC102010C0201

TBC7 3-pole mini contactors – with screw terminals

4 to 5.5 kW

DC operated – large coil voltage range



TBC7-30-10

2CDC21101F0011

Description

TBC7 3-pole mini contactors are compact control products mainly used for switching resistive or motor loads up to 690 V AC.

These contactors are designed with:

- 3 main poles and one built-in auxiliary contact
- control circuit: DC operated
 - low coil consumption (5 W at pull-in and at holding)
 - hum-free coil
- expanded ambient temperature range -30 ... +70 °C and wide range voltage supply
- no auxiliary contact block permitted for mounting
- designed for rail or wall mounting
- material is approved for railway applications

Ordering details

IEC		UL/CSA		Rated control circuit voltage: $U_{Cmin} \dots U_{Cmax}$	Auxiliary contacts fitted 	Type	Order code	Pkg qty	Weight (1 pce) kg
Rated power	operational current $\theta \leq 40 \text{ }^\circ\text{C}$	3-phase motor rating 480 V	General use rating						
400 V AC-3 kW	AC-1 A	hp		V DC					
TBC7 mini contactors									
5.5	20	5	600 V / 16 A	17 ... 32	1 0	TBC7-30-10-51	GJL1313061R5101	10	0.185
					0 1	TBC7-30-01-51	GJL1313061R5011	10	0.185
				50 ... 90	1 0	TBC7-30-10-55	GJL1313061R5105	10	0.185
					0 1	TBC7-30-01-55	GJL1313061R5015	10	0.185
				77 ... 143	1 0	TBC7-30-10-62	GJL1313061R6102	10	0.185
					0 1	TBC7-30-01-62	GJL1313061R6012	10	0.185
				140 ... 260	1 0	TBC7-30-10-68	GJL1313061R6108	10	0.185
					0 1	TBC7-30-01-68	GJL1313061R6018	10	0.185

Other types on request

Main dimensions mm, inches

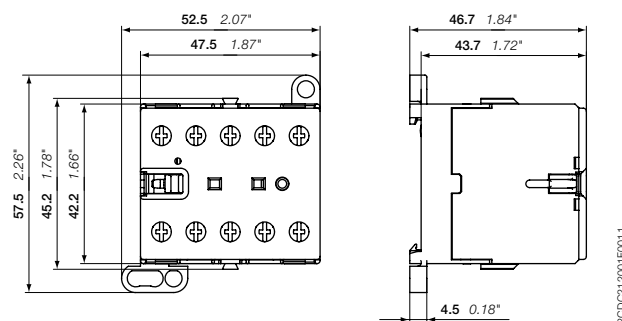

TBC7

2CDC211001F0011

2CDC102020 C0201

B6, B7 4-pole mini contactors – with screw terminals

4 to 5.5 kW

AC operated



2CDC21102BF0011

3

B6-22-00

Description

B6, B7 4-pole mini contactors are compact control products mainly used for switching resistive loads up to 690 V AC.

These contactors are designed with:

- 4 main poles
- control circuit: AC operated
 - low coil consumption (3.5 VA at pull-in and at holding)
- add-on auxiliary contact blocks for front or side mounting and a wide range of accessories
- hum-free coil
- designed for rail or wall mounting

Ordering details

IEC	UL/CSA	Rated control circuit voltage U_c	Auxiliary contacts fitted	Type	Order code	Pkg qty	Weight (1 pce)
Rated operational current I_n $\theta \leq 40^\circ\text{C}$ AC-1	General use rating	50/60 Hz					
A		V AC					kg
4 N.O. main poles							
20	300 V / 12 A	24	0 0	B6-40-00-01	GJL1211201R0001	10	0.175
		42	0 0	B6-40-00-02	GJL1211201R0002	10	0.175
		48	0 0	B6-40-00-03	GJL1211201R0003	10	0.175
		110 ... 127	0 0	B6-40-00-84	GJL1211201R8004	10	0.175
		220 ... 240	0 0	B6-40-00-80	GJL1211201R8000	10	0.175
20	600 V / 16 A	24	0 0	B7-40-00-01	GJL1311201R0001	10	0.175
		42	0 0	B7-40-00-02	GJL1311201R0002	10	0.175
		48	0 0	B7-40-00-03	GJL1311201R0003	10	0.175
		110 ... 127	0 0	B7-40-00-84	GJL1311201R8004	10	0.175
		220 ... 240	0 0	B7-40-00-80	GJL1311201R8000	10	0.175
2 N.O. + 2 N.C. main poles							
20	300 V / 12 A	24	0 0	B6-22-00-01	GJL1211501R0001	10	0.175
		42	0 0	B6-22-00-02	GJL1211501R0002	10	0.175
		48	0 0	B6-22-00-03	GJL1211501R0003	10	0.175
		110 ... 127	0 0	B6-22-00-84	GJL1211501R8004	10	0.175
		220 ... 240	0 0	B6-22-00-80	GJL1211501R8000	10	0.175
20	600 V / 16 A	24	0 0	B7-22-00-01	GJL1311501R0001	10	0.175
		42	0 0	B7-22-00-02	GJL1311501R0002	10	0.175
		48	0 0	B7-22-00-03	GJL1311501R0003	10	0.175
		110 ... 127	0 0	B7-22-00-84	GJL1311501R8004	10	0.175
		220 ... 240	0 0	B7-22-00-80	GJL1311501R8000	10	0.175

Other types on request

Main dimensions mm, inches

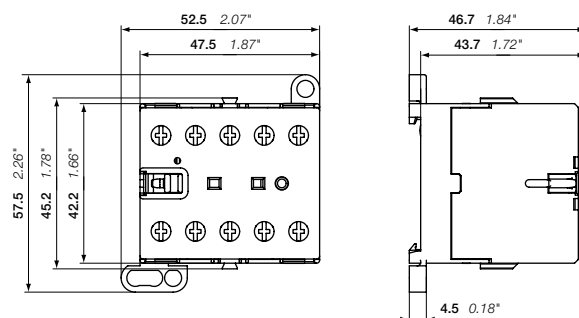

B6, B7

2CDC212001R0011

2CDC102009C0201

BC6, B7D 4-pole mini contactors – with screw terminals

4 to 5.5 kW

DC operated



BC6-22-00

Description

BC6, B7D 4-pole mini contactors are compact control products mainly used for switching resistive loads up to 690 V AC.

These contactors are designed with:

- 4 main poles
- control circuit: DC operated
 - low coil consumption (3.5 W at pull-in and at holding)
 - hum-free coil
- add-on auxiliary contact blocks for front or side mounting
- designed for rail or wall mounting

Ordering details

IEC	UL/CSA	Rated control circuit voltage: U_c	Auxiliary contacts fitted	Type	Order code	Pkg qty	Weight (1 pce)
Rated operational current $\theta \leq 40^\circ\text{C}$ AC-1 A	General use rating	V DC					kg
4 N.O. main poles							
20	600 V / 16 A	24	0 0	B7D-40-00-01	GJL1317201R0001	10	0.175
		220	0 0	B7D-40-00-05	GJL1317201R0005	10	0.175
2 N.O. + 2 N.C. main poles							
20	300 V / 12 A	12	0 0	BC6-22-00-07	GJL1213501R0007	10	0.175
		24	0 0	BC6-22-00-01	GJL1213501R0001	10	0.175
		42	0 0	BC6-22-00-02	GJL1213501R0002	10	0.175
		48	0 0	BC6-22-00-16	GJL1213501R1006	10	0.175
		60	0 0	BC6-22-00-03	GJL1213501R0003	10	0.175
		110 ... 125	0 0	BC6-22-00-04	GJL1213501R0004	10	0.175
		220 ... 240	0 0	BC6-22-00-05	GJL1213501R0005	10	0.175

Other types on request

Main dimensions mm, inches

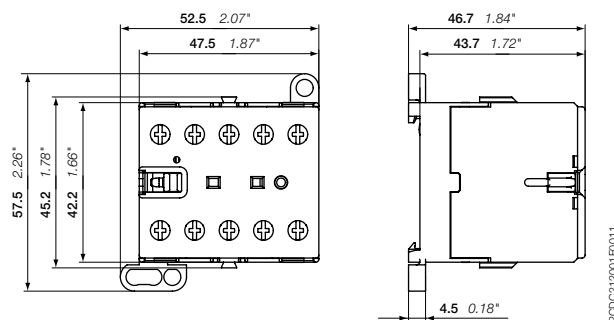

BC6, B7D

TBC7 4-pole mini contactors – with screw terminals

4 to 5.5 kW

DC operated – large coil voltage range



3

TBC7-31-00

Description

TBC7 4-pole mini contactors are compact control products mainly used for switching resistive or motor loads up to 690 V AC.

These contactors are designed with:

- 4 main poles
- control circuit: DC operated
 - low coil consumption (5 W at pull-in and at holding)
 - hum-free coil
- expanded ambient temperature range -30 ... +70 °C and wide range voltage supply
- no auxiliary contact block permitted for mounting
- designed for rail or wall mounting
- material is approved for railway applications

Ordering details

IEC	UL/CSA	Rated control circuit voltage $U_{Cmin} \dots U_{Cmax}$	Auxiliary contacts fitted	Type	Order code	Pkg qty	Weight (1 pce)
Rated operational current $\theta \leq 40^\circ\text{C}$ AC-1 A	General use rating	V DC					kg
3 N.O. + 1 N.C. main poles							
20	600 V / 16 A	50 ... 90	0 0	TBC7-31-00-55	GJL1313461R5005	10	0.185
		77 ... 143	0 0	TBC7-31-00-62	GJL1313461R6002	10	0.185
		140 ... 260	0 0	TBC7-31-00-68	GJL1313461R6008	10	0.185
2 N.O. + 2 N.C. main poles							
20	600 V / 16 A	50 ... 90	0 0	TBC7-22-00-55	GJL1313561R5005	10	0.185
		77 ... 143	0 0	TBC7-22-00-62	GJL1313561R6002	10	0.185
		140 ... 260	0 0	TBC7-22-00-68	GJL1313561R6008	10	0.185

Other types on request

Main dimensions mm, inches

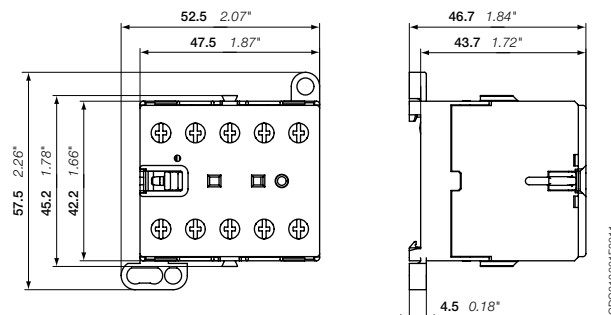

TBC7

K6 4-pole mini contactor relays – with screw terminals AC operated



K6-22Z



K6-31Z

Description

K6 4-pole mini-contactor relays are space optimized control products mainly used for control functions or for small loads up to 4 A.

These contactors are designed with:

- 4-poles with various contact combinations
- control circuit: AC operated
 - low coil consumption (3.5 VA at pull-in and at holding)
 - hum-free coil
- add-on auxiliary contact blocks for front or side mounting
- designed for rail or wall mounting

Ordering details

Rated control circuit voltage U_c		Type	Order code	Pkg qty	Weight (1 pce)
50 Hz V AC	60 Hz V AC				kg
K6 4-pole mini contactor relays					
24	24	K6-22Z-01	GJH1211001R0221	10	0.175
42	42	K6-22Z-02	GJH1211001R0222	10	0.175
48	48	K6-22Z-03	GJH1211001R0223	10	0.175
110 ... 127	110 ... 127	K6-22Z-84	GJH1211001R8224	10	0.175
220 ... 240	220 ... 240	K6-22Z-80	GJH1211001R8220	10	0.175
380 ... 415	380 ... 415	K6-22Z-85	GJH1211001R8225	10	0.175
24	24	K6-31Z-01	GJH1211001R0311	10	0.175
42	42	K6-31Z-02	GJH1211001R0312	10	0.175
48	48	K6-31Z-03	GJH1211001R0313	10	0.175
110 ... 127	110 ... 127	K6-31Z-84	GJH1211001R8314	10	0.175
220 ... 240	220 ... 240	K6-31Z-80	GJH1211001R8310	10	0.175
380 ... 415	380 ... 415	K6-31Z-85	GJH1211001R8315	10	0.175
24	24	K6-40E-01	GJH1211001R0401	10	0.175
42	42	K6-40E-02	GJH1211001R0402	10	0.175
48	48	K6-40E-03	GJH1211001R0403	10	0.175
110 ... 127	110 ... 127	K6-40E-84	GJH1211001R8404	10	0.175
220 ... 240	220 ... 240	K6-40E-80	GJH1211001R8400	10	0.175
380 ... 415	380 ... 415	K6-40E-85	GJH1211001R8405	10	0.175

Other types on request

Main dimensions mm, inches

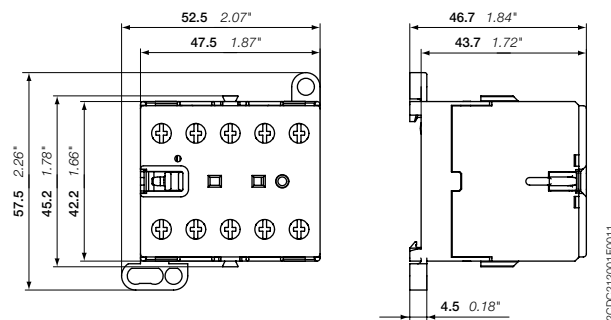

K6

KC6 4-pole mini contactor relays – with screw terminals DC operated



2CDC21101R00011

3

KC6-22Z

Description

KC6 4-pole mini-contactor relays are space optimized control products mainly used for control functions or for small loads up to 4 A.

These contactors are designed with:

- 4-poles with various contact combinations
- control circuit: DC operated
 - low coil consumption (3.5 W at pull-in and at holding)
- hum-free coil
- add-on auxiliary contact blocks for front or side mounting
- designed for rail or wall mounting

Ordering details

Rated control circuit voltage U_c V DC	Type	Order code	Pkg qty	Weight (1 pce) kg
KC6 4-pole mini contactor relays				
12	KC6-22Z-07	GJH1213001R0227	10	0.175
24	KC6-22Z-01	GJH1213001R0221	10	0.175
48	KC6-22Z-16	GJH1213001R1226	10	0.175
60	KC6-22Z-03	GJH1213001R0223	10	0.175
110 ... 125	KC6-22Z-04	GJH1213001R0224	10	0.175
220 ... 240	KC6-22Z-05	GJH1213001R0225	10	0.175
12	KC6-31Z-07	GJH1213001R0317	10	0.175
24	KC6-31Z-01	GJH1213001R0311	10	0.175
48	KC6-31Z-16	GJH1213001R1316	10	0.175
60	KC6-31Z-03	GJH1213001R0313	10	0.175
110 ... 125	KC6-31Z-04	GJH1213001R0314	10	0.175
220 ... 240	KC6-31Z-05	GJH1213001R0315	10	0.175
12	KC6-40E-07	GJH1213001R0407	10	0.175
24	KC6-40E-01	GJH1213001R0401	10	0.175
48	KC6-40E-16	GJH1213001R1406	10	0.175
60	KC6-40E-03	GJH1213001R0403	10	0.175
110 ... 125	KC6-40E-04	GJH1213001R0404	10	0.175
220 ... 240	KC6-40E-05	GJH1213001R0405	10	0.175

Other types on request

Main dimensions mm, inches

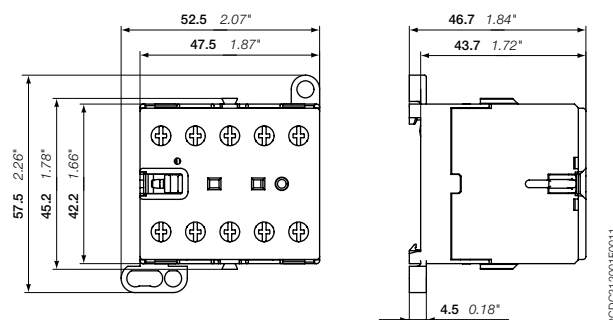

KC6

2CDC211001R00011

2CDC102012C0201

KC6 4-pole interface mini contactor relays – with screw terminals DC operated



KC6-31Z

Description

KC6 4-pole interface mini-contactor relays are space optimized control products mainly used for control functions or for small loads up to 4 A.

These contactors are designed with:

- 4-poles with various contact combinations
- control circuit: DC operated
 - low coil consumption (1.4 ... 2.8 W at pull-in and at holding)
- hum-free coil
- no auxiliary contact block permitted for mounting
- designed for rail or wall mounting

Ordering details

Rated control circuit voltage U_c V DC	Type	Order code	Pkg qty	Weight (1 pce) kg
DC operation 24 V / 1.4 W				
24	KC6-31Z-1.4-81	GJH1213001R8311	10	0.175
24	KC6-40E-1.4-81	GJH1213001R8401	10	0.175
DC operation 17 ... 32 V / 2.4 W				
17 ... 32	KC6-31Z-2.4-51	GJH1213001R5311	10	0.175
17 ... 32	KC6-40E-2.4-51	GJH1213001R5401	10	0.175
DC operation 24 V / 1.7 W				
24	K6S-22Z-1.7-71	GJH1213001R7221	10	0.175
24	K6S-31Z-1.7-71	GJH1213001R7311	10	0.175
24	K6S-40E-1.7-71	GJH1213001R7401	10	0.175
DC operation 17 ... 32 V / 2.8 W				
17 ... 32	K6S-22Z-2.8-72	GJH1213001R7222	10	0.175
17 ... 32	K6S-31Z-2.8-72	GJH1213001R7312	10	0.175
17 ... 32	K6S-40E-2.8-72	GJH1213001R7402	10	0.175

Other types on request

Main dimensions mm, inches

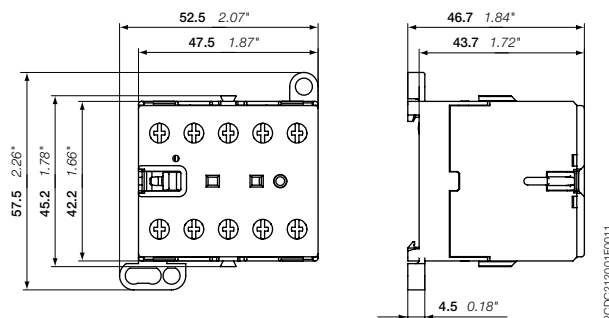

KC6

TKC6 4-pole mini contactor relays – with screw terminals

DC operated – large coil voltage range



2CDC211021F0011

3

TKC6-31Z

Description

TKC6 4-pole mini contactors are space optimized control products mainly used for control functions or for small loads up to 4 A.

These contactors are designed with:

- 4-poles with various contact combinations
- control circuit: DC operated, hum free, low consumption (5 W at pull-in and at holding)
- expanded ambient temperature range -30 ... +70 °C and wide range voltage supply
- material is suitable for railway applications
- humfree operating DC coil
- no auxiliary contact block permitted for mounting
- designed for rail or wall mounting

Ordering details

Rated control circuit voltage $U_{C \min} \dots U_{C \max}$ V DC	Type	Order code	Pkg qty	Weight (1 pce) kg
17 ... 32	TKC6-22Z-51	GJH1213061R5221	10	0.180
50 ... 90	TKC6-22Z-55	GJH1213061R5225	10	0.180
77 ... 143	TKC6-22Z-62	GJH1213061R6222	10	0.180
140 ... 260	TKC6-22Z-68	GJH1213061R6228	10	0.180
17 ... 32	TKC6-31Z-51	GJH1213061R5311	10	0.180
50 ... 90	TKC6-31Z-55	GJH1213061R5315	10	0.180
77 ... 143	TKC6-31Z-62	GJH1213061R6312	10	0.180
140 ... 260	TKC6-31Z-68	GJH1213061R6318	10	0.180
17 ... 32	TKC6-40E-51	GJH1213061R5401	10	0.180
50 ... 90	TKC6-40E-55	GJH1213061R5405	10	0.180
77 ... 143	TKC6-40E-62	GJH1213061R6402	10	0.180
140 ... 260	TKC6-40E-68	GJH1213061R6408	10	0.180

Other types on request

Main dimensions mm, inches

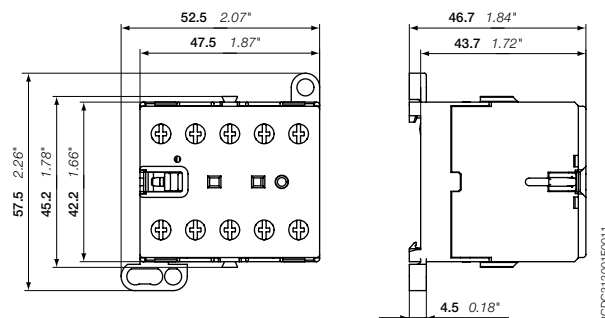

TKC6

2CDC212001F0011

2CDC102014C0201

B6, B7, BC6, BC7 3 and 4-pole mini contactors VB6, VB7, VBC6, VBC7 3-pole mini reversing contactors Accessories



CAF6-11N

2CDC2110750010



RV-BC6/250

2CDC21100750010



CA6-11E-P

2CDC21103650010



CA6-11E

2CDC21101850011



BSM6-30

5S127792R



T16

2CDC231012F0011

Ordering details

For contactors	Auxiliary contacts	Type	Order code	Pkg qty	Weight (1 pce)
					kg

Front-mounted instantaneous auxiliary contact blocks (not allowed for mounting on TBC, B6S, B7S, interface contactors) (1)

B6-, B7-40-00, BC6-, BC7-40-00	1 1	CAF6-11E	GJL1201330R0002	10	0.020
VB6, VB7, VBC6, VBC7, VB6A, VB7A	2 0	CAF6-20E	GJL1201330R0006	10	0.020
VBC6A, VBC7A	0 2	CAF6-02E	GJL1201330R0010	10	0.020
B6-, B7-30-10, BC6-, BC7-30-10	1 1	CAF6-11M	GJL1201330R0003	10	0.020
VB6, VB7, VBC6, VBC7, VB6A, VB7A	2 0	CAF6-20M	GJL1201330R0007	10	0.020
VBC6A, VBC7A	0 2	CAF6-02M	GJL1201330R0011	10	0.020
B6-, B7-30-01, BC6-, BC7-30-01	1 1	CAF6-11N	GJL1201330R0004	10	0.020
VB6, VB7, VBC6, VBC7, VB6A, VB7A	2 0	CAF6-20N	GJL1201330R0008	10	0.020
VBC6A, VBC7A	0 2	CAF6-02N	GJL1201330R0012	10	0.020

Side-mounted instantaneous auxiliary contact block (1)

B6-, B7-40-00, BC6-, BC7-40-00	1 1	CA6-11E	GJL1201317R0002	10	0.030
B6-, B7-30-10, BC6-, BC7-30-10	1 1	CA6-11M	GJL1201317R0003	10	0.030
B6-, B7-30-01, BC6-, BC7-30-01	1 1	CA6-11N	GJL1201317R0004	10	0.030

(1) CA6 and CAF6 must not be fitted simultaneously.

For contactors	Rated control circuit voltage U _c V DC	Connection type	Type	Order code	Pkg qty	Weight (1 pce) kg
----------------	--	-----------------	------	------------	---------	----------------------

Surge suppressors for contactor coils

BC6, BC7	24...60	Cable lug	RV-BC6/60	GHV2501902R0002	10	0.005
		Flat pin, 2.8 mm	RV-BC6-F/60	GHV2501902R0003	10	0.005
	50...250	Cable lug	RV-BC6/250	GHV2501903R0002	10	0.005
		Flat pin, 2.8 mm	RV-BC6-F/250	GHV2501903R0003	10	0.010
	380	Cable lug	RV-BC6/380	GHV2501904R0002	10	0.005
		Flat pin, 2.8 mm	RV-BC6-F/380	GHV2501904R0003	10	0.010

Note: Mini contactors for AC operation have an integrated protective circuit.

Connecting links with manual motor starters

To connect B..VB.. mini contactor to MS116, MS132	BEA7/132	1SBN080906R1002	10	0.013
To connect B..VB.. mini contactors to MS325	BEA7/325	1SBN080906R1001	10	0.021

Connection sets for reversing contactors

VB6, VB7, VBC6, VBC7, VB6A, VB7A, VBC6A, VBC7A, cross-section 1.8 mm ²	BSM6-30	GJL1201908R0001	10	0.010
--	---------	-----------------	----	-------

Parallel connecting link

B6, B7, BC6, BC7	LP6	GJL1201907R0001	100	0.009
------------------	-----	-----------------	-----	-------

Cover cap, transparent fitting to DIN rail design, sealable

B6, B7, BC6, BC7	LT6-B	GJL1201906R0001	10	0.015
------------------	-------	-----------------	----	-------

Overload relays fitting details (2)

Contactor types	Thermal overload relays	Electronic overload relays
B6, B7, BC6, BC7	T16 (0.10...16 A)	E16DU (0.10...18.9 A)

(2) Direct mounting - No kit required. Ordering details, see overload relays section.

K6, KC6 4-pole mini contactor relays

Accessories



CAF6-11K

2CDC211019S0011



CA6-11K

2CDC211006S0010



CA6-11K-P

2CDC211011S0010



LT6-B

2CDC211006S0010



RV-BC6/250

2CDC211007S0010

Ordering details

For contactors	Auxiliary contacts	Type	Order code	Pkg qty	Weight (1 pce)
					kg

Front-mounted instantaneous auxiliary contact blocks (1)

K6, KC6	1 1	CAF6-11K	GJL1201330R0001	10	0.020
	2 0	CAF6-20K	GJL1201330R0005	10	0.020
	0 2	CAF6-02K	GJL1201330R0009	10	0.020

Side-mounted instantaneous auxiliary contact block (1)

K6, KC6	1 1	CA6-11K	GJL1201317R0001	10	0.030
---------	-----	---------	-----------------	----	-------

(1) CA6 and CAF6 must not be fitted simultaneously.

For contactors	Rated control circuit voltage U_c V DC	Connection type	Type	Order code	Pkg qty	Weight (1 pce)
						kg

Surge suppressors for contactor coils

KC6	24...60	Cable lug	RV-BC6/60	GHV2501902R0002	10	0.005
		Flat pin, 2.8 mm	RV-BC6-F/60	GHV2501902R0003	10	0.005
	50...250	Cable lug	RV-BC6/250	GHV2501903R0002	10	0.005
		Flat pin, 2.8 mm	RV-BC6-F/250	GHV2501903R0003	10	0.010
	380	Cable lug	RV-BC6/380	GHV2501904R0002	10	0.005
		Flat pin, 2.8 mm	RV-BC6-F/380	GHV2501904R0003	10	0.010

Note: Mini contactors for AC operation have an integrated protective circuit.

Cover cap, transparent fitting to DIN rail design, sealable

K6, KC6		LT6-B	GJL1201906R0001	10	0.015
---------	--	-------	-----------------	----	-------

Notes

A series of horizontal dotted lines for taking notes, spanning the width of the page.

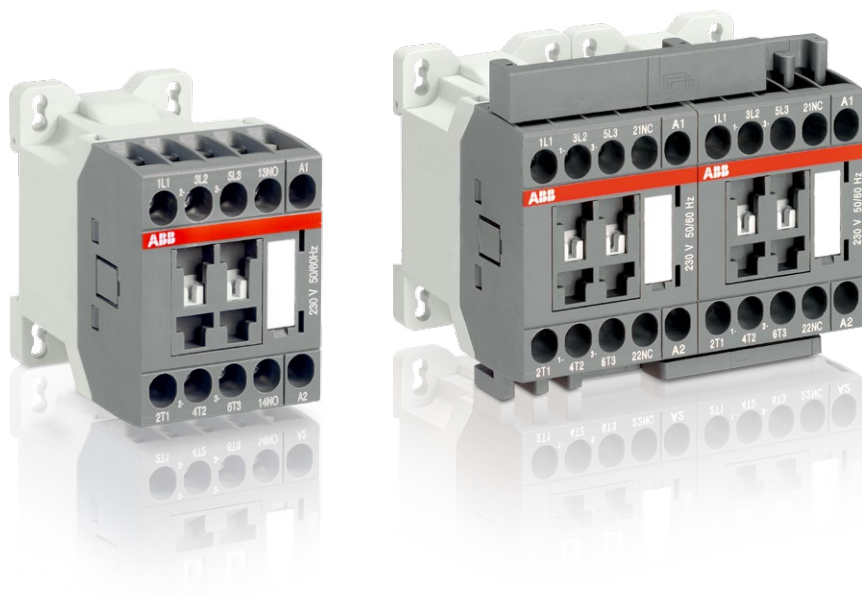

AS 3-pole contactors and NS contactor relays with screw terminals

[Overview](#) 4/2

3-pole contactors

AS09 ... AS16	AC operated	4/4
ASL09 ... ASL16	DC operated	4/5
AS09 ... AS16	AC operated - 2-stack	4/6
ASL09 ... ASL16	DC operated - 2-stack	4/7
Main accessories		4/8

Contactor relays

NS	AC operated	4/10
NSL	DC operated	4/11
Main accessories		4/12

[Voltage code table](#) 4/14

For direct product details information, use product type or order code, ex:
www.abb.com/productdetails/AF09-30-10-13 or www.abb.com/productdetails/1SBL137001R1310

Compact Optimize your equipment dimensions!

One frame size for contactors up to 7.5 kW - 400 V

Same dimensions

for AC and DC operated contactors with screw or spring terminals

4

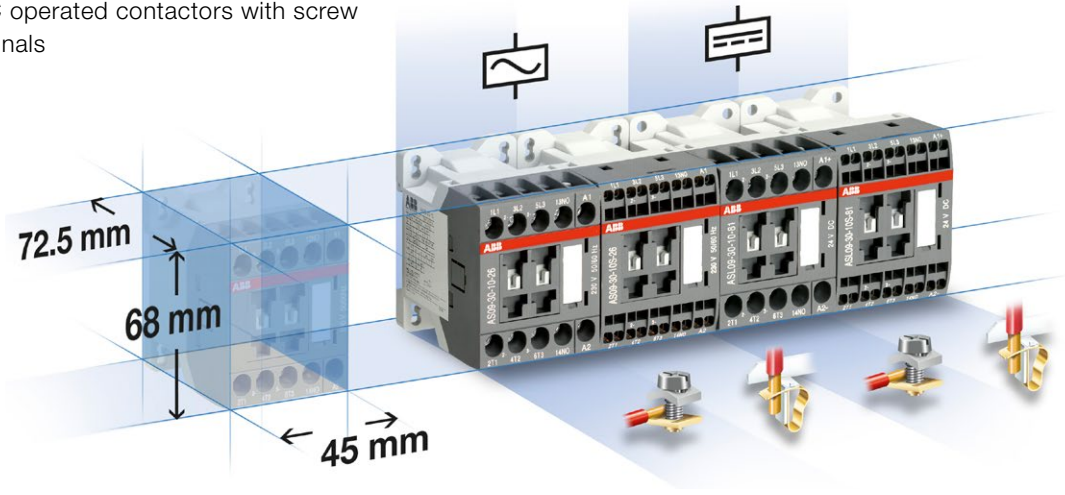

Reversing contactors

including mechanical and electrical interlocking without additional width

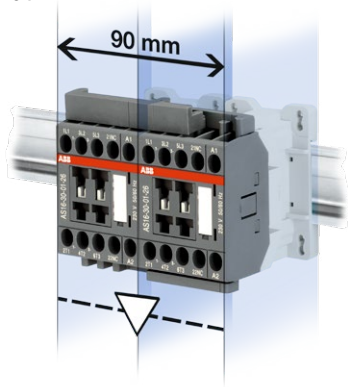

Direct control by PLC

removing any use of interface relay and reducing panel power consumption

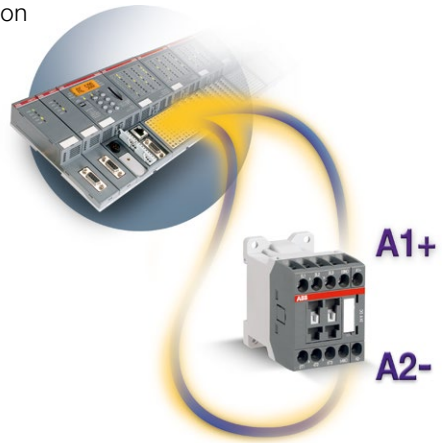

Side clipped-on surge suppressors

integrated into overall contactor dimensions allowing free access to coil terminals

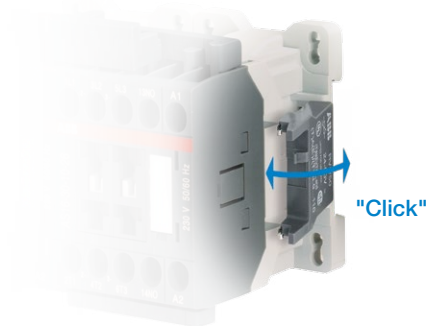

Multiple packaging available for all products



Simple

Choose reliable and time-saving solutions

Select compact starters:

- Direct-on-line and reversing starters up to 7.5 kW – 400 V
- Star-delta starters up to 11 KW – 400 V.

Protect your motors against short-circuits and overloads

- Type 1 or type 2 coordination guaranteed between contactors and short-circuit protection devices (manual motor starters or fuses)

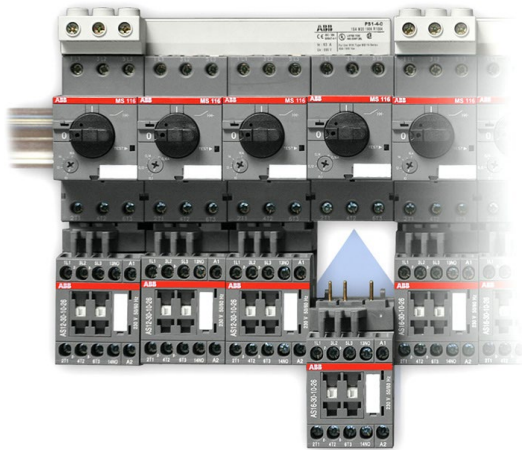

Time/cost saving solutions with

- Connection sets for reversing and star-delta starter
- Easy, fast and secure assembly, fitting and wiring of components
- Direct 35 mm rail mounting: no additional mounting plate required
- Easy installation and dismantling of contactors: no unwiring of manual motor starters.



Compliant to International standards Complies with RoHS European directives



Make your control circuits safe



High reliability for low signals



Mechanically linked contacts according to IEC 60947-5-1 Annex L 3.0



Mirror contact according to IEC 60947-4-1 Annex F 2.1

Time and space-saving solutions, suitable for your applications

- Escalators
- Elevators
- Conveyors
- Compressors
- Door control
- Hvac
- Pumps
- Washing machines...

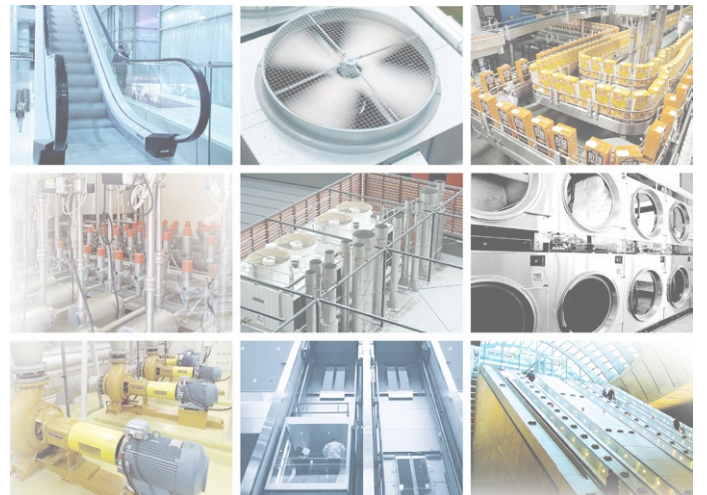

AS09 ... AS16 3-pole contactors

4 to 7.5 kW

AC operated



AS09-30-10

Description

AS09 ... AS16 contactors are mainly used for controlling 3-phase motors and power circuits up to 690 V AC and 220 V DC.

These contactors are of the block type design with:

- 3 main poles and 1 built-in auxiliary contact
- control circuit: AC operated
- add-on auxiliary contact blocks for front mounting and a comprehensive range of accessories.

Ordering details

IEC Rated operational power 400 V AC-3 kW	Rated operational current $\theta \leq 40^\circ\text{C}$ AC-1 A	UL/CSA 3-phase motor rating 480 V hp	General use rating 600 V AC A	Rated control circuit voltage Uc (1)		Auxiliary contacts fitted 	Type	Order code	Weight Pkg (1 pce) kg				
				V 50 Hz	V 60 Hz								
4	22	5	20	24	24	1 0	AS09-30-10-20	1SBL101001R2010	0.220				
						0 1	AS09-30-01-20	1SBL101001R2001	0.220				
				-	120	1 0	AS09-30-10-16	1SBL101001R1610	0.220				
						0 1	AS09-30-01-16	1SBL101001R1601	0.220				
				230	230	1 0	AS09-30-10-26	1SBL101001R2610	0.220				
						0 1	AS09-30-01-26	1SBL101001R2601	0.220				
				400	400	1 0	AS09-30-10-28	1SBL101001R2810	0.220				
						0 1	AS09-30-01-28	1SBL101001R2801	0.220				
				5.5	24	7.5	20	24	24	1 0	AS12-30-10-20	1SBL111001R2010	0.220
										0 1	AS12-30-01-20	1SBL111001R2001	0.220
-	120	1 0	AS12-30-10-16					1SBL111001R1610	0.220				
		0 1	AS12-30-01-16					1SBL111001R1601	0.220				
230	230	1 0	AS12-30-10-26					1SBL111001R2610	0.220				
		0 1	AS12-30-01-26					1SBL111001R2601	0.220				
400	400	1 0	AS12-30-10-28					1SBL111001R2810	0.220				
		0 1	AS12-30-01-28					1SBL111001R2801	0.220				
7.5	24	10	20					24	24	1 0	AS16-30-10-20	1SBL121001R2010	0.220
										0 1	AS16-30-01-20	1SBL121001R2001	0.220
				-	120	1 0	AS16-30-10-16	1SBL121001R1610	0.220				
						0 1	AS16-30-01-16	1SBL121001R1601	0.220				
				230	230	1 0	AS16-30-10-26	1SBL121001R2610	0.220				
						0 1	AS16-30-01-26	1SBL121001R2601	0.220				
				400	400	1 0	AS16-30-10-28	1SBL121001R2810	0.220				
						0 1	AS16-30-01-28	1SBL121001R2801	0.220				

Note: for multiple packaging, please contact your ABB local sales organization.

(1) Other control voltages see voltage code table.

Main dimensions mm, inches

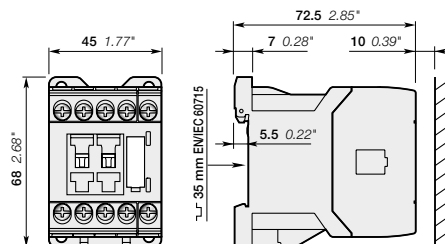

AS09, AS12, AS16

ASL09 ... ASL16 3-pole contactors

4 to 7.5 kW

DC operated



ASL09-30-10

Description

ASL09 ... ASL16 contactors are mainly used for controlling 3-phase motors and power circuits up to 690 V AC and 220 V DC.

These contactors are of the block type design with:

- 3 main poles and 1 built-in auxiliary contact
- control circuit: low consumption (3 W at pull-in and holding) DC operated with solid core magnet. Suitable for direct control by PLC outputs (the polarity on the coil terminals A1+ and A2- must be respected)
- add-on auxiliary contact blocks for front mounting and a comprehensive range of accessories.

Ordering details

IEC		UL/CSA		Rated control circuit voltage Uc (1)	Auxiliary contacts fitted	Type	Order code	Weight Pkg (1 pce) kg
Rated operational power	Rated operational current $\theta \leq 40^\circ\text{C}$	3-phase motor rating 480 V	General use rating 600 V AC					
400 V AC-3 kW	AC-1 A	hp	A	V DC				
4	22	5	20	24	1 0	ASL09-30-10-81	1SBL103001R8110	0.280
					0 1	ASL09-30-01-81	1SBL103001R8101	0.280
					1 0	ASL09-30-10-83	1SBL103001R8310	0.280
					0 1	ASL09-30-01-83	1SBL103001R8301	0.280
					1 0	ASL09-30-10-86	1SBL103001R8610	0.280
					0 1	ASL09-30-01-86	1SBL103001R8601	0.280
5.5	24	7.5	20	24	1 0	ASL12-30-10-81	1SBL113001R8110	0.280
					0 1	ASL12-30-01-81	1SBL113001R8101	0.280
					1 0	ASL12-30-10-83	1SBL113001R8310	0.280
					0 1	ASL12-30-01-83	1SBL113001R8301	0.280
					1 0	ASL12-30-10-86	1SBL113001R8610	0.280
					0 1	ASL12-30-01-86	1SBL113001R8601	0.280
7.5	24	10	20	24	1 0	ASL16-30-10-81	1SBL123001R8110	0.280
					0 1	ASL16-30-01-81	1SBL123001R8101	0.280
					1 0	ASL16-30-10-83	1SBL123001R8310	0.280
					0 1	ASL16-30-01-83	1SBL123001R8301	0.280
					1 0	ASL16-30-10-86	1SBL123001R8610	0.280
					0 1	ASL16-30-01-86	1SBL123001R8601	0.280
7.5	24	10	20	24	1 0	ASL16-30-10-88	1SBL123001R8810	0.280
					0 1	ASL16-30-01-88	1SBL123001R8801	0.280
					1 0	ASL16-30-10-81	1SBL123001R8110	0.280
					0 1	ASL16-30-01-81	1SBL123001R8101	0.280
					1 0	ASL16-30-10-83	1SBL123001R8310	0.280
					0 1	ASL16-30-01-83	1SBL123001R8301	0.280

Note: for multiple packaging, please contact your ABB local sales organization.

(1) Other control voltages see voltage code table.

Main dimensions mm, inches

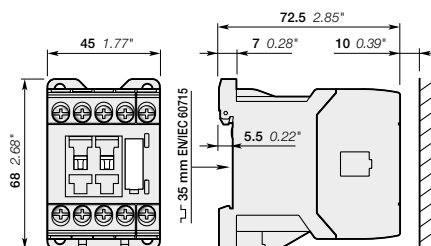

ASL09, ASL12, ASL16

AS09 ... AS16 2-stack 3-pole contactors

4 to 7.5 kW

AC operated



AS09-30-32

Description

AS09 ... AS16 contactors are mainly used for controlling 3-phase motors and power circuits up to 690 V AC and 220 V DC.

These contactors are of the block type design with:

- 1st stack with 3 main poles and 1 N.O. built-in auxiliary contact
- 2nd stack with permanently fixed 2 N.O. + 2 N.C. auxiliary contact block. The auxiliary contact elements are mechanically linked (side-marked symbol) and the N.C. auxiliary contacts are mirror contacts
- control circuit: AC operated
- a comprehensive range of accessories.

Ordering details

IEC Rated operational power 400 V AC-3 kW	UL/CSA 3-phase motor rating 480 V hp	General use rating 600 V AC A	Rated control circuit voltage Uc (1)		Auxiliary contacts fitted	Type	Order code	Weight Pkg (1 pce) kg	
			V 50 Hz	V 60 Hz					
4	22	5	20	24	24	3 2	AS09-30-32-20	1SBL101001R2032	0.260
				-	120		3 2	AS09-30-32-16	1SBL101001R1632
				230	230	3 2	AS09-30-32-26	1SBL101001R2632	0.260
				400	400	3 2	AS09-30-32-28	1SBL101001R2832	0.260
5.5	24	7.5	20	24	24	3 2	AS12-30-32-20	1SBL111001R2032	0.260
				-	120		3 2	AS12-30-32-16	1SBL111001R1632
				230	230	3 2	AS12-30-32-26	1SBL111001R2632	0.260
				400	400	3 2	AS12-30-32-28	1SBL111001R2832	0.260
7.5	24	10	20	24	24	3 2	AS16-30-32-20	1SBL121001R2032	0.260
				-	120		3 2	AS16-30-32-16	1SBL121001R1632
				230	230	3 2	AS16-30-32-26	1SBL121001R2632	0.260
				400	400	3 2	AS16-30-32-28	1SBL121001R2832	0.260

Note: for multiple packaging, please contact your ABB local sales organization.

(1) Other control voltages see voltage code table.

Main dimensions mm, inches

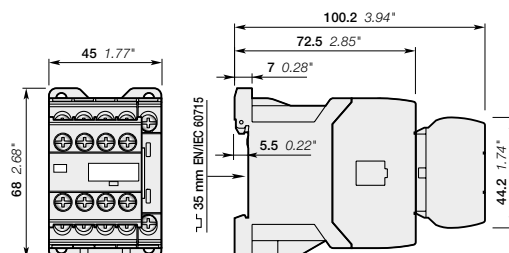

AS09, AS12, AS16

ASL09 ... ASL16 2-stack 3-pole contactors

4 to 7.5 kW

DC operated



ASL09-30-32

Description

ASL09 ... ASL16 contactors are mainly used for controlling 3-phase motors and power circuits up to 690 V AC and 220 V DC.

These contactors are of the block type design with:

- 1st stack with 3 main poles and 1 N.O. built-in auxiliary contact
- 2nd stack with permanently fixed 2 N.O. + 2 N.C. auxiliary contact block. The auxiliary contact elements are mechanically linked (side-marked symbol) and the N.C. auxiliary contacts are mirror contacts
- control circuit: low consumption (3 W at pull-in and holding) DC operated with solid core magnet. Suitable for direct control by PLC outputs (the polarity on the coil terminals A1+ and A2- must be respected)
- a comprehensive range of accessories.

Ordering details

IEC	Rated power	operational current $\theta \leq 40^\circ\text{C}$	UL/CSA 3-phase motor rating 480 V	General use rating 600 V AC	Rated control circuit voltage U_c (1)	Auxiliary contacts fitted	Type	Order code	Weight
400 V AC-3	kW	A	hp	A	VDC	I L			Pkg (1 pce)
4	22	5	20	24	3 2	ASL09-30-32-81	1SBL103001R8132	0.320	
				48	3 2	ASL09-30-32-83	1SBL103001R8332	0.320	
				110	3 2	ASL09-30-32-86	1SBL103001R8632	0.320	
				220	3 2	ASL09-30-32-88	1SBL103001R8832	0.320	
5.5	24	7.5	20	24	3 2	ASL12-30-32-81	1SBL113001R8132	0.320	
				48	3 2	ASL12-30-32-83	1SBL113001R8332	0.320	
				110	3 2	ASL12-30-32-86	1SBL113001R8632	0.320	
				220	3 2	ASL12-30-32-88	1SBL113001R8832	0.320	
7.5	24	10	20	24	3 2	ASL16-30-32-81	1SBL123001R8132	0.320	
				48	3 2	ASL16-30-32-83	1SBL123001R8332	0.320	
				110	3 2	ASL16-30-32-86	1SBL123001R8632	0.320	
				220	3 2	ASL16-30-32-88	1SBL123001R8832	0.320	

Note: for multiple packaging, please contact your ABB local sales organization.

(1) Other control voltages see voltage code table.

Main dimensions mm, inches

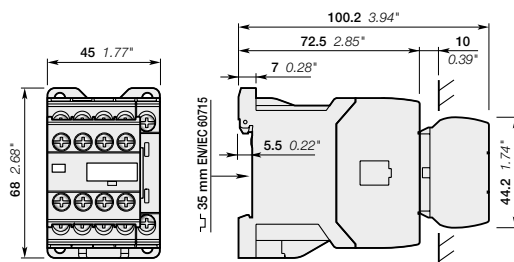

ASL09, ASL12, ASL16

AS09 ... AS16 and ASL09 ... ASL16 3-pole contactors

Main accessories

Contactor and main accessories (other accessories available)

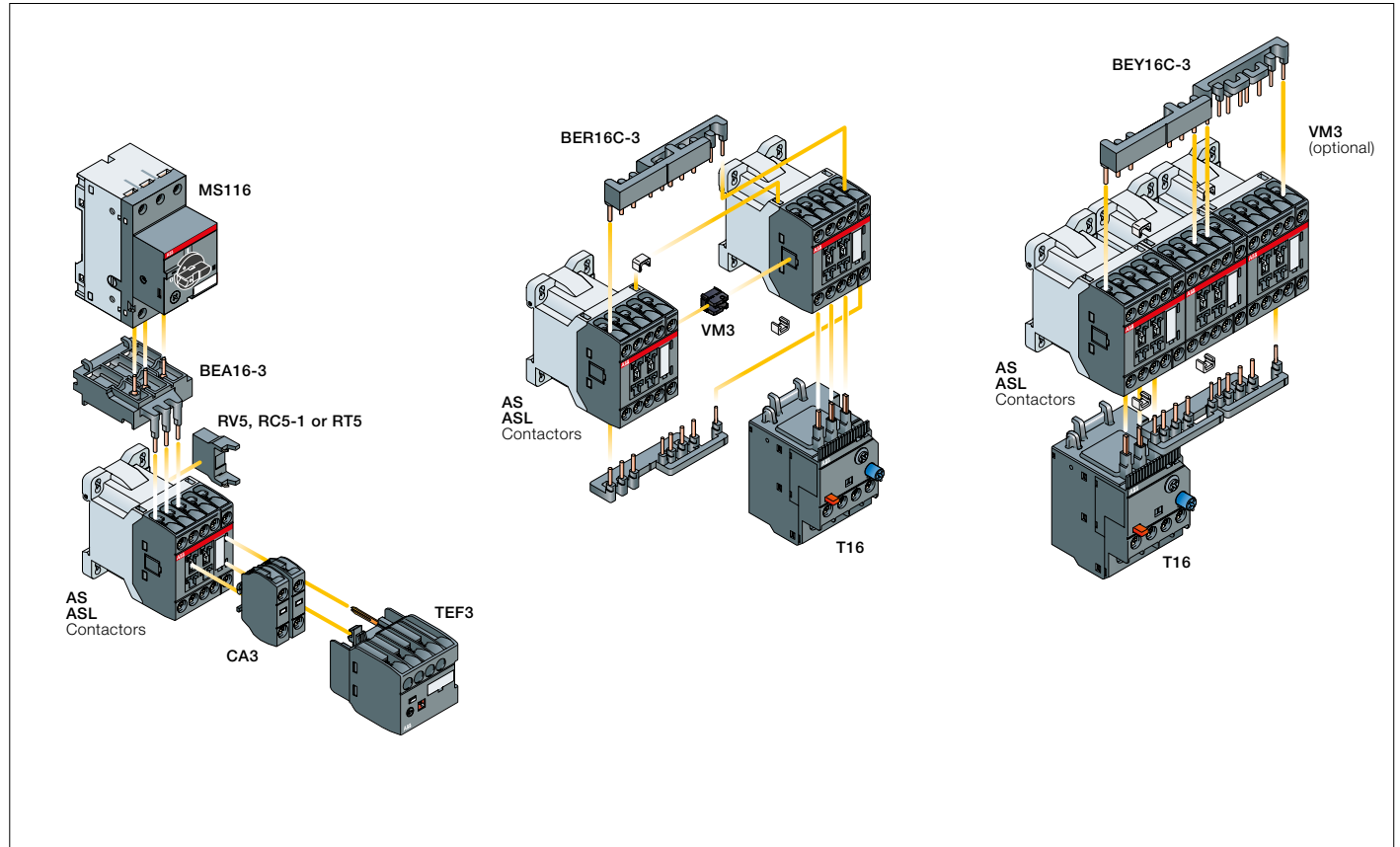

Main accessory fitting details

Many configurations of accessories are possible depending on whether these are front-mounted or side-mounted.

Contactor types	Main poles	Built-in auxiliary contacts	Front-mounted accessories			Side-mounted accessories	
			Auxiliary contact blocks	Electronic timer	Mechanical interlock unit (between 2 contactors)	Surge suppressors	
AS09 ... AS16	3 0	1 0	2 max.	or 1	+ 1	+ RV5	or RC5-1
	3 0	0 1	-	-	1	+ RV5	or RC5-1
ASL09 ... ASL16	3 0	1 0	2 max.	or 1	+ 1	+ RV5	or RT5
	3 0	0 1	-	-	1	+ RV5	or RT5

Overload relays fitting details (1)

Contactor types	Thermal overload relays
AS09 ... AS16	T16 (0.10...16 A)
ASL09 ... ASL16	

The addition of an overload relay on the contactor does not prevent fitting of many other accessories as shown above.

(1) Direct mounting - No kit required.

AS09 ... AS16 and ASL09 ... ASL16 3-pole contactors

Main accessories



CA3-10

Front-mounted instantaneous auxiliary contact blocks

For contactors	Auxiliary contacts	Type	Order code	Pkg qty	Weight (1 pce) kg
AS09 ... AS16	1 0	CA3-10	1SBN011010T1010	10	0.011
ASL09 ... ASL16	0 1	CA3-01	1SBN011010T1001	10	0.011



TEF3-ON

Front-mounted electronic timer

For contactors	Rated control circuit voltage - U _c V	Type	Order code	Pkg qty	Weight (1 pce) kg
ON-delay					
AS09 ... AS16, ASL09 ... ASL16	24...240 V AC/DC	TEF3-ON	1SBN021012R1000	1	0.065
OFF-delay					
AS09 ... AS16, ASL09 ... ASL16	24...240 V AC/DC	TEF3-OFF	1SBN021014R1000	1	0.065



VM3

Mechanical interlock unit

For contactors	Type	Order code	Pkg qty	Weight (1 pce) kg
AS09 ... AS16, ASL09 ... ASL16	VM3	1SBN031005T1000	10	0.002



RV5

Surge suppressors

For contactors	Rated control circuit voltage - U _c		Type	Order code	Pkg qty	Weight (1 pce) kg
	V	AC DC				
AS09 ... AS16, ASL09 ... ASL16	24...50	● ●	RV5/50	1SBN050010R1000	2	0.015
	50...133	● ●	RV5/133	1SBN050010R1001	2	0.015
	110...250	● ●	RV5/250	1SBN050010R1002	2	0.015
	250...440	● ●	RV5/440	1SBN050010R1003	2	0.015
AS09 ... AS16	24...50	● -	RC5-1/50	1SBN050100R1000	2	0.012
	50...133	● -	RC5-1/133	1SBN050100R1001	2	0.012
	110...250	● -	RC5-1/250	1SBN050100R1002	2	0.012
	250...440	● -	RC5-1/440	1SBN050100R1003	2	0.012
ASL09 ... ASL16	12...32	- ●	RT5/32	1SBN050020R1000	2	0.015
	25...65	- ●	RT5/65	1SBN050020R1001	2	0.015
	50...90	- ●	RT5/90	1SBN050020R1002	2	0.015
	77...150	- ●	RT5/150	1SBN050020R1003	2	0.015
	150...264	- ●	RT5/264	1SBN050020R1004	2	0.015



BEA16-3

Connecting links with manual motor starters

For contactors	Manual motor starter	Type	Order code	Pkg qty	Weight (1 pce) kg
AS09 ... AS16	MS116-0.16 ... MS116-16	BEA16-3	1SBN081006T1000	10	0.019
ASL09 ... ASL16	MS132-0.16 ... MS132-16				

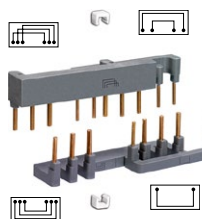

BER16C-3

Connection sets for reversing contactors

For contactors	Mechanical interlock unit	Type	Order code	Pkg qty	Weight (1 pce) kg
AS09 ... AS16, ASL09 ... ASL16	with or without VM3	BER16C-3	1SBN081012R1000	1	0.035

Note: BER16C-3 connection set includes two BB3 fixing clips, and an electrical interlocking when fitted on contactors with built-in N.C. auxiliary contacts. BER16C-3 can be used with or without VM3 mechanical interlock unit.

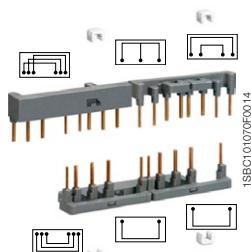

BEY16C-3

Connection sets for star-delta starting

For contactors	Mech. interlock unit between Star & Delta contactors	Type	Order code	Pkg qty	Weight (1 pce) kg
AS09 ... AS12, ASL09 ... ASL12	with or without VM3	BEY16C-3	1SBN081018R2000	1	0.041

Note: BEY16C-3 connection set includes two BB3 fixing clips, and an electrical interlocking when fitted on Star and Delta contactors with built-in N.C. auxiliary contacts. BEY16C-3 can be used with or without VM3 mechanical interlock unit.

NS contactor relays

AC operated



NS22E

Description

NS contactor relays are used for switching auxiliary and control circuits.

These contactor relays are designed with:

- 4 poles or 8 poles. Contactor relays have mechanically linked auxiliary contact elements (side-marked symbol)
- control circuit: AC operated
- add-on auxiliary contact blocks for front mounting and a comprehensive range of accessories.

Ordering details

Number of contacts 1st stack	2nd stack	Rated control circuit voltage Uc (1)		Type	Order code	Weight Pkg (1 pce) kg
		V 50 Hz	V 60 Hz			
		24	24	NS22E-20	1SBH101001R2022	0.220
		-	120	NS22E-16	1SBH101001R1622	0.220
		230	230	NS22E-26	1SBH101001R2622	0.220
		400	400	NS22E-28	1SBH101001R2822	0.220
		-	120	NS31E-16	1SBH101001R1631	0.220
		230	230	NS31E-26	1SBH101001R2631	0.220
		400	400	NS31E-28	1SBH101001R2831	0.220
		-	120	NS40E-16	1SBH101001R1640	0.220
		230	230	NS40E-26	1SBH101001R2640	0.220
		400	400	NS40E-28	1SBH101001R2840	0.220
		-	120	NS44E-16	1SBH101001R1644	0.260
		230	230	NS44E-26	1SBH101001R2644	0.260
		400	400	NS44E-28	1SBH101001R2844	0.260
		-	120	NS53E-16	1SBH101001R1653	0.260
		230	230	NS53E-26	1SBH101001R2653	0.260
		400	400	NS53E-28	1SBH101001R2853	0.260
		-	120	NS62E-16	1SBH101001R1662	0.260
		230	230	NS62E-26	1SBH101001R2662	0.260
		400	400	NS62E-28	1SBH101001R2862	0.260
		-	120	NS71E-16	1SBH101001R1671	0.260
		230	230	NS71E-26	1SBH101001R2671	0.260
		400	400	NS71E-28	1SBH101001R2871	0.260
		-	120	NS80E-16	1SBH101001R1680	0.260
		230	230	NS80E-26	1SBH101001R2680	0.260
		400	400	NS80E-28	1SBH101001R2880	0.260

Note: for multiple packaging, please contact your ABB local sales organization.

(1) Other control voltages see voltage code table.

Main dimensions mm, inches

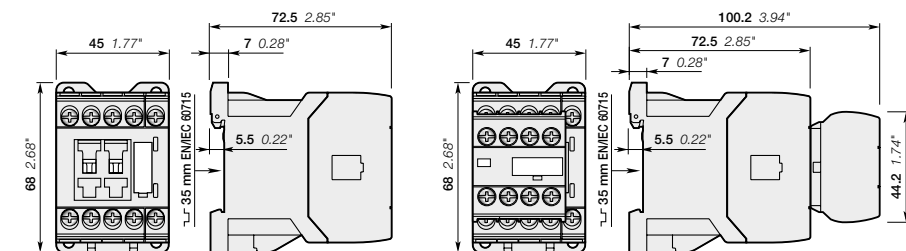

NS22E, NS31E, NS40E

NS44E, NS53E, NS62E, NS71E, NS80E

1SBC101475S0201

NSL contactor relays

DC operated



NSL22E

1SBC101018F0014

Description

NSL contactor relays are used for switching auxiliary and control circuits.

These contactor relays are designed with:

- 4 poles or 8 poles. Contactor relays have mechanically linked auxiliary contact elements (side-marked symbol)
- control circuit: low coil consumption (3 W at pull-in and holding) DC operated with solid core magnet. Suitable for direct control by PLC outputs (the polarity on the coil terminals A1+ and A2- must be respected)
- add-on auxiliary contact blocks for front mounting and a comprehensive range of accessories.

Ordering details

Number of contacts 1st stack	2nd stack	Rated control circuit voltage Uc (1) V DC	Type	Order code	Weight
					Pkg (1 pce) kg
		24	NSL22E-81	1SBH103001R8122	0.280
		48	NSL22E-83	1SBH103001R8322	0.280
		110	NSL22E-86	1SBH103001R8622	0.280
		220	NSL22E-88	1SBH103001R8822	0.280
		24	NSL31E-81	1SBH103001R8131	0.280
		48	NSL31E-83	1SBH103001R8331	0.280
		110	NSL31E-86	1SBH103001R8631	0.280
		220	NSL31E-88	1SBH103001R8831	0.280
		24	NSL40E-81	1SBH103001R8140	0.280
		48	NSL40E-83	1SBH103001R8340	0.280
		110	NSL40E-86	1SBH103001R8640	0.280
		220	NSL40E-88	1SBH103001R8840	0.280
		24	NSL44E-81	1SBH103001R8144	0.320
		48	NSL44E-83	1SBH103001R8344	0.320
		110	NSL44E-86	1SBH103001R8644	0.320
		220	NSL44E-88	1SBH103001R8844	0.320
		24	NSL53E-81	1SBH103001R8153	0.320
		48	NSL53E-83	1SBH103001R8353	0.320
		110	NSL53E-86	1SBH103001R8653	0.320
		220	NSL53E-88	1SBH103001R8853	0.320
		24	NSL62E-81	1SBH103001R8162	0.320
		48	NSL62E-83	1SBH103001R8362	0.320
		110	NSL62E-86	1SBH103001R8662	0.320
		220	NSL62E-88	1SBH103001R8862	0.320
		24	NSL71E-81	1SBH103001R8171	0.320
		48	NSL71E-83	1SBH103001R8371	0.320
		110	NSL71E-86	1SBH103001R8671	0.320
		220	NSL71E-88	1SBH103001R8871	0.320
		24	NSL80E-81	1SBH103001R8180	0.320
		48	NSL80E-83	1SBH103001R8380	0.320
		110	NSL80E-86	1SBH103001R8680	0.320
		220	NSL80E-88	1SBH103001R8880	0.320

Note: for multiple packaging, please contact your ABB local sales organization.

(1) Other control voltages see voltage code table.

Main dimensions mm, inches

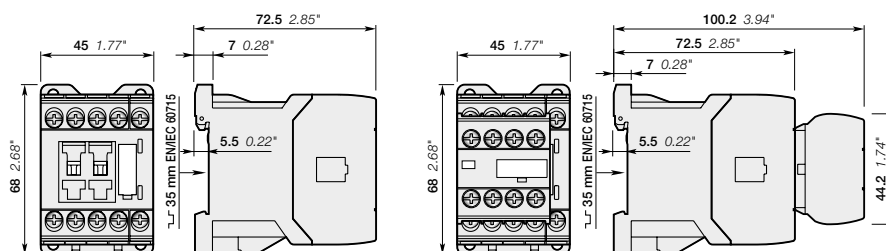

NSL22E, NSL31E, NSL40E

NSL44E, NSL53E, NSL62E, NSL71E, NSL80E



NS and NSL contactor relays

Main accessories

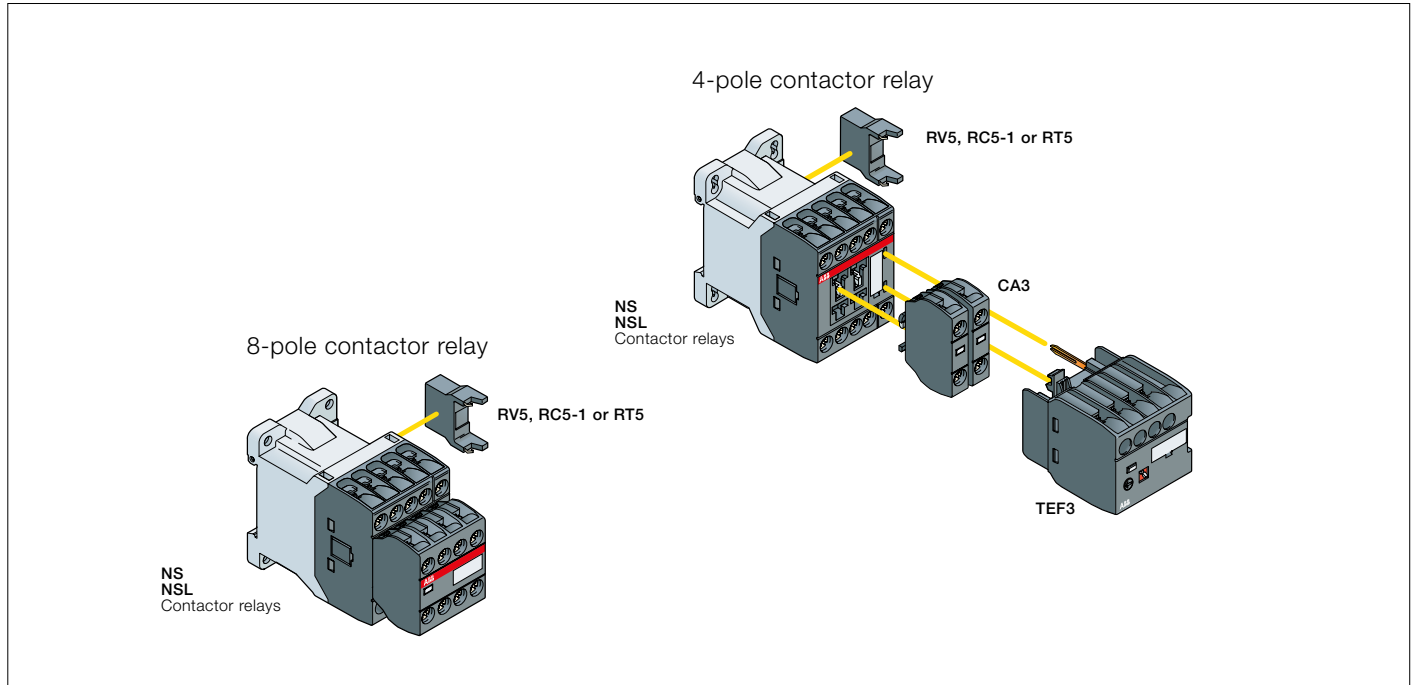
Contactor relays and main accessories (other accessories available)



Main accessory fitting details

Contactor types	Main poles	Front-mounted accessories		Side-mounted accessories	
		Auxiliary contact blocks	Electronic timer	Surge suppressors	
	 	1-pole CA3	TEF3		
NS..	2 2 E	2 max.	or 1	+	RV5 or RC5-1
NS..	3 1 E				
NS..	4 0 E				
NS..	4 4 E	-	-		RV5 or RC5-1
NS..	5 3 E				
NS..	6 2 E				
NS..	7 1 E				
NS..	8 0 E				
NSL..	2 2 E	2 max.	or 1	+	RV5 or RT5
NSL..	3 1 E				
NSL..	4 0 E				
NSL..	4 4 E	-	-		RV5 or RT5
NSL..	5 3 E				
NSL..	6 2 E				
NSL..	7 1 E				
NSL..	8 0 E				

NS and NSL contactor relays

Main accessories



CA3-10



TEF3-ON



RV5

Front-mounted instantaneous auxiliary contact blocks

For contactor relays	Auxiliary contacts	Type	Order code	Pkg qty	Weight (1 pce)
		CA3-10	1SBN011010T1010	10	0.011
		CA3-01	1SBN011010T1001	10	0.011

Front-mounted electronic timer

For contactors	Rated control circuit voltage - U _c V	Type	Order code	Pkg qty	Weight (1 pce)
ON-delay					
NS, NSL	24...240 V AC/DC	TEF3-ON	1SBN021012R1000	1	0.065
OFF-delay					
NS, NSL	24...240 V AC/DC	TEF3-OFF	1SBN021014R1000	1	0.065

Surge suppressors

For contactor relays	Rated control circuit voltage - U _c		Type	Order code	Pkg qty	Weight (1 pce)	
	V	AC					DC
NS, NSL	24...50	●	●	RV5/50	1SBN050010R1000	2	0.015
	50...133	●	●	RV5/133	1SBN050010R1001	2	0.015
	110...250	●	●	RV5/250	1SBN050010R1002	2	0.015
	250...440	●	●	RV5/440	1SBN050010R1003	2	0.015
NS	24...50	●	-	RC5-1/50	1SBN050100R1000	2	0.012
	50...133	●	-	RC5-1/133	1SBN050100R1001	2	0.012
	110...250	●	-	RC5-1/250	1SBN050100R1002	2	0.012
	250...440	●	-	RC5-1/440	1SBN050100R1003	2	0.012
NSL	12...32	-	●	RT5/32	1SBN050020R1000	2	0.015
	25...65	-	●	RT5/65	1SBN050020R1001	2	0.015
	50...90	-	●	RT5/90	1SBN050020R1002	2	0.015
	77...150	-	●	RT5/150	1SBN050020R1003	2	0.015
	150...264	-	●	RT5/264	1SBN050020R1004	2	0.015

Voltage code table

The below tables indicate the available coil voltages and corresponding digits for order codes. When placing an order, please give either type or order code. Select a standard contactor from ordering detail pages. Change the **coil voltage code** in the type or in the order code according to the table below. Example: for contactor AS09-30-10 and coil 42 V 50/60 Hz, type is AS09-30-10-21 and order code is 1SBL101001R2110.

3-pole contactors

Type

AS16 - 30 - 10 - 26

Auxiliary contacts
N.O. N.C.

Main contacts
N.O. N.C.

Contactor type
AS AC operated
ASL DC operated

Order code

1SBL121001R 26 10

AC coil code

	50 Hz	60 Hz
20	24 V	24 V
21	42 V	42 V
22	48 V	48 V
23	110 V	110 V
24	115 V	115 V
16	-	120 V
25	220 V	220 V
26	230 V	230 V
27	240 V	240 V
17	-	277 V
13	380 V	-
28	400 V	400 V
29	415 V	415 V

DC coil code

80	12 V
81	24 V
83	48 V
84	60 V
86	110 V
87	125 V
88	220 V
89	240 V

3-pole reversing contactors

Type

VAS12 S EM - 26 M

Surge suppressor

Contactor type
VAS AC operated
VASL DC operated

Order code

1SBK113800M 26 00

AC coil code

	50 Hz	60 Hz
20	24 V	24 V
21	42 V	42 V
22	48 V	48 V
23	110 V	110 V
24	115 V	115 V
16	-	120 V
25	220 V	220 V
26	230 V	230 V
27	240 V	240 V
17	-	277 V
13	380 V	-
28	400 V	400 V
29	415 V	415 V

DC coil code

80	12 V (1)
81	24 V
83	48 V
84	60 V
86	110 V
87	125 V
88	220 V
89	240 V

(1) Not for VASL..SEM

Contactor relays

Type

NS 40 E - 26

N.O. N.C.
Number contacts

Contactor type
NS AC operated
NSL DC operated

Order code

1SBH101001R 26 40

AC coil code

	50 Hz	60 Hz
20	24 V	24 V
21	42 V	42 V
22	48 V	48 V
23	110 V	110 V
24	115 V	115 V
16	-	120 V
25	220 V	220 V
26	230 V	230 V
27	240 V	240 V
17	-	277 V
13	380 V	-
28	400 V	400 V
29	415 V	415 V

DC coil code

80	12 V
81	24 V
83	48 V
84	60 V
86	110 V
87	125 V
88	220 V
89	240 V

Notes

A series of horizontal dotted lines for taking notes.



AF, EK contactors and NF contactor relays

Motor starting solution, in kit form

DOL and reversing starters protected by manual motor starters	5/2
DOL starters protected by moulded-case circuit-breakers	5/8
DOL and reversing starters protected by overload relays	5/14
Star-delta starters protected by overload relays	5/20

AF 3-pole contactors - Overview 5/26

4 to 45 kW / 5 to 60 hp

AF09 ... AF38	AC / DC operated	5/28
AF09Z ... AF38Z	AC / DC operated - low consumption	5/29
AF40 ... AF96	AC / DC operated	5/30
Main accessories		5/32

55 to 200 kW / 75 to 350 hp

AF116 ... AF146	AC / DC operated	5/34
AF190 ... AF370	AC / DC operated	5/36
Main accessories		5/38

200 to 560 kW / 350 to 900 hp

AF400 ... AF750	AC / DC operated	5/40
AF1250 ... AF2650	AC / DC operated	5/41
Main accessories		5/42

AF and EK 4-pole contactors - Overview 5/44

25 to 125 A AC-1

AF09 ... AF38	AC / DC operated	5/46
AF09Z ... AF38Z	AC / DC operated - low consumption	5/47
AF40 ... AF80	AC / DC operated	5/48
Main accessories		5/50

160 to 525 A AC-1

AF116 ... AF140	AC / DC operated	5/52
AF190 ... AF370	AC / DC operated	5/53
Main accessories		5/54

800 to 1000 A AC-1

EK550, EK1000	AC operated	5/56
EK550, EK1000	DC operated	5/57
Main accessories		5/58

NF contactor relays

NF	AC / DC operated	5/60
NFZ	AC / DC operated - low consumption	5/61
Main accessories		5/62

Voltage code table 5/64

For direct product details information, use product type or order code, ex:
www.abb.com/productdetails/AF09-30-10-13 or www.abb.com/productdetails/1SBL137001R1310

DOL and reversing starters protected by manual motor starters With AF contactors - open type version in kit form

5



1SFC101102X0001

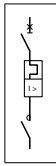

Application

Full voltage direct-on-line (DOL) starting and reversing starting for controlling three-phase asynchronous motors is a simple and economic solution characterised by a high starting torque (1.9 to 2.1 times full-speed torque) and a starting current 5.5 to 7 times nominal current.

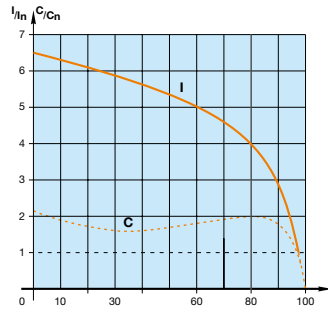

I = current
C = torque
In = nominal current
Cn = nominal torque

DOL starter

MS132-10 + BEA16-4 + AF09-30-10

Coordination types

The contactor and the manual motor starter control and protect motors against overload and short-circuits according to coordination types 1 and 2 (IEC 60947-4-1 / EN 60947-4-1) defining the anticipated level of service continuity as follow:

Type 1: In short-circuit conditions, the contactor or starter does not endanger persons or installations and will not be able to then operate without being repaired or having parts replaced.

Type 2: In short-circuit conditions, the contactor or starter does not endanger persons or installations and will be able to operate afterwards. The risk of contacts light welding is acceptable.



1SFC101105V0001

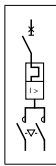

Main Technical Data

Standards	IEC 60947-4-1 / EN 60947-4-1	
Rated operational voltage Ue max.	690 V - 50/60 Hz	
Rated insulation voltage Ui		
acc. to IEC 60947-4-1	690 V	
acc. to UL / CSA	600 V	
Switching frequency		
	≤ 15 starts/hour - 80 % max. load factor - with max. 1.5 s starting time	
	≤ 30 starts/hour - 50 % max. load factor - with max. 1.5 s starting time	
Ambient air temperature		
Close to the device	use with MS116	≤ 55 °C
	use with MS132, MS165, MS495	≤ 60 °C
Degree of protection	IP20	

Reversing starter

MS132-10 + BEA16-4 + BER16-4 + VEM4 + AF09-30-10

Mounting positions

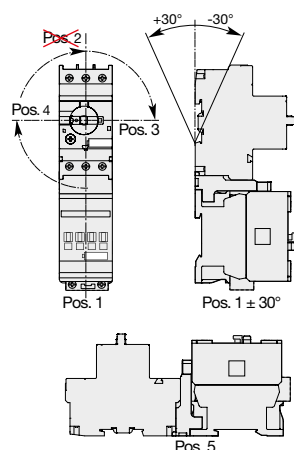

DOL starters

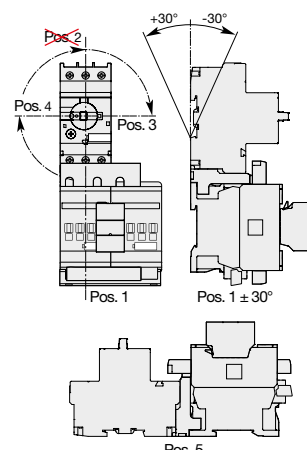

Reversing starters

DOL and reversing starters protected by manual motor starters With AF contactors - open type version in kit form

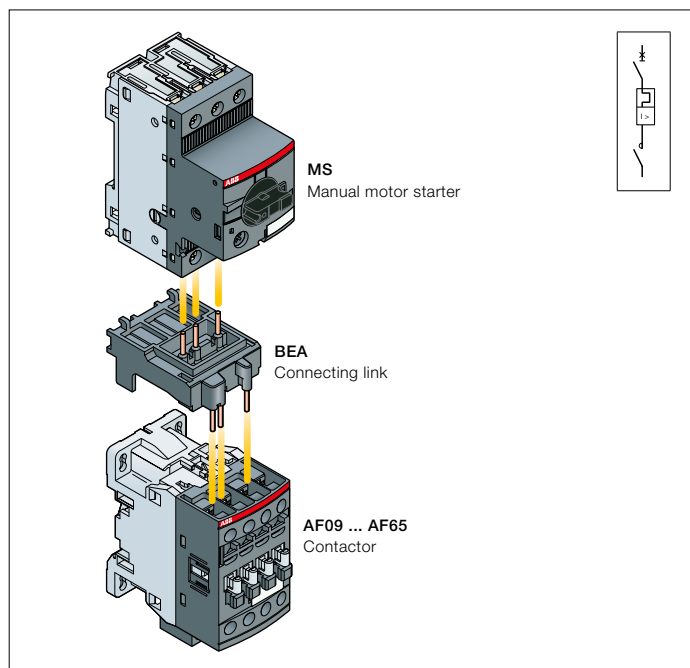

Direct-on-line starters

Description

You can easily assemble a direct-on-line starter by using the BEA...-4 connecting link 3-pole insulated. It is used to electrically and mechanically connect MS116, MS132 or MS165 manual motor starter and AF09 ... AF65 contactor, AC or DC operated.

5

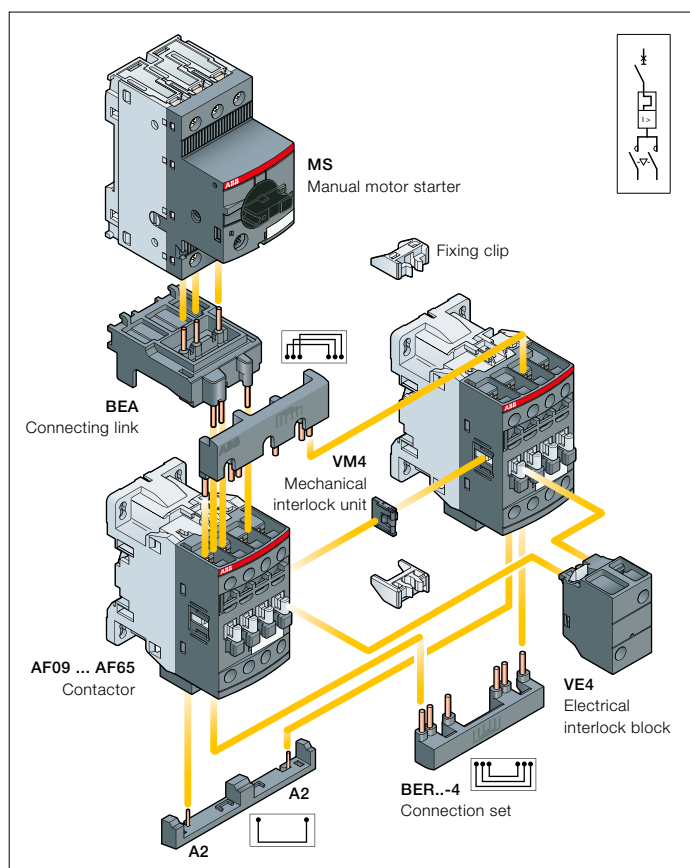

Reversing starters

Description

You can easily assemble reversing starter thanks to our complete range of accessories:

- BEA...-4 connecting link 3-pole insulated: it is used to electrically and mechanically connect MS116, MS132 or MS165 manual motor starter and AF09 ... AF65 contactor, AC or DC operated
- For AF09 ... AF38, use VEM4 mechanical and electrical interlock set for reversing starter in 90 mm width. It includes:
 - VM4 mechanical interlock unit including 2 fixing clips
 - VE4 electrical interlock block with A2-A2 connection.
- For AF40 ... AF96, use VM96-4 mechanical interlock unit and additional auxiliary contact blocks for electrical interlocking
- BER...-4 connection set: it assures a safe and simple reversing connection between both contactor main terminals.

Select now easily and quickly your starter in the following pages for coordination type 1 or 2 at 400 V, 50/60 Hz, I_q = 16 kA up to 18.5 kW and I_q = 50 kA up to 45 kW.

For the full coordination tables:

www.abb.com/lowvoltage then go to the right menu: "Support", select: "Online Product Selection Tools" then select "Coordination Tables for motor protection"

DOL starters protected by MS manual motor starters

Coordination type 1

Coordination type 1, AC-3, 16 kA or 50 kA, 400 V, 50/60 Hz

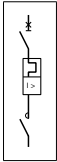
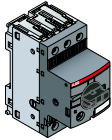
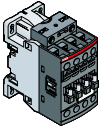
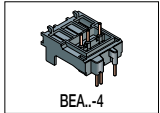
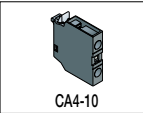
		Manual motor starters					Contactors					Accessories	
												 	
IEC AC-3, 400 V Rated operational power kW	Type (1)	Order code	Current setting range A	Magnetic tripping current A	Rated control circuit voltage Uc min. ... Uc max. (2)	Type (3)	Order code	Allowed setting current A	Type	Order code			
0.06	0.2	MS132-0.25	1SAM350000R1002	0.16...0.25	2.44	24...60	20...60	AF09Z-30-10-21	1SBL136001R2110	0.25	BEA16-4	1SBN081306T1000	
0.09	0.3	MS132-0.4	1SAM350000R1003	0.25...0.40	3.9	24...60	20...60	AF09Z-30-10-21	1SBL136001R2110	0.4			
0.12	0.44	MS132-0.63	1SAM350000R1004	0.40...0.63	6.14	24...60	20...60	AF09Z-30-10-21	1SBL136001R2110	0.63			
0.18	0.6	MS132-0.63	1SAM350000R1004	0.40...0.63	6.14	24...60	20...60	AF09Z-30-10-21	1SBL136001R2110	0.63			
0.25	0.85	MS132-1.0	1SAM350000R1005	0.63...1.00	11.5	24...60	20...60	AF09Z-30-10-21	1SBL136001R2110	1			
0.37	1.1	MS132-1.6	1SAM350000R1006	1.00...1.60	18.4	24...60	20...60	AF09Z-30-10-21	1SBL136001R2110	1.6			
0.55	1.5	MS132-1.6	1SAM350000R1006	1.00...1.60	18.4	24...60	20...60	AF09Z-30-10-21	1SBL136001R2110	1.6			
0.75	1.9	MS132-2.5	1SAM350000R1007	1.60...2.50	28.75	24...60	20...60	AF09Z-30-10-21	1SBL136001R2110	2.5			
1.1	2.7	MS132-4.0	1SAM350000R1008	2.50...4.00	50	24...60	20...60	AF09Z-30-10-21	1SBL136001R2110	4			
1.5	3.6	MS132-4.0	1SAM350000R1008	2.50...4.00	50	24...60	20...60	AF09Z-30-10-21	1SBL136001R2110	4			
2.2	4.9	MS132-6.3	1SAM350000R1009	4.00...6.30	78.75	24...60	20...60	AF09Z-30-10-21	1SBL136001R2110	6.3			
3	6.5	MS132-10	1SAM350000R1010	6.30...10.0	150	24...60	20...60	AF09Z-30-10-21	1SBL136001R2110	9			
4	8.5	MS132-10	1SAM350000R1010	6.30...10.0	150	24...60	20...60	AF09Z-30-10-21	1SBL136001R2110	9			
5.5	11.5	MS132-12	1SAM350000R1012	8.00...12.0	180	24...60	20...60	AF12Z-30-10-21	1SBL156001R2110	12			
7.5	15.5	MS132-16	1SAM350000R1011	10.0...16.0	240	24...60	20...60	AF16Z-30-10-21	1SBL176001R2110	16			
11	22	MS132-25	1SAM350000R1014	20.0...25.0	375	24...60	20...60	AF26Z-30-00-21	1SBL236001R2100	25	+	BEA38-4 CA4-10	1SBN082306T2000 1SBN010110R1010
15	29	MS132-32	1SAM350000R1015	25.0...32.0	480	24...60	20...60	AF30Z-30-00-21	1SBL276001R2100	32			
18.5	35	MS165-42	1SAM451000R1015	30.0...42.0	630	24...60	20...60	AF40-30-00-11	1SBL347001R1100	40			
22	41	MS165-54	1SAM451000R1016	40.0...54.0	810	24...60	20...60	AF52-30-00-11	1SBL367001R1100	53	+	BEA65-4 CA4-10	1SBN083406R1000 1SBN010110R1010
30	55	MS165-65	1SAM451000R1017	52.0...65.0	975	24...60	20...60	AF65-30-00-11	1SBL387001R1100	65			
37	66	MS495-75	1SAM550000R1008	57.0...75.0	975	24...60	20...60	AF80-30-00-11	1SBL397001R1100	75			
45	80	MS495-90	1SAM550000R1009	70.0...90.0	1170	24...60	20...60	AF96-30-00-11	1SBL407001R1100	90			

(1) MS116 manual motor starter can be selected according to the current setting range indicated on the coordination line, up to:

- 15 kW, 400 V - AC-3 at 16 kA
- 4 kW, 400 V - AC-3 at 50 kA.



(2) For other control voltages, see "Voltage code table".

(3) AF38 3-pole contactor can be selected for coordination type 1, 16 kA and 50 kA, 18.5 kW, 400 V - AC-3 (BEA65-4 available for AF40 ... AF65 only).

DOL starters protected by MS manual motor starters

Coordination type 2

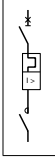
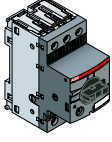
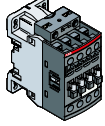
Coordination type 2, AC-3, 16 kA or 50 kA, 400 V, 50/60 Hz

		Manual motor starters					Contactors					Accessories	
												 BEA-4  CA4-10	
IEC AC-3, 400 V Rated operational power kW	Type (1)	Order code	Current setting range A	Magnetic tripping current A	Rated control circuit voltage Uc min. ... Uc max. (2)	Type (3)	Order code	Allowed setting current A	Type (4)	Order code			
					V 50/60 Hz V DC								
0.06	0.2	MS132-0.25 1SAM350000R1002	0.16...0.25	2.44	24...60 20...60	AF09Z-30-10-21	1SBL136001R2110	0.25		BEA16-4	1SBN081306T1000		
0.09	0.3	MS132-0.4 1SAM350000R1003	0.25...0.40	3.9	24...60 20...60	AF09Z-30-10-21	1SBL136001R2110	0.4					
0.12	0.44	MS132-0.63 1SAM350000R1004	0.40...0.63	6.14	24...60 20...60	AF09Z-30-10-21	1SBL136001R2110	0.63					
0.18	0.6	MS132-0.63 1SAM350000R1004	0.40...0.63	6.14	24...60 20...60	AF09Z-30-10-21	1SBL136001R2110	0.63					
0.25	0.85	MS132-1.0 1SAM350000R1005	0.63...1.00	11.5	24...60 20...60	AF09Z-30-10-21	1SBL136001R2110	1					
0.37	1.1	MS132-1.6 1SAM350000R1006	1.00...1.60	18.4	24...60 20...60	AF09Z-30-10-21	1SBL136001R2110	1.6					
0.55	1.5	MS132-1.6 1SAM350000R1006	1.00...1.60	18.4	24...60 20...60	AF09Z-30-10-21	1SBL136001R2110	1.6					
0.75	1.9	MS132-2.5 1SAM350000R1007	1.60...2.50	28.75	24...60 20...60	AF09Z-30-10-21	1SBL136001R2110	2.5					
1.1	2.7	MS132-4.0 1SAM350000R1008	2.50...4.00	50	24...60 20...60	AF26Z-30-00-21	1SBL236001R2100	4					
1.5	3.6	MS132-4.0 1SAM350000R1008	2.50...4.00	50	24...60 20...60	AF26Z-30-00-21	1SBL236001R2100	4	+	BEA26-4 CA4-10	1SBN082306T1000 1SBN010110R1010		
2.2	4.9	MS132-6.3 1SAM350000R1009	4.00...6.30	78.75	24...60 20...60	AF26Z-30-00-21	1SBL236001R2100	6.3					
3	6.5	MS132-10 1SAM350000R1010	6.30...10.0	150	24...60 20...60	AF26Z-30-00-21	1SBL236001R2100	10					
4	8.5	MS132-10 1SAM350000R1010	6.30...10.0	150	24...60 20...60	AF26Z-30-00-21	1SBL236001R2100	10					
5.5	11.5	MS132-12 1SAM350000R1012	8.00...12.0	180	24...60 20...60	AF26Z-30-00-21	1SBL236001R2100	12					
7.5	15.5	MS132-16 1SAM350000R1011	10.0...16.0	240	24...60 20...60	AF30Z-30-00-21	1SBL276001R2100	16	+	BEA38-4 CA4-10	1SBN082306T2000 1SBN010110R1010		
11	22	MS132-25 1SAM350000R1014	20.0...25.0	375	24...60 20...60	AF30Z-30-00-21	1SBL276001R2100	25					
15	29	MS132-32 1SAM350000R1015	25.0...32.0	480	24...60 20...60	AF30Z-30-00-21	1SBL276001R2100	32					
18.5	35	MS165-42 1SAM451000R1015	30.0...42.0	630	24...60 20...60	AF40-30-00-11	1SBL347001R1100	40		BEA65-4 CA4-10	1SBN083406R1000 1SBN010110R1010		
22	41	MS165-54 1SAM451000R1016	40.0...54.0	810	24...60 20...60	AF52-30-00-11	1SBL367001R1100	53					
30	55	MS165-65 1SAM451000R1017	52.0...65.0	975	24...60 20...60	AF65-30-00-11	1SBL387001R1100	65					
37	66	MS495-75 1SAM550000R1008	57.0...75.0	975	24...60 20...60	AF80-30-00-11	1SBL397001R1100	75					
45	80	MS495-90 1SAM550000R1009	70.0...90.0	1170	24...60 20...60	AF96-30-00-11	1SBL407001R1100	90					

(1) MS116 manual motor starter can be selected according to the current setting range indicated on the coordination line, up to
 - 15 kW 400V - AC-3 at 16 kA
 - 4 kW, 400 V - AC-3 at 50 kA.

(2) For other control voltages, see "Voltage code table".

(3) AF26 3-pole contactor can be selected for coordination type 2, 16 kA, 7.5 kW, 400 V - AC-3.

AF38 3-pole contactor can be selected for coordination type 2, 16 kA and 50 kA, 18.5 kW, 400 V - AC-3 (BEA65-4 available for AF40 ... AF65 only).

(4) BEA26-4 should be selected with MS116-12 ... MS116-16 and AF26 ... AF38.

BEA38-4 can only be selected with MS116-20 ... MS116-32.

Reversing starters protected by MS manual motor starters

Coordination type 1

Coordination type 1, AC-3, 16 kA or 50 kA, 400 V, 50/60 Hz

		Manual motor starters					Contactors					Accessories		
IEC	Type	Order code	Current setting range	Magnetic tripping current	Rated control circuit voltage	Type	Order code	Allowed setting current	Type	Order code				
AC-3, 400 V	(1)		A	A	Uc min. ... Uc max.	(3)		A						
Rated operational power					V 50/60 Hz : V DC									
kW	A													
0.06	0.2	MS132-0.25	1SAM350000R1002	0.16...0.25	2.44	24...60	20...60	AF09Z-30-10-21	1SBL136001R2110	0.25				
0.09	0.3	MS132-0.4	1SAM350000R1003	0.25...0.40	3.9	24...60	20...60	AF09Z-30-10-21	1SBL136001R2110	0.4	BEA16-4	1SBN081306T1000		
0.12	0.44	MS132-0.63	1SAM350000R1004	0.40...0.63	6.14	100...250	100...250	AF09-30-10-13	1SBL137001R1310		BER16-4	1SBN081311R1000		
0.18	0.6	MS132-0.63	1SAM350000R1004	0.40...0.63	6.14	100...250	100...250	AF09-30-10-13	1SBL137001R1310		VEM4	1SBN030111R1000		
0.25	0.85	MS132-1.0	1SAM350000R1005	0.63...1.00	11.5	24...60	20...60	AF09Z-30-10-21	1SBL136001R2110	1				
0.37	1.1	MS132-1.6	1SAM350000R1006	1.00...1.60	18.4	100...250	100...250	AF09-30-10-13	1SBL137001R1310	1.6				
0.55	1.5	MS132-1.6	1SAM350000R1006	1.00...1.60	18.4	24...60	20...60	AF09Z-30-10-21	1SBL136001R2110	1.6				
0.75	1.9	MS132-2.5	1SAM350000R1007	1.60...2.50	28.75	100...250	100...250	AF09-30-10-13	1SBL137001R1310	2.5				
1.1	2.7	MS132-4.0	1SAM350000R1008	2.50...4.00	50	24...60	20...60	AF09Z-30-10-21	1SBL136001R2110	4				
1.5	3.6	MS132-4.0	1SAM350000R1008	2.50...4.00	50	100...250	100...250	AF09-30-10-13	1SBL137001R1310	4				
2.2	4.9	MS132-6.3	1SAM350000R1009	4.00...6.30	78.75	24...60	20...60	AF09Z-30-10-21	1SBL136001R2110	6.3				
3	6.5	MS132-10	1SAM350000R1010	6.30...10.0	150	100...250	100...250	AF09-30-10-13	1SBL137001R1310	9				
4	8.5	MS132-10	1SAM350000R1010	6.30...10.0	150	24...60	20...60	AF09Z-30-10-21	1SBL136001R2110	9				
5.5	11.5	MS132-12	1SAM350000R1012	8.00...12.0	180	100...250	100...250	AF09-30-10-13	1SBL137001R1310	12				
7.5	15.5	MS132-16	1SAM350000R1011	10.0...16.0	240	24...60	20...60	AF12Z-30-10-21	1SBL156001R2110	16				
11	22	MS132-25	1SAM350000R1014	20.0...25.0	375	100...250	100...250	AF16Z-30-10-13	1SBL177001R1310	25				
15	29	MS132-32	1SAM350000R1015	25.0...32.0	480	24...60	20...60	AF26Z-30-00-21	1SBL236001R2100	32	BEA38-4	1SBN082306T2000		
18.5	35	MS165-42	1SAM451000R1015	30.0...42.0	630	100...250	100...250	AF26-30-00-13	1SBL237001R1300		BER38-4	1SBN082311R1000		
22	41	MS165-54	1SAM451000R1016	40.0...54.0	810	100...250	100...250	AF30Z-30-00-21	1SBL276001R2100		VEM4	1SBN030111R1000		
30	55	MS165-65	1SAM451000R1017	52.0...65.0	975	100...250	100...250	AF30-30-00-13	1SBL277001R1300		CA4-10	1SBN010110R1010		
37	66	MS495-75	1SAM550000R1008	57.0...75.0	975	24...60	20...60	AF40-30-00-11	1SBL347001R1100	40	BEA65-4	1SBN083406R1000		
45	80	MS495-90	1SAM550000R1009	70.0...90.0	1170	100...250	100...250	AF40-30-00-13	1SBL347001R1300	53	BER65-4	1SBN083411R1000		
						24...60	20...60	AF52-30-00-11	1SBL367001R1100	65	VM96-4	1SBN033405T1000		
						100...250	100...250	AF52-30-00-13	1SBL367001R1300		CA4-10	1SBN010110R1010		
						24...60	20...60	AF65-30-00-11	1SBL387001R1100		CA4-01	1SBN010110R1001		
						100...250	100...250	AF65-30-00-13	1SBL387001R1300	75				
						24...60	20...60	AF80-30-00-11	1SBL397001R1100	90	BER96-4	1SBN083911R1000		
						100...250	100...250	AF80-30-00-13	1SBL397001R1300		VM96-4	1SBN033405T1000		
						24...60	20...60	AF96-30-00-11	1SBL407001R1100		CA4-10	1SBN010110R1010		
						100...250	100...250	AF96-30-00-13	1SBL407001R1300		CA4-01	1SBN010110R1001		

(1) MS116 manual motor starter can be selected according to the current setting range indicated on the coordination line, up to:
 - 15 kW, 400 V - AC-3 at 16 kA
 - 4 kW, 400 V - AC-3 at 50 kA.

(2) For other control voltages, see "Voltage code table".

(3) AF38 3-pole contactor can be selected for coordination type 1, 16 kA and 50 kA, 18.5 kW, 400 V - AC-3 (BEA65-4 available for AF40 ... AF65 only).

Reversing starters protected by MS manual motor starters

Coordination type 2

Coordination type 2, AC-3, 16 kA or 50 kA, 400 V, 50/60 Hz

		Manual motor starters					Contactors					Accessories			
IEC	Type	Order code	Current setting range	Magnetic tripping current	Rated control circuit voltage	Type	Order code	Allowed setting current	Type	Order code					
AC-3, 400 V	(1)		A	A	Uc min. ... Uc max.	(3)		A	(4)						
Rated operational power					(2)										
kW	A				V 50/60 Hz V DC										
0.06	0.2	MS132-0.25 1SAM350000R1002	0.16...0.25	2.44	24...60 20...60	AF09Z-30-10-21	1SBL136001R2110	0.25							
0.09	0.3	MS132-0.4 1SAM350000R1003	0.25...0.40	3.9	24...60 20...60	AF09Z-30-10-21	1SBL136001R2110	0.4							
0.12	0.44	MS132-0.63 1SAM350000R1004	0.40...0.63	6.14	24...60 20...60	AF09Z-30-10-21	1SBL136001R2110	0.63							
0.18	0.6	MS132-0.63 1SAM350000R1004	0.40...0.63	6.14	24...60 20...60	AF09Z-30-10-21	1SBL136001R2110	0.63							
0.25	0.85	MS132-1.0 1SAM350000R1005	0.63...1.00	11.5	24...60 20...60	AF09Z-30-10-21	1SBL136001R2110	1							
0.37	1.1	MS132-1.6 1SAM350000R1006	1.00...1.60	18.4	24...60 20...60	AF09Z-30-10-21	1SBL136001R2110	1.6							
0.55	1.5	MS132-1.6 1SAM350000R1006	1.00...1.60	18.4	24...60 20...60	AF09Z-30-10-21	1SBL136001R2110	1.6							
0.75	1.9	MS132-2.5 1SAM350000R1007	1.60...2.50	28.75	24...60 20...60	AF09Z-30-10-21	1SBL136001R2110	2.5							
1.1	2.7	MS132-4.0 1SAM350000R1008	2.50...4.00	50	24...60 20...60	AF26Z-30-00-21	1SBL236001R2100	4							
1.5	3.6	MS132-4.0 1SAM350000R1008	2.50...4.00	50	24...60 20...60	AF26Z-30-00-21	1SBL236001R2100	4							
2.2	4.9	MS132-6.3 1SAM350000R1009	4.00...6.30	78.75	24...60 20...60	AF26Z-30-00-21	1SBL236001R2100	6.3							
3	6.5	MS132-10 1SAM350000R1010	6.30...10.0	150	24...60 20...60	AF26Z-30-00-21	1SBL236001R2100	10							
4	8.5	MS132-10 1SAM350000R1010	6.30...10.0	150	24...60 20...60	AF26Z-30-00-21	1SBL236001R2100	10							
5.5	11.5	MS132-12 1SAM350000R1012	8.00...12.0	180	24...60 20...60	AF26Z-30-00-21	1SBL236001R2100	12							
7.5	15.5	MS132-16 1SAM350000R1011	10.0...16.0	240	24...60 20...60	AF30Z-30-00-21	1SBL276001R2100	16							
11	22	MS132-25 1SAM350000R1014	20.0...25.0	375	24...60 20...60	AF30Z-30-00-21	1SBL276001R2100	25							
15	29	MS132-32 1SAM350000R1015	25.0...32.0	480	24...60 20...60	AF30Z-30-00-21	1SBL276001R2100	32							
18.5	35	MS165-42 1SAM451000R1015	30.0...42.0	630	24...60 20...60	AF40-30-00-11	1SBL347001R1100	40							
22	41	MS165-54 1SAM451000R1016	40.0...54.0	810	24...60 20...60	AF52-30-00-11	1SBL367001R1100	53							
30	55	MS165-65 1SAM451000R1017	52.0...65.0	975	24...60 20...60	AF65-30-00-11	1SBL387001R1100	65							
37	66	MS495-75 1SAM550000R1008	57.0...75.0	975	24...60 20...60	AF80-30-00-11	1SBL397001R1100	75							
45	80	MS495-90 1SAM550000R1009	70.0...90.0	1170	24...60 20...60	AF96-30-00-11	1SBL407001R1100	90							

- MS116 manual motor starter can be selected according to the current setting range indicated on the coordination line, up to - 15 kW 400V - AC-3 at 16 kA - 4 kW, 400 V - AC-3 at 50 kA.
- For other control voltages, see "Voltage code table".
- AF26 3-pole contactor can be selected for coordination type 2, 16 kA, 7.5 kW, 400 V - AC-3. AF38 3-pole contactor can be selected for coordination type 2, 16 kA and 50 kA, 18.5 kW, 400 V - AC-3 (BEA65-4 available for AF40 ... AF65 only).
- BEA26-4 should be selected with MS116-12 ... MS116-16 and AF26 ... AF38. BEA38-4 can only be selected with MS116-20 ... MS116-32.

DOL starters protected by moulded-case circuit-breakers and overload relays

With AF contactors - Open type version in kit form

5



XT2S 160 + BEA140/XT2 + AF140-30-11

Application

Full voltage direct-on-line (DOL) starting for controlling three-phase asynchronous motors is a simple and economic solution characterised by a high starting torque (1.9 to 2.1 times full-speed torque) and a starting current 5.5 to 7 times nominal current.

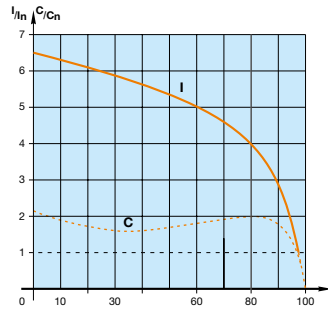

I = current
C = torque
In = nominal current
Cn = nominal torque

Coordination types

The contactor and the moulded-case circuit-breaker control and protect motors against overload and short-circuits according to coordination types 1 and 2 (IEC 60947-4-1/EN 60947-4-1) defining the anticipated level of service continuity as follows:

Type 1: In short-circuit conditions, the contactor or starter does not endanger persons or installations and will not be able to then operate without being repaired or having parts replaced.

Type 2: In short-circuit conditions, the contactor or starter does not endanger persons or installations and will be able to operate afterwards. The risk of contacts light welding is acceptable.

Main Technical Data

Standards	IEC 60947-4-1 / EN 60947-4-1
Rated operational voltage Ue max.	400 V - 50/60 Hz
Rated insulation voltage Ui	
acc. to IEC 60947-4-1	690 V
acc. to UL / CSA	600 V
Switching frequency	≤ 15 starts/hour - 80 % max. load factor - with max. 1.5 s starting time ≤ 30 starts/hour - 50 % max. load factor - with max. 1.5 s starting time
Ambient air temperature	
Close to the device	< 55 °C
Degree of protection	IP20



XT2S 160 + BEA140/XT2 + AF140-30-11 + EF146

Mounting positions

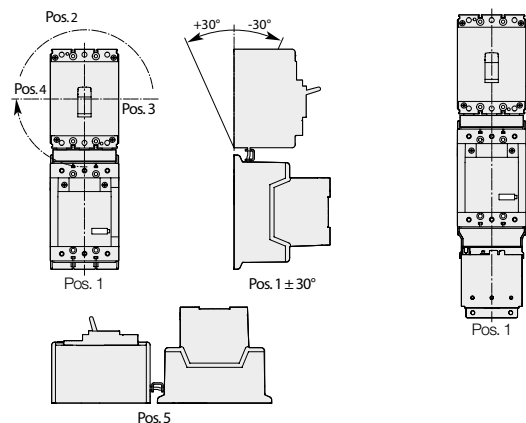

Direct-on-line
MCCB + AF

Direct-on-line
MCCB + AF + OL

DOL starters protected by moulded-case circuit-breakers and overload relays

With AF contactors - Open type version in kit form

Description

You can easily assemble a direct-on-line starter by using the BEA connection bars. It is used to electrically connect MCCB moulded-case circuit-breaker and AF116 ... AF370 contactor, AC or DC operated.

Select now easily and quickly your starter in the following pages for coordination type 1 or 2 at 400 V, 50/60 Hz, I_q = 50 kA up to 200 kW.

For the full coordination tables:
www.abb.com/lowvoltage then go to the right menu: "Support", select: "Online Product Selection Tools" then select "Coordination Tables for motor protection"

5

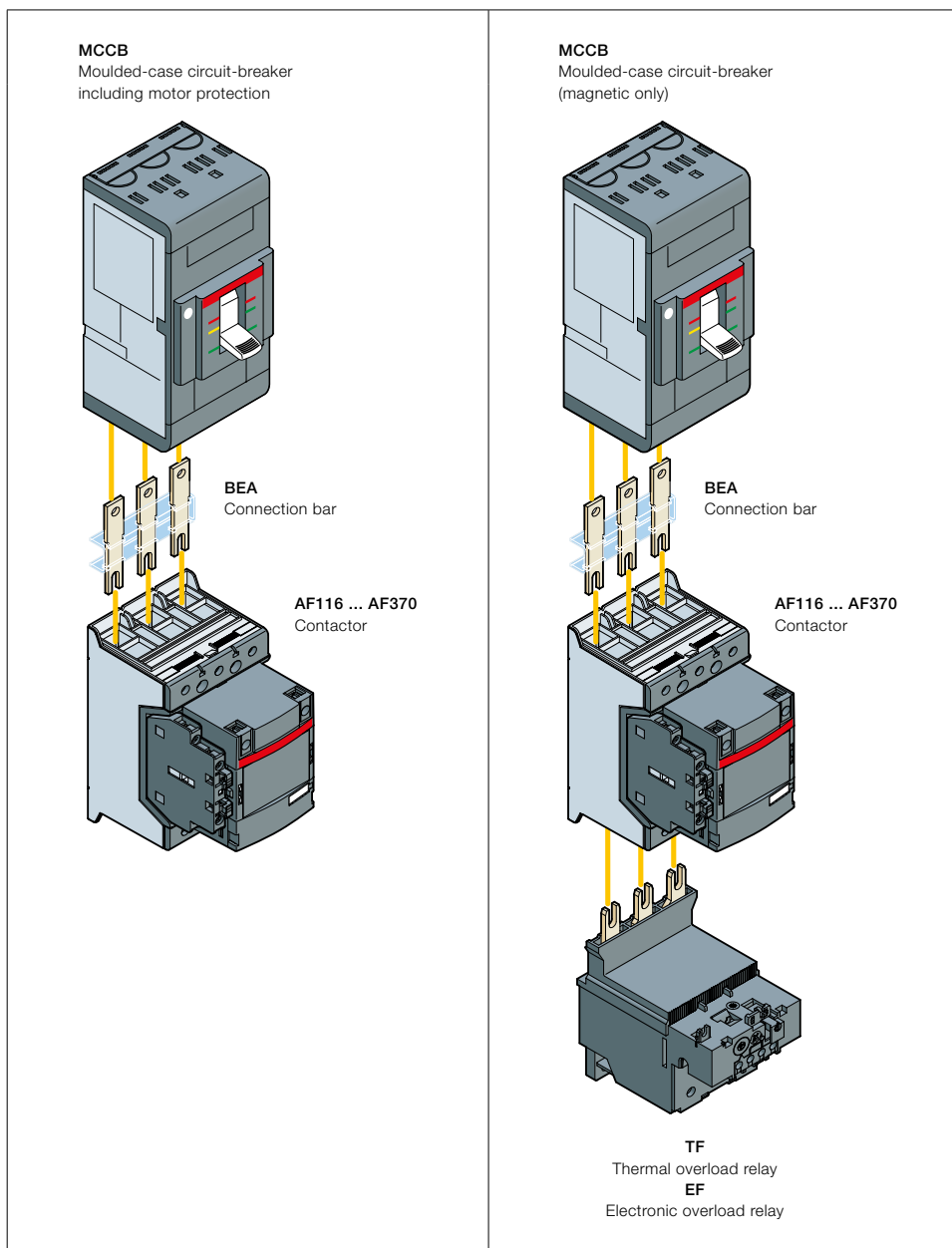

DOL starters protected by MCCB including motor protection Coordination type 1 or 2

Coordination type 1 or 2, AC-3, 50 kA, 400 V, 50/60 Hz

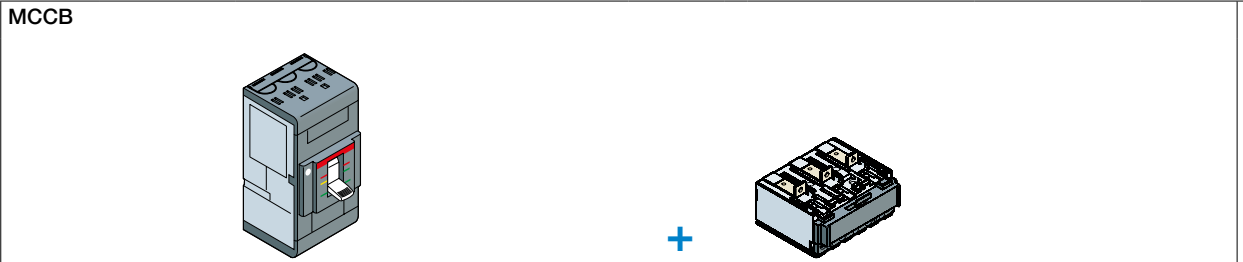

IEC AC-3, 400 V Rated power kW		Rated current A	Magnetic tripping current setting A	Max. allowed thermal setting	Base Type	Order code		Trip unit Type	Order code
55	97	1440	116	116	XT2S 160	1SDA068164R1		+ Ekip M-LIU In160	1SDA067355R1
75	132	1920	140	140	XT2S 160	1SDA068164R1		+ Ekip M-LIU In160	1SDA067355R1
90	160	2400	190	190	T4S 250 PR222MP In200	1SDA054527R1		Included	-
110	195	2880	205	205	T5S 400 PR222MP In320	1SDA054553R1		Included	-
132	230	3600	265	265	T5S 400 PR222MP In400	1SDA054554R1		Included	-
160	280	4400	305	305	T5S 400 PR222MP In400	1SDA054554R1		Included	-

5

Contactors

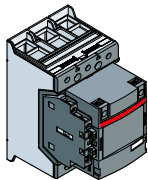

Connection bars



Control voltage
Uc min. ... Uc max.

Type

Order code

Type

Order code

V 50/60 Hz

V DC

V 50/60 Hz	V DC	Type	Order code	Type	Order code
24...60	20...60	AF116-30-11-11	1SFL427001R1111	BEA140/XT2	1SFN084206R1000
100...250	100...250	AF116-30-11-13	1SFL427001R1311		
24...60	20...60	AF140-30-11-11	1SFL447001R1111	BEA205/T4	1SFN084806R1001
100...250	100...250	AF140-30-11-13	1SFL447001R1311		
24...60	20...60	AF190-30-11-11	1SFL487002R1111	BEA205/T4	1SFN084806R1001
100...250	100...250	AF190-30-11-13	1SFL487002R1311		
24...60	20...60	AF205-30-11-11	1SFL527002R1111	BEA370/T5	1SFN085406R1000
100...250	100...250	AF205-30-11-13	1SFL527002R1311		
24...60	20...60	AF265-30-11-11	1SFL547002R1111	BEA370/T5	1SFN085406R1000
100...250	100...250	AF265-30-11-13	1SFL547002R1311		
24...60	20...60	AF305-30-11-11	1SFL587002R1111	BEA370/T5	1SFN085406R1000
100...250	100...250	AF305-30-11-13	1SFL587002R1311		

DOL starters protected by MCCB (magnetic only) and overload relays

Coordination type 1 or 2

Coordination type 1 or 2, AC-3, 50 kA, 400 V, 50/60 Hz

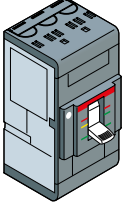
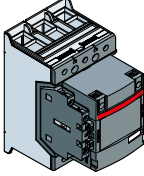
MCCB 	Contactors 
--	--

Thermal overload relays

IEC AC-3, 400 V Rated power kW	Rated current A	Magnetic tripping current A	Type	Order code	Control voltage Uc min. ... Uc max.		Type	Order code
					V 50/60 Hz	V DC		
55	97	1600	XT2S 160 MA 160	1SDA076530R1	24...60	20...60	AF116-30-11-11	1SFL427001R1111
					100...250	100...250	AF116-30-11-13	1SFL427001R1311
75	132	1920	XT2S 160 MA 160	1SDA076530R1	24...60	20...60	AF140-30-11-11	1SFL447001R1111
					100...250	100...250	AF140-30-11-13	1SFL447001R1311
90	160	2250	XT4S 250 Ekip I In250	1SDA068480R1	24...60	20...60	AF190-30-11-11	1SFL487002R1111
					100...250	100...250	AF190-30-11-13	1SFL487002R1311
110	195	2720	T4S 320 PR221-I In320	1SDA054126R1	24...60	20...60	AF205-30-11-11	1SFL527002R1111
					100...250	100...250	AF205-30-11-13	1SFL527002R1311

Electronic overload relays

55	97	1600	XT2S 160 MA 160	1SDA076530R1	24...60	20...60	AF116-30-11-11	1SFL427001R1111
					100...250	100...250	AF116-30-11-13	1SFL427001R1311
75	132	1920	XT2S 160 MA 160	1SDA076530R1	24...60	20...60	AF140-30-11-11	1SFL447001R1111
					100...250	100...250	AF140-30-11-13	1SFL447001R1311
90	160	2250	XT4S 250 Ekip I In250	1SDA068480R1	24...60	20...60	AF190-30-11-11	1SFL487002R1111
					100...250	100...250	AF190-30-11-13	1SFL487002R1311
110	195	2720	T4S 320 PR221-I In320	1SDA054126R1	24...60	20...60	AF205-30-11-11	1SFL527002R1111
					100...250	100...250	AF205-30-11-13	1SFL527002R1311
132	230	3200	T5S 400 PR221-I In400	1SDA054335R1	24...60	20...60	AF265-30-11-11	1SFL547002R1111
					100...250	100...250	AF265-30-11-13	1SFL547002R1311
160	280	4000	T5S 400 PR221-I In400	1SDA054335R1	24...60	20...60	AF305-30-11-11	1SFL587002R1111
					100...250	100...250	AF305-30-11-13	1SFL587002R1311
200	350	5040	T5S 630 PR221-I In630	1SDA054405R1	24...60	20...60	AF370-30-11-11	1SFL607002R1111
					100...250	100...250	AF370-30-11-13	1SFL607002R1311

Overload relays

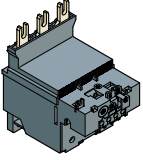

Connection bars

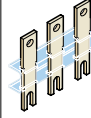

Setting ranges	Max. allowed setting current	Type	Order code	Type	Order code
A	A				
80...110	110	TF140DU-110	1SAZ431201R1002	BEA140/XT2	1SFN084206R1000
110...142	140	TF140DU-142	1SAZ431201R1004		
130...175	175	TA200DU-175	1SAZ421201R1005	BEA205/XT4	1SFN084806R1000
155...200	200	TA200DU-200	1SAZ421201R1006	BEA205/T4	1SFN084806R1001
54...150	116	EF146-150	1SAX351001R1101	BEA140/XT2	1SFN084206R1000
54...150	140	EF146-150	1SAX351001R1101		
63...210	190	EF205-210	1SAX531001R1101	BEA205/XT4	1SFN084806R1000
63...210	205	EF205-210	1SAX531001R1101	BEA205/T4	1SFN084806R1001
115...380	265	EF370-380	1SAX611001R1101	BEA370/T5	1SFN085406R1000
115...380	305	EF370-380	1SAX611001R1101		
115...380	350	EF370-380	1SAX611001R1101		

DOL and reversing starters protected by overload relays With AF contactors - Open type version in kit form

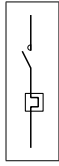

Application

Full voltage direct-on-line and reversing starting for controlling three-phase asynchronous motors is a simple and economic solution characterised by a high starting torque (1.9 to 2.1 times full-speed torque) and a starting current 5.5 to 7 times nominal current.

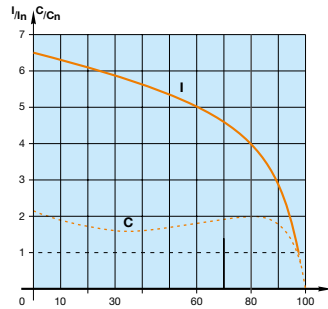

I = current
C = torque
In = nominal current
Cn = nominal torque

5

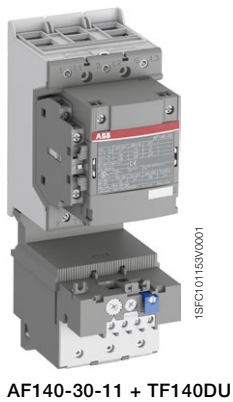

Coordination Types

The contactor, the short-circuit protection device and the thermal overload relay control and protect motors against overload and short-circuits according to coordination types 1 and 2 (IEC 60947-4-1 / EN 60947-4-1) defining the anticipated level of service continuity as follow:

Type 1: In short-circuit conditions, the contactor or starter does not endanger persons or installations and will not be able to then operate without being repaired or having parts replaced.

Type 2: In short-circuit conditions, the contactor or starter does not endanger persons or installations and will be able to operate afterwards. The risk of contacts light welding is acceptable.

Main Technical Data

Standards	IEC 60947-4-1 / EN 60947-4-1
Rated operational voltage Ue max.	690 V - 50/60 Hz
Rated insulation voltage Ui	
acc. to IEC 60947-4-1	690 V
acc. to UL / CSA	600 V
Ambient air temperature	
Close to the device	≤ 60 °C (TF42: 38 A above ≤ 50 °C)
Degree of protection	IP20
Switching frequency	Refer to "Switching frequency diagrams" page

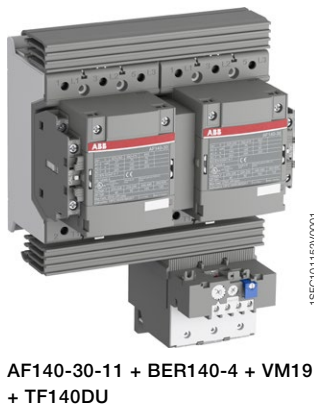
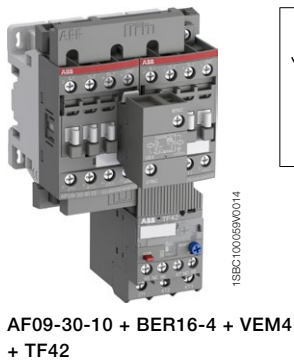

Mounting positions



Direct-on-line

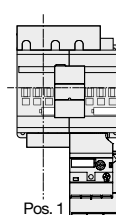

Reversing

DOL and reversing starters protected by overload relays

With AF contactors - Open type version in kit form

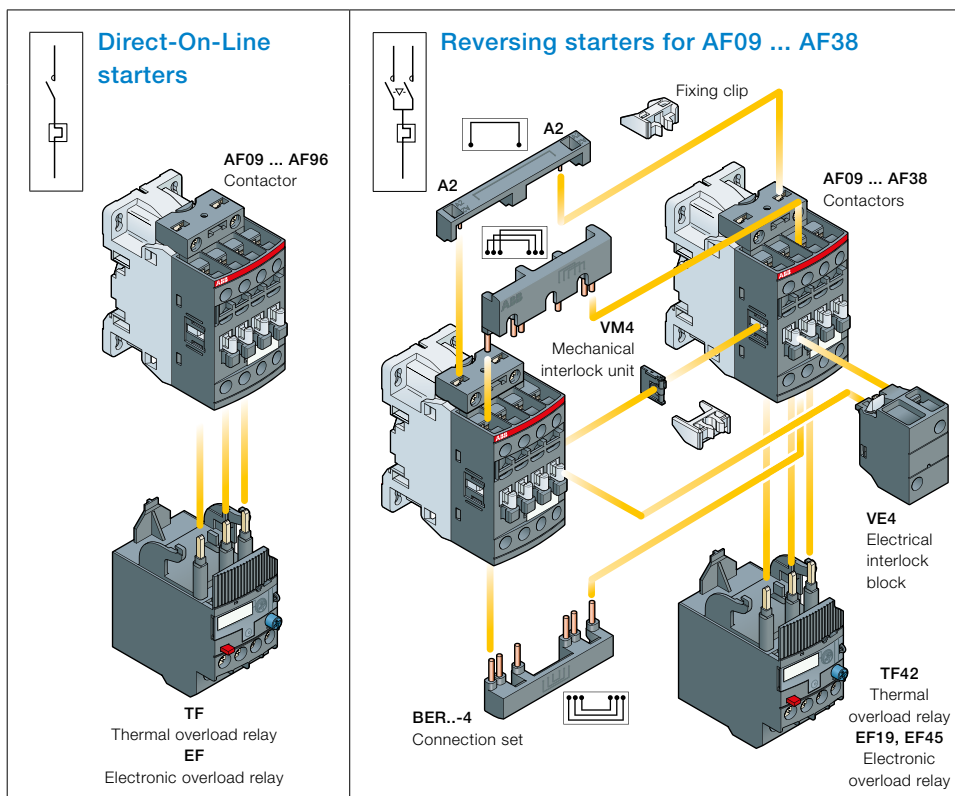

Description

You can easily assemble a direct-on-line starter by connecting AF contactor and TF thermal overload relay or EF electronic overload relay.

You can also easily assemble reversing starter thanks to our complete range of accessories:

- For AF09 ... AF38, use VEM4 mechanical and electrical interlock set for reversing starter in 90 mm width. It includes:
 - VM4 mechanical interlock unit including 2 fixing clips
 - VE4 electrical interlock block with A2-A2 connection.
- For AF40 ... AF370, use VM mechanical interlock unit and additional auxiliary contact blocks for electrical interlocking.
- BER...-4 connection set: it assures a safe and simple reversing connection between both contactor main terminals.

Select now easily and quickly your starter in the following pages at 400 V, up to 200 kW.

For the full coordination tables: www.abb.com/lowvoltage then go to the right menu: "Support", select: "Online Product Selection Tools" then select "Coordination Tables for motor protection"

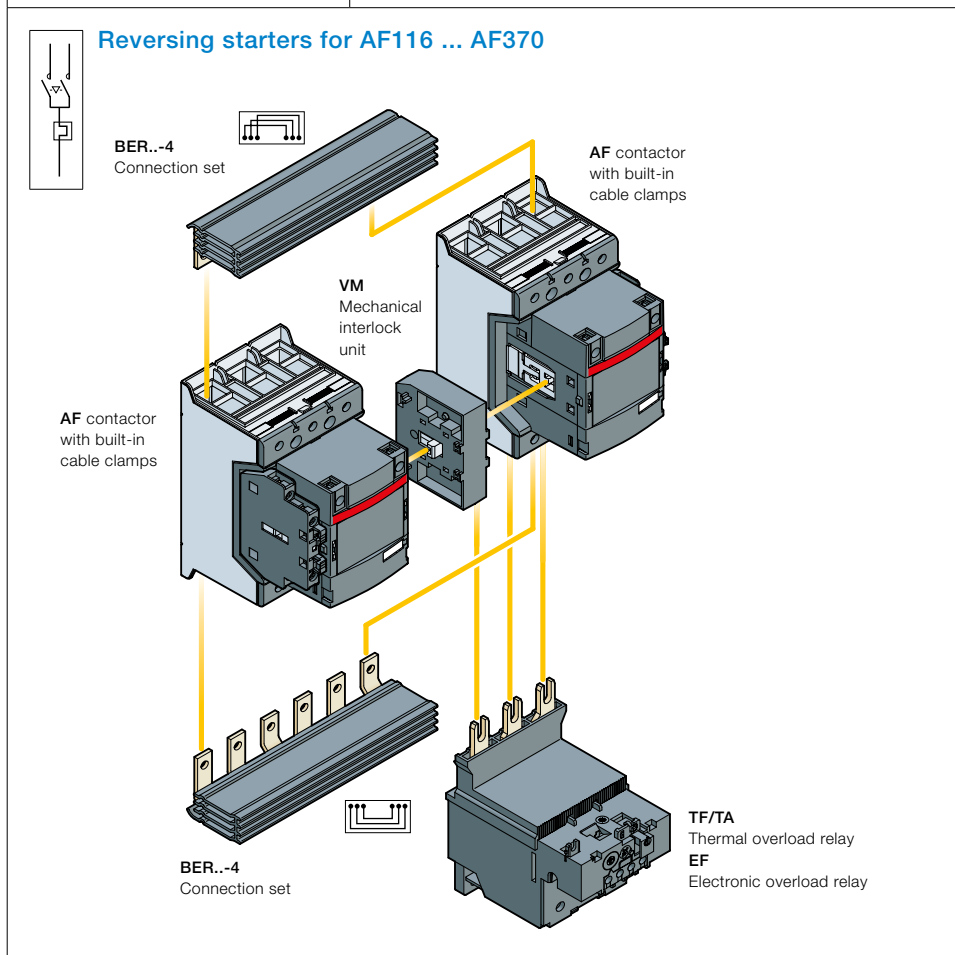

Direct-on-line starters protected by thermal overload relays

With AF contactors - Open type version in kit form

IEC		Control voltage Uc min. ... Uc max. (1)				Type	Order code	Setting ranges	Type	Order code
Rated power	Rated current	V 50/60 Hz		V DC				A		
4	8.5	24...60	20...60	100...250	100...250	AF09Z-30-10-21	1SBL136001R2110	7.60...10.0	TF42-10	1SAZ721201R1043
						AF09-30-10-13	1SBL137001R1310			
5.5	11.5	24...60	20...60	100...250	100...250	AF12Z-30-10-21	1SBL156001R2110	10.0...13.0	TF42-13	1SAZ721201R1045
						AF12-30-10-13	1SBL157001R1310			
7.5	15.5	24...60	20...60	100...250	100...250	AF16Z-30-10-21	1SBL176001R2110	13.0...16.0	TF42-16	1SAZ721201R1047
						AF16-30-10-13	1SBL177001R1310			
11	22	24...60	20...60	100...250	100...250	AF26Z-30-00-21	1SBL236001R2100	20.0...24.0	TF42-24	1SAZ721201R1051
						AF26-30-00-13	1SBL237001R1300			
15	29	24...60	20...60	100...250	100...250	AF30Z-30-00-21	1SBL276001R2100	29.0...35.0	TF42-35	1SAZ721201R1053
						AF30-30-00-13	1SBL277001R1300			
18.5	35	24...60	20...60	100...250	100...250	AF38Z-30-00-21	1SBL296001R2100	35.0...38.0/40.0	TF42-38	1SAZ721201R1055
						AF38-30-00-13	1SBL297001R1300			
18.5	35	24...60	20...60	100...250	100...250	AF40-30-00-11	1SBL347001R1100	30.0...40.0	TF65-40	1SAZ811201R1003
						AF40-30-00-13	1SBL347001R1300			
22	41	24...60	20...60	100-250	100-250	AF52-30-00-11	1SBL367001R1100	36.00...47.0	TF65-47	1SAZ811201R1004
						AF52-30-00-13	1SBL367001R1300			
30	55	24...60	20...60	100-250	100-250	AF65-30-00-11	1SBL387001R1100	50.0...60.0	TF65-60	1SAZ811201R1006
						AF65-30-00-13	1SBL387001R1300			
37	66	24...60	20...60	100-250	100-250	AF80-30-00-11	1SBL397001R1100	57.0...68.0	TF96-68	1SAZ911201R1003
						AF80-30-00-13	1SBL397001R1300			
45	80	24...60	20...60	100-250	100-250	AF96-30-00-11	1SBL407001R1100	75.0...87.0	TF96-87	1SAZ911201R1005
						AF96-30-00-13	1SBL407001R1300			
55	97	24...60	20...60	100-250	100-250	AF116-30-11-11	1SFL427001R1111	80...110	TF140DU-110	1SAZ431201R1002
						AF116-30-11-13	1SFL427001R1311			
75	132	24...60	20...60	100-250	100-250	AF140-30-11-11	1SFL447001R1111	100...135	TF140DU-135	1SAZ431201R1003
						AF140-30-11-13	1SFL447001R1311			
90	160	24...60	20...60	100-250	100-250	AF190-30-11-11	1SFL487002R1111	130...175	TA200DU-175	1SAZ421201R1005
						AF190-30-11-13	1SFL487002R1311			
110	195	24...60	20...60	100-250	100-250	AF205-30-11-11	1SFL527002R1111	150...200	TA200DU-200	1SAZ421201R1006
						AF205-30-11-13	1SFL527002R1311			

(1) For other control voltages, see "Voltage code table".

Note : for rated power above 110 kW, refer to "Starters protected by electronic overload relays".

Reversing starters protected by thermal overload relays

With AF contactors - Open type version in kit form

IEC		Control voltage				Type		Order code		Setting ranges			Type		Order code		Type		Order code	
AC-3, 400 V	Rated power kW	Rated current A	Uc min. ... Uc max. (1)		V 50/60 Hz		V DC				A									
			V	VDC	V	VDC														
4	8.5	8.5	24...60	20...60	AF09Z-30-10-21	1SBL136001R2110	7.6...10.0	TF42-10	1SAZ721201R1043	+	BER16-4 VEM4	1SBN081311R1000 1SBN030111R1000								
			100...250	100...250	AF09-30-10-13	1SBL137001R1310														
5.5	11.5	11.5	24...60	20...60	AF12Z-30-10-21	1SBL156001R2110	10.0...13.0	TF42-13	1SAZ721201R1045											
			100...250	100...250	AF12-30-10-13	1SBL157001R1310														
7.5	15.5	15.5	24...60	20...60	AF16Z-30-10-21	1SBL176001R2110	13.0...16.0	TF42-16	1SAZ721201R1047											
			100...250	100...250	AF16-30-10-13	1SBL177001R1310														
11	22	22	24...60	20...60	AF26Z-30-00-21	1SBL236001R2100	20.0...24.0	TF42-24	1SAZ721201R1051	+	BER38-4 VEM4	1SBN082311R1000 1SBN030111R1000								
			100...250	100...250	AF26-30-00-13	1SBL237001R1300														
15	29	29	24...60	20...60	AF30Z-30-00-21	1SBL276001R2100	29.0...35.0	TF42-35	1SAZ721201R1053	+ 2x	CA4-10	1SBN010110R1010								
			100...250	100...250	AF30-30-00-13	1SBL277001R1300														
18.5	35	35	24...60	20...60	AF38Z-30-00-21	1SBL296001R2100	35.0...38.0/40.0	TF42-38	1SAZ721201R1055											
			100...250	100...250	AF38-30-00-13	1SBL297001R1300														
18.5	35	35	24...60	20...60	AF40-30-00-11	1SBL347001R1100	30.0...40.0	TF65-40	1SAZ811201R1003	+	BER65-4 VM96-4	1SBN083411R1000 1SBN033405T1000								
			100...250	100...250	AF40-30-00-13	1SBL347001R1300														
22	41	41	24...60	20...60	AF52-30-00-11	1SBL367001R1100	36.0...47.0	TF65-47	1SAZ811201R1004	+ 2x	CA4-10	1SBN010110R1010								
			100...250	100...250	AF52-30-00-13	1SBL367001R1300														
30	55	55	24...60	20...60	AF65-30-00-11	1SBL387001R1100	50.0...60.0	TF65-60	1SAZ811201R1006	+ 2x	CA4-01	1SBN010110R1001								
			100...250	100...250	AF65-30-00-13	1SBL387001R1300														
37	66	66	24...60	20...60	AF80-30-00-11	1SBL397001R1100	57.0...68.0	TF96-68	1SAZ911201R1003	+	BER96-4 VM96-4	1SBN083911R1000 1SBN033405T1000								
			100...250	100...250	AF80-30-00-13	1SBL397001R1300														
45	80	80	24...60	20...60	AF96-30-00-11	1SBL407001R1100	75.0...87.0	TF96-87	1SAZ911201R1005	+ 2x	CA4-10	1SBN010110R1010								
			100...250	100...250	AF96-30-00-13	1SBL407001R1300														
55	97	97	24...60	20...60	AF116-30-11-11	1SFL427001R1111	80...110	TF140DU-110	1SAZ431201R1002	+	BER140-4 VM19	1SFN084211R1000 1SFN030300R1000								
			100...250	100...250	AF116-30-11-13	1SFL427001R1311														
75	132	132	24...60	20...60	AF140-30-11-11	1SFL447001R1111	100...135	TF140DU-135	1SAZ431201R1003											
			100...250	100...250	AF140-30-11-13	1SFL447001R1311														
90	160	160	24...60	20...60	AF190-30-11-11	1SFL487002R1111	130...175	TA200DU-175	1SAZ421201R1005	+	BER205-4 VM19	1SFN084811R1000 1SFN030300R1000								
			100...250	100...250	AF190-30-11-13	1SFL487002R1311														
110	195	195	24...60	20...60	AF205-30-11-11	1SFL527002R1111	150...200	TA200DU-200	1SAZ421201R1006											
			100...250	100...250	AF205-30-11-13	1SFL527002R1311														

(1) For other control voltages, see "Voltage code table".

Note : for rated power above 110 kW, refer to "Starters protected by electronic overload relays".

Direct-on-line starters protected by electronic overload relays

With AF contactors - Open type version in kit form

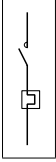
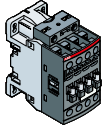
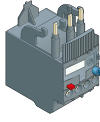
		  Contactors				 Electronic overload relays			Accessories
IEC		Control voltage Uc min. ... Uc max. (1)		Type	Order code	Setting ranges	Type	Order code	
AC-3, 400 V Rated power kW	Rated current A	V 50/60 Hz				A			
		V DC							
4	8.5	24...60	20...60	AF09Z-30-10-21	1SBL136001R2110	5.70...18.9	EF19-18.9	1SAX121001R1105	
		100...250	100...250	AF09-30-10-13	1SBL137001R1310				
5.5	11.5	24...60	20...60	AF12Z-30-10-21	1SBL156001R2110	5.70...18.9	EF19-18.9	1SAX121001R1105	
		100...250	100...250	AF12-30-10-13	1SBL157001R1310				
7.5	15.5	24...60	20...60	AF16Z-30-10-21	1SBL176001R2110	5.70...18.9	EF19-18.9	1SAX121001R1105	
		100...250	100...250	AF16-30-10-13	1SBL177001R1310				
11	22	24...60	20...60	AF26Z-30-00-21	1SBL236001R2100	9.00...30.0	EF45-30	1SAX221001R1101	
		100...250	100...250	AF26-30-00-13	1SBL237001R1300				
15	29	24...60	20...60	AF30Z-30-00-21	1SBL276001R2100	9.00...30.0	EF45-30	1SAX221001R1101	
		100...250	100...250	AF30-30-00-13	1SBL277001R1300				
18.5	35	24...60	20...60	AF38Z-30-00-21	1SBL296001R2100	15.0...45.0	EF45-45	1SAX221001R1102	
		100...250	100...250	AF38-30-00-13	1SBL297001R1300				
18.5	35	24...60	20...60	AF40-30-00-11	1SBL347001R1100	25.0...70.0	EF65-70	1SAX331001R1101	
		100...250	100...250	AF40-30-00-13	1SBL347001R1300				
22	41	24...60	20...60	AF52-30-00-11	1SBL367001R1100	25.0...70.0	EF65-70	1SAX331001R1101	
		100-250	100-250	AF52-30-00-13	1SBL367001R1300				
30	55	24...60	20...60	AF65-30-00-11	1SBL387001R1100	25.0...70.0	EF65-70	1SAX331001R1101	
		100-250	100-250	AF65-30-00-13	1SBL387001R1300				
37	66	24...60	20...60	AF80-30-00-11	1SBL397001R1100	36...100	EF96-100	1SAX341001R1101	
		100-250	100-250	AF80-30-00-13	1SBL397001R1300				
45	80	24...60	20...60	AF96-30-00-11	1SBL407001R1100	36...100	EF96-100	1SAX341001R1101	
		100-250	100-250	AF96-30-00-13	1SBL407001R1300				
55	97	24...60	20...60	AF116-30-11-11	1SFL427001R1111	54...150	EF146-150	1SAX351001R1101	
		100-250	100-250	AF116-30-11-13	1SFL427001R1311				
75	132	24...60	20...60	AF140-30-11-11	1SFL447001R1111	54...150	EF146-150	1SAX351001R1101	
		100-250	100-250	AF140-30-11-13	1SFL447001R1311				
90	160	24...60	20...60	AF190-30-11-11	1SFL487002R1111	63...210	EF205-210	1SAX531001R1101	
		100-250	100-250	AF190-30-11-13	1SFL487002R1311				
110	195	24...60	20...60	AF205-30-11-11	1SFL527002R1111	63...210	EF205-210	1SAX531001R1101	
		100-250	100-250	AF205-30-11-13	1SFL527002R1311				
132	230	24...60	20...60	AF265-30-11-11	1SFL547002R1111	115...380	EF370-380	1SAX611001R1101	
		100-250	100-250	AF265-30-11-13	1SFL547002R1311				
160	280	24...60	20...60	AF305-30-11-11	1SFL587002R1111	115...380	EF370-380	1SAX611001R1101	
		100-250	100-250	AF305-30-11-13	1SFL587002R1311				
200	350	24...60	20...60	AF370-30-11-11	1SFL607002R1111	115...380	EF370-380	1SAX611001R1101	
		100-250	100-250	AF370-30-11-13	1SFL607002R1311				

(1) For other control voltages, see "Voltage code table".

Reversing starters protected by electronic overload relays

With AF contactors - Open type version in kit form

IEC		Control voltage				Type		Order code		Setting ranges			Type		Order code		Type		Order code	
AC-3, 400 V	Rated power kW	Rated current A	Uc min. ... Uc max. (1)		VDC				A											
			V 50/60 Hz	VDC																
4	8.5	8.5	24...60	20...60	AF09Z-30-10-21	1SBL136001R2110	5.70...18.9	EF19-18.9	1SAX121001R1105	+	BER16-4 VEM4	1SBN081311R1000 1SBN030111R1000								
			100...250	100...250	AF09-30-10-13	1SBL137001R1310														
5.5	11.5	11.5	24...60	20...60	AF12Z-30-10-21	1SBL156001R2110	5.70...18.9	EF19-18.9	1SAX121001R1105											
			100...250	100...250	AF12-30-10-13	1SBL157001R1310														
7.5	15.5	15.5	24...60	20...60	AF16Z-30-10-21	1SBL176001R2110	5.70...18.9	EF19-18.9	1SAX121001R1105											
			100...250	100...250	AF16-30-10-13	1SBL177001R1310														
11	22	22	24...60	20...60	AF26Z-30-00-21	1SBL236001R2100	9.00...30.0	EF45-30	1SAX221001R1101	+	BER38-4 VEM4	1SBN082311R1000 1SBN030111R1000								
			100...250	100...250	AF26-30-00-13	1SBL237001R1300														
15	29	29	24...60	20...60	AF30Z-30-00-21	1SBL276001R2100	9.00...30.0	EF45-30	1SAX221001R1101	+ 2x	CA4-10	1SBN010110R1010								
			100...250	100...250	AF30-30-00-13	1SBL277001R1300														
18.5	35	35	24...60	20...60	AF38Z-30-00-21	1SBL296001R2100	15.0...45.0	EF45-45	1SAX221001R1102											
			100...250	100...250	AF38-30-00-13	1SBL297001R1300														
18.5	35	35	24...60	20...60	AF40-30-00-11	1SBL347001R1100	25.0...70.0	EF65-70	1SAX331001R1101	+	BER65-4 VM96-4	1SBN083411R1000 1SBN033405T1000								
			100...250	100...250	AF40-30-00-13	1SBL347001R1300														
22	41	41	24...60	20...60	AF52-30-00-11	1SBL367001R1100	25.0...70.0	EF65-70	1SAX331001R1101	+ 2x	CA4-10	1SBN010110R1010								
			100...250	100...250	AF52-30-00-13	1SBL367001R1300														
30	55	55	24...60	20...60	AF65-30-00-11	1SBL387001R1100	25.0...70.0	EF65-70	1SAX331001R1101	+ 2x	CA4-01	1SBN010110R1001								
			100...250	100...250	AF65-30-00-13	1SBL387001R1300														
37	66	66	24...60	20...60	AF80-30-00-11	1SBL397001R1100	36...100	EF96-100	1SAX341001R1101	+	BER96-4 VM96-4	1SBN083911R1000 1SBN033405T1000								
			100...250	100...250	AF80-30-00-13	1SBL397001R1300														
45	80	80	24...60	20...60	AF96-30-00-11	1SBL407001R1100	36...100	EF96-100	1SAX341001R1101	+ 2x	CA4-10 CA4-01	1SBN010110R1010 1SBN010110R1001								
			100...250	100...250	AF96-30-00-13	1SBL407001R1300														
55	97	97	24...60	20...60	AF116-30-11-11	1SFL427001R1111	54...150	EF146-150	1SAX351001R1101	+	BER140-4 VM19	1SFN084211R1000 1SFN030300R1000								
			100...250	100...250	AF116-30-11-13	1SFL427001R1311														
75	132	132	24...60	20...60	AF140-30-11-11	1SFL447001R1111	54...150	EF146-150	1SAX351001R1101											
			100...250	100...250	AF140-30-11-13	1SFL447001R1311														
90	160	160	24...60	20...60	AF190-30-11-11	1SFL487002R1111	63...210	EF205-210	1SAX531001R1101	+	BER205-4 VM19	1SFN084811R1000 1SFN030300R1000								
			100...250	100...250	AF190-30-11-13	1SFL487002R1311														
110	195	195	24...60	20...60	AF205-30-11-11	1SFL527002R1111	63...210	EF205-210	1SAX531001R1101											
			100...250	100...250	AF205-30-11-13	1SFL527002R1311														
132	230	230	24...60	20...60	AF265-30-11-11	1SFL547002R1111	115...380	EF370-380	1SAX611001R1101	+	BER370-4 VM19	1SFN085411R1000 1SFN030300R1000								
			100...250	100...250	AF265-30-11-13	1SFL547002R1311														
160	280	280	24...60	20...60	AF305-30-11-11	1SFL587002R1111	115...380	EF370-380	1SAX611001R1101											
			100...250	100...250	AF305-30-11-13	1SFL587002R1311														
200	350	350	24...60	20...60	AF370-30-11-11	1SFL607002R1111	115...380	EF370-380	1SAX611001R1101											
			100...250	100...250	AF370-30-11-13	1SFL607002R1311														

(1) For other control voltages, see "Voltage code table".

Star-delta starters protected by overload relays

With AF contactors - Open type version in kit form

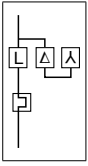

Application

Star-delta starting is the most common method to reduce the starting current of a motor.

This system can be used on all the squirrel cage motors, which are normally used in delta connection. In this type of starting, it is recommended to choose motors having high starting torque i.e. much higher than the resistive torque in order to reach sufficient high speed when the motor is connected in star.

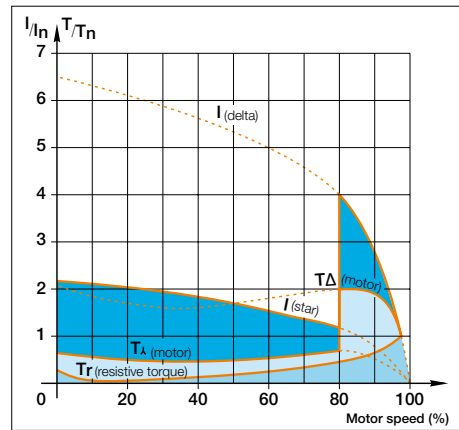

When starting:

- Inrush current is reduced to a third of direct starting current
- Motor torque is reduced to a third or even less of direct starting torque.

Transient current is generated when switching from star to delta connection.

During the initial starting phase ("star" connection), the resistive torque of the driven load must remain, irrespective of speed, less than the "star" motor torque until "star-delta" switching occurs.

This starting mode is therefore ideal for machines having low starting torque such as pumps, centrifugal compressors, wood-working machines...

I = current
T = torque
In = nominal current
Tn = nominal torque

Precaution

- Motor nominal voltage in delta connection must be equal to that of the mains. Example: a motor for 400 V star-delta starting must be designed for 400 V in "delta" connection. Its usual designation is "400 V / 690 V motor". The motor must be constructed with 6 terminal windings
- In order to prevent a high current peak, at least 85 % of nominal speed must be reached before switching from star to delta

Sequence

Starting is a three-stage process:

1st stage: "Star" connection - Press the "On" button on the control circuit to close the KM2 "Star" contactor. The KM1 "line" contactor then closes and the motor starts. Countdown of programmed starting time (6 to 10 s) then begins.

2nd stage: "Star" to "Delta" switching - when programmed starting time is over, the KM2 "Star" contactor opens.

3rd stage: "Delta" connection - Thanks to AF contactors, a transition time (or dwelling time) of 50 ms is already integrated between the opening of the "star" contactor and closing of the "delta" contactor.

Conclusion: An on-delay timer without dwelling time (e.g.: CT-ERS.21S or TEF4-ON) is enough to count-down the programmed starting time (6 to 10 s) during "Star connection". The use of a star-delta timer including a dwelling time is not permitted.

Main Technical Data

Standards	IEC 60947-4-1 / EN 60947-4-1
Rated operational voltage Ue max.	690 V - 50/60 Hz
Rated insulation voltage Ui	
acc. to IEC 60947-4-1	690 V
acc. to UL / CSA	600 V
Ambient air temperature	
Close to the device	≤ 60 °C (TF42: 38 A above ≤ 50 °C)
Degree of protection	IP20
Switching frequency	Refer to "Switching frequency diagrams" page

Mounting positions

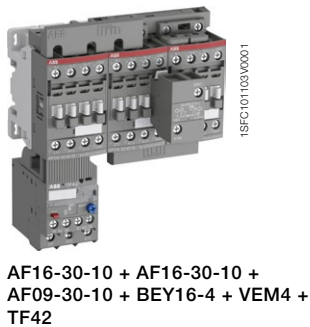
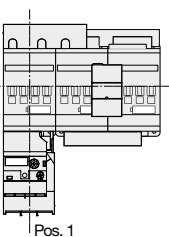

Star-delta starters protected by overload relays

With AF contactors - Open type version in kit form

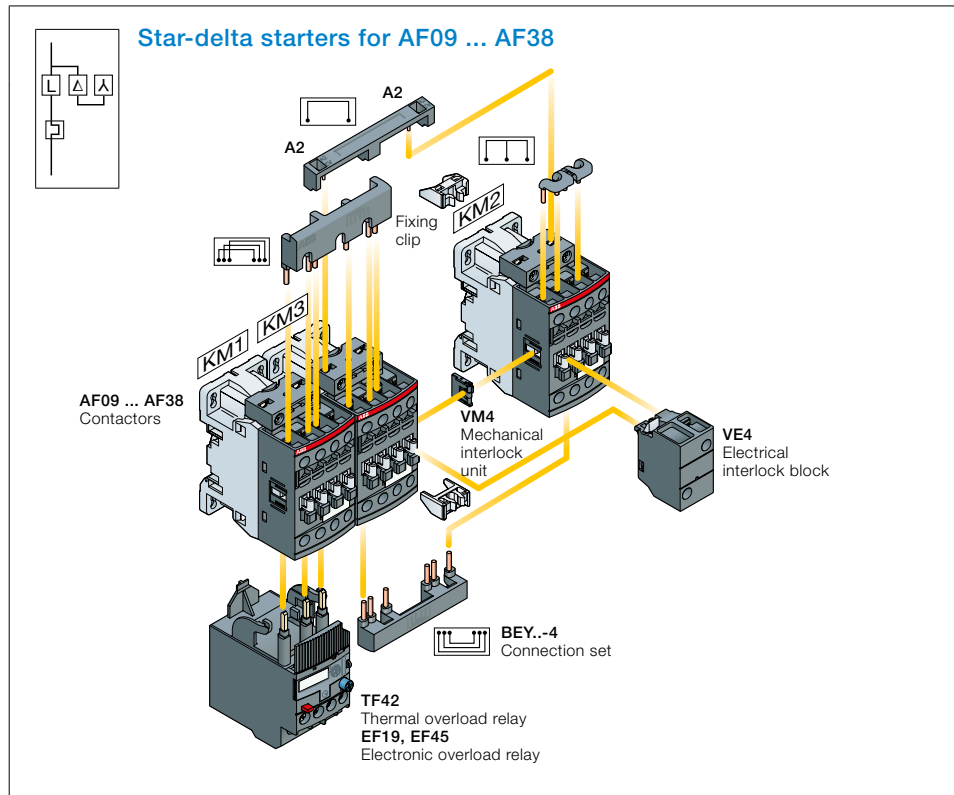

Description

You can easily assemble star-delta starter thanks to our complete range of accessories:

- For AF09 ... AF38, use VEM4 mechanical and electrical interlock set without increasing starter width. It includes:
 - VM4 mechanical interlock unit and 2 fixing clips
 - VE4 electrical interlock block with A2-A2 connection.
- For AF40 ... AF370, use VM mechanical interlock unit and additional auxiliary contact blocks for electrical interlocking.
- BEY...-4 connection set: it assures a safe and simple connection between both contactor main terminals.

Select now easily and quickly your starter in the following pages at 400 V, up to 200 kW.

For the full coordination tables: www.abb.com/lowvoltage then go to the right menu: "Support", select: "Online Product Selection Tools" then select "Coordination Tables for motor protection"

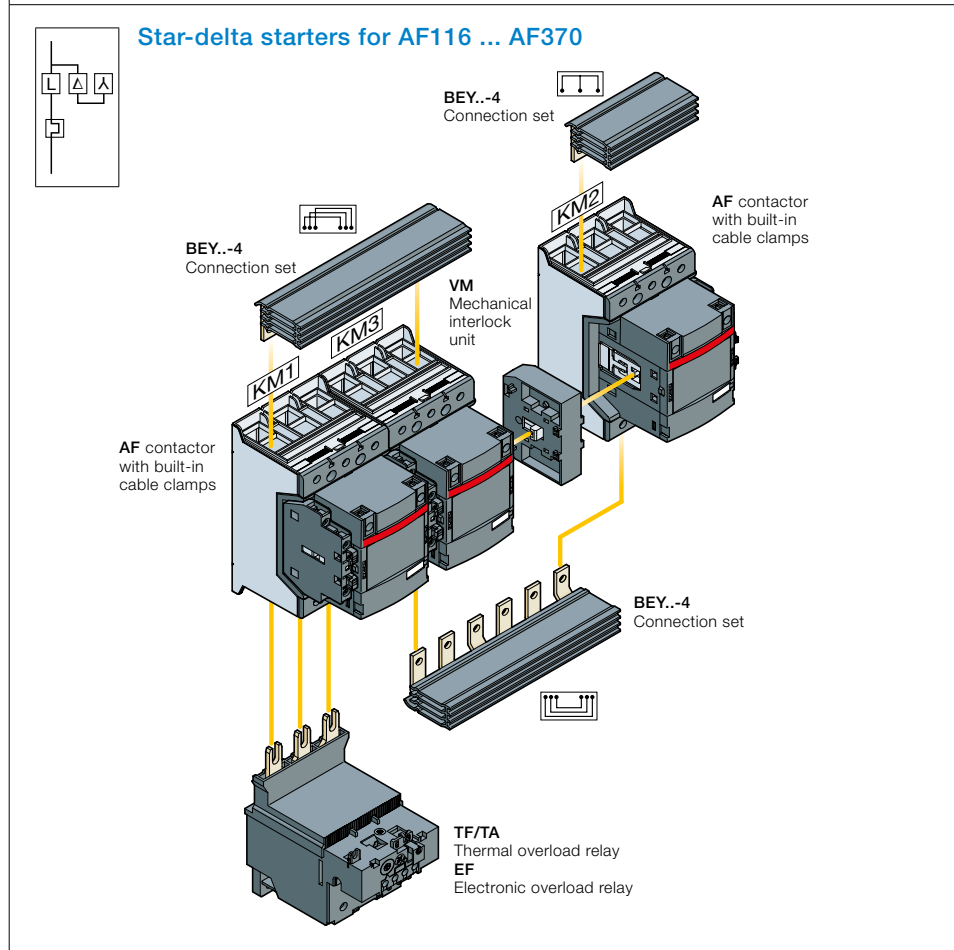

Star-delta starters protected by thermal overload relays With AF contactors - Open type version in kit form

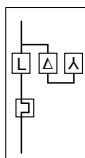

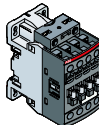
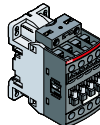
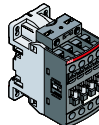
		Line contactor KM1		Delta contactor KM3		Star contactor KM2										
																
		Type	Order code	Type	Order code	Type	Order code									
		Control voltage Uc min. ... Uc max. (1)														
IEC		V 50/60 Hz: V DC														
AC-3																
Rated power																
220 V	230/240 V	380 V	400 V	415 V	440 V	500 V	690 V	400 V	Rated current							
kW	kW	kW	kW	kW	kW	kW	kW	A								
4	4	7.5	7.5	7.5	7.5	9	9	15.5	24...60 100...250	20...60 100...250	AF09Z-30-10-21 AF09-30-10-13	1SBL136001R2110 1SBL137001R1310	AF09Z-30-10-21 AF09-30-10-13	1SBL136001R2110 1SBL137001R1310	AF09Z-30-10-21 AF09-30-10-13	1SBL136001R2110 1SBL137001R1310
5.5	5.5	9	11	11	11	11	11	22	24...60 100...250	20...60 100...250	AF12Z-30-10-21 AF12-30-10-13	1SBL156001R2110 1SBL157001R1310	AF12Z-30-10-21 AF12-30-10-13	1SBL156001R2110 1SBL157001R1310	AF09Z-30-10-21 AF09-30-10-13	1SBL136001R2110 1SBL137001R1310
7.5	9	15	15	15	15	15	15	29	24...60 100...250	20...60 100...250	AF16Z-30-10-21 AF16-30-10-13	1SBL176001R2110 1SBL177001R1310	AF16Z-30-10-21 AF16-30-10-13	1SBL176001R2110 1SBL177001R1310	AF09Z-30-10-21 AF09-30-10-13	1SBL136001R2110 1SBL137001R1310
11	11	18.5	18.5	25	25	25	25	35	24...60 100...250	20...60 100...250	AF26Z-30-00-21 AF26-30-00-13	1SBL236001R2100 1SBL237001R1300	AF26Z-30-00-21 AF26-30-00-13	1SBL236001R2100 1SBL237001R1300	AF26Z-30-00-21 AF26-30-00-13	1SBL236001R2100 1SBL237001R1300
11	11	22	22	25	25	25	25	41	24...60 100...250	20...60 100...250	AF26Z-30-00-21 AF26-30-00-13	1SBL236001R2100 1SBL237001R1300	AF26Z-30-00-21 AF26-30-00-13	1SBL236001R2100 1SBL237001R1300	AF26Z-30-00-21 AF26-30-00-13	1SBL236001R2100 1SBL237001R1300
11	15	25	25	25	25	30	30	47	24...60 100...250	20...60 100...250	AF30Z-30-00-21 AF30-30-00-13	1SBL276001R2100 1SBL277001R1300	AF30Z-30-00-21 AF30-30-00-13	1SBL276001R2100 1SBL277001R1300	AF26Z-30-00-21 AF26-30-00-13	1SBL236001R2100 1SBL237001R1300
18.5	18.5	37	37	37	37	37	37	66	24...60 100...250	20...60 100...250	AF40-30-00-11 AF40-30-00-13	1SBL347001R1100 1SBL347001R1300	AF40-30-00-11 AF40-30-00-13	1SBL347001R1100 1SBL347001R1300	AF40-30-00-11 AF40-30-00-13	1SBL347001R1100 1SBL347001R1300
25	25	45	45	45	45	45	45	80	24...60 100...250	20...60 100...250	AF52-30-00-11 AF52-30-00-13	1SBL367001R1100 1SBL367001R1300	AF52-30-00-11 AF52-30-00-13	1SBL367001R1100 1SBL367001R1300	AF40-30-00-11 AF40-30-00-13	1SBL347001R1100 1SBL347001R1300
30	30	55	55	55	55	55	55	97	24...60 100...250	20...60 100...250	AF65-30-00-11 AF65-30-00-13	1SBL387001R1100 1SBL387001R1300	AF65-30-00-11 AF65-30-00-13	1SBL387001R1100 1SBL387001R1300	AF40-30-00-11 AF40-30-00-13	1SBL347001R1100 1SBL347001R1300
37	37	75	75	75	75	75	75	132	24...60 100...250	20...60 100...250	AF80-30-00-11 AF80-30-00-13	1SBL397001R1100 1SBL397001R1300	AF80-30-00-11 AF80-30-00-13	1SBL397001R1100 1SBL397001R1300	AF52-30-00-11 AF52-30-00-13	1SBL367001R1100 1SBL367001R1300
45	45	90	90	90	90	90	90	160	24...60 100...250	20...60 100...250	AF96-30-00-11 AF96-30-00-13	1SBL407001R1100 1SBL407001R1300	AF96-30-00-11 AF96-30-00-13	1SBL407001R1100 1SBL407001R1300	AF65-30-00-11 AF65-30-00-13	1SBL387001R1100 1SBL387001R1300
55	55	90	110	110	132	132	110	195	24...60 100...250	20...60 100...250	AF116-30-11-11 AF116-30-11-13	1SFL427001R1111 1SFL427001R1311	AF116-30-11-11 AF116-30-11-13	1SFL427001R1111 1SFL427001R1311	AF116-30-11-11 (4) AF116-30-11-13	1SFL427001R1111 1SFL427001R1311
75	75	132	132	132	132	160	132	230	24...60 100...250	20...60 100...250	AF140-30-11-11 AF140-30-11-13	1SFL447001R1111 1SFL447001R1311	AF140-30-11-11 AF140-30-11-13	1SFL447001R1111 1SFL447001R1311	AF116-30-11-11 AF116-30-11-13	1SFL427001R1111 1SFL427001R1311
90	90	160	160	160	160	200	200	280	24...60 100...250	20...60 100...250	AF190-30-11-11 AF190-30-11-13	1SFL487002R1111 1SFL487002R1311	AF190-30-11-11 AF190-30-11-13	1SFL487002R1111 1SFL487002R1311	AF140-30-11-11 AF140-30-11-13	1SFL447001R1111 1SFL447001R1311

(1) AF09 ... AF190: ambient temperature ≤ 60 °C.



(2) The setting current value is: nominal motor current x 0.58. Overload relay type given for 400 V - AC-3.

For other voltage, select overload relay type according to required nominal motor current x 0.58.

(3) On-delay timer without dwelling-time (e.g.: side-mounted CT-ERS.21S or front-mounted TEF4-ON) is enough to countdown the programmed starting time during "Star connection".

In case of use of front-mounted TEF4-ON on-delay timer, mount on KM1 contactor AF26 ... AF96 a side-mounted GAL4-11 auxiliary contact block instead of CA4-10 auxiliary contact block.

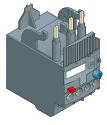
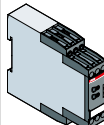
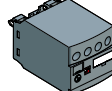
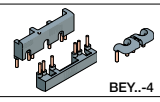
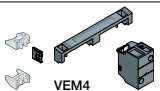
(4) AF80 can also be used, but no connection set and mechanical interlock is available for this combination.

Thermal overload relays (2)			Electronic timers (3)			Accessories			Auxiliary contact blocks		
			 CT-ERS  TEF4-ON Uc = 24...240 V 50/60 Hz or DC			 BEY..-4  VEM4			 CA4		
Setting ranges	Type	Order code	Type	Order code	Type	Order code	Type	Order code	Type	Order code	
A											
7.60...10.0	TF42-10	1SAZ721201R1043	CT-ERS.21S or TEF4-ON	1SVR730100R0300 1SBN020112R1000	BEY16-4 + VEM4	1SBN081313R2000 1SBN030111R1000	-	-	-	-	
10.0...13.0	TF42-13	1SAZ721201R1045	CT-ERS.21S or TEF4-ON	1SVR730100R0300 1SBN020112R1000	BEY16-4 + VEM4	1SBN081313R2000 1SBN030111R1000	-	-	-	-	
16.0...20.0	TF42-20	1SAZ721201R1049	CT-ERS.21S or TEF4-ON	1SVR730100R0300 1SBN020112R1000	BEY16-4 + VEM4	1SBN081313R2000 1SBN030111R1000	-	-	-	-	
20.0...24.0	TF42-24	1SAZ721201R1051	CT-ERS.21S or TEF4-ON	1SVR730100R0300 1SBN020112R1000	BEY38-4 + VEM4	1SBN082713R2000 1SBN030111R1000	KM1 : 1 x CA4-10 KM2 : 1 x CA4-10	1SBN010110R1010 1SBN010110R1010			
20.0...24.0	TF42-24	1SAZ721201R1051	CT-ERS.21S or TEF4-ON	1SVR730100R0300 1SBN020112R1000	BEY38-4 + VEM4	1SBN082713R2000 1SBN030111R1000	KM1 : 1 x CA4-10 KM2 : 1 x CA4-10	1SBN010110R1010 1SBN010110R1010			
24.0...29.0	TF42-29	1SAZ721201R1052	CT-ERS.21S or TEF4-ON	1SVR730100R0300 1SBN020112R1000	BEY38-4 + VEM4	1SBN082713R2000 1SBN030111R1000	KM1 : 1 x CA4-10 KM2 : 1 x CA4-10	1SBN010110R1010 1SBN010110R1010			
30.0...40.0	TF65-40	1SAZ811201R1003	CT-ERS.21S or TEF4-ON	1SVR730100R0300 1SBN020112R1000	BEY65-4 + VM96-4	1SBN083413R2000 1SBN033405T1000	KM1 : 1 x CA4-10 (3) KM2 : 1 x CA4-10 1 x CA4-01 KM3 : 1 x CA4-01	1SBN010110R1010 1SBN010110R1010 1SBN010110R1001 1SBN010110R1001			
36.0...47.0	TF65-47	1SAZ811201R1004	CT-ERS.21S or TEF4-ON	1SVR730100R0300 1SBN020112R1000	BEY65-4 + VM96-4	1SBN083413R2000 1SBN033405T1000	KM1 : 1 x CA4-10 (3) KM2 : 1 x CA4-10 1 x CA4-01 KM3 : 1 x CA4-01	1SBN010110R1010 1SBN010110R1010 1SBN010110R1001 1SBN010110R1001			
50.0...60.0	TF65-60	1SAZ811201R1006	CT-ERS.21S or TEF4-ON	1SVR730100R0300 1SBN020112R1000	BEY65-4 + VM96-4	1SBN083413R2000 1SBN033405T1000	KM1 : 1 x CA4-10 (3) KM2 : 1 x CA4-10 1 x CA4-01 KM3 : 1 x CA4-01	1SBN010110R1010 1SBN010110R1010 1SBN010110R1001 1SBN010110R1001			
65.0...78.0	TF96-78	1SAZ911201R1004	CT-ERS.21S or TEF4-ON	1SVR730100R0300 1SBN020112R1000	BEY96-4 + VM96-4	1SBN083913R2000 1SBN033405T1000	KM1 : 1 x CA4-10 (3) KM2 : 1 x CA4-10 1 x CA4-01 KM3 : 1 x CA4-01	1SBN010110R1010 1SBN010110R1010 1SBN010110R1001 1SBN010110R1001			
84.0...96.0	TF96-96	1SAZ911201R1006	CT-ERS.21S or TEF4-ON	1SVR730100R0300 1SBN020112R1000	BEY96-4 + VM96-4	1SBN083913R2000 1SBN033405T1000	KM1 : 1 x CA4-10 (3) KM2 : 1 x CA4-10 1 x CA4-01 KM3 : 1 x CA4-01	1SBN010110R1010 1SBN010110R1010 1SBN010110R1001 1SBN010110R1001			
100...135	TF140DU-135	1SAZ431201R1003	CT-ERS.21S	1SVR730100R0300	BEY140-4 + VM19	1SBN084413R1000 1SBN030300R1000	-	-	-	-	
100...135	TF140DU-135	1SAZ431201R1003	CT-ERS.21S	1SVR730100R0300	BEY140-4 + VM19	1SBN084413R1000 1SBN030300R1000	-	-	-	-	
130...175	TA200DU-175	1SAZ421201R1005	CT-ERS.21S	1SVR730100R0300	BEY190-4 + VM140/190	1SBN084813R1000 1SBN034403R1000	-	-	-	-	

Star-delta starters protected by electronic overload relays With AF contactors - Open type version in kit form

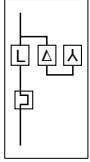

Line contactor KM1

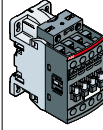

Delta contactor KM3

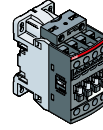

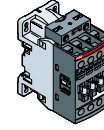

Star contactor KM2

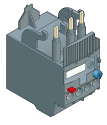
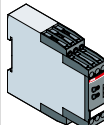
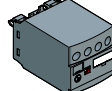
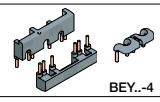
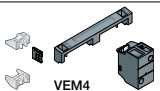

IEC AC-3 Rated power											Control voltage Uc min. ... Uc max. (1)		Type	Order code	Type	Order code	Type	Order code	
220 V kW	230/240 V kW	380 V kW	400 V kW	415 V kW	440 V kW	500 V kW	690 V kW	400 V A	Rated current	V 50/60 Hz	V DC								
4	4	7.5	7.5	7.5	7.5	9	9	15.5		24...60 100...250	20...60 100...250	AF09Z-30-10-21	1SBL136001R2110	AF09-30-10-13	1SBL137001R1310	AF09Z-30-10-21	1SBL136001R2110	AF09-30-10-13	1SBL137001R1310
5.5	5.5	9	11	11	11	11	11	22		24...60 100...250	20...60 100...250	AF12Z-30-10-21	1SBL156001R2110	AF12-30-10-13	1SBL157001R1310	AF12Z-30-10-21	1SBL156001R2110	AF12-30-10-13	1SBL157001R1310
7.5	9	15	15	15	15	15	15	29		24...60 100...250	20...60 100...250	AF16Z-30-10-21	1SBL176001R2110	AF16-30-10-13	1SBL177001R1310	AF16Z-30-10-21	1SBL176001R2110	AF16-30-10-13	1SBL177001R1310
11	11	18.5	18.5	25	25	25	25	35		24...60 100...250	20...60 100...250	AF26Z-30-00-21	1SBL236001R2100	AF26-30-00-13	1SBL237001R1300	AF26Z-30-00-21	1SBL236001R2100	AF26-30-00-13	1SBL237001R1300
11	11	22	22	25	25	25	25	41		24...60 100...250	20...60 100...250	AF26Z-30-00-21	1SBL236001R2100	AF26-30-00-13	1SBL237001R1300	AF26Z-30-00-21	1SBL236001R2100	AF26-30-00-13	1SBL237001R1300
11	15	25	25	25	25	30	30	47		24...60 100...250	20...60 100...250	AF30Z-30-00-21	1SBL276001R2100	AF30-30-00-13	1SBL277001R1300	AF30Z-30-00-21	1SBL276001R2100	AF30-30-00-13	1SBL277001R1300
18.5	18.5	37	37	37	37	37	37	66		24...60 100...250	20...60 100...250	AF40-30-00-11	1SBL347001R1100	AF40-30-00-13	1SBL347001R1300	AF40-30-00-11	1SBL347001R1100	AF40-30-00-13	1SBL347001R1300
25	25	45	45	45	45	45	45	80		24...60 100...250	20...60 100...250	AF52-30-00-11	1SBL367001R1100	AF52-30-00-13	1SBL367001R1300	AF52-30-00-11	1SBL367001R1100	AF52-30-00-13	1SBL367001R1300
30	30	55	55	55	55	55	55	97		24...60 100...250	20...60 100...250	AF65-30-00-11	1SBL387001R1100	AF65-30-00-13	1SBL387001R1300	AF65-30-00-11	1SBL387001R1100	AF65-30-00-13	1SBL387001R1300
37	37	75	75	75	75	75	75	132		24...60 100...250	20...60 100...250	AF80-30-00-11	1SBL397001R1100	AF80-30-00-13	1SBL397001R1300	AF80-30-00-11	1SBL397001R1100	AF80-30-00-13	1SBL397001R1300
45	45	90	90	90	90	90	90	160		24...60 100...250	20...60 100...250	AF96-30-00-11	1SBL407001R1100	AF96-30-00-13	1SBL407001R1300	AF96-30-00-11	1SBL407001R1100	AF96-30-00-13	1SBL407001R1300
55	55	90	110	110	132	132	110	195		24...60 100...250	20...60 100...250	AF116-30-11-11	1SFL427001R1111	AF116-30-11-13	1SFL427001R1311	AF116-30-11-11 (4)	1SFL427001R1111	AF116-30-11-13	1SFL427001R1311
75	75	132	132	132	132	160	132	230		24...60 100...250	20...60 100...250	AF140-30-11-11	1SFL447001R1111	AF140-30-11-13	1SFL447001R1311	AF140-30-11-11	1SFL447001R1111	AF140-30-11-13	1SFL447001R1311
90	90	160	160	160	160	200	200	280		24...60 100...250	20...60 100...250	AF190-30-11-11	1SFL487002R1111	AF190-30-11-13	1SFL487002R1311	AF190-30-11-11	1SFL487002R1111	AF190-30-11-13	1SFL487002R1311
110	110	160	200	200	200	250	250	350		24...60 100...250	20...60 100...250	AF205-30-11-11	1SFL527002R1111	AF205-30-11-13	1SFL527002R1311	AF205-30-11-11	1SFL527002R1111	AF205-30-11-13	1SFL527002R1311
132	132	250	250	250	250	315	355	430		24...60 100...250	20...60 100...250	AF265-30-11-11	1SFL547002R1111	AF265-30-11-13	1SFL547002R1311	AF265-30-11-11	1SFL547002R1111	AF265-30-11-13	1SFL547002R1311
160	160	315	315	315	355	400	400	540		24...60 100...250	20...60 100...250	AF370-30-11-11	1SFL607002R1111	AF370-30-11-13	1SFL607002R1311	AF370-30-11-11	1SFL607002R1111	AF370-30-11-13	1SFL607002R1311
200	200	315	355	355	400	400	500	610		24...60 100...250	20...60 100...250	AF370-30-11-11	1SFL607002R1111	AF370-30-11-13	1SFL607002R1311	AF370-30-11-11	1SFL607002R1111	AF370-30-11-13	1SFL607002R1311

(1) AF09 ... AF370: ambient temperature ≤ 60 °C.
 (2) The setting current value is: nominal motor current x 0.58. Overload relay type given for 400 V - AC-3.
 For other voltage, select overload relay type according to required nominal motor current x 0.58.
 (3) On-delay timer without dwelling-time (e.g.: side-mounted CT-ERS.21S or front-mounted TEF4-ON) is enough to countdown the programmed starting time during "Star connection".
 In case of use of front-mounted TEF4-ON on-delay timer, mount on KM1 contactor AF26 ... AF96 a side-mounted CAL4-11 auxiliary contact block instead of CA4-10 auxiliary contact block.
 (4) AF80 can also be used, but no connection set and mechanical interlock is available for this combination.

Electronic overload relays (2)			Electronic timers (3)			Accessories			Auxiliary contact blocks		
			 CT-ERS  TEF4-ON Uc = 24...240 V 50/60 Hz or DC			 BEY..-4  VEM4			 CA4		
Setting ranges	Type	Order code	Type	Order code	Type	Order code	Type	Order code			
A											
5.70...18.9	EF19-18.9	1SAX121001R1105	CT-ERS.21S or TEF4-ON	1SVR730100R0300 1SBN020112R1000	BEY16-4 + VEM4	1SBN081313R2000 1SBN030111R1000	-	-			
5.70...18.9	EF19-18.9	1SAX121001R1105	CT-ERS.21S or TEF4-ON	1SVR730100R0300 1SBN020112R1000	BEY16-4 + VEM4	1SBN081313R2000 1SBN030111R1000	-	-			
5.70...18.9	EF19-18.9	1SAX121001R1105	CT-ERS.21S or TEF4-ON	1SVR730100R0300 1SBN020112R1000	BEY16-4 + VEM4	1SBN081313R2000 1SBN030111R1000	-	-			
9.00...30.0	EF45-30	1SAX221001R1101	CT-ERS.21S or TEF4-ON	1SVR730100R0300 1SBN020112R1000	BEY38-4 + VEM4	1SBN082713R2000 1SBN030111R1000	KM1 : 1 x CA4-10 KM2 : 1 x CA4-10	1SBN010110R1010 1SBN010110R1010			
9.00...30.0	EF45-30	1SAX221001R1101	CT-ERS.21S or TEF4-ON	1SVR730100R0300 1SBN020112R1000	BEY38-4 + VEM4	1SBN082713R2000 1SBN030111R1000	KM1 : 1 x CA4-10 KM2 : 1 x CA4-10	1SBN010110R1010 1SBN010110R1010			
9.00...30.0	EF45-30	1SAX221001R1101	CT-ERS.21S or TEF4-ON	1SVR730100R0300 1SBN020112R1000	BEY38-4 + VEM4	1SBN082713R2000 1SBN030111R1000	KM1 : 1 x CA4-10 KM2 : 1 x CA4-10	1SBN010110R1010 1SBN010110R1010			
25...70	EF65-70	1SAX331001R1101	CT-ERS.21S or TEF4-ON	1SVR730100R0300 1SBN020112R1000	BEY65-4 + VM96-4	1SBN083413R2000 1SBN033405T1000	KM1 : 1 x CA4-10 (3) KM2 : 1 x CA4-10 1 x CA4-01 KM3 : 1 x CA4-01	1SBN010110R1010 1SBN010110R1010 1SBN010110R1001 1SBN010110R1001			
25...70	EF65-70	1SAX331001R1101	CT-ERS.21S or TEF4-ON	1SVR730100R0300 1SBN020112R1000	BEY65-4 + VM96-4	1SBN083413R2000 1SBN033405T1000	KM1 : 1 x CA4-10 (3) KM2 : 1 x CA4-10 1 x CA4-01 KM3 : 1 x CA4-01	1SBN010110R1010 1SBN010110R1010 1SBN010110R1001 1SBN010110R1001			
25...70	EF65-70	1SAX331001R1101	CT-ERS.21S or TEF4-ON	1SVR730100R0300 1SBN020112R1000	BEY65-4 + VM96-4	1SBN083413R2000 1SBN033405T1000	KM1 : 1 x CA4-10 (3) KM2 : 1 x CA4-10 1 x CA4-01 KM3 : 1 x CA4-01	1SBN010110R1010 1SBN010110R1010 1SBN010110R1001 1SBN010110R1001			
36...100	EF96-100	1SAX341001R1101	CT-ERS.21S or TEF4-ON	1SVR730100R0300 1SBN020112R1000	BEY96-4 + VM96-4	1SBN083913R2000 1SBN033405T1000	KM1 : 1 x CA4-10 (3) KM2 : 1 x CA4-10 1 x CA4-01 KM3 : 1 x CA4-01	1SBN010110R1010 1SBN010110R1010 1SBN010110R1001 1SBN010110R1001			
36...100	EF96-100	1SAX341001R1101	CT-ERS.21S or TEF4-ON	1SVR730100R0300 1SBN020112R1000	BEY96-4 + VM96-4	1SBN083913R2000 1SBN033405T1000	KM1 : 1 x CA4-10 (3) KM2 : 1 x CA4-10 1 x CA4-01 KM3 : 1 x CA4-01	1SBN010110R1010 1SBN010110R1010 1SBN010110R1001 1SBN010110R1001			
54...150	EF146-150	1SAX351001R1101	CT-ERS.21S	1SVR730100R0300	BEY140-4 + VM19	1SFN084413R1000 1SFN030300R1000	-	-			
54...150	EF146-150	1SAX351001R1101	CT-ERS.21S	1SVR730100R0300	BEY140-4 + VM19	1SFN084413R1000 1SFN030300R1000	-	-			
63...210	EF205-210	1SAX531001R1101	CT-ERS.21S	1SVR730100R0300	BEY190-4 + VM140/190	1SFN084813R1000 1SFN034403R1000	-	-			
63...210	EF205-210	1SAX531001R1101	CT-ERS.21S	1SVR730100R0300	BEY205-4 + VM19	1SFN085213R1000 1SFN030300R1000	-	-			
115...380	EF370-380	1SAX611001R1101	CT-ERS.21S	1SVR730100R0300	BEY265-4 + VM205/265	1SFN085413R1000 1SFN035203R1000	-	-			
115...380	EF370-380	1SAX611001R1101	CT-ERS.21S	1SVR730100R0300	BEY370-4 + VM19	1SFN085813R1000 1SFN030300R1000	-	-			
115...380	EF370-380	1SAX611001R1101	CT-ERS.21S	1SVR730100R0300	BEY370-4 + VM19	1SFN085813R1000 1SFN030300R1000	-	-			

3-pole contactors, for motor control and power switching



AC / DC Control supply			Type	AF09	AF12	AF16	AF26	AF30	AF38	AF40	AF52	AF65	AF80	AF96	
IEC	AC-3	Rated operational power $\theta \leq 60^\circ\text{C}$ for AF09 ... AF370 $\theta \leq 55^\circ\text{C}$ for AF400 ... AF2650	220 - 230 - 240 V	kW	2.2	3	4	6.5	9	11	11	15	18.5	22	25
			380 - 400 V	kW	4	5.5	7.5	11	15	18.5	18.5	22	30	37	45
			415 V	kW	4	5.5	9	11	15	18.5	22	30	37	45	55
			440 V	kW	4	5.5	9	15	18.5	22	22	30	37	45	55
			500 V	kW	5.5	7.5	9	15	18.5	22	22	30	37	45	55
			690 V	kW	5.5	7.5	9	15	18.5	22	22	30	37	45	55
			1000 V	kW	—	—	—	—	—	—	—	—	—	—	35
	Rated operational current	380 - 400 V	A	9	12	18	26	32	38	40	53	65	80	96	
	AC-1	Rated operational current	$\theta \leq 40^\circ\text{C}$, 690 V	A	25	28	30	45	50	50	70	100	105	125	130

UL / CSA	1-phase motor rating	120 V	hp	0.75	1	1.5	2	2	2	3	3	5	7.5	7.5	
		240 V	hp	1.5	2	3	3	5	5	7.5	10	15	15	20	20
	3-phase motor rating	200 - 208 V	hp	2	3	5	7.5	10	10	10	15	20	25	30	30
		220 - 240 V	hp	2	3	5	7.5	10	10	15	20	25	30	30	
		440 - 480 V	hp	5	7.5	10	15	20	25	30	40	50	60	60	
	550 - 600 V	hp	7.5	10	15	20	25	30	40	50	60	75	75		
	General use rating	600 V	A	25	28	30	45	50	50	60	80	90	105	115	
NEMA	NEMA Size			00	0	—	1	—	—	2	—	—	3	—	

Main accessories

Auxiliary contact blocks	Front mounting	CA4-10 (1 x N.O.) CA4-01 (1 x N.C.)
	Side mounting	CAL4-11 (1 x N.O. + 1 x N.C.)
Timers	Electronic	TEF4-ON TEF4-OFF
	Mechanical	VM4
Interlocking units	Mechanical / Electrical	VM96-4
	For reversing contactors	VEM4
Connection sets		BER16-4 BER38-4 BER65-4 BER96-4
Surge suppressors		Built-in surge protection

Overload relays

Thermal relays	Class 10 (Class 10A for TF140, TA200DU)	TF42 (0.10...38 A)	TF65 (22...67 A)	TF96 (40...96 A)
Electronic relays	Class 10E, 20E, 30E	EF19 (0.10...18.9 A)	EF19 (0.10...18.9 A) EF45 (9...45 A)	EF65 (20...70 A)

Manual motor starters

	Thermal / magnetic protection Class 10	MS116 (0.10...32 A) lcs up to 50 kA for class 10 A MS132 (0.10...32 A) lcs up to 100 kA	MS165 (10...65 A) lcs up to 100 kA (1)	MS5100 (40...100 A) lcs up to 50 kA MS495 (45...100 A) lcs up to 50 kA
	Magnetic only types	MO132 (0.16...32 A) lcs up to 100 kA	MO165 (16...65 A) lcs up to 100 kA (1)	MO5100 (70...100 A) lcs up to 36 kA MO496 (32...100 A) lcs up to 100 kA
Accessories	For contactor mounting	BEA16-4	BEA38-4	BEA65-4 (2)
				MO495 (63...100 A) lcs up to 50 kA

(1) MS165/MO165 are suitable for use with AF09 ... AF30 for North American applications.
(2) BEA65-4 suitable for MS165 and MO165 only.



AF116	AF140	AF146	AF190	AF205	AF265	AF305	AF370	AF400	AF460	AF580	AF750	AF1250	AF1350	AF1650	AF2050	AF2650
30	37	45	55	55	75	90	110	110	132	160	220	—	257	315	—	—
55	75	75	90	110	132	160	200	200	250	315	400	—	475	560	—	—
55	75	75	90	110	132	160	200	220	250	355	425	—	500	630	—	—
75	90	90	110	132	160	160	200	220	250	355	450	—	560	710	—	—
75	90	90	110	132	160	200	250	250	315	400	520	—	560	710	—	—
55	75	90	132	160	200	250	315	315	355	500	600	—	800	1000	—	—
—	—	75	110	132	132	132	132	220	280	355	400	—	—	—	—	—
116	140	146	190	205	265	305	370	400	460	580	750	—	860	1060	—	—
160	200	225	275	350	400	500	600	600	700	800	1050	1260	1350	1650	2050	2650

—	—	—	—	—	—	—	—	—	—	—	—	—	—	—	—	—
—	—	—	—	—	—	—	—	—	—	—	—	—	—	—	—	—
30	40	40	50	60	75	100	125	125	150	200	250	—	—	—	—	—
40	50	50	60	75	100	125	150	150	200	250	300	—	400	450	—	—
75	100	100	125	150	200	250	300	350	400	500	600	—	800	900	—	—
100	125	125	150	200	250	300	350	400	500	600	700	—	1000	1150	—	—
160	200	200	250	300	350	400	520	550	650	750	900	1210	1350	1650	2100	2700
—	4	—	—	—	5	—	—	—	6	—	7	—	—	8	—	—

CAL19-11 (1 x N.O. + 1 x N.C.)								CAL18-11 (1 x N.O. + 1 x N.C.)									
VM19 (for same size contactors)								VM750H VM750V				VM1650H					
BER140-4			BER205-4			BER370-4			BEM460-30			BEM750-30					
TF140DU (66...142 A) $\theta \leq 55^\circ\text{C}$			TA200DU (66...200 A) $\theta \leq 55^\circ\text{C}$			EF370 (115...380 A)			EF460 (150...500 A)			EF750 (250...800 A)			E1250DU (375...1250 A)		
EF146 (54...150 A)			EF205 (63...210 A)			EF370 (115...380 A)			EF460 (150...500 A)			EF750 (250...800 A)			E1250DU (375...1250 A)		

Short-circuit protection devices

MCCB and switch-fuses

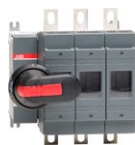

AF09 ... AF38 3-pole contactors

4 to 18.5 kW

AC / DC operated



AF09-30-10



AF26-30-00

Description

AF09 ... AF38 contactors are mainly used for controlling 3-phase motors and power circuits up to 690 V AC and 220 V DC. These contactors are of the block type design with 3 main poles.

- control circuit: AC or DC operated with electronic coil interface accepting a wide control voltage range (e.g. 100...250 V AC and DC), only 4 control voltage ranges covering 24...500V 50/60 Hz and 20...500 V DC
- can manage large control voltage variations
- reduced panel energy consumption
- very distinct closing and opening.
- built-in surge suppression
- add-on auxiliary contact blocks for front or side mounting and a wide range of accessories.

Ordering details

IEC		UL/CSA		Rated control circuit voltage		Auxiliary contacts fitted	Type (1)	Order code	Weight					
Rated operational power	current	3-phase motor rating	General use rating	Uc min. ... Uc max.										
400 V AC-3	$\theta \leq 40^\circ\text{C}$	480 V	600 V AC	V 50/60 Hz	V DC				Pkg (1 pce)					
kW	A	hp	A						kg					
4	25	5	25	24...60	-	(2)	1 0	AF09-30-10-41	1SBL137001R4110	0.270				
							0 1	AF09-30-01-41	1SBL137001R4101	0.270				
				48...130	48...130		1 0	AF09-30-10-12	1SBL137001R1210	0.270				
							0 1	AF09-30-01-12	1SBL137001R1201	0.270				
				100...250	100...250		1 0	AF09-30-10-13	1SBL137001R1310	0.270				
							0 1	AF09-30-01-13	1SBL137001R1301	0.270				
				250...500	250...500		1 0	AF09-30-10-14	1SBL137001R1410	0.310				
							0 1	AF09-30-01-14	1SBL137001R1401	0.310				
				5.5	28	7.5	28	24...60	-	(2)	1 0	AF12-30-10-41	1SBL157001R4110	0.270
											0 1	AF12-30-01-41	1SBL157001R4101	0.270
				48...130	48...130		1 0	AF12-30-10-12	1SBL157001R1210	0.270				
							0 1	AF12-30-01-12	1SBL157001R1201	0.270				
				100...250	100...250		1 0	AF12-30-10-13	1SBL157001R1310	0.270				
							0 1	AF12-30-01-13	1SBL157001R1301	0.270				
				250...500	250...500		1 0	AF12-30-10-14	1SBL157001R1410	0.310				
							0 1	AF12-30-01-14	1SBL157001R1401	0.310				
7.5	30	10	30	24...60	-	(2)	1 0	AF16-30-10-41	1SBL177001R4110	0.270				
							0 1	AF16-30-01-41	1SBL177001R4101	0.270				
				48...130	48...130		1 0	AF16-30-10-12	1SBL177001R1210	0.270				
							0 1	AF16-30-01-12	1SBL177001R1201	0.270				
				100...250	100...250		1 0	AF16-30-10-13	1SBL177001R1310	0.270				
							0 1	AF16-30-01-13	1SBL177001R1301	0.270				
				250...500	250...500		1 0	AF16-30-10-14	1SBL177001R1410	0.310				
							0 1	AF16-30-01-14	1SBL177001R1401	0.310				
				11	45	15	45	24...60	-	(2)	0 0	AF26-30-00-41	1SBL237001R4100	0.310
								48...130	48...130		0 0	AF26-30-00-12	1SBL237001R1200	0.310
				100...250	100...250		0 0	AF26-30-00-13	1SBL237001R1300	0.310				
				250...500	250...500		0 0	AF26-30-00-14	1SBL237001R1400	0.350				
15	50	20	50	24...60	-	(2)	0 0	AF30-30-00-41	1SBL277001R4100	0.310				
				48...130	48...130		0 0	AF30-30-00-12	1SBL277001R1200	0.310				
				100...250	100...250		0 0	AF30-30-00-13	1SBL277001R1300	0.310				
				250...500	250...500		0 0	AF30-30-00-14	1SBL277001R1400	0.350				
				18.5	50	25	50	24...60	-	(2)	0 0	AF38-30-00-41	1SBL297001R4100	0.310
				48...130	48...130		0 0	AF38-30-00-12	1SBL297001R1200	0.310				
				100...250	100...250		0 0	AF38-30-00-13	1SBL297001R1300	0.310				
				250...500	250...500		0 0	AF38-30-00-14	1SBL297001R1400	0.350				

(1) For other auxiliary contacts arrangements, please contact your ABB local sales organization.

(2) For 24...60 V 50/60 Hz - 20...60 V DC, use AF.Z-30...-21.

Main dimensions mm, inches

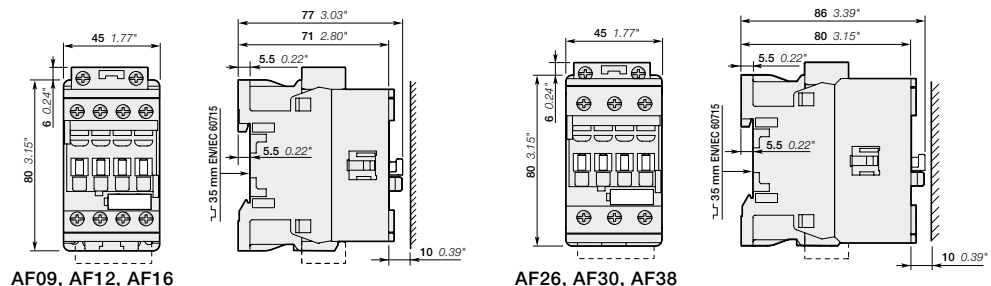

AF09Z ... AF38Z 3-pole contactors

4 to 18.5 kW

AC / DC operated - low consumption



AF09Z-30-10



AF26Z-30-00

Description

AF09Z ... AF38Z contactors are mainly used for controlling 3-phase motors and power circuits up to 690 V AC and 220 V DC. These contactors are of the block type design with 3 main poles.

- control circuit: AC or DC operated with electronic coil interface accepting a wide control voltage range (e.g. 100...250 V AC and DC), only 4 control voltage ranges covering 24...250 V 50/60 Hz and 12...250 V DC
- can manage large control voltage variations
- allow direct control by PLC-output ≥ 24 V DC 500 mA
- reduced panel energy consumption
- very distinct closing and opening
- can withstand short voltage dips and voltage sags (SEMI F47-0706 conditions of use on request).
- built-in surge suppression
- add-on auxiliary contact blocks for front or side mounting and a wide range of accessories.

Ordering details

IEC Rated power kW	operational current $\theta \leq 40^\circ\text{C}$ A	UL/CSA 3-phase motor rating 480 V hp	General use rating 600 V AC A	Rated control circuit voltage Uc min. ... Uc max.		Auxiliary contacts fitted	Type (1)	Order code	Weight Pkg (1 pce) kg
				V 50/60 Hz	V DC				
4	25	5	25	-	12...20	1 0	AF09Z-30-10-20	1SBL136001R2010	0.310
						0 1	AF09Z-30-01-20	1SBL136001R2001	0.310
						1 0	AF09Z-30-10-21	1SBL136001R2110	0.310
						0 1	AF09Z-30-01-21	1SBL136001R2101	0.310
						1 0	AF09Z-30-10-22	1SBL136001R2210	0.310
						0 1	AF09Z-30-01-22	1SBL136001R2201	0.310
						1 0	AF09Z-30-10-23	1SBL136001R2310	0.310
						0 1	AF09Z-30-01-23	1SBL136001R2301	0.310
5.5	28	7.5	28	-	12...20	1 0	AF12Z-30-10-20	1SBL156001R2010	0.310
						0 1	AF12Z-30-01-20	1SBL156001R2001	0.310
						1 0	AF12Z-30-10-21	1SBL156001R2110	0.310
						0 1	AF12Z-30-01-21	1SBL156001R2101	0.310
						1 0	AF12Z-30-10-22	1SBL156001R2210	0.310
						0 1	AF12Z-30-01-22	1SBL156001R2201	0.310
						1 0	AF12Z-30-10-23	1SBL156001R2310	0.310
						0 1	AF12Z-30-01-23	1SBL156001R2301	0.310
7.5	30	10	30	-	12...20	1 0	AF16Z-30-10-20	1SBL176001R2010	0.310
						0 1	AF16Z-30-01-20	1SBL176001R2001	0.310
						1 0	AF16Z-30-10-21	1SBL176001R2110	0.310
						0 1	AF16Z-30-01-21	1SBL176001R2101	0.310
						1 0	AF16Z-30-10-22	1SBL176001R2210	0.310
						0 1	AF16Z-30-01-22	1SBL176001R2201	0.310
						1 0	AF16Z-30-10-23	1SBL176001R2310	0.310
						0 1	AF16Z-30-01-23	1SBL176001R2301	0.310
11	45	15	45	-	12...20	0 0	AF26Z-30-00-20	1SBL236001R2000	0.350
						0 0	AF26Z-30-00-21	1SBL236001R2100	0.350
						0 0	AF26Z-30-00-22	1SBL236001R2200	0.350
						0 0	AF26Z-30-00-23	1SBL236001R2300	0.350
15	50	20	50	-	12...20	0 0	AF30Z-30-00-20	1SBL276001R2000	0.350
						0 0	AF30Z-30-00-21	1SBL276001R2100	0.350
						0 0	AF30Z-30-00-22	1SBL276001R2200	0.350
						0 0	AF30Z-30-00-23	1SBL276001R2300	0.350
18.5	50	25	50	-	12...20	0 0	AF38Z-30-00-20	1SBL296001R2000	0.350
						0 0	AF38Z-30-00-21	1SBL296001R2100	0.350
						0 0	AF38Z-30-00-22	1SBL296001R2200	0.350
						0 0	AF38Z-30-00-23	1SBL296001R2300	0.350

(1) For other auxiliary contacts arrangements, please contact your ABB local sales organization.

Note: Only AF.Z contactors with DC control voltage 12...20 V DC need to respect the connection polarities indicated close to the coil terminals: A1+ for the positive pole and A2- for the negative pole.

Main dimensions mm, inches

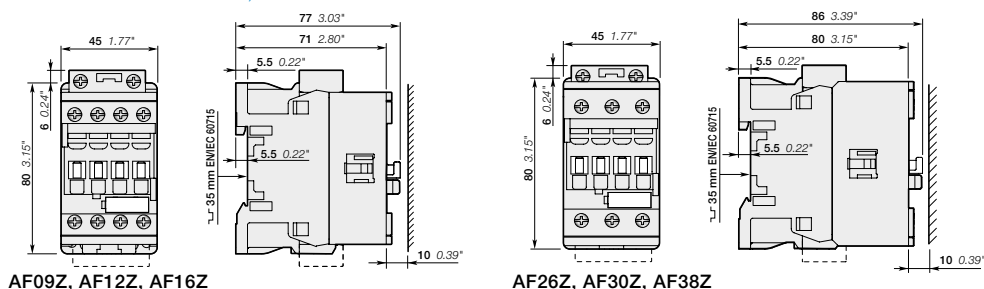

AF40 ... AF96 3-pole contactors

18.5 to 45 kW

AC / DC operated



AF40-30-00



AF80-30-00

Description

AF40 ... AF96 contactors are mainly used for controlling 3-phase motors and power circuits up to 690 V AC and 220 V DC. These contactors are of the block type design with 3 main poles.

- control circuit: AC or DC operated with electronic coil interface accepting a wide control voltage range (e.g. 100...250 V AC and DC), only 4 control voltage ranges covering 24...500 V 50/60 Hz and 20...500 V DC
- can manage large control voltage variations
- reduced panel energy consumption
- very distinct closing and opening.
- built-in surge suppression
- add-on auxiliary contact blocks for front or side mounting and a wide range of accessories.

Ordering details

IEC		UL / CSA		Rated control circuit voltage		Auxiliary contacts fitted	Type (1)	Order code	Weight
Rated operational power	current	3-phase motor rating	General use rating	Uc min. ... Uc max.					
400 V AC-3	AC-1	480 V	600 V AC	V 50/60 Hz	V DC			kg	
18.5	70	30	60	24...60	-	0 0	AF40-30-00-41	1SBL347001R4100	0.970
				24...60	20...60 (2)	0 0	AF40-30-00-11	1SBL347001R1100	0.970
				48...130	48...130	0 0	AF40-30-00-12	1SBL347001R1200	0.970
				100...250	100...250	0 0	AF40-30-00-13	1SBL347001R1300	0.950
				250...500	250...500	0 0	AF40-30-00-14	1SBL347001R1400	0.950
22	100	40	80	24...60	-	0 0	AF52-30-00-41	1SBL367001R4100	0.970
				24...60	20...60 (2)	0 0	AF52-30-00-11	1SBL367001R1100	0.970
				48...130	48...130	0 0	AF52-30-00-12	1SBL367001R1200	0.970
				100...250	100...250	0 0	AF52-30-00-13	1SBL367001R1300	0.950
				250...500	250...500	0 0	AF52-30-00-14	1SBL367001R1400	0.950
30	105	50	90	24...60	-	0 0	AF65-30-00-41	1SBL387001R4100	0.970
				24...60	20...60 (2)	0 0	AF65-30-00-11	1SBL387001R1100	0.970
				48...130	48...130	0 0	AF65-30-00-12	1SBL387001R1200	0.970
				100...250	100...250	0 0	AF65-30-00-13	1SBL387001R1300	0.950
				250...500	250...500	0 0	AF65-30-00-14	1SBL387001R1400	0.950
37	125	60	105	24...60	-	0 0	AF80-30-00-41	1SBL397001R4100	1.220
				24...60	20...60 (2)	0 0	AF80-30-00-11	1SBL397001R1100	1.220
				48...130	48...130	0 0	AF80-30-00-12	1SBL397001R1200	1.220
				100...250	100...250	0 0	AF80-30-00-13	1SBL397001R1300	1.170
				250...500	250...500	0 0	AF80-30-00-14	1SBL397001R1400	1.170
45	130	60	115	24...60	-	0 0	AF96-30-00-41	1SBL407001R4100	1.220
				24...60	20...60 (2)	0 0	AF96-30-00-11	1SBL407001R1100	1.220
				48...130	48...130	0 0	AF96-30-00-12	1SBL407001R1200	1.220
				100...250	100...250	0 0	AF96-30-00-13	1SBL407001R1300	1.170
				250...500	250...500	0 0	AF96-30-00-14	1SBL407001R1400	1.170

(1) For other auxiliary contacts arrangements, please contact your ABB local sales organization.

(2) AF...-30...-11 not suitable for direct control by PLC-output.

Main dimensions mm, inches

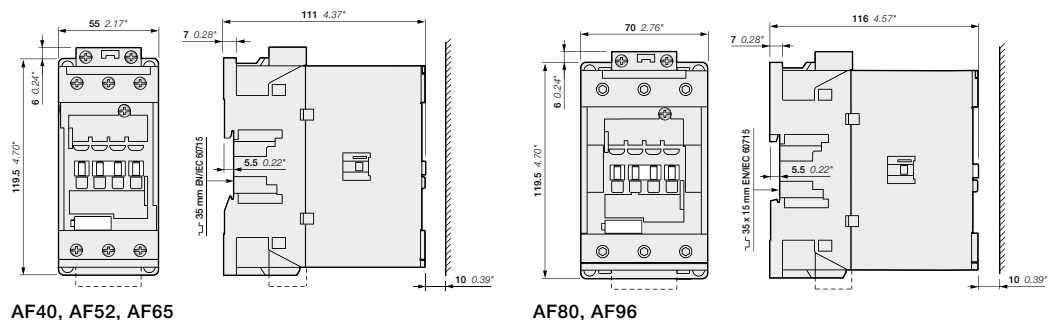

AF40, AF52, AF65

AF80, AF96

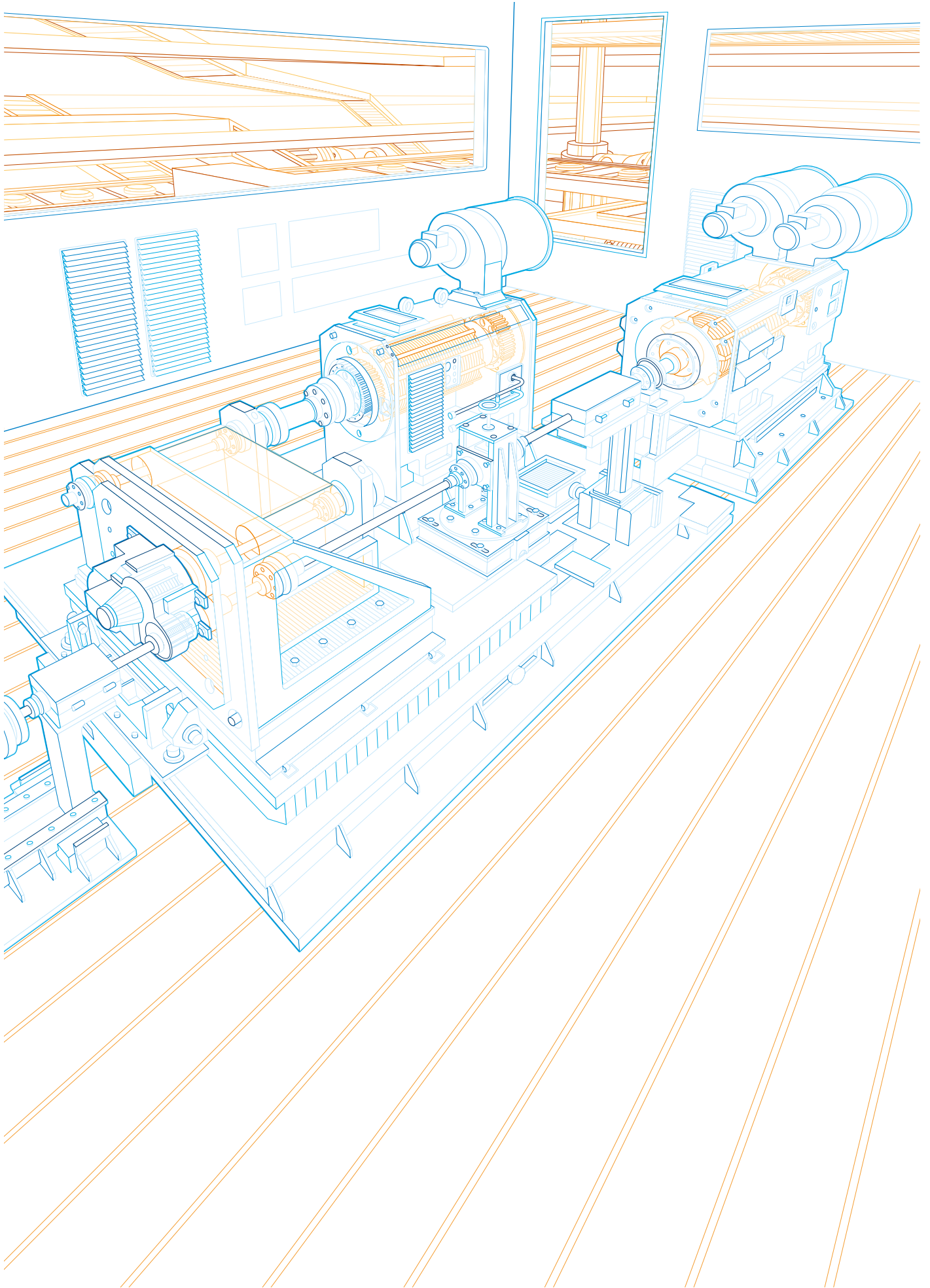

AF09 ... AF96 3-pole contactors

Main accessories

Contactor and main accessories (other accessories available)

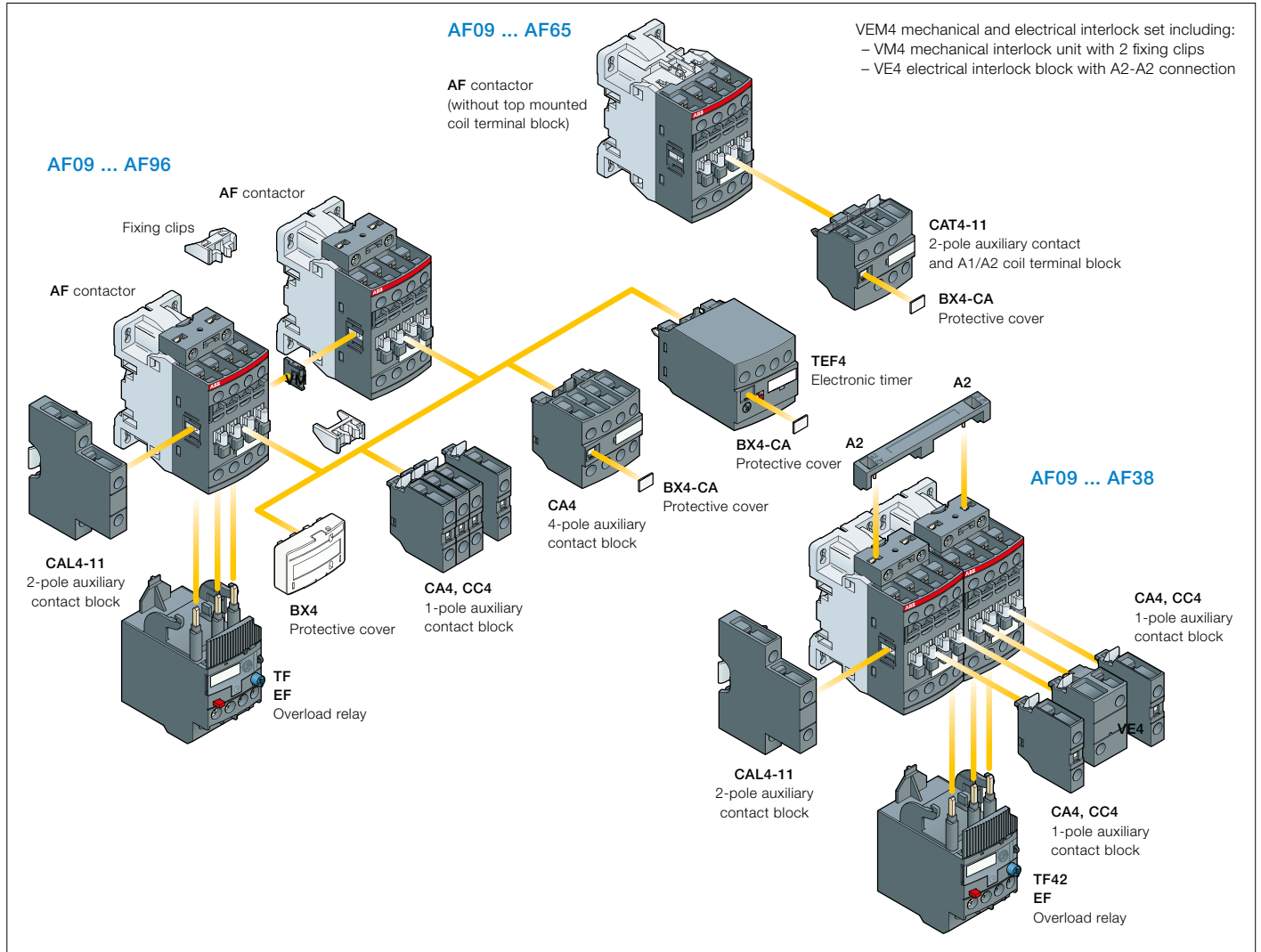

Main accessory fitting details

Many configurations of accessories are possible depending on whether these are front-mounted or side-mounted.

Contactor types	Main poles	Built-in auxiliary contacts	Front-mounted accessories					Side-mounted accessories			
			Auxiliary contact blocks			Electronic timer	Electrical and mechanical interlock set (between 2 contactors)	Auxiliary contact blocks			
			1-pole CA4			TEF4	VEM4	Left side	Right side		
			1-pole CC4	2-pole CAT4-11	4-pole CA4			2-pole CAL4-11			
			Max. N.C. built-in and add-on N.C. auxiliary contacts: 4 N.C. max. on positions 1, 2, 3, 4 and 3 N.C. max. on positions 1 ±30°, 5								
AF09 ... AF16	3	0	0	1	4 max.	or 1	or 1	or 1	-	+ 1	-
AF09 ... AF16	3	0	1	0	2 max.	or 1	-	or 1	-	+ 1	+ 1
AF26 ... AF38	3	0	0	0	3 max.	-	-	-	+ 1	+ 1	or 1
			Max. add-on N.C. auxiliary contacts: 6 N.C. max. on positions 1, 1 ±30°, 2, 3, 4, 5								
AF40 ... AF65	3	0	0	0	4 max.	or 1	or 1	or 1	-	+ 1	+ 1
AF80, AF96	3	0	0	0	4 max.	-	or 1	or 1	-	+ 1	+ 1

Overload relays fitting details (1)

Contactor types	Thermal overload relays	Electronic overload relays
AF09 ... AF38	TF42 (0.10...38 A)	EF19 (0.10...19 A)
AF26 ... AF38	TF42 (0.10...38 A)	EF45 (9...45 A)
AF40 ... AF65	TF65 (22...67 A)	EF65 (20...70 A)
AF80, AF96	TF96 (40...96 A)	EF96 (36...100 A)

The addition of an overload relay on the contactor does not prevent fitting of many other accessories as shown above.

(1) Direct mounting - No kit required.

AF09 ... AF96 3-pole contactors

Main accessories



CA4-10



CAL4-11



CA4-22E



CAT4-11E

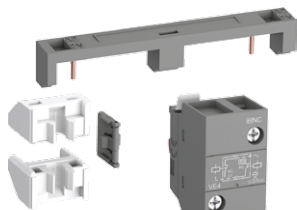

VEM4

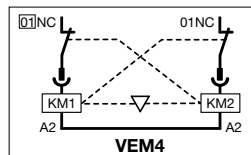

TEF4-ON

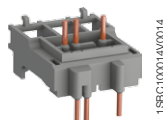

BEA16-4

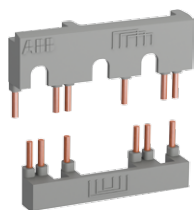

BER16-4

Ordering details (1)

For contactors	Auxiliary contacts	Type	Order code	Pkg qty	Weight (1 pce)
					kg

Front-mounted instantaneous auxiliary contact blocks

AF09 ... AF96	1 0	--	CA4-10	1SBN010110R1010	1	0.014
	1 0	--	CA4-10-T	1SBN010110T1010	10	0.014
	0 1	--	CA4-01	1SBN010110R1001	1	0.014
	0 1	--	CA4-01-T	1SBN010110T1001	10	0.014
AF09 ... AF16...-30-10	2 2	--	CA4-22M	1SBN010140R1122	1	0.055
AF26 ... AF96...-30-00	2 2	--	CA4-22E	1SBN010140R1022	1	0.055
AF09 ... AF16...-30-01	2 2	--	CA4-22U	1SBN010140R1322	1	0.055

Front-mounted auxiliary contact blocks with N.O. leading contact and N.C. lagging contact

AF09 ... AF96	--	1 0	CC4-10	1SBN010111R1010	1	0.014
	--	0 1	CC4-01	1SBN010111R1001	1	0.014

Side-mounted instantaneous auxiliary contact blocks

AF09 ... AF96	1 1	--	CAL4-11	1SBN010120R1011	1	0.040
	1 1	--	CAL4-11-T	1SBN010120T1011	10	0.040

Front-mounted instantaneous auxiliary contact and A1/A2 coil terminal blocks

AF09 ... AF16...-30-10	1 1	--	CAT4-11M	1SBN010151R1111	1	0.040
AF26 ... AF65...-30-00	1 1	--	CAT4-11E	1SBN010151R1011	1	0.040
AF09 ... AF16...-30-01	1 1	--	CAT4-11U	1SBN010151R1311	1	0.040

Note: CAT4 not suitable for AF..Z contactors with DC control voltage 12...20 V DC.

Mechanical interlock unit

AF09 ... AF38			VM4	1SBN030105T1000	10	0.005
AF40 ... AF96			VM96-4	1SBN033405T1000	10	0.006

Note: VM4 and VM96-4 include 2 fixing clips (BB4) to maintain together both contactors.

Mechanical and electrical interlock set

AF09 ... AF16	0 2	--	VEM4	1SBN030111R1000	1	0.035
AF26 ... AF38						

Note: - VEM4 includes a VM4 mechanical interlock unit with 2 fixing clips (BB4), a VE4 electrical interlock block. VE4 block must be used with A2-A2 connection to respect the electrical connection diagram.
- VEM4 not suitable for AF..Z contactors with DC control voltage 12...20 V DC.

For contactors	Time delay range	Delay type	Auxiliary contacts	Type	Order code	Pkg qty	Weight (1 pce)
	selected by switch						kg

Electronic timers

AF09 ... AF96	0.1...1 s	ON-delay	1 1	TEF4-ON	1SBN020112R1000	1	0.065
	1...10 s						
	10...100 s	OFF-delay	1 1	TEF4-OFF	1SBN020114R1000	1	0.065

Note: Rated control circuit voltage Uc 24...240 V 50/60 Hz or DC.

Connecting links with manual motor starters

AF09 ... AF16	with	MS116-0.16 ... MS116-25, MS132-0.16 ... MS132-25		BEA16-4	1SBN081306T1000	10	0.025
AF26 ... AF38	with	MS116-0.16 ... MS116-16, MS132-0.16 ... MS132-10		BEA26-4	1SBN082306T1000	10	0.025
	with	MS116-20 ... MS116-32, MS132-12 ... MS132-32		BEA38-4	1SBN082306T2000	10	0.030
AF40 ... AF65	with	MS165-16 ... MS165-65		BEA65-4	1SBN083406R1000	1	0.090

Connection sets for reversing contactors

AF09 ... AF16				BER16-4	1SBN081311R1000	1	0.045
AF26 ... AF38				BER38-4	1SBN082311R1000	1	0.100
AF40 ... AF65				BER65-4	1SBN083411R1000	1	0.175
AF80 ... AF96				BER96-4	1SBN083911R1000	1	0.250

Connection sets for star-delta starting

AF09 ... AF16	With or without VM4			BEY16-4	1SBN081313R2000	1	0.050
AF26 ... AF38	With or without VM4			BEY38-4	1SBN082713R2000	1	0.110
AF40 ... AF65	With or without VM96-4			BEY65-4	1SBN083413R2000	1	0.200
AF80 ... AF96	With or without VM96-4			BEY96-4	1SBN083913R2000	1	0.250

(1) For more information, refer to main catalog "Accessories" section.

AF116 ... AF146 3-pole contactors

55 to 75 kW

AC / DC operated with 1 N.O. + 1 N.C. auxiliary contacts



AF146-30-11

1SFC101001V0001



AF146-30-11B

1SFC101008V0001

Description

AF116 ... AF146 contactors are mainly used for controlling 3-phase motors and power circuits up to 690 V AC, AF146 up to 1000 V AC and AF116 ... AF146 up to 260 V DC. These contactors are of the block type design with 3 main poles.

- control circuit: AC or DC operated with electronic coil interface accepting a wide control voltage range (e.g. 100...250 V AC and DC), only 4 coils to cover control voltages between 24...500 V 50/60 Hz and 20...500 V DC
- can manage large control voltage variations
- reduced panel energy consumption
- very distinct closing and opening
- can withstand short voltage dips and voltage sags (SEMI F47 conditions of use on request).
- built-in surge suppression
- add-on auxiliary contact blocks for side mounting and a wide range of accessories.

Ordering details

IEC	UL / CSA		Rated control circuit voltage	Auxiliary contacts fitted	Type (1)	Order code	Weight
Rated operational power	current	3-phase motor rating	Uc min. ... Uc max.				Pkg (1 pce)
400 V AC-3	AC-1	480 V	V 50/60 Hz; V DC				kg
kW	A	hp	A				

For connection with built-in cable clamps

Rated power (kW)	Rated current (A)	3-phase motor rating (hp)	General use rating (A)	Uc min. (V)	Uc max. (V)	Coils	Type	Order code	Weight (kg)
55	160	75	160	24...60	20...60	1 1	AF116-30-11-11	1SFL427001R1111	1.750
				48...130	48...130	1 1	AF116-30-11-12	1SFL427001R1211	1.750
				100...250	100...250	1 1	AF116-30-11-13	1SFL427001R1311	1.750
				250...500	250...500	1 1	AF116-30-11-14	1SFL427001R1411	1.750
75	200	100	200	24...60	20...60	1 1	AF140-30-11-11	1SFL447001R1111	1.750
				48...130	48...130	1 1	AF140-30-11-12	1SFL447001R1211	1.750
				100...250	100...250	1 1	AF140-30-11-13	1SFL447001R1311	1.750
				250...500	250...500	1 1	AF140-30-11-14	1SFL447001R1411	1.750
75	225	100	200	24...60	20...60	1 1	AF146-30-11-11	1SFL467001R1111	1.750
				48...130	48...130	1 1	AF146-30-11-12	1SFL467001R1211	1.750
				100...250	100...250	1 1	AF146-30-11-13	1SFL467001R1311	1.750
				250...500	250...500	1 1	AF146-30-11-14	1SFL467001R1411	1.750

With bar connections

Rated power (kW)	Rated current (A)	3-phase motor rating (hp)	General use rating (A)	Uc min. (V)	Uc max. (V)	Coils	Type	Order code	Weight (kg)
55	160	75	160	24...60	20...60	1 1	AF116-30-11B-11	1SFL427002R1111	1.500
				48...130	48...130	1 1	AF116-30-11B-12	1SFL427002R1211	1.500
				100...250	100...250	1 1	AF116-30-11B-13	1SFL427002R1311	1.500
				250...500	250...500	1 1	AF116-30-11B-14	1SFL427002R1411	1.500
75	200	100	200	24...60	20...60	1 1	AF140-30-11B-11	1SFL447002R1111	1.500
				48...130	48...130	1 1	AF140-30-11B-12	1SFL447002R1211	1.500
				100...250	100...250	1 1	AF140-30-11B-13	1SFL447002R1311	1.500
				250...500	250...500	1 1	AF140-30-11B-14	1SFL447002R1411	1.500
75	225	100	200	24...60	20...60	1 1	AF146-30-11B-11	1SFL467002R1111	1.500
				48...130	48...130	1 1	AF146-30-11B-12	1SFL467002R1211	1.500
				100...250	100...250	1 1	AF146-30-11B-13	1SFL467002R1311	1.500
				250...500	250...500	1 1	AF146-30-11B-14	1SFL467002R1411	1.500

(1) For other auxiliary contacts arrangements, please contact your ABB local sales organization.

Main dimensions mm, inches

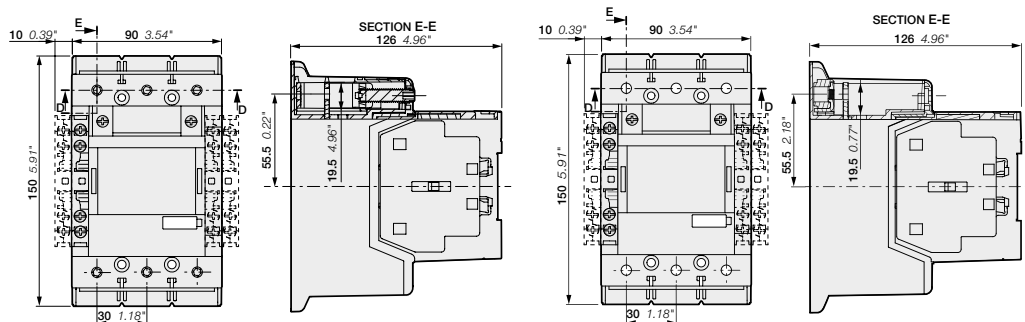

AF116, AF140, AF146-30-11

AF116, AF140, AF146-30-11B

AF116 ... AF146 3-pole contactors with built-in PLC interface

55 to 75 kW

AC / DC operated with 1 N.O. + 1 N.C. auxiliary contacts



AF146-30-11



AF146-30-11B

Description

AF116 ... AF146 contactors are mainly used for controlling 3-phase motors and power circuits up to 690 V AC, AF146 up to 1000 V AC and AF116 ... AF146 up to 260 V DC. These contactors are of the block type design with 3 main poles.

- control circuit: AC or DC operated with electronic coil interface accepting a wide control voltage range (e.g. 100...250 V AC and DC), only 2 coils to cover control voltages between 100...500 V 50/60 Hz and 100...500 V DC
- can manage large control voltage variations
- reduced panel energy consumption
- very distinct closing and opening
- can withstand short voltage dips and voltage sags (SEMI F47 conditions of use on request).
- built-in surge suppression
- add-on auxiliary contact blocks for side mounting and a wide range of accessories.

Ordering details

IEC		UL / CSA		Rated control circuit voltage		Auxiliary contacts fitted	Type (1)	Order code	Weight
Rated power	operational current $\theta \leq 40^\circ\text{C}$	3-phase motor rating	General use rating	Uc min. ...	Uc max.				Pkg (1 pce)
kW	A	hp	A	V 50/60 Hz	V DC				kg
400 V AC-3	AC-1	480 V	600 V AC						

For connection with built-in cable clamps

55	160	75	160	100...250	100...250	1	1	AF116-30-11-33	1SFL427001R3311	1.750
				250...500	250...500	1	1	AF116-30-11-34	1SFL427001R3411	1.750
75	200	100	200	100...250	100...250	1	1	AF140-30-11-33	1SFL447001R3311	1.750
				250...500	250...500	1	1	AF140-30-11-34	1SFL447001R3411	1.750
75	225	100	200	100...250	100...250	1	1	AF146-30-11-33	1SFL467001R3311	1.750
				250...500	250...500	1	1	AF146-30-11-34	1SFL467001R3411	1.750

With bar connections

55	160	75	160	100...250	100...250	1	1	AF116-30-11B-33	1SFL427002R3311	1.500
				250...500	250...500	1	1	AF116-30-11B-34	1SFL427002R3411	1.500
75	200	100	200	100...250	100...250	1	1	AF140-30-11B-33	1SFL447002R3311	1.500
				250...500	250...500	1	1	AF140-30-11B-34	1SFL447002R3411	1.500
75	225	100	200	100...250	100...250	1	1	AF146-30-11B-33	1SFL467002R3311	1.500
				250...500	250...500	1	1	AF146-30-11B-34	1SFL467002R3411	1.500

(1) For other auxiliary contacts arrangements, please contact your ABB local sales organization.

AF116 ... AF146 are equipped with low voltage inputs for control, for example by a PLC.

Control inputs

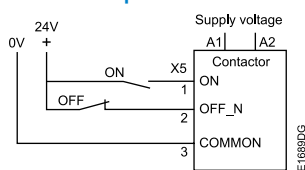

Main dimensions mm, inches

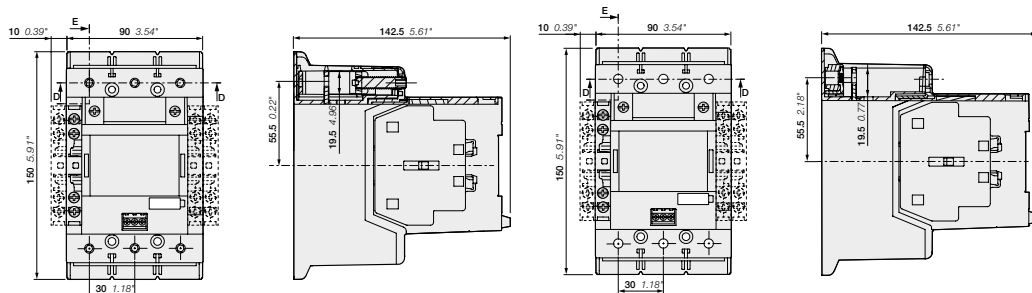

AF116, AF140, AF146-30-11

AF116, AF140, AF146-30-11B

AF190 ... AF370 3-pole contactors

90 to 200 kW

AC / DC operated with 1 N.O. + 1 N.C. auxiliary contacts



AF205-30-11

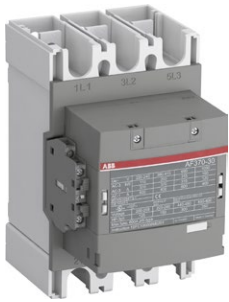

AF370-30-11

Description

AF190 ... AF370 contactors are mainly used for controlling 3-phase motors and power circuits up to 1000 V AC and up to 340 V DC. These contactors are of the block type design with 3 main poles.

- control circuit: AC or DC operated with electronic coil interface accepting a wide control voltage range (e.g. 100...250 V AC and DC), only 4 coils to cover control voltages between 24...500 V 50/60 Hz and 20...500 V DC
 - can manage large control voltage variations
 - reduced panel energy consumption
 - very distinct closing and opening
 - can withstand short voltage dips and voltage sags (SEMI F47 conditions of use on request).
- built-in surge suppression
- add-on auxiliary contact blocks for side mounting and a wide range of accessories.

Ordering details

IEC	UL / CSA	Rated control circuit voltage	Auxiliary contacts fitted	Type (1)	Order code	Weight			
Rated operational power	3-phase motor rating	Uc min. ... Uc max.				Pkg (1 pce)			
400 V AC-3	480 V	V 50/60 Hz: V DC				kg			
kW	hp	A	A						
90	125	275	250	24...60	20...60	1 1	AF190-30-11-11	1SFL487002R1111	3,000
				48...130	48...130	1 1	AF190-30-11-12	1SFL487002R1211	3,000
				100...250	100...250	1 1	AF190-30-11-13	1SFL487002R1311	3,000
				250...500	250...500	1 1	AF190-30-11-14	1SFL487002R1411	3,000
110	150	350	300	24...60	20...60	1 1	AF205-30-11-11	1SFL527002R1111	3,000
				48...130	48...130	1 1	AF205-30-11-12	1SFL527002R1211	3,000
				100...250	100...250	1 1	AF205-30-11-13	1SFL527002R1311	3,000
				250...500	250...500	1 1	AF205-30-11-14	1SFL527002R1411	3,000
132	200	400	350	24...60	20...60	1 1	AF265-30-11-11	1SFL547002R1111	4,640
				48...130	48...130	1 1	AF265-30-11-12	1SFL547002R1211	4,640
				100...250	100...250	1 1	AF265-30-11-13	1SFL547002R1311	4,640
				250...500	250...500	1 1	AF265-30-11-14	1SFL547002R1411	4,640
160	250	500	400	24...60	20...60	1 1	AF305-30-11-11	1SFL587002R1111	4,640
				48...130	48...130	1 1	AF305-30-11-12	1SFL587002R1211	4,640
				100...250	100...250	1 1	AF305-30-11-13	1SFL587002R1311	4,640
				250...500	250...500	1 1	AF305-30-11-14	1SFL587002R1411	4,640
200	300	600	520	24...60	20...60	1 1	AF370-30-11-11	1SFL607002R1111	4,640
				48...130	48...130	1 1	AF370-30-11-12	1SFL607002R1211	4,640
				100...250	100...250	1 1	AF370-30-11-13	1SFL607002R1311	4,640
				250...500	250...500	1 1	AF370-30-11-14	1SFL607002R1411	4,640

(1) For other auxiliary contacts arrangements, please contact your ABB local sales organization.

Main dimensions mm, inches

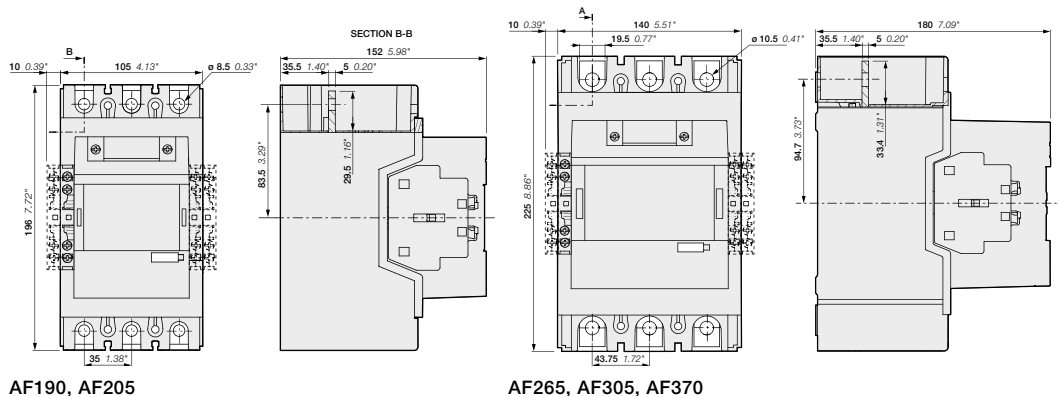

AF190, AF205

AF265, AF305, AF370

1SFC101091C0201 - Rev. E

AF190 ... AF370 3-pole contactors with built-in PLC interface

90 to 200 kW

AC / DC operated with 1 N.O. + 1 N.C. auxiliary contacts

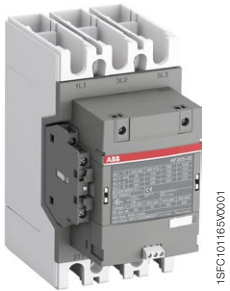

1SFC101165W0001

AF205-30-11

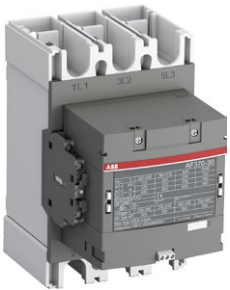

1SFC101153W0001

AF370-30-11

Description

AF190 ... AF370 contactors are mainly used for controlling 3-phase motors and power circuits up to 1000 V AC and up to 340 V DC. These contactors are of the block type design with 3 main poles.

- control circuit: AC or DC operated with electronic coil interface accepting a wide control voltage range (e.g. 100...250 V AC and DC), only 2 coils to cover control voltages between 100...500 V 50/60 Hz and 100...500 V DC
- can manage large control voltage variations
- reduced panel energy consumption
- very distinct closing and opening
- can withstand short voltage dips and voltage sags (SEMI F47 conditions of use on request).
- built-in surge suppression
- add-on auxiliary contact blocks for side mounting and a wide range of accessories.

Ordering details

IEC		UL / CSA		Rated control circuit voltage		Auxiliary contacts fitted		Type (1)	Order code	Weight
Rated operational power	current $\theta \leq 40^\circ\text{C}$	3-phase motor rating	General use rating	Uc min. ... Uc max.		I L				Pkg (1 pce)
400 V AC-3	AC-1	hp	A	V 50/60 Hz	V DC					kg
90	275	125	250	100...250	100...250	1	1	AF190-30-11-33	1SFL487002R3311	3.000
				250...500	250...500	1	1	AF190-30-11-34	1SFL487002R3411	3.000
110	350	150	300	100...250	100...250	1	1	AF205-30-11-33	1SFL527002R3311	3.000
				250...500	250...500	1	1	AF205-30-11-34	1SFL527002R3411	3.000
132	400	200	350	100...250	100...250	1	1	AF265-30-11-33	1SFL547002R3311	4.640
				250...500	250...500	1	1	AF265-30-11-34	1SFL547002R3411	4.640
160	500	250	400	100...250	100...250	1	1	AF305-30-11-33	1SFL587002R3311	4.640
				250...500	250...500	1	1	AF305-30-11-34	1SFL587002R3411	4.640
200	600	300	520	100...250	100...250	1	1	AF370-30-11-33	1SFL607002R3311	4.640
				250...500	250...500	1	1	AF370-30-11-34	1SFL607002R3411	4.640

(1) For other auxiliary contacts arrangements, please contact your ABB local sales organization.

AF190 ... AF370 are equipped with low voltage inputs for control, for example by a PLC.

Control inputs

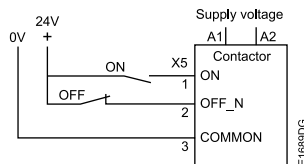

Main dimensions mm, inches

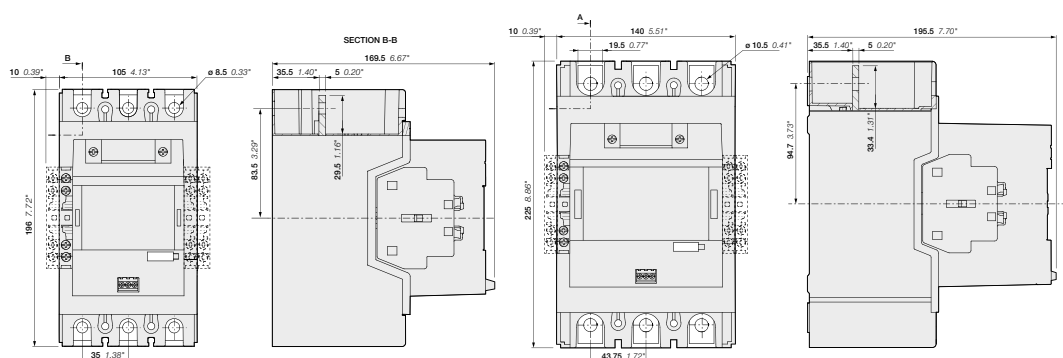

AF190, AF205

AF265, AF305, AF370

AF116 ... AF370 3-pole contactors with 1 N.O. + 1 N.C. auxiliary contacts Main accessories

Main accessories (other accessories available)

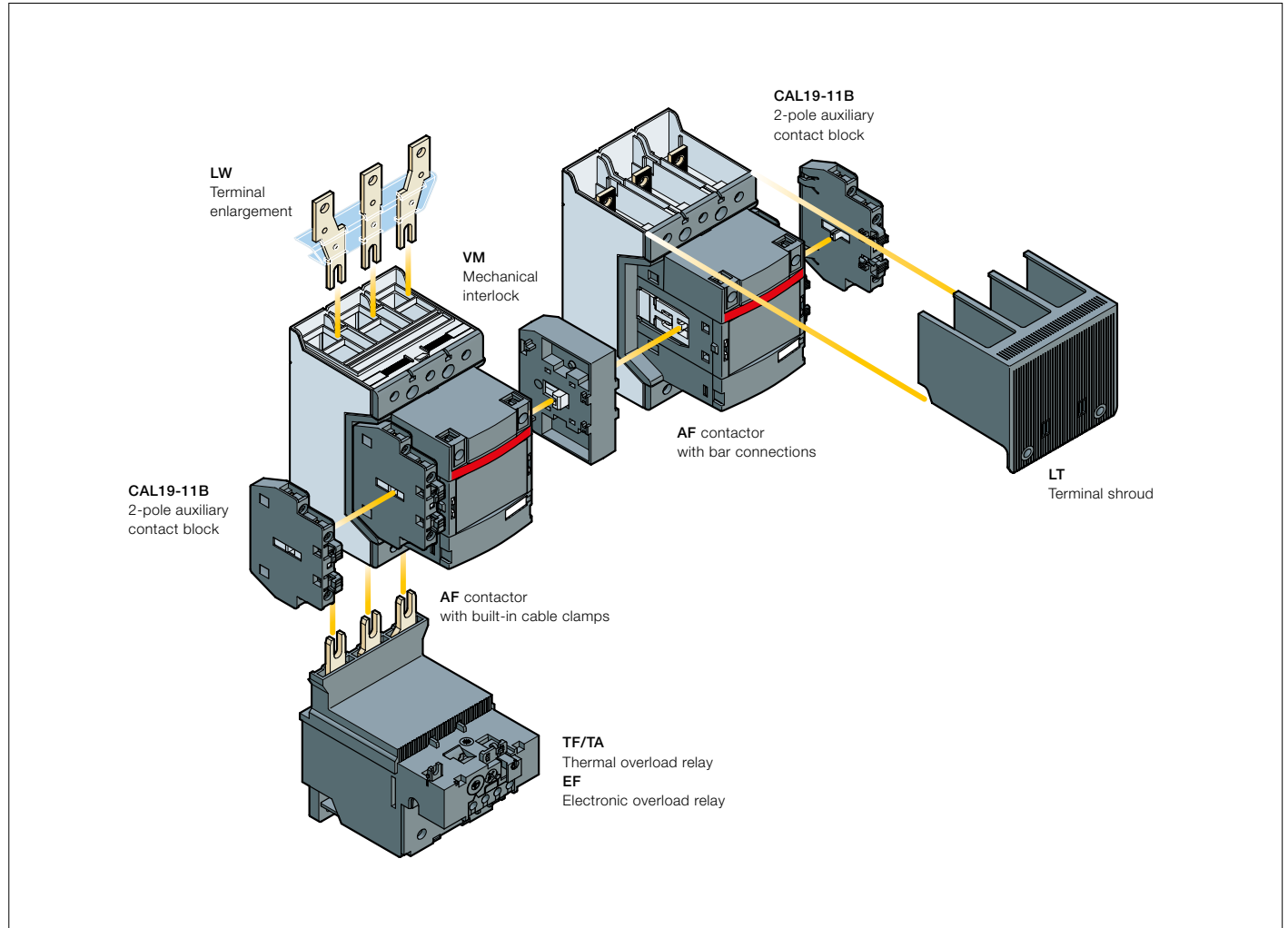

Main accessory fitting details

Contactor types	Main poles	Available auxiliary contacts	Side-mounted accessories		
			Auxiliary contact blocks		Mechanical interlock units (between two contactors)
			CAL19-11	CAL19-11B	
AF116 ... AF370	3	0 1 1	1 x CAL19-11	+ 2 x CAL19-11B	-
AF116 ... AF370	3	0 1 1	-	+ 2 x CAL19-11B (1)	+ VM... (2)

(1) Total number of auxiliary contact blocks for the two contactors.

(2) Interlock type, according to the contactor ratings (see "Accessories").

Overload relays fitting details (1)

Contactor types	Thermal overload relays	Electronic overload relays
	AF116 ... AF140	TF140DU (66...142 A)
AF146	-	EF146 (54...150 A)
AF190, AF205	TA200DU (66...200 A)	EF205 (63...210 A)
AF265 ... AF370	-	EF370 (115...380 A)

The addition of a thermal or electronic overload relay on the contactor does not prevent fitting of many other accessories as shown in "Main accessory fitting details" table.

(1) Direct mounting - No kit required.

AF116 ... AF370 3-pole contactors with 1 N.O. + 1 N.C. auxiliary contacts Main accessories



1SFC101071V0001

CAL19-11

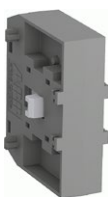

1SFC101035V0001

VM19



1SFC101041V0001

LT370-30C



1SFC101049V0001

LX140

Ordering details (1)

For contactors	Auxiliary contacts	Type	Order code	Pkg qty	Weight (1 pce)
					kg

Side-mounted instantaneous auxiliary contact blocks

AF116 ... AF370	1	1	CAL19-11	1SFN010820R1011	2	0.050
	1	1	CAL19-11B	1SFN010820R3311	2	0.050

Mechanical interlock unit

AF116 ... AF370		VM19	1SFN030300R1000	1	0.054
AF116 ... AF146 and AF190, AF205		VM140/190	1SFN034403R1000	1	0.088
AF190, AF205 and AF265 ... AF370		VM205/265	1SFN035203R1000	1	0.090

Terminal shrouds

AF116 ... AF146, with compression lugs		LT140-30L	1SFN124203R1000	2	0.070
AF190, AF205, with cable clamps		LT205-30C	1SFN124801R1000	2	0.050
AF190, AF205, with compression lugs		LT205-30L	1SFN124803R1000	2	0.220
AF190, AF205, with shorting bar or between contactor and TOL/EOL in DOL-starters		LT205-30Y	1SFN124804R1000	1	0.050
AF265 ... AF370, with cable clamps		LT370-30C	1SFN125401R1000	2	0.035
AF265 ... AF370, with compression lugs		LT370-30L	1SFN125403R1000	2	0.280
AF265 ... AF370, with shorting bar or between contactor and TOL/EOL in DOL-starters		LT370-30Y	1SFN125404R1000	1	0.075
AF265 ... AF370, for use with extending cable clamps, ATK300/2 and OZXB4		LT370-30D	1SFN125406R1000	1	0.150

For contactors	Dimensions		Type	Order code	Pkg qty	Weight (1 pce)
	hole Ø mm	bar mm				kg

Terminal enlargements

AF116...AF146	6.5	13 x 3	LW140	1SFN074207R1000	1	0.115
AF190...AF205	10.5	17.5 x 5	LW205	1SFN074807R1000	1	0.260
AF265...AF370	10.5	20 x 5	LW370	1SFN075407R1000	1	0.340

Terminal extension

AF116...AF146	6.5	13 x 3	LX140	1SFN074210R1000	1	0.072
AF190...AF250	8.5	17.5 x 5	LX205	1SFN074810R1000	1	0.180
AF265...AF370	10.5	20 x 5	LX370	1SFN075410R1000	1	0.234

(1) For more information, refer to main catalog "Accessories" section.

AF400 ... AF750 3-pole contactors

200 to 400 kW

AC / DC operated with 1 N.O. + 1 N.C. auxiliary contacts



AF460-30-11

1SFC101025V0001



AF750-30-11

1SFC101025V0001

Description

AF400 ... AF750 contactors are mainly used for controlling 3-phase motors and power circuits up to 1000 V AC or 600 V DC (2). These contactors are of the block type design with 3 main poles.

- control circuit: AC or DC operated with electronic coil interface accepting a wide control voltage range (e.g. 100...250 V AC and DC), only 4 coils to cover control voltages between 48...500 V 50/60 Hz and 24...500 V DC
- can manage large control voltage variations
- reduced panel energy consumption
- very distinct closing and opening
- can withstand short voltage dips and voltages sags (SEMI F47 conditions of use on request).
- built-in surge suppression
- add-on auxiliary contact blocks for side mounting and a wide range of accessories.

Ordering details

IEC Rated operational power 400 V AC-3 kW	UL/CSA 3-phase General use rating 600 V AC 690 V AC-1 480 V	3-phase motor rating hp	General use rating A	Rated control circuit voltage Uc min. ... Uc max.		Auxiliary contacts fitted	Type	Order code	Weight Pkg (1 pce) kg
				V 50/60 Hz	V DC				
200	600	350	550	-	24...60	1 1	AF400-30-11	1SFL577001R6811 (1)	12.000
				48...130	48...130	1 1	AF400-30-11	1SFL577001R6911	12.000
				100...250	100...250	1 1	AF400-30-11	1SFL577001R7011	12.000
				250...500	250...500	1 1	AF400-30-11	1SFL577001R7111	12.000
250	700	400	650	-	24...60	1 1	AF460-30-11	1SFL597001R6811 (1)	12.000
				48...130	48...130	1 1	AF460-30-11	1SFL597001R6911	12.000
				100...250	100...250	1 1	AF460-30-11	1SFL597001R7011	12.000
				250...500	250...500	1 1	AF460-30-11	1SFL597001R7111	12.000
315	800	500	750	-	24...60	1 1	AF580-30-11	1SFL617001R6811 (1)	15.000
				48...130	48...130	1 1	AF580-30-11	1SFL617001R6911	15.000
				100...250	100...250	1 1	AF580-30-11	1SFL617001R7011	15.000
				250...500	250...500	1 1	AF580-30-11	1SFL617001R7111	15.000
400	1050	600	900	-	24...60	1 1	AF750-30-11	1SFL637001R6811 (1)	15.000
				48...130	48...130	1 1	AF750-30-11	1SFL637001R6911	15.000
				100...250	100...250	1 1	AF750-30-11	1SFL637001R7011	15.000
				250...500	250...500	1 1	AF750-30-11	1SFL637001R7111	15.000

(1) The connection polarities indicated close to the coil terminals must be respected: A1 for the positive pole and A2 for the negative pole.
 (2) Up to 850 V DC for AF580, AF750.

AF400 ... AF750 are equipped with low voltage inputs for control, for example by a PLC.

Control inputs

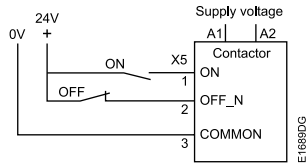

Main dimensions mm, inches

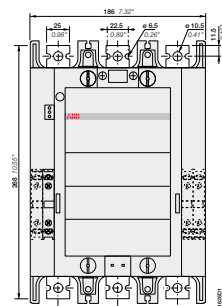

AF400, AF460

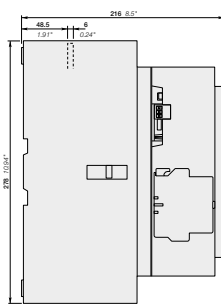

AF580, AF750

1SFC101013C0201 - Rev. A

AF1250 ... AF2650 3-pole contactors

475 to 560 kW and 1260 to 2650 A AC-1

AC / DC operated with 1 N.O. + 1 N.C. auxiliary contacts



AF1250-30-11

Description

AF1250 ... AF2050 contactors are mainly used for controlling power circuits up to 1000 V AC or 850 V DC, AF2650 for controlling power up to 1000 V AC. These contactors are of the block type design with 3 main poles.

- control circuit: AC or DC operated with electronic coil interface accepting a wide control voltage range (e.g. 100...250 V AC and DC)
- only 4 coils for AF1250 to cover control voltages between 48...500 V 50/60 Hz and 24...500 V DC
- only 1 coil for AF1350 ... AF2650 to cover control voltages between 100...250 V 50/60 Hz and 100...250 V DC
- can manage large control voltage variations
- reduced panel energy consumption
- very distinct closing and opening
- can withstand short voltage dips and voltages sags (SEMI F47 conditions of use on request).
- built-in surge suppression
- add-on auxiliary contact blocks for side mounting and a wide range of accessories.

Ordering details

IEC		UL/CSA		Rated control circuit voltage U _c		Auxiliary contacts fitted		Type	Order code	Weight
Rated operational power	3-phase motor current θ ≤ 40 °C	3-phase motor rating	General use rating	(1)		1 1				Pkg (1 pce)
kW	A	hp	A	V 50/60 Hz	V DC	1 1				kg
-	1260	-	1210	-	24...60	1	1	AF1250-30-11	1SFL647001R6811 (1)	16.000
				48...130	48...130	1	1	AF1250-30-11	1SFL647001R6911	16.000
				100...250	100...250	1	1	AF1250-30-11	1SFL647001R7011	16.000
				250...500	250...500	1	1	AF1250-30-11	1SFL647001R7111	16.000
475	1350	800	1350	100...250	100...250	1	1	AF1350-30-11	1SFL657001R7011	34.000
560	1650	900	1650	100...250	100...250	1	1	AF1650-30-11	1SFL677001R7011	35.000
-	2050	-	2100	100...250	100...250	1	1	AF2050-30-11	1SFL707001R7011	35.000
-	2650	-	2700	100...250	100...250	1	1	AF2650-30-11	1SFL667001R7011	45.000

(1) The connection polarities indicated close to the coil terminals must be respected: A1 for the positive pole and A2 for the negative pole.
 (2) AF2650: Maximum operational voltage = 1000 V according to UL / CSA.



AF2650-30-11

AF1250 ... AF2650 are equipped with low voltage inputs for control, for example by a PLC

Control inputs

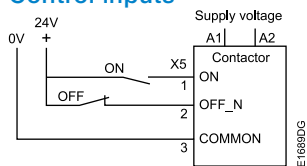

	AF1350, AF1650, AF2050	AF2650
A	392 mm / 15.43"	422 mm / 16.61"
B	47 mm / 1.85"	53 mm / 2.09"
C	10 mm / 0.39"	25 mm / 0.98"

Main dimensions mm, inches

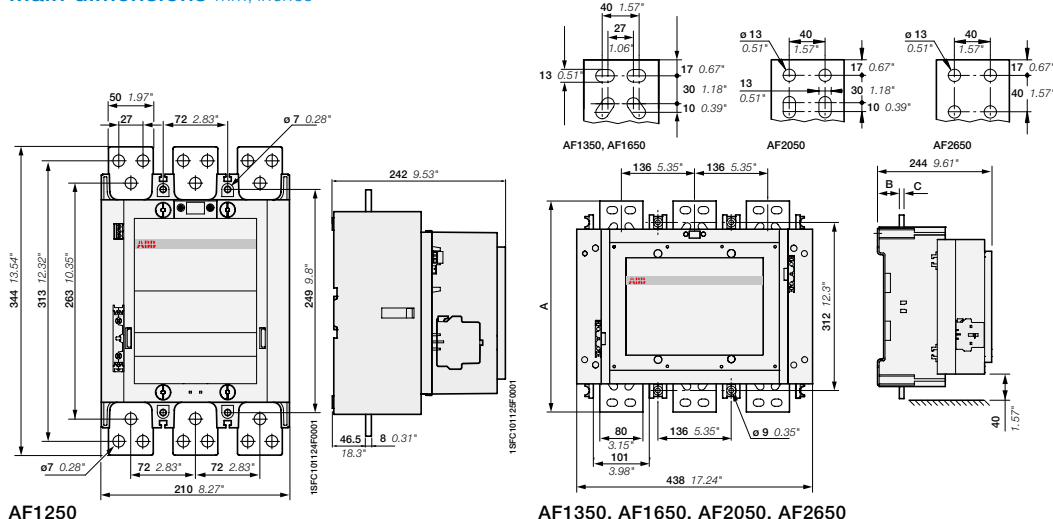

AF400 ... AF2650 3-pole contactors with 1 N.O. + 1 N.C. auxiliary contacts

Main accessories

Main accessories (other accessories available)

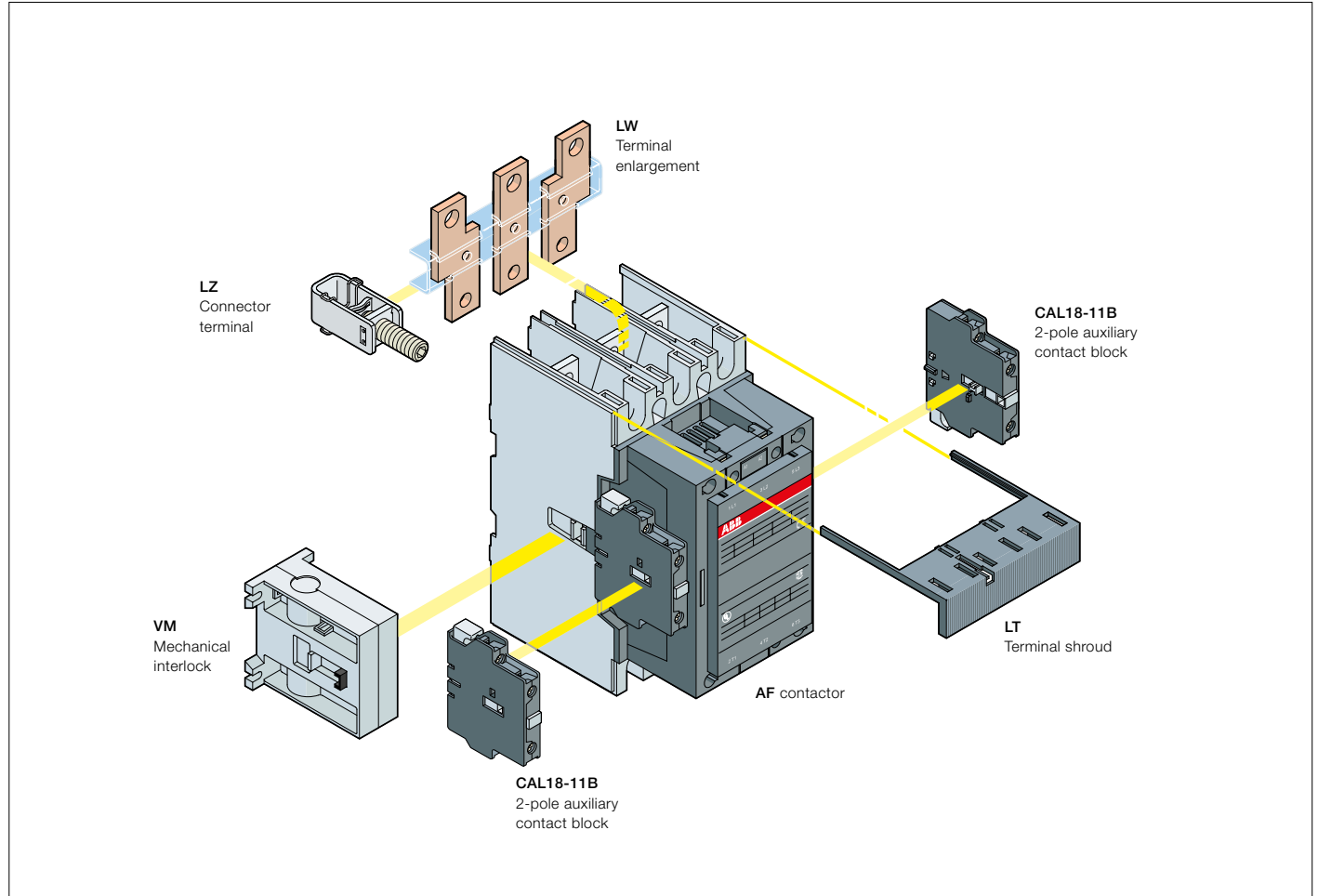

Main accessory fitting details

Contactor types	Main poles	Available auxiliary contacts	Side-mounted accessories		Mechanical interlock units (between two contactors)
			Auxiliary contact blocks		
			CAL18-11	CAL18-11B (3)	

Contactors + auxiliary contact blocks

AF400 ... AF2650	3	0	1	1	1 x CAL18-11	+	2 x CAL18-11B	-
------------------	---	---	---	---	--------------	---	---------------	---

Contactors with mechanical interlocking + auxiliary contact blocks

AF400 ... AF2650	3	0	1	1	2 x CAL18-11 (1)	+	4 x CAL18-11B (1)	+	VM...H (2)
------------------	---	---	---	---	------------------	---	-------------------	---	------------

(1) Total number of auxiliary contact blocks for the two contactors.

(2) Interlock type, according to the contactor ratings (see "Accessories").

(3) The CEL18-.. auxiliary contact blocks can replace the CAL18-11 and CAL18-11B. Though, no auxiliary contact block can be mounted outside the CEL18-..

Overload relays fitting details

Contactor types	Thermal overload relays	Electronic overload relays
AF400, AF460	-	EF460 (150...500 A) (4)
AF580, AF750	-	EF750 (250...800 A) (4)
AF1350, AF1650	-	E1250DU (375...1250 A) (4)

The addition of a thermal or electronic overload relay on the contactor does not prevent fitting of many other accessories as shown in "Main accessory fitting details" table.

(4) Mounting kit required (see "Motor protection").

AF400 ... AF2650 3-pole contactors with 1 N.O. + 1 N.C. auxiliary contacts Main accessories



CAL18-11

1SFC101082V0001

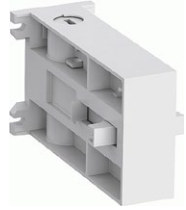

VM750H

1SFC101084V0001



LT460-AC

1SFC101089V0001

Ordering details (1)

For contactors	Auxiliary contacts	Type	Order code	Pkg qty	Weight (1 pce)
					kg

Side-mounted instantaneous auxiliary contact blocks

AF400 ... AF2650	1	1	CAL18-11	1SFN010720R1011	2	0.050
	1	1	CAL18-11B	1SFN010720R3311	2	0.050

Mechanical interlock unit

AF400 ... AF1250			VM750H	1SFN035700R1000	1	0.200
AF1350 ... AF2650			VM1650H	1SFN036503R1000	1	6.000

Terminal shrouds

AF400, AF460 with connectors			LT460-AC	1SFN125701R1000	2	0.100
AF400, AF460 with lugs			LT460-AL	1SFN125703R1000	2	0.800
AF580 ... AF750 with connectors			LT750-AC	1SFN126101R1000	2	0.120
AF580 ... AF750 with lugs			LT750-AL	1SFN126103R1000	2	0.825

For contactors	Dimensions		Type	Order code	Pkg qty	Weight (1 pce)
	hole Ø	bar				kg
	mm	mm				

Terminal enlargements

AF400, AF460	10.5	25 x 5	LW460	1SFN075707R1000	1	0.730
AF580, AF750	13	40 x 6	LW750	1SFN076107R1000	1	1.230
AF1250	13	50 x 10	LW1250	1SFN076407R1000	1	2.000

Terminal extension

AF400, AF460	10.5	25 x 5	LX460	1SFN075710R1000	1	0.500
AF580, AF750	13	40 x 6	LX750	1SFN076110R1000	1	0.850

(1) For more information, refer to main catalog "Accessories" section.

4-pole contactors



IEC	AC-1 Rated operational current	$\theta \leq 40\text{ }^\circ\text{C}$, 690 V	A	25	30	45	55	70	100	125	
UL/CSA	General use rating	600 V	A	25	30	45	55	60	80	105	
AC / DC Control supply			Type	AF09	AF16	AF26	AF38	AF40	AF52	AF80	
AC Control supply			Type	AF09	AF16	AF26	AF38	AF40	AF52	AF80	
DC Control supply			Type	AF09	AF16	AF26	AF38	AF40	AF52	AF80	
IEC	AC-1 Rated operational current	$\theta \leq 40\text{ }^\circ\text{C}$	A	25	30	45	55	70	100	125	
		690 V	$\theta \leq 60\text{ }^\circ\text{C}$ (1)	A	25	30	40	45	60	80	105
			$\theta \leq 70\text{ }^\circ\text{C}$	A	22	26	32	37	50	70	90
		With conductor cross sectional area		mm ²	4	6	10	16	35	35	50
	Rated operational voltage Ue max.		V	690	690	690	690	690	690	690	

(1) $\theta \leq 55\text{ }^\circ\text{C}$ for EK550, EK1000 contactors

Main accessories

Auxiliary contact blocks	Front mounting	CA4-10 (1 x N.O.), CA4-01 (1 x N.C.)
	Side mounting	
Timers	Electronic	TEF4-ON
		TEF4-OFF
Interlocking units	Mechanical	VM4
	Mechanical / Electrical	
Surge suppressors	Varistor + RC (AC / DC)	Built-in surge protection



160	200	275	350	400	500	525	800	1000
160	175	230	250	300	350	420	540	—
AF116	AF140	AF190	AF205	AF265	AF305	AF370	—	—
AF116	AF140	AF190	AF205	AF265	AF305	AF370	EK550	EK1000
AF116	AF140	AF190	AF205	AF265	AF305	AF370	EK550	EK1000
160	200	275	350	400	500	525	800	1000
145	175	250	300	350	400	425	650	800
130	160	200	240	290	325	350	575	720
70	95	150	240	240	300	2 x 185	2 x 240	2 x 300
690	690	1000	1000	1000	1000	1000	1000	1000

CAL19-11 (1 x N.O. + 1 x N.C.)	CAL16-11 (1 x N.O. + 1 x N.C.)
VM19 (for same size contactors)	VH800
	RC-EH800

AF09 ... AF38 4-pole contactors

25 to 55 A AC-1

AC / DC operated



AF09-40-00

1SBC101096FF014

Description

AF09 ... AF38 4-pole contactors are mainly used for controlling non-inductive or slightly inductive loads (i.e. resistance furnaces...) and generally for controlling power circuits up to 690 V AC and 440 V DC. These contactors are of the block type design with 4 main poles.

- control circuit: AC or DC operated with electronic coil interface accepting a wide control voltage range (e.g. 100...250 V AC and DC), only 4 control voltage ranges covering 24...500 V 50/60 Hz and 20...500 V DC
- can manage large control voltage variations
- reduced panel energy consumption
- very distinct closing and opening.
- built-in surge suppression
- add-on auxiliary contact blocks for front or side mounting and a wide range of accessories.

Ordering details

IEC Rated operational current $\theta \leq 40^\circ\text{C}$ AC-1	UL/CSA General use rating 600 V AC	Rated control circuit voltage Uc min. ... Uc max.		Auxiliary contacts fitted		Type	Order code	Weight Pkg (1 pce)	
A	A	V 50/60 Hz	V DC					kg	
4 N.O. main poles									
25	25	24...60	-	(1)	0	0	AF09-40-00-41	1SBL137201R4100	0.270
		48...130	48...130		0	0	AF09-40-00-12	1SBL137201R1200	0.270
		100...250	100...250		0	0	AF09-40-00-13	1SBL137201R1300	0.270
		250...500	250...500		0	0	AF09-40-00-14	1SBL137201R1400	0.310
30	30	24...60	-	(1)	0	0	AF16-40-00-41	1SBL177201R4100	0.270
		48...130	48...130		0	0	AF16-40-00-12	1SBL177201R1200	0.270
		100...250	100...250		0	0	AF16-40-00-13	1SBL177201R1300	0.270
		250...500	250...500		0	0	AF16-40-00-14	1SBL177201R1400	0.310
45	45	24...60	-	(1)	0	0	AF26-40-00-41	1SBL237201R4100	0.360
		48...130	48...130		0	0	AF26-40-00-12	1SBL237201R1200	0.360
		100...250	100...250		0	0	AF26-40-00-13	1SBL237201R1300	0.360
		250...500	250...500		0	0	AF26-40-00-14	1SBL237201R1400	0.400
55	55	24...60	-	(1)	0	0	AF38-40-00-41	1SBL297201R4100	0.360
		48...130	48...130		0	0	AF38-40-00-12	1SBL297201R1200	0.360
		100...250	100...250		0	0	AF38-40-00-13	1SBL297201R1300	0.360
		250...500	250...500		0	0	AF38-40-00-14	1SBL297201R1400	0.400
2 N.O. + 2 N.C. main poles									
25	25	24...60	-	(1)	0	0	AF09-22-00-41	1SBL137501R4100	0.270
		48...130	48...130		0	0	AF09-22-00-12	1SBL137501R1200	0.270
		100...250	100...250		0	0	AF09-22-00-13	1SBL137501R1300	0.270
		250...500	250...500		0	0	AF09-22-00-14	1SBL137501R1400	0.310
30	30	24...60	-	(1)	0	0	AF16-22-00-41	1SBL177501R4100	0.270
		48...130	48...130		0	0	AF16-22-00-12	1SBL177501R1200	0.270
		100...250	100...250		0	0	AF16-22-00-13	1SBL177501R1300	0.270
		250...500	250...500		0	0	AF16-22-00-14	1SBL177501R1400	0.310
45	45	24...60	-	(1)	0	0	AF26-22-00-41	1SBL237501R4100	0.360
		48...130	48...130		0	0	AF26-22-00-12	1SBL237501R1200	0.360
		100...250	100...250		0	0	AF26-22-00-13	1SBL237501R1300	0.360
		250...500	250...500		0	0	AF26-22-00-14	1SBL237501R1400	0.400
55	55	24...60	-	(1)	0	0	AF38-22-00-41	1SBL297501R4100	0.360
		48...130	48...130		0	0	AF38-22-00-12	1SBL297501R1200	0.360
		100...250	100...250		0	0	AF38-22-00-13	1SBL297501R1300	0.360
		250...500	250...500		0	0	AF38-22-00-14	1SBL297501R1400	0.400

(1) For 24...60 V 50/60 Hz - 20...60 V DC, use AF..Z...00-21.

Main dimensions mm, inches

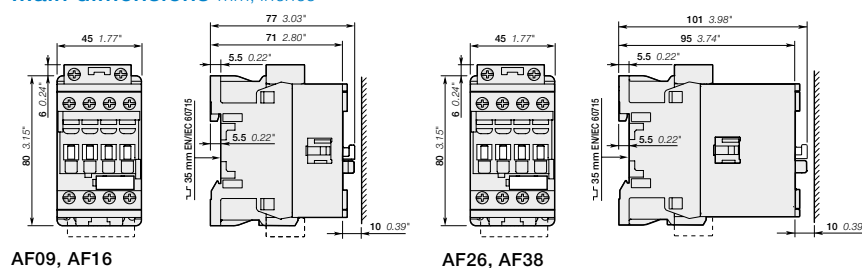

AF09, AF16

AF26, AF38

AF09Z ... AF38Z 4-pole contactors

25 to 55 A AC-1

AC / DC operated - low consumption



AF09Z-40-00





AF26Z-40-00

Description

AF09Z ... AF38Z 4-pole contactors are mainly used for controlling non-inductive or slightly inductive loads (i.e. resistance furnaces...) and generally for controlling power circuits up to 690 V AC and 440 V DC. These contactors are of the block type design with 4 main poles.

- control circuit: AC or DC operated with electronic coil interface accepting a wide control voltage range (e.g. 100...250 V AC and DC), only 4 control voltage ranges covering 24...250 V 50/60 Hz and 12...250 V DC
- can manage large control voltage variations
- allow direct control by PLC-output ≥ 24 V DC 500 mA
- reduced panel energy consumption
- very distinct closing and opening
- can withstand short voltage dips and voltage sags (SEMI F47-0706 conditions of use on request).
- built-in surge suppression
- add-on auxiliary contact blocks for front or side mounting and a wide range of accessories.

Ordering details

IEC	UL/CSA	Rated control circuit voltage		Auxiliary contacts fitted	Type	Order code	Weight
Rated operational current $\theta \leq 40$ °C AC-1	General use rating 600 V AC	Uc min. ...	Uc max.				Pkg (1 pce)
A	A	V 50/60 Hz	V DC	 			kg

4 N.O. main poles

Rated current	General use rating	Uc min. (V 50/60 Hz)	Uc max. (V DC)	Auxiliary contacts	Type	Order code	Weight
25	25	-	12...20	0 0	AF09Z-40-00-20	1SBL136201R2000	0.310
		24...60	20...60	0 0	AF09Z-40-00-21	1SBL136201R2100	0.310
		48...130	48...130	0 0	AF09Z-40-00-22	1SBL136201R2200	0.310
		100...250	100...250	0 0	AF09Z-40-00-23	1SBL136201R2300	0.310
30	30	-	12...20	0 0	AF16Z-40-00-20	1SBL176201R2000	0.310
		24...60	20...60	0 0	AF16Z-40-00-21	1SBL176201R2100	0.310
		48...130	48...130	0 0	AF16Z-40-00-22	1SBL176201R2200	0.310
		100...250	100...250	0 0	AF16Z-40-00-23	1SBL176201R2300	0.310
45	45	-	12...20	0 0	AF26Z-40-00-20	1SBL236201R2000	0.400
		24...60	20...60	0 0	AF26Z-40-00-21	1SBL236201R2100	0.400
		48...130	48...130	0 0	AF26Z-40-00-22	1SBL236201R2200	0.400
		100...250	100...250	0 0	AF26Z-40-00-23	1SBL236201R2300	0.400
55	55	-	12...20	0 0	AF38Z-40-00-20	1SBL296201R2000	0.400
		24...60	20...60	0 0	AF38Z-40-00-21	1SBL296201R2100	0.400
		48...130	48...130	0 0	AF38Z-40-00-22	1SBL296201R2200	0.400
		100...250	100...250	0 0	AF38Z-40-00-23	1SBL296201R2300	0.400

2 N.O. + 2 N.C. main poles

Rated current	General use rating	Uc min. (V 50/60 Hz)	Uc max. (V DC)	Auxiliary contacts	Type	Order code	Weight
25	25	-	12...20	0 0	AF09Z-22-00-20	1SBL136501R2000	0.310
		24...60	20...60	0 0	AF09Z-22-00-21	1SBL136501R2100	0.310
		48...130	48...130	0 0	AF09Z-22-00-22	1SBL136501R2200	0.310
		100...250	100...250	0 0	AF09Z-22-00-23	1SBL136501R2300	0.310
30	30	-	12...20	0 0	AF16Z-22-00-20	1SBL176501R2000	0.310
		24...60	20...60	0 0	AF16Z-22-00-21	1SBL176501R2100	0.310
		48...130	48...130	0 0	AF16Z-22-00-22	1SBL176501R2200	0.310
		100...250	100...250	0 0	AF16Z-22-00-23	1SBL176501R2300	0.310
45	45	-	12...20	0 0	AF26Z-22-00-20	1SBL236501R2000	0.400
		24...60	20...60	0 0	AF26Z-22-00-21	1SBL236501R2100	0.400
		48...130	48...130	0 0	AF26Z-22-00-22	1SBL236501R2200	0.400
		100...250	100...250	0 0	AF26Z-22-00-23	1SBL236501R2300	0.400
55	55	-	12...20	0 0	AF38Z-22-00-20	1SBL296501R2000	0.400
		24...60	20...60	0 0	AF38Z-22-00-21	1SBL296501R2100	0.400
		48...130	48...130	0 0	AF38Z-22-00-22	1SBL296501R2200	0.400
		100...250	100...250	0 0	AF38Z-22-00-23	1SBL296501R2300	0.400

Note: Only AF.Z contactors with DC control voltage 12...20 V DC need to respect the connection polarities indicated close to the coil terminals: A1+ for the positive pole and A2- for the negative pole.

Main dimensions mm, inches

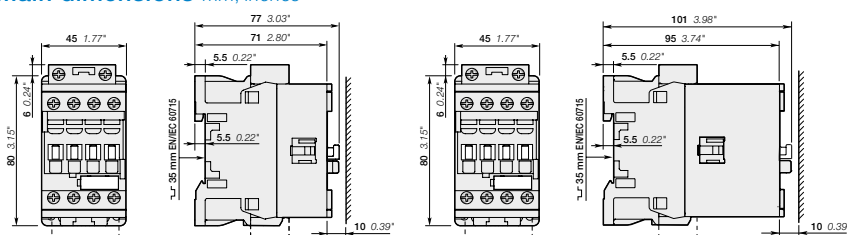

AF09Z, AF16Z

AF26Z, AF38Z

AF40 ... AF80 4-pole contactors

70 to 125 A AC-1

AC / DC operated



AF40-40-00



AF80-40-00

Description

AF40 ... AF80 4-pole contactors are mainly used for controlling non-inductive or slightly inductive loads (i.e. resistance furnaces...) and generally for controlling power circuits up to 690 V AC and 440 V DC. These contactors are of the block type design with 4 main poles.

- control circuit: AC or DC operated with electronic coil interface accepting a wide control voltage range (e.g. 100...250 V AC and DC), only 4 control voltages ranges covering 24...500 V 50/60 Hz and 20...500 V DC
- can manage large control voltage variations
- reduced panel energy consumption
- very distinct closing and opening.
- built-in surge suppression
- add-on auxiliary contact blocks for front or side mounting and a wide range of accessories.

Ordering details

IEC Rated operational current $\theta \leq 40^\circ\text{C}$ AC-1 A	UL/CSA General use rating 600 V AC A	Rated control circuit voltage Uc min. ... Uc max.		Auxiliary contacts fitted 	Type (1)	Order code	Weight Pkg (1 pce) kg
		V 50/60 Hz	V DC				
4 N.O. Main Poles							
70	60	24...60	-	0 0	AF40-40-00-41	1SBL347201R4100	1.210
		24...60	20...60 (1)	0 0	AF40-40-00-11	1SBL347201R1100	1.210
		48...130	48...130	0 0	AF40-40-00-12	1SBL347201R1200	1.210
		100...250	100...250	0 0	AF40-40-00-13	1SBL347201R1300	1.160
		250...500	250...500	0 0	AF40-40-00-14	1SBL347201R1400	1.160
100	80	24...60	-	0 0	AF52-40-00-41	1SBL367201R4100	1.210
		24...60	20...60 (1)	0 0	AF52-40-00-11	1SBL367201R1100	1.210
		48...130	48...130	0 0	AF52-40-00-12	1SBL367201R1200	1.210
		100...250	100...250	0 0	AF52-40-00-13	1SBL367201R1300	1.160
		250...500	250...500	0 0	AF52-40-00-14	1SBL367201R1400	1.160
125	105	24...60	-	0 0	AF80-40-00-41	1SBL397201R4100	1.490
		24...60	20...60 (1)	0 0	AF80-40-00-11	1SBL397201R1100	1.490
		48...130	48...130	0 0	AF80-40-00-12	1SBL397201R1200	1.490
		100...250	100...250	0 0	AF80-40-00-13	1SBL397201R1300	1.440
		250...500	250...500	0 0	AF80-40-00-14	1SBL397201R1400	1.440
2 N.O. + 2 N.C. Main Poles							
70	60	24...60	-	0 0	AF40-22-00-41	1SBL347501R4100	1.210
		24...60	20...60 (1)	0 0	AF40-22-00-11	1SBL347501R1100	1.210
		48...130	48...130	0 0	AF40-22-00-12	1SBL347501R1200	1.210
		100...250	100...250	0 0	AF40-22-00-13	1SBL347501R1300	1.160
		250...500	250...500	0 0	AF40-22-00-14	1SBL347501R1400	1.160
125	105	24...60	-	0 0	AF80-22-00-41	1SBL397501R4100	1.490
		24...60	20...60 (1)	0 0	AF80-22-00-11	1SBL397501R1100	1.490
		48...130	48...130	0 0	AF80-22-00-12	1SBL397501R1200	1.490
		100...250	100...250	0 0	AF80-22-00-13	1SBL397501R1300	1.440
		250...500	250...500	0 0	AF80-22-00-14	1SBL397501R1400	1.440

(1) AF.....-11 not suitable for direct control by PLC-output.

Main dimensions mm, inches

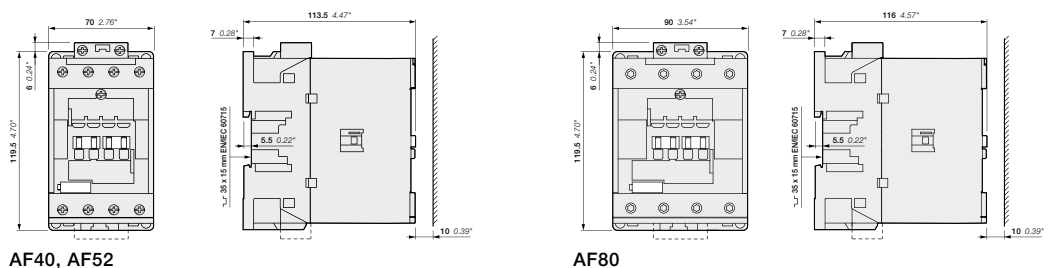

AF40, AF52

AF80

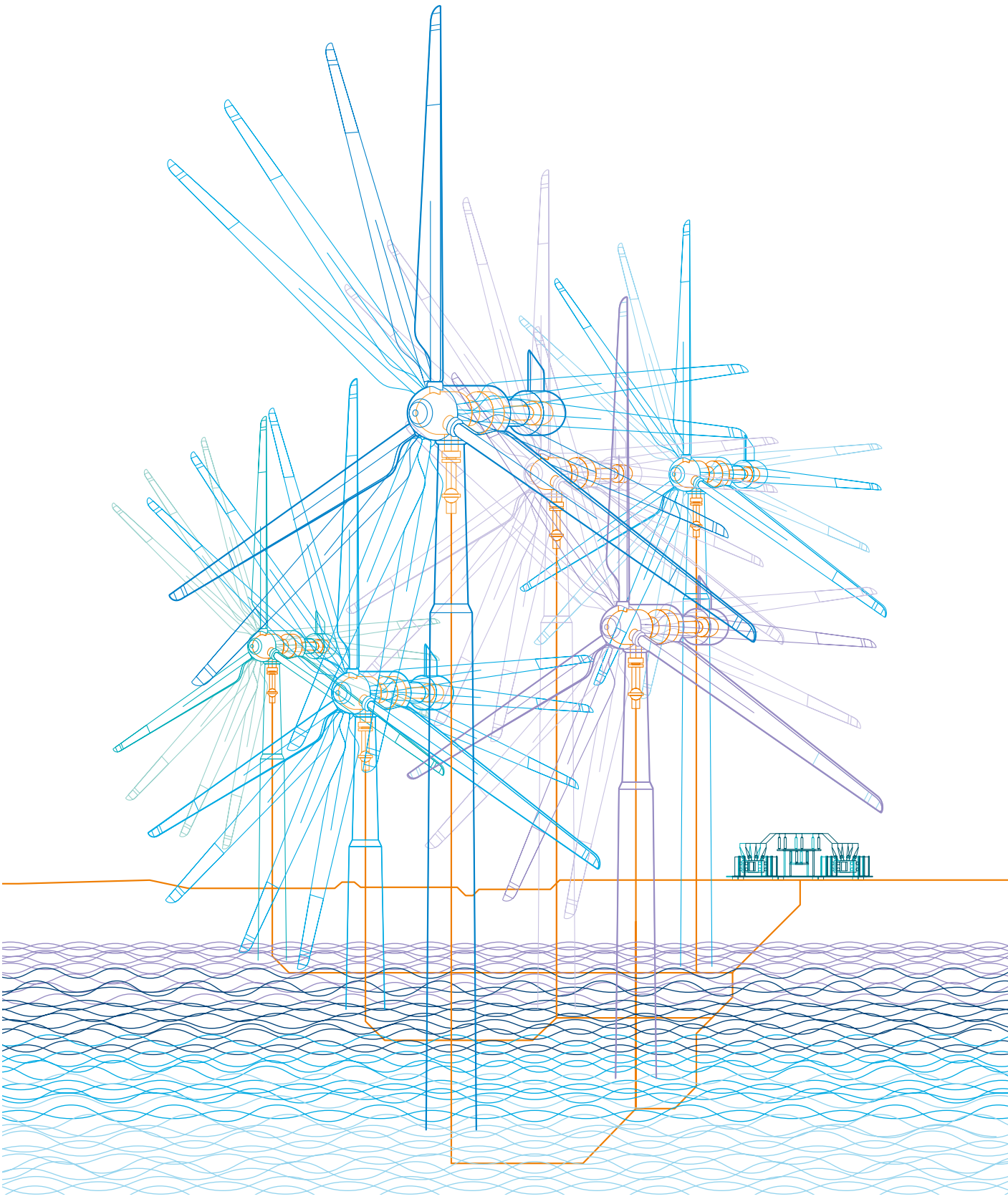

AF09 ... AF80 4-pole contactors

Main accessories

Contactor and main accessories (other accessories available)

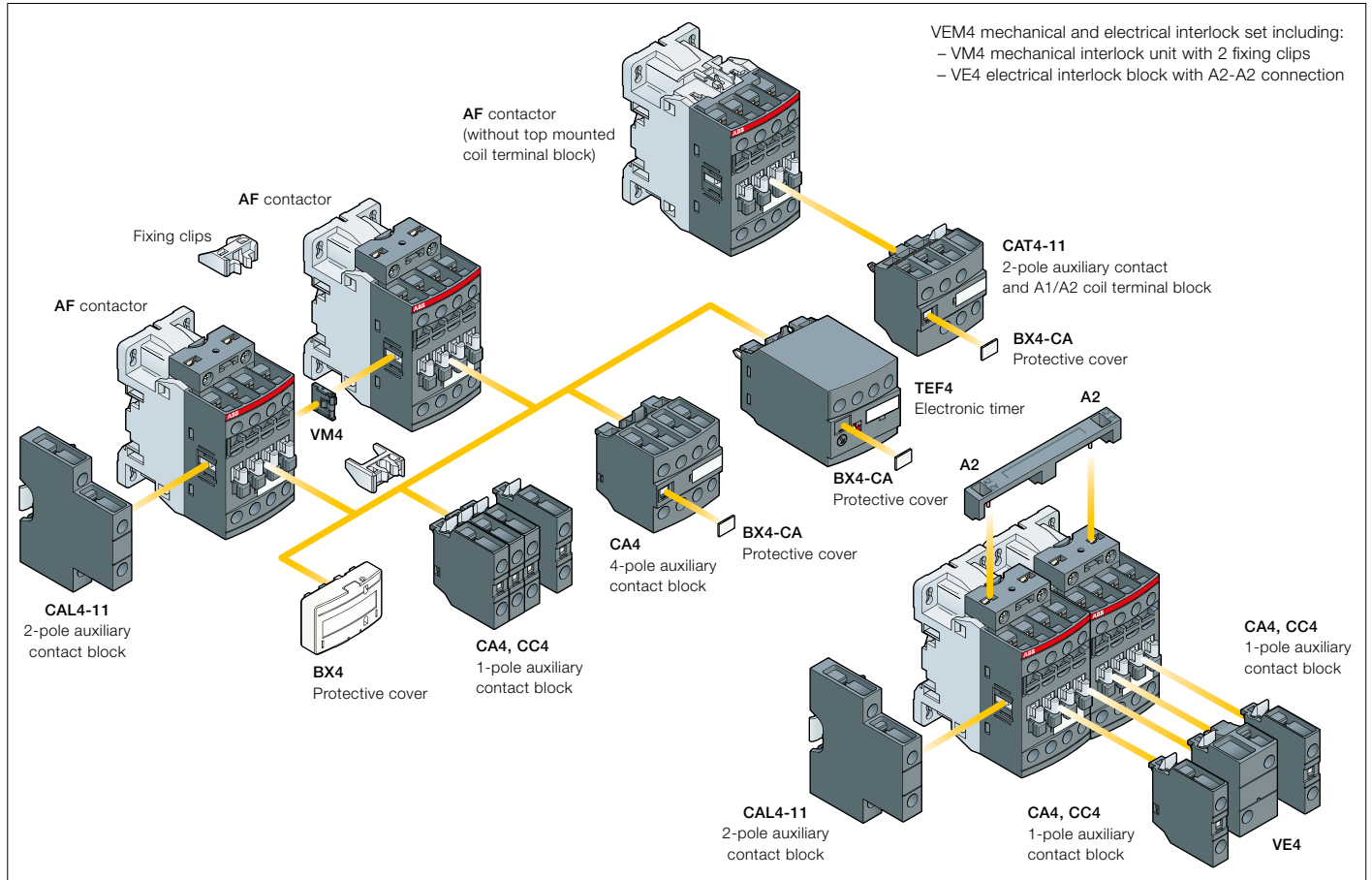

Main accessory fitting details

Many configurations of accessories are possible depending on whether these are front-mounted or side-mounted.

Contactor types	Main poles	Built-in auxiliary contacts	Front-mounted accessories					Side-mounted accessories	
			Auxiliary contact blocks			Electronic timer	Electrical and mechanical interlock set (between 2 contactors)	Auxiliary contact blocks	
			1-pole CA4 1-pole CC4	2-pole CAT4-11	4-pole CA4	TEF4	VEM4	Left side 2-pole CAL4-11	Right side
Max. add-on N.C. auxiliary contacts: 4 N.C. max. on positions 1, 2, 3, 4 and 3 N.C. max. on positions 1 ±30°, 5									
AF09 ... AF16	4	0	0	0	4 max. or 1	or 1	or 1	+	1
					2 max. or 1	-	or 1	+	1
					3 max. -	-	-	+	1
Max. add-on N.C. auxiliary contacts: 3 N.C. max. on positions 1, 2, 3, 4 and 2 N.C. max. on positions 1 ±30°, 5									
AF26 ... AF38	4	0	0	0	4 max. or 1	or 1	or 1	+	1
					2 max. or 1	-	or 1	+	1
					3 max. -	-	-	+	1
Max. add-on N.C. auxiliary contacts: 6 N.C. max. on positions 1, 1 ±30°, 2, 3, 4, 5									
AF40 ... AF52	4	0	0	0	4 max. or 1	or 1	or 1	+	1
AF80	4	0	0	0	4 max. -	or 1	or 1	+	1
Max. add-on N.C. auxiliary contacts: 3 N.C. max. on positions 1, 2, 3, 4 and 2 N.C. max. on positions 1 ±30°, 5									
AF09 ... AF16	2	2	0	0	4 max. or 1	or 1	or 1	+	1
AF26 ... AF38	2	2	0	0	2 max. or 1	-	or 1	+	1
Max. add-on N.C. auxiliary contacts: 2 N.C. max. on positions 1, 1 ±30°, 2, 3, 4, 5									
AF40	2	2	0	0	4 max. or 1	or 1	or 1	+	1
	2	2	0	0	4 max. -	or 1	or 1	+	1
AF80	2	2	0	0	4 max. -	or 1	or 1	+	1

AF09 ... AF80 4-pole contactors

Main accessories



CA4-10



CAL4-11



CA4-22E



CAT4-11E



VEM4

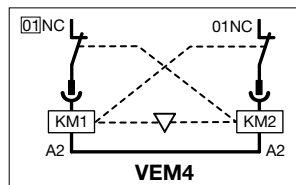

TEF4-ON

Ordering details (1)

For contactors	Auxiliary contacts	Type	Order code	Pkg qty	Weight (1 pce)
					kg

Front-mounted instantaneous auxiliary contact blocks

AF09 ... AF80-40-00	1 0	- -	CA4-10	1SBN010110R1010	1	0.014
AF09 ... AF80-22-00	1 0	- -	CA4-10-T	1SBN010110T1010	10	0.014
	0 1	- -	CA4-01	1SBN010110R1001	1	0.014
	0 1	- -	CA4-01-T	1SBN010110T1001	10	0.014
	2 2	- -	CA4-22E	1SBN010140R1022	1	0.055
	3 1	- -	CA4-31E	1SBN010140R1031	1	0.055
	4 0	- -	CA4-40E	1SBN010140R1040	1	0.055
AF09 ... AF16...-40-00	0 4	- -	CA4-04E	1SBN010140R1004	1	0.055

Front-mounted auxiliary contact blocks with N.O. leading contact and N.C. lagging contact

AF09 ... AF80-40-00	- -	1 0	CC4-10	1SBN010111R1010	1	0.014
AF09 ... AF80-22-00	- -	0 1	CC4-01	1SBN010111R1001	1	0.014

Side-mounted instantaneous auxiliary contact blocks

AF09 ... AF80-40-00	1 1	- -	CAL4-11	1SBN010120R1011	1	0.040
AF09 ... AF80-22-00	1 1	- -	CAL4-11-T	1SBN010120T1011	10	0.040

Front-mounted instantaneous auxiliary contact and A1/A2 coil terminal blocks

AF09 ... AF52...-40-00	1 1	- -	CAT4-11E	1SBN010151R1011	1	0.040
AF09 ... AF40...-22-00						

Note: CAT4 not suitable for AF..Z contactors with DC control voltage 12...20 V DC.

Mechanical interlock unit

AF09 ... AF38...-40-00			VM4	1SBN030105T1000	10	0.005
AF40 ... AF80...-40-00			VM96-4	1SBN033405T1000	10	0.006

Note: VM4 includes 2 fixing clips (BB4) to maintain together both contactors.

Mechanical and electrical interlock set

AF09, AF16...-40-00	0 2	- -	VEM4	1SBN030111R1000	1	0.035
AF26, AF38...-40-00						

Note: - VEM4 includes a VM4 mechanical interlock unit with 2 fixing clips (BB4), a VE4 electrical interlock block. VE4 block must be used with A2-A2 connection to respect the electrical connection diagram.

- VEM4 not suitable for AF..Z contactors with DC control voltage 12...20 V DC.

For contactors	Time delay range selected by switch	Delay type	Auxiliary contacts	Type	Order code	Pkg qty	Weight (1 pce)
							kg

Electronic timers

AF09 ... AF80	0.1...1 s	ON-delay	1 1	TEF4-ON	1SBN020112R1000	1	0.065
	1...10 s						
	10...100 s	OFF-delay	1 1	TEF4-OFF	1SBN020114R1000	1	0.065

Note: Rated control circuit voltage U_c 24...240 V 50/60 Hz or DC.

(1) For more information, refer to main catalog "Accessories" section.

AF116 ... AF140 4-pole contactors

160 to 200 A AC-1

AC / DC operated with 1 N.O. + 1 N.C. auxiliary contacts



AF140-40-11

1SFC101154V0001



AF140-40-11B

1SFC101192V0001

Description

AF116 ... AF140 4-pole contactors are mainly used for controlling non-inductive or slightly inductive loads (i.e. resistance furnaces...) and generally for controlling power circuits up to 690 V AC and 350 V DC. These contactors are of the block type design with 4 main poles.

- control circuit: AC or DC operated with electronic coil interface accepting a wide control voltage range (e.g. 100...250 V AC and DC), only 4 coils to cover control voltages between 24...500 V 50/60 Hz and 20...500 V DC
- can manage large control voltage variations
- reduced panel energy consumption
- very distinct closing and opening
- can withstand short voltage dips and voltage sags (SEMI F47 conditions of use on request).
- built-in surge suppression
- add-on auxiliary contact blocks for side mounting and a wide range of accessories.

Ordering details

IEC Rated operational current $\theta \leq 40^\circ\text{C}$ AC-1 A	UL / CSA General use rating 600 V AC A	Rated control circuit voltage Uc min. ... Uc max. V 50/60 Hz V DC		Auxiliary contacts fitted 	Type (1)	Order code	Weight Pkg (1 pce) kg
--	--	---	--	---	-------------	------------	--------------------------------

4 N.O. main poles

For connection with built-in cable clamps

Rated operational current (A)	UL / CSA rating (A)	Rated control circuit voltage V 50/60 Hz	Rated control circuit voltage V DC	N.O. contacts	N.C. contacts	Type	Order code	Weight (kg)
160	160	24...60	20...60	1	1	AF116-40-11-11	1SFL427101R1111	2.270
		48...130	48...130	1	1	AF116-40-11-12	1SFL427101R1211	2.270
		100...250	100...250	1	1	AF116-40-11-13	1SFL427101R1311	2.270
		250...500	250...500	1	1	AF116-40-11-14	1SFL427101R1411	2.270
200	175	24...60	20...60	1	1	AF140-40-11-11	1SFL447101R1111	2.270
		48...130	48...130	1	1	AF140-40-11-12	1SFL447101R1211	2.270
		100...250	100...250	1	1	AF140-40-11-13	1SFL447101R1311	2.270
		250...500	250...500	1	1	AF140-40-11-14	1SFL447101R1411	2.270

With bar connections

Rated operational current (A)	UL / CSA rating (A)	Rated control circuit voltage V 50/60 Hz	Rated control circuit voltage V DC	N.O. contacts	N.C. contacts	Type	Order code	Weight (kg)
160	160	24...60	20...60	1	1	AF116-40-11B-11	1SFL427102R1111	2.170
		48...130	48...130	1	1	AF116-40-11B-12	1SFL427102R1211	2.170
		100...250	100...250	1	1	AF116-40-11B-13	1SFL427102R1311	2.170
		250...500	250...500	1	1	AF116-40-11B-14	1SFL427102R1411	2.170
200	175	24...60	20...60	1	1	AF140-40-11B-11	1SFL447102R1111	2.170
		48...130	48...130	1	1	AF140-40-11B-12	1SFL447102R1211	2.170
		100...250	100...250	1	1	AF140-40-11B-13	1SFL447102R1311	2.170
		250...500	250...500	1	1	AF140-40-11B-14	1SFL447102R1411	2.170

(1) For other auxiliary contacts arrangements, please contact your ABB local organization.

Main dimensions mm, inches

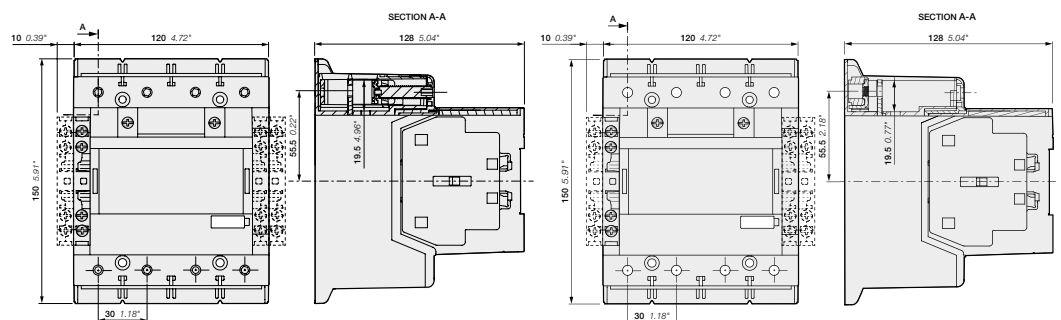

AF116, AF140-40-11

AF116, AF140-40-11B

1SFC101198C0201 - Rev. B

AF190 ... AF370 4-pole contactors

275 to 525 A AC-1

AC / DC operated with 1 N.O. + 1 N.C. auxiliary contacts

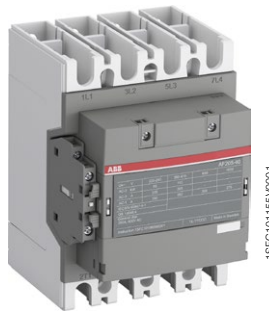

AF205-40-11





AF370-40-11

Description

AF190 ... AF370 4-pole contactors are mainly used for controlling non-inductive or slightly inductive loads (i.e. resistance furnaces...) and generally for controlling power circuits up to 1000 V AC and 440 V DC. These contactors are of the block type design with 4 main poles.

- control circuit: AC or DC operated with electronic coil interface accepting a wide control voltage range (e.g. 100...250 V AC and DC), only 4 coils to cover control voltages between 24...500 V 50/60 Hz and 20...500 V DC
- can manage large control voltage variations
- reduced panel energy consumption
- very distinct closing and opening
- can withstand short voltage dips and voltage sags (SEMI F47 conditions of use on request).
- built-in surge suppression
- add-on auxiliary contact blocks for side mounting and a wide range of accessories.

Ordering details

IEC Rated operational current $\theta \leq 40^\circ\text{C}$ AC-1	UL / CSA General use rating 600 V AC	Rated control circuit voltage Uc min. ... Uc max.		Auxiliary contacts fitted	Type (1)	Order code	Weight Pkg (1 pce) kg
A	A	V 50/60 Hz	V DC	 			
4 N.O. main poles							
275	230	24...60	20...60	1 1	AF190-40-11-11	1SFL487102R1111	3.920
		48...130	48...130	1 1	AF190-40-11-12	1SFL487102R1211	3.920
		100...250	100...250	1 1	AF190-40-11-13	1SFL487102R1311	3.920
		250...500	250...500	1 1	AF190-40-11-14	1SFL487102R1411	3.920
350	250	24...60	20...60	1 1	AF205-40-11-11	1SFL527102R1111	3.920
		48...130	48...130	1 1	AF205-40-11-12	1SFL527102R1211	3.920
		100...250	100...250	1 1	AF205-40-11-13	1SFL527102R1311	3.920
		250...500	250...500	1 1	AF205-40-11-14	1SFL527102R1411	3.920
400	300	24...60	20...60	1 1	AF265-40-11-11	1SFL547102R1111	6.380
		48...130	48...130	1 1	AF265-40-11-12	1SFL547102R1211	6.380
		100...250	100...250	1 1	AF265-40-11-13	1SFL547102R1311	6.380
		250...500	250...500	1 1	AF265-40-11-14	1SFL547102R1411	6.380
500	350	24...60	20...60	1 1	AF305-40-11-11	1SFL587102R1111	6.380
		48...130	48...130	1 1	AF305-40-11-12	1SFL587102R1211	6.380
		100...250	100...250	1 1	AF305-40-11-13	1SFL587102R1311	6.380
		250...500	250...500	1 1	AF305-40-11-14	1SFL587102R1411	6.380
525	420	24...60	20...60	1 1	AF370-40-11-11	1SFL607102R1111	6.380
		48...130	48...130	1 1	AF370-40-11-12	1SFL607102R1211	6.380
		100...250	100...250	1 1	AF370-40-11-13	1SFL607102R1311	6.380
		250...500	250...500	1 1	AF370-40-11-14	1SFL607102R1411	6.380

(1) For other auxiliary contacts arrangements, please contact your ABB local organization.

Main dimensions mm, inches

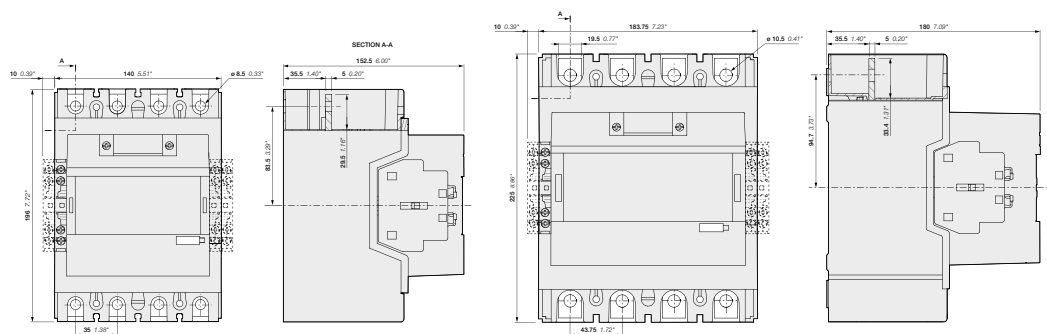

AF190, AF205

AF265, AF305, AF370

AF116 ... AF370 4-pole contactors with 1 N.O. + 1 N.C. auxiliary contacts Main accessories

Main accessories (other accessories available)

5

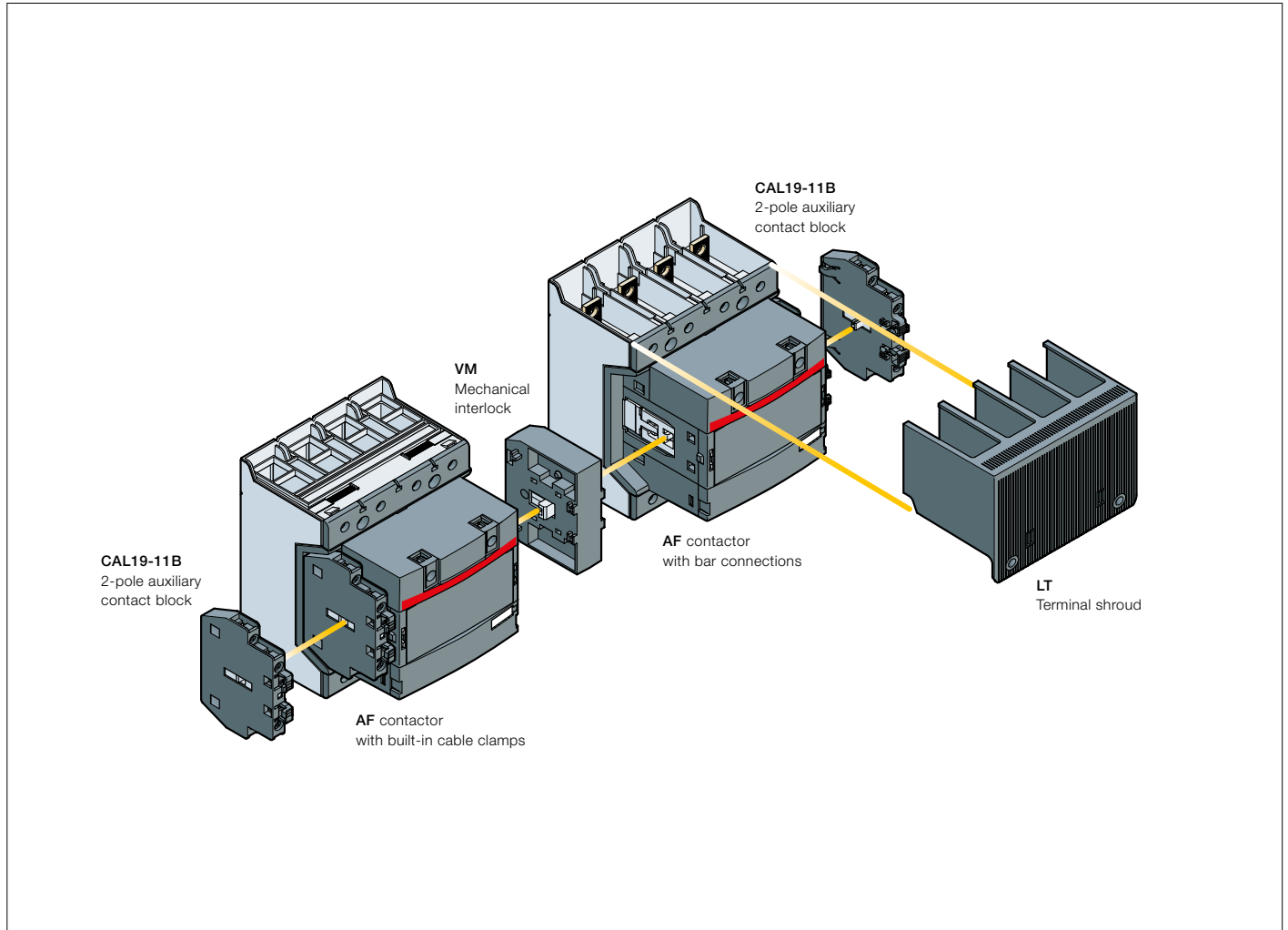

Main accessory fitting details

Contactor types	Main poles	Available auxiliary contacts	Side-mounted accessories		
			Auxiliary contact blocks		Mechanical interlock units (between two contactors)
			CAL19-11	CAL19-11B	
AF116 ... AF370	4	0 1 1	1 x CAL19-11	+ 2 x CAL19-11B	–
AF116 ... AF370	4	0 1 1	–	+ 2 x CAL19-11B (1)	+ VM... (2)

(1) Total number of auxiliary contact blocks for the two contactors.

(2) Interlock type, according to the contactor ratings (see "Accessories").

AF116 ... AF370 4-pole contactors with 1 N.O. + 1 N.C. auxiliary contacts Main accessories



CAL19-11

1SFC101071V0001

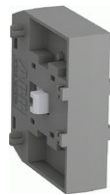

VM19

1SFC101035V0001

Ordering details (1)

For contactors	Auxiliary contacts	Type	Order code	Pkg qty	Weight (1 pce)
					kg

Side-mounted instantaneous auxiliary contact blocks

AF116 ... AF370	1	1	CAL19-11	1SFN010820R1011	2	0.050
	1	1	CAL19-11B	1SFN010820R3311	2	0.050

Mechanical interlock unit

AF116 ... AF370		VM19	1SFN030300R1000	1	0.054
AF116 ... AF146 and AF190, AF205		VM140/190	1SFN034403R1000	1	0.088
AF190, AF205 and AF265 ... AF370		VM205/265	1SFN035203R1000	1	0.090

Terminal shrouds

AF116 ... AF140, with compression lugs		LT140-40L	1SFN124203R2000	2	0.090
AF190 ... AF205, with cable clamps		LT205-40C	1SFN124801R2000	2	0.060
AF190 ... AF205, with compression lugs		LT205-40L	1SFN124803R2000	2	0.290
AF265 ... AF370, with cable clamps		LT370-40C	1SFN125401R2000	2	0.040
AF265 ... AF370, with compression lugs		LT370-40L	1SFN125403R2000	2	0.370

5

For contactors	Dimensions		Type	Order code	Pkg qty	Weight (1 pce)
	hole Ø mm	bar mm				

Terminal enlargements

AF190 ... AF205	10.5	20 x 5	LW205-40	1SFN074807R2000	1	0.306
AF265 ... AF370	10.5	25 x 5	LW370-40	1SFN075407R2000	1	0.540

(1) For more information, refer to "Accessories" section.

EK550, EK1000 4-pole contactors

800 to 1000 A AC-1

AC operated - with 1 N.O. + 1 N.C. auxiliary contacts



EK1000-40-11



Description

EK550 4-pole contactors are mainly used for controlling non-inductive or slightly inductive loads (i.e. resistance furnaces...) and generally for controlling power circuits up to 1000 V AC and 600 V DC, EK1000 up to 1000 V AC.

These contactors are of the block type design with:

- 4 main poles
- control circuit: AC operated
- add-on auxiliary contact blocks for side mounting and a wide range of accessories.

Ordering details

IEC Rated operational current $\theta \leq 40^\circ\text{C}$ AC-1	UL/CSA General use rating 600 V AC	Rated control circuit voltage U_c (1)		Auxiliary contacts fitted		Type	Order code	Weight Pkg (1 pce) kg
		V 50 Hz	V 60 Hz					
800	540	48	-	1	1	EK550-40-11	SK827041-AD	17.200
		110	110...120	1	1	EK550-40-11	SK827041-EF	17.200
		110...115	115...127	1	1	EK550-40-11	SK827041-EG	17.200
		220	220...240	1	1	EK550-40-11	SK827041-EL	17.200
		220...230	230...255	1	1	EK550-40-11	SK827041-EM	17.200
		380	380...415	1	1	EK550-40-11	SK827041-EP	17.200
		380...400	400...440	1	1	EK550-40-11	SK827041-ER	17.200
		400...415	-	1	1	EK550-40-11	SK827041-AR	17.200
1000	-	48	-	1	1	EK1000-40-11	SK827044-AD	17.500
		110	110...120	1	1	EK1000-40-11	SK827044-EF	17.500
		110...115	115...127	1	1	EK1000-40-11	SK827044-EG	17.500
		220	220...240	1	1	EK1000-40-11	SK827044-EL	17.500
		220...230	230...255	1	1	EK1000-40-11	SK827044-EM	17.500
		380	380...415	1	1	EK1000-40-11	SK827044-EP	17.500
		380...400	400...440	1	1	EK1000-40-11	SK827044-ER	17.500
		400...415	-	1	1	EK1000-40-11	SK827044-AR	17.500

(1) Other control voltages see voltage code table.

Main dimensions mm, inches

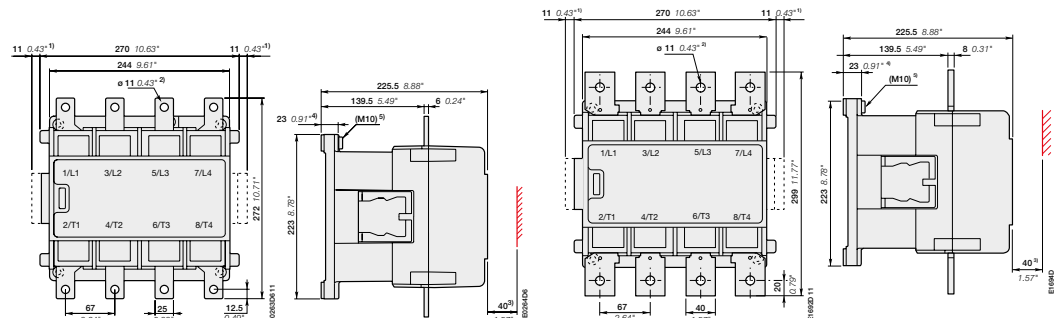

EK550

- 1) Dimension for extra auxiliary contact block.
- 2) Screw, nut and washer by-packed.
- 3) Min. distance to uninsulated wall.
- 4) Damping elements are included.
- 5) Earthing screw.

EK1000

EK550, EK1000 4-pole contactors

800 to 1000 A AC-1

DC operated - with 2 N.O. + 1 N.C. auxiliary contacts



EK1000-40-21

Description

EK550 4-pole contactors are mainly used for controlling non-inductive or slightly inductive loads (i.e. resistance furnaces...) and generally for controlling power circuits up to 1000 V AC and 600 V DC, EK1000 up to 1000 V AC.

These contactors are of the block type design with:

- 4 main poles
- control circuit: DC operated
- add-on auxiliary contact blocks for side mounting and a wide range of accessories.

Ordering details

IEC	UL / CSA	Rated control circuit voltage Uc	Auxiliary contacts fitted	Type	Order code	Weight
Rated operational current $\theta \leq 40^\circ\text{C}$ AC-1	General use rating 600 V AC					Pkg (1 pce) kg
A	A	V DC				
800	540	24	2 1	EK550-40-21	SK827041-DB	17.200
		36	2 1	EK550-40-21	SK827041-DC	17.200
		48	2 1	EK550-40-21	SK827041-DD	17.200
		60	2 1	EK550-40-21	SK827041-DT	17.200
		75	2 1	EK550-40-21	SK827041-DG	17.200
		110	2 1	EK550-40-21	SK827041-DE	17.200
		125	2 1	EK550-40-21	SK827041-DU	17.200
		220	2 1	EK550-40-21	SK827041-DF	17.200
1000	-	24	2 1	EK1000-40-21	SK827044-DB	17.500
		36	2 1	EK1000-40-21	SK827044-DC	17.500
		48	2 1	EK1000-40-21	SK827044-DD	17.500
		60	2 1	EK1000-40-21	SK827044-DT	17.500
		75	2 1	EK1000-40-21	SK827044-DG	17.500
		110	2 1	EK1000-40-21	SK827044-DE	17.500
		125	2 1	EK1000-40-21	SK827044-DU	17.500
		220	2 1	EK1000-40-21	SK827044-DF	17.500

Main dimensions mm, inches

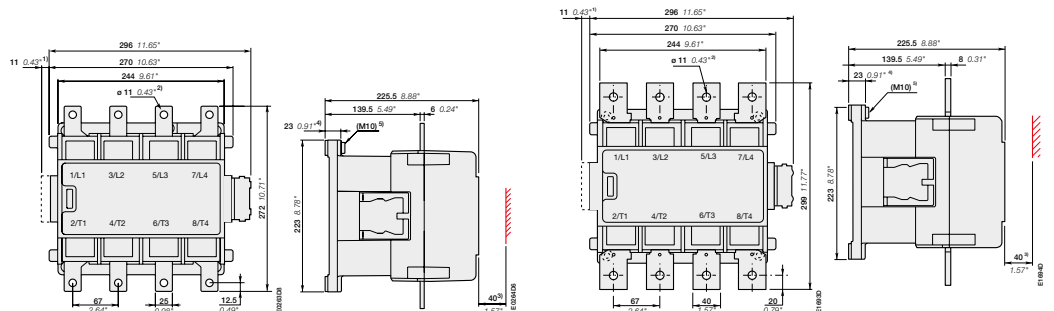

EK550

- 1) Dimension for extra auxiliary contact block.
- 2) Screw, nut and washer by-packed.
- 3) Min. distance to uninsulated wall.
- 4) Damping elements are included.
- 5) Earthing screw.

EK1000

EK550, EK1000 4-pole contactors with 1 N.O. + 1 N.C. auxiliary contacts and 2 N.O. + 1 N.C. auxiliary contacts

Main accessory fitting details

Mounting positions of the auxiliary contact	Auxiliary contact types and connecting diagrams
	<p style="text-align: right;">(1) Contact 35-36 used for some types of EK... contactors</p>

EK 4-pole contactors

Contactor types	Main poles	Available auxiliary contacts	Add-on auxiliary contact blocks	Mounting and positioning
			2-pole CAL16-11 ...	
AC operated, 50 Hz, 60 Hz or 50/60 Hz				
EK550, EK1000	4 0	1 1	+ 1 x CAL16-11B + 1 x CAL16-11C + 1 x CAL16-11D	
DC operated				
EK550, EK1000	4 0	2 1	+ 1 x CAL16-11C	

EK 4-pole reversing contactors with VH800 mechanical and electrical interlock units

"Left hand" contactors	Interlocking	"Right hand" contactors	Add-on auxiliary contact blocks	Mounting and positioning
			2-pole CAL16-11 ...	
AC operated, 50 Hz, 60 Hz or 50/60 Hz				
EK550, EK1000	VH800	EK550, EK1000	+ 1 x CAL16-11C + 1 x CAL16-11D	
DC operated				
EK550, EK1000	VH800	EK550, EK1000	—	

EK550, EK1000 4-pole contactors with 1 N.O. + 1 N.C. auxiliary contacts and 2 N.O. + 1 N.C. auxiliary contacts

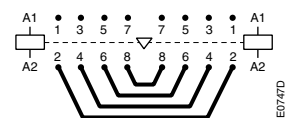



BSS550 ... BSS1000



RC-EH

Ordering details (1)

For contactors	Auxiliary contacts	Type	Order code	Pkg qty	Weight (1 pce)
	 				kg

Side-mounted auxiliary contact blocks

EK	1	1	CAL16-11B	SK829002-B	1	0.050
	1	1	CAL16-11C	SK829002-C	1	0.050
	1	1	CAL16-11D	SK829002-D	1	0.050
	1	1	CCL16-11E (2)	SK829002-E	1	0.050

Mechanical interlock unit for two horizontal mounted contactors

EK550, EK1000	VH800	SK829070-F	1	6.000
---------------	-------	------------	---	-------

Connecting sets

EK550	BSS550	SK829090-E	1	3.300
EK1000	BSS1000	SK829090-H	1	5.500

Surge suppressors

For contactors	Rated control circuit voltage U _c		Type	Order code	Pkg qty	Weight (1 pce)	
	V	AC					DC
EK550, EK1000	48...110	●	-	RC-EH800/110	SK829007-C	1	0.015
EK550, EK1000	24...125	-	●	RC-EH800/110	SK829007-C	1	0.015
EK550, EK1000	220...600	●	-	RC-EH800/600	SK829007-D	1	0.015

(1) See "Main accessory fitting details" table.

(2) Mounting of CCL16-11E blocks does not allow an additional second block to be added on top of it. All DC operated EK contactors are equipped with one CCL16-11E on the right side.

NF 4-pole contactor relays

AC / DC operated



NF22E

1SBH10104R0014

Description

NF contactor relays are used for switching auxiliary and control circuits.

These contactor relays are of the block type design with:

- 4 poles. Contactor relays have mechanically linked auxiliary contact elements (side-marked symbol)
- control circuit: AC or DC operated with electronic coil interface accepting a wide control voltage range (e.g. 100...250 V AC and DC)
 - can manage large control voltage variations
 - only 4 control voltage ranges covering 24...500 V 50/60 Hz and 20...500 V DC
 - reduced panel energy consumption
 - very distinct closing and opening.
- built-in surge suppression
- add-on auxiliary contact blocks for front or side mounting and a wide range of accessories.

Ordering details

Number of contacts	Rated control circuit voltage		Type	Order code	Weight
	Uc min. ... Uc max.				
	V 50/60 Hz	V DC			kg
	24...60	-	(1) NF22E-41	1SBH137001R4122	0.270
	48...130	48...130	NF22E-12	1SBH137001R1222	0.270
	100...250	100...250	NF22E-13	1SBH137001R1322	0.270
	250...500	250...500	NF22E-14	1SBH137001R1422	0.310
	24...60	-	(1) NF31E-41	1SBH137001R4131	0.270
	48...130	48...130	NF31E-12	1SBH137001R1231	0.270
	100...250	100...250	NF31E-13	1SBH137001R1331	0.270
	250...500	250...500	NF31E-14	1SBH137001R1431	0.310
	24...60	-	(1) NF40E-41	1SBH137001R4140	0.270
	48...130	48...130	NF40E-12	1SBH137001R1240	0.270
	100...250	100...250	NF40E-13	1SBH137001R1340	0.270
	250...500	250...500	NF40E-14	1SBH137001R1440	0.310

(1) For 24...60 V 50/60 Hz - 20...60 V DC, use NF..E-21.

Main dimensions mm, inches

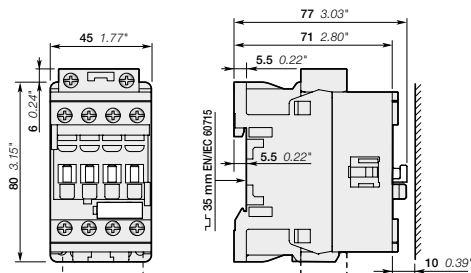

NF22E, NF31E, NF40E

1SBH101568S0201a - Rev. B

NFZ 4-pole contactor relays

AC / DC operated - low consumption



NFZ22E

Description

NFZ contactor relays are used for switching auxiliary and control circuits.

These contactor relays are of the block type design with:

- 4 poles. Contactor relays have mechanically linked auxiliary contact elements (side-marked symbol)
- control circuit: AC or DC operated with electronic coil interface accepting a wide control voltage range (e.g. 100...250 V AC and DC)
 - can manage large control voltage variations
 - only 4 control voltage ranges covering 24...250 V 50/60 Hz and 12...250 V DC
 - allow direct control by PLC-output ≥ 24 V DC 500 mA
 - reduced panel energy consumption
 - very distinct closing and opening
 - can withstand short voltage dips and voltage sags (SEMI F47-0706 conditions of use on request).
- built-in surge suppression
- add-on auxiliary contact blocks for front or side mounting and a wide range of accessories.

Ordering details

Number of contacts	Rated control circuit voltage Uc min. ... Uc max.		Type	Order code	Weight Pkg (1 pce) kg
	V 50/60 Hz	V DC			
	-	12...20	NFZ22E-20	1SBH136001R2022	0.310
	24...60	20...60	NFZ22E-21	1SBH136001R2122	0.310
	48...130	48...130	NFZ22E-22	1SBH136001R2222	0.310
	100...250	100...250	NFZ22E-23	1SBH136001R2322	0.310
	-	12...20	NFZ31E-20	1SBH136001R2031	0.310
	24...60	20...60	NFZ31E-21	1SBH136001R2131	0.310
	48...130	48...130	NFZ31E-22	1SBH136001R2231	0.310
	100...250	100...250	NFZ31E-23	1SBH136001R2331	0.310
	-	12...20	NFZ40E-20	1SBH136001R2040	0.310
	24...60	20...60	NFZ40E-21	1SBH136001R2140	0.310
	48...130	48...130	NFZ40E-22	1SBH136001R2240	0.310
	100...250	100...250	NFZ40E-23	1SBH136001R2340	0.310

Note: Only NFZ contactor relays with DC control voltage 12...20 V DC need to respect the connection polarities indicated close to the coil terminals: A1+ for the positive pole and A2- for the negative pole.

Main dimensions mm, inches

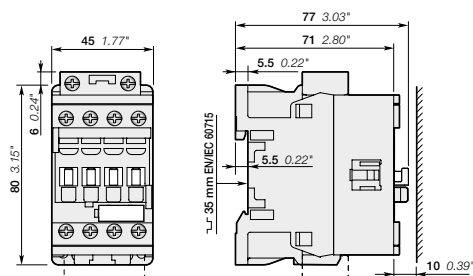

NFZ22E, NFZ31E, NFZ40E

NF 4-pole contactor relays

Main accessories

Contactor relays and main accessories (other accessories available)

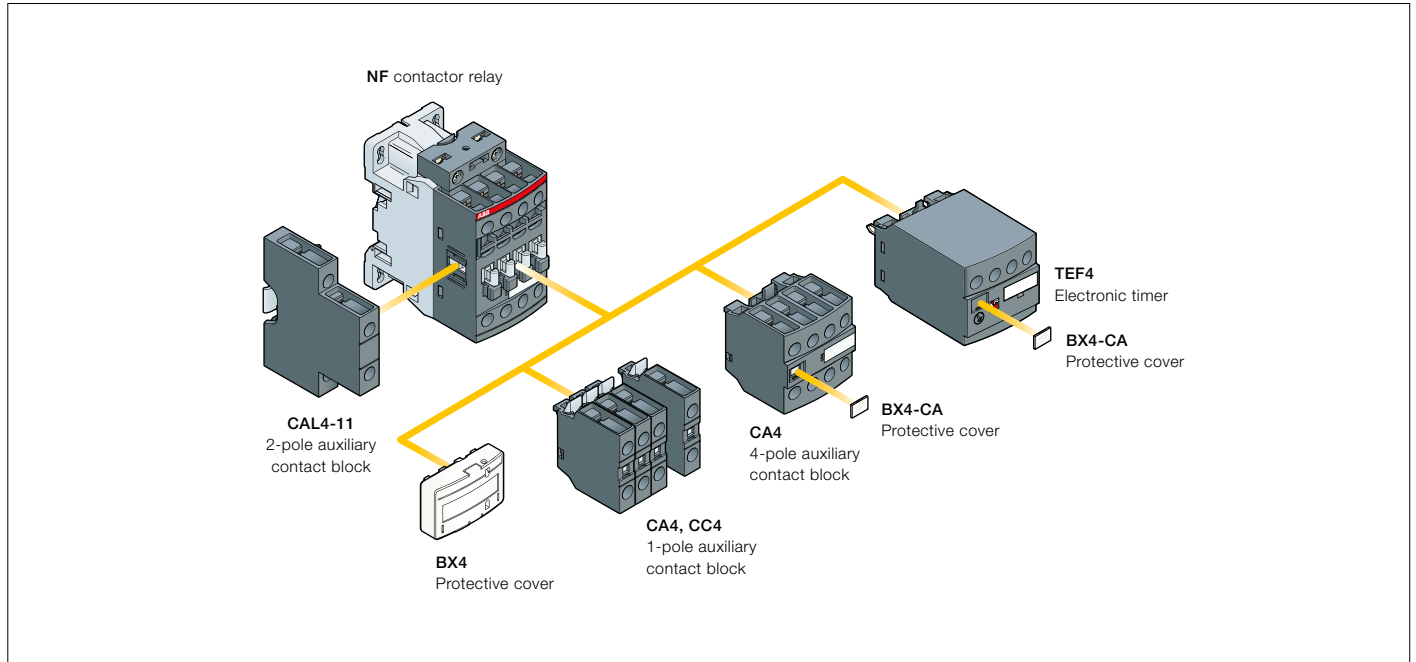

Main accessory fitting details

Many configurations of accessories are possible depending on whether these are front-mounted or side-mounted.

Contactor relay types	Main poles	Front-mounted accessories			Side-mounted accessories	
		Auxiliary contact blocks		Electronic timer	Auxiliary contact blocks	
		1-pole CA4	4-pole CA4	TEF4	Left side 2-pole CAL4-11	Right side
		Max. add-on N.C. auxiliary contacts: 3 N.C. max. on positions 1, 2, 3, 4 and 2 N.C. max. on positions 1 ±30°, 5				
NF	2 2 E	4 max.	or 1	or 1	+ 1	-
	3 1 E	2 max.	-	or 1	+ 1	+ 1
		Max. add-on N.C. auxiliary contacts: 4 N.C. max. on positions 1, 2, 3, 4 and 3 N.C. max. on positions 1 ±30°, 5				
NF	4 0 E	4 max.	or 1	or 1	+ 1	-
		2 max.	-	or 1	+ 1	+ 1

NF 4-pole contactor relays

Main accessories



CA4-10



CA4-22N



CAL4-11



TEF4-ON



LDC4



BX4



BX4-CA

Ordering details (1)

For contactor relays	Auxiliary contacts	Type	Order code	Pkg qty	Weight (1 pce)
					kg

Front-mounted instantaneous auxiliary contact blocks

4-pole NF	NO	NC	Type	Order code	Pkg qty	Weight (1 pce)
	1	0	CA4-10	1SBN010110R1010	1	0.014
	1	0	CA4-10-T	1SBN010110T1010	10	0.014
	0	1	CA4-01	1SBN010110R1001	1	0.014
	0	1	CA4-01-T	1SBN010110T1001	10	0.014
	4	0	CA4-40N	1SBN010140R1240	1	0.055
	3	1	CA4-31N	1SBN010140R1231	1	0.055
	2	2	CA4-22N	1SBN010140R1222	1	0.055
	1	3	CA4-13N	1SBN010140R1213	1	0.055
NF..40E	0	4	CA4-04N	1SBN010140R1204	1	0.055

Front-mounted auxiliary contact blocks with N.O. leading contact and N.C. lagging contact

4-pole NF	NO	NC	Type	Order code	Pkg qty	Weight (1 pce)
	-	-	CC4-10	1SBN010111R1010	1	0.014
	-	0	CC4-01	1SBN010111R1001	1	0.014

Side-mounted instantaneous auxiliary contact blocks

NF	NO	NC	Type	Order code	Pkg qty	Weight (1 pce)
	1	1	CAL4-11	1SBN010120R1011	1	0.040
	1	1	CAL4-11-T	1SBN010120T1011	10	0.040

For contactors	Time delay range selected by switch	Delay type	Auxiliary contacts	Type	Order code	Pkg qty	Weight (1 pce)
							kg

Electronic timers

NF	Time delay range	Delay type	NO	NC	Type	Order code	Pkg qty	Weight (1 pce)
	0.1...1 s	ON-delay	1	1	TEF4-ON	1SBN020112R1000	1	0.065
	1...10 s	OFF-delay	1	1	TEF4-OFF	1SBN020114R1000	1	0.065
	10...100 s							

Note: Rated control circuit voltage U_c 24...240 V 50/60 Hz or DC.

Additional coil terminal block

NF	Type	Order code	Pkg qty	Weight (1 pce)
	LDC4	1SBN070156T1000	10	0.010

Protective covers

All 1-stack contactor relays	Type	Order code	Pkg qty	Weight (1 pce)
	BX4	1SBN110108T1000	10	0.006
4-pole CA4 auxiliary contact blocks and TEF4 electronic timer	Type	Order code	Pkg qty	Weight (1 pce)
	BX4-CA	1SBN110109W1000	50	0.001

(1) For more information, refer to main catalog "Accessories" section.

Voltage code table

The below tables indicate the available coil voltages and corresponding digits for order codes. When placing an order, please give the order code. Select a standard contactor from ordering detail pages. Change the **coil voltage code** in the order code according to the table below. Example: for contactor AF400-30-11 and coil 100...250 V 50/60 Hz, the order code is 1SFL577001R7011.

AF09 ... AF370 3-pole contactors AF09 ... AF370 4-pole contactors

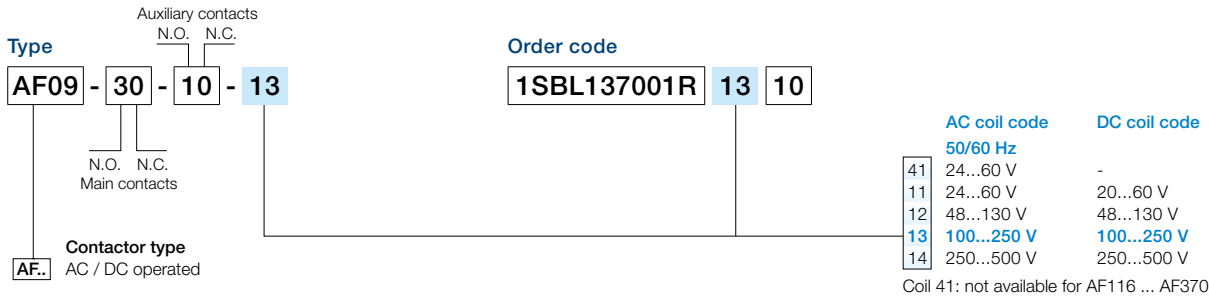

AF116 ... AF370 3-pole contactors with built-in PLC interface

	AC coil code 50/60 Hz	DC coil code
33	100...250 V	100...250 V
34	250...500 V	250...500 V

AF400 ... AF2650 3-pole contactors

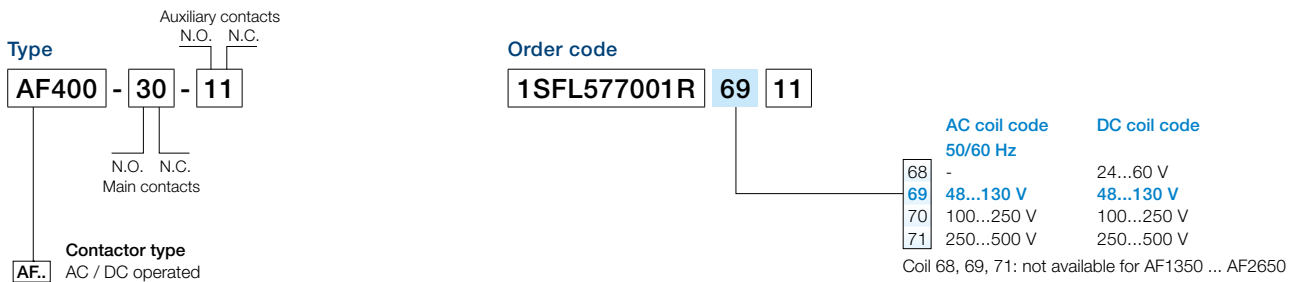

AF09 ... AF38 3- and 4-pole contactors - low consumption

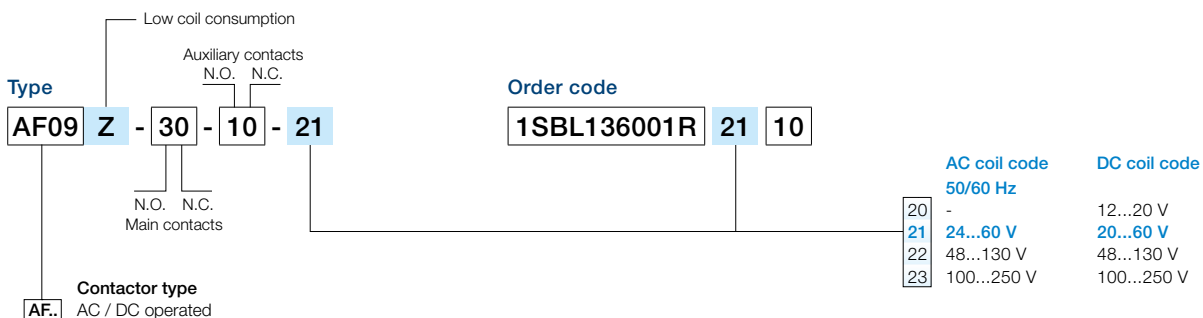

Voltage code table

NF contactor relays



NF contactor relays with overlapping of lagging / leading contacts

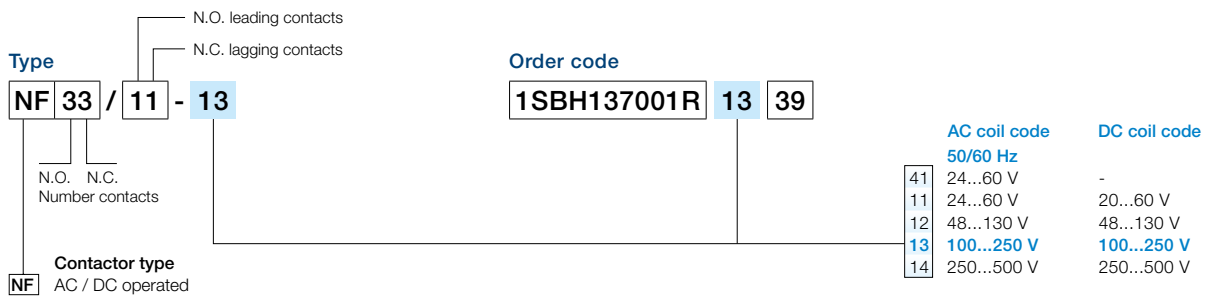

NF contactor relays - low consumption

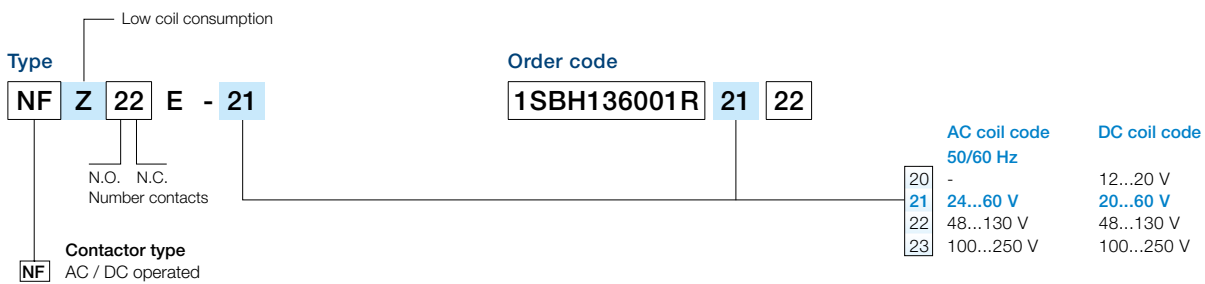

NF contactor relays with overlapping of lagging / leading contacts - low consumption

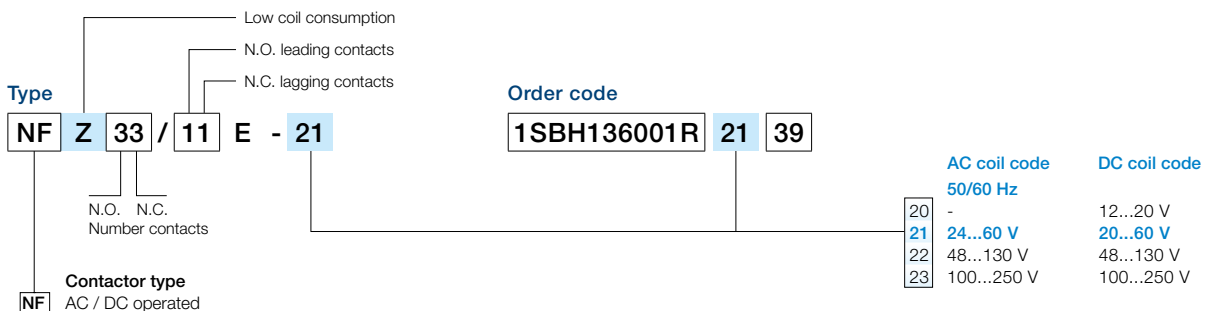

Voltage code table

UA, UA..RA contactors GA contactors

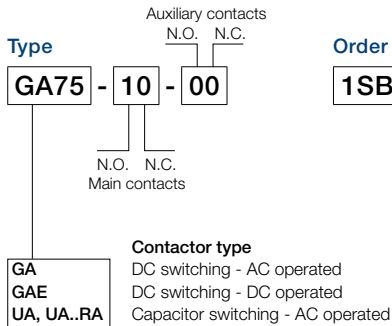

Order code
1SBL411025R **82** **00**

Contactors: UA, UA..RA, GA AC coil code

	50 Hz	60 Hz
81	24 V	24 V
16	26 V	28 V
17	28 V	32 V
82	42 V	42 V
20	42 V	48 V
83	48 V	48 V
73	60 V	60 V
74	100 V	100...110 V
26	105 V	110...127 V
84	110 V	110...120 V
89	110...115 V	115...127 V
29	120 V	140 V
30	125...127 V	150 V
34	175 V	208 V
36	190 V	220 V
40	210 V	240 V
80	220...230 V	230...240 V
88	230...240 V	240...260 V
42	230...240 V	277 V
85	380...400 V	400...415 V
86	400...415 V	415...440 V
50	400 V	440 V
51	400...415 V	480 V
87	415...440 V	440...460 V
53	440 V	500 V
55	500 V	600 V
56	550 V	-
58	660...690 V	-
59	-	690 V

Contactors: GAE DC coil code

80	12 V
81	24 V
82	42 V
83	48 V
21	50 V
84	60 V
85	75 V
86	110 V
87	125 V
88	220 V
89	240 V
38	250 V

Codes in bold for dual frequency coils.

EK550, EK1000 contactors

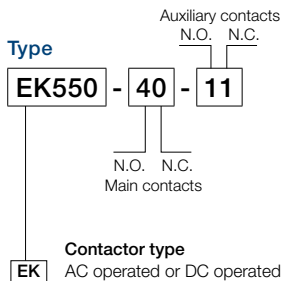

Order code
SK827041 - **AD**

AC coil code

	50 Hz	60 Hz
AD	48 V	-
AE	-	110 V
AF	110 V	120 V
AG	127 V	-
AZ	-	208 V
AH	190 V	220 V
AK	-	240 V
AL	220...230 V	240 V
AM	230...240 V	-
AN	-	380 V
AP	380...400 V	440 V
AR	400...415 V	-
AS	-	480 V
AT	440 V	-
AU	500 V	-
AV	-	600 V

Dual frequency coil code

	50 Hz	60 Hz
EF	110 V	110...120 V
EG	110...115 V	115...127 V
EL	220 V	220...240 V
EM	220...230 V	230...255 V
EP	380 V	380...415 V
ER	380...400 V	400...440 V

2 auxiliary contact blocks maximum per contactor, ambient temperature ≤ 55 °C and mounting positions 2 and 6 excluded.

DC coil code

DB	24 V
DC	36 V
DD	48 V
DT	60 V
DG	75 V
DE	110 V
DU	125 V
DF	220 V

Voltage code table

GAF185 ... GAF300 contactors

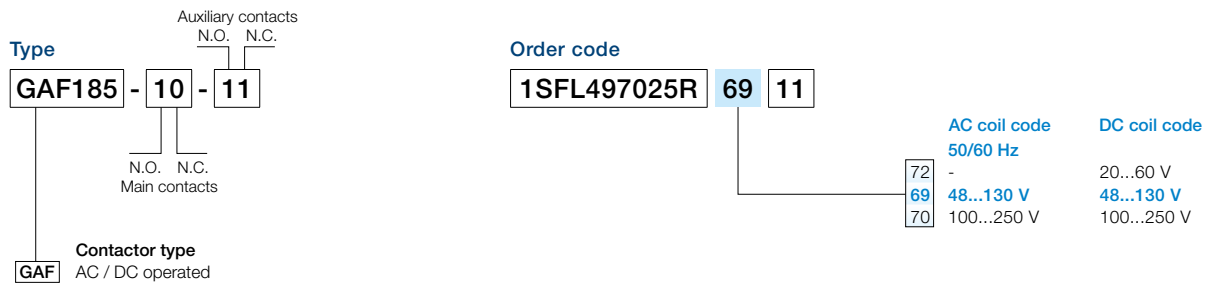

GAF460 ... GAF1250 contactors

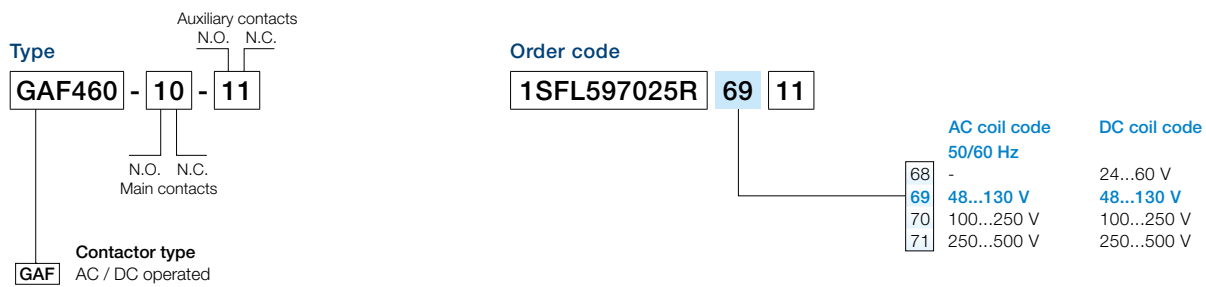

GAF1650, GAF2050 contactors

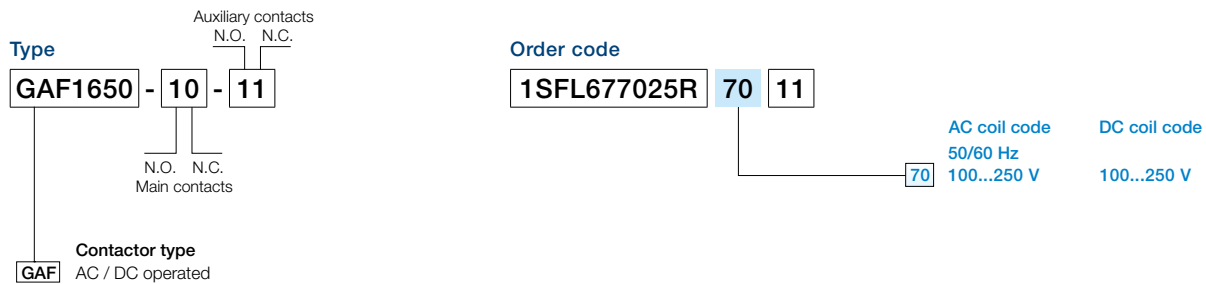



Overload relays

[Overview](#) 6/2

Thermal overload relays

T16 – 0.10 to 16.0 A	6/4
TF42 – 0.10 to 38.0 A	6/5
TF65 – 22.0 to 67.0 A	6/6
TF96 – 40.0 to 96.0 A	6/7
TF140DU – 66 to 142 A	6/8
TA200DU – 66 to 200 A	6/9

Electronic overload relays

E16DU, EF19, EF45 – 0.10 to 45.0 A	6/10
EF65, EF96, EF146 – 20 to 150 A	6/11
EF205, EF370 – 63 to 380 A	6/12
EF460, EF750 – 150 to 800 A	6/13
E1250DU – 375 to 1250 A	6/14

[General accessories](#) 6/15

For direct product details information, use product type or order code, ex:
www.abb.com/productdetails/AF09-30-10-13 or www.abb.com/productdetails/1SBL137001R1310

Thermal and electronic overload relays

Thermal overload relays

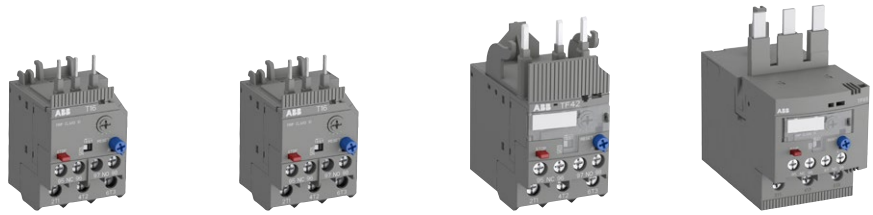

IEC: rated operational power AC-3	400 V	0.03 ... 4.0 kW	0.03 ... 4.0 kW	4.0 ... 18.5 kW	18.5 ... 30 kW
UL/CSA: 3-phase hp-ratings	480 V	1/2 ... 5 hp	1/2 ... 10 hp	5 ... 20 hp	30 ... 60 hp
Fitting to contactors		B6, B7	AS09 ... AS16	AF09 ... AF38	AF40, AF52, AF65
Type		T16	T16	TF42	TF65
Current range		0.10 ... 16 A	0.10 ... 16 A	0.10 ... 38 A	22 ... 67 A
Trip class		10	10	10	10
Single mounting kit		DB16	DB16	DB42	-

6

Electronic overload relays with integrated CT

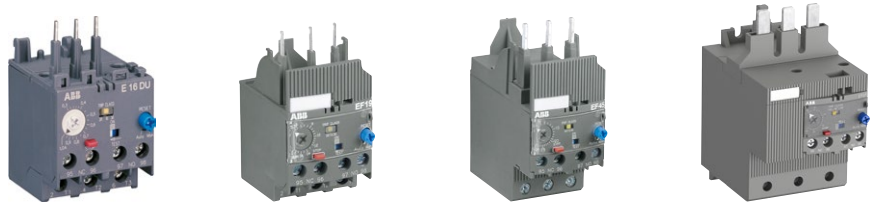

IEC: rated operational power AC-3	400 V	4 ... 7.5 kW	4 ... 7.5 kW	4.0 ... 18.5 kW	18.5 ... 30 kW
UL/CSA: 3-phase hp-ratings	480 V	5 ... 10 hp	5 ... 10 hp	5 ... 20 hp	30 ... 60 hp
Fitting to contactors		B6, B7, BC6, BC7, A09 ... A16, AL09 ... AL16, VB6, VB7, VBC6, VBC7	AF09 ... AF16	AF26 ... AF38	AF40, AF52, AF65
Type		E16DU	EF19	EF45	EF65
Current range		0.10 ... 18.9 A	0.10 ... 18.9 A	9 ... 45 A	20 ... 70 A
Trip class		10E, 20E, 30E selectable			
Single mounting kit		DB16E	DB19EF	-	-

Electronic overload relays with external separate CT

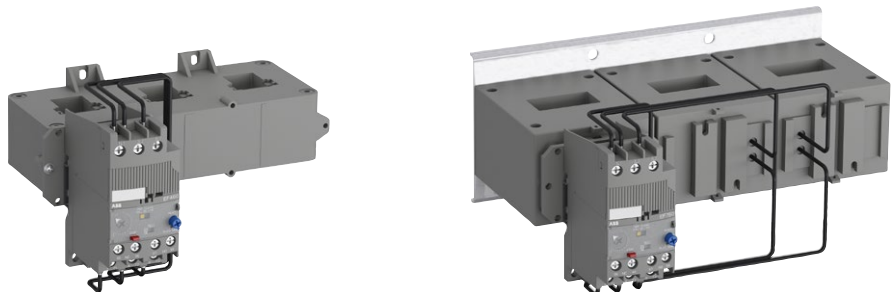

IEC: rated operational power AC-3	400 V	200 ... 250 kW	315 ... 400 kW
UL/CSA: 3-phase hp-ratings	480 V	350 ... 400 hp	500 ... 600 hp
Fitting to contactors		AF400, AF460	AF580, AF750, AF1250
Type		EF460	EF750
Current range		150 ... 500 A	250 ... 800 A
Trip class		10E, 20E, 30E selectable	

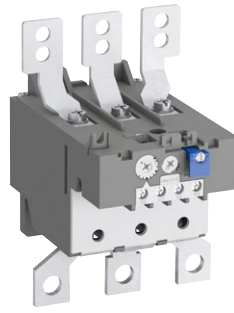

37 ... 45 kW

60 hp

AF80, AF96

TF96

40 ... 96 A

10

-

55 ... 75 kW

75 ... 100 hp

AF116, AF140

TF140DU

66 ... 142 A

10A

-

90 ... 110 kW

125 ... 150 hp

AF190, AF205

TA200DU

66 ... 200 A

10A

DB200

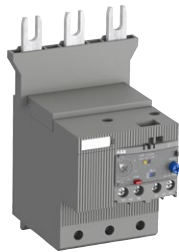

37 ... 45 kW

60 hp

AF80, AF96

EF96

36 ... 100 A

10E, 20E, 30E selectable

-

55 ... 75 kW

75 ... 100 hp

AF116, AF140, AF146

EF146

54 ... 150 A

-

90 ... 110 kW

125 ... 150 hp

AF190, AF205

EF205

63 ... 210 A

-

132 ... 200 kW

200 ... 350 hp

AF265, AF305, AF370

EF370

115 ... 380 A

-

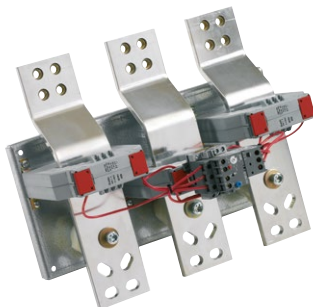

475 ... 560 kW

800 ... 900 hp

AF1350, AF1650

E1250DU

375 ... 1250 A

10E, 20E, 30E selectable

T16 thermal overload relays – 0.10 to 16.0 A

Ordering details



2CDC231009F0013

T16



2CDC231029F0013

T16 + DB16



1SFC151224F0002

KPR-101L



2CDC231002F0011

DB16

Description

The T16 thermal overload relays are economic electromechanical protection devices for the main circuit. They offer reliable protection for motors in the event of overload or phase failure. The devices have trip class 10.

The thermal overload relays are three pole relays with bimetal tripping elements. The motor current flows through the bimetal tripping elements and heats them directly and indirectly. In case of an overload (over current), the bimetal elements bent as a result of the heating. This leads to a release of the relay and a change of the contacts switching position (95-96 / 97-98).

- Manual or automatic reset selectable
- Phase loss sensitive acc. to IEC/EN 60947-4-1
- TEST and STOP function – Trip indication on the front
- Temperature compensation
- Suitable for three- and single-phase applications

Ordering details

Setting range	Short-circuit protective device	Trip class	Type	Order code	Weight (1 pc) kg
A					
0.10 ... 0.13	0.5 A, fuse type T	10	T16-0.13	1SAZ711201R1005	0.100
0.13 ... 0.17	1.0 A, fuse type T	10	T16-0.17	1SAZ711201R1008	0.100
0.17 ... 0.23	1.0 A, fuse type T	10	T16-0.23	1SAZ711201R1009	0.100
0.23 ... 0.31	1.0 A, fuse type T	10	T16-0.31	1SAZ711201R1013	0.100
0.31 ... 0.41	2.0 A, fuse type gG	10	T16-0.41	1SAZ711201R1014	0.100
0.41 ... 0.55	2.0 A, fuse type gG	10	T16-0.55	1SAZ711201R1017	0.100
0.55 ... 0.74	4.0 A, fuse type gG	10	T16-0.74	1SAZ711201R1021	0.100
0.74 ... 1.00	6.0 A, fuse type gG	10	T16-1.0	1SAZ711201R1023	0.100
1.00 ... 1.30	6.0 A, fuse type gG	10	T16-1.3	1SAZ711201R1025	0.100
1.30 ... 1.70	10.0 A, fuse type gG	10	T16-1.7	1SAZ711201R1028	0.100
1.70 ... 2.30	10.0 A, fuse type gG	10	T16-2.3	1SAZ711201R1031	0.100
2.30 ... 3.10	10.0 A, fuse type gG	10	T16-3.1	1SAZ711201R1033	0.100
3.10 ... 4.20	20.0 A, fuse type gG	10	T16-4.2	1SAZ711201R1035	0.100
4.20 ... 5.70	20.0 A, fuse type gG	10	T16-5.7	1SAZ711201R1038	0.100
5.70 ... 7.60	35.0 A, fuse type gG	10	T16-7.6	1SAZ711201R1040	0.100
7.60 ... 10.0	35.0 A, fuse type gG	10	T16-10	1SAZ711201R1043	0.104
10.0 ... 13.0	40.0 A, fuse type gG	10	T16-13	1SAZ711201R1045	0.104
13.0 ... 16.0	40.0 A, fuse type gG	10	T16-16	1SAZ711201R1047	0.104

Ordering details accessories

Suitable for	Description	Type	Order code	Weight (1 pc) kg
T16	Single mounting kit	DB16	1SAZ701901R0001	0.032
T16	Reset push button*	KPR-101L	1SFA616162R1014	0.027

*Note: for more information see catalog 1SFC151004C0201

Main dimensions mm, inches

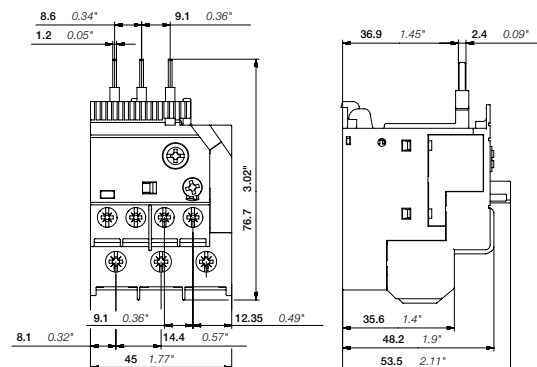

T16

2CDC232009F0008

2CDC106036C0201a

TF42 thermal overload relays – 0.10 to 38.0 A

Ordering details



2CDC231009F0013

TF42



2CDC231009F0011

DB42



2CDC231026F0013

TF42 + DB42



1SFC151224F0002

KPR-101L

Description

The TF42 thermal overload relays are economic electromechanical protection devices for the main circuit. They offer reliable protection for motors in the event of overload or phase failure. The devices have trip class 10.

The thermal overload relays are three pole relays with bimetal tripping elements. The motor current flows through the bimetal tripping elements and heats them directly and indirectly. In case of an overload (over current), the bimetal elements bent as a result of the heating. This leads to a release of the relay and a change of the contacts switching position (95-96 / 97-98).

- Manual or automatic reset selectable
- Phase loss sensitive acc. to IEC/EN 60947-4-1
- TEST and STOP function – Trip indication on the front
- Temperature compensation
- Suitable for three- and single-phase applications
- With ATEX certification

Ordering details

Setting range	Short-circuit protective device	Trip class	Type	Order code	Weight (1 pc) kg
0.10 ... 0.13	0.5 A, fuse type T	10	TF42-0.13	1SAZ721201R1005	0.130
0.13 ... 0.17	1.0 A, fuse type T	10	TF42-0.17	1SAZ721201R1008	0.130
0.17 ... 0.23	1.0 A, fuse type T	10	TF42-0.23	1SAZ721201R1009	0.130
0.23 ... 0.31	1.0 A, fuse type T	10	TF42-0.31	1SAZ721201R1013	0.130
0.31 ... 0.41	2.0 A, fuse type gG	10	TF42-0.41	1SAZ721201R1014	0.130
0.41 ... 0.55	2.0 A, fuse type gG	10	TF42-0.55	1SAZ721201R1017	0.130
0.55 ... 0.74	4.0 A, fuse type gG	10	TF42-0.74	1SAZ721201R1021	0.130
0.74 ... 1.00	6.0 A, fuse type gG	10	TF42-1.0	1SAZ721201R1023	0.130
1.00 ... 1.30	6.0 A, fuse type gG	10	TF42-1.3	1SAZ721201R1025	0.130
1.30 ... 1.70	10.0 A, fuse type gG	10	TF42-1.7	1SAZ721201R1028	0.130
1.70 ... 2.30	10.0 A, fuse type gG	10	TF42-2.3	1SAZ721201R1031	0.130
2.30 ... 3.10	10.0 A, fuse type gG	10	TF42-3.1	1SAZ721201R1033	0.130
3.10 ... 4.20	20.0 A, fuse type gG	10	TF42-4.2	1SAZ721201R1035	0.130
4.20 ... 5.70	20.0 A, fuse type gG	10	TF42-5.7	1SAZ721201R1038	0.130
5.70 ... 7.60	35.0 A, fuse type gG	10	TF42-7.6	1SAZ721201R1040	0.130
7.60 ... 10.0	35.0 A, fuse type gG	10	TF42-10	1SAZ721201R1043	0.130
10.0 ... 13.0	40.0 A, fuse type gG	10	TF42-13	1SAZ721201R1045	0.130
13.0 ... 16.0	40.0 A, fuse type gG	10	TF42-16	1SAZ721201R1047	0.130
16.0 ... 20.0	63.0 A, fuse type gG	10	TF42-20	1SAZ721201R1049	0.145
20.0 ... 24.0	63.0 A, fuse type gG	10	TF42-24	1SAZ721201R1051	0.145
24.0 ... 29.0	63.0 A, fuse type gG	10	TF42-29	1SAZ721201R1052	0.145
29.0 ... 35.0	80.0 A, fuse type gG	10	TF42-35	1SAZ721201R1053	0.145
35.0 ... 38.0/40.0	80.0 A, fuse type gG	10	TF42-38	1SAZ721201R1055	0.145

Ordering details accessories

Suitable for	Description	Type	Order code	Weight (1 pc) kg
TF42	Single mounting kit	DB42	1SAZ701902R0001	0.087
TF42	Reset push button*	KPR-101L	1SFA616162R1014	0.027

*Note: for more information see catalog 1SFC151004C0201

Main dimensions mm, inches

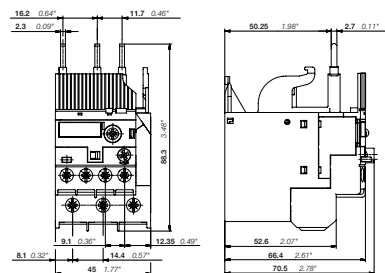

TF42

2CDC232005F0009

2CDC106046C0201a

TF65 thermal overload relays – 22.0 to 67.0 A

Ordering details



2CDC231004F0013

TF65



2CDC231003V0015

DB65



2CDC231004W0015

DB65 + TF65



1SFC151224F0002

KPR-101L

Description

The TF65 thermal overload relays are economic electromechanical protection devices for the main circuit. They offer reliable protection for motors in the event of overload or phase failure. The devices have trip class 10.

The thermal overload relays are three pole relays with bimetal tripping elements. The motor current flows through the bimetal tripping elements and heats them directly and indirectly. In case of an overload (over current), the bimetal elements bent as a result of the heating. This leads to a release of the relay and a change of the contacts switching position (95-96 / 97-98).

- Manual or automatic reset selectable
- Phase loss sensitive acc. to IEC/EN 60947-4-1
- TEST and STOP function – Trip indication on the front
- Temperature compensation
- Suitable for three- and single-phase applications
- With ATEX certification ¹⁾

Ordering details

Setting range	Short-circuit protective device	Trip class	Type	Order code	Weight (1 pc) kg
A					
22.0 ... 28.0	80 A, gG Type Fuses	10	TF65-28	1SAZ811201R1001	0.456
25.0 ... 33.0	80 A, gG Type Fuses	10	TF65-33	1SAZ811201R1002	0.456
30.0 ... 40.0	100 A, gG Type Fuses	10	TF65-40	1SAZ811201R1003	0.456
36.0 ... 47.0	125 A, gG Type Fuses	10	TF65-47	1SAZ811201R1004	0.456
44.0 ... 53.0	125 A, gG Type Fuses	10	TF65-53	1SAZ811201R1005	0.456
50.0 ... 60.0	125 A, gG Type Fuses	10	TF65-60	1SAZ811201R1006	0.466
57.0 ... 67.0	160 A, gG Type Fuses	10	TF65-67	1SAZ811201R1007	0.466

Ordering details accessories

Suitable for	Description	Type	Order code	Weight (1 pc) kg
TF65	Single mounting kit	DB65	1SAZ801901R1001	0.132
TF65	Reset push button ²⁾	KPR-101L	1SFA616162R1014	0.027

¹⁾ ATEX is valid for products, produced from week 26, 2015

²⁾ Note: for more information see catalog 1SFC151004C0201

Main dimensions mm, inches

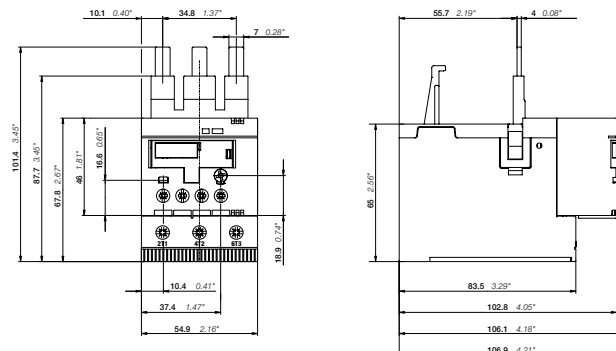

TF65

TF96 thermal overload relays – 40.0 to 96.0 A

Ordering details



TF96

2CDC231005F0013

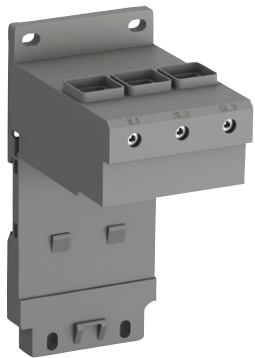

DB96

2CDC231001V0015



DB96 + TF96

2CDC231005V0015



KPR-101L

1SFC151224FV002

Description

The TF96 thermal overload relays are economic electromechanical protection devices for the main circuit. They offer reliable protection for motors in the event of overload or phase failure. The devices have trip class 10.

The thermal overload relays are three pole relays with bimetal tripping elements. The motor current flows through the bimetal tripping elements and heats them directly and indirectly. In case of an overload (over current), the bimetal elements bent as a result of the heating. This leads to a release of the relay and a change of the contacts switching position (95-96 / 97-98).

- Manual or automatic reset selectable
- Phase loss sensitive acc. to IEC/EN 60947-4-1
- TEST and STOP function – Trip indication on the front
- Temperature compensation
- Suitable for three- and single-phase applications
- With ATEX certification ¹⁾

Ordering details

Setting range	Short-circuit protective device	Trip class	Type	Order code	Weight (1 pc) kg
A					
40.0 ... 51.0	125 A, gG Type Fuses	10	TF96-51	1SAZ911201R1001	0.620
48.0 ... 60.0	160 A, gG Type Fuses	10	TF96-60	1SAZ911201R1002	0.620
57.0 ... 68.0	160 A, gG Type Fuses	10	TF96-68	1SAZ911201R1003	0.620
65.0 ... 78.0	200 A, gG Type Fuses	10	TF96-78	1SAZ911201R1004	0.620
75.0 ... 87.0	200 A, gG Type Fuses	10	TF96-87	1SAZ911201R1005	0.620
84.0 ... 96.0	250 A, gG Type Fuses	10	TF96-96	1SAZ911201R1006	0.630

Ordering details accessories

Suitable for	Description	Type	Order code	Weight (1 pc) kg
TF96, EF96	Single mounting kit	DB96	1SAZ901901R1001	0.190
TF96	Reset push button ²⁾	KPR-101L	1SFA616162R1014	0.027

¹⁾ ATEX is valid for products, produced from week 26, 2015

²⁾ Note: for more information see catalog 1SFC151004C0201a

Main dimensions mm, inches

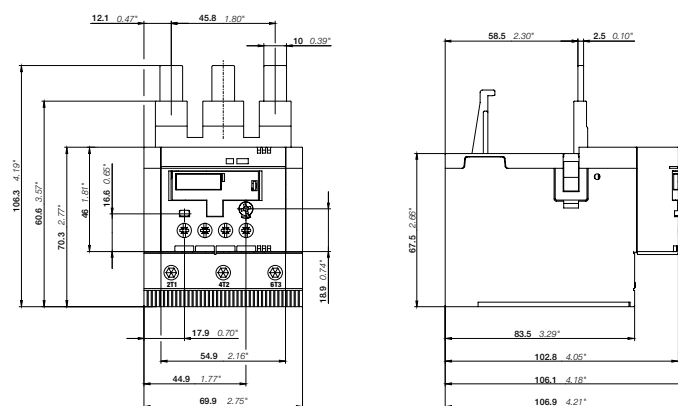

TF96

2CDC232005F0009

2CDC106064C0201a

TF140DU thermal overload relays – 66 to 142 A

Ordering details



2CDC231012P0012

TF140DU



1SFC151224F0002

KPR-101L

6

Description

The TF140DU thermal overload relays are economic electromechanical protection devices for the main circuit. They offer reliable protection for motors in the event of overload or phase failure. The devices have trip class 10A.

The thermal overload relays are three pole relays with bimetal tripping elements. The motor current flows through the bimetal tripping elements and heats them directly and indirectly. In case of an overload (over current), the bimetal elements bent as a result of the heating. This leads to a release of the relay and a change of the contacts switching position (95-96 / 97-98).

- Manual or automatic reset selectable
- Phase loss sensitive acc. to IEC/EN 60947-4-1
- TEST and STOP function – Trip indication on the front
- Temperature compensation
- Suitable for three- and single-phase applications
- ATEX variants available

Ordering details

Setting range	Short-circuit protective device	Trip class	Type	Order code	Weight (1 pc) kg
A					
66 ... 90	200 A, fuse type gG	10A	TF140DU-90	1SAZ431201R1001	0.820
80 ... 110	224 A, fuse type gG	10A	TF140DU-110	1SAZ431201R1002	0.820
100 ... 135	224 A, fuse type gG	10A	TF140DU-135	1SAZ431201R1003	0.820
110 ... 142	250 A, fuse type gG	10A	TF140DU-142	1SAZ431201R1004	0.820
66 ... 90	200 A, fuse type gG	10A	TF140DU-90-V1000*	1SAZ431301R1001	0.820
80 ... 110	224 A, fuse type gG	10A	TF140DU-110-V1000*	1SAZ431301R1002	0.820
100 ... 135	224 A, fuse type gG	10A	TF140DU-135-V1000*	1SAZ431301R1003	0.820
110 ... 142	250 A, fuse type gG	10A	TF140DU-142-V1000*	1SAZ431301R1004	0.820

*Note: ATEX variant

Ordering details accessories

Suitable for	Description	Type	Order code	Weight (1 pc) kg
TF140DU	Reset push button*	KPR-101L	1SFA616162R1014	0.027

*Note: for more information see catalog 1SFC151004C0201

Main dimensions mm, inches

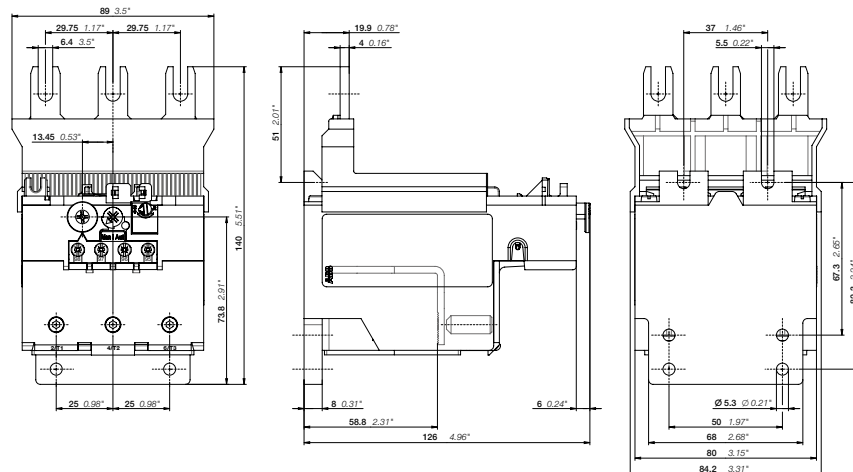

TF140DU

2CDC232008F0012

2CDC106054C0201a

TA200DU thermal overload relays – 66 to 200 A

Ordering details

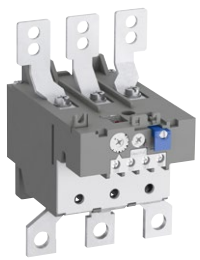

2CDC23016F0013

TA200DU



1SFC151224F0002

KPR-101L

Description

The TA200DU thermal overload relays are economic electromechanical protection devices for the main circuit. They offer reliable protection for motors in the event of overload or phase failure. The devices have trip class 10A.

The thermal overload relays are three pole relays with bimetal tripping elements. The motor current flows through the bimetal tripping elements and heats them directly and indirectly. In case of an overload (over current), the bimetal elements bent as a result of the heating. This leads to a release of the relay and a change of the contacts switching position (95-96 / 97-98).

- Manual or automatic reset selectable
- Phase loss sensitive acc. to IEC/EN 60947-4-1
- TEST and STOP function – Trip indication on the front
- Temperature compensation
- Suitable for three- and single-phase applications

Ordering details

Setting range	Short-circuit protective device	Trip class	Type	Order code	Weight (1 pc) kg
A					
66 ... 90	200 A, fuse type gG / 125 A aM	10A	TA200DU-90	1SAZ421201R1001	0.755
80 ... 110	224 A, fuse type gG / 160 A aM	10A	TA200DU-110	1SAZ421201R1002	0.760
100 ... 135	224 A, fuse type gG / 200 A aM	10A	TA200DU-135	1SAZ421201R1003	0.760
110 ... 150	250 A, fuse type gG / 200 A aM	10A	TA200DU-150	1SAZ421201R1004	0.760
130 ... 175	315 A, fuse type gG / 250 A aM	10A	TA200DU-175	1SAZ421201R1005	0.770
150 ... 200	315 A, fuse type gG / 250 A aM	10A	TA200DU-200	1SAZ421201R1006	0.785

Ordering details accessories

Suitable for	Description	Type	Order code	Weight (1 pc) kg
TA200DU	Terminal shroud	LT200/A	1SAZ401901R1001	0.090
TA200DU	Single mounting kit	DB200	1SAZ401110R0001	0.225
TA200DU	Reset push button*	KPR-101L	1SFA616162R1014	0.027

*Note: for more information see catalog 1SFC151004C0201

Main dimensions mm, inches

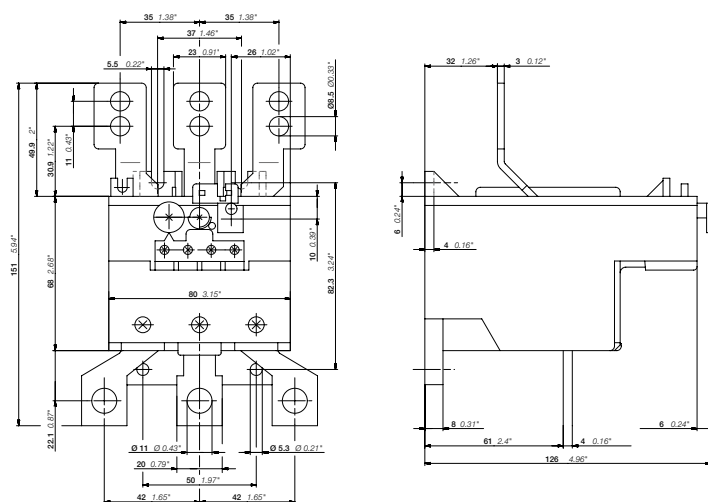

TA200DU

2CDC23021 F0011

2CDC106038C0201a

E16DU, EF19, EF45 electronic overload relays – 0.10 to 45.0 A

Ordering details



2CDC231001R0007

E16DU-1.0



1SFC101147FC010

EF19-18.9



1SBC101148P0010

EF45-30

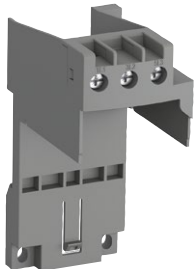

2CDC231024V0013

DB19EF



2CDC231002V0014

DB45EF



1SFC151224F0002

KPR-101L

Description

The E16DU, EF19 and EF45 are self-supplied electronic overload relays, which means no extra external supply is needed. It offers reliable protection for motors in the event of overload or phase failure. Easy to use like a thermal overload relay and compatible with standard motor applications, the electronic overload relay is convincing, above all, due to its wide setting range, high accuracy, high operational temperature range and the possibility to select a trip class (10E, 20E, 30E). Further features are the temperature compensation, trip contact (N.C.), signal contact (N.O.), automatic or manual reset selectable, trip-free mechanism, STOP and TEST function and a trip indication. The overload relays are connected directly to the contactors.

Ordering details

Setting range	Short-circuit protective device	Trip class	Type	Order code	Weight (1 pc) kg
---------------	---------------------------------	------------	------	------------	------------------

E16DU electronic overload relays					
0.10 ... 0.32	1 A, fuse type gG	10E, 20E, 30E	E16DU-0.32	1SAX111001R1101	0.150
0.30 ... 1.00	4 A, fuse type gG	10E, 20E, 30E	E16DU-1.0	1SAX111001R1102	0.150
0.80 ... 2.70	10 A, fuse type gG	10E, 20E, 30E	E16DU-2.7	1SAX111001R1103	0.150
2.00 ... 6.30	20 A, fuse type gG	10E, 20E, 30E	E16DU-6.3	1SAX111001R1104	0.150
5.70 ... 18.9	50 A, fuse type gG	10E, 20E, 30E	E16DU-18.9	1SAX111001R1105	0.150

EF19 electronic overload relays					
0.10 ... 0.32	1 A, fuse type gG	10E, 20E, 30E	EF19-0.32	1SAX121001R1101	0.158
0.30 ... 1.00	4 A, fuse type gG	10E, 20E, 30E	EF19-1.0	1SAX121001R1102	0.158
0.80 ... 2.70	10 A, fuse type gG	10E, 20E, 30E	EF19-2.7	1SAX121001R1103	0.158
1.90 ... 6.30	20 A, fuse type gG	10E, 20E, 30E	EF19-6.3	1SAX121001R1104	0.158
5.70 ... 18.9	50 A, fuse type gG	10E, 20E, 30E	EF19-18.9	1SAX121001R1105	0.158

EF45 electronic overload relays					
9.00 ... 30.0	160 A, fuse type gG	10E, 20E, 30E	EF45-30	1SAX221001R1101	0.362
15.0 ... 45.0	160 A, fuse type gG	10E, 20E, 30E	EF45-45	1SAX221001R1102	0.362

Ordering details accessories

Suitable for	Description	Type	Order code	Weight (1 pc) kg
E16DU	Single mounting kit	DB16E	1SAX101110R0001	0.035
EF19	Single mounting kit	DB19EF	1SAX101910R1001	0.046
EF45	Single mounting kit	DB45EF	1SAX201910R0001	0.100
E16DU, EF19, EF45	Reset push button*	KPR-101L	1SFA616162R1014	0.019

*Note: for more information see catalog 1SFC151004C0201

Main dimensions mm, inches

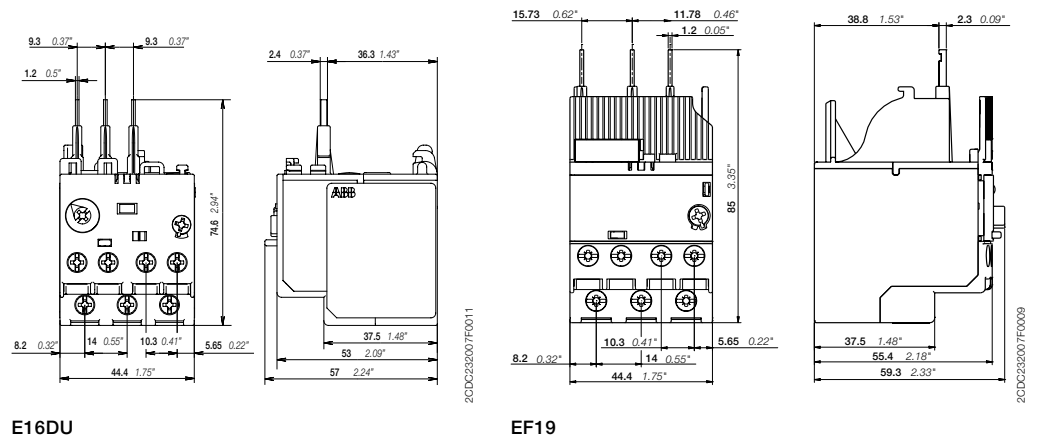

EF65, EF96, EF146 electronic overload relays – 20 to 150 A

Ordering details



EF65-70

2CDC231001F0012



EF96-100

2CDC231002F0012



EF146-150

2CDC231003F0012



DB96

2CDC231001V0015



DB96 + EF96

2CDC231002V0015



KPR-101L

1SFC15124F0002

Description

The EF65, EF96 and EF146 are self-supplied electronic overload relays, which means no extra external supply is needed. It offers reliable protection for motors in the event of overload or phase failure. Easy to use like a thermal overload relay and compatible with standard motor applications, the electronic overload relay is convincing, above all, due to its wide setting range, high accuracy, high operational temperature range and the possibility to select a trip class (10E, 20E, 30E). Further features are the temperature compensation, trip contact (N.C.), signal contact (N.O.), automatic or manual reset selectable, trip-free mechanism, STOP and TEST function and a trip indication. The overload relays are connected directly to the contactors.

Ordering details

Setting range	Short-circuit protective device	Trip class	Type	Order code	Weight (1 pc) kg
A					
20 ... 56	160 A, fuse type gG	10E, 20E, 30E	EF65-56	1SAX331001R1102	0.821
25 ... 70	160 A, fuse type gG	10E, 20E, 30E	EF65-70	1SAX331001R1101	0.821
36 ... 100	200 A, fuse type gG	10E, 20E, 30E	EF96-100	1SAX341001R1101	0.802
54 ... 150	315 A, fuse type gG	10E, 20E, 30E	EF146-150	1SAX351001R1101	0.879

Ordering details accessories

Suitable for	Description	Type	Order code	Weight (1 pc) kg
EF96, TF96	Single mounting kit	DB96	1SAZ901901R1001	0.190
EF65, EF96, EF146	Reset push button*	KPR-101L	1SFA616162R1014	0.019

*Note: for more information see catalog 1SFC151004C0201

Main dimensions mm, inches

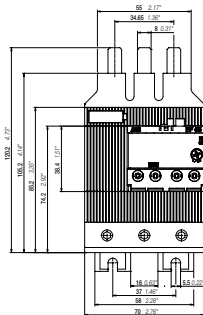

EF65-56 / EF65-70

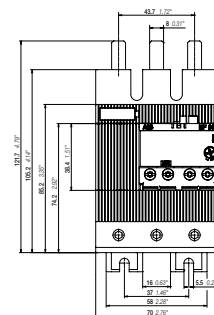
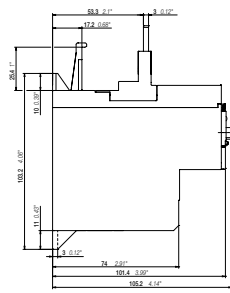

EF96-100

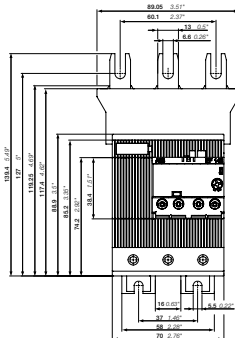

EF146-150

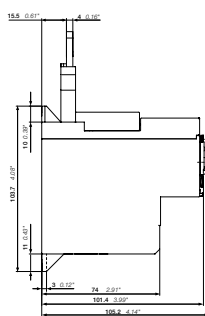

EF205, EF370 electronic overload relays – 63 to 380 A

Ordering details



2CDC231004F0012

EF205-210



2CDC231006F0012

EF370-380



1SFC15124F0002

KPR-101L

Description

The EF205 and EF370 are self-supplied electronic overload relays, which means no extra external supply is needed. It offers reliable protection for motors in the event of overload or phase failure. Easy to use like a thermal overload relay and compatible with standard motor applications, the electronic overload relay is convincing, above all, due to its wide setting range, high accuracy, high operational temperature range and the possibility to select a trip class (10E, 20E, 30E). Further features are the temperature compensation, trip contact (N.C.), signal contact (N.O.), automatic or manual reset selectable, trip-free mechanism, STOP and TEST function and a trip indication. The overload relays are connected directly to the contactors.

Ordering details

Setting range	Short-circuit protective device	Trip class	Type	Order code	Weight (1 pc) kg
A					
63 ... 210	1250 A, fuse type gG	10E, 20E, 30E	EF205-210	1SAX531001R1101	1.210
115 ... 380	1600 A, fuse type gG	10E, 20E, 30E	EF370-380	1SAX611001R1101	1.430

Ordering details accessories

Suitable for	Description	Type	Order code	Weight (1 pc) kg
EF205, EF370	Reset push button*	KPR-101L	1SFA616162R1014	0.027

*Note: for more information see catalog 1SFC151004C0201

Main dimensions mm, inches

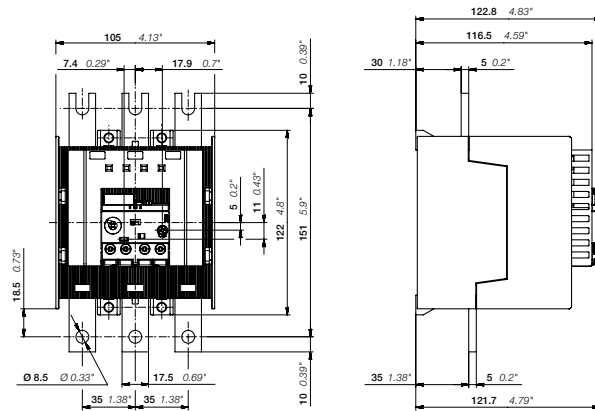

2CDC231004F0012

EF205-210

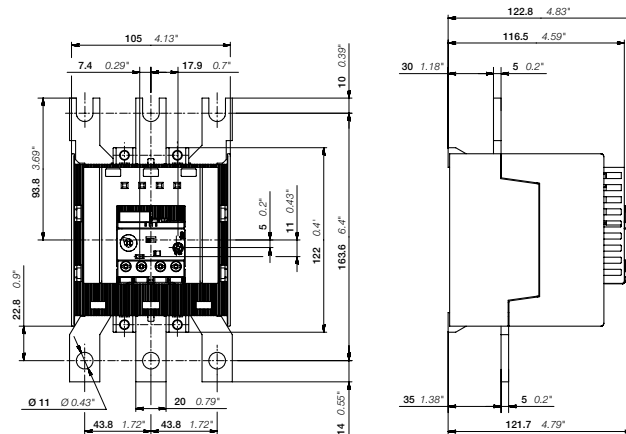

2CDC231006F0012

EF370-380

EF460, EF750 electronic overload relays – 150 to 800 A

Ordering details



2CDC231014R0013

EF460-500



2CDC231014R0013

EF750-800



1SFC151224R0002

KPR-101L

Description

The EF460 and EF750 are self-supplied electronic overload relays, which means no extra external supply is needed. It offers reliable protection for motors in the event of overload or phase failure. Easy to use like a thermal overload relay and compatible with standard motor applications, the electronic overload relay is convincing, above all, due to its wide setting range, high accuracy, high operational temperature range and the possibility to select a trip class (10E, 20E, 30E). Further features are the temperature compensation, trip contact (N.C.), signal contact (N.O.), automatic or manual reset selectable, trip-free mechanism, STOP and TEST function and a trip indication. Busbar kits are available as accessory for contactor mounting.

Ordering details

Setting range	Short-circuit protective device	Trip class	Type	Order code	Weight (1 pc) kg
A					
EF460 electronic overload relay					
150 ... 500	690 V: 630 A, Type gG 1000 V: 1600 A, Type gG	10E, 20E, 30E	EF460-500	1SAX721001R1101	1.170
EF750 electronic overload relay					
250 ... 800	690 V: 800 A, Type gG 1000 V: 1600 A, Type gG	10E, 20E, 30E	EF750-800	1SAX821001R1101	3.905

Ordering details accessories

Suitable for	Description	Type	Order code	Weight (1 pc) kg
EF460, EF750	Reset push button*	KPR-101L	1SFA616162R1014	0.027

*Note: for more information see catalog 1SFC151004C0201

Main dimensions mm, inches

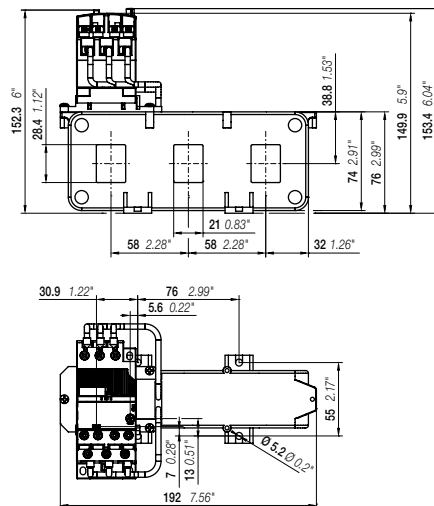

EF460-500

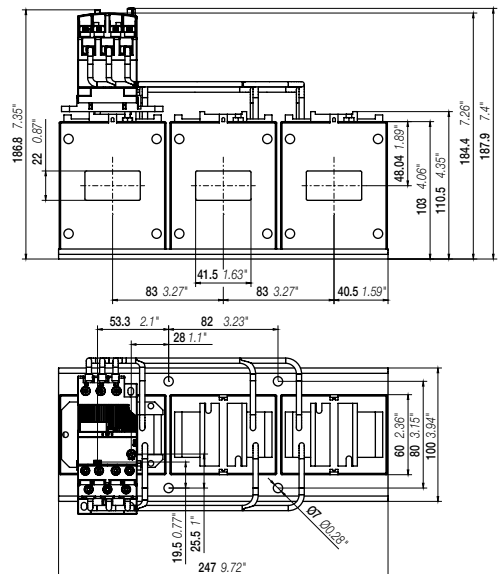

EF750-800

E1250DU electronic overload relays – 375 to 1250 A

Ordering details

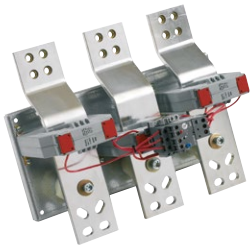

1SFA739001R1000

E1250DU-1250

Description

The E1250DU are self-supplied electronic overload relays, which means no extra external supply is needed. It offers reliable protection for motors in the event of overload or phase failure. Easy to use like a thermal overload relay and compatible with standard motor applications, the electronic overload relay is convincing, above all, due to its wide setting range, high accuracy, high operational temperature range and the possibility to select a trip class (10E, 20E, 30E). Further features are the temperature compensation, trip contact (N.C.), signal contact (N.O.), automatic or manual reset selectable, trip-free mechanism, STOP and TEST function and a trip indication. Busbar kits are available as accessory for contactor mounting.

Ordering details

Setting range	Short-circuit protective device	Trip class	Type	Order code	Weight (1 pc) kg
A					
E1250DU electronic overload relay					
375 ... 1250	-	10E, 20E, 30E	E1250DU-1250	1SFA739001R1000	12.181

Thermal and electronic overload relays

General accessories



WRB-400

2CDC231102BF0013



WRH-F

2CDC2311027F0013

Description

The wire reset is a general accessory for thermal and electronic overload relays. In installations which are difficult to access, like a motor control centre or compact cubical, the accessory allows the user to remotely reset the overload relays.

The wire reset consists of two parts, the bowden wire with actuator and the holder. The actuator should be mounted into a door of a panel. The holder will be mounted on the overload relay. The actuator and holder are connected via the bowden wire.

Ordering details

Suitable for	Description	Length mm	Type	Order code	Weight (1 pc) kg
Holder					
TF42, TF65, TF96, EF19, EF45, EF65, EF96, EF146, EF205, EF370, EF460, EF750	Holder for tool less direct mounting		WRH-F	1SAZ701903R1001	0.006
Bowden wire with actuator					
WRH-F	Bowden wire with actuator, hole diameter: 7.3 mm, maximum panel thickness: 12 mm	400	WRB-400	1SAZ701903R1011	0.030
		600	WRB-600	1SAZ701903R1012	0.040
		1000	WRB-1000	1SAZ701903R1013	0.060
IP54 gasket					
WRB-400 WRB-600 WRB-1000	IP54 Panel seal gasket		WRBG	1SAZ701903R1030	0.037

6

Overload relays with accessory wire reset (WRH, WRB)

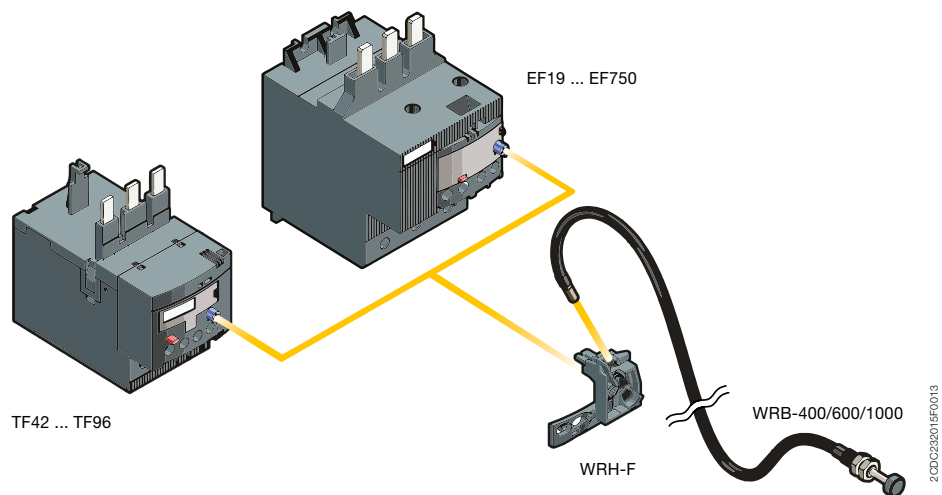



DRAS and DRAF enclosed starters

DRAS enclosed starter

Ordering details	7/2
Voltage code table	7/3

DRAF enclosed starter

Overview	7/4
Ordering details	7/6

For direct product details information, use product type or order code, ex:
www.abb.com/productdetails/AF09-30-10-13 or www.abb.com/productdetails/1SBL137001R1310

DRAS09 ... DRAS16 enclosed direct-on-line starters

4 to 7.5 kW, protected by thermal overload relays

AC or DC operated



1SBC133003V0014

DRAS
+ T16 to be ordered separately

Description

Enclosed direct-on-line (DOL) starters are used for controlling 3-phase asynchronous motors up to 690 V AC.

Each starter is delivered assembled and wired. It contains:

- IP65 compact plastic enclosure with double insulation, equipped with:
 - 1 green flush "I" ON button and 1 red protruding "O" OFF/RESET button
 - 2 quarter-turn, quick fastening screws and a base with 6 cable inlets and outlets via knockouts.
- 1 AS or ASL 3-pole contactor with holding contact
- 1 PE and 1 neutral terminal.

3 versions of control supply wiring are available: phase-to-phase, separate supply or phase-to-neutral.

T16 thermal overload relay has to be ordered separately and chosen according to motor's nominal current (see table below).

DRAS, DRASL enclosed DOL starters

IEC - AC-3				Rated control circuit voltage Uc Other control voltages see AS voltage code table	Control supply wiring	Type	Order code	Weight Pkg (1 pce) kg
Rated operational power	400 V	500 V	max. current $\theta \leq 40^\circ\text{C}$ Ue=400 V					
220 V				V 50/60 Hz	V DC			
230 V								
240 V								
kW	kW	kW	A					

AC operated with AS 3-pole contactors

2.2	4	4	9	24	-	Separate supply	DRAS09-20S	1SBK104235R2000	0.650
				230	-	Phase-to-neutral	DRAS09-26N	1SBK104135R2600	0.650
				240	-	Phase-to-neutral	DRAS09-27N	1SBK104135R2700	0.650
				400	-	Phase-to-phase	DRAS09-28P	1SBK104035R2800	0.650
				415	-	Phase-to-phase	DRAS09-29P	1SBK104035R2900	0.650
3	5.5	5.5	12	24	-	Separate supply	DRAS12-20S	1SBK114235R2000	0.650
				230	-	Phase-to-neutral	DRAS12-26N	1SBK114135R2600	0.650
				240	-	Phase-to-neutral	DRAS12-27N	1SBK114135R2700	0.650
				400	-	Phase-to-phase	DRAS12-28P	1SBK114035R2800	0.650
				415	-	Phase-to-phase	DRAS12-29P	1SBK114035R2900	0.650
4	7.5	7.5	15.5	24	-	Separate supply	DRAS16-20S	1SBK124235R2000	0.650
				230	-	Phase-to-neutral	DRAS16-26N	1SBK124135R2600	0.650
				240	-	Phase-to-neutral	DRAS16-27N	1SBK124135R2700	0.650
				400	-	Phase-to-phase	DRAS16-28P	1SBK124035R2800	0.650
				415	-	Phase-to-phase	DRAS16-29P	1SBK124035R2900	0.650

DC operated with ASL 3-pole contactors

2.2	4	4	9	-	24	Separate supply	DRASL09-81S	1SBK104335R8100	0.700
				-	48		DRASL09-83S	1SBK104335R8300	0.700
3	5.5	5.5	12	-	24	Separate supply	DRASL12-81S	1SBK114335R8100	0.700
				-	48		DRASL12-83S	1SBK114335R8300	0.700
4	7.5	7.5	15.5	-	24	Separate supply	DRASL16-81S	1SBK124335R8100	0.700
				-	48		DRASL16-83S	1SBK124335R8300	0.700

T16 thermal overload relays to be ordered separately

Setting range	Short-circuit protective device	Trip class	Type	Order code	Weight (1 pce) kg
0.10...0.13	0.5 A, Fuse type T	10	T16-0.13	1SAZ711201R1005	0.100
0.13...0.17	1.0 A, Fuse type T		T16-0.17	1SAZ711201R1008	0.100
0.17...0.23			T16-0.23	1SAZ711201R1009	0.100
0.23...0.31			T16-0.31	1SAZ711201R1013	0.100
0.31...0.41	2.0 A, Fuse type gG		T16-0.41	1SAZ711201R1014	0.100
0.41...0.55			T16-0.55	1SAZ711201R1017	0.100
0.55...0.74	4.0 A, Fuse type gG		T16-0.74	1SAZ711201R1021	0.100
0.74...1.00	6.0 A, Fuse type gG		T16-1.0	1SAZ711201R1023	0.100
1.00...1.30			T16-1.3	1SAZ711201R1025	0.100
1.30...1.70	10.0 A, Fuse type gG		T16-1.7	1SAZ711201R1028	0.100
1.70...2.30			T16-2.3	1SAZ711201R1031	0.100
2.30...3.10			T16-3.1	1SAZ711201R1033	0.100
3.10...4.20	20.0 A, Fuse type gG		T16-4.2	1SAZ711201R1035	0.100
4.20...5.70			T16-5.7	1SAZ711201R1038	0.100
5.70...7.60	35.0 A, Fuse type gG		T16-7.6	1SAZ711201R1040	0.100
7.60...10.0			T16-10	1SAZ711201R1043	0.104
10.0...13.0	40.0 A, Fuse type gG		T16-13	1SAZ711201R1045	0.104
13.0...16.0			T16-16	1SAZ711201R1047	0.104

Empty enclosure with push-button

-	-	-	FR16AS-12VARS	1SBN101035R1000	0.394
---	---	---	---------------	-----------------	-------

To be completed with AS or ASL contactor, T16 thermal overload relay and MCB-10B (1SFA611610R2001) contact block.



T16

2CDC31003V0013



1SBC133001V0014

Empty enclosure
with push-button

Voltage code table

DRAS09 ... DRAS16 and DRASL09 ... DRASL16 enclosed DOL starters

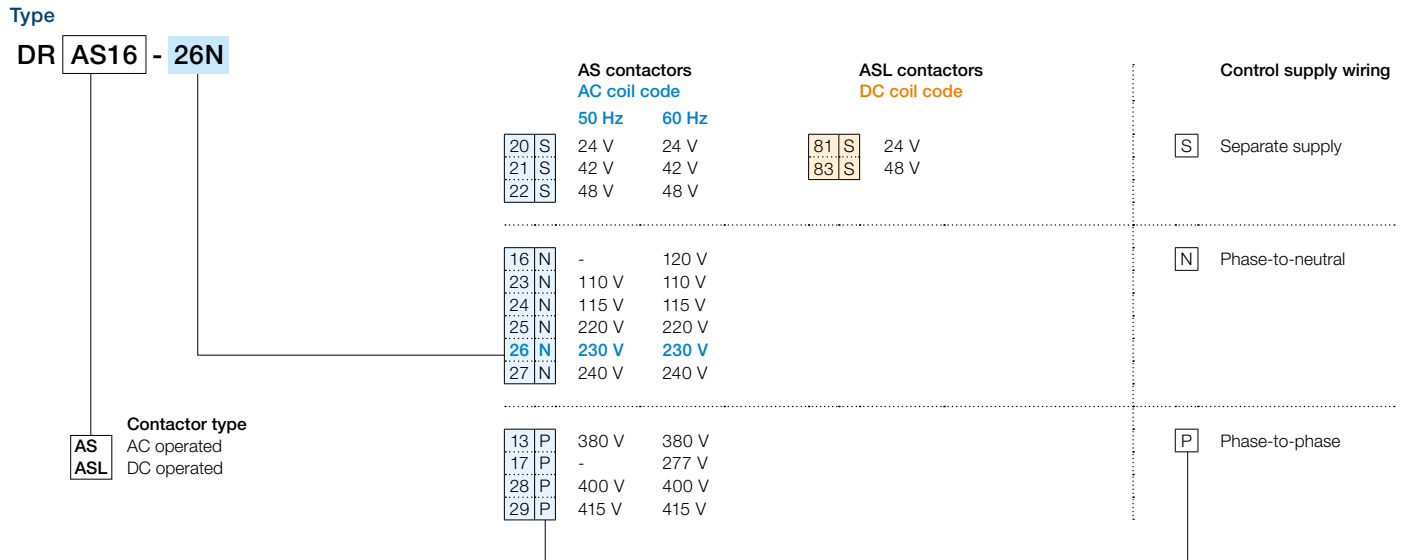

DRAF enclosed direct-on-line starters

Experience reliable and easy to install motor starting



Improve installation efficiency

- Easy to connect and to operate
- Pre-wired control circuit and easy to follow wiring instructions
- Coil energy consumption down by 80%.



Reliable in harsh condition

- High number of electrical and mechanical operations
- Robust IP66 and type 4X enclosure
- Double electrical insulation.

7



Continuous operation

- AF contactors manage voltage fluctuation, chattering free
- Protected motor with thermal overload relay
- Safety through coordinated product.



For machine or wall mounting

Main applications

Control of stand alone motors like for heat pumps, air conditioning units, small machine tools, compressors, pumping, irrigation...



Motor starting solutions up to 7.5 kW and 10 hp

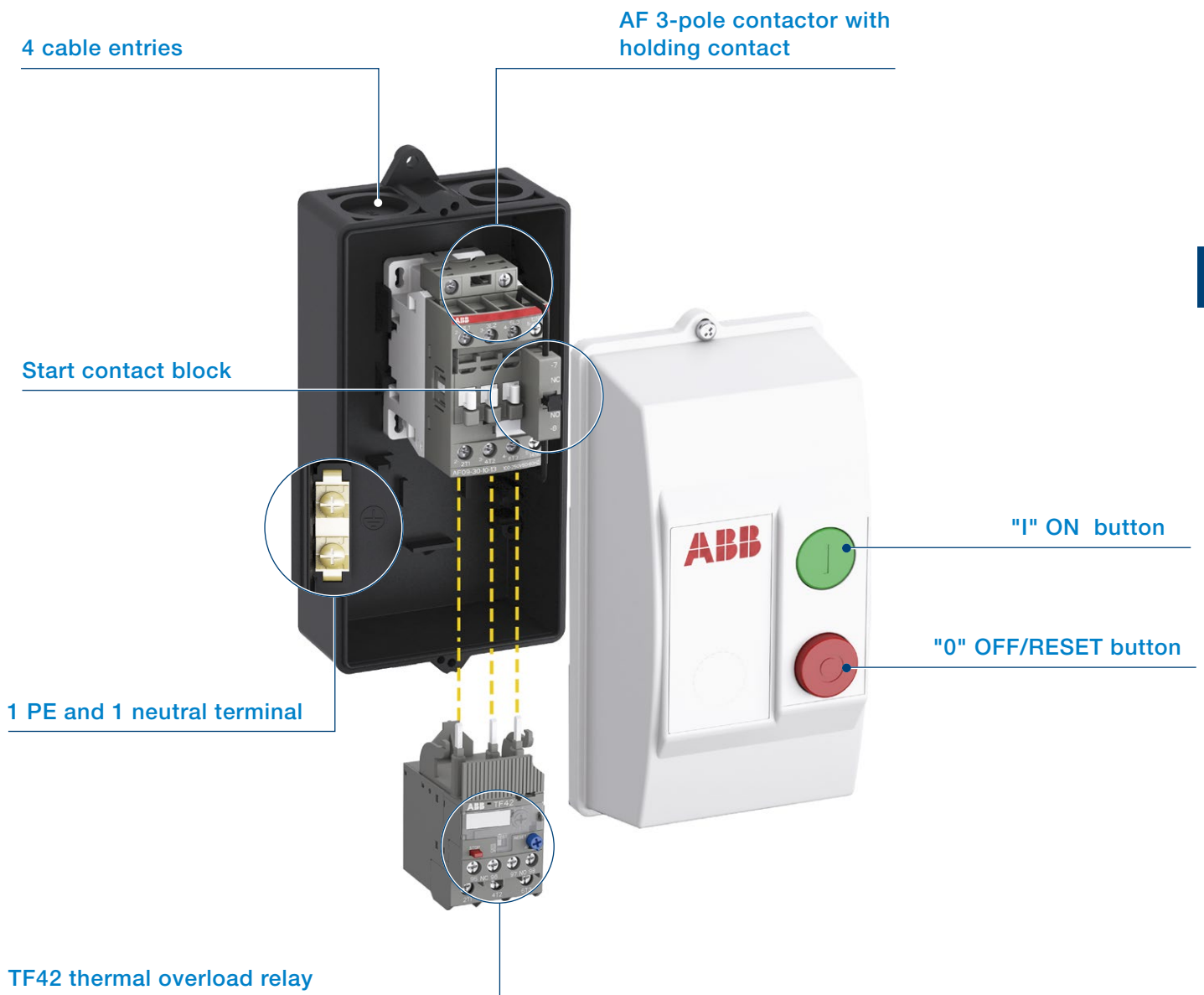

DRAF09 ... DRAF16 enclosed direct-on-line starters

Up to 7.5 kW and 10 hp, protected by thermal overload relays

AC operated



DRAF
+ TF42 to be ordered separately

Description

Enclosed direct-on-line (DOL) starters are used for controlling 3-phase asynchronous motors up to 690 V AC.

Each starter is delivered assembled and wired. It contains:

- IP66 and type 4X plastic enclosure with double insulation, equipped with:
 - 1 green flush "I" ON button and 1 red protruding "O" OFF/RESET button
 - 4 cable inlets and outlets via knockouts.
- 1 AF 3-pole contactor with holding contact
- 1 CB5-10 start contact block
- 1 PE and 1 neutral terminal.

Control supply wiring:

IEC starters type: phase-to-phase, separate supply or phase-to-neutral.

UL starters type: separate supply.

TF42 thermal overload relay to be ordered separately and chosen according to motor's nominal current (see table in the next page).

DRAF enclosed DOL starters

IEC - AC-3					Control supply wiring	Rated control circuit voltage Uc min ... Uc max (1)	Type	Order code	Weight Pkg (1 pce) kg
Rated operational power				max. current $\theta \leq 40^\circ\text{C}$ Ue=400 V					
220 V	380 V	500 V	690 V						
230 V	400 V								
240 V									
kW	kW	kW	kW	A					
IEC starters type									
2.2	4	5.5	5.5	9	Separate supply	24...60	DRAF09-11S	1SBK134237R1100	0.820
					Phase-to-neutral	100...250	DRAF09-13N	1SBK134137R1300	0.820
					Phase-to-phase	250...500	DRAF09-14P	1SBK134037R1400	0.820
3	5.5	7.5	7.5	12	Separate supply	24...60	DRAF12-11S	1SBK154237R1100	0.820
					Phase-to-neutral	100...250	DRAF12-13N	1SBK154137R1300	0.820
					Phase-to-phase	250...500	DRAF12-14P	1SBK154037R1400	0.820
4	7.5	9	9	18	Separate supply	24...60	DRAF16-11S	1SBK174237R1100	0.820
					Phase-to-neutral	100...250	DRAF16-13N	1SBK174137R1300	0.820
					Phase-to-phase	250...500	DRAF16-14P	1SBK174037R1400	0.820

(1) Select DRAF.S with separate supply for 24...60 V DC control circuit voltage (change A2 - Us wire to blue color acc. to IEC 60947-4-1).

UL starter type with separate control supply wiring

UL / CSA						Rated control circuit voltage Uc min ... Uc max	Type	Order code	Weight Pkg (1 pce) kg
Horse power ratings									
Single phase motor			Three phase motor						
120 V	240 V		200 V	220 V	440 V				
			208 V	240 V	480 V				
550 V					600 V				
hp	hp	hp	hp	hp	hp				
UL starters type									
0.75	1.5	2	2	5	7.5	24...60	DRAF09-11U	1SBK134238R1100	0.820
						100...250	DRAF09-13U	1SBK134238R1300	0.820
						250...500	DRAF09-14U	1SBK134238R1400	0.820
1	2	3	3	7.5	10	24...60	DRAF12-11U	1SBK154238R1100	0.820
						100...250	DRAF12-13U	1SBK154238R1300	0.820
						250...500	DRAF12-14U	1SBK154238R1400	0.820
1.5	3	5	5	10	15	24...60	DRAF16-11U	1SBK174238R1100	0.820
						100...250	DRAF16-13U	1SBK174238R1300	0.820
						250...500	DRAF16-14U	1SBK174238R1400	0.820

DRAF09 ... DRAF16 enclosed direct-on-line starters

Up to 7.5 kW and 10 hp, protected by thermal overload relays

AC operated



TF42



Empty enclosure with push-button

TF42 thermal overload relays to be ordered separately

Setting range	Short-circuit protective device	Trip class	Type	Order code	Weight (1 pce)
A					
0.10 ... 0.13	0.5 A, Fuse type T	10	TF42-0.13	1SAZ721201R1005	0.130
0.13 ... 0.17	1.0 A, Fuse type T	10	TF42-0.17	1SAZ721201R1008	0.130
0.17 ... 0.23	1.0 A, Fuse type T	10	TF42-0.23	1SAZ721201R1009	0.130
0.23 ... 0.31	1.0 A, Fuse type T	10	TF42-0.31	1SAZ721201R1013	0.130
0.31 ... 0.41	2.0 A, Fuse type gG	10	TF42-0.41	1SAZ721201R1014	0.130
0.41 ... 0.55	2.0 A, Fuse type gG	10	TF42-0.55	1SAZ721201R1017	0.130
0.55 ... 0.74	4.0 A, Fuse type gG	10	TF42-0.74	1SAZ721201R1021	0.130
0.74 ... 1.00	6.0 A, Fuse type gG	10	TF42-1.0	1SAZ721201R1023	0.130
1.00 ... 1.30	6.0 A, Fuse type gG	10	TF42-1.3	1SAZ721201R1025	0.130
1.30 ... 1.70	10.0 A, Fuse type gG	10	TF42-1.7	1SAZ721201R1028	0.130
1.70 ... 2.30	10.0 A, Fuse type gG	10	TF42-2.3	1SAZ721201R1031	0.130
2.30 ... 3.10	10.0 A, Fuse type gG	10	TF42-3.1	1SAZ721201R1033	0.130
3.10 ... 4.20	20.0 A, Fuse type gG	10	TF42-4.2	1SAZ721201R1035	0.130
4.20 ... 5.70	20.0 A, Fuse type gG	10	TF42-5.7	1SAZ721201R1038	0.130
5.70 ... 7.60	35.0 A, Fuse type gG	10	TF42-7.6	1SAZ721201R1040	0.130
7.60 ... 10.0	35.0 A, Fuse type gG	10	TF42-10	1SAZ721201R1043	0.130
10.0 ... 13.0	40.0 A, Fuse type gG	10	TF42-13	1SAZ721201R1045	0.130
13.0 ... 16.0	40.0 A, Fuse type gG	10	TF42-16	1SAZ721201R1047	0.130
16.0 ... 20.0	63.0 A, Fuse type gG	10	TF42-20	1SAZ721201R1049	0.145

Empty enclosure with push-button

mm cable inlet/outlet suitable for IEC starter types	-	FR16AF-12	1SBN101337R1000	0.53
Inch cable inlet/outlet suitable for UL starter types	-	FR16AF-12U	1SBN101338R1000	0.53

To be completed with AF contactor, TF42 thermal overload relay and CB5-10 (1SBN010013R1010) start contact block.

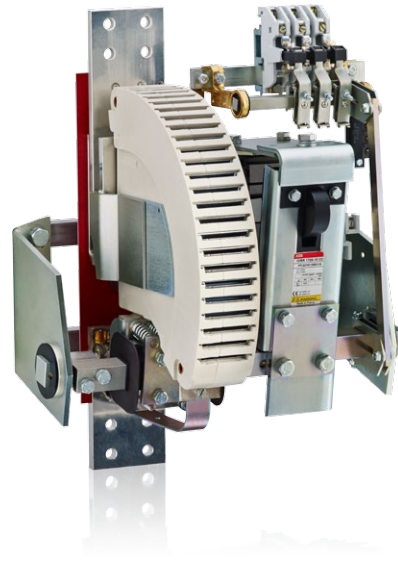
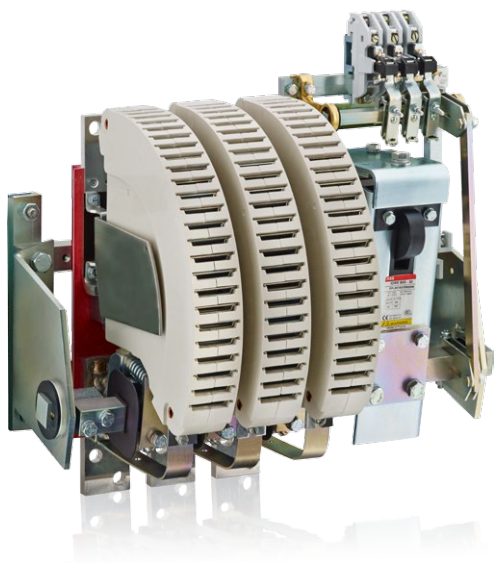

R contactors

Download



For additional information refer to our main catalog.

[Download main catalog](#)



Submit your request with the dedicated form. Our expert will define the right contactor for your application.

[Download the form](#)



R contactors

Tailored to your needs

With over 100 years of experience in control, ABB has designed its R contactors to meet the particular requirements of power applications from 63 A up to 5000 A in AC and DC.

With a variable number of poles and advanced features, these tailor-made bar mounted contactors remain the most flexible solution. Robustness and reliability bring our technology far beyond the limits of standard contactors. Our know-how enables us to offer R contactors perfectly suited to your applications whatever the environment.

Performance

- High making and breaking capacity
- Current up to 5000 A
- Voltage up to 1000 V AC or 1500 V DC.

Flexibility

- Variable number of poles
- Combination of N.O. and N.C. poles
- Adjustable number of auxiliary contacts.

Reliability

- Robust construction
- Durability up to 5 millions of operating cycles
- Experienced and proven for years.

... you can trust

Easy maintenance

- Direct access to all the contactor parts for inspection or replacement
- Complete and didactic instruction manual for installation, inspection or maintenance
- Dedicated R contactors service support available by ABB.

From standard to tailor-made solution

- Pre-sales support to identify and define customer requirements
- Customized support with development of solutions from specifications
- Specialists available to optimize your configuration.

Sustainability of control for a wide variety of applications

- Iron and steel industries
- Mining
- Cranes
- Induction furnaces
- Hydroelectric power stations
- Photovoltaic power plants
- Power distribution
- Energy storage
- Railway substation
- Lighting equipment
- Pump stations.



15BC104005S0201

R contactors

Get the right product

Conventional applications

AC circuit switching

Up to 500 V AC
IOR contactors

From 500 up to 1000 V AC
IOR..MT contactors

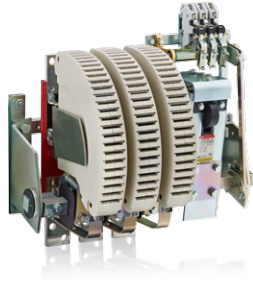

AC-1 Rated operational current up to 5000 A
AC-3 Rated power up to 1500 kW (1520 A - 440 V)

DC circuit switching

Up to 1500 V DC with poles in series
IOR..CC contactors



DC-1 Rated operational current up to 5000 A
DC-3 / DC-5 operational current up to 2000 A

Advanced applications

N.O./N.C. main poles combination

AC circuit switching
NOR..MT contactors

DC circuit switching
NOR..CC contactors



Power circuit coupling

Up to 1000 V AC / 1500 V DC
LOR couplers



Slip-ring motor control

Uer up to 5000 V AC
FOR contactors



Energy saving and safety requirements

Equipped with latching
..AMA, ..AME contactor types

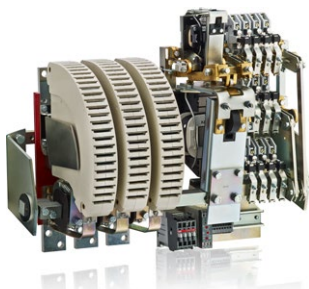

Alternator field discharge

Umax 2250 V DC
AM-CC-JORE contactors

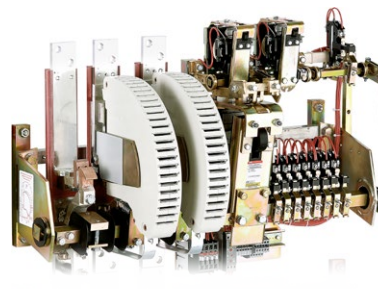

Certifications and approvals

[Certifications and approvals](#) 9/2

[Coordination with short-circuit protection devices](#) 9/8

Certifications and approvals

Designed according to the appropriate specifications, the devices in this catalogue have been built and tested. They can be used in most countries without any further certifications.

Some countries, however, require certification according to their own national standards. In other cases, the Marine for example, approvals ratifying that particular specifications have been met are necessary.

The table below shows the approvals and certifications for different devices.















The following documents may be obtained on request:

- Certificates of conformity
- Certificates of certification or approval.

The use of certified devices does not exonerate the equipment supplier from complying with the legal specifications of the country concerned.















Explanation of symbols:

■ **Standard design approved**, the company labels bear the certification mark when this is required.

Mark	Certifications					Approvals: ship classification societies									
															
Abbreviation	CSA	UL	cULus	CCC	GOST or EAC		BV	GL	LR	DNV	RINa	ABS	RMRS	CCS	
Approved in	Canada	USA	North America	China	Russia		France	Germany	Gr.Britain	Norway	Italy	USA	Russia	China shipping	
3-pole contactors															
4 to 7.5 kW															
AC operated AS09, AS12, AS16			■ E312527	■	■										
DC operated ASL09, ASL12, ASL16			■ E312527	■	■										
4 to 45 kW															
AC / DC operated AF09, AF12, AF16, AF26, AF30, AF38			■ E312527	■	■		■	■ (3)	■	■ (3)	■	■ (1)	■		
AC / DC operated AF40, AF52, AF65, AF80, AF96			■ E312527	■	■		■	■ (3)	■	■ (3)	■	■ (1)	■		
55 to 200 kW															
AC / DC operated (2) AF116, AF140, AF146			■ E36588	■	■		■	■	■	■	■	■	■ (1)	■	
AC / DC operated (2) AF190, AF205, AF265, AF305, AF370			■ E36588	■	■		■	■	■	■	■	■	■ (1)	■	
200 to 560 kW															
AC / DC operated AF400, AF460, AF580, AF750			■ E36588	■	■		■	■	■	■	■	■	■	■	
AC / DC operated AF1250			■ E73397	■	■									■	
AC / DC operated AF1350, AF1650			■ E36588	■	■		■	■	■	■	■	■	■	■	
AC / DC operated AF2050			■ E73397	■	■						■	■		■	
AC / DC operated AF2650			■ E73397	■	■						■			■	
4-pole contactors															
25 to 125 A, AC-1															
AC / DC operated AF09, AF16, AF26, AF38			■ E312527	■	■		■	■ (3)	■	■ (3)	■	■	■		
AC / DC operated AF40, AF52, AF80			■ E312527		■ (1)	■									
160 to 525 A, AC-1															
AC / DC operated AF116, AF140, AF190, AF205, AF265, AF305, AF370			■ E73397			■ (1)			■ (1)						
800 to 1000 A AC-1															
AC operated EK550			■ E36588	■	■										
AC operated EK1000				■	■										
DC operated EK550			■ E36588	■	■										
DC operated EK1000				■	■										







(1) in progress. (2) Marine approvals for AF116 ... AF370 with built-in PLC interface: only DNV is available. (3) DNV-GL certificate.









Certifications and approvals

Mark	Certifications					Approvals: ship classification societies									
	 CSA Canada	 UL USA	 cULus North America	 CCC China	 PGT Russia	 EAC	 BV France	 GL Germany	 Lloyd's Register Gr. Britain	 DNV Norway	 RINA Italy	 ABS USA	 RMRS Russia	 CCS China shipping	
DC switching contactors															
AC operated GA75	■	■ E319322		■											
DC operated GAE75	■	■ E319322		■											
AC / DC operated GAF185 ... GAF300			■ E73397	■											
AC / DC operated GAF460, GAF750, GAF1250, GAF1650, GAF2050			■ E73397	■											
Capacitor switching contactors															
AC operated UA16		■ E312527		■	■										
AC operated UA26 ... UA75	■	■ E312527		■	■										
AC operated UA95, UA110			■ E36588	■	■										
AC operated UA16..RA ... UA75..RA		■ E312527		■	■										
AC operated UA95..RA, UA110..RA			■ E36588	■	■										
Contactors relays															
AC operated 4-pole, 8-pole - NS..			■ E252354	■	■										
DC operated 4-pole, 8- pole - NSL..			■ E252354	■	■										
AC / DC operated 4-pole, 8-pole - NF..			■ E252354	■	■										
						■	■	■	■	■	(1)		■		

(1) in progress.

Certifications and approvals

	Certifications					
Mark						
Abbreviation	CSA	UL	cULus	CCC	GOST or EAC	
Approved in	Canada	USA	North America	China	Russia	

Approvals: ship classification societies							
							
BV	GL	LR	DNV	RINa	ABS	RMRS	CCS
France	Germany	Gr.Britain	Norway	Italy	USA	Russia	China shipping

Accessories for AS09 ... AS16 contactors

Accessory	CSA	UL	cULus	CCC	GOST or EAC
Auxiliary contacts					
CA3			■ E252354	■	■
Mechanical interlock unit					
VM3			■ E312527		■
Connecting links					
BEA16-3			■ E312527		■
BEA16-3U			■ E312527		
BER16C-3			■ E312527		■
BEY16C-3			■ E312527		■
Electronic timer					
TEF3			■ E252354		■
Surge suppressors					
RT5			■ E312527		■
RC5-1			■ E312527		■
RV5			■ E312527		■

Accessory	BV	GL	LR	DNV	RINa	ABS	RMRS	CCS
CA3								
VM3	□	□	□	□	□	□	□	□
BEA16-3	□	□	□	□	□	□	□	□
BEA16-3U	□	□	□	□	□	□	□	□
BER16C-3	□	□	□	□	□	□	□	□
BEY16C-3	□	□	□	□	□	□	□	□
TEF3								
RT5								
RC5-1								
RV5								















Accessories for AF09 ... AF2650 and EK contactors and NF contactor relays

Accessory	CSA	UL	cULus	CCC	GOST or EAC
Auxiliary contacts					
CA4, CC4			■ E252354	■	■
CAT4			■ E252354	■	■
CAL4			■ E252354	■	■
CAL19			■ E76003	■	■
CAL18			■ E76003	■	■
CAL16			■ E76003	■	■
CE5...D0.1		■ E319322		■	■
CE5...D2		■ E319322		■	■
CE5...W0.1		■ E319322		■	■
CE5...W2		■ E319322			■
CEL18			■ E76003		■
Electronic timer					
TEF4			■ E252354		■
Mechanical / electrical interlock unit					
VEM4			■ E312527	■	■
Mechanical interlock units					
VM4, VM96-4			■ E312527		■
VM19			■ E36588		■
VM140/190			■ E36588		■
VM205/265			■ E36588		■
VM 750			■ E36588		■
VM1650H			■ E36588		■
Latching unit					
WB75-A		■ E252354			■

Accessory	BV	GL	LR	DNV	RINa	ABS	RMRS	CCS
CA4, CC4	■ (CA4)	■ (CA4)	■	■ (CA4)	■	(1) (CA4)	■	
CAT4	■	■	■	■	■	■	■	
CAL4	■	■	■	■	■	■	■	
CAL19	■	■	■	■	■	■	■	■
CAL18	■	■	■	■	■	■	■	■
CAL16								
CE5...D0.1								
CE5...D2								
CE5...W0.1								
CE5...W2								
CEL18								
TEF4								
VEM4								
VM4, VM96-4	□	□	□	□	□	□	□	□
VM19	□	□	□	□	□	□	□	□
VM140/190	□	□	□	□	□	□	□	□
VM205/265	□	□	□	□	□	□	□	□
VM 750	□	□	□	□	□	□	□	□
VM1650H	□	□	□	□	□	□	□	□
WB75-A								













(1) in progress. □ Marine approvals not needed for this accessory.

Certifications and approvals

Mark	Certifications					Approvals: ship classification societies								
	 CSA Canada	 UL USA	 UL ^{us} North America	 CCC China	 PGT Russia	 EAC	 BV France	 GL Germany	 Lloyd's Register Gr. Britain	 DNV Norway	 RINA Italy	 ABS USA	 RMRS Russia	 CCS China shipping
Connecting links														
BEA16-4, BEA26-4, BEA38-4, BEA65-4			■ E312527		■									
Connection sets for reversing contactors														
BER16-4, BER38-4			■ E312527		■									
BER65-4, BER96-4			■ E312527		■									
BER140-4, BER205-4, BER370-4			■ E36588		■									
BEM460-30, BEM750-30			■ E36588		■									
Connection sets for star-delta starters														
BEY16-4, BEY38-4			■ E312527		■									
BEY65-4, BEY96-4			■ E312527		■									
BEY190-4, BEY205-4, BEY265-4, BEY370-4			■ E36588		■									
BED460, BED580, BED750			■ E36588		■									
Phase to phase connections														
BEP140-30, BEP205-30, BEP370-30			■ E36588		■									
BEP140-40, BEP205-40, BEP370-40														
BES460, BES750			■ E36588		■									
Terminal connecting strips and shorting bars														
LY16-4, LY38-4			■ E312527		■									
LY110, LY185, LY300, LY460, LY750			■ E36588		■									
LP185, LP300, LP460, LP750			■ E36588		■									
LH38-4			■ E312527		■									
LF16-4, LF38-4			■ E312527		■									
LG16-4			■ E312527		■									
LK96-4			■ E312527		■									
Additional coil terminal blocks														
LD38-4			■ E312527											
Additional terminal blocks														
LDC4			■ E312527											
Protective covers														
BX4, BX4-CA			■ E252354											
Terminal shrouds														
LT, LT.-30			■ E36588		■									
LT.-40			■ E73397		■									
Terminal enlargement														
LW			■ E36588		■									
Terminal extension														
LX			■ E36588		■									
Connection socket														
LL			■ E36588		■									
Connection modules														
LD146-30, LD146-40			■ E36588		■									
Function marker														
BA4			■ E252354											
Fixing clip														
BB4			■ E312527											













Marine approvals not needed for this accessory.

Certifications and approvals

Mark	Certifications						Approvals: ship classification societies						
	 CSA Canada	 UL USA	 cULus North America	 CCC China	 GOST or EAC Russia	 EAC Russia	 BV France	 GL Germany	 LR Gr. Britain	 DNV Norway	 RINA Italy	 ABS USA	 RMRS Russia
Manual motor starters													
MS116			E137861				(1)						
MS132			E137861 E345003										
MS165			E137861 E345003										
MS495		E167205 E195536											
MS497		E167205 E195536											
Manual motor starters magnetic only													
MO132			E137861 E345003										
MO165			E137861 E345003										
MO495		E167205											
MO496		E167205											
Circuit breaker for transformer protection													
MS132-T													
Mini contactors													
3-pole contactors													
AC operated B6, B7			E191658										
DC operated BC6, BC7, B7D			E191658										
DC operated B6S, B7S			E191658										
3-pole reversing contactors													
AC operated VB6, VB7			E191658										
DC operated VBC6, VBC7			E191658										
AC operated VB6A, VB7A			E191658										
DC operated VBC6A, VBC7A			E191658										
3-pole interface contactors													
DC operated BC6, BC7			E191658										
3-pole contactor - large coil voltage range													
DC operated TBC7													
4-pole contactors													
AC operated B6, B7			E191658										
DC operated BC6, B7D			E191658										
4-pole contactor - large coil voltage range													
DC operated TBC7													

(1) MS116 up to 16 A only.
Contactor relays

Certifications and approvals

Mark	Certifications						Approvals: ship classification societies						
	 CSA Canada	 UL USA	 cULus North America	 CCC China	 GOST or EAC Russia	 ATEX	 BV France	 GL Germany	 LR Gr.Britain	 DNV Norway	 RINA Italy	 ABS USA	 RMRS Russia
AC operated K6			<input checked="" type="checkbox"/>	<input checked="" type="checkbox"/>	<input checked="" type="checkbox"/>								<input checked="" type="checkbox"/>
DC operated KC6			<input checked="" type="checkbox"/>	<input checked="" type="checkbox"/>	<input checked="" type="checkbox"/>								<input checked="" type="checkbox"/>
Interface contactor relays													
DC operated KC6			<input checked="" type="checkbox"/>	<input checked="" type="checkbox"/>	<input checked="" type="checkbox"/>								<input checked="" type="checkbox"/>
DC operated K6S			<input checked="" type="checkbox"/>	<input checked="" type="checkbox"/>	<input checked="" type="checkbox"/>								<input checked="" type="checkbox"/>
Contactor relays - large coil voltage range													
DC operated TKC6													
Thermal overload relays													
T16			<input checked="" type="checkbox"/>	<input checked="" type="checkbox"/>	<input checked="" type="checkbox"/>		<input checked="" type="checkbox"/>	<input checked="" type="checkbox"/>	<input checked="" type="checkbox"/>	<input checked="" type="checkbox"/>	<input checked="" type="checkbox"/>	<input checked="" type="checkbox"/>	<input checked="" type="checkbox"/>
TF42			<input checked="" type="checkbox"/>	<input checked="" type="checkbox"/>	<input checked="" type="checkbox"/>	<input checked="" type="checkbox"/>	<input checked="" type="checkbox"/>	<input checked="" type="checkbox"/>	<input checked="" type="checkbox"/>	<input checked="" type="checkbox"/>	<input checked="" type="checkbox"/>	<input checked="" type="checkbox"/>	<input checked="" type="checkbox"/>
TF65			<input checked="" type="checkbox"/>		<input checked="" type="checkbox"/>	<input checked="" type="checkbox"/>	<input checked="" type="checkbox"/>	<input checked="" type="checkbox"/>	<input checked="" type="checkbox"/>		<input checked="" type="checkbox"/>	<input checked="" type="checkbox"/>	<input checked="" type="checkbox"/>
TF96			<input checked="" type="checkbox"/>		<input checked="" type="checkbox"/>	<input checked="" type="checkbox"/>	<input checked="" type="checkbox"/>	<input checked="" type="checkbox"/>	<input checked="" type="checkbox"/>		<input checked="" type="checkbox"/>	<input checked="" type="checkbox"/>	<input checked="" type="checkbox"/>
TF140DU			<input checked="" type="checkbox"/>	<input checked="" type="checkbox"/>	<input checked="" type="checkbox"/>		<input checked="" type="checkbox"/>	<input checked="" type="checkbox"/>	<input checked="" type="checkbox"/>		<input checked="" type="checkbox"/>	<input checked="" type="checkbox"/>	<input checked="" type="checkbox"/>
TF140DU-V1000			<input checked="" type="checkbox"/>	<input checked="" type="checkbox"/>	<input checked="" type="checkbox"/>	<input checked="" type="checkbox"/>	<input checked="" type="checkbox"/>	<input checked="" type="checkbox"/>	<input checked="" type="checkbox"/>		<input checked="" type="checkbox"/>	<input checked="" type="checkbox"/>	<input checked="" type="checkbox"/>
TA200DU			<input checked="" type="checkbox"/>	<input checked="" type="checkbox"/>	<input checked="" type="checkbox"/>		<input checked="" type="checkbox"/>	<input checked="" type="checkbox"/>	<input checked="" type="checkbox"/>		<input checked="" type="checkbox"/>	<input checked="" type="checkbox"/>	<input checked="" type="checkbox"/>
TA200DU-V1000			<input checked="" type="checkbox"/>	<input checked="" type="checkbox"/>	<input checked="" type="checkbox"/>	<input checked="" type="checkbox"/>	<input checked="" type="checkbox"/>	<input checked="" type="checkbox"/>	<input checked="" type="checkbox"/>		<input checked="" type="checkbox"/>	<input checked="" type="checkbox"/>	<input checked="" type="checkbox"/>
Electronic overload relays													
0.10...45 A													
E16DU			<input checked="" type="checkbox"/>	<input checked="" type="checkbox"/>	<input checked="" type="checkbox"/>								<input checked="" type="checkbox"/>
EF19			<input checked="" type="checkbox"/>	<input checked="" type="checkbox"/>	<input checked="" type="checkbox"/>	<input checked="" type="checkbox"/>	<input checked="" type="checkbox"/>	<input checked="" type="checkbox"/>	<input checked="" type="checkbox"/>	<input checked="" type="checkbox"/>	<input checked="" type="checkbox"/>	<input checked="" type="checkbox"/>	<input checked="" type="checkbox"/>
EF45			<input checked="" type="checkbox"/>	<input checked="" type="checkbox"/>	<input checked="" type="checkbox"/>	<input checked="" type="checkbox"/>	<input checked="" type="checkbox"/>	<input checked="" type="checkbox"/>	<input checked="" type="checkbox"/>	<input checked="" type="checkbox"/>	<input checked="" type="checkbox"/>	<input checked="" type="checkbox"/>	<input checked="" type="checkbox"/>
20...150 A													
EF65			<input checked="" type="checkbox"/>	<input checked="" type="checkbox"/>	<input checked="" type="checkbox"/>	<input checked="" type="checkbox"/>	<input checked="" type="checkbox"/>	<input checked="" type="checkbox"/>	<input checked="" type="checkbox"/>	<input checked="" type="checkbox"/>	<input checked="" type="checkbox"/>	<input checked="" type="checkbox"/>	<input checked="" type="checkbox"/>
EF96			<input checked="" type="checkbox"/>	<input checked="" type="checkbox"/>	<input checked="" type="checkbox"/>	<input checked="" type="checkbox"/>	<input checked="" type="checkbox"/>	<input checked="" type="checkbox"/>	<input checked="" type="checkbox"/>	<input checked="" type="checkbox"/>	<input checked="" type="checkbox"/>	<input checked="" type="checkbox"/>	<input checked="" type="checkbox"/>
EF146			<input checked="" type="checkbox"/>	<input checked="" type="checkbox"/>	<input checked="" type="checkbox"/>	<input checked="" type="checkbox"/>	<input checked="" type="checkbox"/>	<input checked="" type="checkbox"/>	<input checked="" type="checkbox"/>	<input checked="" type="checkbox"/>	<input checked="" type="checkbox"/>	<input checked="" type="checkbox"/>	<input checked="" type="checkbox"/>
63...380 A													
EF205			<input checked="" type="checkbox"/>	<input checked="" type="checkbox"/>	<input checked="" type="checkbox"/>	<input checked="" type="checkbox"/>	<input checked="" type="checkbox"/>	<input checked="" type="checkbox"/>	<input checked="" type="checkbox"/>	<input checked="" type="checkbox"/>	<input checked="" type="checkbox"/>	<input checked="" type="checkbox"/>	<input checked="" type="checkbox"/>
EF370			<input checked="" type="checkbox"/>	<input checked="" type="checkbox"/>	<input checked="" type="checkbox"/>	<input checked="" type="checkbox"/>	<input checked="" type="checkbox"/>	<input checked="" type="checkbox"/>	<input checked="" type="checkbox"/>	<input checked="" type="checkbox"/>	<input checked="" type="checkbox"/>	<input checked="" type="checkbox"/>	<input checked="" type="checkbox"/>
150...800 A													
EF460			<input checked="" type="checkbox"/>	<input checked="" type="checkbox"/>	<input checked="" type="checkbox"/>	<input checked="" type="checkbox"/>	<input checked="" type="checkbox"/>	<input checked="" type="checkbox"/>	<input checked="" type="checkbox"/>	<input checked="" type="checkbox"/>	<input checked="" type="checkbox"/>	<input checked="" type="checkbox"/>	<input checked="" type="checkbox"/>
EF750			<input checked="" type="checkbox"/>	<input checked="" type="checkbox"/>	<input checked="" type="checkbox"/>	<input checked="" type="checkbox"/>	<input checked="" type="checkbox"/>	<input checked="" type="checkbox"/>	<input checked="" type="checkbox"/>	<input checked="" type="checkbox"/>	<input checked="" type="checkbox"/>	<input checked="" type="checkbox"/>	<input checked="" type="checkbox"/>
150...1250 A													
E1250DU			<input checked="" type="checkbox"/>										<input checked="" type="checkbox"/>

(2) EF65-56 has no RINA approval and no ATEX certification.
 (3) ATEX is valid for products produced from week 26, 2015.
 All electronic overload relays are  (C-Tick) marked.

Coordination with short-circuit protection devices

In compliance with standards IEC 60947-4-1 and EN 60947-4-1, we define for the contactors and starters the type, rating and characteristics of the short-circuit protection devices SCPD which allow selective protection against overloads and ensure protection against short circuits.

Basic functions

Any starter is designed to:

- start motors,
- ensure continuous functioning of motors,
- disconnect motors from the supply line,
- guarantee protection of motors against overloads.

The starter is typically made up of a switching device (contactor) and an overload protection device (thermal overload relay or electronic overload relay).

These two devices MUST be coordinated with equipment capable of providing protection against short circuit (SCPD: short circuit protective device): typically a circuit breaker with magnetic release only or a switch fuse. These are not necessarily part of the starter.

Applicable standards

IEC 60947-4-1 (EN 60947-4-1) precisely defines the different points to be considered in order to carry out correct coordination.

Complete coordination for a combination includes the following points:

- Selectivity test between the overload relay and the short-circuit protection device SCPD.
- Short-circuit condition tests:
 - at prospective "r" currents - These currents depend on the rated operational current of the starter (**I_e** AC-3) and are given by the standard (Table 13). For example:
 - r = 1kA for **I_e** AC-3 < 16 A
 - r = 3 kA for 16 A < **I_e** AC-3 < 63 A
 - r = 5 kA for 63 A < **I_e** AC-3 < 125 A etc.
 - at the rated conditional short-circuit current "**I_q**" - This is the maximum prospective current that the combination can withstand, for example 50 kA.

9

Types of coordination

IEC 60947-4-1 (EN 60947-4-1) defines two types of coordination according to the expected level of service continuity. Acceptable extreme damage for the switchgear is divided into two types.

Type 1: In short-circuit conditions, the contactor or starter does not endanger persons or installations and will not be able to then operate without being repaired or having parts replaced.

Type 2: In short-circuit conditions, the contactor or starter does not endanger persons or installations and will be able to operate afterwards. The risk of contacts light welding is acceptable. In this case, the manufacturer must stipulate the measures to be taken with respect to maintenance of the equipment.

The complete ABB offer

ABB has acquired years of experience with respect to problems of coordination and is able to make a complete offer based on tests performed in its qualified laboratories. This offer includes 400 V, 500 V, 690 V networks.

A complete data base of coordination tables, according to IEC 60947-4-1 (EN 60947-4-1), is available on the ABB Website.

In the coordination tables the following short-circuit protection devices are recommended:

- Moulded case circuit-breakers (MCCBs)
- Miniature circuit-breakers (MCBs)
- Switch-disconnector-fuses (aM, gG and BS)
- Manual Motor Starters (MMS).

General remarks applicable to all tables

- Each table is defined for a maximum ambient temperature of 40 °C. For higher temperatures, apply a derating factor according to the following rules:
 - Fuses: factor of 0.8 applied to **I_n** for an ambient temperature of 70 °C
 - MCCBs and MCBs: factor of 0.8 applied to **I_n** for an ambient temperature of 60 °C
 - The starter derating factor depends on the operating conditions of thermal overload relays:
 - Factor of 0.9 applied to **I_n** for an ambient temperature of 70 °C.
- Each table is defined for motor currents: 3-phase motors, 4-pole
- **Normal starting** means a starting time < 2 s. - **Difficult starting** means an accelerating time 10 s < **t_s** < 30 s
- **Tripping classes** of thermal overload relays according to IEC 60947-4-1 (EN 60947-4-1): 10A and 10
- **Tripping classes** of electronic overload relays according to IEC 60947-4-1 (EN 60947-4-1): 10E, 20E, 30E selectable
- In the tables with MCCBs, these are fitted with the magnetic relay alone. Setting is always carried out at > 12.3 **I_e** AC-3 so that the transient current peak occurring during starting does not lead to tripping.

Coordination with short-circuit protection devices

A complete data base of coordination tables, according to **IEC 60947-4-1** (EN 60947-4-1) or **UL 508 / UL 60947-4-1**, is available on the ABB Website: see below.

Selection

Simple or multiple selections all from the same screen.

Short-circuit protection devices

- Air circuit breakers
- Fuses "gG" or "aM"
- Miniature circuit breaker
- Moulded case circuit breaker
- Manual motor starter

Starter type

- Direct-on-line normal start
- Direct-on-line heavy duty
- Star-delta normal start
- Soft starter normal start

Overload relay

- TOL : thermal overload relay
- EOL : electronic overload relay
- UMC : Universal motor controller

Coordination

- IEC type 1 or type 2
- UL type A to Type F

Results

- Search results displayed at the bottom of the selection page.
- Only the most appropriate solutions to your application, will be displayed at the bottom of the page.
- "Enable Smart Current Search" function featured for the short-circuit current where "near to" selected values also are included in the result.
- Possible to print the page to a pdf file or from your printer.
- "Clear selection" function to deselect all selected.

Fuses, 400 Vac, 100 kA, DOL-NS, Coordination Type IEC Type 2, Overload Relay TOL, Motor efficiency class IE1 + IE2									
Motor	Fuses IEC			Contactor	Overload Relay				
Rated Power [kW]	Rated Current [A]	Switch-Fuse Type	Rating gG/aM [A]	Type and Size	Type	Type	Current range [A]	Max allowed load current [A]	Table
0,25	0,85	OS32GD_	2	CFAF 000aM	AF09	TF42-1,0	0,74 - 1,00	1,00	>>
0,12	0,44	OS32GD_	2	CFAF 000H	AF09	TF42-0,55	0,42 - 0,55	0,55	>>

Fuses, 400 Vac, 100 kA, DOL-NS, Coordination Type IEC Type 2, Overload Relay EOL, Motor efficiency class IE3									
Motor	Fuses IEC			Contactor	Overload Relay				
Rated Power [kW]	Rated Current [A]	Switch-Fuse Type	Rating gG/aM [A]	Type and Size	Type	Type	Current range [A]	Max allowed load current [A]	Table
0,18	0,60	OS32GD_	2	CFAF 000aM	AF09	EF19-1,0 10*	0,30 - 1,00		>>
0,12	0,44	OS32GD_	2	CFAF 000H	AF09	EF19-1,0 10*	0,30 - 1,00		>>
0,12	0,44	OS32GD_	2	CFAF 000H	AF09	EF19-1,0 10*	0,30 - 1,00	0,54	>>
0,18	0,60	OS32GD_	2	CFAF 000aM	AF09	EF19-1,0 10*	0,30 - 1,00	1,00	>>



Access

To find the coordination tables for motor protection, please see:
<http://applications.it.abb.com/SOC/Page/Selection.aspx>

Index

Order code classification

Order code	Type	Page
1SAM101923R0002	MSMN	2/24
1SAM101923R0012	MSMNO	2/24
1SAM201901R1001	HKF1-11	2/13
1SAM201901R1002	HKF1-20	2/13
1SAM201901R1003	HKF1-10	2/13
1SAM201901R1004	HKF1-01	2/13
1SAM201902R1001	HK1-11	2/13
1SAM201902R1002	HK1-20	2/13
1SAM201902R1003	HK1-02	2/13
1SAM201902R1004	HK1-20L	2/13
1SAM201903R1001	SK1-11	2/13
1SAM201903R1002	SK1-20	2/13
1SAM201903R1003	SK1-02	2/13
1SAM201904R1001	UA1-24	2/14
1SAM201904R1002	UA1-48	2/14
1SAM201904R1003	UA1-60	2/14
1SAM201904R1004	UA1-110	2/14
1SAM201904R1005	UA1-230	2/14
1SAM201904R1006	UA1-400	2/14
1SAM201904R1007	UA1-415	2/14
1SAM201904R1008	UA1-208	2/14
1SAM201904R1009	UA1-575	2/14
1SAM201904R1010	UA1-20	2/14
1SAM201906R1102	PS1-2-0-65	2/16
1SAM201906R1103	PS1-3-0-65	2/16
1SAM201906R1104	PS1-4-0-65	2/16
1SAM201906R1105	PS1-5-0-65	2/16
1SAM201906R1112	PS1-2-1-65	2/16
1SAM201906R1113	PS1-3-1-65	2/16
1SAM201906R1114	PS1-4-1-65	2/16
1SAM201906R1115	PS1-5-1-65	2/16
1SAM201906R1122	PS1-2-2-65	2/16
1SAM201906R1123	PS1-3-2-65	2/16
1SAM201906R1124	PS1-4-2-65	2/16
1SAM201906R1125	PS1-5-2-65	2/16
1SAM201907R1101	S1-M1-25	2/16
1SAM201907R1102	S1-M2-25	2/16
1SAM201907R1103	S1-M3-25	2/16
1SAM201908R1001	BS1-3	2/16
1SAM201909R1001	FS116	2/16
1SAM201909R1021	MSAH1	2/24
1SAM201910R1001	AA1-24	2/14
1SAM201910R1002	AA1-110	2/14
1SAM201910R1003	AA1-230	2/14
1SAM201910R1004	AA1-400	2/14
1SAM201911R1010	IB132-G	2/18
1SAM201911R1011	IB132-Y	2/18
1SAM201912R1010	DMS132-G	2/18
1SAM201912R1011	DMS132-Y	2/18
1SAM201913R1103	S1-M3-35	2/16
1SAM201914R1001	PB1-1-32	2/16
1SAM201914R1002	S1-PB1-25	2/16
1SAM201916R1103	PS1-3-0-100	2/16
1SAM201916R1104	PS1-4-0-100	2/16
1SAM201916R1105	PS1-5-0-100	2/16
1SAM201916R1113	PS1-3-1-100	2/16
1SAM201916R1114	PS1-4-1-100	2/16
1SAM201916R1115	PS1-5-1-100	2/16
1SAM201916R1123	PS1-3-2-100	2/16
1SAM201920R1000	MSH-AR	2/24
1SAM201920R1001	MSHD-LB	2/24
1SAM201920R1002	MSHD-LY	2/24
1SAM201920R1011	MSHD-LTB	2/24
1SAM201920R1012	MSHD-LTY	2/24
1SAM250000R1001	MS116-0.16	2/6
1SAM250000R1002	MS116-0.25	2/6
1SAM250000R1003	MS116-0.4	2/6
1SAM250000R1004	MS116-0.63	2/6
1SAM250000R1005	MS116-1.0	2/6
1SAM250000R1006	MS116-1.6	2/6
1SAM250000R1007	MS116-2.5	2/6
1SAM250000R1008	MS116-4.0	2/6
1SAM250000R1009	MS116-6.3	2/6
1SAM250000R1010	MS116-10	2/6
1SAM250000R1011	MS116-16	2/6
1SAM250000R1012	MS116-12	2/6
1SAM250000R1013	MS116-20	2/6
1SAM250000R1014	MS116-25	2/6
1SAM250000R1015	MS116-32	2/6
1SAM250005R1001	MS116-0.16-HKF1-11	2/6
1SAM250005R1002	MS116-0.25-HKF1-11	2/6
1SAM250005R1003	MS116-0.4-HKF1-11	2/6
1SAM250005R1004	MS116-0.63-HKF1-11	2/6
1SAM250005R1005	MS116-1.0-HKF1-11	2/6
1SAM250005R1006	MS116-1.6-HKF1-11	2/6
1SAM250005R1007	MS116-2.5-HKF1-11	2/6
1SAM250005R1008	MS116-4.0-HKF1-11	2/6
1SAM250005R1009	MS116-6.3-HKF1-11	2/6
1SAM250005R1010	MS116-10.0-HKF1-11	2/6
1SAM250005R1011	MS116-16.0-HKF1-11	2/6
1SAM250005R1012	MS116-12.0-HKF1-11	2/6
1SAM250005R1013	MS116-20-HKF1-11	2/6
1SAM250005R1014	MS116-25-HKF1-11	2/6
1SAM250005R1015	MS116-32-HKF1-11	2/6

Order code	Type	Page
1SAM301901R1001	CK1-11	2/13
1SAM301901R1002	CK1-20	2/13
1SAM301901R1003	CK1-02	2/13
1SAM340000R1001	MS132-0.16T	2/11
1SAM340000R1002	MS132-0.25T	2/11
1SAM340000R1003	MS132-0.4T	2/11
1SAM340000R1004	MS132-0.63T	2/11
1SAM340000R1005	MS132-1.0T	2/11
1SAM340000R1006	MS132-1.6T	2/11
1SAM340000R1007	MS132-2.5T	2/11
1SAM340000R1008	MS132-4.0T	2/11
1SAM340000R1009	MS132-6.3T	2/11
1SAM340000R1010	MS132-10T	2/11
1SAM340000R1011	MS132-16T	2/11
1SAM340000R1012	MS132-12T	2/11
1SAM340000R1013	MS132-20T	2/11
1SAM340000R1014	MS132-25T	2/11
1SAM350000R1001	MS132-0.16	2/7
1SAM350000R1002	MS132-0.25	2/7
1SAM350000R1003	MS132-0.4	2/7
1SAM350000R1004	MS132-0.63	2/7
1SAM350000R1005	MS132-1.0	2/7
1SAM350000R1006	MS132-1.6	2/7
1SAM350000R1007	MS132-2.5	2/7
1SAM350000R1008	MS132-4.0	2/7
1SAM350000R1009	MS132-6.3	2/7
1SAM350000R1010	MS132-10	2/7
1SAM350000R1011	MS132-16	2/7
1SAM350000R1012	MS132-12	2/7
1SAM350000R1013	MS132-20	2/7
1SAM350000R1014	MS132-25	2/7
1SAM350000R1015	MS132-32	2/7
1SAM350005R1001	MS132-0.16-HKF1-11	2/7
1SAM350005R1002	MS132-0.25-HKF1-11	2/7
1SAM350005R1003	MS132-0.4-HKF1-11	2/7
1SAM350005R1004	MS132-0.63-HKF1-11	2/7
1SAM350005R1005	MS132-1.0-HKF1-11	2/7
1SAM350005R1006	MS132-1.6-HKF1-11	2/7
1SAM350005R1007	MS132-2.5-HKF1-11	2/7
1SAM350005R1008	MS132-4.0-HKF1-11	2/7
1SAM350005R1009	MS132-6.3-HKF1-11	2/7
1SAM350005R1010	MS132-10.0-HKF1-11	2/7
1SAM350005R1011	MS132-16.0-HKF1-11	2/7
1SAM350005R1012	MS132-12.0-HKF1-11	2/7
1SAM350005R1013	MS132-20-HKF1-11	2/7
1SAM350005R1014	MS132-25-HKF1-11	2/7
1SAM350005R1015	MS132-32-HKF1-11	2/7
1SAM360000R1001	MO132-0.16	2/9
1SAM360000R1002	MO132-0.25	2/9
1SAM360000R1003	MO132-0.4	2/9
1SAM360000R1004	MO132-0.63	2/9
1SAM360000R1005	MO132-1.0	2/9
1SAM360000R1006	MO132-1.6	2/9
1SAM360000R1007	MO132-2.5	2/9
1SAM360000R1008	MO132-4.0	2/9
1SAM360000R1009	MO132-6.3	2/9
1SAM360000R1010	MO132-10	2/9
1SAM360000R1011	MO132-16	2/9
1SAM360000R1012	MO132-12	2/9
1SAM360000R1013	MO132-20	2/9
1SAM360000R1014	MO132-25	2/9
1SAM360000R1015	MO132-32	2/9
1SAM401901R1001	HK4-11	2/23
1SAM401901R1002	HK4-W	2/23
1SAM401902R1001	HKS4-11	2/23
1SAM401902R1002	HKS4-20	2/23
1SAM401902R1003	HKS4-02	2/23
1SAM401904R1001	SK4-11	2/23
1SAM401905R1001	UA4-110	2/23
1SAM401905R1002	UA4-230	2/23
1SAM401905R1003	UA4-400	2/23
1SAM401905R1004	UA4-24	2/23
1SAM401906R1001	UA4-HK-230	2/23
1SAM401906R1002	UA4-HK-400	2/23
1SAM401907R1001	AA4-24	2/23
1SAM401907R1002	AA4-110	2/23
1SAM401907R1003	AA4-230	2/23
1SAM401907R1004	AA4-400	2/23
1SAM401912R1001	DX495	2/23
1SAM401920R1002	PS2-2-0-125	2/17
1SAM401920R1003	PS2-3-0-125	2/17
1SAM401920R1004	PS2-4-0-125	2/17
1SAM401920R1022	PS2-2-2-125	2/17
1SAM401920R1023	PS2-3-2-125	2/17
1SAM401920R1024	PS2-4-2-125	2/17
1SAM401921R1001	BS2-3	2/17
1SAM401922R1001	KA165	2/17
1SAM451000R1011	MS165-16	2/8
1SAM451000R1012	MS165-20	2/8
1SAM451000R1013	MS165-25	2/8
1SAM451000R1014	MS165-32	2/8
1SAM451000R1015	MS165-42	2/8
1SAM451000R1016	MS165-54	2/8
1SAM451000R1017	MS165-65	2/8

Order code	Type	Page
1SAM461000R1011	MO165-16	2/10
1SAM461000R1012	MO165-20	2/10
1SAM461000R1013	MO165-25	2/10
1SAM461000R1014	MO165-32	2/10
1SAM461000R1015	MO165-42	2/10
1SAM461000R1016	MO165-54	2/10
1SAM461000R1017	MO165-65	2/10
1SAM501901R1001	KA495	2/23
1SAM501902R1001	KA495C	2/23
1SAM550000R1007	MS495-63	2/19
1SAM550000R1008	MS495-75	2/19
1SAM550000R1009	MS495-90	2/19
1SAM550000R1010	MS495-100	2/19
1SAM560000R1007	MO495-63	2/20
1SAM560000R1008	MO495-75	2/20
1SAM560000R1009	MO495-90	2/20
1SAM560000R1010	MO495-100	2/20
1SAM580000R1004	MS497-32	2/19
1SAM580000R1005	MS497-40	2/19
1SAM580000R1006	MS497-50	2/19
1SAM580000R1007	MS497-63	2/19
1SAM580000R1008	MS497-75	2/19
1SAM580000R1009	MS497-90	2/19
1SAM580000R1010	MS497-100	2/19
1SAM590000R1004	MO496-32	2/20
1SAM590000R1005	MO496-40	2/20
1SAM590000R1006	MO496-50	2/20
1SAM590000R1007	MO496-63	2/20
1SAM590000R1008	MO496-75	2/20
1SAM590000R1009	MO496-90	2/20
1SAM590000R1010	MO496-100	2/20
1SAX101110R0001	DB16E	6/10
1SAX101910R1001	DB19EF	6/10
1SAX111001R1101	E16DU-0.32	6/10
1SAX111001R1102	E16DU-1.0	6/10
1SAX111001R1103	E16DU-2.7	6/10
1SAX111001R1104	E16DU-6.3	6/10
1SAX111001R1105	E16DU-18.9	6/10
1SAX121001R1101	EF19-0.32	6/10
1SAX121001R1102	EF19-1.0	6/10
1SAX121001R1103	EF19-2.7	6/10
1SAX121001R1104	EF19-6.3	6/10
1SAX121001R1105	EF19-18.9	5/18
1SAX201910R0001	DB45EF	6/10
1SAX221001R1101	EF45-30	5/18
1SAX221001R1102	EF45-45	5/18
1SAX331001R1101	EF65-70	5/18
1SAX331001R1102	EF65-56	6/11
1SAX341001R1101	EF96-100	5/18
1SAX351001R1101	EF146-150	5/12
1SAX531001R1101	EF205-210	5/12
1SAX611001R1101	EF370-380	5/12
1SAX721001R1101	EF460-500	6/13
1SAX821001R1101	EF750-800	6/13
1SAZ401110R0001	DB200	6/9
1SAZ401901R1001	LT200A	6/9
1SAZ421201R1001	TA200DU-90	6/9
1SAZ421201R1002	TA200DU-110	6/9
1SAZ421201R1003	TA200DU-135	6/9
1SAZ421201R1004	TA200DU-150	6/9
1SAZ421201R1005	TA200DU-175	5/12
1SAZ421201R1006	TA200DU-200	5/12
1SAZ431201R1001	TF140DU-90	6/8
1SAZ431201R1002	TF140DU-110	5/12
1SAZ431201R1003	TF140DU-135	5/16
1SAZ431201R1004	TF140DU-142	5/12
1SAZ431301R1001	TF140DU-90-V1000*	6/8
1SAZ431301R1002	TF140DU-110-V1000*	6/8
1SAZ431301R1003	TF140DU-135-V1000*	6/8
1SAZ431301R1004	TF140DU-142-V1000*	6/8
1SAZ701901R0001	DB16	6/4
1SAZ701902R0001	DB42	6/5
1SAZ701903R1001	WRB-F	6/15
1SAZ701903R1011	WRB-400	6/15
1SAZ701903R1012	WRB-600	6/15
1SAZ701903R1013	WRB-1000	6/15
1SAZ701903R1030	WRB*	6/15
1SAZ711201R1005	T16-0.13	6/4
1SAZ711201R1008	T16-0.17	6/4
1SAZ711201R1009	T16-0.23	6/4
1SAZ711201R1013	T16-0.31	6/4
1SAZ711201R1014	T16-0.41	6/4</

Index

Order code classification

Order code	Type	Page	Order code	Type	Page	Order code	Type	Page
1SAZ711201R1047	T16-16	6/4	1SBH103001R8671	NSL71E-86	4/11	1SBL103001R8632	ASL09-30-32-86	4/7
1SAZ721201R1005	TF42-0.13	6/5	1SBH103001R8680	NSL80E-86	4/11	1SBL103001R8801	ASL09-30-01-88	4/5
1SAZ721201R1008	TF42-0.17	6/5	1SBH103001R8822	NSL22E-88	4/11	1SBL103001R8810	ASL09-30-10-88	4/5
1SAZ721201R1009	TF42-0.23	6/5	1SBH103001R8831	NSL31E-88	4/11	1SBL103001R8832	ASL09-30-32-88	4/7
1SAZ721201R1013	TF42-0.31	6/5	1SBH103001R8840	NSL40E-88	4/11	1SBL111001R1601	AS12-30-01-16	4/4
1SAZ721201R1014	TF42-0.41	6/5	1SBH103001R8844	NSL44E-88	4/11	1SBL111001R1610	AS12-30-10-16	4/4
1SAZ721201R1017	TF42-0.55	6/5	1SBH103001R8853	NSL53E-88	4/11	1SBL111001R1632	AS12-30-32-16	4/6
1SAZ721201R1021	TF42-0.74	6/5	1SBH103001R8862	NSL62E-88	4/11	1SBL111001R2001	AS12-30-01-20	4/4
1SAZ721201R1023	TF42-1.0	6/5	1SBH103001R8871	NSL71E-88	4/11	1SBL111001R2010	AS12-30-10-20	4/4
1SAZ721201R1025	TF42-1.3	6/5	1SBH103001R8880	NSL80E-88	4/11	1SBL111001R2032	AS12-30-32-20	4/6
1SAZ721201R1028	TF42-1.7	6/5	1SBH136001R2022	NFZ22E-20	5/61	1SBL111001R2601	AS12-30-01-26	4/4
1SAZ721201R1031	TF42-2.3	6/5	1SBH136001R2031	NFZ31E-20	5/61	1SBL111001R2610	AS12-30-10-26	4/4
1SAZ721201R1033	TF42-3.1	6/5	1SBH136001R2040	NFZ40E-20	5/61	1SBL111001R2632	AS12-30-32-26	4/6
1SAZ721201R1035	TF42-4.2	6/5	1SBH136001R2122	NFZ22E-21	5/61	1SBL111001R2801	AS12-30-01-28	4/4
1SAZ721201R1038	TF42-5.7	6/5	1SBH136001R2131	NFZ31E-21	5/61	1SBL111001R2810	AS12-30-10-28	4/4
1SAZ721201R1040	TF42-7.6	6/5	1SBH136001R2140	NFZ40E-21	5/61	1SBL111001R2832	AS12-30-32-28	4/6
1SAZ721201R1043	TF42-10	5/16	1SBH136001R2222	NFZ22E-22	5/61	1SBL133001R8101	ASL12-30-01-81	4/5
1SAZ721201R1045	TF42-13	5/16	1SBH136001R2231	NFZ31E-22	5/61	1SBL133001R8110	ASL12-30-10-81	4/5
1SAZ721201R1047	TF42-16	5/16	1SBH136001R2240	NFZ40E-22	5/61	1SBL133001R8132	ASL12-30-32-81	4/7
1SAZ721201R1049	TF42-20	5/22	1SBH136001R2322	NFZ22E-23	5/61	1SBL133001R8301	ASL12-30-01-83	4/5
1SAZ721201R1051	TF42-24	5/16	1SBH136001R2331	NFZ31E-23	5/61	1SBL133001R8310	ASL12-30-10-83	4/5
1SAZ721201R1052	TF42-29	5/22	1SBH136001R2340	NFZ40E-23	5/61	1SBL133001R8332	ASL12-30-32-83	4/7
1SAZ721201R1053	TF42-35	5/16	1SBH137001R1222	NF22E-12	5/60	1SBL133001R8601	ASL12-30-01-86	4/5
1SAZ721201R1055	TF42-38	5/16	1SBH137001R1231	NF31E-12	5/60	1SBL133001R8610	ASL12-30-10-86	4/5
1SAZ801901R1001	DB65	6/6	1SBH137001R1240	NF40E-12	5/60	1SBL133001R8632	ASL12-30-32-86	4/7
1SAZ811201R1001	TF65-28	6/6	1SBH137001R1322	NF22E-13	5/60	1SBL133001R8801	ASL12-30-01-88	4/5
1SAZ811201R1002	TF65-33	6/6	1SBH137001R1331	NF31E-13	5/60	1SBL133001R8810	ASL12-30-10-88	4/5
1SAZ811201R1003	TF65-40	5/16	1SBH137001R1340	NF40E-13	5/60	1SBL133001R8832	ASL12-30-32-88	4/7
1SAZ811201R1004	TF65-47	5/16	1SBH137001R1422	NF22E-14	5/60	1SBL121001R1601	AS16-30-01-16	4/4
1SAZ811201R1005	TF65-53	6/6	1SBH137001R1431	NF31E-14	5/60	1SBL121001R1610	AS16-30-10-16	4/4
1SAZ811201R1006	TF65-60	5/16	1SBH137001R1440	NF40E-14	5/60	1SBL121001R1632	AS16-30-32-16	4/6
1SAZ811201R1007	TF65-67	6/6	1SBH137001R4122	NF22E-41	5/60	1SBL121001R2001	AS16-30-01-20	4/4
1SAZ901901R1001	DB96	6/7	1SBH137001R4131	NF31E-41	5/60	1SBL121001R2010	AS16-30-10-20	4/4
1SAZ911201R1001	TF96-51	6/7	1SBH137001R4140	NF40E-41	5/60	1SBL121001R2032	AS16-30-32-20	4/6
1SAZ911201R1002	TF96-60	6/7	1SBK104035R2800	DRAS09-28P	7/2	1SBL121001R2601	AS16-30-01-26	4/4
1SAZ911201R1003	TF96-68	5/16	1SBK104035R2900	DRAS09-29P	7/2	1SBL121001R2610	AS16-30-10-26	4/4
1SAZ911201R1004	TF96-78	5/22	1SBK104135R2600	DRAS09-26N	7/2	1SBL121001R2632	AS16-30-32-26	4/6
1SAZ911201R1005	TF96-87	5/16	1SBK104135R2700	DRAS09-27N	7/2	1SBL121001R2801	AS16-30-01-28	4/4
1SAZ911201R1006	TF96-96	5/22	1SBK104235R2000	DRAS09-20S	7/2	1SBL121001R2810	AS16-30-10-28	4/4
1SBH101001R1622	NS22E-16	4/10	1SBK104335R8100	DRASL09-81S	7/2	1SBL121001R2832	AS16-30-32-28	4/6
1SBH101001R1631	NS31E-16	4/10	1SBK104335R8300	DRASL09-83S	7/2	1SBL123001R8101	ASL16-30-01-81	4/5
1SBH101001R1640	NS40E-16	4/10	1SBK114035R2800	DRASL12-28P	7/2	1SBL123001R8110	ASL16-30-10-81	4/5
1SBH101001R1644	NS44E-16	4/10	1SBK114035R2900	DRASL12-29P	7/2	1SBL123001R8132	ASL16-30-32-81	4/7
1SBH101001R1653	NS53E-16	4/10	1SBK114135R2600	DRASL12-26N	7/2	1SBL123001R8301	ASL16-30-01-83	4/5
1SBH101001R1662	NS62E-16	4/10	1SBK114135R2700	DRASL12-27N	7/2	1SBL123001R8310	ASL16-30-10-83	4/5
1SBH101001R1671	NS71E-16	4/10	1SBK114235R2000	DRASL12-20S	7/2	1SBL123001R8332	ASL16-30-32-83	4/7
1SBH101001R1680	NS80E-16	4/10	1SBK114335R8100	DRASL12-81S	7/2	1SBL123001R8601	ASL16-30-01-86	4/5
1SBH101001R2022	NS22E-20	4/10	1SBK114335R8300	DRASL12-83S	7/2	1SBL123001R8610	ASL16-30-10-86	4/5
1SBH101001R2031	NS31E-20	4/10	1SBK124035R2800	DRASL16-28P	7/2	1SBL123001R8632	ASL16-30-32-86	4/7
1SBH101001R2040	NS40E-20	4/10	1SBK124035R2900	DRASL16-29P	7/2	1SBL123001R8801	ASL16-30-01-88	4/5
1SBH101001R2044	NS44E-20	4/10	1SBK124135R2600	DRASL16-26N	7/2	1SBL123001R8810	ASL16-30-10-88	4/5
1SBH101001R2053	NS53E-20	4/10	1SBK124135R2700	DRASL16-27N	7/2	1SBL123001R8832	ASL16-30-32-88	4/7
1SBH101001R2062	NS62E-20	4/10	1SBK124235R2000	DRASL16-20S	7/2	1SBL136001R2001	AF09Z-30-01-20	5/29
1SBH101001R2071	NS71E-20	4/10	1SBK124335R8100	DRASL16-81S	7/2	1SBL136001R2010	AF09Z-30-10-20	5/29
1SBH101001R2080	NS80E-20	4/10	1SBK124335R8300	DRASL16-83S	7/2	1SBL136001R2101	AF09Z-30-01-21	5/29
1SBH101001R2622	NS22E-26	4/10	1SBK134037R1400	DRAF09-14P	7/6	1SBL136001R2110	AF09Z-30-10-21	5/4
1SBH101001R2631	NS31E-26	4/10	1SBK134137R1300	DRAF09-13N	7/6	1SBL136001R2201	AF09Z-30-01-22	5/29
1SBH101001R2640	NS40E-26	4/10	1SBK134237R1100	DRAF09-11S	7/6	1SBL136001R2210	AF09Z-30-10-22	5/29
1SBH101001R2644	NS44E-26	4/10	1SBK134238R1100	DRAF09-11U	7/6	1SBL136001R2301	AF09Z-30-01-23	5/29
1SBH101001R2653	NS53E-26	4/10	1SBK134238R1300	DRAF09-13U	7/6	1SBL136001R2310	AF09Z-30-10-23	5/29
1SBH101001R2662	NS62E-26	4/10	1SBK134238R1400	DRAF09-14U	7/6	1SBL136201R2000	AF09Z-40-00-20	5/47
1SBH101001R2671	NS71E-26	4/10	1SBK134303R1400	DRAF12-14P	7/6	1SBL136201R2100	AF09Z-40-00-21	5/47
1SBH101001R2680	NS80E-26	4/10	1SBK134303R1300	DRAF12-13N	7/6	1SBL136201R2200	AF09Z-40-00-22	5/47
1SBH101001R2822	NS22E-28	4/10	1SBK134237R1100	DRAF12-11S	7/6	1SBL136201R2300	AF09Z-40-00-23	5/47
1SBH101001R2831	NS31E-28	4/10	1SBK134238R1100	DRAF12-11U	7/6	1SBL136501R2000	AF09Z-22-00-20	5/47
1SBH101001R2840	NS40E-28	4/10	1SBK134238R1300	DRAF12-13U	7/6	1SBL136501R2100	AF09Z-22-00-21	5/47
1SBH101001R2844	NS44E-28	4/10	1SBK134238R1400	DRAF12-14U	7/6	1SBL136501R2200	AF09Z-22-00-22	5/47
1SBH101001R2853	NS53E-28	4/10	1SBK134303R1400	DRAF16-14P	7/6	1SBL136501R2300	AF09Z-22-00-23	5/47
1SBH101001R2862	NS62E-28	4/10	1SBK134303R1300	DRAF16-13N	7/6	1SBL137001R1201	AF09-30-01-12	5/28
1SBH101001R2871	NS71E-28	4/10	1SBK134303R1100	DRAF16-11S	7/6	1SBL137001R1210	AF09-30-10-12	5/28
1SBH101001R2880	NS80E-28	4/10	1SBK134238R1100	DRAF16-11U	7/6	1SBL137001R1301	AF09-30-01-13	5/28
1SBH103001R8122	NSL22E-81	4/11	1SBK134238R1300	DRAF16-13U	7/6	1SBL137001R1310	AF09-30-10-13	5/28
1SBH103001R8131	NSL31E-81	4/11	1SBK134238R1400	DRAF16-14U	7/6	1SBL137001R1401	AF09-30-01-14	5/4
1SBH103001R8140	NSL40E-81	4/11	1SBL101001R1601	AS09-30-01-16	4/4	1SBL137001R1410	AF09-30-10-14	5/28
1SBH103001R8144	NSL44E-81	4/11	1SBL101001R1610	AS09-30-10-16	4/4	1SBL137001R1610	AF09-30-01-16	5/28
1SBH103001R8153	NSL53E-81	4/11	1SBL101001R1632	AS09-30-32-16	4/6	1SBL137001R1100	AF09-30-10-11	5/28
1SBH103001R8162	NSL62E-81	4/11	1SBL101001R2001	AS09-30-01-20	4/4	1SBL137201R1200	AF09-40-00-12	5/46
1SBH103001R8171	NSL71E-81	4/11	1SBL101001R2010	AS09-30-10-20	4/4	1SBL137201R1300	AF09-40-00-13	5/46
1SBH103001R8180	NSL80E-81	4/11	1SBL101001R2032	AS09-30-32-20	4/6	1SBL137201R1400	AF09-40-00-14	5/46
1SBH103001R8322	NSL22E-83	4/11	1SBL101001R2601	AS09-30-01-26	4/4	1SBL137201R4100	AF09-40-00-41	5/46
1SBH103001R8331	NSL31E-83	4/11	1SBL101001R2610	AS09-30-10-26	4/4	1SBL137501R1200	AF09-22-00-12	5/46
1SBH103001R8340	NSL40E-83	4/11	1SBL101001R2632	AS09-30-32-26	4/6	1SBL137501R1300	AF09-22-00-13	5/46
1SBH103001R8344	NSL44E-83	4/11	1SBL101001R2801	AS09-30-01-28	4/4	1SBL137501R1400	AF09-22-00-14	5/46
1SBH103001R8353	NSL53E-83	4/11	1SBL101001R2810	AS09-30-10-28	4/4	1SBL137501R4100	AF09-22-00-41	5/46
1SBH103001R8362	NSL62E-83	4/11	1SBL101001R2832	AS09-30-32-28	4/6	1SBL156001R2001	AF12Z-30-01-20	5/29
1SBH103001R8371	NSL71E-83	4/11	1SBL103001R8101	ASL09-30-01-81	4/5	1SBL156001R2010	AF12Z-30-10-20	5/29
1SBH103001R8380	NSL80E-83	4/11	1SBL103001R8110	ASL09-30-10-81	4/5	1SBL156001R2101	AF12Z-30-01-21	5/29
1SBH103001R8622	NSL22E-86	4/11	1SBL103001R8132	ASL09-30-32-81	4/5	1SBL156001R2110	AF12Z-30-10-21	5/4
1SBH103001R8631	NSL31E-86	4/11	1SBL103001R8301	ASL09-30-01-83	4/5	1SBL156001R2201	AF12Z-30-01-22	5/29
1SBH103001R8640	NSL40E-86	4/11	1SBL103001R8310	ASL09-30-10-83	4/5	1SBL156001R2210	AF12Z-30-10-22	5/29
1SBH103001R8644	NSL44E-86	4/11	1SBL103001R8332	ASL09-30-32-83	4/7	1SBL156001R2301	AF12Z-30-01-23	5/29
1SBH103001R8653	NSL53E-86	4/11	1SBL103001R8601	ASL09-30-01-86	4/5	1SBL156001R2310	AF12Z-30-10-23	5/29
1SBH103001R8662	NSL62E-86	4/11	1SBL103001R8610	ASL09-30-10-86	4/5	1SBL157001R1201	AF12Z-30-01-12	5/28

Index

Order code classification

Order code	Type	Page
1SBL157001R1210	AF12-30-10-12	5/28
1SBL157001R1301	AF12-30-01-13	5/28
1SBL157001R1310	AF12-30-10-13	5/4
1SBL157001R1401	AF12-30-01-14	5/28
1SBL157001R1410	AF12-30-10-14	5/28
1SBL157001R4101	AF12-30-01-41	5/28
1SBL157001R4110	AF12-30-10-41	5/28
1SBL176001R2001	AF16Z-30-01-20	5/29
1SBL176001R2010	AF16Z-30-10-20	5/29
1SBL176001R2101	AF16Z-30-01-21	5/29
1SBL176001R2110	AF16Z-30-10-21	5/4
1SBL176001R2201	AF16Z-30-01-22	5/29
1SBL176001R2210	AF16Z-30-10-22	5/29
1SBL176001R2301	AF16Z-30-01-23	5/29
1SBL176001R2310	AF16Z-30-10-23	5/29
1SBL176201R2000	AF16Z-40-00-20	5/47
1SBL176201R2100	AF16Z-40-00-21	5/47
1SBL176201R2200	AF16Z-40-00-22	5/47
1SBL176201R2300	AF16Z-40-00-23	5/47
1SBL176501R2000	AF16Z-22-00-20	5/47
1SBL176501R2100	AF16Z-22-00-21	5/47
1SBL176501R2200	AF16Z-22-00-22	5/47
1SBL176501R2300	AF16Z-22-00-23	5/47
1SBL177001R1201	AF16-30-01-12	5/28
1SBL177001R1210	AF16-30-10-12	5/28
1SBL177001R1301	AF16-30-01-13	5/28
1SBL177001R1310	AF16-30-10-13	5/4
1SBL177001R1401	AF16-30-01-14	5/28
1SBL177001R1410	AF16-30-10-14	5/28
1SBL177001R4101	AF16-30-01-41	5/28
1SBL177001R4110	AF16-30-10-41	5/28
1SBL177201R1200	AF16-40-00-12	5/46
1SBL177201R1300	AF16-40-00-13	5/46
1SBL177201R1400	AF16-40-00-14	5/46
1SBL177201R4100	AF16-40-00-41	5/46
1SBL177501R1200	AF16-22-00-12	5/46
1SBL177501R1300	AF16-22-00-13	5/46
1SBL177501R1400	AF16-22-00-14	5/46
1SBL177501R4100	AF16-22-00-41	5/46
1SBL236001R2000	AF26Z-30-00-20	5/29
1SBL236001R2100	AF26Z-30-00-21	5/4
1SBL236001R2200	AF26Z-30-00-22	5/29
1SBL236001R2300	AF26Z-30-00-23	5/29
1SBL236201R2000	AF26Z-40-00-20	5/47
1SBL236201R2100	AF26Z-40-00-21	5/47
1SBL236201R2200	AF26Z-40-00-22	5/47
1SBL236201R2300	AF26Z-40-00-23	5/47
1SBL236501R2000	AF26Z-22-00-20	5/47
1SBL236501R2100	AF26Z-22-00-21	5/47
1SBL236501R2200	AF26Z-22-00-22	5/47
1SBL236501R2300	AF26Z-22-00-23	5/47
1SBL237001R1200	AF26-30-00-12	5/28
1SBL237001R1300	AF26-30-00-13	5/4
1SBL237001R1400	AF26-30-00-14	5/28
1SBL237001R4100	AF26-30-00-41	5/28
1SBL237201R1200	AF26-40-00-12	5/46
1SBL237201R1300	AF26-40-00-13	5/46
1SBL237201R1400	AF26-40-00-14	5/46
1SBL237201R4100	AF26-40-00-41	5/46
1SBL237501R1200	AF26-22-00-12	5/46
1SBL237501R1300	AF26-22-00-13	5/46
1SBL237501R1400	AF26-22-00-14	5/46
1SBL237501R4100	AF26-22-00-41	5/46
1SBL276001R2000	AF30Z-30-00-20	5/29
1SBL276001R2100	AF30Z-30-00-21	5/4
1SBL276001R2200	AF30Z-30-00-22	5/29
1SBL276001R2300	AF30Z-30-00-23	5/29
1SBL277001R1200	AF30-30-00-12	5/28
1SBL277001R1300	AF30-30-00-13	5/4
1SBL277001R1400	AF30-30-00-14	5/28
1SBL277001R4100	AF30-30-00-41	5/28
1SBL296001R2000	AF38Z-30-00-20	5/29
1SBL296001R2100	AF38Z-30-00-21	5/16
1SBL296001R2200	AF38Z-30-00-22	5/29
1SBL296001R2300	AF38Z-30-00-23	5/29
1SBL296201R2000	AF38Z-40-00-20	5/47
1SBL296201R2100	AF38Z-40-00-21	5/47
1SBL296201R2200	AF38Z-40-00-22	5/47
1SBL296201R2300	AF38Z-40-00-23	5/47
1SBL296501R2000	AF38Z-22-00-20	5/47
1SBL296501R2100	AF38Z-22-00-21	5/47
1SBL296501R2200	AF38Z-22-00-22	5/47
1SBL296501R2300	AF38Z-22-00-23	5/47
1SBL297001R1200	AF38-30-00-12	5/28
1SBL297001R1300	AF38-30-00-13	5/16
1SBL297001R1400	AF38-30-00-14	5/28
1SBL297001R4100	AF38-30-00-41	5/28
1SBL297201R1200	AF38-40-00-12	5/46
1SBL297201R1300	AF38-40-00-13	5/46
1SBL297201R1400	AF38-40-00-14	5/46
1SBL297201R4100	AF38-40-00-41	5/46
1SBL297501R1200	AF38-22-00-12	5/46
1SBL297501R1300	AF38-22-00-13	5/46
1SBL297501R1400	AF38-22-00-14	5/46

Order code	Type	Page
1SBL297501R4100	AF38-22-00-41	5/46
1SBL347001R1100	AF40-30-00-11	5/4
1SBL347001R1200	AF40-30-00-12	5/30
1SBL347001R1300	AF40-30-00-13	5/4
1SBL347001R1400	AF40-30-00-14	5/30
1SBL347001R4100	AF40-30-00-41	5/30
1SBL347201R1100	AF40-40-00-11	5/48
1SBL347201R1200	AF40-40-00-12	5/48
1SBL347201R1300	AF40-40-00-13	5/48
1SBL347201R1400	AF40-40-00-14	5/48
1SBL347201R4100	AF40-40-00-41	5/48
1SBL347501R1100	AF40-22-00-11	5/48
1SBL347501R1200	AF40-22-00-12	5/48
1SBL347501R1300	AF40-22-00-13	5/48
1SBL347501R1400	AF40-22-00-14	5/48
1SBL347501R4100	AF40-22-00-41	5/48
1SBL367001R1100	AF52-30-00-11	5/4
1SBL367001R1200	AF52-30-00-12	5/30
1SBL367001R1300	AF52-30-00-13	5/4
1SBL367001R1400	AF52-30-00-14	5/30
1SBL367001R4100	AF52-30-00-41	5/30
1SBL367201R1100	AF52-40-00-11	5/48
1SBL367201R1200	AF52-40-00-12	5/48
1SBL367201R1300	AF52-40-00-13	5/48
1SBL367201R1400	AF52-40-00-14	5/48
1SBL367201R4100	AF52-40-00-41	5/48
1SBL387001R1100	AF65-30-00-11	5/4
1SBL387001R1200	AF65-30-00-12	5/30
1SBL387001R1300	AF65-30-00-13	5/4
1SBL387001R1400	AF65-30-00-14	5/30
1SBL387001R4100	AF65-30-00-41	5/30
1SBL397001R1100	AF80-30-00-11	5/4
1SBL397001R1200	AF80-30-00-12	5/30
1SBL397001R1300	AF80-30-00-13	5/4
1SBL397001R1400	AF80-30-00-14	5/30
1SBL397001R4100	AF80-30-00-41	5/30
1SBL397201R1100	AF80-40-00-11	5/48
1SBL397201R1200	AF80-40-00-12	5/48
1SBL397201R1300	AF80-40-00-13	5/48
1SBL397201R1400	AF80-40-00-14	5/48
1SBL397201R4100	AF80-40-00-41	5/48
1SBL397501R1100	AF80-22-00-11	5/48
1SBL397501R1200	AF80-22-00-12	5/48
1SBL397501R1300	AF80-22-00-13	5/48
1SBL397501R1400	AF80-22-00-14	5/48
1SBL397501R4100	AF80-22-00-41	5/48
1SBL407001R1100	AF96-30-00-11	5/4
1SBL407001R1200	AF96-30-00-12	5/30
1SBL407001R1300	AF96-30-00-13	5/4
1SBL407001R1400	AF96-30-00-14	5/30
1SBL407001R4100	AF96-30-00-41	5/30
1SBLN01003R1010	CB5-10	7/7
1SBLN0110R1001	CA4-01	5/33
1SBLN0110R1010	CA4-10	5/33
1SBLN0110T1001	CA4-01-T	5/33
1SBLN0110T1010	CA4-10-T	5/33
1SBLN0110R1001	CC4-01	5/33
1SBLN0110R1010	CC4-10	5/33
1SBLN01120R1011	CAL4-11	5/33
1SBLN0120T1011	CAL4-11-T	5/33
1SBLN0140R1004	CA4-04E	5/51
1SBLN0140R1022	CA4-22E	5/33
1SBLN0140R1031	CA4-31E	5/51
1SBLN0140R1040	CA4-40E	5/51
1SBLN0140R1122	CA4-22M	5/33
1SBLN0140R1204	CA4-04N	5/63
1SBLN0140R1213	CA4-13N	5/63
1SBLN0140R1222	CA4-22N	5/63
1SBLN0140R1231	CA4-31N	5/63
1SBLN0140R1240	CA4-40N	5/63
1SBLN0140R1322	CA4-22U	5/33
1SBLN0151R1011	CAT4-11E	5/33
1SBLN0151R1111	CAT4-11M	5/33
1SBLN0151R1311	CAT4-11U	5/33
1SBLN0110T1001	CA3-01	4/9
1SBLN0110T1010	CA3-10	4/9
1SBLN020112R1000	TEF4-ON	5/33
1SBLN020114R1000	TEF4-OFF	5/33
1SBLN021012R1000	TEF3-ON	4/9
1SBLN021014R1000	TEF3-OFF	4/9
1SBLN030105T1000	VM4	5/33
1SBLN030111R1000	VM4	5/33
1SBLN0301005T1000	VM3	4/9
1SBLN033405T1000	VM96-4	5/33
1SBLN050010R1000	RV5/50	4/9
1SBLN050010R1001	RV5/133	4/9
1SBLN050010R1002	RV5/250	4/9
1SBLN050010R1003	RV5/440	4/9
1SBLN050020R1000	RT5/32	4/9
1SBLN050020R1001	RT5/65	4/9
1SBLN050020R1002	RT5/90	4/9
1SBLN050020R1003	RT5/150	4/9
1SBLN050020R1004	RT5/264	4/9
1SBLN050100R1000	RCS-1/50	4/9

Order code	Type	Page
1SBLN050100R1001	RCS-1/133	4/9
1SBLN050100R1002	RCS-1/250	4/9
1SBLN050100R1003	RCS-1/440	4/9
1SBLN070156T1000	LDC4	5/63
1SBLN080906R1001	BEA7/325	3/17
1SBLN080906R1002	BEA7/132	3/17
1SBLN081006T1000	BEA16-3	4/9
1SBLN081012R1000	BER16C-3	4/9
1SBLN081018R2000	BEY16C-3	4/9
1SBLN081306T1000	BEA16-4	5/4
1SBLN081311R1000	BER16-4	5/33
1SBLN081313R2000	BEY16-4	5/22
1SBLN082306T1000	BEA26-4	5/5
1SBLN082306T2000	BEA38-4	5/4
1SBLN082311R1000	BER38-4	5/33
1SBLN082713R2000	BEY38-4	5/22
1SBLN083406R1000	BEA65-4	5/4
1SBLN083411R1000	BER65-4	5/33
1SBLN083413R2000	BEY65-4	5/22
1SBLN083911R1000	BER96-4	5/2
1SBLN083913R2000	BEY96-4	5/22
1SBLN101035R1000	FR16AS-12VARS	7/2
1SBLN101337R1000	FR16AF-12	7/7
1SBLN101338R1000	FR16AF-12U	7/7
1SBLN110108T1000	BX4	5/63
1SBLN110109W1000	BX4-CA	5/63
1SBLN101647R1001	OXS6X85	2/24
1SBLN101655R1001	OXS6X130	2/24
1SBLN101659R1001	OXS6X180	2/24
1SBLN108043R1001	OXS6X105	2/24
1SFA611610R2001	MCB-10B	7/2
1SFA616162R1014	KPR-101L	6/4
1SFA739001R1000	E1250DU-1250	6/14
1SFL427001R1111	AF116-30-11-11	5/10
1SFL427001R1211	AF116-30-11-12	5/34
1SFL427001R1311	AF116-30-11-13	5/10
1SFL427001R1411	AF116-30-11-14	5/34
1SFL427001R3311	AF116-30-11-33	5/35
1SFL427001R3411	AF116-30-11-34	5/35
1SFL427002R1111	AF116-30-11B-11	5/34
1SFL427002R1211	AF116-30-11B-12	5/34
1SFL427002R1311	AF116-30-11B-13	5/34
1SFL427002R1411	AF116-30-11B-14	5/34
1SFL427002R2311	AF116-30-11B-33	5/35
1SFL427002R3411	AF116-30-11B-34	5/35
1SFL427101R1111	AF116-40-11-11	5/52
1SFL427101R1211	AF116-40-11-12	5/52
1SFL427101R1311	AF116-40-11-13	5/52
1SFL427101R1411	AF116-40-11-14	5/52
1SFL427102R1111	AF116-40-11B-11	5/52
1SFL427102R1211	AF116-40-11B-12	5/52
1SFL427102R1311	AF116-40-11B-13	5/52
1SFL427102R1411	AF116-40-11B-14	5/52
1SFL447001R1111	AF140-30-11-11	5/10
1SFL447001R1211	AF140-30-11-12	5/34
1SFL447001R1311	AF140-30-11-13	5/10
1SFL447001R1411	AF140-30-11-14	5/34
1SFL447001R3311	AF140-30-11-33	5/35
1SFL447001R3411	AF140-30-11-34	5/35
1SFL447002R1111	AF140-30-11B-11	5/34
1SFL447002R1211	AF140-30-11B-12	5/34
1SFL447002R1311	AF140-30-11B-13	5/34
1SFL447002R1411	AF140-30-11B-14	5/34
1SFL447002R2311	AF140-30-11B-33	5/35
1SFL447002R3411	AF140-30-11B-34	5/35
1SFL447101R1111	AF140-40-11-11	5/52
1SFL447101R1211	AF140-40-11-12	5/52
1SFL447101R1311	AF140-40-11-13	5/52

Index

Order code classification

Order code	Type	Page
1SFL527002R1111	AF205-30-11-11	5/10
1SFL527002R1211	AF205-30-11-12	5/36
1SFL527002R1311	AF205-30-11-13	5/10
1SFL527002R1411	AF205-30-11-14	5/36
1SFL527002R3311	AF205-30-11-33	5/37
1SFL527002R3411	AF205-30-11-34	5/37
1SFL527102R1111	AF205-40-11-11	5/53
1SFL527102R1211	AF205-40-11-12	5/53
1SFL527102R1311	AF205-40-11-13	5/53
1SFL527102R1411	AF205-40-11-14	5/53
1SFL547002R1111	AF265-30-11-11	5/10
1SFL547002R1211	AF265-30-11-12	5/36
1SFL547002R1311	AF265-30-11-13	5/10
1SFL547002R1411	AF265-30-11-14	5/36
1SFL547002R3311	AF265-30-11-33	5/37
1SFL547002R3411	AF265-30-11-34	5/37
1SFL547102R1111	AF265-40-11-11	5/53
1SFL547102R1211	AF265-40-11-12	5/53
1SFL547102R1311	AF265-40-11-13	5/53
1SFL547102R1411	AF265-40-11-14	5/53
1SFL577001R6811	AF400-30-11	5/40
1SFL577001R6911	AF400-30-11	5/40
1SFL577001R7011	AF400-30-11	5/40
1SFL577001R7111	AF400-30-11	5/40
1SFL587002R1111	AF305-30-11-11	5/10
1SFL587002R1211	AF305-30-11-12	5/36
1SFL587002R1311	AF305-30-11-13	5/10
1SFL587002R1411	AF305-30-11-14	5/36
1SFL587002R3311	AF305-30-11-33	5/37
1SFL587002R3411	AF305-30-11-34	5/37
1SFL587102R1111	AF305-40-11-11	5/53
1SFL587102R1211	AF305-40-11-12	5/53
1SFL587102R1311	AF305-40-11-13	5/53
1SFL587102R1411	AF305-40-11-14	5/53
1SFL597001R6811	AF460-30-11	5/40
1SFL597001R6911	AF460-30-11	5/40
1SFL597001R7011	AF460-30-11	5/40
1SFL597001R7111	AF460-30-11	5/40
1SFL607002R1111	AF370-30-11-11	5/12
1SFL607002R1211	AF370-30-11-12	5/36
1SFL607002R1311	AF370-30-11-13	5/12
1SFL607002R1411	AF370-30-11-14	5/36
1SFL607002R3311	AF370-30-11-33	5/37
1SFL607002R3411	AF370-30-11-34	5/37
1SFL607102R1111	AF370-40-11-11	5/53
1SFL607102R1211	AF370-40-11-12	5/53
1SFL607102R1311	AF370-40-11-13	5/53
1SFL607102R1411	AF370-40-11-14	5/53
1SFL617001R6811	AF580-30-11	5/40
1SFL617001R6911	AF580-30-11	5/40
1SFL617001R7011	AF580-30-11	5/40
1SFL617001R7111	AF580-30-11	5/40
1SFL637001R6811	AF750-30-11	5/40
1SFL637001R6911	AF750-30-11	5/40
1SFL637001R7011	AF750-30-11	5/40
1SFL637001R7111	AF750-30-11	5/40
1SFL647001R6811	AF1250-30-11	5/41
1SFL647001R6911	AF1250-30-11	5/41
1SFL647001R7011	AF1250-30-11	5/41
1SFL647001R7111	AF1250-30-11	5/41
1SFL657001R7011	AF1350-30-11	5/41
1SFL667001R7011	AF2650-30-11	5/41
1SFL677001R7011	AF1650-30-11	5/41
1SFL707001R7011	AF2050-30-11	5/41
1SFN010720R1011	CAL18-11	5/43
1SFN010720R3311	CAL18-11B	5/43
1SFN010820R1011	CAL19-11	5/39
1SFN010820R3311	CAL19-11B	5/39
1SFN030300R1000	VM19	5/39
1SFN034403R1000	VM140/190	5/39
1SFN035203R1000	VM205/265	5/39
1SFN035700R1000	VM750H	5/43
1SFN036503R1000	VM1650H	5/43
1SFN074207R1000	LW140	5/39
1SFN074210R1000	LX140	5/39
1SFN074807R1000	LW205	5/39
1SFN074807R2000	LW205-40	5/55
1SFN074810R1000	LX205	5/39
1SFN075407R1000	LW370	5/39
1SFN075407R2000	LW370-40	5/55
1SFN075410R1000	LX370	5/39
1SFN075707R1000	LW460	5/43
1SFN075710R1000	LX460	5/43
1SFN076107R1000	LW750	5/43
1SFN076110R1000	LX750	5/43
1SFN076407R1000	LW1250	5/43
1SFN084206R1000	BEA140/XT2	5/10
1SFN084211R1000	BER140-4	5/17
1SFN084413R1000	BEY140-4	5/22
1SFN084806R1000	BEA205/XT4	5/12
1SFN084806R1001	BEA205/T4	5/10
1SFN084811R1000	BER205-4	5/17
1SFN084813R1000	BEY190-4	5/22

Order code	Type	Page
1SFN085213R1000	BEY205-4	5/24
1SFN085406R1000	BEA370/T5	5/10
1SFN085411R1000	BER370-4	5/19
1SFN085413R1000	BEY265-4	5/24
1SFN085813R1000	BEY370-4	5/24
1SFN124203R1000	LT140-30L	5/39
1SFN124203R2000	LT140-40L	5/55
1SFN124801R1000	LT205-30C	5/39
1SFN124801R2000	LT205-40C	5/55
1SFN124803R1000	LT205-30L	5/39
1SFN124803R2000	LT205-40L	5/55
1SFN124804R1000	LT205-30Y	5/39
1SFN125401R1000	LT370-30C	5/39
1SFN125401R2000	LT370-40C	5/55
1SFN125403R1000	LT370-30L	5/39
1SFN125403R2000	LT370-40L	5/55
1SFN125404R1000	LT370-30Y	5/39
1SFN125406R1000	LT370-30D	5/39
1SFN125701R1000	LT460-AC	5/43
1SFN125703R1000	LT460-AL	5/43
1SFN126101R1000	LT750-AC	5/43
1SFN126103R1000	LT750-AL	5/43
1SVR730100R0300	CT-ERS.21S	5/22
GHV2501902R0002	RV-BC6/60	3/17
GHV2501902R0003	RV-BC6-F/60	3/17
GHV2501903R0002	RV-BC6/250	3/17
GHV2501903R0003	RV-BC6-F/250	3/17
GHV2501904R0002	RV-BC6/380	3/17
GHV2501904R0003	RV-BC6-F/380	3/17
GJF1101903R0001	SA1	2/16
GJF1101903R0002	SA2	2/16
GJF1101903R0003	SA3	2/16
GJH1211001R0221	K6-22Z-01	3/13
GJH1211001R0222	K6-22Z-02	3/13
GJH1211001R0223	K6-22Z-03	3/13
GJH1211001R0311	K6-31Z-01	3/13
GJH1211001R0312	K6-31Z-02	3/13
GJH1211001R0313	K6-31Z-03	3/13
GJH1211001R0401	K6-40E-01	3/13
GJH1211001R0402	K6-40E-02	3/13
GJH1211001R0403	K6-40E-03	3/13
GJH1211001R8220	K6-22Z-80	3/13
GJH1211001R8224	K6-22Z-84	3/13
GJH1211001R8225	K6-22Z-85	3/13
GJH1211001R8310	K6-31Z-80	3/13
GJH1211001R8314	K6-31Z-84	3/13
GJH1211001R8315	K6-31Z-85	3/13
GJH1211001R8400	K6-40E-80	3/13
GJH1211001R8404	K6-40E-84	3/13
GJH1211001R8405	K6-40E-85	3/13
GJH1213001R0221	KC6-22Z-01	3/14
GJH1213001R0223	KC6-22Z-03	3/14
GJH1213001R0224	KC6-22Z-04	3/14
GJH1213001R0225	KC6-22Z-05	3/14
GJH1213001R0227	KC6-22Z-07	3/14
GJH1213001R0311	KC6-31Z-01	3/14
GJH1213001R0313	KC6-31Z-03	3/14
GJH1213001R0314	KC6-31Z-04	3/14
GJH1213001R0315	KC6-31Z-05	3/14
GJH1213001R0317	KC6-31Z-07	3/14
GJH1213001R0401	KC6-40E-01	3/14
GJH1213001R0403	KC6-40E-03	3/14
GJH1213001R0404	KC6-40E-04	3/14
GJH1213001R0405	KC6-40E-05	3/14
GJH1213001R0407	KC6-40E-07	3/14
GJH1213001R1226	KC6-22Z-16	3/14
GJH1213001R1316	KC6-31Z-16	3/14
GJH1213001R1406	KC6-40E-16	3/14
GJH1213001R5311	KC6-31Z-2.4-51	3/15
GJH1213001R5401	KC6-40E-2.4-51	3/15
GJH1213001R7221	K6S-22Z-1.7-71	3/15
GJH1213001R7222	K6S-22Z-2.8-72	3/15
GJH1213001R7311	K6S-31Z-1.7-71	3/15
GJH1213001R7312	K6S-31Z-2.8-72	3/15
GJH1213001R7401	K6S-40E-1.7-71	3/15
GJH1213001R7402	K6S-40E-2.8-72	3/15
GJH1213001R8311	KC6-31Z-1.4-81	3/15
GJH1213001R8401	KC6-40E-1.4-81	3/15
GJH1213061R5221	TKC6-22Z-51	3/16
GJH1213061R5225	TKC6-22Z-55	3/16
GJH1213061R5311	TKC6-31Z-51	3/16
GJH1213061R5315	TKC6-31Z-55	3/16
GJH1213061R5401	TKC6-40E-51	3/16
GJH1213061R5405	TKC6-40E-55	3/16
GJH1213061R6222	TKC6-22Z-62	3/16
GJH1213061R6228	TKC6-22Z-68	3/16
GJH1213061R6312	TKC6-31Z-62	3/16
GJH1213061R6318	TKC6-31Z-68	3/16
GJH1213061R6402	TKC6-40E-62	3/16
GJH1213061R6408	TKC6-40E-68	3/16
GJL1201317R0001	CA6-11K	3/18
GJL1201317R0002	CA6-11E	3/17
GJL1201317R0003	CA6-11M	3/17

Order code	Type	Page
GJL1201317R0004	CA6-11N	3/17
GJL1201330R0001	CAF6-11K	3/18
GJL1201330R0002	CAF6-11E	3/17
GJL1201330R0003	CAF6-11M	3/17
GJL1201330R0004	CAF6-11N	3/17
GJL1201330R0005	CAF6-20K	3/18
GJL1201330R0006	CAF6-20E	3/17
GJL1201330R0007	CAF6-20M	3/17
GJL1201330R0008	CAF6-20N	3/17
GJL1201330R0009	CAF6-02K	3/18
GJL1201330R0010	CAF6-02E	3/17
GJL1201330R0011	CAF6-02M	3/17
GJL1201330R0012	CAF6-02N	3/17
GJL1201906R0001	LT6-B	3/17
GJL1201907R0001	LP6	3/17
GJL1201908R0001	BSM6-30	3/17
GJL1211001R0011	B6-30-01-01	3/4
GJL1211001R0012	B6-30-01-02	3/4
GJL1211001R0013	B6-30-01-03	3/4
GJL1211001R0101	B6-30-10-01	3/4
GJL1211001R0102	B6-30-10-02	3/4
GJL1211001R0103	B6-30-10-03	3/4
GJL1211001R8010	B6-30-01-80	3/4
GJL1211001R8014	B6-30-01-84	3/4
GJL1211001R8015	B6-30-01-85	3/4
GJL1211001R8100	B6-30-10-80	3/4
GJL1211001R8104	B6-30-10-84	3/4
GJL1211001R8105	B6-30-10-85	3/4
GJL12121001R0001	B6-40-00-01	3/10
GJL12121001R0002	B6-40-00-02	3/10
GJL12121001R0003	B6-40-00-03	3/10
GJL12121001R8000	B6-40-00-80	3/10
GJL12121001R8004	B6-40-00-84	3/10
GJL12121001R0001	B6-22-00-01	3/10
GJL12121501R0002	B6-22-00-02	3/10
GJL12121501R0003	B6-22-00-03	3/10
GJL12121501R8000	B6-22-00-80	3/10
GJL12121501R8004	B6-22-00-84	3/10
GJL1215001R0001	VB6-30-01-01	3/6
GJL1215001R0012	VB6-30-01-02	3/6
GJL1215001R0013	VB6-30-01-03	3/6
GJL1215001R0101	VB6-30-10-01	3/6
GJL1215001R0102	VB6-30-10-02	3/6
GJL1215001R0103	VB6-30-10-03	3/6
GJL1215001R8010	VB6-30-01-80	3/6
GJL1215001R8014	VB6-30-01-84	3/6
GJL1215001R8015	VB6-30-01-85	3/6
GJL1215001R8100	VB6-30-10-80	3/6
GJL1215001R8104	VB6-30-10-84	3/6
GJL1215001R8105	VB6-30-10-85	3/6
GJL1213001R0011	BC6-30-01-01	3/5
GJL1213001R0013	BC6-30-01-03	3/5
GJL1213001R0014	BC6-30-01-04	3/5
GJL1213001R0015	BC6-30-01-05	3/5
GJL1213001R0017	BC6-30-01-07	3/5
GJL1213001R0101	BC6-30-10-01	3/5
GJL1213001R0103	BC6-30-10-03	3/5
GJL1213001R0104	BC6-30-10-04	3/5
GJL1213001R0105	BC6-30-10-05	3/5
GJL1213001R0107	BC6-30-10-07	3/5
GJL1213001R0106	BC6-30-01-16	3/5
GJL1213001R1106	BC6-30-10-16	3/5
GJL1213001R5011	BC6-30-01-2.4-51	3/8
GJL1213001R5101	BC6-30-10-2.4-51	3/8
GJL1213001R7011	B6S-30-01-1.7-71	3/8
GJL1213001R7012	B6S-30-01-2.8-72	3/8
GJL1213001R7101	B6S-30-10-1.7-71	3/8
GJL1213001R7102	B6S-30-10-2.8-72	3/8
GJL1213001R8011	BC6-30-01-1.4-81	3/8

Index

Type classification

Type	Order code	Page	Type	Order code	Page	Type	Order code	Page
GJL1311001R0102	B7-30-10-02	3/4						
GJL1311001R0103	B7-30-10-03	3/4						
GJL1311001R8010	B7-30-01-80	3/4						
GJL1311001R8014	B7-30-01-84	3/4						
GJL1311001R8015	B7-30-01-85	3/4						
GJL1311001R8100	B7-30-10-80	3/4						
GJL1311001R8104	B7-30-10-84	3/4						
GJL1311001R8105	B7-30-10-85	3/4						
GJL1311201R0001	B7-40-00-01	3/10						
GJL1311201R0002	B7-40-00-02	3/10						
GJL1311201R0003	B7-40-00-03	3/10						
GJL1311201R8000	B7-40-00-80	3/10						
GJL1311201R8004	B7-40-00-84	3/10						
GJL1311501R0001	B7-22-00-01	3/10						
GJL1311501R0002	B7-22-00-02	3/10						
GJL1311501R0003	B7-22-00-03	3/10						
GJL1311501R8000	B7-22-00-80	3/10						
GJL1311501R8004	B7-22-00-84	3/10						
GJL1311901R0011	VB7-30-01-01	3/6						
GJL1311901R0012	VB7-30-01-02	3/6						
GJL1311901R0013	VB7-30-01-03	3/6						
GJL1311901R0101	VB7-30-10-01	3/6						
GJL1311901R0102	VB7-30-10-02	3/6						
GJL1311901R0103	VB7-30-10-03	3/6						
GJL1311901R8010	VB7-30-01-80	3/6						
GJL1311901R8014	VB7-30-01-84	3/6						
GJL1311901R8015	VB7-30-01-85	3/6						
GJL1311901R8100	VB7-30-10-80	3/6						
GJL1311901R8104	VB7-30-10-84	3/6						
GJL1311901R8105	VB7-30-10-85	3/6						
GJL1313001R0011	BC7-30-01-01	3/5						
GJL1313001R0013	BC7-30-01-03	3/5						
GJL1313001R0014	BC7-30-01-04	3/5						
GJL1313001R0015	BC7-30-01-05	3/5						
GJL1313001R0017	BC7-30-01-07	3/5						
GJL1313001R0101	BC7-30-10-01	3/5						
GJL1313001R0104	BC7-30-10-04	3/5						
GJL1313001R0105	BC7-30-10-05	3/5						
GJL1313001R0107	BC7-30-10-07	3/5						
GJL1313001R1016	BC7-30-01-16	3/5						
GJL1313001R1103	BC7-30-10-03	3/5						
GJL1313001R1106	BC7-30-10-16	3/5						
GJL1313001R5011	BC7-30-01-2.4-51	3/8						
GJL1313001R5101	BC7-30-10-2.4-51	3/8						
GJL1313001R7011	B7S-30-01-1.7-71	3/8						
GJL1313001R7012	B7S-30-01-2.8-72	3/8						
GJL1313001R7101	B7S-30-10-1.7-71	3/8						
GJL1313001R7102	B7S-30-10-2.8-72	3/8						
GJL1313001R8011	BC7-30-01-1.4-81	3/8						
GJL1313001R8101	BC7-30-10-1.4-81	3/8						
GJL1313061R5011	TBC7-30-01-51	3/9						
GJL1313061R5015	TBC7-30-01-55	3/9						
GJL1313061R5101	TBC7-30-10-51	3/9						
GJL1313061R5105	TBC7-30-10-55	3/9						
GJL1313061R6012	TBC7-30-01-62	3/9						
GJL1313061R6018	TBC7-30-01-68	3/9						
GJL1313061R6102	TBC7-30-10-62	3/9						
GJL1313061R6108	TBC7-30-10-68	3/9						
GJL1313461R5005	TBC7-31-00-55	3/12						
GJL1313461R6002	TBC7-31-00-62	3/12						
GJL1313461R6008	TBC7-31-00-68	3/12						
GJL1313561R5005	TBC7-22-00-55	3/12						
GJL1313561R6002	TBC7-22-00-62	3/12						
GJL1313561R6008	TBC7-22-00-68	3/12						
GJL1313901R0011	VBC7-30-01-01	3/7						
GJL1313901R0013	VBC7-30-01-03	3/7						
GJL1313901R0014	VBC7-30-01-04	3/7						
GJL1313901R0015	VBC7-30-01-05	3/7						
GJL1313901R0017	VBC7-30-01-07	3/7						
GJL1313901R0101	VBC7-30-10-01	3/7						
GJL1313901R0103	VBC7-30-10-03	3/7						
GJL1313901R0104	VBC7-30-10-04	3/7						
GJL1313901R0105	VBC7-30-10-05	3/7						
GJL1313901R0107	VBC7-30-10-07	3/7						
GJL1313901R1016	VBC7-30-01-16	3/7						
GJL1313901R1106	VBC7-30-10-16	3/7						
GJL1317001R0011	B7D-30-01-01	3/5						
GJL1317001R0015	B7D-30-01-05	3/5						
GJL1317001R0101	B7D-30-10-01	3/5						
GJL1317001R0105	B7D-30-10-05	3/5						
GJL1317201R0001	B7D-40-00-01	3/11						
GJL1317201R0005	B7D-40-00-05	3/11						

Index

Type classification

Type	Order code	Page
AA1-110	1SAM201910R1002	2/14
AA1-230	1SAM201910R1003	2/14
AA1-24	1SAM201910R1001	2/14
AA1-400	1SAM201910R1004	2/14
AA4-110	1SAM401907R1002	2/23
AA4-230	1SAM401907R1003	2/23
AA4-24	1SAM401907R1001	2/23
AA4-400	1SAM401907R1004	2/23
AF09-22-00-12	1SBL137501R1200	5/46
AF09-22-00-13	1SBL137501R1300	5/46
AF09-22-00-14	1SBL137501R1400	5/46
AF09-22-00-41	1SBL137501R4100	5/46
AF09-30-01-12	1SBL137001R1201	5/28
AF09-30-01-13	1SBL137001R1301	5/28
AF09-30-01-14	1SBL137001R1401	5/28
AF09-30-01-41	1SBL137001R4101	5/28
AF09-30-10-12	1SBL137001R1210	5/28
AF09-30-10-13	1SBL137001R1310	5/4
AF09-30-10-14	1SBL137001R1410	5/28
AF09-30-10-41	1SBL137001R4110	5/28
AF09-40-00-12	1SBL137201R1200	5/46
AF09-40-00-13	1SBL137201R1300	5/46
AF09-40-00-14	1SBL137201R1400	5/46
AF09-40-00-41	1SBL137201R4100	5/46
AF09Z-22-00-20	1SBL136501R2000	5/47
AF09Z-22-00-21	1SBL136501R2100	5/47
AF09Z-22-00-22	1SBL136501R2200	5/47
AF09Z-22-00-23	1SBL136501R2300	5/47
AF09Z-30-01-20	1SBL136001R2001	5/29
AF09Z-30-01-21	1SBL136001R2101	5/29
AF09Z-30-01-22	1SBL136001R2201	5/29
AF09Z-30-01-23	1SBL136001R2301	5/29
AF09Z-30-10-20	1SBL136001R2010	5/29
AF09Z-30-10-21	1SBL136001R2110	5/4
AF09Z-30-10-22	1SBL136001R2210	5/29
AF09Z-30-10-23	1SBL136001R2310	5/29
AF09Z-40-00-20	1SBL136201R2000	5/47
AF09Z-40-00-21	1SBL136201R2100	5/47
AF09Z-40-00-22	1SBL136201R2200	5/47
AF09Z-40-00-23	1SBL136201R2300	5/47
AF116-30-11-11	1SFL427001R1111	5/10
AF116-30-11-11 (1SFL427001R1111	5/22
AF116-30-11-12	1SFL427001R1211	5/34
AF116-30-11-13	1SFL427001R1311	5/10
AF116-30-11-14	1SFL427001R1411	5/34
AF116-30-11-33	1SFL427001R3311	5/35
AF116-30-11-34	1SFL427001R3411	5/35
AF116-30-11B-11	1SFL427002R1111	5/34
AF116-30-11B-12	1SFL427002R1211	5/34
AF116-30-11B-13	1SFL427002R1311	5/34
AF116-30-11B-14	1SFL427002R1411	5/34
AF116-30-11B-33	1SFL427002R3311	5/35
AF116-30-11B-34	1SFL427002R3411	5/35
AF116-40-11-11	1SFL427101R1111	5/52
AF116-40-11-12	1SFL427101R1211	5/52
AF116-40-11-13	1SFL427101R1311	5/52
AF116-40-11-14	1SFL427101R1411	5/52
AF116-40-11B-11	1SFL427102R1111	5/52
AF116-40-11B-12	1SFL427102R1211	5/52
AF116-40-11B-13	1SFL427102R1311	5/52
AF116-40-11B-14	1SFL427102R1411	5/52
AF12-30-01-12	1SBL157001R1201	5/28
AF12-30-01-13	1SBL157001R1301	5/28
AF12-30-01-14	1SBL157001R1401	5/28
AF12-30-01-41	1SBL157001R4101	5/28
AF12-30-10-12	1SBL157001R1210	5/28
AF12-30-10-13	1SBL157001R1310	5/4
AF12-30-10-14	1SBL157001R1410	5/28
AF12-30-10-41	1SBL157001R4110	5/28
AF1250-30-11	1SFL647001R6811	5/41
AF12Z-30-01-20	1SBL156001R2001	5/29
AF12Z-30-01-21	1SBL156001R2101	5/29
AF12Z-30-01-22	1SBL156001R2201	5/29
AF12Z-30-01-23	1SBL156001R2301	5/29
AF12Z-30-10-20	1SBL156001R2010	5/29
AF12Z-30-10-21	1SBL156001R2110	5/4
AF12Z-30-10-22	1SBL156001R2210	5/29
AF12Z-30-10-23	1SBL156001R2310	5/29
AF1350-30-11	1SFL657001R7011	5/41
AF140-30-11-11	1SFL447001R1111	5/10
AF140-30-11-12	1SFL447001R1211	5/34
AF140-30-11-13	1SFL447001R1311	5/10
AF140-30-11-14	1SFL447001R1411	5/34
AF140-30-11-33	1SFL447001R3311	5/35
AF140-30-11-34	1SFL447001R3411	5/35
AF140-30-11B-11	1SFL447002R1111	5/34
AF140-30-11B-12	1SFL447002R1211	5/34
AF140-30-11B-13	1SFL447002R1311	5/34
AF140-30-11B-14	1SFL447002R1411	5/34
AF140-30-11B-33	1SFL447002R3311	5/35
AF140-30-11B-34	1SFL447002R3411	5/35
AF140-40-11-11	1SFL447101R1111	5/52
AF140-40-11-12	1SFL447101R1211	5/52

Type	Order code	Page
AF140-40-11-13	1SFL447101R1311	5/52
AF140-40-11-14	1SFL447101R1411	5/52
AF140-40-11B-11	1SFL447102R1111	5/52
AF140-40-11B-12	1SFL447102R1211	5/52
AF140-40-11B-13	1SFL447102R1311	5/52
AF140-40-11B-14	1SFL447102R1411	5/52
AF146-30-11-11	1SFL467001R1111	5/34
AF146-30-11-12	1SFL467001R1211	5/34
AF146-30-11-13	1SFL467001R1311	5/34
AF146-30-11-14	1SFL467001R1411	5/34
AF146-30-11-33	1SFL467001R3311	5/35
AF146-30-11-34	1SFL467001R3411	5/35
AF146-30-11B-11	1SFL467002R1111	5/34
AF146-30-11B-12	1SFL467002R1211	5/34
AF146-30-11B-13	1SFL467002R1311	5/34
AF146-30-11B-14	1SFL467002R1411	5/34
AF146-30-11B-33	1SFL467002R3311	5/35
AF16-22-00-12	1SBL177501R1200	5/46
AF16-22-00-13	1SBL177501R1300	5/46
AF16-22-00-14	1SBL177501R1400	5/46
AF16-22-00-41	1SBL177501R4100	5/46
AF16-30-01-12	1SBL177001R1201	5/28
AF16-30-01-13	1SBL177001R1301	5/28
AF16-30-01-14	1SBL177001R1401	5/28
AF16-30-01-41	1SBL177001R4101	5/28
AF16-30-10-12	1SBL177001R1210	5/28
AF16-30-10-13	1SBL177001R1310	5/4
AF16-30-10-14	1SBL177001R1410	5/28
AF16-30-10-41	1SBL177001R4110	5/28
AF16-40-00-12	1SBL177201R1200	5/46
AF16-40-00-13	1SBL177201R1300	5/46
AF16-40-00-14	1SBL177201R1400	5/46
AF16-40-00-41	1SBL177201R4100	5/46
AF1650-30-11	1SFL677001R7011	5/41
AF16Z-22-00-20	1SBL176501R2000	5/47
AF16Z-22-00-21	1SBL176501R2100	5/47
AF16Z-22-00-22	1SBL176501R2200	5/47
AF16Z-22-00-23	1SBL176501R2300	5/47
AF16Z-30-01-20	1SBL176001R2001	5/29
AF16Z-30-01-21	1SBL176001R2101	5/29
AF16Z-30-01-22	1SBL176001R2201	5/29
AF16Z-30-01-23	1SBL176001R2301	5/29
AF16Z-30-10-20	1SBL176001R2010	5/29
AF16Z-30-10-21	1SBL176001R2110	5/4
AF16Z-30-10-22	1SBL176001R2210	5/29
AF16Z-30-10-23	1SBL176001R2310	5/29
AF16Z-40-00-20	1SBL176201R2000	5/47
AF16Z-40-00-21	1SBL176201R2100	5/47
AF16Z-40-00-22	1SBL176201R2200	5/47
AF16Z-40-00-23	1SBL176201R2300	5/47
AF190-30-11-11	1SFL487002R1111	5/10
AF190-30-11-12	1SFL487002R1211	5/36
AF190-30-11-13	1SFL487002R1311	5/10
AF190-30-11-14	1SFL487002R1411	5/36
AF190-30-11-33	1SFL487002R3311	5/37
AF190-30-11-34	1SFL487002R3411	5/37
AF190-40-11-11	1SFL487102R1111	5/53
AF190-40-11-12	1SFL487102R1211	5/53
AF190-40-11-13	1SFL487102R1311	5/53
AF190-40-11-14	1SFL487102R1411	5/53
AF2050-30-11	1SFL707001R7011	5/41
AF205-30-11-11	1SFL527002R1111	5/10
AF205-30-11-12	1SFL527002R1211	5/36
AF205-30-11-13	1SFL527002R1311	5/10
AF205-30-11-14	1SFL527002R1411	5/36
AF205-30-11-33	1SFL527002R3311	5/37
AF205-30-11-34	1SFL527002R3411	5/37
AF205-40-11-11	1SFL527102R1111	5/53
AF205-40-11-12	1SFL527102R1211	5/53
AF205-40-11-13	1SFL527102R1311	5/53
AF205-40-11-14	1SFL527102R1411	5/53
AF26-22-00-12	1SBL237501R1200	5/46
AF26-22-00-13	1SBL237501R1300	5/46
AF26-22-00-14	1SBL237501R1400	5/46
AF26-22-00-41	1SBL237501R4100	5/46
AF26-30-00-12	1SBL237001R1200	5/28
AF26-30-00-13	1SBL237001R1300	5/4
AF26-30-00-14	1SBL237001R1400	5/28
AF26-30-00-41	1SBL237001R4100	5/28
AF26-40-00-12	1SBL237201R1200	5/46
AF26-40-00-13	1SBL237201R1300	5/46
AF26-40-00-14	1SBL237201R1400	5/46
AF26-40-00-41	1SBL237201R4100	5/46
AF2650-30-11	1SFL667001R7011	5/41
AF265-30-11-11	1SFL547002R1111	5/10
AF265-30-11-12	1SFL547002R1211	5/36
AF265-30-11-13	1SFL547002R1311	5/10
AF265-30-11-14	1SFL547002R1411	5/36
AF265-30-11-33	1SFL547002R3311	5/37
AF265-30-11-34	1SFL547002R3411	5/37
AF265-40-11-11	1SFL547102R1111	5/53
AF265-40-11-12	1SFL547102R1211	5/53
AF265-40-11-13	1SFL547102R1311	5/53
AF265-40-11-14	1SFL547102R1411	5/53

Type	Order code	Page
AF265-40-11-14	1SFL547102R1411	5/53
AF26Z-22-00-20	1SBL236501R2000	5/47
AF26Z-22-00-21	1SBL236501R2100	5/47
AF26Z-22-00-22	1SBL236501R2200	5/47
AF26Z-22-00-23	1SBL236501R2300	5/47
AF26Z-30-00-20	1SBL236001R2000	5/29
AF26Z-30-00-21	1SBL236001R2100	5/4
AF26Z-30-00-22	1SBL236001R2200	5/29
AF26Z-30-00-23	1SBL236001R2300	5/29
AF26Z-40-00-20	1SBL236201R2000	5/47
AF26Z-40-00-21	1SBL236201R2100	5/47
AF26Z-40-00-22	1SBL236201R2200	5/47
AF26Z-40-00-23	1SBL236201R2300	5/47
AF30-30-00-12	1SBL277001R1200	5/28
AF30-30-00-13	1SBL277001R1300	5/4
AF30-30-00-14	1SBL277001R1400	5/28
AF30-30-00-41	1SBL277001R4100	5/28
AF305-30-11-11	1SFL587002R1111	5/10
AF305-30-11-12	1SFL587002R1211	5/36
AF305-30-11-13	1SFL587002R1311	5/10
AF305-40-11-14	1SFL587002R1411	5/36
AF305-30-11-33	1SFL587002R3311	5/37
AF305-30-11-34	1SFL587002R3411	5/37
AF305-40-11-11	1SFL587102R1111	5/53
AF305-40-11-12	1SFL587102R1211	5/53
AF305-40-11-13	1SFL587102R1311	5/53
AF305-40-11-14	1SFL587102R1411	5/53
AF30Z-30-00-20	1SBL276001R2000	5/29
AF30Z-30-00-21	1SBL276001R2100	5/4
AF30Z-30-00-22	1SBL276001R2200	5/29
AF30Z-30-00-23	1SBL276001R2300	5/29
AF370-30-11-11	1SFL607002R1111	5/12
AF370-30-11-12	1SFL607002R1211	5/36
AF370-30-11-13	1SFL607002R1311	5/12
AF370-30-11-14	1SFL607002R1411	5/36
AF370-30-11-33	1SFL607002R3311	5/37
AF370-30-11-34	1SFL607002R3411	5/37
AF370-40-11-11	1SFL607102R1111	5/53
AF370-40-11-12	1SFL607102R1211	5/53
AF370-40-11-13	1SFL607102R1311	5/53
AF370-40-11-14	1SFL607102R1411	5/53
AF38-22-00-12	1SBL297501R1200	5/46
AF38-22-00-13	1SBL297501R1300	5/46
AF38-22-00-14	1SBL297501R1400	5/46
AF38-22-00-41	1SBL297501R4100	5/46
AF38-30-00-12	1SBL297001R1200	5/28
AF38-30-00-13	1SBL297001R1300	5/16
AF38-30-00-14	1SBL297001R1400	5/28
AF38-30-00-41	1SBL297001R4100	5/28
AF38-40-00-12	1SBL297201R1200	5/46
AF38-40-00-13	1SBL297201R1300	5/46
AF38-40-00-14	1SBL297201R1400	5/46

Index

Type classification

Type	Order code	Page	Type	Order code	Page	Type	Order code	Page
AF65-30-00-11	1SBL387001R1100	5/4	ASL16-30-32-81	1SBL123001R8132	4/7	BC7-30-10-03	GJL1313001R1103	3/5
AF65-30-00-12	1SBL387001R1200	5/30	ASL16-30-32-83	1SBL123001R8332	4/7	BC7-30-10-04	GJL1313001R0104	3/5
AF65-30-00-13	1SBL387001R1300	5/4	ASL16-30-32-86	1SBL123001R8632	4/7	BC7-30-10-05	GJL1313001R0105	3/5
AF65-30-00-14	1SBL387001R1400	5/30	ASL16-30-32-88	1SBL123001R8832	4/7	BC7-30-10-07	GJL1313001R0107	3/5
AF65-30-00-41	1SBL387001R4100	5/30	B6-22-00-01	GJL1211501R0001	3/10	BC7-30-10-1.4-81	GJL1313001R8101	3/8
AF750-30-11	1SFL637001R6811	5/40	B6-22-00-02	GJL1211501R0002	3/10	BC7-30-10-16	GJL1313001R1106	3/5
AF80-22-00-11	1SBL397501R1100	5/48	B6-22-00-03	GJL1211501R0003	3/10	BC7-30-10-2.4-51	GJL1313001R5101	3/8
AF80-22-00-12	1SBL397501R1200	5/48	B6-22-00-80	GJL1211501R8000	3/10	BEA140/XT2	1SFN084206R1000	5/10
AF80-22-00-13	1SBL397501R1300	5/48	B6-22-00-84	GJL1211501R8004	3/10	BEA16-3	1SBN081006T1000	4/9
AF80-22-00-14	1SBL397501R1400	5/48	B6-30-01-01	GJL1211001R0011	3/4	BEA16-4	1SBN081306T1000	5/33
AF80-22-00-41	1SBL397501R4100	5/48	B6-30-01-02	GJL1211001R0012	3/4	BEA205/T4	1SFN084806R1001	5/10
AF80-30-00-11	1SBL397001R1100	5/4	B6-30-01-03	GJL1211001R0013	3/4	BEA205/XT4	1SFN084806R1000	5/12
AF80-30-00-12	1SBL397001R1200	5/30	B6-30-01-80	GJL1211001R8010	3/4	BEA26-4	1SBN082306T1000	5/33
AF80-30-00-13	1SBL397001R1300	5/4	B6-30-01-84	GJL1211001R8014	3/4	BEA370/T5	1SFN085406R1000	5/10
AF80-30-00-14	1SBL397001R1400	5/30	B6-30-01-85	GJL1211001R8015	3/4	BEA38-4	1SBN082306T2000	5/33
AF80-30-00-41	1SBL397001R4100	5/30	B6-30-10-01	GJL1211001R0101	3/4	BEA65-4	1SBN083406R1000	5/33
AF80-40-00-11	1SBL397201R1100	5/48	B6-30-10-02	GJL1211001R0102	3/4	BEA7/132	1SBN080906R1002	3/17
AF80-40-00-12	1SBL397201R1200	5/48	B6-30-10-03	GJL1211001R0103	3/4	BEA7/325	1SBN080906R1001	3/17
AF80-40-00-13	1SBL397201R1300	5/48	B6-30-10-80	GJL1211001R8100	3/4	BER140-4	1SFN084211R1000	5/17
AF80-40-00-14	1SBL397201R1400	5/48	B6-30-10-84	GJL1211001R8104	3/4	BER16-4	1SBN081311R1000	5/33
AF80-40-00-41	1SBL397201R4100	5/48	B6-30-10-85	GJL1211001R8105	3/4	BER16C-3	1SBN081012R1000	4/9
AF96-30-00-11	1SBL407001R1100	5/4	B6-40-00-01	GJL1211201R0001	3/10	BER205-4	1SFN084811R1000	5/17
AF96-30-00-12	1SBL407001R1200	5/30	B6-40-00-02	GJL1211201R0002	3/10	BER370-4	1SFN085411R1000	5/19
AF96-30-00-13	1SBL407001R1300	5/4	B6-40-00-03	GJL1211201R0003	3/10	BER38-4	1SBN082311R1000	5/33
AF96-30-00-14	1SBL407001R1400	5/30	B6-40-00-80	GJL1211201R8000	3/10	BER65-4	1SBN083411R1000	5/33
AF96-30-00-41	1SBL407001R4100	5/30	B6-40-00-84	GJL1211201R8004	3/10	BER96-4	1SBN083911R1000	5/33
AS09-30-01-16	1SBL101001R1601	4/4	B6S-30-01-1.7-71	GJL1213001R7011	3/8	BEY140-4	1SFN084413R1000	5/22
AS09-30-01-20	1SBL101001R2001	4/4	B6S-30-01-2.8-72	GJL1213001R7012	3/8	BEY16-4	1SBN081313R2000	5/33
AS09-30-01-26	1SBL101001R2601	4/4	B6S-30-10-1.7-71	GJL1213001R7101	3/8	BEY16C-3	1SBN081018R2000	4/9
AS09-30-01-28	1SBL101001R2801	4/4	B6S-30-10-2.8-72	GJL1213001R7102	3/8	BEY190-4	1SFN084813R1000	5/22
AS09-30-10-16	1SBL101001R1610	4/4	B7-22-00-01	GJL1311501R0001	3/10	BEY205-4	1SFN085213R1000	5/24
AS09-30-10-20	1SBL101001R2010	4/4	B7-22-00-02	GJL1311501R0002	3/10	BEY265-4	1SFN085413R1000	5/24
AS09-30-10-26	1SBL101001R2610	4/4	B7-22-00-03	GJL1311501R0003	3/10	BEY370-4	1SFN085813R1000	5/24
AS09-30-10-28	1SBL101001R2810	4/4	B7-22-00-80	GJL1311501R8000	3/10	BEY38-4	1SBN082713R2000	5/33
AS09-30-32-16	1SBL101001R1632	4/6	B7-22-00-84	GJL1311501R8004	3/10	BEY65-4	1SBN083413R2000	5/33
AS09-30-32-20	1SBL101001R2032	4/6	B7-30-01-01	GJL1311001R0011	3/4	BEY96-4	1SBN083913R2000	5/33
AS09-30-32-26	1SBL101001R2632	4/6	B7-30-01-02	GJL1311001R0012	3/4	BS1-3	1SAM201908R1001	2/16
AS09-30-32-28	1SBL101001R2832	4/6	B7-30-01-03	GJL1311001R0013	3/4	BS2-3	1SAM401921R1001	2/17
AS12-30-01-16	1SBL111001R1601	4/4	B7-30-01-80	GJL1311001R8010	3/4	BSM6-30	GJL1201908R0001	3/17
AS12-30-01-20	1SBL111001R2001	4/4	B7-30-01-84	GJL1311001R8014	3/4	BX4	1SBN110108T1000	5/63
AS12-30-01-26	1SBL111001R2601	4/4	B7-30-01-85	GJL1311001R8015	3/4	BX4-CA	1SBN110109W1000	5/63
AS12-30-01-28	1SBL111001R2801	4/4	B7-30-10-01	GJL1311001R0101	3/4	CA3-01	1SBN011010T1001	4/9
AS12-30-10-16	1SBL111001R1610	4/4	B7-30-10-02	GJL1311001R0102	3/4	CA3-10	1SBN011010T1010	4/9
AS12-30-10-20	1SBL111001R2010	4/4	B7-30-10-03	GJL1311001R0103	3/4	CA4-01	1SBN011010R1001	5/33
AS12-30-10-26	1SBL111001R2610	4/4	B7-30-10-80	GJL1311001R8100	3/4	CA4-01-T	1SBN0110110T1001	5/33
AS12-30-10-28	1SBL111001R2810	4/4	B7-30-10-84	GJL1311001R8104	3/4	CA4-04E	1SBN0110140R1004	5/51
AS12-30-32-16	1SBL111001R1632	4/6	B7-30-10-85	GJL1311001R8105	3/4	CA4-04N	1SBN0110140R1204	5/63
AS12-30-32-20	1SBL111001R2032	4/6	B7-40-00-01	GJL1311201R0001	3/10	CA4-10	1SBN011010R1010	5/33
AS12-30-32-26	1SBL111001R2632	4/6	B7-40-00-02	GJL1311201R0002	3/10	CA4-10-T	1SBN0110110T1010	5/33
AS12-30-32-28	1SBL111001R2832	4/6	B7-40-00-03	GJL1311201R0003	3/10	CA4-13N	1SBN0110140R1213	5/63
AS16-30-01-16	1SBL121001R1601	4/4	B7-40-00-80	GJL1311201R8000	3/10	CA4-22E	1SBN0110140R1022	5/33
AS16-30-01-20	1SBL121001R2001	4/4	B7-40-00-84	GJL1311201R8004	3/10	CA4-22M	1SBN0110140R1122	5/33
AS16-30-01-26	1SBL121001R2601	4/4	B7D-30-01-01	GJL1317001R0011	3/5	CA4-22N	1SBN0110140R1222	5/63
AS16-30-01-28	1SBL121001R2801	4/4	B7D-30-01-05	GJL1317001R0015	3/5	CA4-22U	1SBN0110140R1322	5/33
AS16-30-10-16	1SBL121001R1610	4/4	B7D-30-10-01	GJL1317001R0101	3/5	CA4-31E	1SBN0110140R1031	5/51
AS16-30-10-20	1SBL121001R2010	4/4	B7D-30-10-05	GJL1317001R0105	3/5	CA4-31N	1SBN0110140R1231	5/63
AS16-30-10-26	1SBL121001R2610	4/4	B7D-40-00-01	GJL1317201R0001	3/11	CA4-40E	1SBN0110140R1040	5/51
AS16-30-10-28	1SBL121001R2810	4/4	B7D-40-00-05	GJL1317201R0005	3/11	CA4-40N	1SBN0110140R1240	5/63
AS16-30-32-16	1SBL121001R1632	4/6	B7S-30-01-1.7-71	GJL1313001R7011	3/8	CA6-11E	GJL1201317R0002	3/17
AS16-30-32-20	1SBL121001R2032	4/6	B7S-30-01-2.8-72	GJL1313001R7012	3/8	CA6-11K	GJL1201317R0001	3/18
AS16-30-32-26	1SBL121001R2632	4/6	B7S-30-10-1.7-71	GJL1313001R7101	3/8	CA6-11M	GJL1201317R0003	3/17
AS16-30-32-28	1SBL121001R2832	4/6	B7S-30-10-2.8-72	GJL1313001R7102	3/8	CA6-11N	GJL1201317R0004	3/17
ASL09-30-01-81	1SBL103001R8101	4/5	BC6-22-00-01	GJL1213501R0001	3/11	CAF6-02E	GJL1201330R0010	3/17
ASL09-30-01-83	1SBL103001R8301	4/5	BC6-22-00-02	GJL1213501R0002	3/11	CAF6-02K	GJL1201330R0009	3/17
ASL09-30-01-86	1SBL103001R8601	4/5	BC6-22-00-03	GJL1213501R0003	3/11	CAF6-02M	GJL1201330R0011	3/17
ASL09-30-01-88	1SBL103001R8801	4/5	BC6-22-00-04	GJL1213501R0004	3/11	CAF6-02N	GJL1201330R0012	3/17
ASL09-30-10-81	1SBL103001R8110	4/5	BC6-22-00-05	GJL1213501R0005	3/11	CAF6-11E	GJL1201330R0002	3/17
ASL09-30-10-83	1SBL103001R8310	4/5	BC6-22-00-07	GJL1213501R0007	3/11	CAF6-11K	GJL1201330R0001	3/18
ASL09-30-10-86	1SBL103001R8610	4/5	BC6-22-00-16	GJL1213501R1006	3/11	CAF6-11M	GJL1201330R0003	3/17
ASL09-30-10-88	1SBL103001R8810	4/5	BC6-30-01-01	GJL1213001R0011	3/5	CAF6-11N	GJL1201330R0004	3/17
ASL09-30-32-81	1SBL103001R8132	4/7	BC6-30-01-03	GJL1213001R0013	3/5	CAF6-20E	GJL1201330R0006	3/17
ASL09-30-32-83	1SBL103001R8332	4/7	BC6-30-01-04	GJL1213001R0014	3/5	CAF6-20K	GJL1201330R0005	3/18
ASL09-30-32-86	1SBL103001R8632	4/7	BC6-30-01-05	GJL1213001R0015	3/5	CAF6-20M	GJL1201330R0007	3/17
ASL09-30-32-88	1SBL103001R8832	4/7	BC6-30-01-07	GJL1213001R0017	3/5	CAF6-20N	GJL1201330R0008	3/17
ASL12-30-01-81	1SBL113001R8101	4/5	BC6-30-01-1.4-81	GJL1213001R8011	3/8	CAL18-11	1SFN010720R1011	5/43
ASL12-30-01-83	1SBL113001R8301	4/5	BC6-30-01-16	GJL1213001R1016	3/5	CAL18-11B	1SFN010720R3311	5/43
ASL12-30-01-86	1SBL113001R8601	4/5	BC6-30-01-2.4-51	GJL1213001R5011	3/8	CAL19-11	1SFN010820R1011	5/39
ASL12-30-01-88	1SBL113001R8801	4/5	BC6-30-10-01	GJL1213001R0101	3/5	CAL19-11B	1SFN010820R3311	5/39
ASL12-30-10-81	1SBL113001R8110	4/5	BC6-30-10-03	GJL1213001R0103	3/5	CAL4-11	1SBN0110120R1011	5/33
ASL12-30-10-83	1SBL113001R8310	4/5	BC6-30-10-04	GJL1213001R0104	3/5	CAL4-11-T	1SBN0110120T1011	5/33
ASL12-30-10-86	1SBL113001R8610	4/5	BC6-30-10-05	GJL1213001R0105	3/5	CAT4-11E	1SBN0110151R1011	5/33
ASL12-30-10-88	1SBL113001R8810	4/5	BC6-30-10-07	GJL1213001R0107	3/5	CAT4-11M	1SBN0110151R1111	5/33
ASL12-30-32-81	1SBL113001R8132	4/7	BC6-30-10-1.4-81	GJL1213001R8101	3/8	CAT4-11U	1SBN0110151R1311	5/33
ASL12-30-32-83	1SBL113001R8332	4/7	BC6-30-10-16	GJL1213001R1106	3/5	CC4-01	1SBN011011R1001	5/33
ASL12-30-32-86	1SBL113001R8632	4/7	BC6-30-10-2.4-51	GJL1213001R5101	3/8	CC4-10	1SBN011011R1010	5/33
ASL12-30-32-88	1SBL113001R8832	4/7	BC7-30-01-01	GJL1313001R0011	3/5	CK1-02	1SAM301901R1003	2/13
ASL16-30-01-81	1SBL123001R8101	4/5	BC7-30-01-03	GJL1313001R0013	3/5	CK1-11	1SAM301901R1001	2/13
ASL16-30-01-83	1SBL123001R8301	4/5	BC7-30-01-04	GJL1313001R0014	3/5	CK1-20	1SAM301901R1002	2/13
ASL16-30-01-86	1SBL123001R8601	4/5	BC7-30-01-05	GJL1313001R0015	3/5	CT-ERS-21S	1SVR730100R0300	5/22
ASL16-30-01-88	1SBL123001R8801	4/5	BC7-30-01-07	GJL1313001R0017	3/5	DB16	1SAZ701901R0001	6/4
ASL16-30-10-81	1SBL123001R8110	4/5	BC7-30-01-1.4-81	GJL1313001R8011	3/8	DB16E	1SAX101110R0001	6/10
ASL16-30-10-83	1SBL123001R8310	4/5	BC7-30-01-16	GJL1313001R1016	3/5	DB19EF	1SAX101910R1001	6/10
ASL16-30-10-86	1SBL1							

Index

Type classification

Type	Order code	Page
DB45EF	1SAX201910R0001	6/10
DB65	1SAZ801901R1001	6/6
DB96	1SAZ901901R1001	6/7
DMS132-G	1SAM201912R1010	2/18
DMS132-Y	1SAM201912R1011	2/18
DRAF09-11S	1SBK134237R1100	7/6
DRAF09-11U	1SBK134238R1100	7/6
DRAF09-13N	1SBK134137R1300	7/6
DRAF09-13U	1SBK134238R1300	7/6
DRAF09-14P	1SBK134037R1400	7/6
DRAF09-14U	1SBK134238R1400	7/6
DRAF12-11S	1SBK154237R1100	7/6
DRAF12-11U	1SBK154238R1100	7/6
DRAF12-13N	1SBK154137R1300	7/6
DRAF12-13U	1SBK154238R1300	7/6
DRAF12-14P	1SBK154037R1400	7/6
DRAF12-14U	1SBK154238R1400	7/6
DRAF16-11S	1SBK174237R1100	7/6
DRAF16-11U	1SBK174238R1100	7/6
DRAF16-13N	1SBK174137R1300	7/6
DRAF16-13U	1SBK174238R1300	7/6
DRAF16-14P	1SBK174037R1400	7/6
DRAF16-14U	1SBK174238R1400	7/6
DRAS09-20S	1SBK104235R2000	7/2
DRAS09-26N	1SBK104135R2600	7/2
DRAS09-27N	1SBK104135R2700	7/2
DRAS09-28P	1SBK104035R2800	7/2
DRAS09-29P	1SBK104035R2900	7/2
DRAS12-20S	1SBK114235R2000	7/2
DRAS12-26N	1SBK114135R2600	7/2
DRAS12-27N	1SBK114135R2700	7/2
DRAS12-28P	1SBK114035R2800	7/2
DRAS12-29P	1SBK114035R2900	7/2
DRAS16-20S	1SBK124235R2000	7/2
DRAS16-26N	1SBK124135R2600	7/2
DRAS16-27N	1SBK124135R2700	7/2
DRAS16-28P	1SBK124035R2800	7/2
DRAS16-29P	1SBK124035R2900	7/2
DRASL09-81S	1SBK104335R8100	7/2
DRASL09-83S	1SBK104335R8300	7/2
DRASL12-81S	1SBK114335R8100	7/2
DRASL12-83S	1SBK114335R8300	7/2
DRASL16-81S	1SBK124335R8100	7/2
DRASL16-83S	1SBK124335R8300	7/2
DX495	1SAM401912R1001	2/23
E1250DU-1250	1SFA739001R1000	6/14
E16DU-0.32	1SAX111001R1101	6/10
E16DU-1.0	1SAX111001R1102	6/10
E16DU-18.9	1SAX111001R1105	6/10
E16DU-2.7	1SAX111001R1103	6/10
E16DU-6.3	1SAX111001R1104	6/10
EF146-150	1SAX351001R1101	5/12
EF19-0.32	1SAX121001R1101	6/10
EF19-1.0	1SAX121001R1102	6/10
EF19-18.9	1SAX121001R1105	5/18
EF19-2.7	1SAX121001R1103	6/10
EF19-6.3	1SAX121001R1104	6/10
EF205-210	1SAX531001R1101	5/12
EF370-380	1SAX611001R1101	5/12
EF45-30	1SAX221001R1101	5/18
EF45-45	1SAX221001R1102	5/18
EF460-500	1SAX721001R1101	6/13
EF65-56	1SAX331001R1102	6/11
EF65-70	1SAX331001R1101	5/18
EF750-800	1SAX821001R1101	6/13
EF96-100	1SAX341001R1101	5/18
FR16AF-12	1SBN101337R1000	7/7
FR16AF-12U	1SBN101338R1000	7/7
FR16AS-12VARS	1SBN101035R1000	7/2
FS116	1SAM201909R1001	2/16
HK1-02	1SAM201902R1003	2/13
HK1-11	1SAM201902R1001	2/13
HK1-20	1SAM201902R1002	2/13
HK1-20L	1SAM201902R1004	2/13
HK4-11	1SAM401901R1001	2/23
HK4-W	1SAM401901R1002	2/23
HKF1-01	1SAM201901R1004	2/13
HKF1-10	1SAM201901R1003	2/13
HKF1-11	1SAM201901R1001	2/13
HKF1-20	1SAM201901R1002	2/13
HKS4-02	1SAM401902R1003	2/23
HKS4-11	1SAM401902R1001	2/23
HKS4-20	1SAM401902R1002	2/23
IB132-G	1SAM201911R1010	2/18
IB132-Y	1SAM201911R1011	2/18
K6-22Z-01	GJH1211001R0221	3/13
K6-22Z-02	GJH1211001R0222	3/13
K6-22Z-03	GJH1211001R0223	3/13
K6-22Z-80	GJH1211001R8220	3/13
K6-22Z-84	GJH1211001R8224	3/13
K6-22Z-85	GJH1211001R8225	3/13
K6-31Z-01	GJH1211001R0311	3/13
K6-31Z-02	GJH1211001R0312	3/13
K6-31Z-03	GJH1211001R0313	3/13
K6-31Z-84	GJH1211001R8314	3/13
K6-31Z-85	GJH1211001R8315	3/13
K6-40E-01	GJH1211001R0401	3/13
K6-40E-02	GJH1211001R0402	3/13
K6-40E-03	GJH1211001R0403	3/13
K6-40E-80	GJH1211001R8400	3/13
K6-40E-84	GJH1211001R8404	3/13
K6-40E-85	GJH1211001R8405	3/13
K6S-22Z-1.7-71	GJH1213001R7221	3/15
K6S-22Z-2.8-72	GJH1213001R7222	3/15
K6S-31Z-1.7-71	GJH1213001R7311	3/15
K6S-31Z-2.8-72	GJH1213001R7312	3/15
K6S-40E-1.7-71	GJH1213001R7401	3/15
K6S-40E-2.8-72	GJH1213001R7402	3/15
KA165	1SAM401922R1001	2/17
KA495	1SAM501901R1001	2/23
KA495C	1SAM501902R1001	2/23
KC6-22Z-01	GJH1213001R0221	3/14
KC6-22Z-03	GJH1213001R0223	3/14
KC6-22Z-04	GJH1213001R0224	3/14
KC6-22Z-05	GJH1213001R0225	3/14
KC6-22Z-07	GJH1213001R0227	3/14
KC6-22Z-16	GJH1213001R1226	3/14
KC6-31Z-01	GJH1213001R0311	3/14
KC6-31Z-03	GJH1213001R0313	3/14
KC6-31Z-04	GJH1213001R0314	3/14
KC6-31Z-05	GJH1213001R0315	3/14
KC6-31Z-07	GJH1213001R0317	3/14
KC6-31Z-1.4-81	GJH1213001R8311	3/15
KC6-31Z-1.6	GJH1213001R1316	3/14
KC6-31Z-2.4-51	GJH1213001R5311	3/15
KC6-40E-01	GJH1213001R0401	3/14
KC6-40E-03	GJH1213001R0403	3/14
KC6-40E-04	GJH1213001R0404	3/14
KC6-40E-05	GJH1213001R0405	3/14
KC6-40E-07	GJH1213001R0407	3/14
KC6-40E-1.4-81	GJH1213001R8401	3/15
KC6-40E-16	GJH1213001R1406	3/14
KC6-40E-2.4-51	GJH1213001R5401	3/15
KPR-101L	1SFA616162R1014	6/4
LDC4	1SBN070156T1000	5/63
LP6	GJL1201907R0001	3/17
LT140-30L	1SFN124203R1000	5/39
LT140-40L	1SFN124203R2000	5/55
LT200/A	1SAZ401901R1001	6/9
LT205-30C	1SFN124801R1000	5/39
LT205-30L	1SFN124803R1000	5/39
LT205-30Y	1SFN124804R1000	5/39
LT205-40C	1SFN124801R2000	5/55
LT205-40L	1SFN124803R2000	5/55
LT370-30C	1SFN125401R1000	5/39
LT370-30D	1SFN125406R1000	5/39
LT370-30L	1SFN125403R1000	5/39
LT370-30Y	1SFN125404R1000	5/39
LT370-40C	1SFN125401R2000	5/55
LT370-40L	1SFN125403R2000	5/55
LT460-AC	1SFN125701R1000	5/43
LT460-AL	1SFN125703R1000	5/43
LT6-B	GJL1201906R0001	3/17
LT750-AC	1SFN126101R1000	5/43
LT750-AL	1SFN126103R1000	5/43
LW1250	1SFN076407R1000	5/43
LW140	1SFN074207R1000	5/39
LW205	1SFN074807R1000	5/39
LW205-40	1SFN074807R2000	5/55
LW370	1SFN075407R1000	5/39
LW370-40	1SFN075407R2000	5/55
LW460	1SFN075707R1000	5/43
LW750	1SFN076107R1000	5/43
LX140	1SFN074210R1000	5/39
LX205	1SFN074810R1000	5/39
LX370	1SFN075410R1000	5/39
LX460	1SFN075710R1000	5/43
LX750	1SFN076110R1000	5/43
MO132-0.16	1SAM360000R1001	2/9
MO132-0.25	1SAM360000R1002	2/9
MO132-0.4	1SAM360000R1003	2/9
MO132-0.63	1SAM360000R1004	2/9
MO132-1.0	1SAM360000R1005	2/9
MO132-1.6	1SAM360000R1006	2/9
MO132-10	1SAM360000R1010	2/9
MO132-12	1SAM360000R1012	2/9
MO132-16	1SAM360000R1011	2/9
MO132-2.5	1SAM360000R1007	2/9
MO132-20	1SAM360000R1013	2/9
MO132-25	1SAM360000R1014	2/9
MO132-32	1SAM360000R1015	2/9
MO132-40	1SAM360000R1016	2/9
MO132-4.0	1SAM360000R1008	2/9
MO132-4.0T	1SAM360000R1009	2/9
MO132-6.3	1SAM360000R1012	2/9
MO132-6.3T	1SAM360000R1011	2/9
MO165-16	1SAM461000R1011	2/10
MO165-20	1SAM461000R1012	2/10

Type	Order code	Page
MO165-25	1SAM461000R1013	2/10
MO165-32	1SAM461000R1014	2/10
MO165-42	1SAM461000R1015	2/10
MO165-54	1SAM461000R1016	2/10
MO165-65	1SAM461000R1017	2/10
MO495-100	1SAM560000R1010	2/20
MO495-63	1SAM560000R1007	2/20
MO495-75	1SAM560000R1008	2/20
MO495-90	1SAM560000R1009	2/20
MO496-100	1SAM590000R1010	2/20
MO496-32	1SAM590000R1004	2/20
MO496-40	1SAM590000R1005	2/20
MO496-50	1SAM590000R1006	2/20
MO496-63	1SAM590000R1007	2/20
MO496-75	1SAM590000R1008	2/20
MO496-90	1SAM590000R1009	2/20
MS116-0.16	1SAM250000R1001	2/6
MS116-0.16-HKF1-11	1SAM250005R1001	2/6
MS116-0.25	1SAM250000R1002	2/6
MS116-0.25-HKF1-11	1SAM250005R1002	2/6
MS116-0.4	1SAM250000R1003	2/6
MS116-0.4-HKF1-11	1SAM250005R1003	2/6
MS116-0.63	1SAM250000R1004	2/6
MS116-0.63-HKF1-11	1SAM250005R1004	2/6
MS116-1.0	1SAM250000R1005	2/6
MS116-1.0-HKF1-11	1SAM250005R1005	2/6
MS116-1.6	1SAM250000R1006	2/6
MS116-1.6-HKF1-11	1SAM250005R1006	2/6
MS116-10	1SAM250000R1010	2/6
MS116-10.0-HKF1-11	1SAM250005R1010	2/6
MS116-12	1SAM250000R1012	2/6
MS116-12.0-HKF1-11	1SAM250005R1012	2/6
MS116-16	1SAM250000R1011	2/6
MS116-16.0-HKF1-11	1SAM250005R1011	2/6
MS116-2.5	1SAM250000R1007	2/6
MS116-2.5-HKF1-11	1SAM250005R1007	2/6
MS116-20	1SAM250000R1013	2/6
MS116-20-HKF1-11	1SAM250005R1013	2/6
MS116-25	1SAM250000R1014	2/6
MS116-25-HKF1-11	1SAM250005R1014	2/6
MS116-32	1SAM250000R1015	2/6
MS116-32-HKF1-11	1SAM250005R1015	2/6
MS116-4.0	1SAM250000R1008	2/6
MS116-4.0-HKF1-11	1SAM250005R1008	2/6
MS116-6.3	1SAM250000R1009	2/6
MS116-6.3-HKF1-11	1SAM250005R1009	2/6
MS132-0.16	1SAM350000R1001	2/7
MS132-0.16-HKF1-11	1SAM350005R1001	2/7
MS132-0.25	1SAM350000R1002	2/7
MS132-0.25-HKF1-11	1SAM350005R1002	2/7
MS132-0.25T	1SAM340000R1002	2/11
MS132-0.4	1SAM350000R1003	2/7
MS132-0.4-HKF1-11	1SAM350005R1003	2/7
MS132-0.4T	1SAM340000R1003	2/11
MS132-0.63	1SAM350000R1004	2/7
MS132-0.63-HKF1-11	1SAM350005R1004	2/7
MS132-0.63T	1SAM340000R1004	2/11
MS132-1.0	1SAM350000R1005	2/7
MS132-1.0-HKF1-11	1SAM350005R1005	2/7
MS132-1.0T	1SAM340000R1005	2/11
MS132-1.6	1SAM350000R1006	2/7
MS132-1.6-HKF1-11	1SAM350005R1006	2/7
MS132-1.6T	1SAM340000R1006	2/11
MS132-10	1SAM350000R1010	2/7
MS132-10.0-HKF1-11	1SAM350005R1010	2/7
MS132-10T	1SAM340000R1010	2/11
MS132-12	1SAM350000R1012	2/7
MS132-12.0-HKF1-11	1SAM350005R1012	2/7
MS132-12T	1SAM340000R1012	2/11
MS132-16	1SAM350000R1011	2/7
MS132-16.0-HKF1-11	1SAM350005R1011	2/7
MS132-16T	1SAM340000R1011	2/11
MS132-2.5	1SAM350000R1007	2/7
MS132-2.5-HKF1-11	1SAM350005R1007	2/7
MS132-2.5T	1SAM340000R1007	2/11
MS132-20	1SAM350000R1013	2/7
MS132-20-HKF1-11	1SAM350005R1013	2/7
MS132-20T	1SAM340000R1013	2/11
MS132-25	1SAM350000R1014	2/7
MS132-25-HKF1-11	1SAM350005R1014	2/7
MS132-25T	1SAM	

Type classification

Type	Order code	Page	Type	Order code	Page	Type	Order code	Page
MS165-32	1SAM451000R1014	2/8	NSL44E-86	1SBH103001R8644	4/11	T16-3.1	1SAZ711201R1033	6/4
MS165-42	1SAM451000R1015	2/8	NSL44E-88	1SBH103001R8844	4/11	T16-4.2	1SAZ711201R1035	6/4
MS165-54	1SAM451000R1016	2/8	NSL53E-81	1SBH103001R8153	4/11	T16-5.7	1SAZ711201R1038	6/4
MS165-65	1SAM451000R1017	2/8	NSL53E-83	1SBH103001R8353	4/11	T16-7.6	1SAZ711201R1040	6/4
MS495-100	1SAM550000R1010	2/19	NSL53E-86	1SBH103001R8653	4/11	TA200DU-110	1SAZ421201R1002	6/9
MS495-63	1SAM550000R1007	2/19	NSL53E-88	1SBH103001R8853	4/11	TA200DU-135	1SAZ421201R1003	6/9
MS495-75	1SAM550000R1008	2/19	NSL62E-81	1SBH103001R8162	4/11	TA200DU-150	1SAZ421201R1004	6/9
MS495-90	1SAM550000R1009	2/19	NSL62E-83	1SBH103001R8362	4/11	TA200DU-175	1SAZ421201R1005	5/12
MS497-100	1SAM580000R1010	2/19	NSL62E-86	1SBH103001R8662	4/11	TA200DU-200	1SAZ421201R1006	5/12
MS497-32	1SAM580000R1004	2/19	NSL62E-88	1SBH103001R8862	4/11	TA200DU-90	1SAZ421201R1001	6/9
MS497-40	1SAM580000R1005	2/19	NSL71E-81	1SBH103001R8171	4/11	TBC7-22-00-55	GJL1313561R5005	3/12
MS497-50	1SAM580000R1006	2/19	NSL71E-83	1SBH103001R8371	4/11	TBC7-22-00-62	GJL1313561R6002	3/12
MS497-63	1SAM580000R1007	2/19	NSL71E-86	1SBH103001R8671	4/11	TBC7-22-00-68	GJL1313561R6008	3/12
MS497-75	1SAM580000R1008	2/19	NSL71E-88	1SBH103001R8871	4/11	TBC7-30-01-51	GJL1313061R5011	3/9
MS497-90	1SAM580000R1009	2/19	NSL80E-81	1SBH103001R8180	4/11	TBC7-30-01-55	GJL1313061R5015	3/9
MSAH1	1SAM201909R1021	2/24	NSL80E-83	1SBH103001R8380	4/11	TBC7-30-01-62	GJL1313061R6012	3/9
MSH-AR	1SAM201920R1000	2/24	NSL80E-86	1SBH103001R8680	4/11	TBC7-30-01-68	GJL1313061R6018	3/9
MSHD-LB	1SAM201920R1001	2/24	NSL80E-88	1SBH103001R8880	4/11	TBC7-30-10-51	GJL1313061R5101	3/9
MSHD-LTB	1SAM201920R1011	2/24	OX56X105	1SCA108043R1001	2/24	TBC7-30-10-55	GJL1313061R5105	3/9
MSHD-LTY	1SAM201920R1012	2/24	OX56X130	1SCA101655R1001	2/24	TBC7-30-10-62	GJL1313061R6102	3/9
MSHD-LY	1SAM201920R1002	2/24	OX56X180	1SCA101659R1001	2/24	TBC7-30-10-68	GJL1313061R6108	3/9
MSMN	1SAM101923R0002	2/24	OX56X85	1SCA101647R1001	2/24	TBC7-31-00-55	GJL1313461R5005	3/12
MSMNO	1SAM101923R0012	2/24	PB1-1-32	1SAM201914R1001	2/16	TBC7-31-00-62	GJL1313461R6002	3/12
NF22E-12	1SBH137001R1222	5/60	PS1-2-0-65	1SAM201906R1102	2/16	TBC7-31-00-68	GJL1313461R6008	3/12
NF22E-13	1SBH137001R1322	5/60	PS1-2-1-65	1SAM201906R1112	2/16	TEF3-OFF	1SBN020104R1000	4/9
NF22E-14	1SBH137001R1422	5/60	PS1-2-2-65	1SAM201906R1122	2/16	TEF3-ON	1SBN020102R1000	4/9
NF22E-41	1SBH137001R4122	5/60	PS1-3-0-100	1SAM201916R1103	2/16	TEF4-OFF	1SBN020114R1000	5/33
NF31E-12	1SBH137001R1231	5/60	PS1-3-0-65	1SAM201906R1103	2/16	TEF4-ON	1SBN020112R1000	5/33
NF31E-13	1SBH137001R1331	5/60	PS1-3-1-100	1SAM201916R1113	2/16	TF140DU-110	1SAZ431201R1002	5/12
NF31E-14	1SBH137001R1431	5/60	PS1-3-1-65	1SAM201906R1113	2/16	TF140DU-110-V1000*	1SAZ431301R1002	6/8
NF31E-41	1SBH137001R4131	5/60	PS1-3-2-100	1SAM201916R1123	2/16	TF140DU-135	1SAZ431201R1003	5/16
NF40E-12	1SBH137001R1240	5/60	PS1-3-2-65	1SAM201906R1123	2/16	TF140DU-135-V1000*	1SAZ431301R1003	6/8
NF40E-13	1SBH137001R1340	5/60	PS1-4-0-100	1SAM201916R1104	2/16	TF140DU-142	1SAZ431201R1004	5/12
NF40E-14	1SBH137001R1440	5/60	PS1-4-0-65	1SAM201906R1104	2/16	TF140DU-142-V1000*	1SAZ431301R1004	6/8
NF40E-41	1SBH137001R4140	5/60	PS1-4-1-100	1SAM201916R1114	2/16	TF140DU-90	1SAZ431201R1001	6/8
NFZ22E-20	1SBH136001R2022	5/61	PS1-4-1-65	1SAM201906R1114	2/16	TF140DU-90-V1000*	1SAZ431301R1001	6/8
NFZ22E-21	1SBH136001R2122	5/61	PS1-4-2-65	1SAM201906R1124	2/16	TF42-0.13	1SAZ721201R1005	6/5
NFZ22E-22	1SBH136001R2222	5/61	PS1-5-0-100	1SAM201916R1105	2/16	TF42-0.17	1SAZ721201R1008	6/5
NFZ22E-23	1SBH136001R2322	5/61	PS1-5-0-65	1SAM201906R1105	2/16	TF42-0.23	1SAZ721201R1009	6/5
NFZ31E-20	1SBH136001R2031	5/61	PS1-5-1-100	1SAM201916R1115	2/16	TF42-0.31	1SAZ721201R1013	6/5
NFZ31E-21	1SBH136001R2131	5/61	PS1-5-1-65	1SAM201906R1115	2/16	TF42-0.41	1SAZ721201R1014	6/5
NFZ31E-22	1SBH136001R2231	5/61	PS1-5-2-65	1SAM201906R1125	2/16	TF42-0.55	1SAZ721201R1017	6/5
NFZ31E-23	1SBH136001R2331	5/61	PS2-2-0-125	1SAM401920R1002	2/17	TF42-0.74	1SAZ721201R1021	6/5
NFZ40E-20	1SBH136001R2040	5/61	PS2-2-2-125	1SAM401920R1022	2/17	TF42-1.0	1SAZ721201R1023	6/5
NFZ40E-21	1SBH136001R2140	5/61	PS2-3-0-125	1SAM401920R1003	2/17	TF42-1.3	1SAZ721201R1025	6/5
NFZ40E-22	1SBH136001R2240	5/61	PS2-3-2-125	1SAM401920R1023	2/17	TF42-1.7	1SAZ721201R1028	6/5
NFZ40E-23	1SBH136001R2340	5/61	PS2-4-0-125	1SAM401920R1004	2/17	TF42-1.0	1SAZ721201R1043	5/16
NS22E-16	1SBH101001R1622	4/10	PS2-4-2-125	1SAM401920R1024	2/17	TF42-13	1SAZ721201R1045	5/16
NS22E-20	1SBH101001R2022	4/10	RC5-1/133	1SBN050100R1001	4/9	TF42-16	1SAZ721201R1047	5/16
NS22E-26	1SBH101001R2622	4/10	RC5-1/250	1SBN050100R1002	4/9	TF42-2.3	1SAZ721201R1031	6/5
NS22E-28	1SBH101001R2822	4/10	RC5-1/440	1SBN050100R1003	4/9	TF42-20	1SAZ721201R1049	5/22
NS31E-16	1SBH101001R1631	4/10	RC5-1/500	1SBN050100R1000	4/9	TF42-24	1SAZ721201R1051	5/16
NS31E-20	1SBH101001R2031	4/10	RT5/150	1SBN050020R1003	4/9	TF42-29	1SAZ721201R1052	5/22
NS31E-26	1SBH101001R2631	4/10	RT5/264	1SBN050020R1004	4/9	TF42-3.1	1SAZ721201R1033	6/5
NS31E-28	1SBH101001R2831	4/10	RT5/32	1SBN050020R1000	4/9	TF42-35	1SAZ721201R1053	5/16
NS40E-16	1SBH101001R1640	4/10	RT5/65	1SBN050020R1001	4/9	TF42-38	1SAZ721201R1055	5/16
NS40E-20	1SBH101001R2040	4/10	RT5/90	1SBN050020R1002	4/9	TF42-4.2	1SAZ721201R1035	6/5
NS40E-26	1SBH101001R2640	4/10	RV5/133	1SBN050010R1001	4/9	TF42-5.7	1SAZ721201R1038	6/5
NS40E-28	1SBH101001R2840	4/10	RV5/250	1SBN050010R1002	4/9	TF42-7.6	1SAZ721201R1040	6/5
NS44E-16	1SBH101001R1644	4/10	RV5/440	1SBN050010R1003	4/9	TF65-28	1SAZ811201R1001	6/6
NS44E-20	1SBH101001R2044	4/10	RV5/500	1SBN050010R1000	4/9	TF65-33	1SAZ811201R1002	6/6
NS44E-26	1SBH101001R2644	4/10	RV-BC6/250	GJH2501903R0002	3/17	TF65-40	1SAZ811201R1003	5/16
NS44E-28	1SBH101001R2844	4/10	RV-BC6/380	GJH2501904R0002	3/17	TF65-47	1SAZ811201R1004	5/16
NS53E-16	1SBH101001R1653	4/10	RV-BC6/60	GJH2501902R0002	3/17	TF65-53	1SAZ811201R1005	6/6
NS53E-20	1SBH101001R2053	4/10	RV-BC6-F/250	GJH2501903R0003	3/17	TF65-60	1SAZ811201R1006	5/16
NS53E-26	1SBH101001R2653	4/10	RV-BC6-F/380	GJH2501904R0003	3/17	TF65-67	1SAZ811201R1007	6/6
NS53E-28	1SBH101001R2853	4/10	RV-BC6-F/60	GJH2501902R0003	3/17	TF96-51	1SAZ911201R1001	6/7
NS62E-16	1SBH101001R1662	4/10	S1-M1-25	1SAM201907R1101	2/16	TF96-60	1SAZ911201R1002	6/7
NS62E-20	1SBH101001R2062	4/10	S1-M2-25	1SAM201907R1102	2/16	TF96-68	1SAZ911201R1003	5/16
NS62E-26	1SBH101001R2662	4/10	S1-M3-25	1SAM201907R1103	2/16	TF96-78	1SAZ911201R1004	5/22
NS62E-28	1SBH101001R2862	4/10	S1-M3-35	1SAM201913R1103	2/16	TF96-87	1SAZ911201R1005	5/16
NS71E-16	1SBH101001R1671	4/10	S1-PB1-25	1SAM201914R1002	2/16	TF96-96	1SAZ911201R1006	5/22
NS71E-20	1SBH101001R2071	4/10	SA1	GJF1101903R0001	2/16	TKC6-222-51	GJH1213061R5221	3/16
NS71E-26	1SBH101001R2671	4/10	SA2	GJF1101903R0002	2/16	TKC6-222-55	GJH1213061R5225	3/16
NS71E-28	1SBH101001R2871	4/10	SA3	GJF1101903R0003	2/16	TKC6-222-62	GJH1213061R6222	3/16
NS80E-16	1SBH101001R1680	4/10	SK1-02	1SAM201903R1003	2/13	TKC6-222-68	GJH1213061R6228	3/16
NS80E-20	1SBH101001R2080	4/10	SK1-11	1SAM201903R1001	2/13	TKC6-31Z-51	GJH1213061R5311	3/16
NS80E-26	1SBH101001R2680	4/10	SK1-20	1SAM201903R1002	2/13	TKC6-31Z-55	GJH1213061R5315	3/16
NS80E-28	1SBH101001R2880	4/10	SK4-11	1SAM401904R1001	2/23	TKC6-31Z-62	GJH1213061R6312	3/16
NSL22E-81	1SBH103001R8122	4/11	T16-0.13	1SAZ711201R1005	6/4	TKC6-31Z-68	GJH1213061R6318	3/16
NSL22E-83	1SBH103001R8322	4/11	T16-0.17	1SAZ711201R1008	6/4	TKC6-40E-51	GJH1213061R5401	3/16
NSL22E-86	1SBH103001R8622	4/11	T16-0.23	1SAZ711201R1009	6/4	TKC6-40E-55	GJH1213061R5405	3/16
NSL22E-88	1SBH103001R8822	4/11	T16-0.31	1SAZ711201R1013	6/4	TKC6-40E-62	GJH1213061R6402	3/16
NSL31E-81	1SBH103001R8131	4/11	T16-0.41	1SAZ711201R1014	6/4	TKC6-40E-68	GJH1213061R6408	3/16
NSL31E-83	1SBH103001R8331	4/11	T16-0.55	1SAZ711201R1017	6/4	CB5-10	1SBN010013R1010	7/7
NSL31E-86	1SBH103001R8631	4/11	T16-0.74	1SAZ711201R1021	6/4	MCB-10B	1SFA611610R2001	7/2
NSL31E-88	1SBH103001R8831	4/11	T16-1.0	1SAZ711201R1023	6/4	UA1-110	1SAM201904R1004	2/14
NSL40E-81	1SBH103001R8140	4/11	T16-1.3	1SAZ711201R1025	6/4	UA1-20	1SAM201904R1010	2/14
NSL40E-83	1SBH103001R8340	4/11	T16-1.7	1SAZ711201R1028	6/4	UA1-208	1SAM201904R1008	2/14
NSL40E-86	1SBH103001R8640	4/11	T16-10	1SAZ711201R1043	6/4	UA1-230	1SAM201904R1005	2/14
NSL40E-88	1SBH103001R8840	4/11	T16-13	1SAZ711201R1045	6/4	UA1-24	1SAM201904R1001	2/14
NSL44E-81	1SBH103001R8144	4/11	T16-16	1SAZ711201R1047	6/4	UA1-400	1SAM201904R1006	2/14
NSL44E-83	1SBH103001R8344	4/11	T16-2.3	1SAZ711201R1031	6/4	UA1-415	1SAM201904R1007	2/14

Index

Type classification

Type	Order code	Page
UA1-48	1SAM201904R1002	2/14
UA1-575	1SAM201904R1009	2/14
UA1-60	1SAM201904R1003	2/14
UA4-110	1SAM401905R1001	2/23
UA4-230	1SAM401905R1002	2/23
UA4-24	1SAM401905R1004	2/23
UA4-400	1SAM401905R1003	2/23
UA4-HK-230	1SAM401906R1001	2/23
UA4-HK-400	1SAM401906R1002	2/23
VB6-30-01-01	GJL1211901R0011	3/6
VB6-30-01-02	GJL1211901R0012	3/6
VB6-30-01-03	GJL1211901R0013	3/6
VB6-30-01-80	GJL1211901R8010	3/6
VB6-30-01-84	GJL1211901R8014	3/6
VB6-30-01-85	GJL1211901R8015	3/6
VB6-30-10-01	GJL1211901R0101	3/6
VB6-30-10-02	GJL1211901R0102	3/6
VB6-30-10-03	GJL1211901R0103	3/6
VB6-30-10-80	GJL1211901R8100	3/6
VB6-30-10-84	GJL1211901R8104	3/6
VB6-30-10-85	GJL1211901R8105	3/6
VB7-30-01-01	GJL1311901R0011	3/6
VB7-30-01-02	GJL1311901R0012	3/6
VB7-30-01-03	GJL1311901R0013	3/6
VB7-30-01-80	GJL1311901R8010	3/6
VB7-30-01-84	GJL1311901R8014	3/6
VB7-30-01-85	GJL1311901R8015	3/6
VB7-30-10-01	GJL1311901R0101	3/6
VB7-30-10-02	GJL1311901R0102	3/6
VB7-30-10-03	GJL1311901R0103	3/6
VB7-30-10-80	GJL1311901R8100	3/6
VB7-30-10-84	GJL1311901R8104	3/6
VB7-30-10-85	GJL1311901R8105	3/6
VBC6-30-01-01	GJL1213901R0011	3/7
VBC6-30-01-03	GJL1213901R0013	3/7
VBC6-30-01-04	GJL1213901R0014	3/7
VBC6-30-01-05	GJL1213901R0015	3/7
VBC6-30-01-07	GJL1213901R0017	3/7
VBC6-30-01-16	GJL1213901R1016	3/7
VBC6-30-10-01	GJL1213901R0101	3/7
VBC6-30-10-03	GJL1213901R0103	3/7
VBC6-30-10-04	GJL1213901R0104	3/7
VBC6-30-10-05	GJL1213901R0105	3/7
VBC6-30-10-07	GJL1213901R0107	3/7
VBC6-30-10-16	GJL1213901R1106	3/7
VBC7-30-01-01	GJL1313901R0011	3/7
VBC7-30-01-03	GJL1313901R0013	3/7
VBC7-30-01-04	GJL1313901R0014	3/7
VBC7-30-01-05	GJL1313901R0015	3/7
VBC7-30-01-07	GJL1313901R0017	3/7
VBC7-30-01-16	GJL1313901R1016	3/7
VBC7-30-10-01	GJL1313901R0101	3/7
VBC7-30-10-03	GJL1313901R0103	3/7
VBC7-30-10-04	GJL1313901R0104	3/7
VBC7-30-10-05	GJL1313901R0105	3/7
VBC7-30-10-07	GJL1313901R0107	3/7
VBC7-30-10-16	GJL1313901R1106	3/7
VEM4	1SBN030111R1000	5/33
VM140/190	1SFN034403R1000	5/39
VM1650H	1SFN036503R1000	5/43
VM19	1SFN030300R1000	5/39
VM205/265	1SFN035203R1000	5/39
VM3	1SBN031005T1000	4/9
VM4	1SBN030105T1000	5/33
VM750H	1SFN035700R1000	5/43
VM96-4	1SBN033405T1000	5/33
WRB-1000	1SAZ701903R1013	6/15
WRB-400	1SAZ701903R1011	6/15
WRB-600	1SAZ701903R1012	6/15
WRBG	1SAZ701903R1030	6/15
WRH-F	1SAZ701903R1001	6/15

Marketing material

<http://new.abb.com/low-voltage/products/motor-protection>

HOME • PRODUCTS • LOW VOLTAGE PRODUCTS • MOTOR PROTECTION AND CONTROL

GLOBAL SITE Power and productivity for a better world™ **ABB**

Motor protection and control



To keep it running, you need Control

ABB's motor protection and control offering is among the widest on the market. From system integrator, OEM, engineering consultant and distributor to panel builder and industrial end-user, our comprehensive range of motor starting solutions, products and services delivers the certainty of consistent quality and performance.





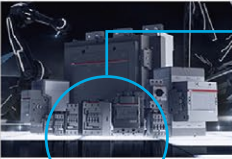







Are you looking for support or purchase information?
↓ [Contact us](#)

Highlights

-  [AF contactor launch](#)
-  [Gamesa chooses AF](#)
-  [ADL and Free Tech cuts logistic costs](#)

Our offering

-  Starting solutions
Get the perfect match
→ [Link](#)
-  Motor protection
A complete motor protection concept
→ [Link](#)
-  3-pole contactors and overload relays
For motor starting and power switching
→ [Link](#)
-  4-pole contactors
For power switching
→ [Link](#)
-  R bar contactors for advanced and heavy duty applications
Tailored to your needs
→ [Link](#)
-  Contactor relays
For switching control and auxiliary circuits
→ [Link](#)
-  Contactors for capacitor switching
Withstand unlimited peak current
→ [Link](#)
-  Contactors for DC switching
For a compact and efficient way of DC switching
→ [Link](#)
-  Contactors for railway applications
Meeting the most stringent standards and requirements
→ [Link](#)
-  Installation contactors
Noiseless control
→ [Link](#)

Products and documents

[Documents](#) [Tools](#)

Download related documents for Contactors

You now see 5 documents within → [Advanced search](#) → [Documents in all languages](#)

Category	Document Title	Language	Date	Size	Download
Popular documents (5)	ESB Installation contactors - Technical catalogue	English	2010-02-08	0,66 MB	PDF
Brochure (10)	ePLAN Electric P8 product data - Mini Contactors, Mini Contactor Relays, Mini Reversing Contactors and Accessories	English, German	2011-06-17	0,08 MB	ZIP
CAD outline drawing (1)	Block contactors	English	2005-01-27	5,80 MB	PDF
Catalogue (30)	Main catalog Motor protection and control	English	2013-06-04	94,02 MB	PDF
Certificate (500)	Modular DIN rail components - Installation contactors	English	2014-03-27	0,75 MB	PDF
Circuit diagram (12)					
Course description (1)					

News

- 2014-11-20: No job too dirty for ABB products
- 2014-11-06: Prost! ABB keeps Oktoberfest beer flowing
- 2014-09-26: ABB's Business Unit Control Products attends first Automation & Power World in Mexico
- 2014-07-24: Product of the year - ABB's AF contactor
- 2014-07-09: New ABB AF range contactors reduce SKUs by 90 percent
- 2014-06-19: ABB inaugurates new factory in Bulgaria

Videos, prints, technical presentations and more



Videos



Success stories

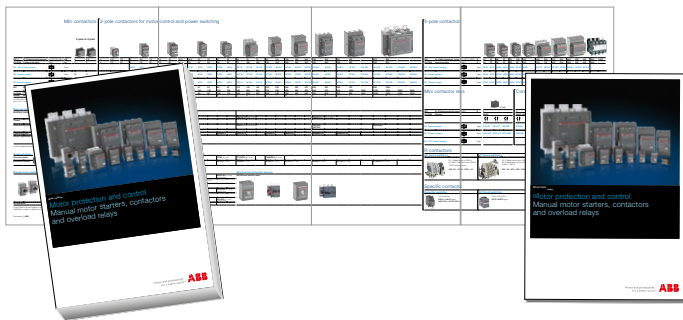

Main catalog : 1SBC100192C0203
 Short form catalog : 1SBC100195C0202
 Panorama : 1SBC100191L0203

For direct product details information,
 use product type or order code, ex:
www.abb.com/productdetails/AF09-30-10-13 or
www.abb.com/productdetails/1SBL137001R1310

Block Contactors

Overview Data Contacts

AF09-30-10-13

General information

Extended Product Type: AF09-30-10-13
 Product ID: 1SBL137001R1310
 EAN: 3471223110038
 Catalog Description: AF09-30-10-13 100-250V/50/60Hz DC Contactor

Long Description:
 AF09 contactors are used for controlling power circuits up to 690 V AC and 220 V DC. They are mainly used for controlling 3-phase motors, non-inductive or slightly inductive loads. AF⁺ contactors include an electronic coil interface accepting a wide control voltage DC min. - DC max. Only four coils cover control voltages between 24 - 500 V (500V/10 or 25 - 500 V DC). AF⁺ contactors can manage large control voltage variations. One coil can be used for different control voltages used worldwide without any coil change. AF⁺ contactors have built-in surge protection and do not require additional surge suppressors. The AF⁺ series is back 3.



[Print View](#)
[Print to Pdf](#)
[Downloads](#)

Userfriendly web design



Tools

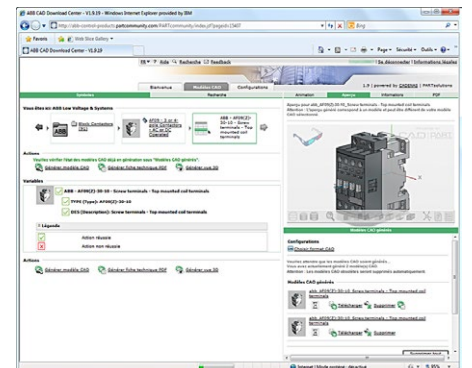

Cadenas portal: Download 2D or 3D files according to your needs (STEP, IGES...)

Coordination tables for motor protection

Selected Optimized Coordination

63 records (0-24 selected) Show record ABB products only Number of Records to show: 20

The oldest tables matching your search are shown (Current and Voltage Smart Search is on)

Coordination	Protection Device	Rated Voltage	Short-Circuit Current (kA)	Starter Type	Coordination Type	Overload Relay	Motor Name Power (kW/HP)
ABB	ABB	400V AC	5	DOL/NO	IEC Type 1	Embedded	0.06
ABB	ABB	400V AC	5	DOL/NO	IEC Type 2	TOC	0.06
ABB	ABB	400V AC	10	DOL/NO	UL Type A	EDL	0.09
ABB	ABB	400V AC	12	SB-NO/UL	UL Type C	AWC	0.10
ABB	ABB	400V AC	16	SB-NO/UL	UL Type D		0.15
ABB	ABB	400V AC	20	UL	UL Type E		0.20
ABB	ABB	400V AC	25	UL	UL Type F		0.27
ABB	ABB	400V AC	27				0.30
ABB	ABB	400V AC	30				0.36

MPS, 400 Vac, 10 kA, DOL/NO, Coordination Type IEC Type 1, Overload/Relay, Embedded

Motor Power (kW)	Rated Current (A)	Short-Circuit Current (kA)	Starter Type	Coordination Type	Overload Relay	Max. allowed load current (A)	Table
0.06	0.20	10-15-25	AD			0.25	11
0.09	0.25	10-15-25	AD			0.30	11
0.10	0.25	10-15-25	AD			0.30	11
0.15	0.30	10-15-25	AD			0.35	11
0.20	0.35	10-15-25	AD			0.40	11
0.27	0.40	10-15-25	AD			0.45	11
0.30	0.40	10-15-25	AD			0.45	11

SOC II: Select the Optimized Coordination tables for your starter according to IEC or UL standard

Notes

A series of horizontal dotted lines for writing notes.

Contact us

ABB France
Low Voltage Products Division
3, rue Jean Perrin
F-69687 Chassieu cedex / France

ABB STOTZ-KONTAKT GmbH
Eppelheimer Straße 82
D-69123 Heidelberg / Germany

ABB AB
Control Products
Low Voltage Products
SE-721 61 Västerås / Sweden

You can find the address of your local sales organisation
on the [ABB home page](#)



<http://new.abb.com/low-voltage/products/motor-protection>



<http://www.abb.com/lowvoltage>

Note

We reserve the right to make technical changes or modify the contents of this document without prior notice.

ABB does not accept any responsibility whatsoever for potential errors or possible lack of information in this document.

We reserve all rights in this document and in the subject matter and illustrations contained therein. Any reproduction, disclosure to third parties or utilization of its contents – in whole or in parts – is forbidden without prior written consent of ABB.

Copyright© 2015 ABB - All rights reserved

X-ON Electronics

Largest Supplier of Electrical and Electronic Components

Click to view similar products for [Contactor Accessories](#) category:

Click to view products by [ABB](#) manufacturer:

Other Similar products are found below :

[3RT1945-5AP61](#) [SZ-N2SJ](#) [YC9Z-CI6](#) [YC9Z-CNA211M](#) [1SAX351001R1101](#) [1SBN050100R1002](#) [1SBN050020R1003](#) [1SAX121001R1103](#)
[022.63](#) [022.18.1](#) [022.26](#) [1SBN050020R1000](#) [1SBN050200R1002](#) [1SBN081313R2000](#) [LA5FF431](#) [CAL5-11](#) [DB25/25A](#) [DB42](#)
[1SBN082306T1000](#) [CA5-22M](#) [DB80](#) [EHTK210](#) [LDC4](#) [MS325-SM1](#) [13222574](#) [SW182B-1](#) [SW190B-24DC-CW4](#) [DILM12-XSPR240](#)
[022.65](#) [SZ-A11](#) [SZ-CD1](#) [YC9Z-CNA111SR](#) [YC9Z-CUA422](#) [LA4DFB](#) [LA4FDE](#) [LA4KC1B](#) [LAD4TGD](#) [LAD90](#) [LAD96560](#) [LAD9SD3S](#)
[DPEAN11](#) [LA4SKC1U](#) [LAD9R1](#) [LAD9R1V](#) [3RH29111GA22](#) [3RT1924-5AC21](#) [3RT1944-5AP61](#) [3TY6483-0AK6](#) [CA7-PA-01](#) [CA7-PA-](#)
[10](#)