



Application Guide

Contactors for capacitor switching

Power and productivity
for a better world™







Contactors for Capacitor Switching

Contents

General

Reminder of Capacitor Transient Conditions	2
Steady State Condition Data	2
Consequences for the Contactors	2

ABB Solutions for Capacitor Bank Switching

The UA..RA Contactors, equipped with Damping Resistors	3
The UA... Contactors	3
The A... and AF... Standard Contactors	3

UA..RA Contactors, equipped with Damping Resistors

Application	4
Description	4
Selection Table	4
Ordering Details	5
Technical Data	6
Main Accessories	7
Terminal Marking and Positioning	8
Dimensions	9

UA... Contactors

Application	12
Selection Table	12
Ordering Details	13
Technical Data	14
Main Accessories	15
Terminal Marking and Positioning	16
Dimensions	17

A... and AF... Standard Contactors

Application	18
Selection Table	18
Ordering Details	19
Main Accessories	20

Selection Examples

Application and possibilities	22
-------------------------------------	----

Calculation and Dimensioning

Inrush current peak and frequency	23
Anti resonance Inductances	31
Installation studies	32

Contactors for Capacitor Switching

AC-6b Utilization Category according to IEC 60947-4-1

Capacitor Transient Conditions

In Low Voltage industrial installations, capacitors are mainly used for reactive energy correction (raising the power factor). When these capacitors are energized, overcurrents of high amplitude and high frequencies (3 to 15 kHz) occur during the transient period (1 to 2 ms).

The amplitude of these current peaks, also known as "inrush current peaks", depends on the following factors:

- The network inductances.
- The transformer power and short-circuit voltage.
- The type of power factor correction.

There are 2 types of power factor correction: fixed or automatic.

Fixed power factor correction consists of inserting, in parallel on the network, a capacitor bank whose total power is provided by the assembly of capacitors of identical or different ratings.

The bank is energized by a contactor that simultaneously supplies all the capacitors (a single step).

The inrush current peak, in the case of fixed correction, can reach 30 times the nominal current of the capacitor bank.



Single-step capacitor bank scheme
Use the A/AF... contactor ranges.

An automatic power factor correction system, on the other hand, consists of several capacitor banks of identical or different ratings (several steps), energized separately according to the value of the power factor to be corrected.

An electronic device automatically determines the power of the steps to be energized and activates the relevant contactors.

The inrush current peak, in the case of automatic correction, depends on the power of the steps already on duty, and can reach 100 times the nominal current of the step to be energized.

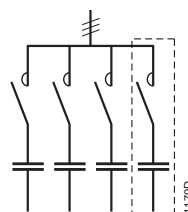

Multi-step capacitor bank scheme
Use the UA... or UA..RA contactor ranges.

Steady State Condition Data

The presence of harmonics and the network's voltage tolerance lead to a current, estimated to be 1.3 times the nominal current I_n of the capacitor, permanently circulating in the circuit.

Taking into account the manufacturing tolerances, the exact power of a capacitor can reach 1.15 times its nominal power.

Standard IEC 60831-1 Edition 2002 specifies that the capacitor must therefore have a maximum thermal current I_T of:

$$I_T = 1.3 \times 1.15 \times I_n = 1.5 \times I_n$$

Consequences for the Contactors

To avoid malfunctions (welding of main poles, abnormal temperature rise, etc.), contactors for capacitor bank switching must be sized to withstand:

- A permanent current that can reach 1.5 times the nominal current of the capacitor bank.
- The short but high peak current on pole closing (maximum permissible peak current \hat{I}).

Contactor Selection Tool for Capacitor Switching

In a given application, if the user does not know the value of the inrush current peak, this value can be approximately calculated using the formulas given on the pages "Calculation and dimensioning".

Alternatively by the **CAPCAL Selection Tool**, available on the ABB Website:

www.abb.com/lowvoltage

right menu: "Support"

search: "Online Product Selection Tools"

select: "Contactors: AC-6b Capacitor Switching"

This program allows the calculation of these peaks and gives the references of the ABB contactors according to the installation specifications. This calculation is valid for one or several capacitor banks.



Contactors for Capacitor Switching

The ABB Solutions

ABB offers 3 contactor versions according to the value of the inrush current peak and the power of the capacitor bank.

UA..RA Contactors for Capacitor Switching (UA 16..RA to UA 110..RA) with insertion of damping resistors.

The insertion of damping resistors protects the contactor and the capacitor from the highest inrush currents.

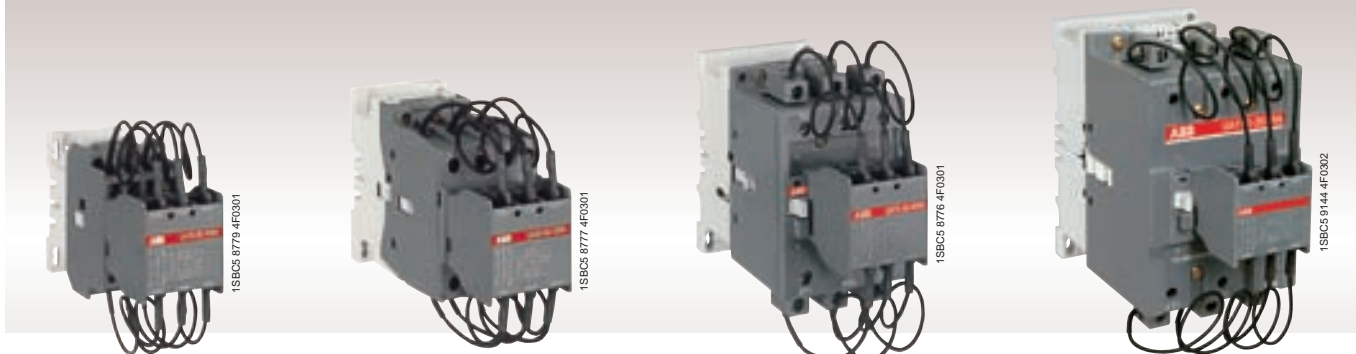

UA... Contactors for Capacitor Switching (UA 16 to UA 110)

Maximum permissible peak current $\hat{I} \leq 100$ times the nominal rms current of the switched capacitor.

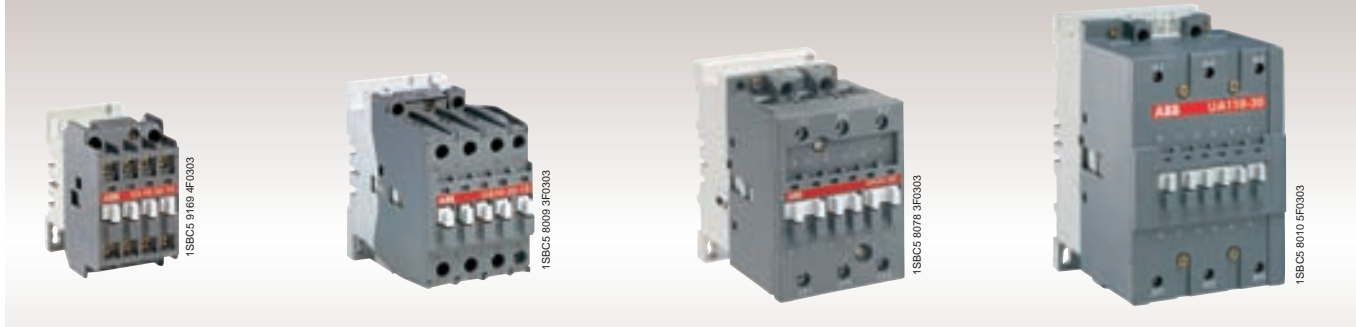

A... and AF... Standard Contactors (A 12 to A 300 and AF 50 to AF 750)

Maximum permissible peak current $\hat{I} \leq 30$ times the nominal rms current of the switched capacitor.

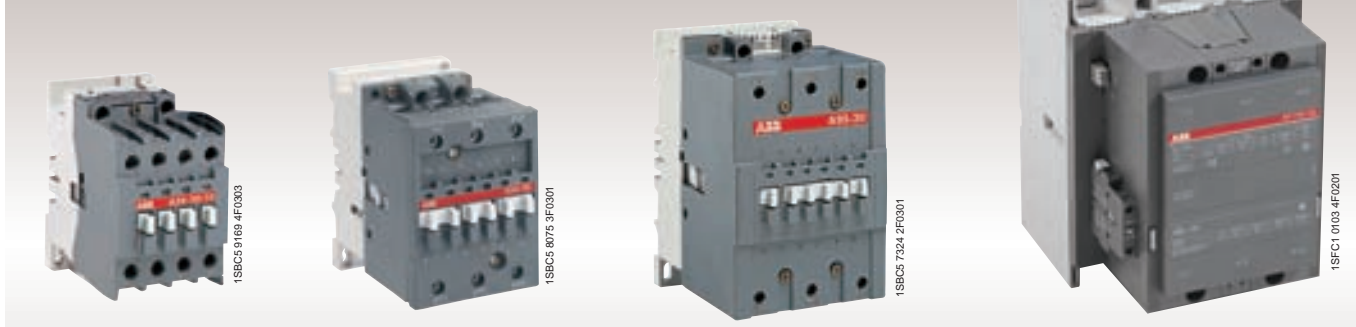

UA..RA 3-pole Contactors for Capacitor Switching

Unlimited Peak Current \hat{I}



Application

The **UA..RA** contactors can be used in installations in which the peak current far exceeds 100 times nominal rms current. The contactors are delivered complete with their damping resistors and must be used without additional inductances (see table below).

The capacitors must be discharged (maximum residual voltage at terminals ≤ 50 V) before being re-energized when the contactors are making. Their electrical durability is 250 000 operating cycles for $U_e < 500$ V and 100 000 operating cycles for 500 V $\leq U_e \leq 690$ V.

Description

The **UA..RA** contactors are fitted with a special front mounted block, which ensures the serial insertion of 3 damping resistors into the circuit to limit the current peak on energization of the capacitor bank. Their connection also ensures capacitor precharging in order to limit the second current peak occurring upon making of the main poles.

Operating principle

The front-mounted block mechanism of the **UA..RA** contactors ensures:

- early making of the auxiliary "PA" poles with respect to the main "PP" poles
- automatic return to the open position of the auxiliary "PA" poles after the main poles are closed.

When the coil is energized, the early making auxiliary poles connect the capacitor to the network via the set of 3 resistors. The damping resistors attenuate the first current peak and the second inrush current when the main contacts begin to make. Once the main poles are in the closed position, the auxiliary poles automatically break.

When the coil is de-energized, the main poles break ensuring the breaking of the capacitor bank. The contactor can then begin a new cycle.

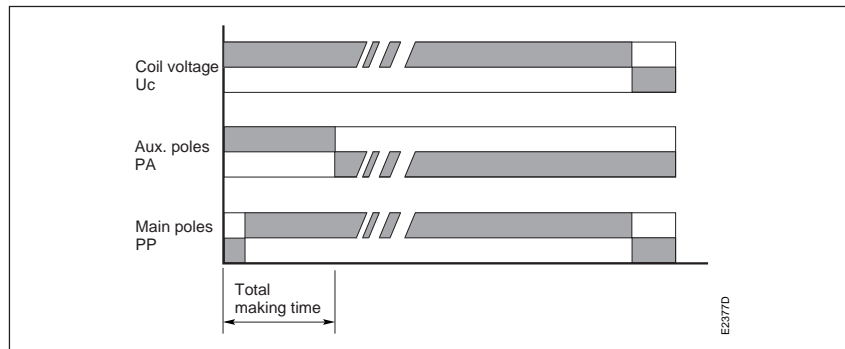
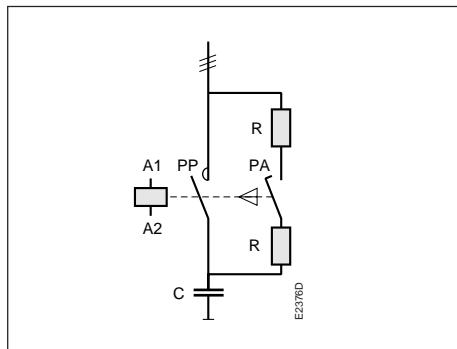

The insertion of resistors allows to damp the highest current peak of the capacitor when switching on, whatever its level.

Selection Table according to IEC

Type	Power in kvar – 50/60 Hz (AC-6b)															Max. permissible peak current \hat{I}	gG type fuses A max (*)
	230/240 V			400/415 V			440 V			500/550 V			690 V				
	40°C	55°C	70°C	40°C	55°C	70°C	40°C	55°C	70°C	40°C	55°C	70°C	40°C	55°C	70°C		
UA 16-30-10 RA	8	7.5	6	12.5	12.5	10	15	13	11	18	16	12.5	22	21	17	Unlimited	80
UA 26-30-10 RA	12.5	11.5	9	22	20	15.5	24	20	17	30	25	20	35	31	26		125
UA 30-30-10 RA	16	16	11	30	27.5	19.5	32	30	20.5	34	34	25	45	45	32		200
UA 50-30-00 RA	25	24	20	40	40	35	50	43	37	55	50	46	72	65	60		200
UA 63-30-00 RA	30	27	23	50	45	39	55	48	42.5	65	60	50	80	75	65		200
UA 75-30-00 RA	35	30	25	60	50	41	65	53	45	75	65	55	100	80	70		200
UA 95-30-00 RA	40	35	30	70	60	53	75	65	58	85	75	70	120	105	85		250
UA 110-30-00 RA	45	40	35	80	70	60	85	75	70	95	82	78	130	110	100		250

(*) The fuse ratings given in the column represent the maximum ratings ensuring type 1 coordination according to the definition of standard IEC 60947-4-1.

Selection Table according to UL/CSA

Type	Power in kvar – 60 Hz			Max permissible peak current \hat{I}
	240 V 40 °C	480 V 40 °C	600 V 40 °C	
UA 16-30-10 RA	8	16	20	Unlimited
UA 26-30-10 RA	11	22	27	
UA 30-30-10 RA	14	28	35	
UA 50-30-00 RA	25	50	62	
UA 63-30-00 RA	27.5	55	70	
UA 75-30-00 RA	32	64	80	
UA 95-30-00 RA (1)	40	80	100	
UA 110-30-00 RA (1)	45	95	120	

(1) UL Listed to U.S. and Canadian safety standards (cULus).

UA..RA 3-pole Contactors for Capacitor Switching

Unlimited Peak Current \hat{I}



Ordering Details

IEC Rated power 400 V 40 °C kvar	UL/CSA Rated power 480 V 40 °C kvar	Auxiliary contacts fitted	Type	Order code	Weight kg
			state coil voltage <input type="text"/> (see table below)	state coil voltage code <input type="text"/> <input type="text"/> (see table below)	Pack ^{ing} 1 piece
12.5	16	1 -	UA 16-30-10 RA <input type="text"/>	1SBL 181 024 R <input type="text"/> <input type="text"/> 10	0.460
22	22	1 -	UA 26-30-10 RA <input type="text"/>	1SBL 241 024 R <input type="text"/> <input type="text"/> 10	0.710
30	28	1 -	UA 30-30-10 RA <input type="text"/>	1SBL 281 024 R <input type="text"/> <input type="text"/> 10	0.810
40	50	- -	UA 50-30-00 RA <input type="text"/>	1SBL 351 024 R <input type="text"/> <input type="text"/> 00	1.350
50	55	- -	UA 63-30-00 RA <input type="text"/>	1SBL 371 024 R <input type="text"/> <input type="text"/> 00	1.350
60	64	- -	UA 75-30-00 RA <input type="text"/>	1SBL 411 024 R <input type="text"/> <input type="text"/> 00	1.350
70	80	- -	UA 95-30-00 RA <input type="text"/>	1SFL 431 024 R <input type="text"/> <input type="text"/> 00	2.000
80	95	- -	UA 110-30-00 RA <input type="text"/>	1SFL 451 024 R <input type="text"/> <input type="text"/> 00	2.000

Coil voltages and codes

Voltage <input type="text"/> <input type="text"/> <input type="text"/> V - 50Hz	Voltage <input type="text"/> <input type="text"/> <input type="text"/> V - 60Hz	Code <input type="text"/> <input type="text"/>
24	24	8 1
48	48	8 3
110	110 ... 120	8 4
220 ... 230	230 ... 240	8 0
230 ... 240	240 ... 260	8 8
380 ... 400	400 ... 415	8 5
400 ... 415	415 ... 440	8 6

Other voltages: page 0/1 of the main catalogue .



UA 16-30-10 RA



UA 30-30-10 RA



UA 75-30-00 RA



UA 110-30-00 RA

>> Technical Data page 6
>> Accessory Fitting Details page 7

>> Terminal Marking and Positioning page 8
>> Dimensions page 9

UA..RA 3-pole Contactors for Capacitor Switching

Unlimited Peak Current \hat{I}



Technical Data

Types	UA 16..RA	UA 26..RA	UA 30..RA	UA 50..RA UA 63..RA UA 75..RA	UA 95..RA UA 110..RA
Short-circuit protection gG type fuses	sized 1.5 ... 1.8 I_n of the capacitor				
Max. electrical switching frequency Operating cycles/h	240				
Electrical durability AC-6b – operating cycles at $U_e \leq 440$ V	250 000				
– operating cycles at 500 V $\leq U_e \leq 690$ V	100 000				
Connecting capacity (min. ... max.) Main conductors (poles)					
Rigid: solid (≤ 4 mm ²) } 1 x mm ²	1 ... 4	1.5 ... 6	2.5 ... 16	6 ... 50	10 ... 95
stranded (≥ 6 mm ²) } 2 x mm ²	–	–	2.5 ... 16 + 2.5 ... 6	6 ... 25 + 6 ... 16	6 ... 35
Flexible with cable end 1 x mm ²	0.75 ... 2.5	1.5 ... 4	2.5 ... 10	6 ... 35	10 ... 70
2 x mm ²	–	–	2.5 ... 10 + 2.5 ... 4	6 ... 16 + 6 ... 10	6 ... 35
Lugs L mm \leq l mm $>$	7.7 3.7	10 4.2	– –	– –	– –
Auxiliary conductors (built-in auxiliary terminals + coil terminals)					
Rigid solid 1 x mm ²	1 ... 4				0.75 ... 2.5
2 x mm ²	1 ... 4				0.75 ... 2.5
Flexible with cable end 1 x mm ²	0.75 ... 2.5			1 ... 2.5	0.75 ... 2.5
2 x mm ²	0.75 ... 2.5				
Lugs					
Built-in aux. terminals L mm \leq l mm $>$	7.7 3.7	10 4.2	8 3.7	– –	– –
Coil terminals L mm \leq l mm $>$	8 3.7				
Degree of protection acc. to IEC 60947-1 / EN 60947-1 and IEC 60529 / EN 60529	Protection against direct contact in acc. with EN 50274				
– Main terminals	IP 20		IP 10		
– Coil terminals	IP 20				
– Built-in auxiliary terminals	IP 20			–	–

Other technical characteristics are the same as those of standard A... contactors.

>> Rated Power in kvar and Selection Table page 4

UA..RA 3-pole Contactors for Capacitor Switching

Main Accessories



Ordering Details

Auxiliary contact blocks

For contactors	Max. number of blocks	Contact blocks	Type	Order code	Pack ^{ing} pieces	Weight kg
						1 piece

1-pole auxiliary contact blocks (Front mounting)

UA 30..RA	1 block	} 1 - - -	CA 5-10	1SBN 010 010 R1010	10	0.014
UA 50..RA	2 blocks					
UA 63..RA	2 blocks					
UA 75..RA	2 blocks					
UA 95..RA	2 blocks					
UA 110..RA	2 blocks					
		- 1 - -	CA 5-01	1SBN 010 010 R1001	10	0.014

2-pole auxiliary contact blocks N.O. + N.C. (Side mounting)

UA 16..RA	1 block	} 1 1 - -	CAL 5-11	1SBN 010 020 R1011	2	0.050
UA 26..RA	2 blocks					
UA 30..RA	2 blocks					
UA 50..RA	2 blocks					
UA 63..RA	2 blocks					
UA 75..RA	2 blocks					
UA 95..RA	2 blocks	} 1 1 - -	CAL 18-11	1SFN 010 720 R1011	2	0.050
UA 110..RA	2 blocks					

Surge suppressors for contactor coils

For contactors	Control voltage	Type	Order code	Pack ^{ing} pieces	Weight kg
	V a.c.				1 piece
UA 16..RA to UA 110..RA	24 ... 50	RV 5/50	1SBN 050 010 R1000	2	0.015
	50 ... 133	RV 5/133	1SBN 050 010 R1001	2	0.015
	110 ... 250	RV 5/250	1SBN 050 010 R1002	2	0.015
	250 ... 440	RV 5/440	1SBN 050 010 R1003	2	0.015
UA 16..RA to UA 30..RA	24 ... 50	RC 5-1/50	1SBN 050 100 R1000	2	0.012
	50 ... 133	RC 5-1/133	1SBN 050 100 R1001	2	0.012
	110 ... 250	RC 5-1/250	1SBN 050 100 R1002	2	0.012
	250 ... 440	RC 5-1/440	1SBN 050 100 R1003	2	0.012
UA 50..RA to UA 110..RA	24 ... 50	RC 5-2/50	1SBN 050 200 R1000	2	0.015
	50 ... 133	RC 5-2/133	1SBN 050 200 R1001	2	0.015
	110 ... 250	RC 5-2/250	1SBN 050 200 R1002	2	0.015
	250 ... 440	RC 5-2/440	1SBN 050 200 R1003	2	0.015



CA 5-10



CAL 5-11



CAL 18-11



RV 5/50



RC 5-1/50

UA..RA 3-pole Contactors for Capacitor Switching

Unlimited Peak Current \hat{I}



Terminal Marking and Positioning

Standard devices without addition of auxiliary contacts

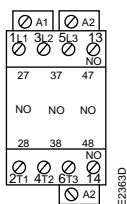

UA16-30-10 RA
UA26-30-10 RA

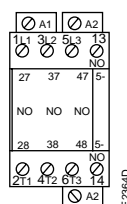

UA30-30-10 RA

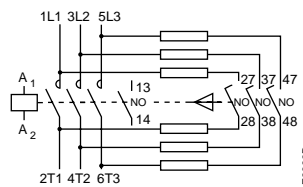

UA16 ... 30-30-10 RA

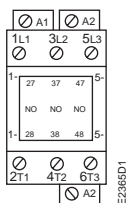

UA50 ... 110-30-00 RA

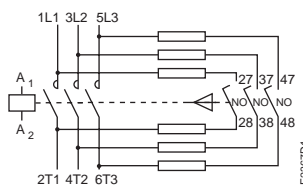

UA50 ... 110-30-00 RA

UA..RA 3-pole Contactors for Capacitor Switching

Unlimited Peak Current \hat{I}



Dimensions (mm)

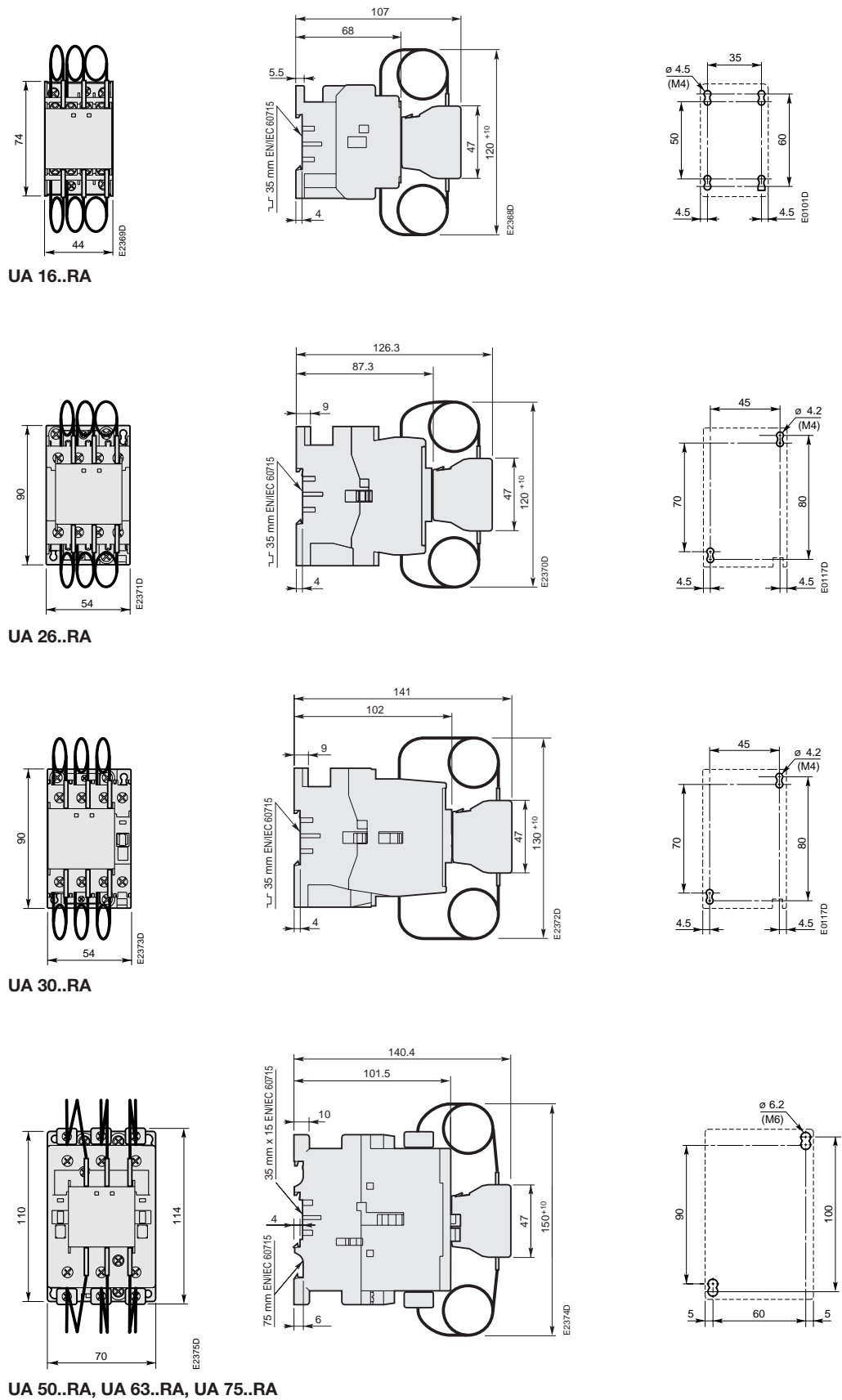

UA..RA 3-pole Contactors for Capacitor Switching

Unlimited Peak Current \hat{I}



Dimensions (mm)

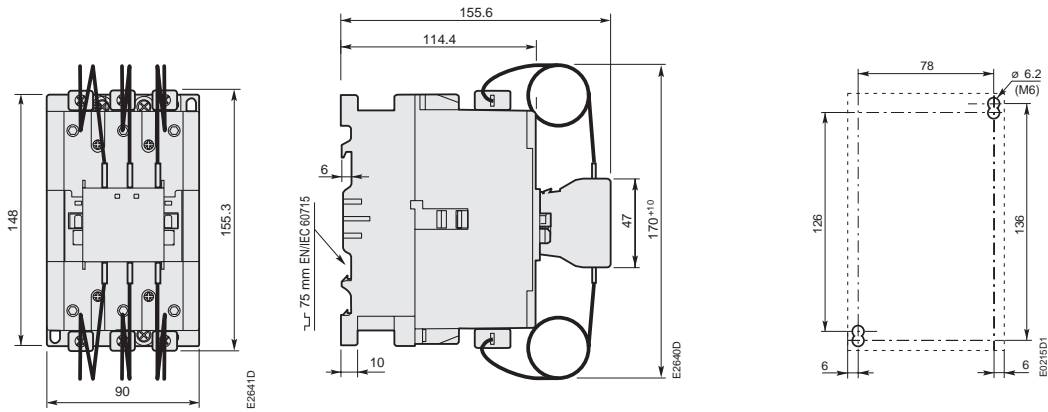

UA 95..RA, UA 110..RA



Notes



A series of horizontal lines for writing notes, with a red line positioned just below the highlighter icon.

UA... 3-pole Contactors for Capacitor Switching

Peak Current $\hat{I} \leq 100$ Times the rms Current



Application

The **UA...** contactors can be used for the switching of capacitor banks whose inrush current peaks are less than or equal to 100 times nominal rms current. The table below gives the permissible powers according to operational voltage and temperature close to the contactor. It also specifies the maximum peak current **\hat{I} values** accepted by the contactor.

The capacitors must be discharged (maximum residual voltage at terminals ≤ 50 V) before being re-energized when the contactors are making.

In these conditions, electrical durability of contactors is equal to 100 000 operating cycles.

Description

See general design for **A...** standard contactors.

Selection Table according to IEC

Type	Power in kvar 50/60 Hz (AC-6b)															Max. permissible peak current \hat{I} (kA)	
	230/240 V			400/415 V			440 V			500/550 V			690 V			U_n	U_n
	40°C	55°C	70°C	40°C	55°C	70°C	40°C	55°C	70°C	40°C	55°C	70°C	40°C	55°C	70°C	≤ 500 V	> 500 V
UA 16	7.5	6.7	6	12.5	11.7	10	13.7	13	11	15.5	14.7	12.5	21.5	20	17	1.8	1.6
UA 26	12	11	8.5	20	18.5	14.5	22	20	16	22	22	19.5	30	30	25	3	2.7
UA 30	16	16	11	27.5	27.5	19	30	30	20	34	34	23.5	45	45	32	3.5	3.1
UA 50	20	20	19	33	33	32	36	36	35	40	40	40	55	55	52	5	4.5
UA 63	25	25	21	45	43	37	50	48	41	50	50	45	70	70	60	6.5	5.8
UA 75	30	30	22	50	50	39	55	53	43	62	62	47.5	75	75	65	7.5	6.75
UA 95	35	35	30	65	65	55	65	65	55	70	70	60	80	80	70	9.3	8
UA 110	40	40	35	75	70	65	75	75	70	80	80	75	90	90	85	10.5	9

For **220 V** and **380 V**, multiply by **0.9** the rated values at 230 V and 400 V respectively.

Example: 50 kvar/400 V corresponding to $0.9 \times 50 = 45$ kvar/380 V.

The capacitor bank will be protected by gG type fuses whose rating is equal to 1.5 ... 1.8 times nominal current.

Selection Table according to UL/CSA

Type	Power in kvar - 60 Hz		
	240 V 40 °C	480 V 40 °C	600 V 40 °C
UA 26	12.5	25	30
UA 30	16	32	40
UA 50	20	40	50
UA 75	27.5	55	70
UA 95	35	70	75
UA 110	40	80	85

If, in an application, the current peak is greater than the maximum peak current \hat{I} specified in the tables above, select a higher rating, refer to the **UA..RA** contactors, or add inductances. (see Calculation and dimensioning).

UA... 3-pole Contactors for Capacitor Switching

Peak Current $\hat{I} \leq 100$ Times the rms Current



Ordering Details

IEC Rated power 400 V 40 °C kvar	Max. peak current \hat{I} kA	UL/CSA Rated power 480 V 40 °C kvar	Auxiliary contacts fitted 	Type	Order code		Weight kg Pack ^{ing} 1 piece
					state coil voltage <input type="text"/> <input type="text"/> (see table below)	state coil voltage code <input type="checkbox"/> <input type="checkbox"/> (see table below)	
12.5	1.8	—	1 —	UA 16-30-10 <input type="text"/> <input type="text"/>	1SBL 181 022 R <input type="checkbox"/> <input type="checkbox"/> 10	0.340	
20	3	25	1 —	UA 26-30-10 <input type="text"/> <input type="text"/>	1SBL 241 022 R <input type="checkbox"/> <input type="checkbox"/> 10	0.600	
27.5	3.5	32	1 —	UA 30-30-10 <input type="text"/> <input type="text"/>	1SBL 281 022 R <input type="checkbox"/> <input type="checkbox"/> 10	0.710	
33	5	40	— —	UA 50-30-00 <input type="text"/> <input type="text"/>	1SBL 351 022 R <input type="checkbox"/> <input type="checkbox"/> 00	1.160	
			1 1	UA 50-30-11 <input type="text"/> <input type="text"/>	1SBL 351 022 R <input type="checkbox"/> <input type="checkbox"/> 11	1.200	
45	6.5	—	— —	UA 63-30-00 <input type="text"/> <input type="text"/>	1SBL 371 022 R <input type="checkbox"/> <input type="checkbox"/> 00	1.160	
			1 1	UA 63-30-11 <input type="text"/> <input type="text"/>	1SBL 371 022 R <input type="checkbox"/> <input type="checkbox"/> 11	1.200	
50	7.5	55	— —	UA 75-30-00 <input type="text"/> <input type="text"/>	1SBL 411 022 R <input type="checkbox"/> <input type="checkbox"/> 00	1.160	
			1 1	UA 75-30-11 <input type="text"/> <input type="text"/>	1SBL 411 022 R <input type="checkbox"/> <input type="checkbox"/> 11	1.200	
65	9.3	70	— —	UA 95-30-00 <input type="text"/> <input type="text"/>	1SFL 431 022 R <input type="checkbox"/> <input type="checkbox"/> 00	2.000	
			1 1	UA 95-30-11 <input type="text"/> <input type="text"/>	1SFL 431 022 R <input type="checkbox"/> <input type="checkbox"/> 11	2.040	
75	10.5	80	— —	UA 110-30-00 <input type="text"/> <input type="text"/>	1SFL 451 022 R <input type="checkbox"/> <input type="checkbox"/> 00	2.000	
			1 1	UA 110-30-11 <input type="text"/> <input type="text"/>	1SFL 451 022 R <input type="checkbox"/> <input type="checkbox"/> 11	2.040	

Coil voltages and codes

Voltage <input type="text"/> <input type="text"/> V - 50Hz	Voltage <input type="text"/> <input type="text"/> V - 60Hz	Code <input type="checkbox"/> <input type="checkbox"/>
24	24	8 1
48	48	8 3
110	110 ... 120	8 4
220 ... 230	230 ... 240	8 0
230 ... 240	240 ... 260	8 8
380 ... 400	400 ... 415	8 5
400 ... 415	415 ... 440	8 6

Other voltages: page 0/1 of the Main Catalogue.

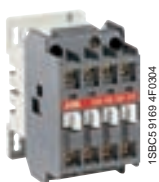

UA 16-30-10



UA 30-30-10

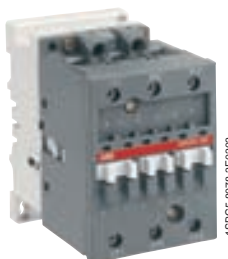

UA 50-30-00



UA 110-30-00

>> Technical Data page 14
>> Accessory Fitting Details page 15

>> Terminal Marking and Positioning page 16
>> Dimensions page 17

UA... 3-pole Contactors for Capacitor Switching

Peak Current $\hat{I} \leq 100$ Times the rms Current



Technical Data

Types	UA 16	UA 26	UA 30	UA 50 UA 63 UA 75	UA 95 UA 110
Short-circuit protection gG type fuses	sized 1.5 ... 1.8 I_n of the capacitor				
Max. electrical switching frequency Operating cycles/h	240				
Electrical durability AC-6b operating cycles at $U_e \leq 690$ V	100 000				
Connecting capacity (min. ... max.) Main conductors (poles)					
Rigid: solid (≤ 4 mm ²) } 1 x mm ²	1 ... 4	1.5 ... 6	2.5 ... 16	6 ... 50	10 ... 95
stranded (≥ 6 mm ²) } 2 x mm ²	1 ... 4	1.5 ... 6	2.5 ... 16	6 ... 25	6 ... 35
Flexible with cable end 1 x mm ²	0.75 ... 2.5	0.75 ... 4	2.5 ... 10	6 ... 35	10 ... 70
2 x mm ²	0.75 ... 2.5	0.75 ... 4	2.5 ... 10	6 ... 16	6 ... 35
Lugs L mm \leq	7.7	10	–	–	–
l mm $>$	3.7	4.2	–	–	–
Auxiliary conductors (built-in auxiliary terminals + coil terminals)					
Rigid solid 1 x mm ²	1 ... 4				0.75 ... 2.5
2 x mm ²	1 ... 4				0.75 ... 2.5
Flexible with cable end 1 x mm ²	0.75 ... 2.5			1 ... 2.5	0.75 ... 2.5
2 x mm ²	0.75 ... 2.5				
Lugs					
Built-in aux. terminals L mm \leq	7.7	10	8	–	–
l mm $>$	3.7	4.2	3.7	–	–
Coil terminals L mm \leq	8				
l mm $>$	3.7				
Degree of protection acc. to IEC 60947-1 / EN 60947-1 and IEC 60529 / EN 60529	Protection against direct contact in acc. with EN 50274				
– Main terminals	IP 20			IP 10	
– Coil terminals	IP 20				
– Built-in auxiliary terminals	IP 20			–	–

Other technical characteristics are the same as those of standard A... contactors.

UA... 3-pole Contactors for Capacitor Switching

Main Accessories



Ordering Details

Auxiliary contact blocks

For contactors	Max. number of blocks	Contact blocks	Type	Order code	Pack ^{ing} pieces	Weight kg
						1 piece

1-pole auxiliary contact blocks (Front mounting)

UA 16 to UA 26	4 blocks	} 1 - - -	CA 5-10	1SBN 010 010 R1010	10	0.014
UA 30	5 blocks		CA 5-01	1SBN 010 010 R1001	10	0.014
UA 50 to UA 110	6 blocks		- 1 - - -			

2-pole auxiliary contact blocks N.O. + N.C. (Side mounting)

UA 16 to UA 75	2 blocks	1 1 - -	CAL 5-11	1SBN 010 020 R1011	2	0.050
UA 95, UA 110	2 blocks	1 1 - -	CAL 18-11	1SFN 010 720 R1011	2	0.050

Surge suppressors for contactor coils

For contactors	Control voltage	Type	Order code	Pack ^{ing} pieces	Weight kg
	V a.c.				
UA 16 to UA 110	24 ... 50	RV 5/50	1SBN 050 010 R1000	2	0.015
	50 ... 133	RV 5/133	1SBN 050 010 R1001	2	0.015
	110 ... 250	RV 5/250	1SBN 050 010 R1002	2	0.015
	250 ... 440	RV 5/440	1SBN 050 010 R1003	2	0.015
UA 16 to UA 30	24 ... 50	RC 5-1/50	1SBN 050 100 R1000	2	0.012
	50 ... 133	RC 5-1/133	1SBN 050 100 R1001	2	0.012
	110 ... 250	RC 5-1/250	1SBN 050 100 R1002	2	0.012
	250 ... 440	RC 5-1/440	1SBN 050 100 R1003	2	0.012
UA 50 to UA 110	24 ... 50	RC 5-2/50	1SBN 050 200 R1000	2	0.015
	50 ... 133	RC 5-2/133	1SBN 050 200 R1001	2	0.015
	110 ... 250	RC 5-2/250	1SBN 050 200 R1002	2	0.015
	250 ... 440	RC 5-2/440	1SBN 050 200 R1003	2	0.015



CA 5-10

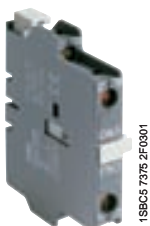

CAL 5-11



CAL 18-11



RV 5/50



RC 5-1/50

UA... 3-pole Contactors for Capacitor Switching

Peak Current $\hat{I} \leq 100$ Times the rms Current



Terminal Marking and Positioning

Standard devices without addition of auxiliary contacts

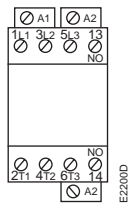

UA16 ... UA30-30-10

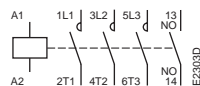

UA16 ... UA30-30-10

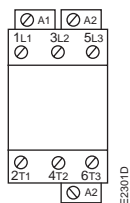

UA50 ... UA110-30-00

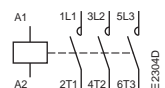

UA50... UA110-30-00

Standard devices with factory mounted auxiliary contacts

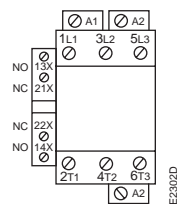

UA50 ... UA110-30-11

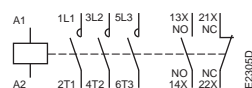

UA50... UA110-30-11

UA... 3-pole Contactors for Capacitor Switching

Peak Current $\hat{I} \leq 100$ Times the rms Current



Dimensions (in mm)

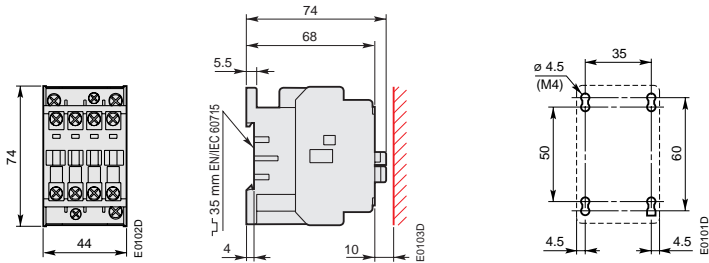

UA 16

UA 16 drilling plan

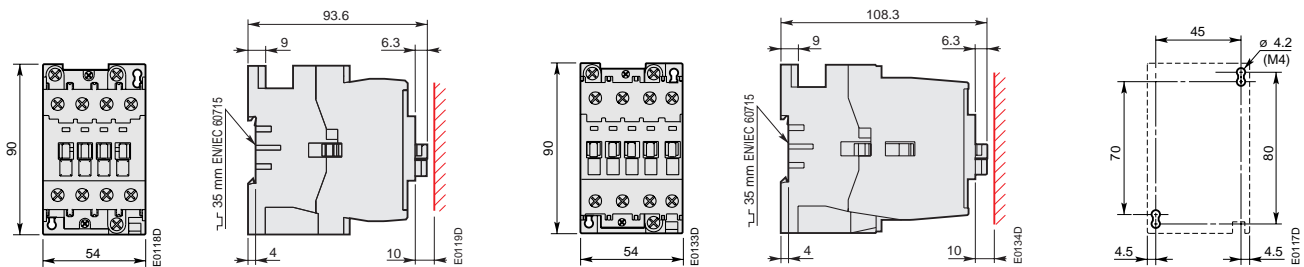

UA 26

UA 30

UA 26, UA 30 drilling plan

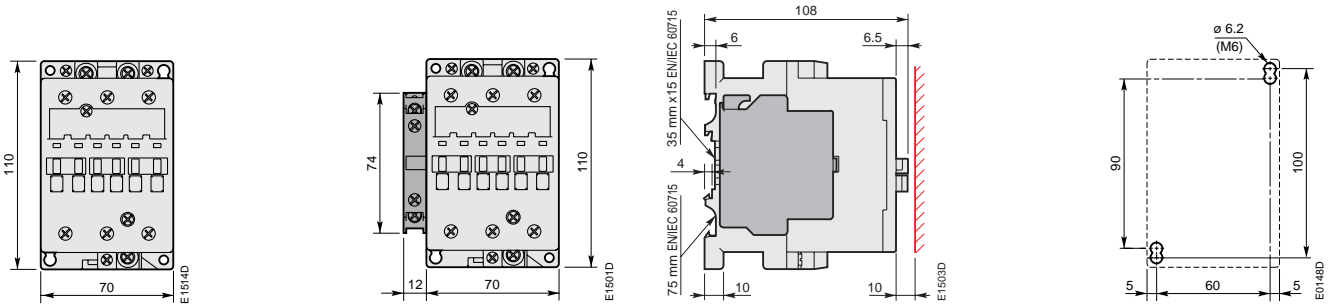

UA 50, UA 63, UA 75-30-00

UA 50, UA 63, UA 75-30-11

Drilling plan

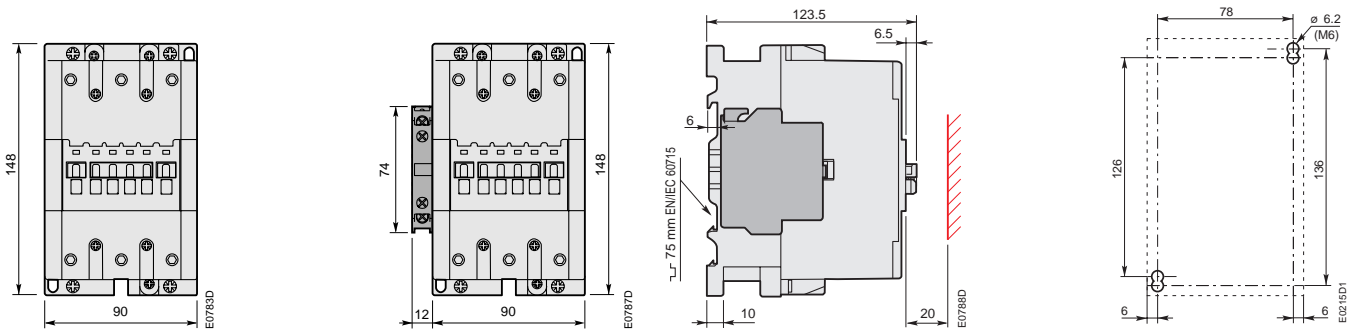

UA 95, UA 110-30-00

UA 95, UA 110-30-11

Drilling plan

A... and AF... Standard 3-pole Contactors for Capacitor Switching

Single Step - Peak Current $\hat{I} \leq 30$ Times the rms Current



Application

The **A...** and **AF...** contactors are suited for capacitor bank switching for the peak current and power values in the table below. The capacitors must be discharged (maximum residual voltage at terminals ≤ 50 V) before being re-energized when the contactors are making. In these conditions, electrical durability of contactors is equal to 100 000 operating cycles.

Description

See "General Design" for **A...** and **AF...** contactors see the Main Catalogue

Selection Table according to IEC

Type	Power in kvar 50/60 Hz (AC-6b)															Max. peak current \hat{I} (kA)
	230/240 V			400/415 V			440 V			500/550V			690 V			
	40°C	55°C	70°C	40°C	55°C	70°C	40°C	55°C	70°C	40°C	55°C	70°C	40°C	55°C	70°C	
A 9	—	—	—	—	—	—	—	—	—	—	—	—	—	—	—	—
A 12	7	7	6	11	11	9.5	12	12	10.5	14	14	12	19	19	16.5	0.7
A 16	7.5	7.5	6	12.5	12.5	10	14	14	10.5	15.5	15.5	12	21.5	21.5	16.5	1
A 26	11.5	11.5	9	19	19	15	20	20	16.5	23	23	19	32	32	26	1.6
A 30	13	13	11	22	22	18.5	24	24	20.5	28	28	23	38	38	32	1.9
A 40	15	15	12	26	26	20	29	29	22	35	35	25	46	46	34.5	2.1
A/AF 50	22	22	20	38	38	34	42	42	37	48	48	42	65	65	58.5	2.3
A/AF 63	25	25	23	43	43	39	47	47	42.5	54	54	48.5	74	74	67	2.5
A/AF 75	28	28	24.5	48	48	41	52	52	45	60	60	51	82	82	70	2.6
A/AF 95	35	35	33	60	60	53	63	63	58	75	75	70	80	80	75	4
A/AF 110	40	40	35	70	70	60	75	75	65	83	83	78	90	90	85	4
A/AF 145	50	50	42	90	90	74	93	93	80	110	110	96	110	110	110	4
A/AF 185	60	60	45	110	110	83	115	115	85	135	135	102	135	135	135	5
A/AF 210	75	75	57	130	130	105	135	135	110	160	160	130	160	160	160	6.5
A/AF 260	85	85	70	145	145	135	155	155	140	180	180	165	200	200	200	8
A/AF 300	100	100	85	165	165	155	180	180	163	210	210	196	240	240	240	8
AF 400	120	120	105	210	210	195	220	220	200	260	260	241	300	300	300	10
AF 460	140	140	120	240	240	225	260	260	230	325	325	300	325	325	325	10
AF 580	170	170	160	285	285	275	300	300	290	350	350	340	440	440	440	12
AF 750	220	220	190	400	400	370	410	410	380	490	490	435	600	600	600	12

Note: For 3-pole A 16 ... A 110 contactors used with anti-resonance inductances (**Severol mH**, built specially to suppress inrush current), see Calculation and dimensioning.

If, in an application, the current peak is greater than the maximum peak current \hat{I} specified in the table above, select a higher rating, refer to the **UA...** contactors, or add inductances, see Calculation and dimensioning.

Specific Technical Data - For other characteristics see Main Catalogue.

Short-circuit protection: gG type fuses sized 1.5 ... 1.8 I_n of the capacitor

Electrical durability AC-6b: 100 000 operating cycles

Terminal Marking and Positioning - see Main Catalogue.

Dimensions - see Main Catalogue.

A... and AF... Standard 3-pole Contactors for Capacitor Switching

Single Step - Peak Current $\hat{I} \leq 30$ Times the rms Current



A 26-30-10

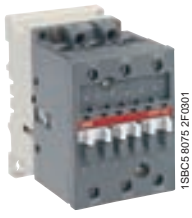

A 50-30-00



A 95-30-00



AF 750-30-11

Ordering Details

IEC Power 400 V 40 °C kvar	Max. peak current \hat{I} kA	Auxiliary contacts fitted 	Type state coil voltage <input type="checkbox"/> <input type="checkbox"/> <input type="checkbox"/> (see table below)	Order code state coil voltage code <input type="checkbox"/> <input type="checkbox"/> (see table below)	Weight kg	Pack ^{ing} 1 piece
11	0.7	1 -	A 12-30-10 <input type="checkbox"/> <input type="checkbox"/> <input type="checkbox"/>	1SBL 161 001 R <input type="checkbox"/> <input type="checkbox"/> <input type="checkbox"/>	0.340	
12.5	1	1 -	A 16-30-10 <input type="checkbox"/> <input type="checkbox"/> <input type="checkbox"/>	1SBL 181 001 R <input type="checkbox"/> <input type="checkbox"/> <input type="checkbox"/>	0.340	
19	1.6	1 -	A 26-30-10 <input type="checkbox"/> <input type="checkbox"/> <input type="checkbox"/>	1SBL 241 001 R <input type="checkbox"/> <input type="checkbox"/> <input type="checkbox"/>	0.600	
22	1.9	1 -	A 30-30-10 <input type="checkbox"/> <input type="checkbox"/> <input type="checkbox"/>	1SBL 281 001 R <input type="checkbox"/> <input type="checkbox"/> <input type="checkbox"/>	0.710	
26	2.1	1 -	A 40-30-10 <input type="checkbox"/> <input type="checkbox"/> <input type="checkbox"/>	1SBL 321 001 R <input type="checkbox"/> <input type="checkbox"/> <input type="checkbox"/>	0.710	
38	2.3	- -	A 50-30-00 <input type="checkbox"/> <input type="checkbox"/> <input type="checkbox"/> AF 50-30-00 <input type="checkbox"/> <input type="checkbox"/> <input type="checkbox"/>	1SBL 351 001 R <input type="checkbox"/> <input type="checkbox"/> <input type="checkbox"/> 1SBL 357 001 R <input type="checkbox"/> <input type="checkbox"/> <input type="checkbox"/>	1.160 1.180	
43	2.5	- -	A 63-30-00 <input type="checkbox"/> <input type="checkbox"/> <input type="checkbox"/> AF 63-30-00 <input type="checkbox"/> <input type="checkbox"/> <input type="checkbox"/>	1SBL 371 001 R <input type="checkbox"/> <input type="checkbox"/> <input type="checkbox"/> 1SBL 377 001 R <input type="checkbox"/> <input type="checkbox"/> <input type="checkbox"/>	1.160 1.180	
48	2.6	- -	A 75-30-00 <input type="checkbox"/> <input type="checkbox"/> <input type="checkbox"/> AF 75-30-00 <input type="checkbox"/> <input type="checkbox"/> <input type="checkbox"/>	1SBL 411 001 R <input type="checkbox"/> <input type="checkbox"/> <input type="checkbox"/> 1SBL 417 001 R <input type="checkbox"/> <input type="checkbox"/> <input type="checkbox"/>	1.160 1.180	
60	4	- -	A 95-30-00 <input type="checkbox"/> <input type="checkbox"/> <input type="checkbox"/> AF 95-30-00 <input type="checkbox"/> <input type="checkbox"/> <input type="checkbox"/>	1SFL 431 001 R <input type="checkbox"/> <input type="checkbox"/> <input type="checkbox"/> 1SFL 437 001 R <input type="checkbox"/> <input type="checkbox"/> <input type="checkbox"/>	2.000 2.030	
70	4	- -	A 110-30-00 <input type="checkbox"/> <input type="checkbox"/> <input type="checkbox"/> AF 110-30-00 <input type="checkbox"/> <input type="checkbox"/> <input type="checkbox"/>	1SFL 451 001 R <input type="checkbox"/> <input type="checkbox"/> <input type="checkbox"/> 1SFL 457 001 R <input type="checkbox"/> <input type="checkbox"/> <input type="checkbox"/>	2.000 2.030	
90	4	1 1	A 145-30-11 <input type="checkbox"/> <input type="checkbox"/> <input type="checkbox"/> AF 145-30-11 <input type="checkbox"/> <input type="checkbox"/> <input type="checkbox"/>	1SFL 471 001 R <input type="checkbox"/> <input type="checkbox"/> <input type="checkbox"/> 1SFL 477 001 R <input type="checkbox"/> <input type="checkbox"/> <input type="checkbox"/>	3.500 3.600	
110	5	1 1	A 185-30-11 <input type="checkbox"/> <input type="checkbox"/> <input type="checkbox"/> AF 185-30-11 <input type="checkbox"/> <input type="checkbox"/> <input type="checkbox"/>	1SFL 491 001 R <input type="checkbox"/> <input type="checkbox"/> <input type="checkbox"/> 1SFL 497 001 R <input type="checkbox"/> <input type="checkbox"/> <input type="checkbox"/>	3.500 3.600	
130	6.5	1 1	A 210-30-11 <input type="checkbox"/> <input type="checkbox"/> <input type="checkbox"/> AF 210-30-11 <input type="checkbox"/> <input type="checkbox"/> <input type="checkbox"/>	1SFL 511 001 R <input type="checkbox"/> <input type="checkbox"/> <input type="checkbox"/> 1SFL 517 001 R <input type="checkbox"/> <input type="checkbox"/> <input type="checkbox"/>	6.100 6.200	
145	8	1 1	A 260-30-11 <input type="checkbox"/> <input type="checkbox"/> <input type="checkbox"/> AF 260-30-11 <input type="checkbox"/> <input type="checkbox"/> <input type="checkbox"/>	1SFL 531 001 R <input type="checkbox"/> <input type="checkbox"/> <input type="checkbox"/> 1SFL 537 001 R <input type="checkbox"/> <input type="checkbox"/> <input type="checkbox"/>	6.100 6.200	
165	8	1 1	A 300-30-11 <input type="checkbox"/> <input type="checkbox"/> <input type="checkbox"/> AF 300-30-11 <input type="checkbox"/> <input type="checkbox"/> <input type="checkbox"/>	1SFL 551 001 R <input type="checkbox"/> <input type="checkbox"/> <input type="checkbox"/> 1SFL 557 001 R <input type="checkbox"/> <input type="checkbox"/> <input type="checkbox"/>	6.100 6.200	
210	10	1 1	AF 400-30-11 <input type="checkbox"/> <input type="checkbox"/> <input type="checkbox"/>	1SFL 577 001 R <input type="checkbox"/> <input type="checkbox"/> <input type="checkbox"/>	12.00	
240	10	1 1	AF 460-30-11 <input type="checkbox"/> <input type="checkbox"/> <input type="checkbox"/>	1SFL 597 001 R <input type="checkbox"/> <input type="checkbox"/> <input type="checkbox"/>	12.00	
285	12	1 1	AF 580-30-11 <input type="checkbox"/> <input type="checkbox"/> <input type="checkbox"/>	1SFL 617 001 R <input type="checkbox"/> <input type="checkbox"/> <input type="checkbox"/>	15.00	
400	12	1 1	AF 750-30-11 <input type="checkbox"/> <input type="checkbox"/> <input type="checkbox"/>	1SFL 637 001 R <input type="checkbox"/> <input type="checkbox"/> <input type="checkbox"/>	15.00	

Coil voltages and codes: A 12 ... A 300

Voltage <input type="checkbox"/> <input type="checkbox"/> <input type="checkbox"/> V - 50Hz	Voltage <input type="checkbox"/> <input type="checkbox"/> <input type="checkbox"/> V - 60Hz	Code <input type="checkbox"/> <input type="checkbox"/>
24	24	8 1
48	48	8 3
110	110 ... 120	8 4
220 ... 230	230 ... 240	8 0
230 ... 240	240 ... 260	8 8
380 ... 400	400 ... 415	8 5
400 ... 415	415 ... 440	8 6

Other voltages: page 0/1 of the Main Catalogue.

Coil voltages and codes: AF 50 ... AF 300

Voltage <input type="checkbox"/> <input type="checkbox"/> <input type="checkbox"/> V - 50/60Hz	Voltage <input type="checkbox"/> <input type="checkbox"/> <input type="checkbox"/> V d.c.	Code <input type="checkbox"/> <input type="checkbox"/>
-	20 ... 60	7 2 (1)
48 ... 130	48 ... 130	6 9
100 ... 250	100 ... 250	7 0

(1) The connection polarities indicated close to the coil terminals must be respected: **A1** for the **positive** pole and **A2** for the **negative** pole.

Coil voltages and codes: AF 400 ... AF 750

Voltage <input type="checkbox"/> <input type="checkbox"/> <input type="checkbox"/> V - 50/60Hz	Voltage <input type="checkbox"/> <input type="checkbox"/> <input type="checkbox"/> V d.c.	Code <input type="checkbox"/> <input type="checkbox"/>
-	24 ... 60	6 8 (1)
48 ... 130	48 ... 130	6 9
100 ... 250	100 ... 250	7 0
250 ... 500	250 ... 500	7 1

(1) The connection polarities indicated close to the coil terminals must be respected: **A1** for the **positive** pole and **A2** for the **negative** pole.

>> Accessory Fitting Details page 20
>> AF... Contactors with Electronic Coil Interface: electromagnetic compatibility Main Catalogue

A... Standard 3-pole Contactors for Capacitor Switching

Main Accessories



Ordering Details

Auxiliary contact blocks

For contactors	Max. number of blocks	Contact blocks	Type	Order code	Pack ^{ing} pieces	Weight kg
						1 piece

1-pole auxiliary contact blocks (Front mounting)

A 12 to A 26	4 blocks	} 1 - - -	CA 5-10	1SBN 010 010 R1010	10	0.014	
A 30, A 40	5 blocks		CA 5-01	1SBN 010 010 R1001	10	0.014	
A 50 to A 110	6 blocks						
AF 50 to AF 110	6 blocks						

2-pole auxiliary contact blocks N.O. + N.C. (Side mounting)

A 12 to A 75	2 blocks	} 1 1 - -	CAL 5-11	1SBN 010 020 R1011	2	0.050
AF 50 to AF 75	2 blocks					
A 95 to A 300	2 blocks	} 1 1 - -	CAL 18-11	1SFN 010 720 R1011	2	0.050
AF 95 to AF 750	2 blocks					
A 145 to A 300	2 blocks ⁽¹⁾	} 1 1 - -	CAL 18-11B	1SFN 010 720 R3311	2	0.050
AF 145 to AF 750	2 blocks ⁽¹⁾					

(1) 2 blocks CAL 18-11 + 2 blocks CAL 18-11B

For contactors	Control voltage		Type	Order code	Pack ^{ing} pieces	Weight kg
	V a.c.					
A 12 to A 110	24 ... 50	RV 5/50	1SBN 050 010 R1000	2	0.015	
	50 ... 133	RV 5/133	1SBN 050 010 R1001	2	0.015	
	110 ... 250	RV 5/250	1SBN 050 010 R1002	2	0.015	
	250 ... 440	RV 5/440	1SBN 050 010 R1003	2	0.015	
A 12 to A 40	24 ... 50	RC 5-1/50	1SBN 050 100 R1000	2	0.012	
	50 ... 133	RC 5-1/133	1SBN 050 100 R1001	2	0.012	
	110 ... 250	RC 5-1/250	1SBN 050 100 R1002	2	0.012	
	250 ... 440	RC 5-1/440	1SBN 050 100 R1003	2	0.012	
A 50 to A110	24 ... 50	RC 5-2/50	1SBN 050 200 R1000	2	0.015	
	50 ... 133	RC 5-2/133	1SBN 050 200 R1001	2	0.015	
	110 ... 250	RC 5-2/250	1SBN 050 200 R1002	2	0.015	
	250 ... 440	RC 5-2/440	1SBN 050 200 R1003	2	0.015	

Note: for AF 50 ... AF 750 the built-in coil interface eliminates the need of extra surge suppressors.

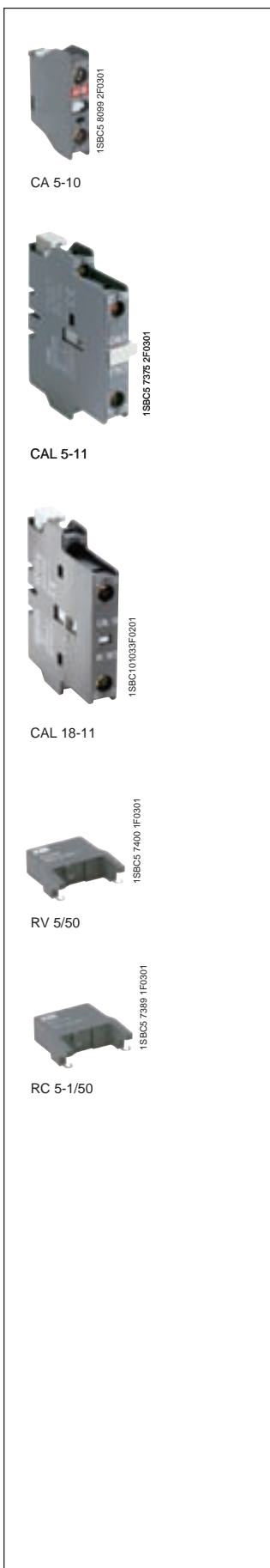

>> Other accessories Main Catalogue

Contactors for Capacitor Switching

Selection Examples

Application and Possibilities

Description of the application

Capacitor bank:
20 kvar at 400 V, 50 Hz three-phase.
Ambient temperature around the contactor: 40 °C

Nominal current:
$$I_n = \frac{P}{\sqrt{3} \times U}$$

$$= \frac{20000}{1.7 \times 400} \approx 29 \text{ A}$$

Thermal current:
$$I_T = I_n \times 1.5$$

$$= 29 \times 1.5 \approx 43 \text{ A}$$

Case no. 1 - Inrush peak current: 1700 Å

Possibility selection table for A... standard contactors see page 18

A 30 contactor (22 kvar, 400 V).
This contactor accepts a maximum peak current of 1900 Å.

Case no. 2 - Inrush peak current: 2500 Å

Possibility no. 1 selection table for UA... contactors see page 12

UA 26 contactor (20 kvar, 400 V). This contactor accepts a maximum peak current of 3000 Å ($U_e \leq 500V$).

Possibility no. 2 selection table for A... standard contactors see page 18

A 30 contactor + additional inductances limiting peak current to a peak of 1900 Å that is acceptable for the A 30 contactor.

Possibility no. 3 selection table for A... standard contactors see page 18

A 63 contactor (43 kvar, 400 V).
This contactor accepts a maximum peak current of 2500 Å.

Case no. 3 - Inrush peak current: 4500 Å.

Possibility no. 1 selection table for UA..RA contactors see page 4

UA 26..RA contactor (22 kvar, 400 V).
This contactor can be directly used without an additional inductance.

Possibility no. 2 selection table for UA... contactors see page 12

UA 26 contactor + additional inductances limiting peak current to a peak of 3000 Å acceptable for the UA 26 contactor ($U_e \leq 500 V$).

Possibility no. 3 selection table for A... standard contactors see page 18

A 30 contactor + additional inductances limiting peak current to a peak of 1900 Å acceptable for the A30 contactor.

Possibility no. 4 selection table for A... standard contactors see page 18

A 185 contactor (105 kvar 400 V).
This contactor accepts a maximum peak current of 5000 Å.

Special Case - Use of anti-resonance inductances

Possibility For no inrush peak current and no 5th harmonics (and above) see page 31.

A 26 contactors (27 kvar, 400 V) + additional anti-resonance inductances suppressing the peak current and the 5th harmonics.

i The information given on pages 23 and 24 will enable the user to calculate current peaks and to limit them to a value acceptable for the contactor. Since this calculation is never exact, capacitor bank manufacturers optimise their products by tests.

Calculation of Inrush Current Peak and Frequency

If the inrush current peak on energizing of a capacitor bank is greater than that acceptable for the switching contactor, there is a risk that power factor correction will no longer be ensured.

This is because, in this case, the contactor may remain permanently closed due to welding of its main poles.

The formulas given below are used to estimate inrush current peak as well as current frequency during the transient period. The values of the inductances used in the formulas can be determined by the methods described on pages 25 and 26.

Caution:

These formulas are applicable only if the capacitor bank is completely discharged at the time of energizing (maximum voltage at terminals ≤ 50 V).

Three-phase Capacitor Bank with a Single Step.

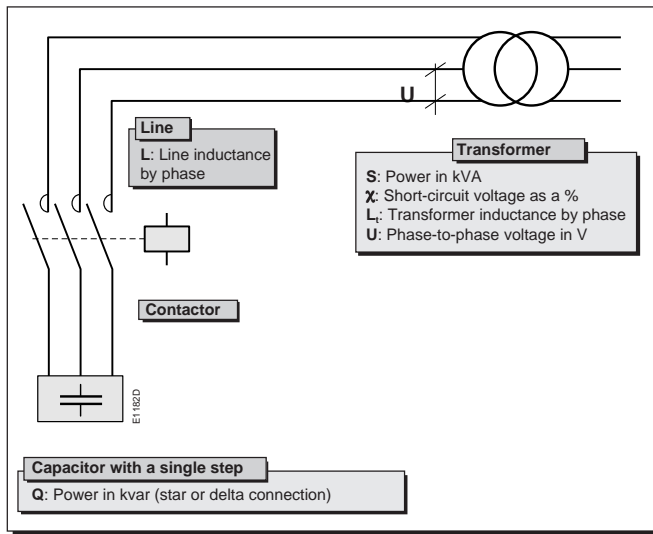

Inrush peak current \hat{I} :

$$\hat{I} = \sqrt{\frac{10^9}{3 \pi f}} \times \sqrt{\frac{Q}{L + L_t}} \quad \hat{I} = k_1 \sqrt{\frac{Q}{L + L_t}}$$

Inrush current frequency f_0 :

$$f_0 = k_2 U \sqrt{\frac{1}{Q(L + L_t)}}$$

\hat{I} : in Amperes

f : mains current frequency in Hz

Q : in kvar

L, L_t in μ H

$k_1 = 1457$ (50 Hz) or 1330 (60 Hz)

$k_2 = 89.2$ (50 Hz) or 97.2 (60 Hz)

Three-phase Capacitor Bank with Several Steps of Identical Power.

Energizing of the capacitor Q_n with "n - 1" capacitors on duty.

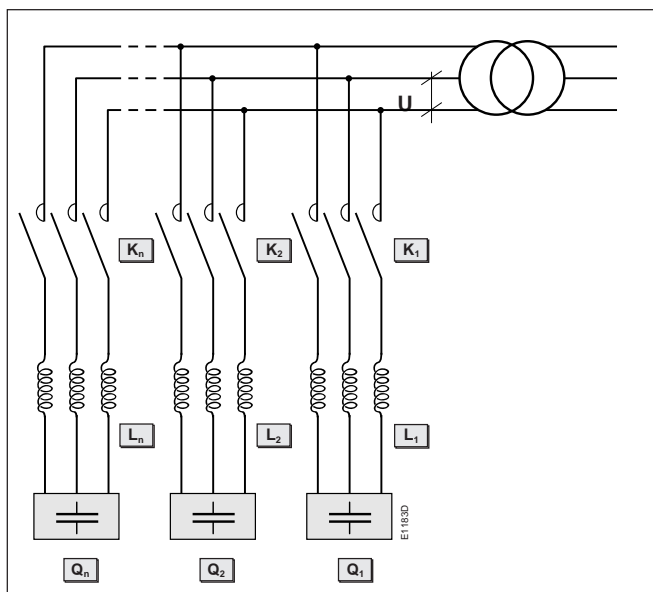

Inrush peak current \hat{I} :

$$\hat{I} = k_1 \frac{n-1}{n} \times \sqrt{\frac{Q_n}{L_n}}$$

Inrush current frequency f_0 :

$$f_0 = k_2 U \sqrt{\frac{1}{L_n \times Q_n}}$$

\hat{I} : in Amperes

$L_1 = L_2 = \dots = L_n$: inductance by phase of a step in μ H

$Q_1 = Q_2 = \dots = Q_n$: power of a step in kvar

n : number of capacitor steps

U : phase-to-phase voltage in V

$k_1 = 1457$ (50 Hz) or 1330 (60 Hz)

$k_2 = 89.2$ (50 Hz) or 97.2 (60 Hz)

Calculation of Inrush Current Peak and Frequency

Three-phase Capacitor Bank with Several Steps of Different Powers

Energizing of the capacitor Q_n with "n - 1" capacitors on duty

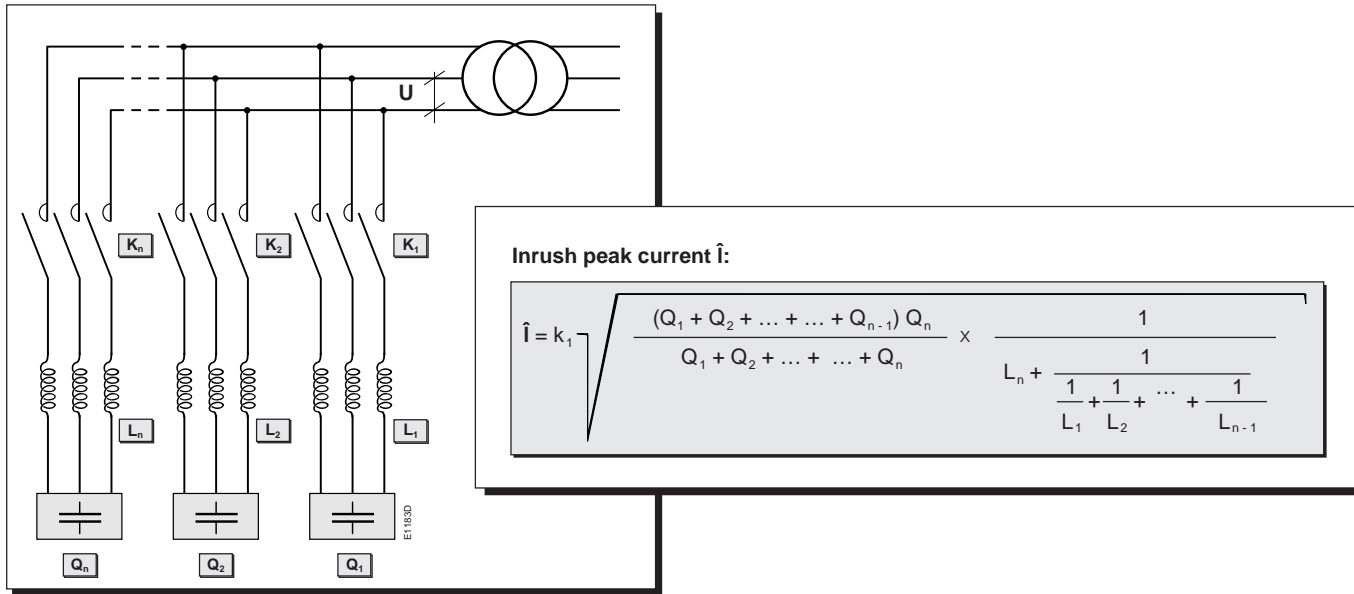

Energizing of Q_n

– Fictitious number of steps $n = \frac{\text{Bank total power}}{\text{Power of smallest step}}$

– The inrush current peak of Q_n is the same as that of a capacitor bank made up of n identical steps provided that the inductances $L_1, L_2 \dots L_n$ are inversely proportional to the power of these steps.

$$L_{n \text{ mini}} = L_1 \frac{Q_1}{Q_n}$$

$Q_1 = a Q_n$	$L_1 = L_n / a$
$Q_2 = b Q_n$	$L_2 = L_n / b$
$Q_{..} = .. Q_n$	$L_{..} = L_n / ..$
⋮	⋮
$Q_{n-1} = z Q_n$	$L_{n-1} = L_n / z$

Determining the Transformer Inductance

The value of the inductance (L_t) of the transformer used in the various formulas above can be determined by following the method described below.

Reminder of the values marked on the transformer plate

- S:** Power in kVA
- χ:** Short-circuit voltage as a %
- U:** Phase-to-phase operating voltage in Volts
- f:** Current frequency in Hertz

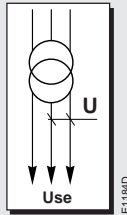

Value L_t of the inductance by phase of the transformer in μH :

$$L_t = \frac{1}{200 \pi f} \cdot \frac{\chi U^2}{S} \cdot 10^3$$

$$L_t = \frac{\chi U^2}{k_3 S}$$

$k_3 = 31.4$ (50 Hz) or 37.68 (60 Hz)

The following chart gives this value by direct reading

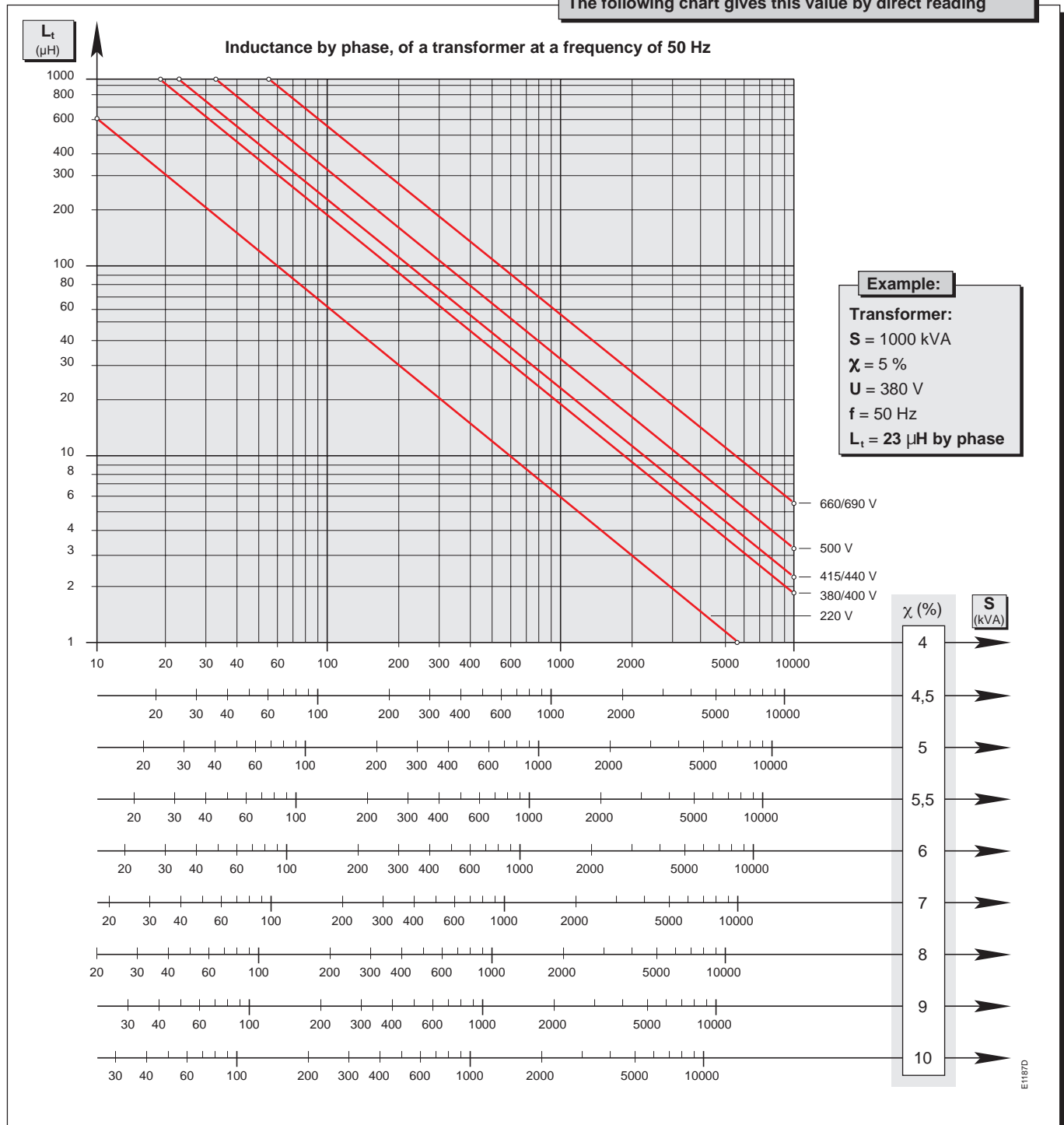

Determining the Electrical Connection Inductances

For a symmetrical connection formed by non-magnetic conductors, the linear coefficient of apparent self-inductance is the same for all the conductors and is given by:

$$L = \left[0.05 + 0.46 \log_{10} \frac{2 a_m}{d} \right] \mu\text{H/m}$$

d = diameter of the conductive core (mm)

a_m = geometric average of distances between the conductor axes (mm)

Single-phase installation

$$a_m = a$$

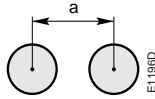

Three-phase delta installation

$$a_m = a$$

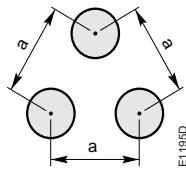

Three-phase adjacent installation

$$a_m = a \sqrt[3]{2}$$

$$a_m = 1.26 a$$

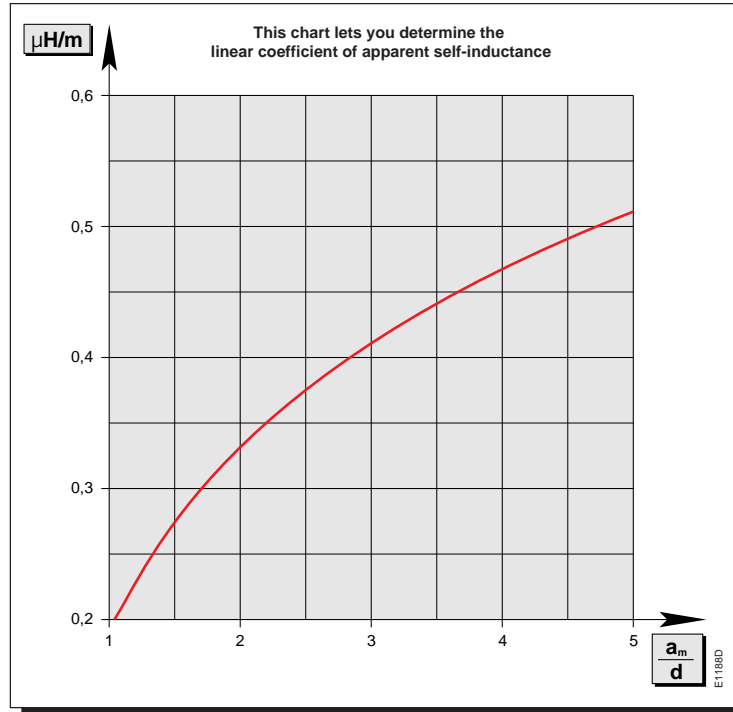
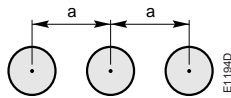

Guideline values

Conductive cross-sectional area (mm ²)	4	6	10	16	25	35	50	70	95	120
Conductive core $\varnothing = d$ (mm)	2.26	2.92	3.9	4.9	6.1	7.2	8.4	10.1	11.9	13.4
Outer \varnothing U1000 RO2V	7.2	8.2	9.2	10.5	12.5	13.5	15	17	19	21

Attenuation of the Inrush Peak

If the electrical connection inductances are very low, the inrush current peak of the capacitor bank may not be sufficiently attenuated and thus cause welding of the main poles of the contactor.

To avoid this risk, the user must select a contactor that can withstand a higher current peak (UA or UA..RA range) or may serial-connect "additional" inductances in the circuit.

Determining Electrical Connection Minimum Inductances

The formulas given on page 23 to calculate the inrush current peak can also be used to determine the minimum value of the electrical connection inductances separating the transformer from the capacitor bank, without risk of welding the main poles of the contactor.

● Capacitor bank with one step

$$\hat{I} = k_1 \sqrt{\frac{Q}{L + L_t}} \quad \text{thus } L_{\min} = \left(\frac{k_1^2 Q}{\hat{I}^2} \right) - L_t$$

L_{\min} : minimum inductance of the electrical connection in μH .

\hat{I} : maximum peak, acceptable for the contactor in **A** (see tables on pages 12 and 18).

Q : power of the capacitor bank in **kvar**.

Q_n : power of the n^{th} step in **kvar**.

L_t : inductance by phase of the transformer in μH .

$k_1 = 1457$ (if $f = 50$ Hz) or $= 1330$ (if $f = 60$ Hz)

● Capacitor bank with several identical steps

$$\hat{I} = k_1 \frac{n-1}{n} \sqrt{\frac{Q_n}{L_n + L_t}} \quad \text{thus } L_{\min} = \left(\frac{k_1^2}{\hat{I}^2} \frac{(n-1)^2}{n^2} Q_n \right) - L_t$$

The chart on page 28 allows, by direct reading, identification of the minimum value of the inductance according to:

- the type of contactor,
- the power of the capacitor bank in kvar,
- the number of steps.

Practical Method for Making Additional Inductances

If the electrical connection inductances are too low (current peaks not sufficiently attenuated), the user can add additional inductances, simply made by winding the cables designed to be connected to the capacitor bank, onto a cylinder. The method below provides all the technical information required to make these additional inductances.

● Theoretical reminder

An electrical conductor wound with joining turns on a cylinder of a diameter (d), forms an inductance coil whose inductance is equal to:

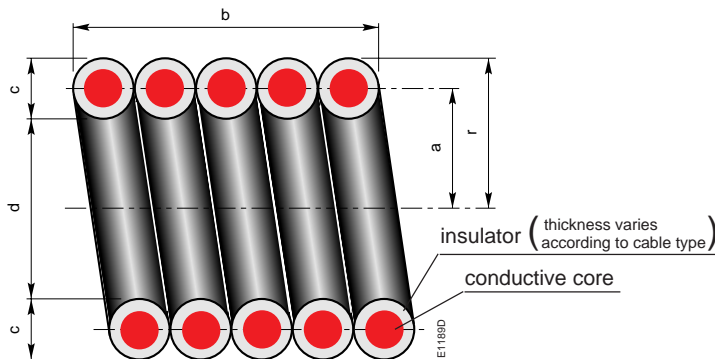

$$L = 10^{-7} \frac{4 \pi^2 \cdot a^2 \cdot N^2}{b + c + r} \cdot F_1 \cdot F_2$$

$$F_1 = \frac{10b + 12c + 2r}{10b + 10c + 1,4r}$$

$$F_2 = 0.5 \log_{10} \left(100 + \frac{14r}{2b + 3c} \right)$$

L: self-inductance in **H**

N: number of circular turns

a, b, c, d, r: dimensions in **m**

● Charts

The charts on pages 29 and 30 allow, by direct reading, identification of the number of turns to be made according to:

- the cable cross-sectional area that will be used to connect the capacitor bank,
- the diameter of the cylinder used to make the inductance coil,
- the necessary inductance value.

Attenuation of the Inrush Peak

Chart used to determine electrical connection minimum inductances

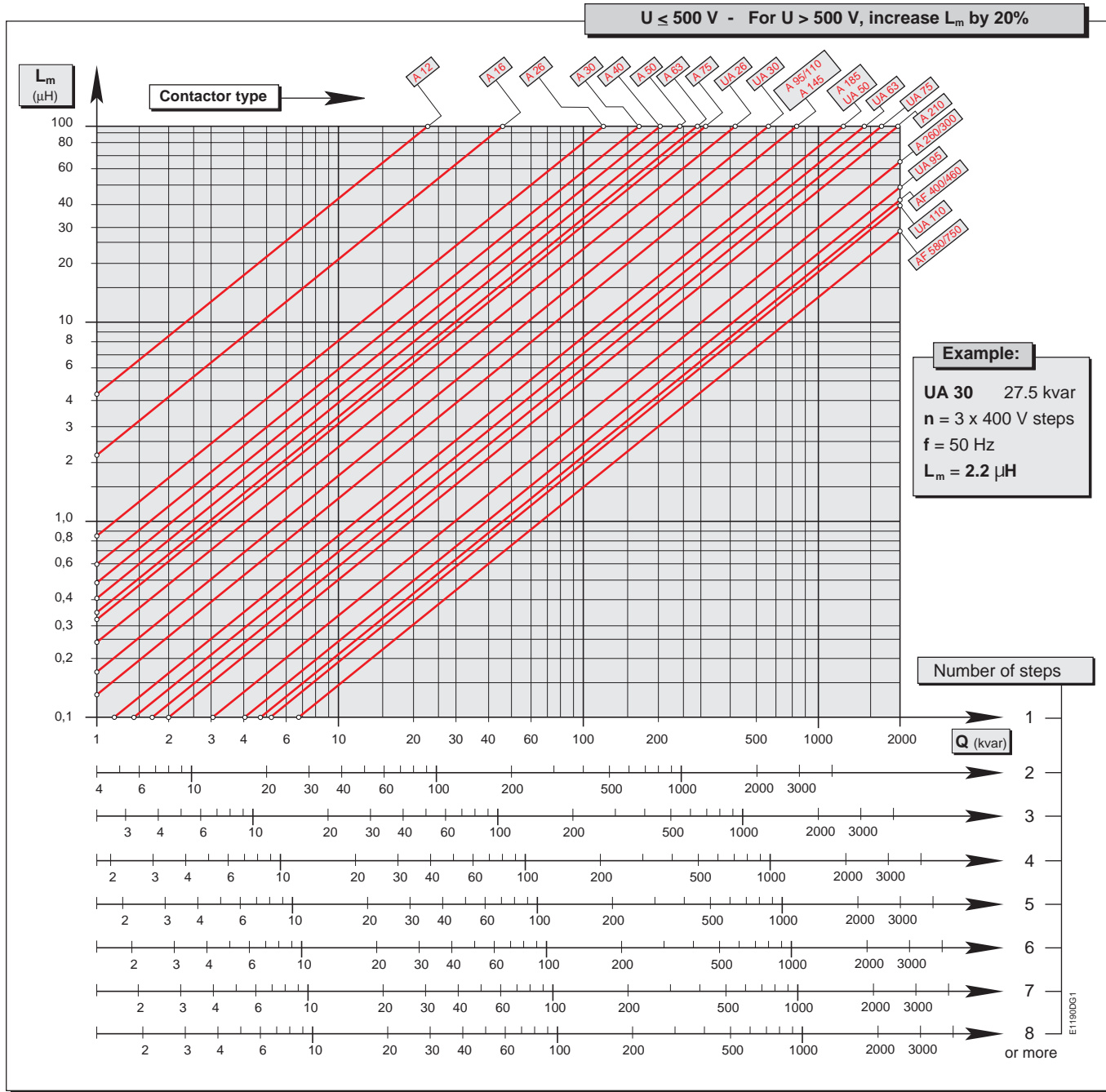

Attenuation of the Inrush Peak

Additional Inductances ($\varnothing = 10 \times$ cable diameter)

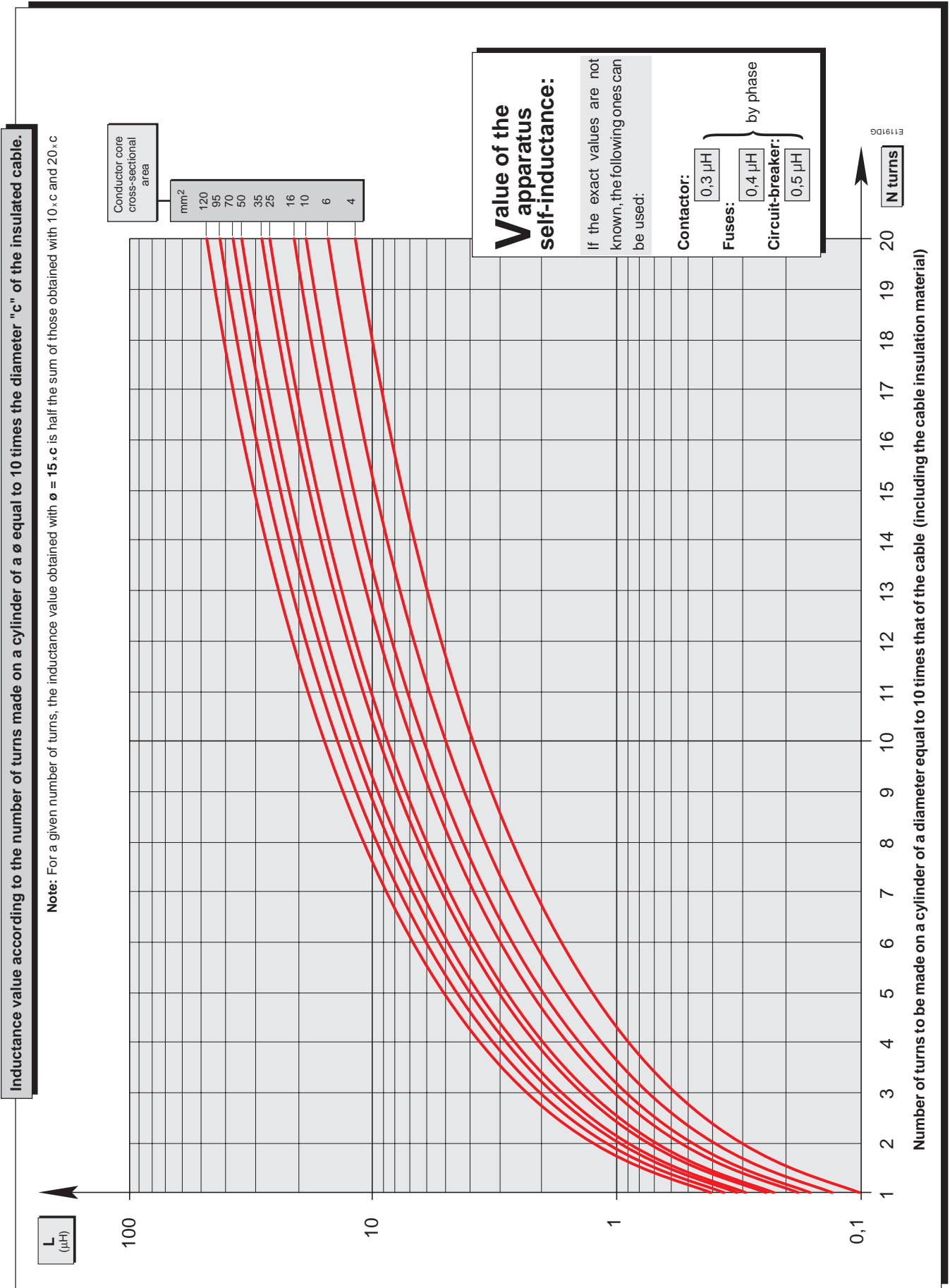

Attenuation of the Inrush Peak

Additional Inductances ($\varnothing = 20 \times$ cable diameter)

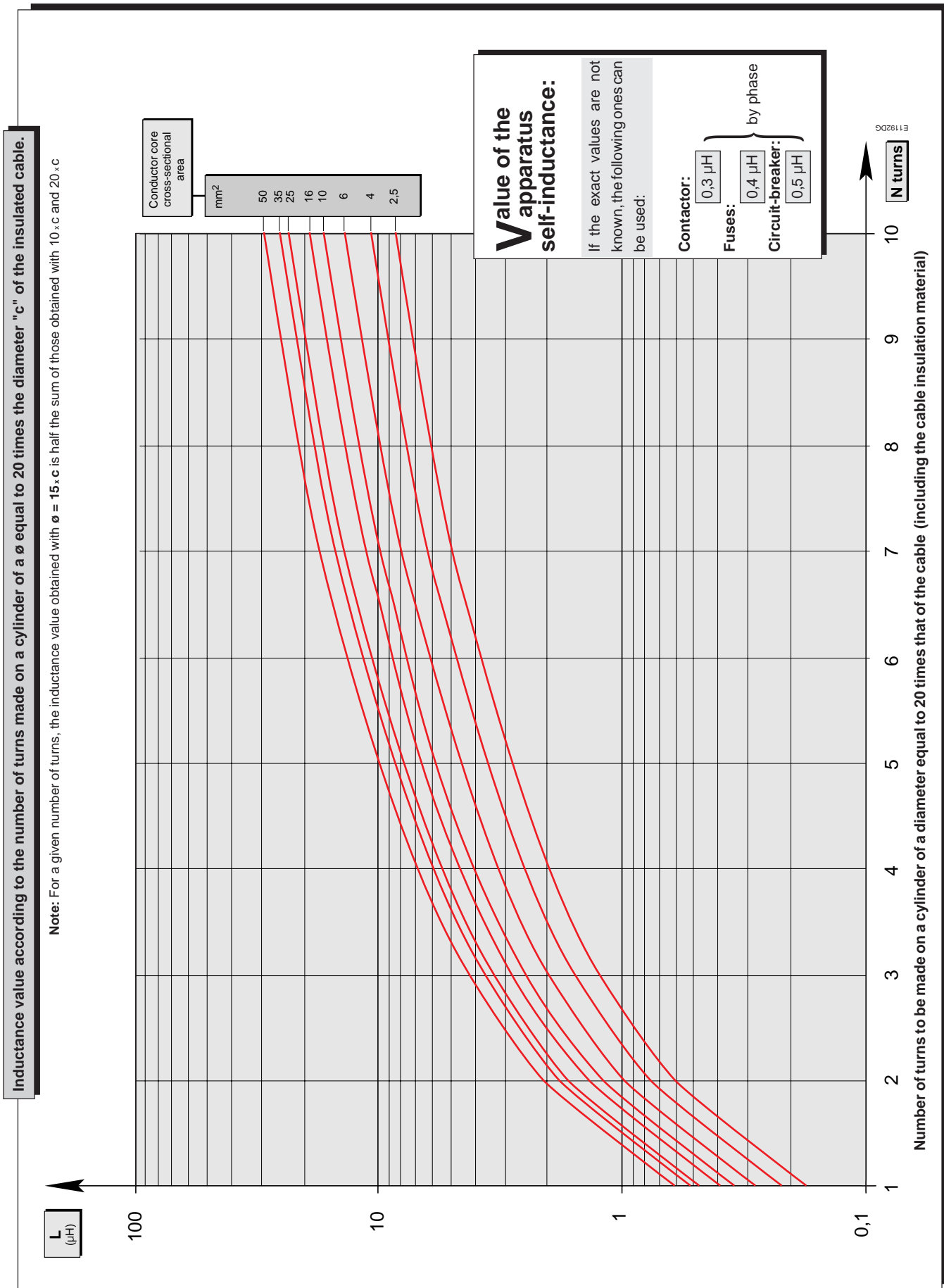

Suppression of the Inrush Peak current and the 5th Harmonics (and above) for A 9 ... A 110 Contactors

Additional Anti-Resonance Inductances

Description

When the harmonics created by switching capacitors have to be avoided, one system is to use anti-resonance inductances in the circuit. These inductances (several mH) suppress any inrush peak current and the 5th harmonics (and above) when contactors are making on capacitors.

The use of standard A 9 ... A 110 3-pole contactors is then possible on multi-step capacitor bank.

The capacitors must be discharged (maximum residual voltage at terminals < 50 V) before being re-energized when the contactors are making.

In these conditions, electrical durability of contactors is larger than 100 000 operating cycles.

Selection Table

The main advantage is to use the contactor close to its I_e AC-1 current (coefficient 1.15) in comparison with dedicated contactors **UA** or **UA-RA** where the coefficient is 1.5, due to the presence of harmonics.

Type	I _e (A)			Power in kvar 50/60 Hz (AC-6b)														
				400 V			415 V			440 V			500 V			690 V		
	40°C	55°C	70°C	40°C	55°C	70°C	40°C	55°C	70°C	40°C	55°C	70°C	40°C	55°C	70°C	40°C	55°C	70°C
A 16	30	27	23	18	16	14	19	17	14	20	18	15	23	20	17	31	28	24
A 26	45	40	32	27	24	19	28	25	20	30	27	21	34	30	24	47	42	33
A 40	60	60	42	36	36	25	38	38	26	40	40	28	45	45	32	62	62	44
A 50	100	85	70	60	51	42	63	53	44	66	56	46	75	64	53	104	88	73
A 63	115	95	80	69	57	48	72	59	50	76	63	53	87	72	60	120	99	83
A 75	125	105	85	75	63	51	78	66	53	83	70	56	94	79	64	130	109	88
A 95	145	135	115	87	81	69	91	84	72	96	89	76	109	102	87	151	140	120
A 110	160	145	130	96	87	78	100	91	81	106	96	86	120	109	98	166	151	135

Calculation of Anti-Resonance Inductances

An anti-resonance inductance is taken as p % of the total reactive power Q given by capacitors.

A typical value of p is 7 % and the data of L is given by the formula:

$$L \text{ (in H)} = \frac{p}{1-p} \times \frac{3 U^2}{2 \pi f Q}$$

U = Voltage
 p = in %
 f = Frequency
 Q = Reactive power

Note: **Anti-Resonance inductances** of several mH are designed to suppress the inrush peak current and the 5th harmonics (and above).

Additional Inductances of several μH (page 27) are designed to attenuate the inrush peak current for A contactors (Standard single-step capacitor switching application) or for **UA..** Contactors (Standard multi-step capacitor switching application)

Installation Studies

Three-phase Capacitor Bank with a Single Step

Example:

Transformer.
500 kVA 220 V 50 Hz Short-circuit voltage $\chi = 4\%$
Capacitor = 5 kvar
Transformer/capacitor connection
10 m of adjacent cables $a_m = 3 d$ (4 mm²)
Temperature: $\theta = 55\text{ }^\circ\text{C}$

$$\hat{i} = k_1 \sqrt{\frac{Q}{L + L_t}} \quad (\text{see page 23})$$

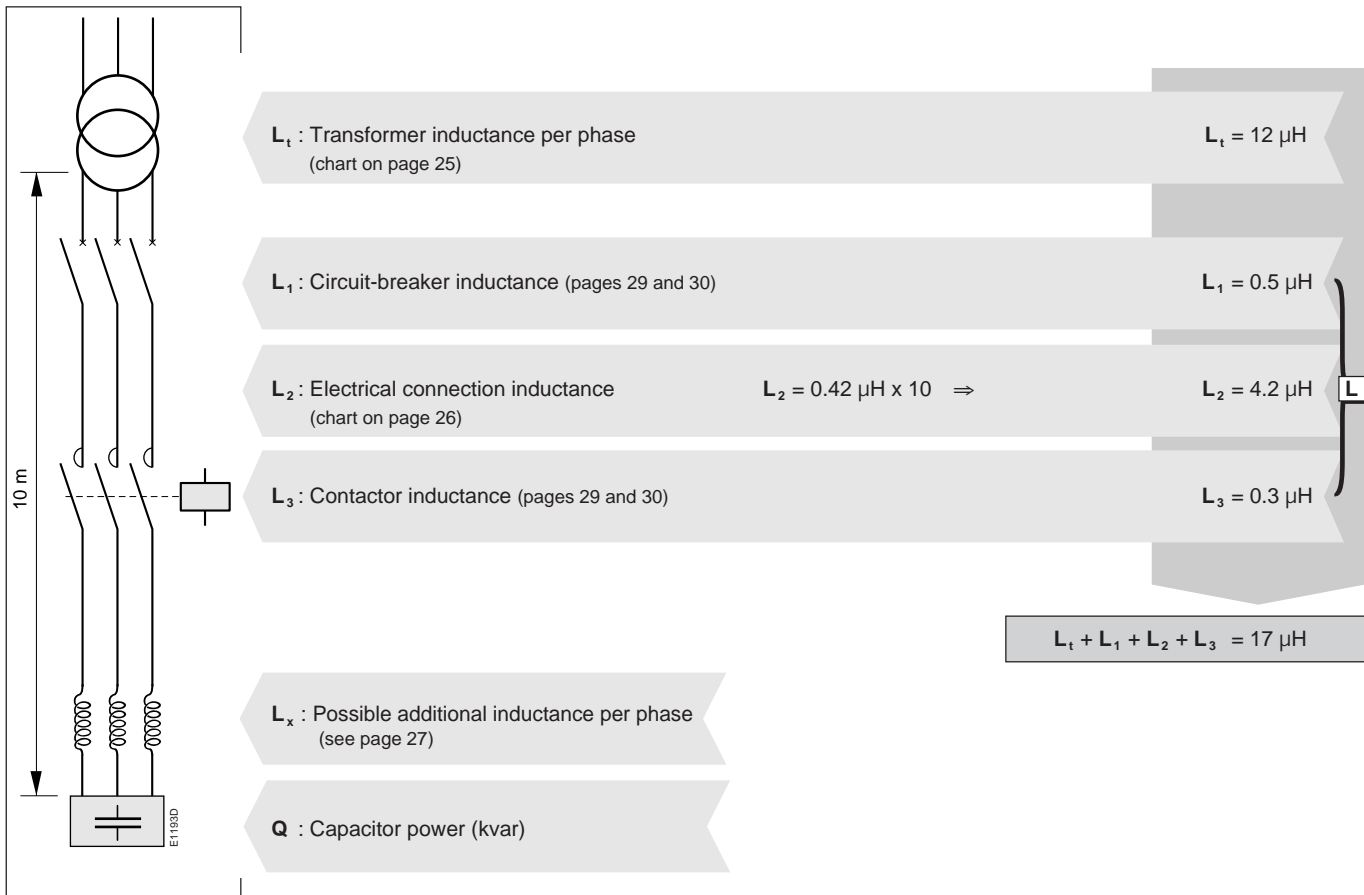

Selecting the contactor (pages 4-12-18)	Type (table on page 18)	A 12
Look for L_m (chart on page 28)	Network minimum inductance	L_m = 21 µH

If $L_m \leq L_t + L_1 + L_2 + L_3 + \dots \Rightarrow$ No additional inductance L_x
 If $L_m > L_t + L_1 + L_2 + L_3 + \dots \Rightarrow$ Add an additional inductance L_x such that: $L_x \geq L_m - (L_t + L_1 + L_2 + L_3 + \dots)$
 $L_x \geq 21\text{ }\mu\text{H} - 17\text{ }\mu\text{H}$ thus $L_x \geq 4\text{ }\mu\text{H}$

L_x made up of 6 turns per phase of 4 mm² copper cable (as per chart on page 30) $\varnothing = 20\text{ c}$

If you want to remove or reduce L_x you can choose a contactor with a greater making capacity

If you choose an **A 16** contactor; the chart (on page 28) gives $L_m = 10\text{ }\mu\text{H}$ **Thus no additional inductance as $10 < 17\text{ }\mu\text{H}$**

Installation Studies

Three-phase Capacitor Bank with Several Steps of Identical Power.

Example:

Transformer.
630 kVA 400 V 50 Hz Short-circuit voltage $\chi = 4\%$

Capacitors: bank with 6 steps of 20 kvar

Connections:
transformer/ capacitors 10 m of adjacent cables $a_m = 4$ d
capacitors/ busbars: 0.50 m in delta 10 mm^2 $a_m = 4$ d

Temperature: $\theta = 40^\circ\text{C}$

$$\hat{I} = k_1 \frac{n-1}{n} \sqrt{\frac{Q_n}{L_n}} \quad (\text{see page 23})$$

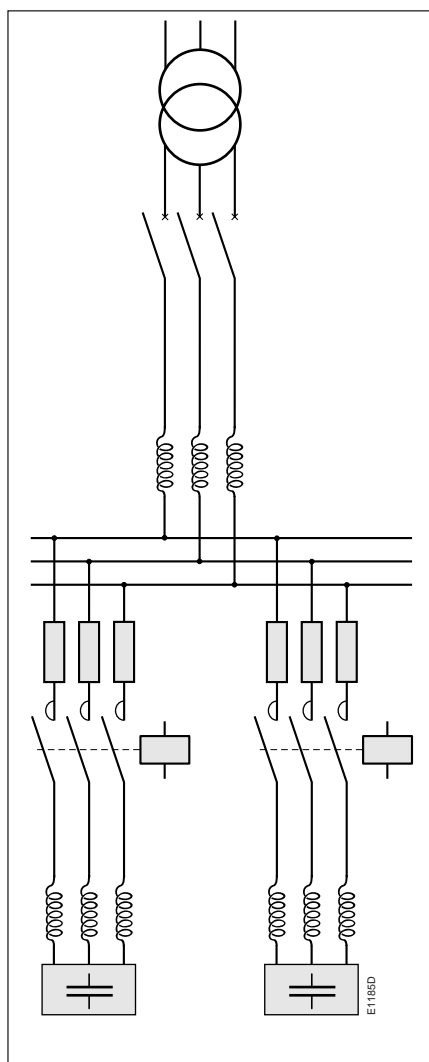

L_t : Transformer inductance per phase (chart on page 25)		$L_t = 30 \mu\text{H}$
L_1 : Circuit-breaker inductance (pages 29 and 30)		$L_1 = 0.5 \mu\text{H}$
L_2 : Connection inductance: transformer/capacitor bank by phase (chart on page 26)	$L_2 = 0.47 \mu\text{H} \times 10 \Rightarrow$	$L_2 = 4.7 \mu\text{H}$
L_x : Additional inductance, if necessary, per phase (value 0 for this example). If L_x other than 0, reduce by the same amount the value of the additional inductance L_y below.		
L_3 : Connection inductance: busbar/capacitor, per phase (chart on page 26)	$L_3 = 0.47 \mu\text{H} \times 0.5 \Rightarrow$	$L_3 = 0.24 \mu\text{H}$
L_4 : Fuse inductance (pages 29 and 30)		$L_4 = 0.4 \mu\text{H}$
L_5 : Contactor inductance (pages 29 and 30)		$L_5 = 0.3 \mu\text{H}$
$L_n = L_3 + L_4 + L_5$		$= 0.94 \mu\text{H}$
L_y : Additional inductance, if necessary, per phase and per step (page 27)		
Q : Capacitor power (kvar) (n identical steps)		

Selecting the contactor (pages 4-12-18)	Type (table page 12)	UA 26
Look for L_m (chart on page 28)	Network minimum inductance	$L_m = 3.2 \mu\text{H}$
If $L_m \leq L_3 + L_4 + L_5 + \dots \Rightarrow$	No additional inductance L_y	
If $L_m > L_3 + L_4 + L_5 + \dots \Rightarrow$	Add an additional inductance L_y	$L_y = 3.2 \mu\text{H} - 0.94 \mu\text{H} = 2.26 \mu\text{H}$
L_y made up of 3 turns per phase of 10 mm^2 copper cable (as per chart on page 30) $\varnothing = 20$ c		
If you want to eliminate or reduce L_y you can choose a contactor with a higher making capacity.		
If you choose an UA75 contactor; the chart (page 28) gives $L_m = 0.85 \mu\text{H}$ Thus no additional inductances as $0.85 < 0.94 \mu\text{H}$		

The upstream inductance value $L_t + L_1 + L_2 = 35.2 \mu\text{H}$ makes the addition of additional inductances L_x pointless.

Installation Studies

Three-phase Capacitor Bank with Several Steps of Different Powers.

Example:

Transformer.

400 kVA 400 V 50 Hz Short-circuit voltage $\chi = 4\%$

Capacitors: bank with 3 steps of: 20 kvar, 30 kvar, 50 kvar

Connections:

transformer/busbars: 10 m of adjacent cables $a_m = 4$ d

busbars/capacitors: 1 m $a_m = 4$ d

Temperature: $\theta = 40^\circ\text{C}$

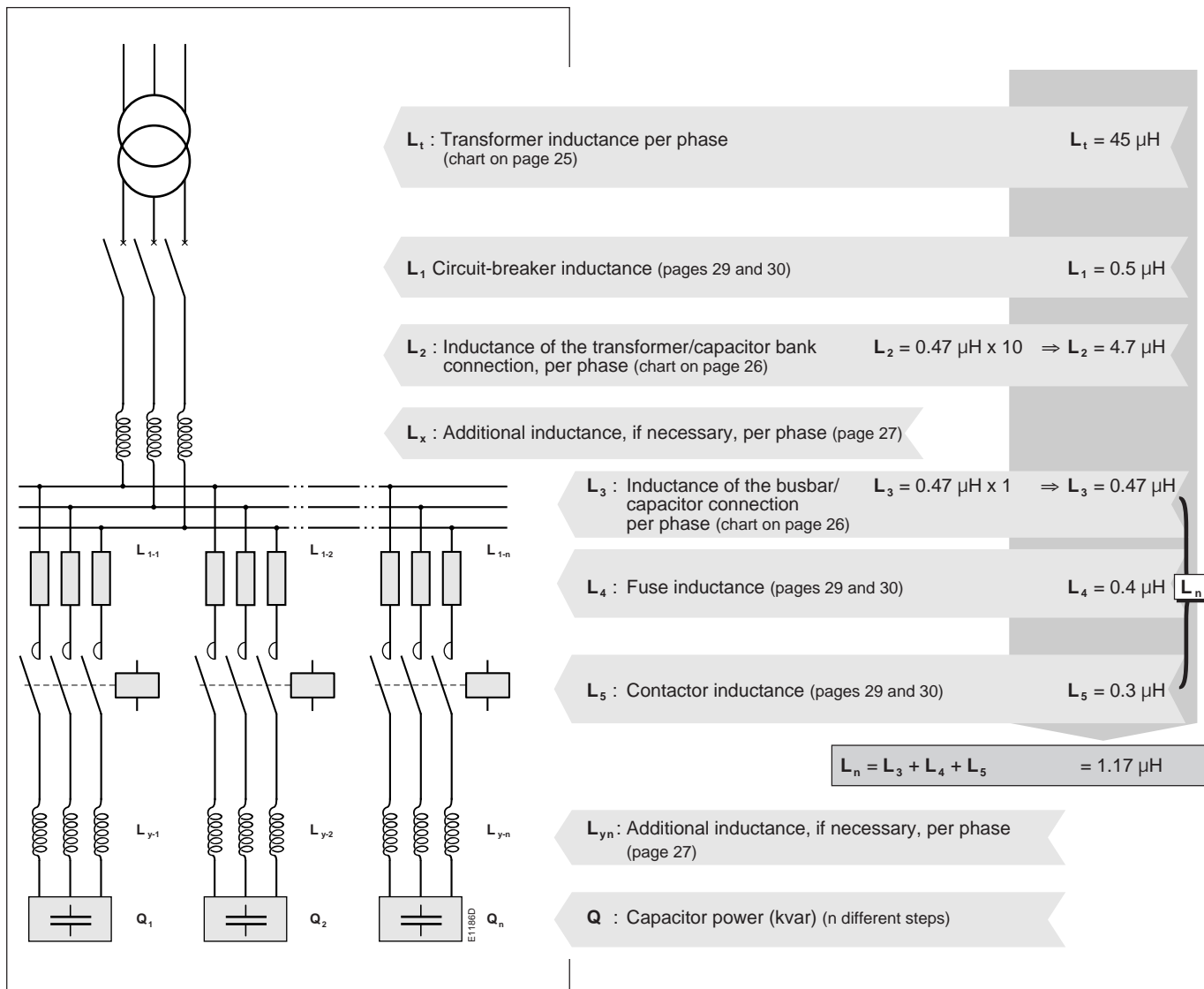

Preselection of contactors (tables on pages 4-12-18)

Type	Smallest step: 20 kvar	⇒	UA 26
(table on page 12)	Step with intermediate power: 30 kvar	⇒	UA 50
	Most powerful step: 50 kvar	⇒	UA 75

Installation Studies

Determining any self-inductances L_y .

Calculate the minimum inductance of the connection of each step, as though the bank were made up of n_p steps of identical power Q_p to that being analysed.

$$n_p = \frac{Q_1 + Q_2 + Q_3 + Q_{\dots} + Q_p + Q_{\dots} + Q_n}{Q_p}$$

Example : $n_1 = \frac{\text{Bank total power}}{\text{Power of smallest step}}$

Smallest step: 20 kvar

Fictitious number of steps: $n_1 = \frac{20 + 30 + 50}{20} = 5$

Preselected **UA 26** contactor (table on page 12)

Minimum inductance for 5 steps of **20 kvar** (chart on page 28): $L_1 = 3 \mu\text{H}$

Additional inductance $L_{y1} = L_1 - L_n$

$L_{y1} = 3 - 1.17 = 1.83 \Rightarrow$ **Additional inductance of 1.83 μH**

The inductances of the other connections must have as their minimum value the one satisfying **the most restrictive** of the 2 requirements below:

Requirement no. 1: Be at least inversely proportional to the powers of each capacitor step, i.e. $L_n \text{ mini} = L_1 \frac{Q_1}{Q_n}$.

Requirement no. 2: Be compatible with the contactor used (chart on page 28).

Step of intermediate power: 30 kvar

Fictitious number of steps: $n_2 = \frac{20 + 30 + 50}{30} \# 3$

Requirement no. 1: $L_{2 \text{ min.}} = L_1 \frac{Q_1}{Q_2} = 3 \times \frac{20}{30} = 2 \mu\text{H}$.

Requirement no. 2: Preselected **UA 50** contactor (table on page 12)

Minimum inductance for 3 steps of **30 kvar** (chart on page 28): **1.1 μH** .

The most restrictive requirement is $L_{2 \text{ min.}} = 2 \mu\text{H}$.

Thus, an additional inductance is required

$L_{y2} = 2 \mu\text{H} - 1.17 \mu\text{H} = 0.83 \mu\text{H}$

Most powerful step: 50 kvar

Fictitious number of steps: $n_3 = \frac{20 + 30 + 50}{50} = 2$

Requirement no. 1: $L_{3 \text{ min.}} = L_1 \frac{Q_1}{Q_3} = 3 \times \frac{20}{50} = 1.2 \mu\text{H}$.

Requirement no. 2: Preselected **UA 75** contactor (table on page 12)

Minimum inductance for 2 steps of **50 kvar** (chart on page 28): **0.7 μH** .

The most restrictive requirement is $L_{3 \text{ min.}} = 1.2 \mu\text{H}$.

The value of the connection inductance, 1.17 μH , is very close to 1.2 μH , there is thus **no point providing an additional inductance: $L_{y3} = 0$**

The upstream inductance value $L_1 + L_{y1} + L_{y2} = 50 \mu\text{H}$ makes the addition of additional inductances L_x pointless.

We could choose all contactors of the same size: the largest preselected rating (UA 75 in our example).

The result would be:

20 kvar step: $n_1 = 5$ \Rightarrow Chart page 28: $L_{1 \text{ min.}} = 0.8 \mu\text{H}$ $\Rightarrow L_n = 1.17 \mu\text{H}$ is greater than L_1 thus $L_{y1} = 0$

30 kvar step: $n_2 = 3$ \Rightarrow Chart on page 28: $L_{2 \text{ min.}} = 0.8 \mu\text{H}$

Checking the other requirement: $L_{2 \text{ min.}} = L_1 \frac{Q_1}{Q_2} = 0.8 \times \frac{20}{30} = 0.53 \mu\text{H}$

The most restrictive requirement is $L_{2 \text{ min.}} = 0.8 \mu\text{H}$ $\Rightarrow L_n = 1.17 \mu\text{H}$ is greater than L_2 thus $L_{y2} = 0$

50 kvar step: $n_3 = 2$ \Rightarrow Chart on page 28: $L_{3 \text{ min.}} = 0.78 \mu\text{H}$

Checking the other requirement: $L_{2 \text{ min.}} = L_1 \frac{Q_1}{Q_3} = 0.8 \times \frac{20}{50} = 0.32 \mu\text{H}$

The most restrictive requirement is $L_{2 \text{ min.}} = 0.78 \mu\text{H}$ $\Rightarrow L_n = 1.17 \mu\text{H}$ is greater than L_3 thus $L_{y3} = 0$

Advantage: this choice means that inductances are not to be added.



Contact us

ABB France
Low Voltage Products Division
10, rue Ampère Z.I. - B.P. 114
F-69685 Chassieu cedex / France

ABB AB/ Cewe-Control
Motorgränd 20
S-721 61 Västerås / Sweden

You can find the address of your local sales organisation
on the ABB home page
<http://www.abb.com/contacts> -> Low Voltage products

Note

We reserve the right to make technical changes or modify the contents of this document without prior notice. With regard to purchase orders, the agreed particulars shall prevail. ABB does not accept any responsibility whatsoever for potential errors or possible lack of information in this document.

We reserve all rights in this document and in the subject matter and illustrations contained therein. Any reproduction, disclosure to third parties or utilization of its contents – in whole or in parts – is forbidden without prior written consent of ABB.

Copyright© 2009 ABB
All rights reserved



X-ON Electronics

Largest Supplier of Electrical and Electronic Components

Click to view similar products for [Contactors - Electromechanical category](#):

Click to view products by [ABB manufacturer](#):

Other Similar products are found below :

[6-1618400-7](#) [686-117111](#) [686-120111](#) [686-924](#) [686-948](#) [70-901](#) [70-914](#) [MB-3D-6](#) [MC-22A/4-AC120V](#) [8-1616943-9](#) [8-1672124-5](#)
[A40-30-10-84](#) [120-905](#) [A701U](#) [120-904](#) [1393132-9](#) [154-905](#) [154-912](#) [154-913](#) [154-915](#) [154-902](#) [154-910](#) [AVR743D](#) [B6-40-00-84](#) [B7-40-00-84](#) [1616017-5](#) [1616021-1](#) [MVDILM](#) [HP-11D-24](#) [P25-E5019-1](#) [P30C47A12D1-120](#) [P40C47A12D1-120](#) [P40P47D13P1-24-01](#) [CA7-12-10-240](#) [CA7-72-00-24Z](#) [90-162](#) [9-1393132-2](#) [2NC4F0222](#) [A275KXXV2-120VAC](#) [ACC338UMM20](#) [AF80-30-11-13](#) [SZ-B1](#) [CGC-9A-120](#) [3GC2H0M22](#) [3NC0T0A22](#) [3NC1Q0A22](#) [3NC2H0A22](#) [3NC2T0122/SE](#) [3TF3400-0BB4](#) [MC-12B-DC24V](#)