



Catalog | 2013

System pro *E* comfort MISTRAL65

Transparency, depth, space

Index

A point of reference. For simplicity and effectiveness	2
A point of arrival. For functions and applications	4
A point of view. Never seen before	6
A point of contact with the world of ABB	8
A point of departure for made-to-measure solutions	10
Order codes	12
Terminal blocks	21
Technical details	22
Upper and lower knockouts	25
Overall dimensions	26
List of quick reference codes	29

A point of reference. For simplicity and effectiveness A complete series, versatile and easy to install

Efficiency, safety, integration: the new System pro *E* comfort MISTRAL65 series rests on the strengths which have consolidated ABB's image over the years for its expertise and reliability in the area of products for protection, control, monitoring, measurement, safety and energy efficiency. These innovative IP65 rated consumer units complete ABB's wide product range for the industrial sector, but also the range for the commercial and residential sectors, in which ABB is represented in the market with the Élos and Chiara ranges of cabling accessories, the integrated Mylos system for home and building automation, the 2Line Musa & Zenith intercom and video intercom systems, and the wireless home automation system DomusTech.

The result of constant research and constant attention paid to technological development, the System pro *E* comfort MISTRAL65 series consumer units are designed to satisfy all requirements electrical installers might have.



The new range of System pro *E* comfort MISTRAL65 consumer units allows almost any type of electrical distribution system to be implemented in industrial, commercial and residential environments. The consumer units are manufactured in a halogen-free thermoplastic which is completely recyclable. The range includes solutions with transparent or opaque doors which open up to 180°, and a choice of between 4 and 72 modules, meeting the most recent regulatory requirements and ensuring an enormous variety of application types are covered. The refined design is marked by some particular characteristics, for example the perfect symmetry, which allows either the whole consumer unit or just the front panel to be rotated, easily changing the door opening side.

In the multi-row versions, the centre distance of the DIN rails can be varied from 150 mm to 125 mm, further increasing the versatility of the product and using the same standard accessories.

The frame is extractable for quick and easy bench cabling. The ample internal space makes the cables more accessible, facilitating cabling and giving the possibility to anchor the cable-ties to special eyeholes on the frame.

The consumer units are designed to house optional dedicated terminal blocks in two different colour schemes to allow quick and tidy cabling, and making separate power supplies easily recognisable, when used.

The range is completely coordinated with ABB MCBs and MCCBs, all of which can be easily installed simply by moving the rail provided for their housing.

The project design also aimed to optimise cabling, assembly and installation times of the consumer units.

Everything has been designed to make the installer's job quicker and easier, allowing them to implement functional and tidy switchboards.



Innovating today does not just mean looking for functional and technologically advanced solutions. For ABB, being innovative means embracing a longer-term perspective by using eco-compatible materials for our products which respect the environment even at the end of their life cycle. For this reason, 100% recyclable halogen-free thermoplastics have been used for the consumer units.

Their environmental compatibility has been assessed using the Life Cycle Assessment (LCA) method, an objective tool for analysing energy and environmental impact which analyses the energy and materials used and the emissions released during production.

A point of arrival. For functions and applications The benefits of a product range designed to last

The 180° door opening facilitates total accessibility to the interior of the consumer unit

The minimalistic simplicity of the new design combines technological reliability with the most innovative aesthetic trends

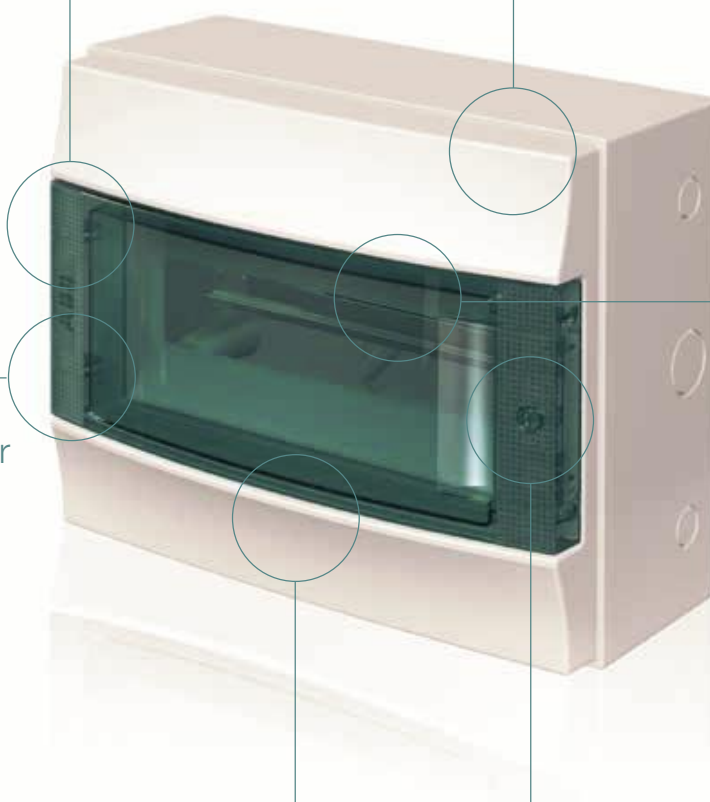

The decorative texture of the door underlines the attention to detail and the quality of the finish

The transparent door in the exclusive new petrol blue colour ensures an elegant and original look

The perfect symmetry of the front allows the opening to be completely reversed

The door has an ergonomic handle with snap-on closing or a lock (optional)

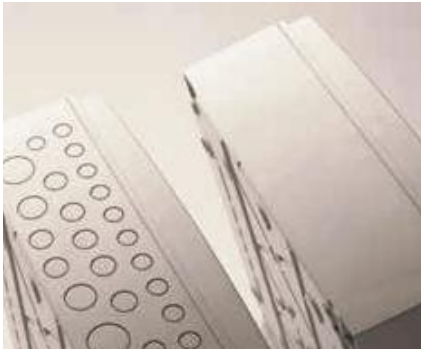

Aside from a series of side knockouts for cable entry and exit, the consumer units can be supplied, on request, with cable entries and exits both at the top and bottom.



Interior slots allow the consumer unit to be fixed to the wall in points which are not visible from the outside, thus contributing to an aesthetically clean installation. Special snap-in closure plugs guarantee protection class II (double insulated).



The possibility to add an additional module by removing two pre-trimmed elements is an extremely useful solution which allows additions to be managed easily and tidily when unforeseen installation requirements are called for.



To speed up cabling and make it neater, various snap-on terminal blocks can be installed (optional and in two different colours), both in the upper and the lower part of the consumer unit. The terminals come in two versions: screw and quick-coupling, for easy and effective cabling with any type of conductor.



The standard door with ergonomic handle and snap-on closure can be supplied with a lock and key on request, ensuring only authorised persons have access and avoiding tampering or incorrect operations.

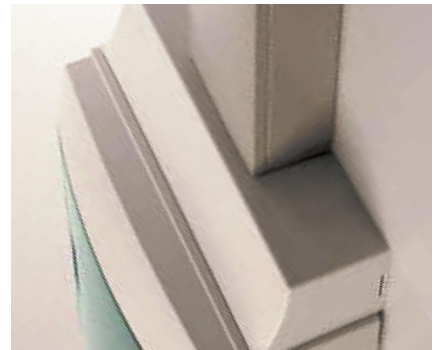

The new polycarbonate accessory for trunking entry can be positioned at the top or bottom of the consumer unit, connecting and protecting the conductor bundles. A series of internal knockouts allows it to house any type of trunking.

A point of view. Never seen before

The technical characteristics and installation possibilities

Practical rear brackets provide practical and stable wall fastening

Every front panel is supplied with captive screws, giving practical and safety advantages



The side knockouts offer additional possibilities for the cables' path

The dual gasket on the front panel module ensures an improved seal

All accessories and the slightest details have been designed and developed in order for the consumer unit to maintain double insulation properties at all times



The extractable frame simplifies and speeds up bench cabling operations. The slotted holes in the frame allow it to be quickly fixed inside the enclosure.

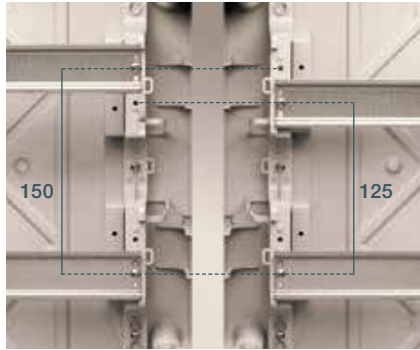

In order to create space at the top or bottom of the consumer unit, the centre distance of the DIN rails can be modified from the standard distance of 150 mm to 125 mm. The closure panels, which are completely reversible, can be unhooked, reversed and reinstalled with a simple click.



Spaces have been created inside the consumer units to make cabling even easier, with cable clips and holes for fastening the conductors to the frame with simple cable-ties.



If the consumer unit must be made completely inaccessible, it is possible to use accessories to seal the front panel.



The consumer units can be installed side by side, with cable gland accessories protecting the conductors' path between adjacent units.



The accessories include blind panels and base plates allowing installation of other types of devices aside from modular DIN rail products such as contactors, manual motor starters or devices on the front of the panel.

A point of contact with the world of ABB Perfect coordination with all products

The project was inspired by the objective of allowing a wide range of products and solutions with different functions and dimensions to be installed in a single IP65 consumer unit, thus meeting the widest range of needs.

MCBs, MCCBs and devices installed in the front of the panel in an integrated, rational and functionally appropriate position.





The frame allows for two different DIN rail positions. This allows products with different depths to be installed, for example MCCBs which, thanks to this solution, are perfectly aligned with other devices in the panel.

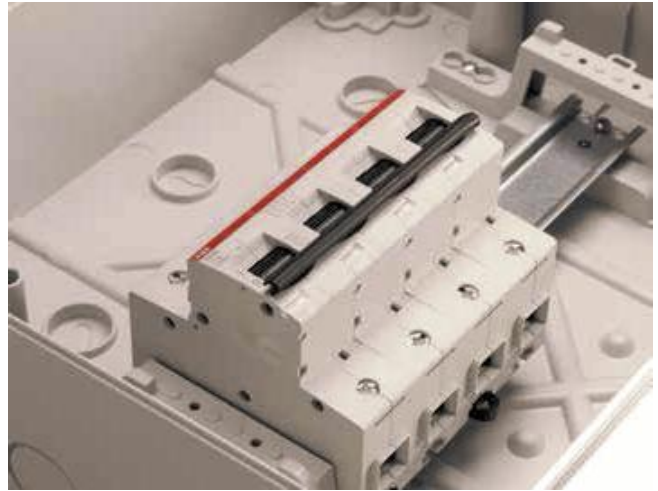

Among these components with greater depth dimensions which can benefit from this flexibility of the frame, we must remember high-performance MCBs with greater than standard depth.

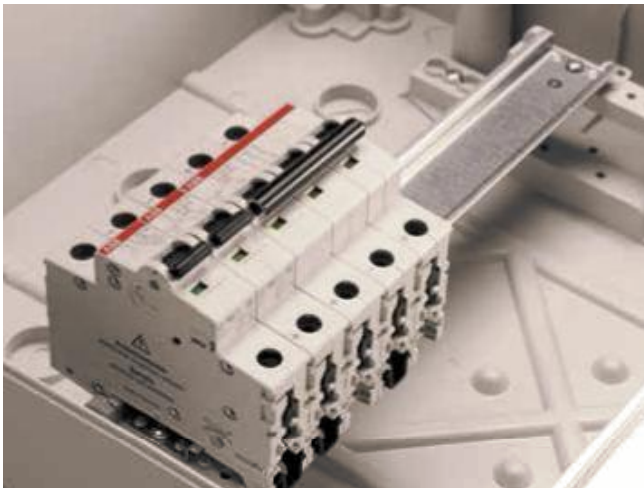

The first depth level allows standard products to be housed; these include most modular products currently available on the market.



Among the accessories, the availability of blank panels and base plates allows non-modular equipment to be installed on the front of the consumer unit, such as control buttons and indicator lights.

A point of departure for made-to-measure solutions The flexibility of a range designed for every application

The simplicity of the consumer units makes adapting them to various system requirements easy.

Optional terminal blocks which can be installed in the top or bottom of the consumer unit allow the cabling to be performed in a tidy manner and their different colours facilitate recognition of any separate circuits.

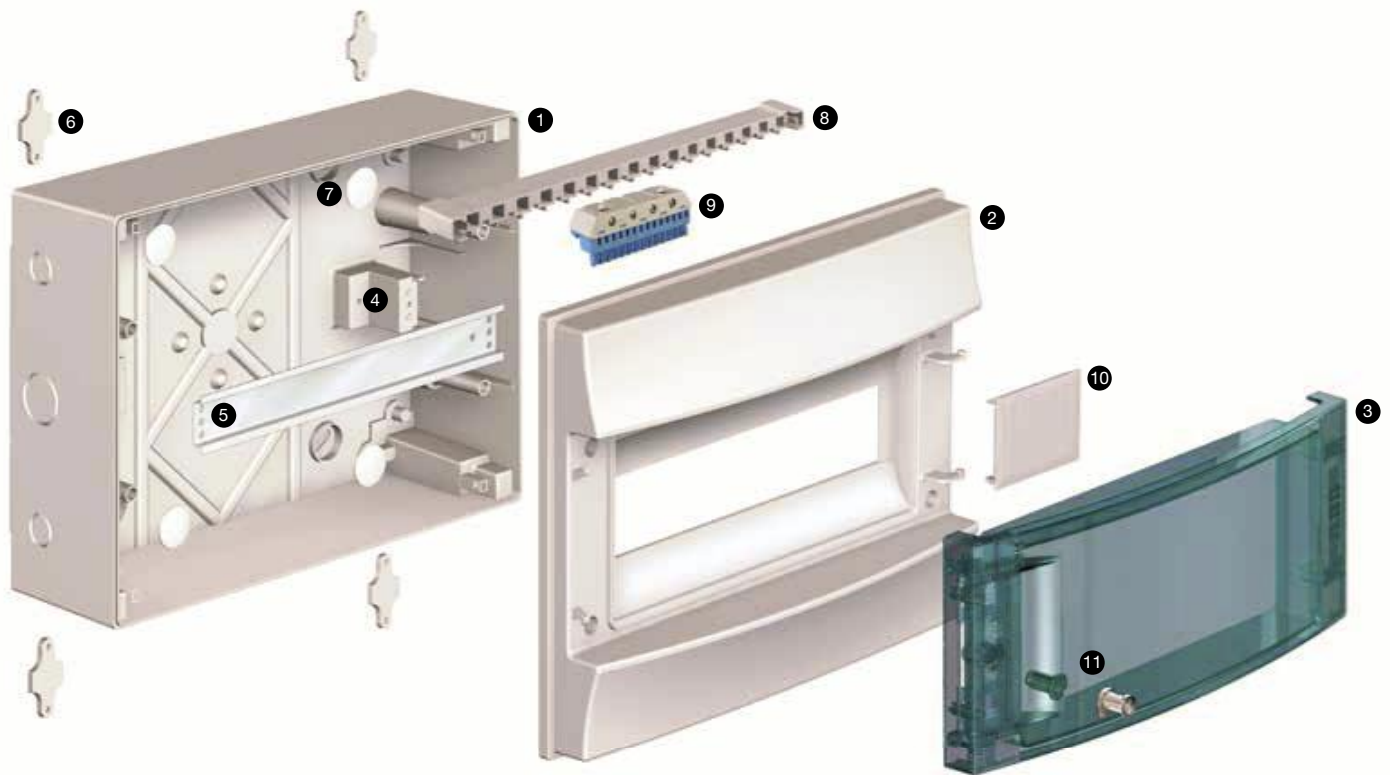

- | | |
|-------------------------------|---|
| 1. Box for wall mounting | 7. Plugs, protection class II |
| 2. Reversible front panel | 8. Jumper for terminals |
| 3. Transparent door | 9. Quick-coupling terminals |
| 4. Fixed support for DIN rail | 10. Module cover |
| 5. DIN rail | 11. Finish or closure elements
(lock and key optional) |
| 6. Wall fastening brackets | |

The perfectly symmetrical design of the front panel makes the choice of opening direction for the door simple – this can be changed just by rotating the whole structure, without having to perform risky separation of parts. The extractable doors also facilitate access to the various components installed in the consumer unit.

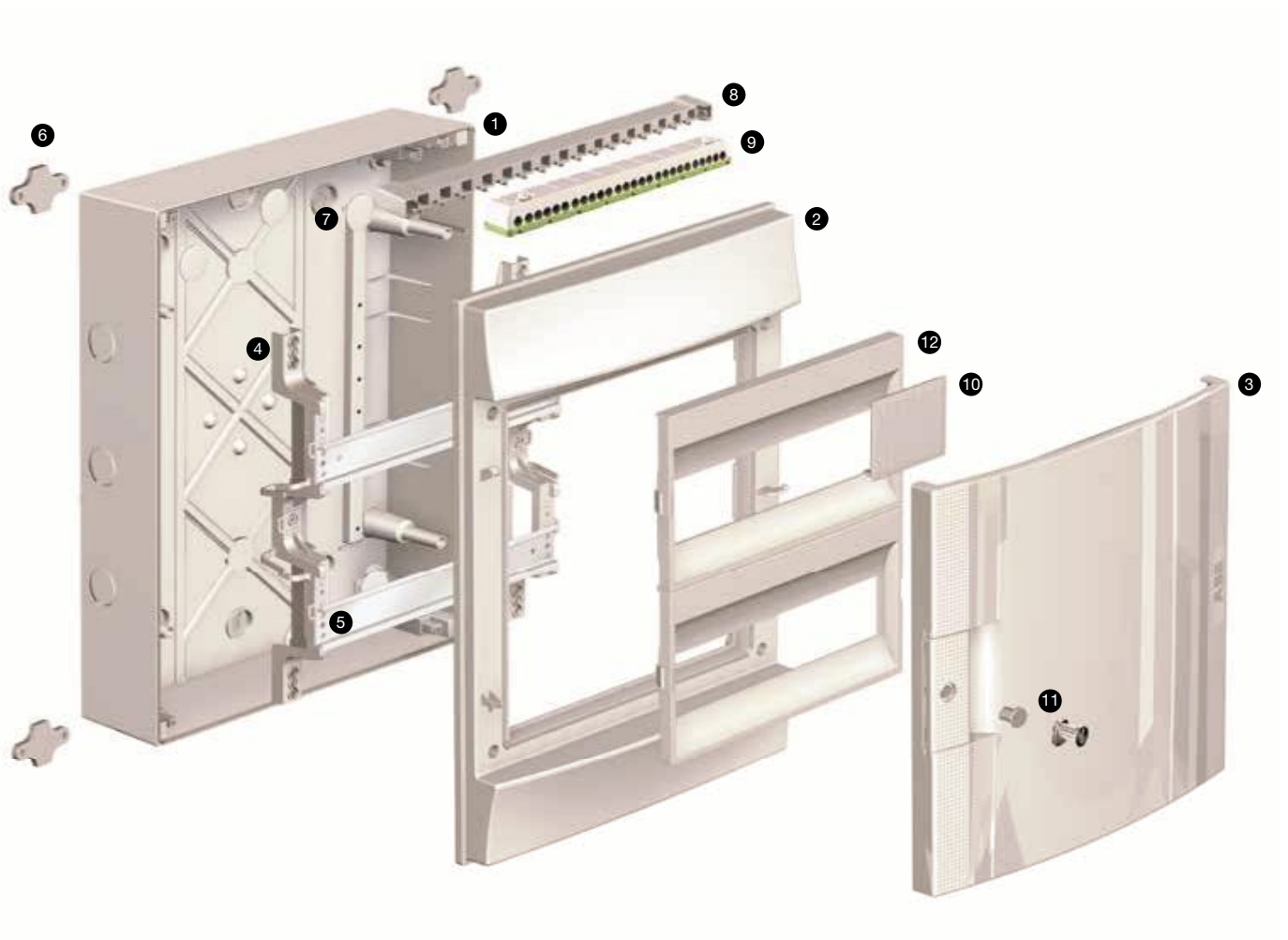

- | | |
|-------------------------------|---|
| 1. Box for wall mounting | 8. Jumper for terminals |
| 2. Reversible front panel | 9. Quick-coupling terminals |
| 3. RAL 7035 opaque door | 10. Module cover |
| 4. Fixed support for DIN rail | 11. Finish or closure elements
(lock and key optional) |
| 5. DIN rail | 12. Reversible panels |
| 6. Wall fastening brackets | |
| 7. Plugs, protection class II | |

Order codes



4 modules



8 modules



12 modules



18 modules

Description	GWT	N. modules [18 mm]	Dimensions WxHxD [mm]	ABB code	Order code	Pack./ N. pieces
1 Row						
Consumer units MISTRAL65 opaque door 4M	650	4	152x202x117	1SL1100A00	1SL1100A00	1/24
Consumer units MISTRAL65 transparent door 4M	650	4	152x202x117	1SL1200A00	1SL1200A00	1/24
Consumer units MISTRAL65 opaque door 8M	650	8	232x250x154	1SL1101A00	1SL1101A00	1/11
Consumer units MISTRAL65 transparent door 8M	650	8	232x250x154	1SL1201A00	1SL1201A00	1/11
Consumer units MISTRAL65 opaque door 12M	650	12	320x250x155	1SL1102A00	1SL1102A00	1/7
Consumer units MISTRAL65 transparent door 12M	650	12	320x250x155	1SL1202A00	1SL1202A00	1/7
Consumer units MISTRAL65 opaque door 18M	650	18	430x250x155	1SL1103A00	1SL1103A00	1/4
Consumer units MISTRAL65 transparent door 18M	650	18	430x250x155	1SL1203A00	1SL1203A00	1/4



24 modules



36 modules

Description	GWT	N. modules [18 mm]	Dimensions WxHxD [mm]	ABB code	Order code	Pack./ N. pieces
2 Rows						
Consumer units MISTRAL65 opaque door 24M	650	24	320x435x155	1SL1104A00	1SL1104A00	1/4
Consumer units MISTRAL65 transparent door 24M	650	24	320x435x155	1SL1204A00	1SL1204A00	1/4
Consumer units MISTRAL65 opaque door 36M 2F	650	36	430x435x155	1SL1105A00	1SL1105A00	1/2
Consumer units MISTRAL65 transparent door 36M 2F	650	36	430x435x155	1SL1205A00	1SL1205A00	1/2



36 modules



54 modules



48 modules



72 modules

Description	GWT	N. modules	Dimensions WxHxD	ABB code	Order code	Pack./ N. pieces
		[18 mm]				
3 Rows						
Consumer units MISTRAL65 opaque door 36M 3F	650	36	320x600x155	1SL1106A00	1SL1106A00	1/3
Consumer units MISTRAL65 transparent door 36M 3F	650	36	320x600x155	1SL1206A00	1SL1206A00	1/3

Consumer units MISTRAL65 opaque door 54M	650	54	430x600x155	1SL1108A00	1SL1108A00	1/1
Consumer units MISTRAL65 transparent door 54M	650	54	430x600x155	1SL1208A00	1SL1208A00	1/1

Description	GWT	N. modules	Dimensions WxHxD	ABB code	Order code	Pack./ N. pieces
		[18 mm]				
4 Rows						
Consumer units MISTRAL65 opaque door 48M	650	48	320x735x155	1SL1107A00	1SL1107A00	1/1
Consumer units MISTRAL65 transparent door 48M	650	48	320x735x155	1SL1207A00	1SL1207A00	1/1

Consumer units MISTRAL65 opaque door 72M	650	72	430x735x155	1SL1109A00	1SL1109A00	1/1
Consumer units MISTRAL65 transparent door 72M	650	72	430x735x155	1SL1209A00	1SL1209A00	1/1

Order codes



801002F0901

4 modules



801004F0901

8 modules



801006F0901

12 modules



801008F0901

18 modules

Description	GWT	N. modules [18 mm]	Dimensions WxHxD [mm]	ABB code	Order code	Pack./ N. pieces
1 Row						
Consumer units MISTRAL65 750 transparent door 4M	750	4	152x202x117	1SLM006500A1210	1SL1210A00	1/24
Consumer units MISTRAL65 750 transparent door 8M	750	8	232x250x154	1SLM006500A1211	1SL1211A00	1/11
Consumer units MISTRAL65 750 transparent door 12M	750	12	320x250x155	1SLM006500A1212	1SL1212A00	1/7
Consumer units MISTRAL65 750 transparent door 18M	750	18	430x250x155	1SLM006500A1213	1SL1213A00	1/4



801010F0901

24 modules



801012F0901

36 modules

Description	GWT	N. modules [18 mm]	Dimensions WxHxD [mm]	ABB code	Order code	Pack./ N. pieces
2 Rows						
Consumer units MISTRAL65 750 transparent door 24M	750	24	320x435x155	1SLM006500A1214	1SL1214A00	1/4
Consumer units MISTRAL65 750 transparent door 36M 2F	750	36	430x435x155	1SLM006500A1215	1SL1215A00	1/2



801014FC001

36 modules



801016FC001

54 modules

Description	GWT	N. modules [18 mm]	Dimensions WxHxD [mm]	ABB code	Order code	Pack./ N. pieces
3 Rows						
Consumer units MISTRAL65 750 transparent door 36M 3F	750	36	320x600x155	1SLM006500A1216	1SL1216A00	1/3

Consumer units MISTRAL65 750 transparent door 54M	750	54	430x600x155	1SLM006500A1218	1SL1218A00	1/1
--	-----	----	-------------	-----------------	------------	-----

Description	GWT	N. modules [18 mm]	Dimensions WxHxD [mm]	ABB code	Order code	Pack./ N. pieces
4 Rows						
Consumer units MISTRAL65 750 transparent door 48M	750	48	320x735x155	1SLM006500A1217	1SL1217A00	1/1



801018FC001

48 modules



801023FC001

72 modules

Consumer units MISTRAL65 750 transparent door 72M	750	72	430x735x155	1SLM006500A1219	1SL1219A00	1/1
--	-----	----	-------------	-----------------	------------	-----

Order codes



Description	GWT	N. modules	Dimensions	ABB code	Order code	Pack./ N. pieces
			WxHxD			
			[18 mm] : [mm]			
MISTRAL65 transparent door 8M 12SM	650	8	232x250x154	1SLM006501A1201	1SLM006501A1201	1/11

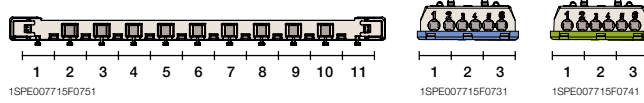

MISTRAL65 transparent door 12M 22SM	650	12	320x250x155	1SLM006501A1202	1SLM006501A1202	1/7
-------------------------------------	-----	----	-------------	-----------------	-----------------	-----

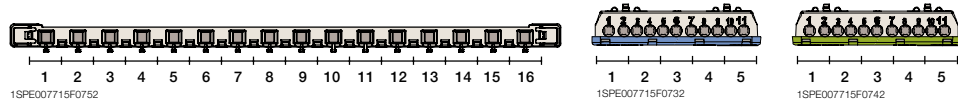

MISTRAL65 transparent door 18M 12SM	650	18	430x250x155	1SLM006501A1203	1SLM006501A1203	1/4
-------------------------------------	-----	----	-------------	-----------------	-----------------	-----

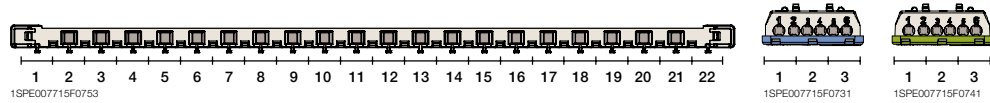

MISTRAL65 transparent door 18M 32SM	650	18	430x250x155	1SLM006502A1203	1SLM006502A1203	1/4
-------------------------------------	-----	----	-------------	-----------------	-----------------	-----

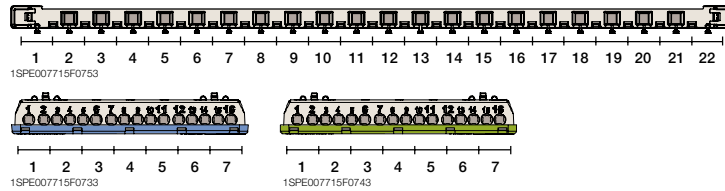

MISTRAL65 transparent door 24M 22SM	650	24	320x435x155	1SLM006501A1204	1SLM006501A1204	1/4
-------------------------------------	-----	----	-------------	-----------------	-----------------	-----

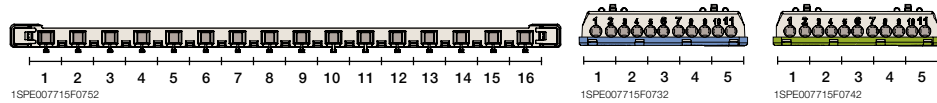

MISTRAL65 transparent door 24M 42SM	650	24	320x435x155	1SLM006502A1204	1SLM006502A1204	1/4
-------------------------------------	-----	----	-------------	-----------------	-----------------	-----

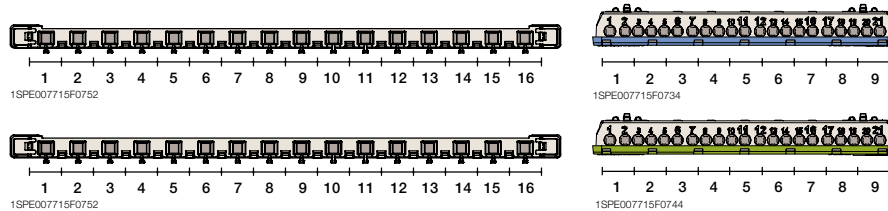



801012F0901

36 modules

Description	GWT	N. modules	Dimensions WxHxD	ABB code	Order code	Pack./ N. pieces
		[18 mm]	[mm]			
MISTRAL65 transparent door 36M 2F 52SM	650	36	430x435x155	1SLM006501A1205	1SLM006501A1205	1/2

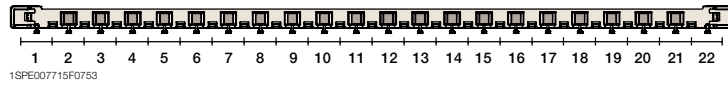

1SPE007715F0753

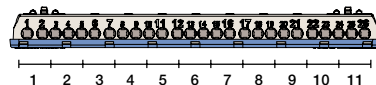

1SPE007715F0735

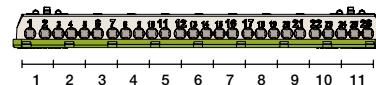

1SPE007715F0745



801014F0901

36 modules

MISTRAL65 transparent door 36M 3F 42SM	650	36	320x600x155	1SLM006501A1206	1SLM006501A1206	1/3
--	-----	----	-------------	-----------------	-----------------	-----

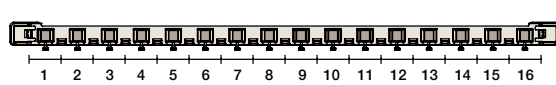

1SPE007715F0752

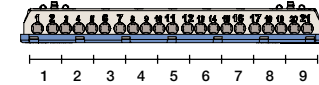

1SPE007715F0734

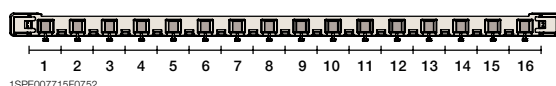

1SPE007715F0752

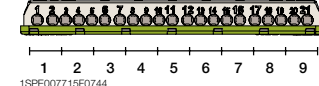

1SPE007715F0744



801018F0901

48 modules

MISTRAL65 transparent door 48M 52SM	650	48	320x735x155	1SLM006501A1207	1SLM006501A1207	1/1
-------------------------------------	-----	----	-------------	-----------------	-----------------	-----

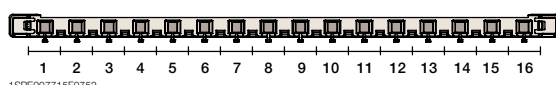

1SPE007715F0752

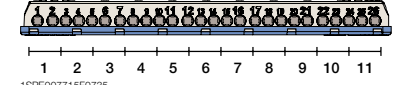

1SPE007715F0735

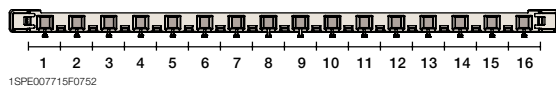

1SPE007715F0752

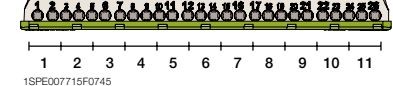

1SPE007715F0745



801016F0901

54 modules

MISTRAL65 transparent door 54M 52SM	650	54	430x600x155	1SLM006501A1208	1SLM006501A1208	1/1
-------------------------------------	-----	----	-------------	-----------------	-----------------	-----

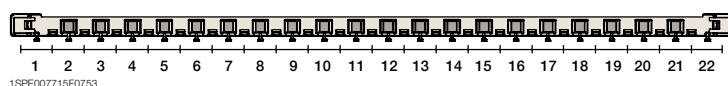

1SPE007715F0753

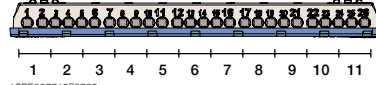

1SPE007715F0735

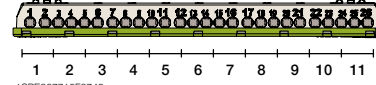

1SPE007715F0745



801022F0901

72 modules

MISTRAL65 transparent door 72M 52SM	650	72	430x735x155	1SLM006501A1209	1SLM006501A1209	1/1
-------------------------------------	-----	----	-------------	-----------------	-----------------	-----

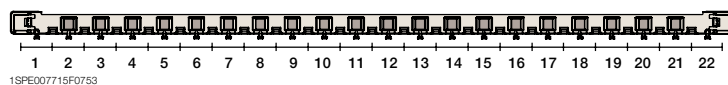

1SPE007715F0753

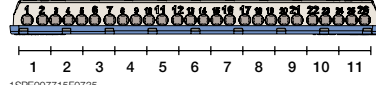

1SPE007715F0735

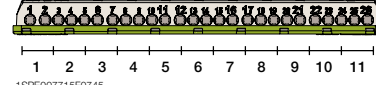

1SPE007715F0745

Order codes



801021F0901

Opaque door



801022F0901

Transparent door



801023F0901

Base plates



801024F0901

Blind panel

Description	ABB code	Order code	Pack./ N. pieces
Opaque door			
Opaque door 4M MISTRAL65	1SLM006500A1900	1SL1900A00	1/15
Opaque door 8M MISTRAL65	1SLM006500A1902	1SL1902A00	1/20
Opaque door 12M MISTRAL65	1SLM006500A1904	1SL1904A00	1/10
Opaque door 18M MISTRAL65	1SLM006500A1906	1SL1906A00	1/20
Opaque door 24M / 48M MISTRAL65	1SLM006500A1908	1SL1908A00	1/6
Opaque door 36M MISTRAL65	1SLM006500A1910	1SL1910A00	1/10
Opaque door 36M / 72M MISTRAL65	1SLM006500A1912	1SL1912A00	1/14
Opaque door 54M MISTRAL65	1SLM006500A1914	1SL1914A00	1/8
Transparent door			
Transparent door 4M MISTRAL65	1SLM006500A1901	1SL1901A00	1/15
Transparent door 8M MISTRAL65	1SLM006500A1903	1SL1903A00	1/20
Transparent door 12M MISTRAL65	1SLM006500A1905	1SL1905A00	1/10
Transparent door 18M MISTRAL65	1SLM006500A1907	1SL1907A00	1/20
Transparent door 24M / 48M MISTRAL65	1SLM006500A1909	1SL1909A00	1/6
Transparent door 36M MISTRAL65	1SLM006500A1911	1SL1911A00	1/10
Transparent door 36M / 72M MISTRAL65	1SLM006500A1913	1SL1913A00	1/14
Transparent door 54M MISTRAL65	1SLM006500A1915	1SL1915A00	1/8
Base plates			
Metal base plate 12M MISTRAL65	1SLM006500A1920	1SL1920A00	1/12
Metal base plate 2x12M MISTRAL65	1SLM006500A1921	1SL1921A00	1/4
Metal base plate 18M MISTRAL65	1SLM006500A1922	1SL1922A00	1/8
Metal base plate 2x18M MISTRAL65	1SLM006500A1923	1SL1923A00	1/4
Blind panel			
Central blind panel 12M MISTRAL65 *	1SLM006500A1945	1SL1945A00	1/15
Blind panel 12M MISTRAL65	1SLM006500A1946	1SL1946A00	1/20
Central blind panel 18M MISTRAL65 **	1SLM006500A1947	1SL1947A00	1/30
Blind panel 18M MISTRAL65	1SLM006500A1948	1SL1948A00	1/30

* Pannelli per centralino MISTRAL da 3 file - 36 moduli

** Pannelli per centralino MISTRAL da 3 file - 54 moduli



801025F0901

Wall fixing bracket



801028F0901

Module cover



801027F0901

Lock



801028F0901

Cable gland



801029F0901

Adapter for trunking



801030F0901

Junction unit



801031F0901

Terminal carrier

Description	ABB code	Order code	Pack./ N. pieces
Other accessories			
Wall fixing brackets (4 pcs) MISTRAL65	1SLM006500A1927	1SL1927A00	1/30
Module cover 12M MISTRAL65	1SLM006500A1929	1SL1929A00	5/180
Sealing kit MISTRAL65	1SLM006500A1950	1SL1950A00	1/50
Lock with key MISTRAL65	1SLM006500A1931	1SL1931A00	1/10
Cable glands			
Cable gland Ø 16	1SLM006500A1935	1SL1935A00	10/100
Cable gland Ø 20	1SLM006500A1936	1SL1936A00	10/100
Cable gland Ø 25	1SLM006500A1937	1SL1937A00	10/100
Cable gland Ø 32	1SLM006500A1938	1SL1938A00	5/50
Adapter			
Adapter for trunking MISTRAL65	1SLM006500A1942	1SL1942A00	1/10
Junction unit			
Junction unit Ø 28,5 MISTRAL65	1SLM006500A1949	1SL1949A00	10/400
Terminal carrier			
Terminal carrier 8M MISTRAL65	1SPE007715F0751		5/280
Terminal carrier 12M MISTRAL65	1SPE007715F0752		5/225
Terminal carrier 18M MISTRAL65	1SPE007715F0753		5/150

Order codes

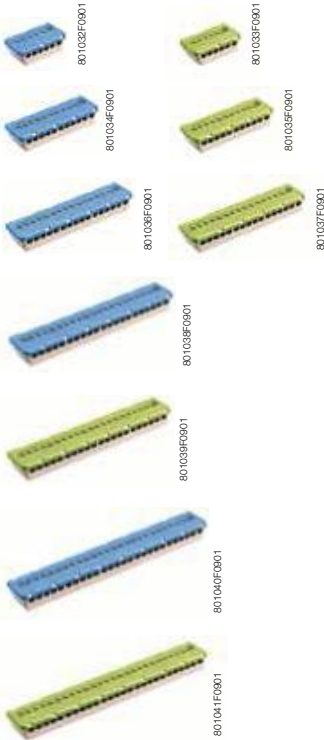

Terminal block

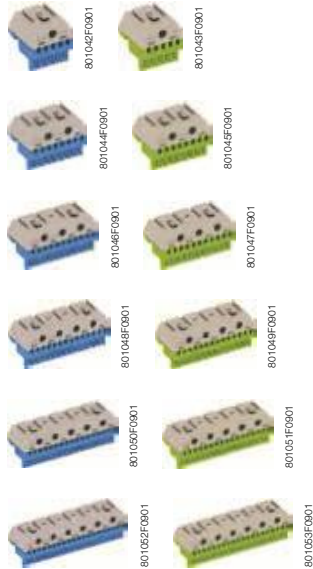

Terminal block screwless

Description	Maximum current	ABB code	Order code	Pack./ N. pieces
Terminal block				
Terminal block N 3x16mm ² +3x6mm ²	100 A	1SPE007715F0731	1SPE007715F0731	5/270
Terminal block N 5x16mm ² +6x6mm ²	100 A	1SPE007715F0732	1SPE007715F0732	5/150
Terminal block N 7x16mm ² +9x6mm ²	100 A	1SPE007715F0733	1SPE007715F0733	5/120
Terminal block N 9x16mm ² +12x6mm ²	100 A	1SPE007715F0734	1SPE007715F0734	5/90
Terminal block N 11x16mm ² +15x6mm ²	100 A	1SPE007715F0735	1SPE007715F0735	5/90
Terminal block PE 3x16mm ² +3x6mm ²	100 A	1SPE007715F0741	1SPE007715F0741	5/270
Terminal block PE 5x16mm ² +6x6mm ²	100 A	1SPE007715F0742	1SPE007715F0742	5/150
Terminal block PE 7x16mm ² +9x6mm ²	100 A	1SPE007715F0743	1SPE007715F0743	5/120
Terminal block PE 9x16mm ² +12x6mm ²	100 A	1SPE007715F0744	1SPE007715F0744	5/90
Terminal block PE 11x16mm ² +15x6mm ²	100 A	1SPE007715F0745	1SPE007715F0745	5/90
Terminal block screwless				
Terminal block screwless N 5x1,5-4mm ²	63 A	1SPE007715F9701	1SPE007715F9701	5/280
Terminal block screwless N 5x1,5-4mm ² +1x25mm ²	63 A	1SPE007715F9702	1SPE007715F9702	5/180
Terminal block screwless N 8x1,5-4mm ² +2x25mm ²	63 A	1SPE007715F9703	1SPE007715F9703	5/150
Terminal block screwless N 11x1,5-4mm ² +3x25mm ²	63 A	1SPE007715F9704	1SPE007715F9704	5/120
Terminal block screwless N 14x1,5-4mm ² +4x25mm ²	63 A	1SPE007715F9705	1SPE007715F9705	5/90
Terminal block screwless N 17x1,5-4mm ² +5x25mm ²	63 A	1SPE007715F9706	1SPE007715F9706	5/70
Terminal block screwless N 20x1,5-4mm ² +6x25mm ²	63 A	1SPE007715F9707	1SPE007715F9707	5/60
Terminal block screwless PE 5x1,5-4mm ² +1x25mm ²	63 A	1SPE007715F9712	1SPE007715F9712	5/180
Terminal block screwless PE 8x1,5-4mm ² +2x25mm ²	63 A	1SPE007715F9713	1SPE007715F9713	5/150
Terminal block screwless PE 11x1,5-4mm ² +3x25mm ²	63 A	1SPE007715F9714	1SPE007715F9714	5/120
Terminal block screwless PE 14x1,5-4mm ² +4x25mm ²	63 A	1SPE007715F9715	1SPE007715F9715	5/90
Terminal block screwless PE 17x1,5-4mm ² +5x25mm ²	63 A	1SPE007715F9716	1SPE007715F9716	5/70
Terminal block screwless PE 20x1,5-4mm ² +6x25mm ²	63 A	1SPE007715F9717	1SPE007715F9717	5/60

Terminal blocks

Terminal carriers

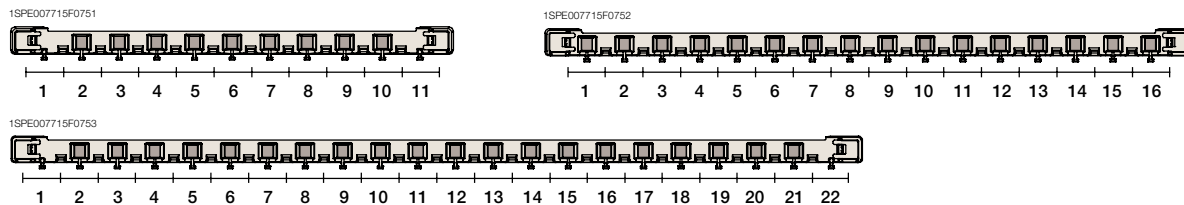

Terminal block

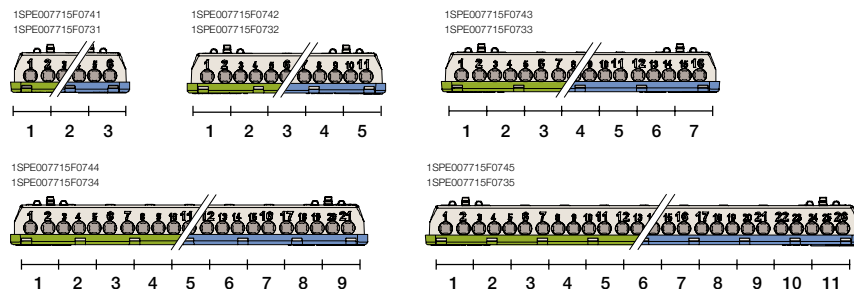

Terminal block screwless

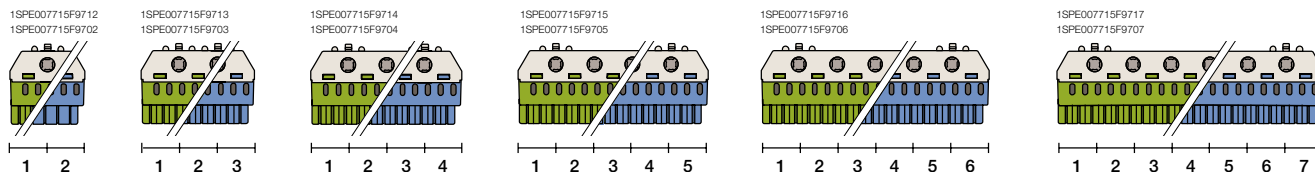

Assembly examples

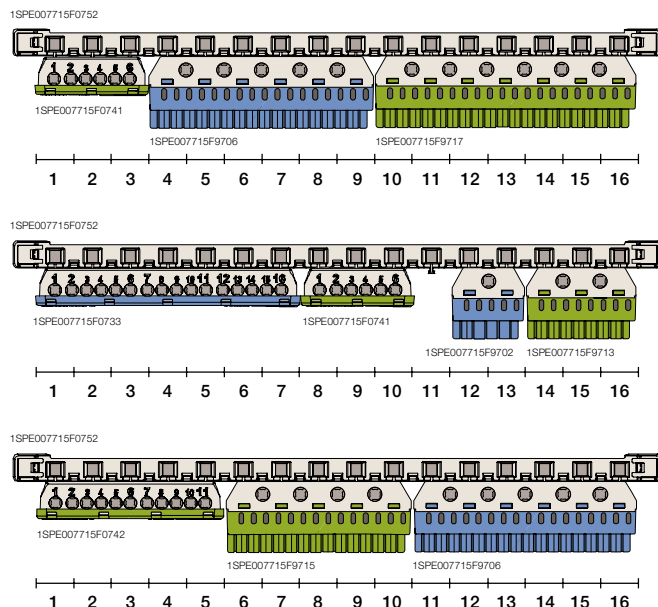

Technical details

Codes	1SL1100A00 1SL1200A00	1SL1101A00 1SL1201A00 1SLM006501A1201	1SL1102A00 1SL1202A00 1SLM006501A1202	1SL1103A00 1SL1203A00 1SLM006501A1203 1SLM006502A1203	1SL1104A00 1SL1204A00 1SLM006501A1204 1SLM006502A1204
Number of modules	4	8	12	18	24
Dimensions (WxHxD) in mm	152 x 202 x 117	232 x 250 x 154	320 x 250 x 155	430 x 250 x 155	320 x 435 x 155
Colour	RAL 7035 grey	RAL 7035 grey	RAL 7035 grey	RAL 7035 grey	RAL 7035 grey
Door type	Opaque / Transparent	Opaque / Transparent	Opaque / Transparent	Opaque / Transparent	Opaque / Transparent
Protection class	II	II	II	II	II
Fire resistance	GWT 650°C	GWT 650°C	GWT 650°C	GWT 650°C	GWT 650°C
Material	Thermoplastic	Thermoplastic	Thermoplastic	Thermoplastic	Thermoplastic
Resistance to mechanical impacts	IK09	IK09	IK09	IK09	IK09
Knockout resistance to mechanical impacts	IK08	IK08	IK08	IK08	IK08
Installation temperature	-25°C / +60°C	-25°C / +60°C	-25°C / +60°C	-25°C / +60°C	-25°C / +60°C
Resistance to heat	BPT 70°C	BPT 70°C	BPT 70°C	BPT 70°C	BPT 70°C
IP rating	IP65	IP65	IP65	IP65	IP65
Max. dissipation power	12 W	20 W	27 W	32 W	34 W
Maximum current	63A	63A	63A	125A	125A
Extractable frame	no	no	no	no	yes
Additional module	no	no	yes	yes	yes
Installation of MCCBs	no	yes	yes	yes	yes
DIN rail centre distance	-	-	-	-	150 - 125 (mm)
Halogen free	yes	yes	yes	yes	yes
Cable entry finish	Smooth	Smooth	Smooth	Smooth	Smooth

Codes	1SL1105A00 1SL1205A00 1SLM006501A1205	1SL1106A00 1SL1206A00 1SLM006501A1206	1SL1107A00 1SL1207A00 1SLM006501A1207	1SL1108A00 1SL1208A00 1SLM006501A1208	1SL1109A00 1SL1209A00 1SLM006501A1209
Number of modules	36	36	48	54	72
Dimensions (WxHxD) in mm	430 x 435 x 155	320 x 435 x 155	320 x 735 x 155	430 x 600 x 155	430 x 735 x 155
Colour	RAL 7035 grey	RAL 7035 grey	RAL 7035 grey	RAL 7035 grey	RAL 7035 grey
Door type	Opaque / Transparent	Opaque / Transparent	Opaque / Transparent	Opaque / Transparent	Opaque / Transparent
Protection class	II	II	II	II	II
Fire resistance	GWT 650°C	GWT 650°C	GWT 650°C	GWT 650°C	GWT 650°C
Material	Thermoplastic	Thermoplastic	Thermoplastic	Thermoplastic	Thermoplastic
Resistance to mechanical impacts	IK09	IK09	IK09	IK09	IK09
Knockout resistance to mechanical impacts	IK08	IK08	IK08	IK08	IK08
Installation temperature	-25°C / +60°C	-25°C / +60°C	-25°C / +60°C	-25°C / +60°C	-25°C / +60°C
Resistance to heat	BPT 70°C	BPT 70°C	BPT 70°C	BPT 70°C	BPT 70°C
IP rating	IP65	IP65	IP65	IP65	IP65
Max. dissipation power	43 W	51 W	64 W	63 W	81 W
Maximum current	125A	125A	125A	125A	125A
Extractable frame	yes	yes	yes	yes	yes
Additional module	yes	yes	yes	yes	yes
Installation of MCCBs	yes	yes	yes	yes	yes
DIN rail centre distance	150 - 125 (mm)	150 - 125 (mm)	150 - 125 (mm)	150 - 125 (mm)	150 - 125 (mm)
Halogen free	yes	yes	yes	yes	yes
Cable entry finish	Smooth	Smooth	Smooth	Smooth	Smooth

Reference standards IEC60670 - EN60439-3

Codes	1SL1210A00	1SL1211A00	1SL1212A00	1SL1213A00	1SL1214A00
Number of modules	4	8	12	18	24
Dimensions (WxHxD) in mm	152 x 202 x 117	232 x 250 x 154	320 x 250 x 155	430 x 250 x 155	320 x 435 x 155
Colour	RAL 7035 grey	RAL 7035 grey	RAL 7035 grey	RAL 7035 grey	RAL 7035 grey
Door type	Transparent	Transparent	Transparent	Transparent	Transparent
Protection class	II □	II □	II □	II □	II □
Fire resistance	GWT 750°C	GWT 750°C	GWT 750°C	GWT 750°C	GWT 750°C
Material	Thermoplastic	Thermoplastic	Thermoplastic	Thermoplastic	Thermoplastic
Resistance to mechanical impacts	IK09	IK09	IK09	IK09	IK09
Knockout resistance to mechanical impacts	IK08	IK08	IK08	IK08	IK08
Installation temperature	-25°C / +60°C	-25°C / +60°C	-25°C / +60°C	-25°C / +60°C	-25°C / +60°C
Resistance to heat	BPT 70°C	BPT 70°C	BPT 70°C	BPT 70°C	BPT 70°C
IP rating	IP65	IP65	IP65	IP65	IP65
Max. dissipation power	12 W	20 W	27 W	32 W	34 W
Maximum current	63A	63A	63A	125A	125A
Extractable frame	no	no	no	no	yes
Additional module	no	no	yes	yes	yes
Installation of MCCBs	no	yes	yes	yes	yes
DIN rail centre distance	-	-	-	-	150 - 125 (mm)
Halogen free	no	no	no	no	no
Cable entry finish	Precut	Precut	Precut	Precut	Precut

Codes	1SL1215A00	1SL1216A00	1SL1217A00	1SL1218A00	1SL1219A00
Number of modules	36	36	48	54	72
Dimensions (WxHxD) in mm	430 x 435 x 155	320 x 435 x 155	320 x 735 x 155	430 x 600 x 155	430 x 735 x 155
Colour	RAL 7035 grey	RAL 7035 grey	RAL 7035 grey	RAL 7035 grey	RAL 7035 grey
Door type	Transparent	Transparent	Transparent	Transparent	Transparent
Protection class	II □	II □	II □	II □	II □
Fire resistance	GWT 750°C	GWT 750°C	GWT 750°C	GWT 750°C	GWT 750°C
Material	Thermoplastic	Thermoplastic	Thermoplastic	Thermoplastic	Thermoplastic
Resistance to mechanical impacts	IK09	IK09	IK09	IK09	IK09
Knockout resistance to mechanical impacts	IK08	IK08	IK08	IK08	IK08
Installation temperature	-25°C / +60°C	-25°C / +60°C	-25°C / +60°C	-25°C / +60°C	-25°C / +60°C
Resistance to heat	BPT 70°C	BPT 70°C	BPT 70°C	BPT 70°C	BPT 70°C
IP rating	IP65	IP65	IP65	IP65	IP65
Max. dissipation power	43 W	51 W	64 W	63 W	81 W
Maximum current	125A	125A	125A	125A	125A
Extractable frame	yes	yes	yes	yes	yes
Additional module	yes	yes	yes	yes	yes
Installation of MCCBs	yes	yes	yes	yes	yes
DIN rail centre distance	150 - 125 (mm)	150 - 125 (mm)	150 - 125 (mm)	150 - 125 (mm)	150 - 125 (mm)
Halogen free	no	no	no	no	no
Cable entry finish	Precut	Precut	Precut	Precut	Precut

Reference standards IEC60670 - EN60439-3

Technical details

Table of resistance to chemical agents

	Cold water	Hot water	Sulphuric acid	Hydrochloric acid	Acetic acid	Petroleum	Benzine	Acetone	Ethyl alcohol	Ammonia	Dichloromethane	Diesel oil - Naptha	Mineral oil	Food oils	Tetrachloroethylene	Trichloroethylene	Ether	Ozone	Toluene	Methyl alcohol	Alcohol	Milk	Fruit juices	Fluorocarbons	Deterives	Detergents	Potassium nitrate	Hydrogen peroxide
MISTRAL65 - IP65 consumer unit	■	■	▲	●	■	●	●	●	▲	■	●	▲	■	■	●	●	●	■	●	▲	■	■	■	●	■	■	▲	■

■ resistant ▲ partially resistant ● non resistant

Ingress protection rating IP65

6 First number:
Protection against the penetration of solid bodies
No dust can penetrate

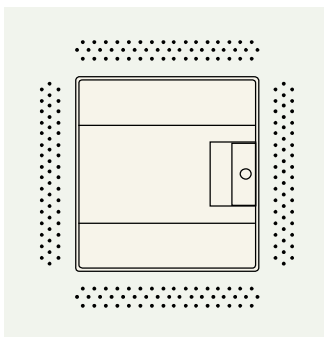

5 Second number:
Protection against the penetration of water
Water projected with a nozzle from all directions must not cause damage

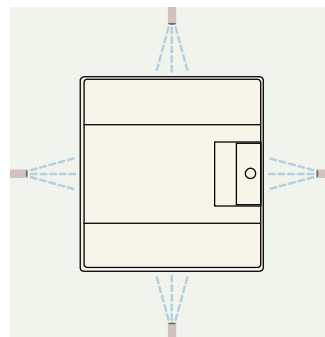

Upper and lower knockouts

Modules		Cable Glands		
		diam. 16	diam. 20	diam. 25
4	04x1	2	-	-
8	08x1	3	3	-
12	12x1	2	2	2
24	12x2	5	5	2
36	12x3	5	5	2
48	12x4	5	5	2
18	18x1	2	2	2
36	18x2	5	5	2
54	18x3	5	5	2
72	18x4	5	5	2

Modules		Holes				
		diam. 12	diam. 16	diam. 20	diam. 25	diam. 32
4	04x1	4	4	-	-	-
8	08x1	-	6	7	2	-
12	12x1	-	10	7	4	2
24	12x2	-	10	7	4	2
36	12x3	-	10	7	4	2
48	12x4	-	10	7	4	2
18	18x1	-	14	9	4	2
36	18x2	-	14	9	4	2
54	18x3	-	14	9	4	2
72	18x4	-	14	9	4	2

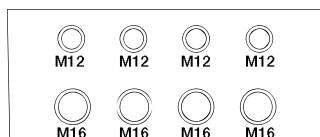

4 modules - top and bottom

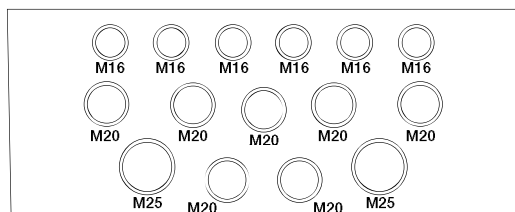

8 modules - top and bottom

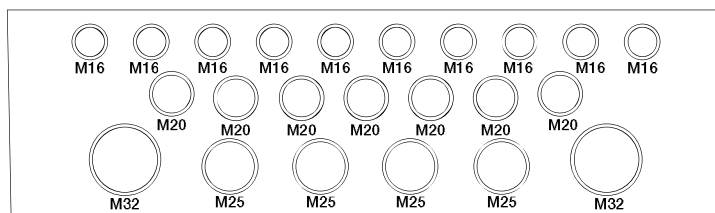

12 modules - top and bottom

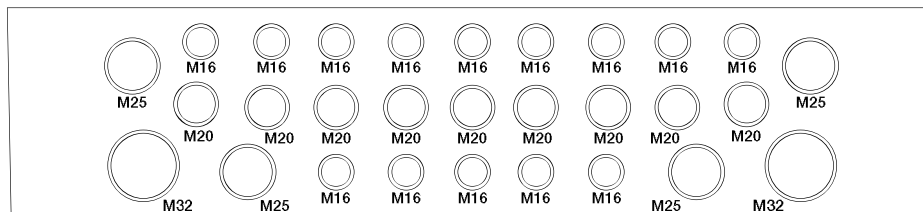

18 modules - top and bottom

Overall dimensions

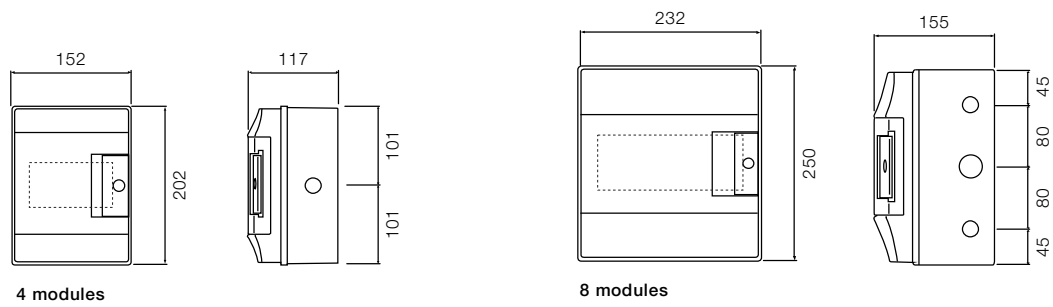

4 modules

8 modules

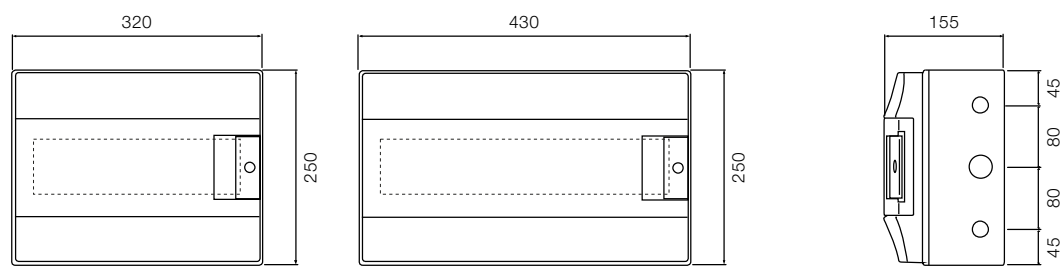

12 modules

18 modules

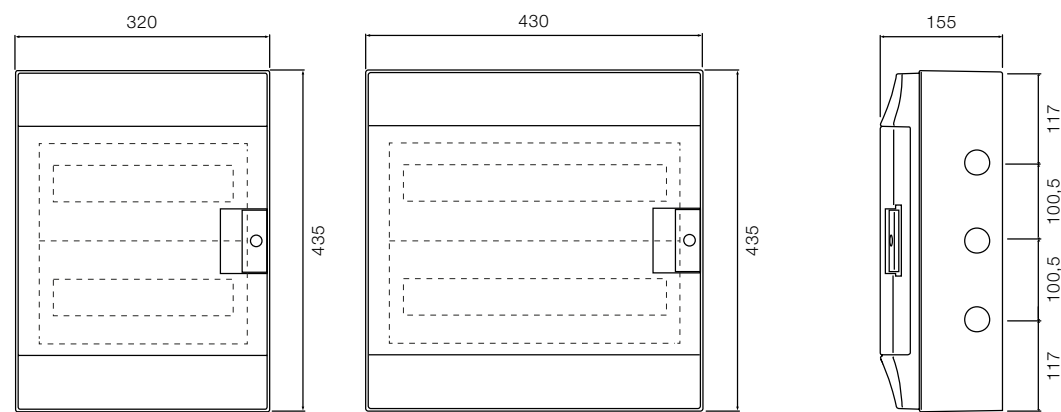

24 modules

36 modules

Dimensions in mm

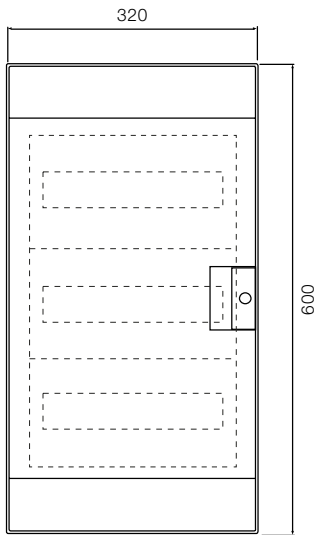

36 modules

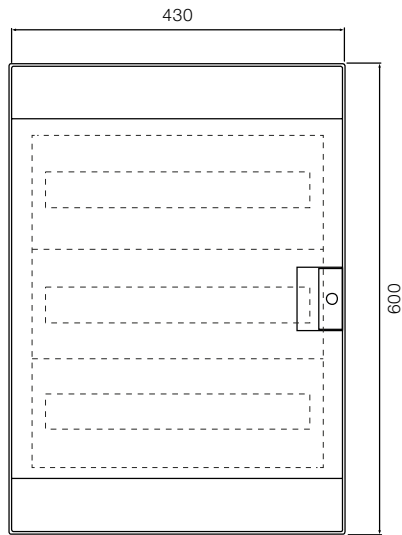

54 modules

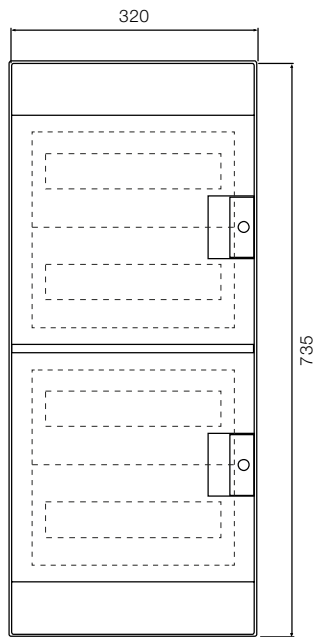
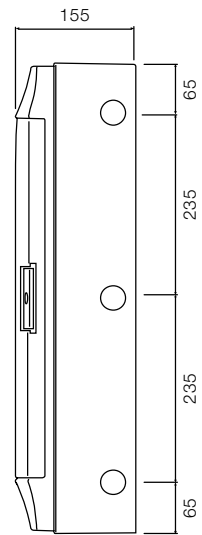

48 modules

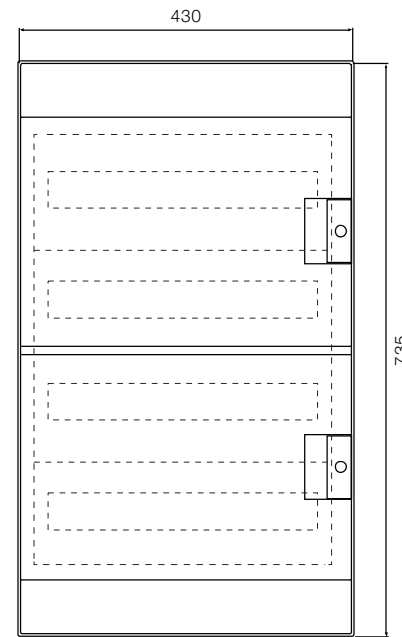

72 modules

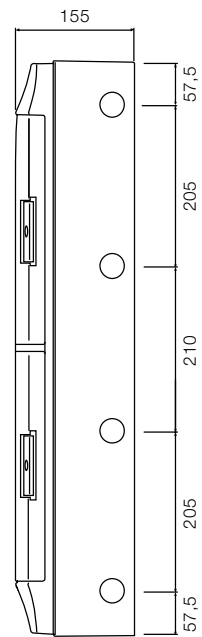

Dimensions in mm

Overall dimensions

Consumer unit fixing template

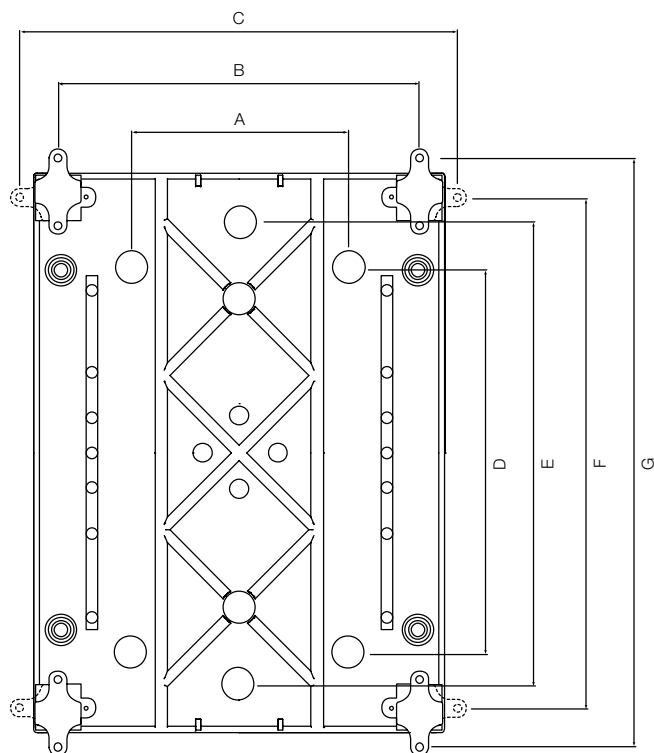

	A	B	C	D	E	F	G
4 Modules		113	173		140	163	223,5
8 Modules	90	194	254,5	180		212	272,5
12 Modules	170	282,5	343	180		212	272,5
18 Modules	280	392	452,5	125	175	212	272,5
24 Modules	170	282,5	343	310	360	397	457,5
36 Modules - 2 F	280	392	452,5	310	360	397	457,5
36 Modules - 3 F	170	282,5	343	475	525	562	622,5
48 Modules	170	282,5	343	610	660	697	757,5
54 Modules	280	392	452,5	475	525	562	622,5
72 Modules	280	392	452,5	610	660	697	757,5

Dimensions in mm

List of quick reference codes

ABB code	Type	Pag.
1SL1100A00	Consumer units MISTRAL65 opaque door 4M	12
1SL1101A00	Consumer units MISTRAL65 opaque door 8M	12
1SL1102A00	Consumer units MISTRAL65 opaque door 12M	12
1SL1103A00	Consumer units MISTRAL65 opaque door 18M	12
1SL1104A00	Consumer units MISTRAL65 opaque door 24M	12
1SL1105A00	Consumer units MISTRAL65 opaque door 36M 2F	12
1SL1106A00	Consumer units MISTRAL65 opaque door 36M 3F	13
1SL1107A00	Consumer units MISTRAL65 opaque door 48M	13
1SL1108A00	Consumer units MISTRAL65 opaque door 54M	13
1SL1109A00	Consumer units MISTRAL65 opaque door 72M	13
1SL1200A00	Consumer units MISTRAL65 transparent door 4M	12
1SL1201A00	Consumer units MISTRAL65 transparent door 8M	12
1SL1202A00	Consumer units MISTRAL65 transparent door 12M	12
1SL1203A00	Consumer units MISTRAL65 transparent door 18M	12
1SL1204A00	Consumer units MISTRAL65 transparent door 24M	12
1SL1205A00	Consumer units MISTRAL65 transparent door 36M 2F	12
1SL1206A00	Consumer units MISTRAL65 transparent door 36M 3F	13
1SL1207A00	Consumer units MISTRAL65 transparent door 48M	13
1SL1208A00	Consumer units MISTRAL65 transparent door 54M	13
1SL1209A00	Consumer units MISTRAL65 transparent door 72M	13
1SL1210A00	Consumer units MISTRAL65 750 transparent door 4M	14
1SL1211A00	Consumer units MISTRAL65 750 transparent door 8M	14
1SL1212A00	Consumer units MISTRAL65 750 transparent door 12M	14
1SL1213A00	Consumer units MISTRAL65 750 transparent door 18M	14
1SL1214A00	Consumer units MISTRAL65 750 transparent door 24M	14
1SL1215A00	Consumer units MISTRAL65 750 transparent door 36M 2F	14
1SL1216A00	Consumer units MISTRAL65 750 transparent door 36M 3F	15
1SL1217A00	Consumer units MISTRAL65 750 transparent door 48M	15
1SL1218A00	Consumer units MISTRAL65 750 transparent door 54M	15
1SL1219A00	Consumer units MISTRAL65 750 transparent door 72M	15
1SL1900A00	Opaque door 4M MISTRAL65	18
1SL1901A00	Transparent door 4M MISTRAL65	18
1SL1902A00	Opaque door 8M MISTRAL65	18
1SL1903A00	Transparent door 8M MISTRAL65	18
1SL1904A00	Opaque door 12M MISTRAL65	18
1SL1905A00	Transparent door 12M MISTRAL65	18
1SL1906A00	Opaque door 18M MISTRAL65	18
1SL1907A00	Transparent door 18M MISTRAL65	18
1SL1908A00	Opaque door 24M / 48M MISTRAL65	18
1SL1909A00	Transparent door 24M / 48M MISTRAL65	18
1SL1910A00	Opaque door 36M MISTRAL65	18
1SL1911A00	Transparent door 36M MISTRAL65	18
1SL1912A00	Opaque door 36M / 72M MISTRAL65	18
1SL1913A00	Transparent door 36M / 72M MISTRAL65	18
1SL1914A00	Opaque door 54M MISTRAL65	18
1SL1915A00	Transparent door 54M MISTRAL65	18
1SL1920A00	Metal base plate 12M MISTRAL65	18
1SL1921A00	Metal base plate 2x12M MISTRAL65	18
1SL1922A00	Metal base plate 18M MISTRAL65	18
1SL1923A00	Metal base plate 2x18M MISTRAL65	18
1SL1927A00	Wall fixing brackets (4 pcs) MISTRAL65	19

ABB code	Type	Pag.
1SL1929A00	Module cover 12M MISTRAL65	19
1SL1931A00	Lock with key MISTRAL65	19
1SL1935A00	Cable gland Ø 16	19
1SL1936A00	Cable gland Ø 20	19
1SL1937A00	Cable gland Ø 25	19
1SL1938A00	Cable gland Ø 32	19
1SL1942A00	Adapter for trunking MISTRAL65	19
1SL1945A00	Central blind panel 12M MISTRAL65	18
1SL1946A00	Blind panel 12M MISTRAL65	18
1SL1947A00	Central blind panel 18M MISTRAL65	18
1SL1948A00	Blind panel 18M MISTRAL65	18
1SL1949A00	Junction unit Ø 28,5 MISTRAL65	19
1SL1950A00	Sealing kit MISTRAL65	19
1SLM006501A1201	MISTRAL65 transparent door 8M 12SM	16
1SLM006501A1202	MISTRAL65 transparent door 12M 22SM	16
1SLM006501A1203	MISTRAL65 transparent door 18M 12SM	16
1SLM006502A1203	MISTRAL65 transparent door 18M 32SM	16
1SLM006501A1204	MISTRAL65 transparent door 24M 22SM	16
1SLM006502A1204	MISTRAL65 transparent door 24M 42SM	16
1SLM006501A1205	MISTRAL65 transparent door 36M 2F 52SM	17
1SLM006501A1206	MISTRAL65 transparent door 36M 3F 42SM	17
1SLM006501A1207	MISTRAL65 transparent door 48M 52SM	17
1SLM006501A1208	MISTRAL65 transparent door 54M 52SM	17
1SLM006501A1209	MISTRAL65 transparent door 72M 52SM	17
1SPE007715F0731	Terminal block N 3x16mm ² +3x6mm ²	20
1SPE007715F0732	Terminal block N 5x16mm ² +6x6mm ²	20
1SPE007715F0733	Terminal block N 7x16mm ² +9x6mm ²	20
1SPE007715F0734	Terminal block N 9x16mm ² +12x6mm ²	20
1SPE007715F0735	Terminal block N 11x16mm ² +15x6mm ²	20
1SPE007715F0741	Terminal block PE 3x16mm ² +3x6mm ²	20
1SPE007715F0742	Terminal block PE 5x16mm ² +6x6mm ²	20
1SPE007715F0743	Terminal block PE 7x16mm ² +9x6mm ²	20
1SPE007715F0744	Terminal block PE 9x16mm ² +12x6mm ²	20
1SPE007715F0745	Terminal block PE 11x16mm ² +15x6mm ²	20
1SPE007715F0751	Terminal carrier 8M MISTRAL65	19
1SPE007715F0752	Terminal carrier 12M MISTRAL65	19
1SPE007715F0753	Terminal carrier 18M MISTRAL65	19
1SPE007715F9701	Terminal block screwless N 5x1,5-4mm ²	20
1SPE007715F9702	Terminal block screwless N 5x1,5-4mm ² +1x25mm ²	20
1SPE007715F9703	Terminal block screwless N 8x1,5-4mm ² +2x25mm ²	20
1SPE007715F9704	Terminal block screwless N 11x1,5-4mm ² +3x25mm ²	20
1SPE007715F9705	Terminal block screwless N 14x1,5-4mm ² +4x25mm ²	20
1SPE007715F9706	Terminal block screwless N 17x1,5-4mm ² +5x25mm ²	20
1SPE007715F9707	Terminal block screwless N 20x1,5-4mm ² +6x25mm ²	20
1SPE007715F9712	Terminal block screwless PE 5x1,5-4mm ² +1x25mm ²	20
1SPE007715F9713	Terminal block screwless PE 8x1,5-4mm ² +2x25mm ²	20
1SPE007715F9714	Terminal block screwless PE 11x1,5-4mm ² +3x25mm ²	20
1SPE007715F9715	Terminal block screwless PE 14x1,5-4mm ² +4x25mm ²	20
1SPE007715F9716	Terminal block screwless PE 17x1,5-4mm ² +5x25mm ²	20
1SPE007715F9717	Terminal block screwless PE 20x1,5-4mm ² +6x25mm ²	20

Contact us

ABB SACE

A division of ABB S.p.A.

Enclosures and Cable Systems

Viale Vicenza, 61

36063 Marostica (VI) - Italy

Tel.: +39 0424 478200

Fax: +39 0424 478305

www.abb.com

The data and illustrations are not binding. We reserve the right to modify the contents of this document on the basis of technical development of the products, without prior notice.

Copyright 2013 ABB. All right reserved.

1SLC801010D0202 - 10/2013

X-ON Electronics

Largest Supplier of Electrical and Electronic Components

Click to view similar products for [abb manufacturer](#):

Other Similar products are found below :

[TV10-516R](#) [017667013](#) [RF727](#) [2CMA100178R1000](#) [5SDD 92Z0401](#) [ESV14-BS](#) [EZS-21-250](#) [F204AC-40/0.03](#) [F204AC-40/0.1](#) [F362-25/0.03](#) [GJL1211001R0011](#) [GJL1211201R8000](#) [GJL1211501R8000](#) [GJL1213001R0017](#) [GJL1213001R0101](#) [GJL1311001R0101](#) [GJL1311001R8010](#) [GJL1311201R0001](#) [GJL1313001R0011](#) [GJL1313001R0101](#) [GJL1317201R0001](#) [AF09-30-01-11](#) [AF460-30-11-68](#) [1455](#) [EF45-30](#) [ERG297](#) [HSC2-20](#) [1SAM201904R1001](#) [1SAM350000R1003](#) [1SAZ721201R1009](#) [1SAZ721201R1014](#) [1SAZ721201R1025](#) [1SFA611101R1002](#) [1SFA611130R1103](#) [1SFA611131R1101](#) [1SFA611143R1101](#) [1SFA611202R1108](#) [1SFA611203R1108](#) [1SFA611215R1001](#) [1SFA611216R1108](#) [1SFA611285R1002](#) [1SFA611702R6006](#) [1SFA616162R1025](#) [1SFA619100R3015](#) [1SVR730020R0200](#) [IPC4111](#) [OS30FACC12](#) [OS60GJ03](#) [OVR1N160277PS](#) [OXC1L48](#)