

Pluggable interface relays and optocouplers CR-S

Slim relays, optocouplers and accessories

Pluggable interface relays and optocouplers are used for electrical isolation, amplification and signal matching between the electronic controlling, e.g. PLC (programmable logic controller), PC or field bus systems and the sensor / actuator level.

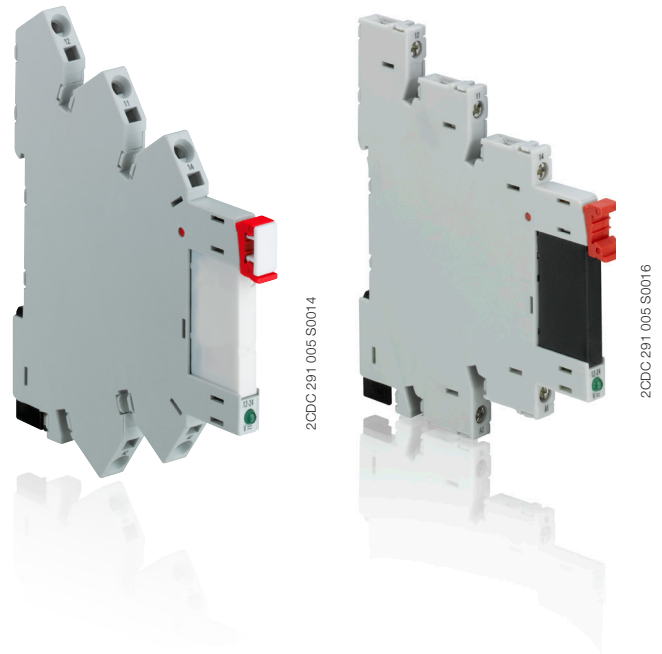

Characteristics

- Standard slim relays (5 mm), optocouplers (5 mm), sockets (6.2 mm) and accessories
- Combination of 9 different rated control supply voltages possible:
DC versions: 5 V, 12 V, 24 V
AC/DC versions: 12 V, 24 V, 48 V, 60 V, 110 V, 230 V
- Output relay: 1 c/o (SPDT) contact (6 A), standard and gold-plated
Output optocoupler: Transistor 100 mA - 48 V DC, MOS-FET 2 A - 24 V DC, Triac 2 A - 240 V AC
- Cadmium-free contact material
- All sockets with LED
- Screw and spring connection terminals
- Jumper bar (red, black, blue), marker and separator available as accessories

Approvals

- ANSI/UL 508, CAN/CSA C22.2 No.14
- CAN/CSA C22.2 No.14-13 (only relays and sockets)
relays also: CAN/CSA C22.2 No.0-10
- VDE (only relays and sockets with screw terminals)
- EAC (only relays and sockets)
- CQC

Marks

- CE (except relays)

Order data

Packing unit = 10 pieces

Pluggable interface relays, 1 c/o (SPDT) standard contacts: 250 V, 6 A

Type	Rated control supply voltage U_s	Order code
CR-S005VDC1R	5 V DC	1SVR405501R1010
CR-S012VDC1R	12 V DC	1SVR405501R2010
CR-S024VDC1R	24 V DC	1SVR405501R3010
CR-S048VDC1R	48 V DC	1SVR405501R4010
CR-S060VDC1R	60 V DC	1SVR405501R5010

Pluggable interface relays, 1 c/o (SPDT) gold plated contacts: 12 V, 250 mA (3W)¹⁾

CR-S005VDC1RG	5 V DC	1SVR405501R1020
CR-S012VDC1RG	12 V DC	1SVR405501R2020
CR-S024VDC1RG	24 V DC	1SVR405501R3020
CR-S048VDC1RG	48 V DC	1SVR405501R4020
CR-S060VDC1RG	60 V DC	1SVR405501R5020

Pluggable interface optocouplers

Type	Rated control supply voltage U_s	Output characteristics	Order code
CR-S024VDC1TRA	24 V DC	Transistor, 100 mA - 48 V DC	1SVR405510R3050
CR-S024VDC1MOS	24 V DC	MOS-FET, 2 A - 24 V DC	1SVR405510R3060
CR-S024VDC1TRI	24 V DC	Triac, 2 A - 240 V AC	1SVR405510R3070

Complete interface relays (relay + socket), 1 c/o (SPDT) standard contacts: 250 V, 6 A

Type	Rated control supply voltage U_s	Connection	Order code
CR-S024VADC1CRS	24 V AC/DC	Screw	1SVR405541R3110
CR-S024VADC1CRZ	24 V AC/DC	Spring	1SVR405541R3210
CR-S110VADC1CRS	110 V AC/DC	Screw	1SVR405541R6110
CR-S110VADC1CRZ	110 V AC/DC	Spring	1SVR405541R6210
CR-S230VADC1CRS	230 V AC/DC	Screw	1SVR405541R7110
CR-S230VADC1CRZ	230 V AC/DC	Spring	1SVR405541R7210

Complete interface relays (relay+socket), 1 c/o (SPDT) gold plated contacts: 12 V, 250 mA (3W)¹⁾

CR-S024VADC1CRGS	24 V AC/DC	Screw	1SVR405541R3120
CR-S024VADC1CRGZ	24 V AC/DC	Spring	1SVR405541R3220
CR-S110VADC1CRGS	110 V AC/DC	Screw	1SVR405541R6120
CR-S110VADC1CRGZ	110 V AC/DC	Spring	1SVR405541R6220
CR-S230VADC1CRGS	230 V AC/DC	Screw	1SVR405541R7120
CR-S230VADC1CRGZ	230 V AC/DC	Spring	1SVR405541R7220

Sockets

CR-S006/024VDC1SS	6-24 V DC	Screw	1SVR405521R1100
CR-S006/024VDC1SZ	6-24 V DC	Spring	1SVR405521R1200
CR-S012/024VADC1SS	12-24 V AC/DC	Screw	1SVR405521R3100
CR-S012/024VADC1SZ	12-24 V AC/DC	Spring	1SVR405521R3200
CR-S048/060VADC1SS	48-60 V AC/DC	Screw	1SVR405521R5100
CR-S048/060VADC1SZ	48-60 V AC/DC	Spring	1SVR405521R5200
CR-S110/125VADC1SS	110-125 V AC/DC	Screw	1SVR405521R6100
CR-S110/125VADC1SZ	110-125 V AC/DC	Spring	1SVR405521R6200
CR-S220/240VADC1SS	220-240 V AC/DC	Screw	1SVR405521R7100
CR-S220/240VADC1SZ	220-240 V AC/DC	Spring	1SVR405521R7200

Accessories for CR-S range sockets

Type	Version	Order code
CR-SJB20-BLUE	Jumper bar 20 pole, blue color	1SVR405598R0700
CR-SJB20-RED	Jumper bar 20 pole, red color	1SVR405598R0800
CR-SJB20-BLACK	Jumper bar 20 pole, black color	1SVR405598R0900
CR-SM	Marker block	1SNB041391R0610
CR-SSEP	Separator	1SVR405599R0000

¹⁾ If specified maximum values exceeded, the gold plating is destroyed. The maximum values of the standard contacts are then valid.

Relay assemblies

Control voltage	Connection terminal	Contact material	Socket type	Socket order code	Relay type	Relay order code
5 V DC	screw	standard	CR-S006/024VDC1SS	1SVR405521R1100	CR-S005VDC1R	1SVR405501R1010
		gold plated	CR-S006/024VDC1SS	1SVR405521R1100	CR-S005VDC1RG	1SVR405501R1020
12 V DC	spring	standard	CR-S006/024VDC1SZ	1SVR405521R1200	CR-S005VDC1R	1SVR405501R1010
		gold plated	CR-S006/024VDC1SZ	1SVR405521R1200	CR-S005VDC1RG	1SVR405501R1020
	screw	standard	CR-S006/024VDC1SS or CR-S012/024VADC1SS	1SVR405521R1100 or 1SVR405521R3100	CR-S012VDC1R	1SVR405501R2010
		gold plated	CR-S006/024VDC1SS or CR-S012/024VADC1SS	1SVR405521R1100 or 1SVR405521R3100	CR-S012VDC1RG	1SVR405501R2020
12 V AC	spring	standard	CR-S006/024VDC1SZ or CR-S012/024VADC1SZ	1SVR405521R1200 or 1SVR405521R3200	CR-S012VDC1R	1SVR405501R2010
		gold plated	CR-S006/024VDC1SZ or CR-S012/024VADC1SZ	1SVR405521R1200 or 1SVR405521R3200	CR-S012VDC1RG	1SVR405501R2020
	screw	standard	CR-S012/024VADC1SS	1SVR405521R3100	CR-S012VDC1R	1SVR405501R2010
		gold plated	CR-S012/024VADC1SS	1SVR405521R3100	CR-S012VDC1RG	1SVR405501R2020
24 V DC	spring	standard	CR-S012/024VADC1SZ	1SVR405521R3200	CR-S012VDC1R	1SVR405501R2010
		gold plated	CR-S012/024VADC1SZ	1SVR405521R3200	CR-S012VDC1RG	1SVR405501R2020
	screw	standard	CR-S006/024VDC1SS or CR-S012/024VADC1SS	1SVR405521R1100 or 1SVR405521R3100	CR-S024VDC1R	1SVR405501R3010
		gold plated	CR-S006/024VDC1SS or CR-S012/024VADC1SS	1SVR405521R1100 or 1SVR405521R3100	CR-S024VDC1RG	1SVR405501R3020
24 V AC	spring	standard	CR-S006/024VDC1SZ or CR-S012/024VADC1SZ	1SVR405521R1200 or 1SVR405521R3200	CR-S024VDC1R	1SVR405501R3010
		gold plated	CR-S006/024VDC1SZ or CR-S012/024VADC1SZ	1SVR405521R1200 or 1SVR405521R3200	CR-S024VDC1RG	1SVR405501R3020
	screw	standard	CR-S012/024VADC1SS	1SVR405521R3100	CR-S024VDC1R	1SVR405501R3010
		gold plated	CR-S012/024VADC1SS	1SVR405521R3100	CR-S024VDC1RG	1SVR405501R3020
48 V AC/DC	spring	standard	CR-S012/024VADC1SZ	1SVR405521R3200	CR-S024VDC1R	1SVR405501R3010
		gold plated	CR-S012/024VADC1SZ	1SVR405521R3200	CR-S024VDC1RG	1SVR405501R3020
	screw	standard	CR-S048/060VADC1SS	1SVR405521R5100	CR-S048VDC1R	1SVR405501R4010
		gold plated	CR-S048/060VADC1SS	1SVR405521R5100	CR-S048VDC1RG	1SVR405501R4020
60 V AC/DC	spring	standard	CR-S048/060VADC1SZ	1SVR405521R5200	CR-S048VDC1R	1SVR405501R4010
		gold plated	CR-S048/060VADC1SZ	1SVR405521R5200	CR-S048VDC1RG	1SVR405501R4020
	screw	standard	CR-S048/060VADC1SS	1SVR405521R5100	CR-S060VDC1R	1SVR405501R5010
		gold plated	CR-S048/060VADC1SS	1SVR405521R5100	CR-S060VDC1RG	1SVR405501R5020
110-125 V AC/DC	spring	standard	CR-S048/060VADC1SZ	1SVR405521R5200	CR-S060VDC1R	1SVR405501R5010
		gold plated	CR-S048/060VADC1SZ	1SVR405521R5200	CR-S060VDC1RG	1SVR405501R5020
	screw	standard	CR-S110/125VADC1SS	1SVR405521R6100	CR-S060VDC1R	1SVR405501R5010
		gold plated	CR-S110/125VADC1SS	1SVR405521R6100	CR-S060VDC1RG	1SVR405501R5020
220-240 V AC/DC	spring	standard	CR-S110/125VADC1SZ	1SVR405521R6200	CR-S060VDC1R	1SVR405501R5010
		gold plated	CR-S110/125VADC1SZ	1SVR405521R6200	CR-S060VDC1RG	1SVR405501R5020
	screw	standard	CR-S220/240VADC1SS	1SVR405521R7100	CR-S060VDC1R	1SVR405501R5010
		gold plated	CR-S220/240VADC1SS	1SVR405521R7100	CR-S060VDC1RG	1SVR405501R5020
spring	standard	CR-S220/240VADC1SZ	1SVR405521R7200	CR-S060VDC1R	1SVR405501R5010	
	gold plated	CR-S220/240VADC1SZ	1SVR405521R7200	CR-S060VDC1RG	1SVR405501R5020	

Optocoupler assemblies

Control voltage	Connection terminal	Output characteristics	Socket type	Socket order code	Opto type	Opto order code	
24 V DC	screw	Transistor	CR-S012/024VADC1SS	1SVR405521R3100	CR-S024VDC1TRA	1SVR405510R3050	
		100 mA - 48 V DC	CR-S012/024VADC1SZ	1SVR405521R3200	CR-S024VDC1TRA	1SVR405510R3050	
	spring	MOS-FET	2 A - 24 V DC	CR-S012/024VADC1SS	1SVR405521R3100	CR-S024VDC1MOS	1SVR405510R3060
			CR-S012/024VADC1SZ	1SVR405521R3200	CR-S024VDC1MOS	1SVR405510R3060	
	screw	Triac	2 A - 240 V AC	CR-S012/024VADC1SS	1SVR405521R3100	CR-S024VDC1TRI	1SVR405510R3070
			CR-S012/024VADC1SZ	1SVR405521R3200	CR-S024VDC1TRI	1SVR405510R3070	

How to use the selection table

- 1 Choose the desired control supply voltage from the column "Control voltage" e.g. 5 V DC.
- 2 Choose the desired kind of connection terminal from the column "Connection Terminal" e.g. spring.
- 3 Choose the desired material of contact from the column "Contact Material" e.g. gold plated.

Control voltage	Connection terminal	Contact material	Socket type	Socket order code	Relay type	Relay order code
5 V DC	screw	standard	CR-S006/024VDC1SS	1SVR405521R1100	CR-S005VDC1R	1SVR405501R1010
		gold plated	CR-S006/024VDC1SS	1SVR405521R1100	CR-S005VDC1RG	1SVR405501R1020
	spring	standard	CR-S006/024VDC1SZ	1SVR405521R1200	CR-S005VDC1R	1SVR405501R1010
		gold plated	CR-S006/024VDC1SZ	1SVR405521R1200	CR-S005VDC1RG	1SVR405501R1020
12 V AC	screw	standard	CR-S012/024VADC1SS	1SVR405521R3100	CR-S012VDC1R	1SVR405501R2010
		gold plated	CR-S012/024VADC1SS	1SVR405521R3100	CR-S012VDC1RG	1SVR405501R2020
	spring	standard	CR-S012/024VADC1SZ	1SVR405521R3200	CR-S012VDC1R	1SVR405501R2010
		gold plated	CR-S012/024VADC1SZ	1SVR405521R3200	CR-S012VDC1RG	1SVR405501R2020

Example: When you have chosen **5 V DC** as Control supply voltage, **spring** connection as Connection Terminal and **gold plated** as Contact Material the following order codes and type designators are valid:

Socket: CR-S006/024VDC1SZ, 1SVR405521R1200

Relay: CR-S005VDC1RG, 1SVR405501R1020

Functions

Operating controls

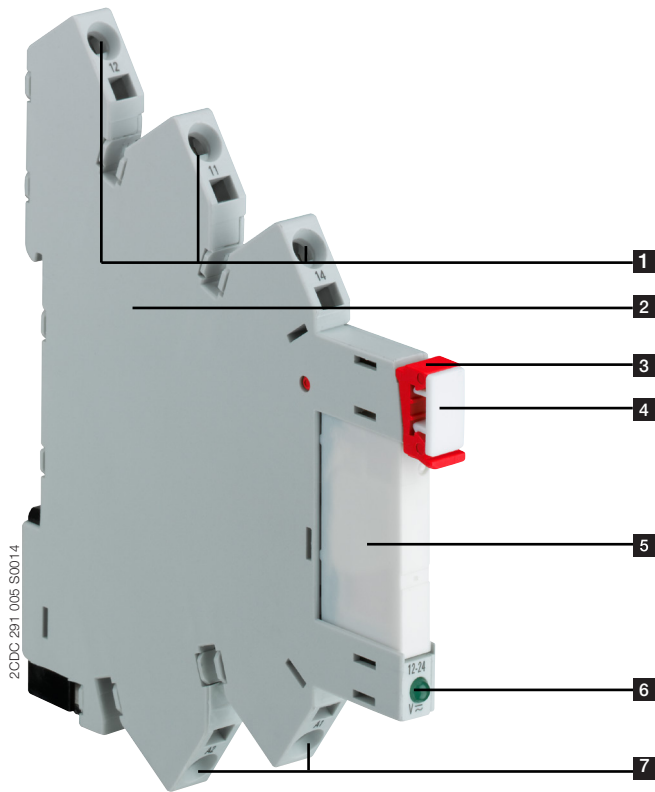

- 1** Output contacts
- 2** Socket
- 3** Relay holder
- 4** Marker
- 5** Interface relay
- 6** LED green: Control supply voltage applied
- 7** Control supply voltage

Application

Interface relays are electromechanic and electronic input and output modules for electrical isolation, levelling, noise suppression or signal amplification between control unit and a process.

Optocouplers are mostly used where high switching frequency is necessary. They have no moving parts thus operate bounce-free and immune to vibrations.

Operating mode

When control supply voltage is applied, the output contacts get closed. When control supply voltage is switched off, the contacts fall back into their starting position.

Electrical connection

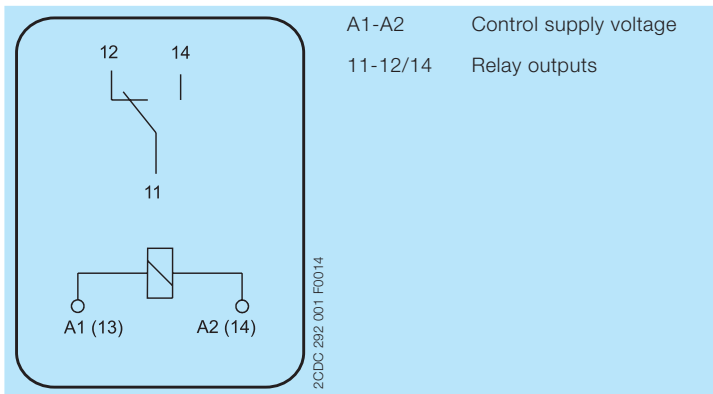

Connection diagram CR-S interface relay

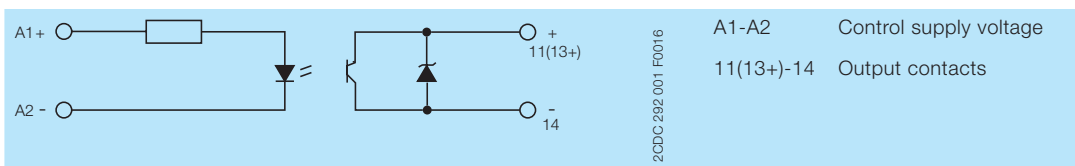

Connection diagram CR-S optocoupler with transistor

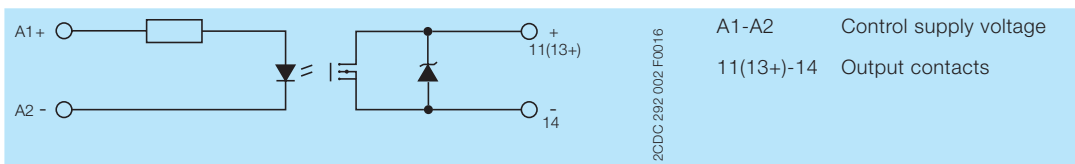

Connection diagram CR-S optocoupler with MOS-FET

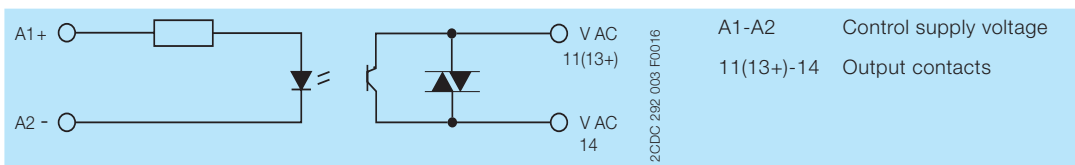

Connection diagram CR-S optocoupler with Triac

Technical data - CR-S Range relay

Input circuit - Coil data A1-A2

	Rated control supply voltage U_s	Make voltage (at 23 °C)	Maxium voltage (at 55 °C)	Break voltage	Rated power	Coil resistance (at 23 °C)	Tolerance of coil resistance
CR-S005VDC1R(G)	5 V DC	3.75 V DC	7.5 V DC	0.25 V DC	170 mW	147 Ω	$\pm 10 \%$
CR-S012VDC1R(G)	12 V DC	9 V DC	18 V DC	0.6 V DC	170 mW	848 Ω	$\pm 10 \%$
CR-S024VDC1R(G)	24 V DC	18 V DC	36 V DC	1.2 V DC	170 mW	3390 Ω	$\pm 15 \%$
CR-S048VDC1R(G)	48 V DC	36 V DC	72 V DC	2.4 V DC	210 mW	10600 Ω	$\pm 15 \%$
CR-S060VDC1R(G)	60 V DC	45 V DC	90 V DC	3 V DC	210 mW	16600 Ω	$\pm 15 \%$

Output circuits

Output circuits	11-12/14		
Kind of output	1 c/o (SPDT)		
Contact material	AgSnO ₂ / AgSnO ₂ /Au		
Rated operational voltage U_o (IEC/EN 60947-1)	250 V AC		
Minimum switching voltage	5 V at 100 mA (AgSnO ₂) / 5 V at 12 mA (AgSnO ₂ /Au)		
Maximum switching voltage	400 V AC / 250 V DC		
Minimum switching current	10 mA at 10 V (AgSnO ₂) / 3 mA at 20 V (AgSnO ₂ /Au)		
Rated free air thermal current I_{th}	5 A		
Rated operational current (IEC/EN 60947-5-1)	AC12 (resistive)	230 V	6 A
	AC15 (inductive)	230 V	1.5 A
	AC15 (inductive)	120 V	3 A
	DC12 (resistive)	24 V	6 A
	DC13 (inductive)	24 V	1 A
	DC13 (inductive)	120 V	0.22 A
	DC13 (inductive)	250 V	0.11 A
AC rating (UL 508; NEMA ICS-5)	Utilization category (pilot duty) (Contact rating code designation)	B300	
DC rating (UL 508; NEMA ICS-5)	Utilization category (pilot duty) (Contact rating code designation)	R300	
Maximum making (inrush) current	15 A, 240 V AC		
Minimum switching power	10 mA at 10 V (AgSnO ₂) / 60 mW (AgSnO ₂ /Au)		
Maximum switching (breaking) power	AC1 (resistive)	1500 VA, 250 V AC	
Contact resistance	100 m Ω (at 1 A/ 6 V DC)		
Maximum operating frequency	rated load AC1	360 switching cycles/h	
	without load	18000 switching cycles/h	
Mechanical lifetime	1 x 10 ⁷ switching cycles		
Electrical lifetime	AC1 (resistive)	(n/c) 3 x 10 ⁴ switching cycles (at +85 °C) (n/o) 1 x 10 ⁴ switching cycles (at +85 °C)	
Response time	8 ms		
Release time	4 ms		

Isolation data

Rated insulation voltage	250 V AC		
Rated impulse withstand voltage U_{imp}	between coil and contacts	4 kV 1 min	
	between open contacts	1 kV 1 min	
Clearance	between coil and contacts	5.5 mm (0.217 in)	
Creepage distance	between coil and contacts	8 mm (0.315 in)	
Overtoltage category	III		
Pollution degree	2		

General data

Dimensions (W x H x D)	28 x 5 x 15 mm (1.102 x 0.196 x 0.590 in)
Weight	5 g (0.011 lb)
Mounting	on socket
Mounting position	any
Degree of protection	RT II and RT III

Electrical connection

Connection	by socket
------------	-----------

Environmental data

Ambient temperature range	operation	-40...+85 °C
	storage	-40...+85 °C
Vibration resistance (10-150 Hz)	n/o contact	10 Hz to 55 Hz 1mm DA
	n/c contact	10 Hz to 55 Hz 1mm DA
Shock resistance	n/o contact	Functional 49 m/s ² / Destructive 980 m/s ²
	n/c contact	Functional 49 m/s ² / Destructive 980 m/s ²

Standards / Directives

Standards	IEC/EN 61810-1
RoHS Directive	2011/65/EU

Technical diagrams

Load limit curves - Max. DC load breaking capacity

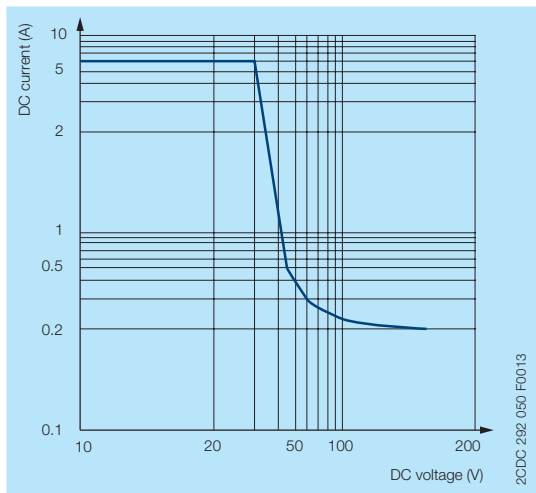

Endurance curve

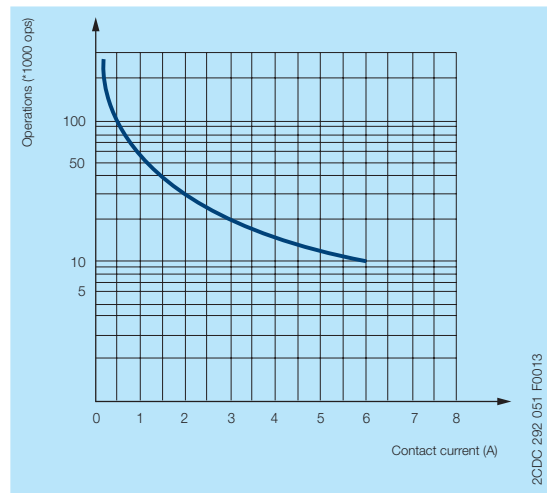

Technical data - CR-S Range optocoupler

Input circuit

Type	CR-S024VDC1TRA	CR-S024VDC1MOS	CR-S024VDC1TRI
Input resistance	3400 Ω	3400 Ω	3400 Ω
Rated control voltage	24 V DC	24 V DC	24 V DC
Pull-in voltage	15 V DC	15 V DC	15 V DC
Maximum input voltage	30 V DC	30 V DC	30 V DC
Nominal input current	7 mA	7 mA	7 mA
Input power	168 mW	168 mW	168 mW
Typical switch-on time	< 40 μs	< 60 μs	< 1/2 cycle
Typical switch-off time	< 600 μs	< 600 μs	< 1/2 cycle

Output circuit ¹⁾

Output circuits	11 (13+) - 14	11 (13+) - 14	11 (13+) - 14
Kind of output	Transistor	MOS-FET	Triac
Rated operational voltage	48 V DC	24 V DC	240 V AC
Maximum switching voltage	48 V DC	24 V DC	275 V AC
Minimum switching current	50 μA	50 μA	22 mA
Maximum switching current continuously	100 mA	2 A	2 A
Leakage current at maximum switching voltage	<1 μA	<1 μA	< 1.5 mA
Voltage drop at rated current	< 120 mV DC	< 120 mV DC	< 1.6 V AC

¹⁾ The output circuit should not exceed 30 m.

Isolation data

Rated insulation voltage (input/output)	2.5 kV	2.5 kV	2.5 kV
Insulation class	2	2	2
Clearance distance (input/output)	14 mm	14 mm	14 mm
Creepage (input/output)	14 mm	14 mm	14 mm
Overvoltage category	III	III	III
Pollution degree	2	2	2

General data

Dimensions (W x H x D)	28 x 5 x 15 mm (1.102 x 0.196 x 0.590 in)	28 x 5 x 15 mm (1.102 x 0.196 x 0.590 in)	28 x 5 x 15 mm (1.102 x 0.196 x 0.590 in)
Weight	3.5 g (0.007 lb)	3.5 g (0.007 lb)	3.5 g (0.007 lb)
Mounting	on socket	on socket	on socket

Environmental data

Ambient temperature	operational	-30...+80 °C	-30...+80 °C	-30...+80 °C
	storage	-40...+100 °C	-40...+100 °C	-40...+100 °C

Standards / Directives

Standards	IEC/EN 62314	IEC/EN 62314	IEC/EN 62314
EMC Directive	2014/30/EU	2014/30/EU	2014/30/EU
RoHS Directive	2011/65/EU	2011/65/EU	2011/65/EU

Technical diagrams

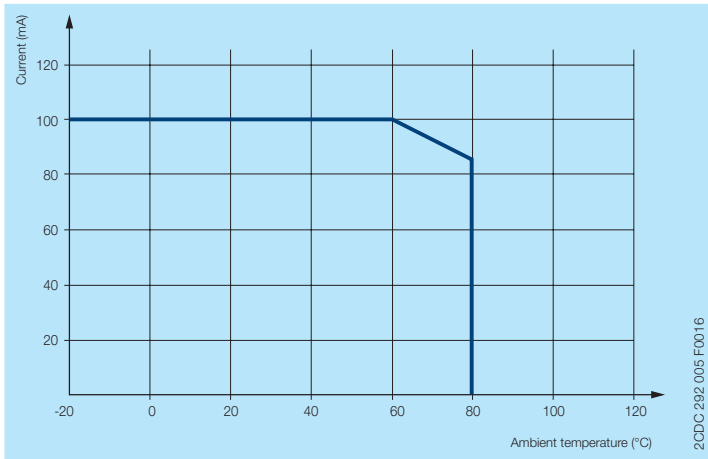

Derating curve transistor output

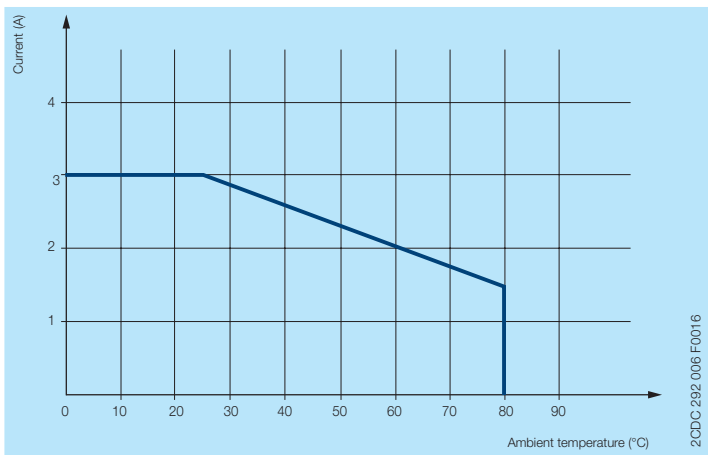

Derating curve MOS-FET output

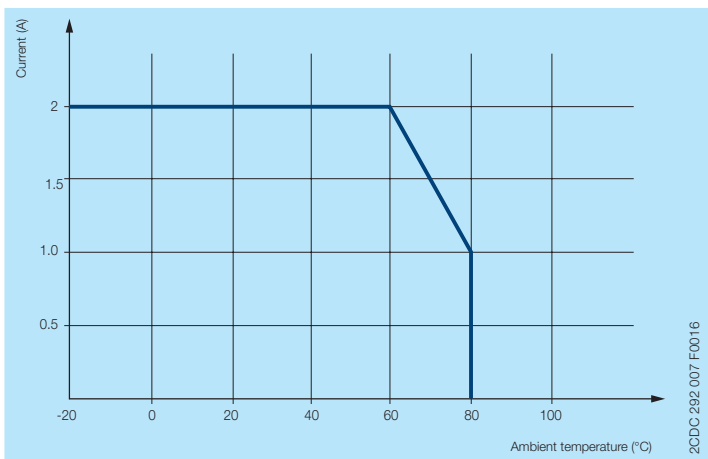

Derating curve Triac output

Technical data - CR-S range sockets with screw connection terminal

Input circuits

Type	CR-S006/024VDC1SS	CR-S012/024VADC1SS	CR-S048/060VADC1SS	CR-S110/125VADC1SS	CR-S220/240VADC1SS
Rated control supply voltage U_s	6-24 V DC	12-24 V AC/DC ¹⁾	48-60 V AC/DC	110-125 V AC/DC	220-240 V AC/DC
Rated control supply voltage U_s tolerance	(0.8-1.2) U_n	(0.8-1.1) U_n			
Typical current	11-29 mA	11-16 mA	3.6-4.5 mA	3.6 mA	3.6 mA
Response time	8 ms				
Release time	4 ms				
Status device	green LED				
Protective circuit	yes				

¹⁾ In combination with optocouplers, only DC supply is allowed.

Output circuits

Output circuits	11-12/14
Number of poles	1
Rated voltage	250 V AC
Rated current	6 A

General data

Type	CR-S006/024VDC1SS	CR-S012/024VADC1SS	CR-S048/060VADC1SS	CR-S110/125VADC1SS	CR-S220/240VADC1SS
Dimensions without holder (L x W x H)	88.3 x 6.3 x 70.9 mm (3.476 x 0.248 x 2.789 in)				
Degree of protection (EN 60529)	IP20 (terminals)				
Temperature range	operation -40...+70 °C			-40...+55 °C	
	storage -40...+85 °C				
Connection type	Screw				
Maximum number of wires per connection terminal	2				
Connecting capacity	rigid 2 x 0.5-1.5 mm ² (2 x 20-16 AWG)				
	fine-strand 2 x 0.5-1.0 mm ² (2 x 20-18 AWG)				
	with wire end ferrule 2 x 0.5-1.0 mm ² (2 x 20-18 AWG)				
Tightening torque	0.5 Nm (4.426 lb.in)				
Stripping length	7 mm (0.276 in)				
Minimum clamping force for fine-strand wire	with 0.2 mm ²		10 N		
	with 1.5 mm ²		40 N		
Mounting (IEC/EN 60715)	DIN rail				
Material	socket PA6 +GF-V2				
	contacts CuZn36				
	contact surface 3 μ Ni/Sn				
	terminals CuZn40, 3 μ Ni				
	combi screw M3 Fe				

Isolation data

Isolation between coil and contacts	5000 V AC
Resistance to shock coil to contact	1000 MΩ
Clearance and creepage distance	IEC/EN 61984

Standards / Directives

Standards	IEC/EN 61984
Low Voltage Directive	2014/35/EU
RoHS Directive	2011/65/EU

Technical data - CR-S range sockets with spring connection terminal

Input circuits

Type	CR-S006/024VDC1SZ	CR-S012/024VADC1SZ	CR-S048/060VADC1SZ	CR-S110/125VADC1SZ	CR-S220/240VADC1SZ
Rated control supply voltage U_s	6-24 V DC	12-24 V AC/DC ¹⁾	48-60 V AC/DC	110-125 V AC/DC	220-240 V AC/DC
Rated control supply voltage U_s tolerance	(0.8-1.2) U_n	(0.8-1.1) U_n			
Typical current	11-29 mA	11-16 mA	3.6-4.5 mA	3.6 mA	3.6 mA
Response time	8 ms				
Release time	4 ms				
Status device	green LED				
Protective circuit	yes				

¹⁾ In combination with optocouplers, only DC supply is allowed.

Output circuits

Output circuits	11-12/14
Number of poles	1
Rated voltage	250 V AC
Rated current	6 A

General data

Type	CR-S006/024VDC1SZ	CR-S012/024VADC1SZ	CR-S048/060VADC1SZ	CR-S110/125VADC1SZ	CR-S220/240VADC1SZ
Dimensions without holder (L x W x H)	94.7 x 6.2 x 73.2 mm (3.728 x 0.244 x 2.881 in)				
Degree of protection (EN 60529)	IP20 (terminals)				
Temperature operation range	-40...+70 °C			-40...+55 °C	
Temperature storage range	-40...+85 °C				
Connection type	spring				
Maximum number of wires per connection terminal	1				
Connecting capacity	0.75-2.5 mm ² (20-14 AWG) rigid, fine-strand and with wire end ferrule				
Stripping length	7 mm (0.276 in)				
Mounting (IEC/EN 60715)	DIN rail				
Material socket	PA6 +GF-V2				
Material contacts	CuZn36				
Material contact surface	3 μ Ni/Sn				
Material spring terminals	SUS301				

Isolation data

Isolation between coil and contacts	5000 V AC
Resistance to shock coil to contact	1000 MΩ
Clearance and creepage distance	IEC/EN 61984

Standards / Directives

Standards	IEC/EN 61984
Low Voltage Directive	2014/35/EU
RoHS Directive	2011/65/EU

Technical data - CR-S range jumper bar

Rated operational voltage / current

Rated operational voltage	250 V AC
Rated operational current	36 A

Electrical connection

Jumper bar cross section	123.2 mm (4.850 in)	
Step distance	6.3 mm (0.248 in)	
Rail length	with isolation	16.7 mm (0.657 in)
	without isolation	6.7 mm (0.264 in)
Stripping length of a connection wire that is used in combination with a jumper bar	7 mm (0.276 in)	

Environmental data

Ambient temperature range	operation	-40 ... +70 °C
---------------------------	-----------	----------------

General data

Material of rail	Cu
Number of pins	20
Flammability	V0

Dimensions

in **mm** and *inch*

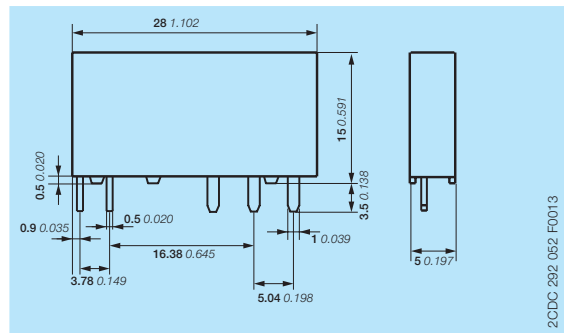

CR-S range interface relays

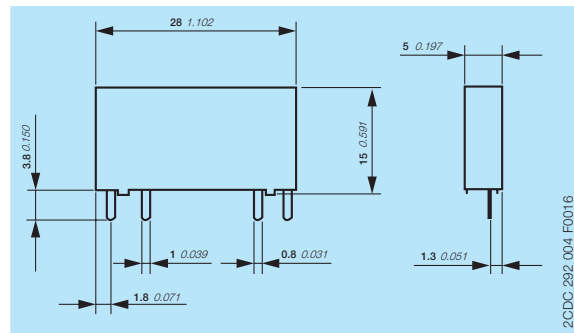

CR-S range optocouplers

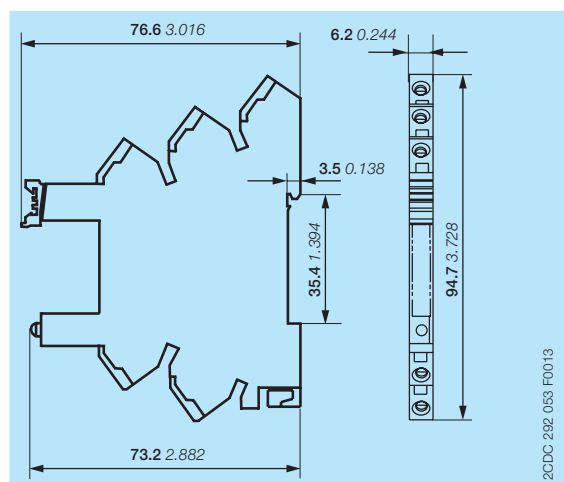

Spring socket for CR-S range interface relays

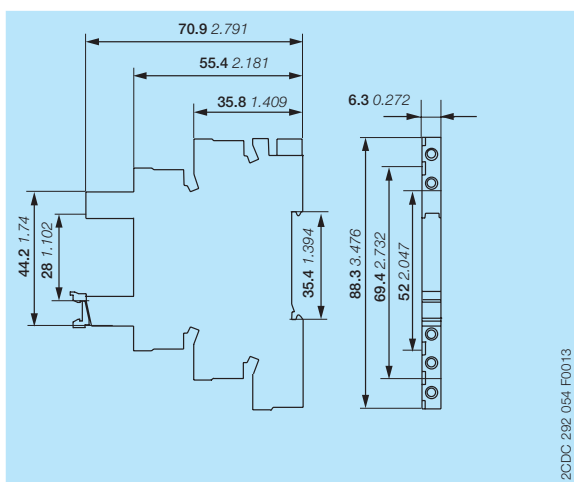

Screw socket for CR-S range interface relays

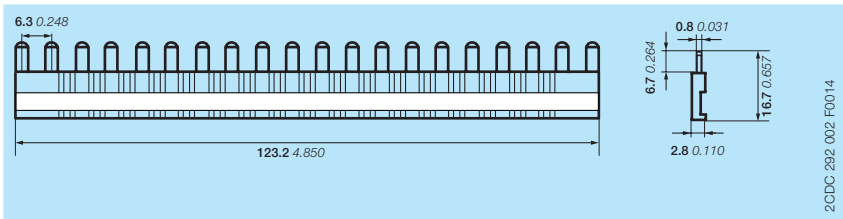

Jumper bar

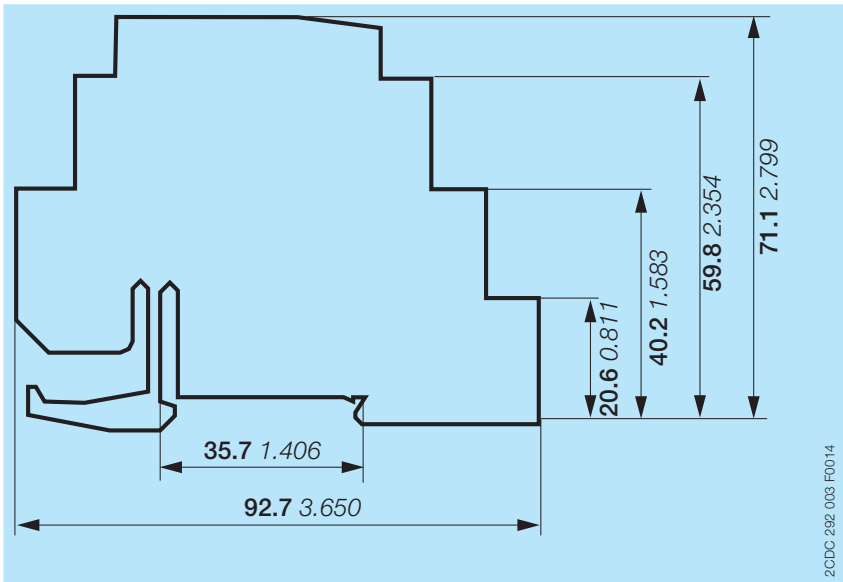

Separator

Further documentation

Document title	Document type	Document number
Electronic Products and Relays	Technical catalogue	2CDC 110 004 C02xx

You can find the documentation on the internet at www.abb.com/lowvoltage
 -> Automation, control and protection -> Electronic relays and controls
 -> Interface relays and optocouplers.

CAD system files

You can find the CAD files for CAD systems at <http://abb-control-products.partcommunity.com>
 -> Low Voltage Products & Systems -> Control Products -> Electronic Relays and Controls.

Contact us

ABB STOTZ-KONTAKT GmbH

P. O. Box 10 16 80
69006 Heidelberg, Germany
Phone: +49 (0) 6221 7 01-0
Fax: +49 (0) 6221 7 01-13 25
E-mail: info.desto@de.abb.com

You can find the address of your
local sales organization on the
ABB home page
<http://www.abb.com/contacts>
-> Low Voltage Products and Systems

Note:

We reserve the right to make technical changes or modify the contents of this document without prior notice. With regard to purchase orders, the agreed particulars shall prevail. ABB AG does not accept any responsibility whatsoever for potential errors or possible lack of information in this document.

We reserve all rights in this document and in the subject matter and illustrations contained therein. Any reproduction, disclosure to third parties or utilization of its contents – in whole or in parts – is forbidden without prior written consent of ABB AG.

Copyright© 2016 ABB
All rights reserved

X-ON Electronics

Largest Supplier of Electrical and Electronic Components

Click to view similar products for [ABB manufacturer](#):

Other Similar products are found below :

[00 070](#) [00 071](#) [001-125-01](#) [00800](#) [00802](#) [00808](#) [00810](#) [00816](#) [00820](#) [00821](#) [00846](#) [00850](#) [00851](#) [00852](#) [021-523-01](#) [035-72775-2](#) [035-72775-21](#) [035-72775-3](#) [035-72775-625](#) [035-73747](#) [05065](#) [05067](#) [05083](#) [05145](#) [05163](#) [05167](#) [05169](#) [05185](#) [053-71411-3](#) [053-71814-132](#) [0913M](#) [10-100](#) [103-W-1/2](#) [10-405](#) [10-411](#) [10-417](#) [104-W-3/4](#) [104-W-FB-3/4](#) [10NPW](#) [10RC-10](#) [10RC-10F](#) [10RC-10FL](#) [10RC-14](#) [10RC-14X](#) [10RC-250F](#) [10RC-251T](#) [10RC-2577](#) [10RC-38X](#) [10RC-6](#) [10RC-6FLX](#)