

Contact us

ABB SACE a division of ABB S.p.A.
ABB STOTZ-KONTAKT GmbH

In consideration of modifications to Standards and materials, the characteristics and overall dimensions indicated in this catalogue may be considered binding only following confirmation by ABB

Copyright 2014 ABB. All rights reserved.

2CSC400002D0211 - 03/2014 - 8.000 P.z. - CAL

System pro *M* compact®

Catalogue | 2014

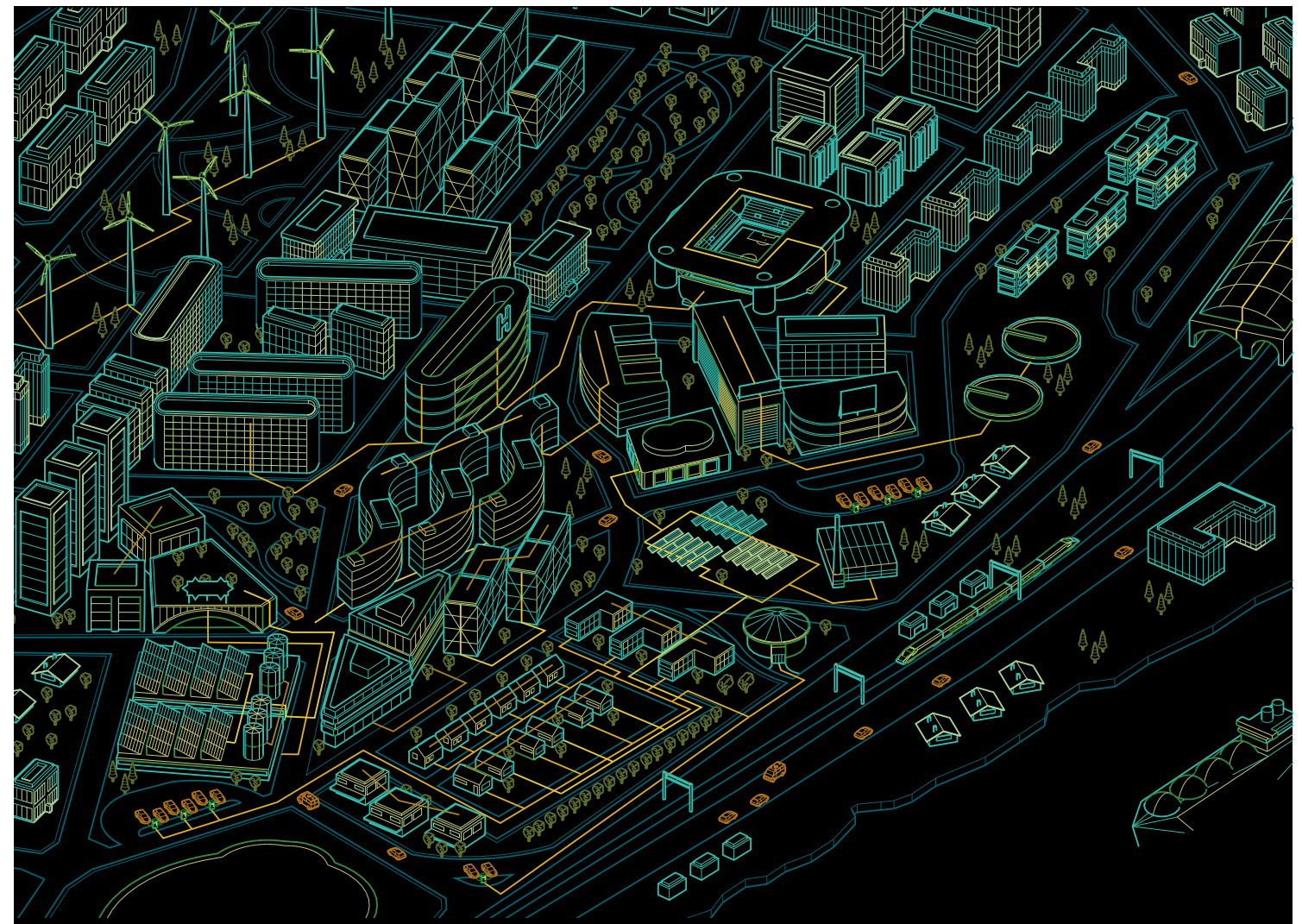

Catalogue - 2014

System pro *M* compact® DIN Rail components for low voltage installation

System pro M compact®

DIN rail components for low voltage installation

Introduction	1
Miniature circuit breakers	2
Residual current devices	3
Accessories for MCBs and RCDs	4
Protection and safety	5
Command and signalling	6
Control and automation	7
Energy efficiency	8
Plug-in systems	9
Technical details	10
Quick product references	11

System pro *M* compact® Introduction

Index	
News	1/2
The best solution for every application	1/7
Presentation	1/14
Advantages	1/16
Perfect places for our DIN rail components	1/18

1

System pro M compact® News

1

The product range is growing and growing.
New functions, new characteristics, new possibilities.



DS201 T

DS201 T RCBOs in only two modules are able to provide complete protection against overcurrents and earth fault currents. In the DS201 T range of RCBOs for traction, specific plastic materials are used that are classified I2-F3 according to the NF F 16-101/102 ("Railway Rolling Stock Fire Behavior-Choice of Materials, and "Railway Rolling Stock Fire Behavior-Choice of Materials, Application to Electrical Equipment,") thus responding to exigence 3. Therefore, DS201 T can be used in rolling stock and specifically in those areas where there are more stringent requirements, like passenger area and staff area.

- Exigence 3 according to NF F 16-101/102 (I2-F3)
- Tested according to IEC 61373 - 2010 - 05 Edition 2.0 considering Category 1, Class A and Class B.
- Laser printed information on the device
- Bi-directional cylindrical terminals
- Differential trip indicator
- Contact position indicator (CPI)
- Label carrier
- System pro M compact® accessories



DDA200 B APR

DDA200 B APR type is suitable for coupling to all S200 miniature circuit breakers up to 63 A. RCD blocks B type are able to provide protection even in case of smooth direct earth fault currents and high frequency residual sinusoidal alternating currents.

- Complete protection against all types of leakage currents.
- Strong resistance against unwanted trippings.
- Remote tripping terminals on the 40 A and 63 A versions



S200M UC

The S200M UC impresses with its performance range and high number of approvals. Moreover, its flexible application for both DC and AC makes it a valuable addition to the System pro M compact® range. Whether warehousing and project engineering, planning and installation or maintaining equipment, the S200M UC is an easy to use and flexible solution.

- For DC and AC applications
- Improved terminal technology
- Excellent technical data
- Wide range of approvals
- Contact position indication
- One module width even with integrated auxiliary contact
- Fully compatible with System pro M compact® accessories



S800B

Designed to meet the current needs of sub-distribution cabinets and IEC 60947-2 requirements up to 16k A and 125 A at 230/400 V AC.

- MCB with 16k A breaking capacity up to 125 Amps
- No polarity: can be supplied from the top or the bottom



S200PR and SU200PR

S200PR and SU200PR are high-performance circuit breakers with ring cable lug connections conforming to UL and CSA standards. The integrated captive mounting screw simplifies the connection of electric lines, provides extra protection and saves time. The circuit breaker is a valuable addition to the proven System pro M compact® range which allow most of the UL and CSA approved components to be combined effortlessly with the new model line.

- Captive screws in the load side and supply side terminal
- Terminals touch safe (even with connected isolated ring lugs)
- S200PR Approved acc. to UL 1077, CSA 22.2 No. 235 and IEC/EN 60947-2
- SU200PR Approved acc. to UL 489, CSA 22.2 No.5 and IEC/EN 60947-2
- Wide range of ring lugs (AWG 18 – AWG 4)
- Compatible with most of the System pro M compact® accessories



OVR PV T1

The OVR PV T1 complete the OVR PV specific range for photovoltaic networks. Thanks to the specific DC thermal disconnection, with quick response time and the insulation of the disconnection device from the varistor, they ensure a safe and reliable protection to the equipment.

- Specific PV disconnection
- Type 1 PV SPD with impulse current of 6.25 kA
- Autoprotected up to 100A DC solar networks
- Suitable for 600V and 1000V DC networks
- Comply with UTE C 61 740-51
- Auxiliary contact for remote indication



OVR - Surge Protective Devices (SPDs)

The new OVR Plus Type 2 surge protective device, with its integrated backup protection, improve safety and transient overvoltage protection to the equipment.

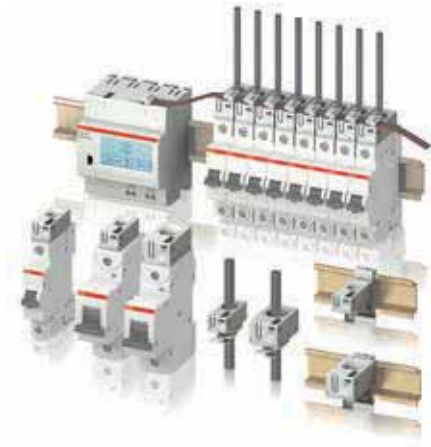

CMS - Current Measurement System

The CMS is an unique multichannel branch monitoring system for AC and DC currents. Installation and integration in new and existing power distribution units (PDUs) has never been easier. Various sensor types allow the mounting in every installation environment. Special attention was paid to create an intuitive concept for operations. Complex user training is not necessary, neither for commissioning nor for the later operational use. The measurement data can be remotely queried by a RS 485 interface (Modbus RTU).

- Space saving - only 18/25 mm wide units
- Huge measurement range up to 160A
- AC and DC measurement
- Ideal solution for retrofitting
- Quick installation & start up time
- User friendly system due to intuitive operation concept
- Contactless measurement for high reliability



SMISLINE TP – Touch proof system, Power and Safety

With the new SMISLINE TP system, components can now be plugged in or unplugged load-free without any risk from electrical current running through the body. The pluggable socket system is completely fingersafe (IP20B)

The system allows the uncomplicated, modular, flexible distribution of power. Plugging in the devices quickly and without problems is essential for time-saving, cost-effective planning and execution.

- Totally finger-safe: when devices are plugged in and unplugged, the system is always touch-proof
- Ideal solution for Data Centers, Telecoms, Airports, Hospitals, Heavy Process Automation and all other applications where power continuity is a must



SD200 - Switch disconnectors

The SD 200 and SHD 200 extends the proven System pro M compact® series by new ranges of switch disconnectors which provides state-of-the-art safety and comfort. The new range is available with 1 to 4 poles with rated currents from 16 to 63 A and provides disconnection properties according to IEC EN 60947-3.

The SD 200 offers performance on a new level. With a rated voltage of 253/440 V AC, a rated conditional short-circuit current of 25 kA, terminals with protection from misconnection and a “Real CPI” contact position indication SD 200 is unique in its field of application. In addition the range is fully compatible with all MCB accessories.

- Performance at new level: rated voltages of 253/440 V ac and short circuit current of 25 kA
- No problem in connection thanks to the terminal protection
- Fully compatibility with MCB accessories
- Real CPI to verify the contact position
- The laser printing and the design of the devices allow a consistent optical appearance in the distribution board.



M2M - Network analyser

The new M2M network analyser, thanks to its advanced functions, is the perfect solution for the effective measurement of the main single-phase or three-phase electrical parameters.

Fitted to low- and medium-voltage electrical panels, M2M allows the measurement and analysis in real time of electrical parameters while it keeps the system's consumption under control, also verifying the quality of the energy thanks to THD measurement. Aside from optimising the use of loads, real time measurement contributes to containing both environmental and budgetary impact.

All information gathered by the analyser can be transmitted quickly to remote locations through the more widespread communications protocols. Interaction with the control and supervision systems is possible via different inputs and outputs, all programmable.

- Reduced depth: only 57 mm inside the panel for easy installation even in limited spaces
- Communication without limits thanks to the availability of different protocols: Modbus RTU, Modbus TCP/IP and Profibus DP.
- Bidirectional reading allows to keep track of produced and consumed (and their balance) active and reactive energy.
- Real time display of energy consumption also in Euros and kg CO₂
- Intuitive and easy-to-use front keypad for navigating screens and configuring the device
- Multilingual backlit display with two lines of scrolling text
- Digital inputs allow pulse acquisition from other energy counters or users.
- Digital and relay outputs and to remotely for control of active and reactive energy consumption and programmable as threshold alarms

1



CT PRO XT and CT MAX - Transformers

The wide and comprehensive range of current transformers ABB is renewed with the introduction of CT PRO XT and CT MAX, cutting-edge products especially designed to ensure ease of installation, maximum performance and safety thanks to the introduction of innovative electronic protection circuit built-in in the new SELV versions.

Ideal for the installation in distribution switchboards and power centers, the new current transformers are characterized by extremely compact dimensions, double possibility of connection to the secondary winding, thanks to the introduction of screwless terminals in addition to the classic screw ones, and a wide range of accessories which guarantee the possibility of installation in any type of application.

- Compact design and maximum ease of installation
- Wide range of installation accessories provided with the product
- Double possibility of connection to the secondary circuit thanks to the introduction of new screwless terminals
- Maximum safety with the SELV versions of CT PRO XT and CT MAX

ABB Circuit Breakers

More than 90 years of innovation

1 1922 Invention and development of the first circuit breaker, manufactured in Mannheim, Germany, by Hugo Stotz

1943 Start of production at Heidelberg, Germany

1999 Launch of the System pro *M* compact® range

2010 The improved generation of System pro *M* compact®

2012 Next generation S 200 / S 200 M, S 200 M UC and S 200 PR as well as SU 200 PR of System pro *M* compact®



The first "Stotz" circuit breaker



The Stotz Kontakt factory (Heidelberg, Germany)

Why ABB?

Because we have the most comprehensive and flexible range currently on the market, with presence in all the segments.

Because we have more than 90 years experience of innovation in the electrical sector always offering the maximum quality for our customers.

Because our products come with all the relevant certificates and approvals which allow their installation anywhere in the world.

The best solution for every application

A world of advantages

Residential, tertiary and industrial sector

Our extensive range of modular DIN Rail components, with protection, command, control and measurement functions, is perfect for meeting all the current requirements of electrical installations, in residential, tertiary and industrial sector.



1

Railways

The breadth of our product portfolio has allowed us to become leader in the railway sector. This is thanks to the high-performance S200M-UC AC and DC circuit breaker, as well as the S200MT series, particularly suitable for conditions of fire and smoke, in compliance with the French NF F 16-101/102 standard.

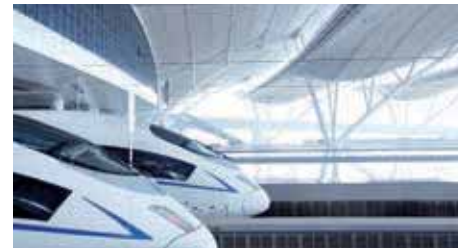

Solutions for solar energy

At ABB we provide products specifically designed for protection and operation of AC and DC circuits in solar power plants. These include circuit breakers and switch disconnectors such as S800PV up to 1,200 V DC, E90PV fuseholders, E9F PV fuses, OVR-PV surge protective devices, etc.



Wind power

The outstanding performance of our high voltages devices and our constant innovation have allowed us to become world leader in electrical switchgear for wind-energy sector. The high performance of our S800 circuit breaker series, characterized by the high breaking capacity of 690 V AC, and their combination with the new S800-SCL-SR self-resetting short-circuit current limiter make our range of modular DIN Rail components perfect for the needs of the sector.



Critical Power/Data Centres

In electrical installations such as data centres, banks, hospitals and airports where service continuity is critical, a system that allows the switchgear to connect and disconnect voltages in a totally safe manner is required. The SMISLINE Touch Proof pluggable socket system ensures an installation safe, flexible and without interruptions.



UL/CSA standards for US and Canada

In order to meet international certification requirements, our modular DIN Rail product portfolio is compliant with a large number of standards from all over the world, with the highly sought-after UL certification met by the S200U, S200UP and S800U circuit breakers and the F200 residual current devices.



The best solution for every application

A world of advantages

1 Miniature circuit-brakers

1 S200 Series

Circuit breakers up to 63 A
S200, S200M and S200P:
For residential, commercial
and industrial use up to 25
kA.
S200U, S200UP and SU-
200PR with certification acc.
to: Certification UL489/CSA
22.2 No. 5 (US and Canada).

2 SN201 Series

SN201 series circuit breakers including one pole and neutral in one
module width up to 40A specific for household applications and
tertiary sector.

3 S800 Series

S800 circuit breakers
with high breaking capacity up to
125A
S800B : 16 kA breaking capacity.
S800C : 25 kA breaking capacity.
S800N : 36 kA breaking capacity.
S800S : 50 kA breaking capacity.

Residual Current protection

4 F200 Series

Residual current devices up to 125 A
F200: Residential, tertiary and indus-
trial.

5 DDA200 and DDA800 Series

RCD blocks adaptable to the S200 and
S800 circuit-breaker series up to 63A and
100A respectively.



Increased terminal opening for higher wire
gauges up to 35mm².
For conductors with or without connector
sleeves.
Fulfills still the requirements for protection de-
gree IP20 (finger safe) acc. to IEC/EN 60529.
Integrated plate protecting flexible cables from
damage and homogenous pressure in the termi-
nal opening.



Multiple certification marks visible on the
upper and lower face of the S200 circuit
breakers.
Laser marking for reliable readability.
Real contact position indication, directly
connected to the moving contact, for more
comfort and safety. Individual identification
code for each MCB on the front.



Switch with intermediate trip
position (TRIP).
S800 circuit breakers diffe-
rentiate manual actuation
from over-current trip.



Label-holder built into SN200
circuit breakers.
Easy identification of protected
circuits.
One pole plus neutral in a width of
just 17.6 mm.



The green/red switch co-
lour clearly indicates the
connected/disconnected
status.



Terminal on the front face
for fail-safe function.



Failsafe bi-directional cylinder-
lift terminal at top and bottom
(available for the entire System
pro M compact range). Ideal for
connection of cables and busbars
simultaneously.

Other protection devices

1

6 DS200 Series

Circuit breakers and residual current protection in a single device, just two modules width. Suitable for residential, tertiary and industrial applications.

7 RD3 residual current relays

Residual current relays with the possibility to set sensitivity and intervention time. Ideal to obtain time and sensitivity combinations and to achieve selectivity with other residual current devices.

8 OVR series surge protective devices

Protection of electrical equipment against surges caused by lightning or other grid disruptions.

9 E90 fuseholders and fuse disconnectors

E90: Disconnector series up to 32A.
E90h: Compact series up to 32A.
E930: Series up to 125A.

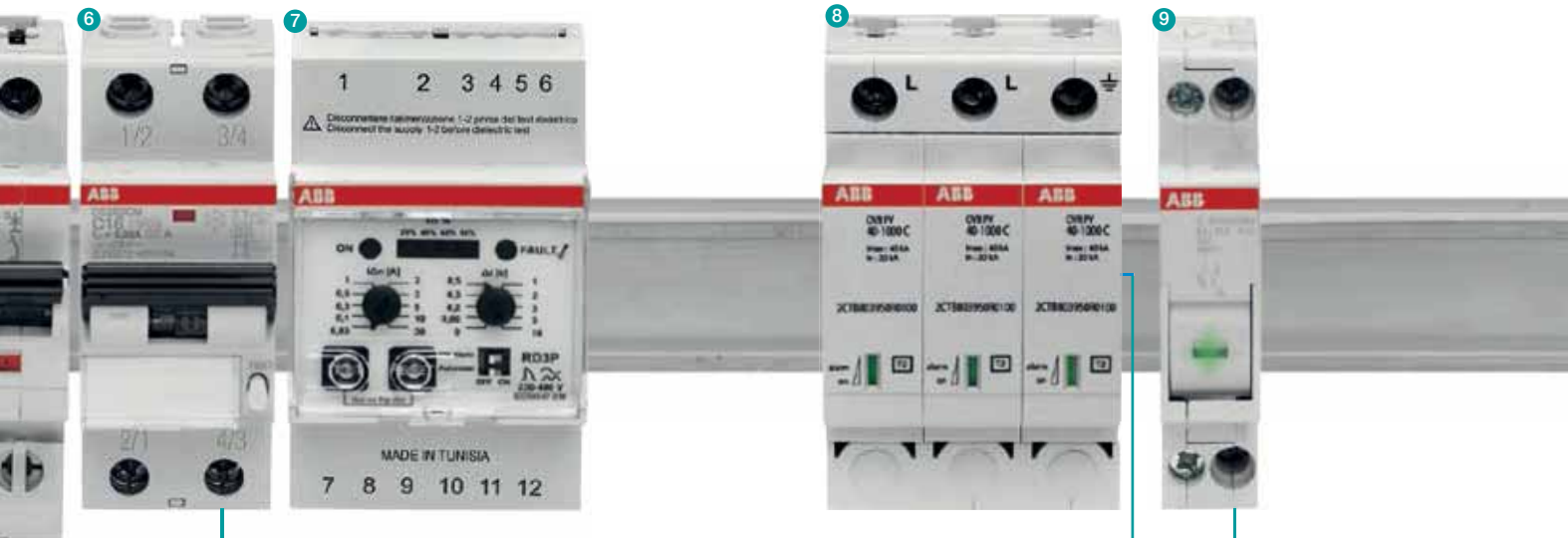

Displays the cause of the trip of the DS200 residual current breaker. Blue (residual current trip) or black (over-current trip indications).



Includes RFID label. Prevents forgeries through the inclusion of a serial number in compliance with the ISO/IEC FCD 15693-3 standard.



Contact position indicator visible on the front of the DS200 residual current breaker.



Blown fuse indicator light on the front part of the E90 fuseholder.



Visual indicator of the remaining life of the OVR surge protective device. Option to include remote signalling contacts of the OVR status.

The best solution for every application

A world of advantages

1

Command and control

10 Contactors, latching relays and installation relays

ESB and EN series contactors.
E259 series installation relays.
E250 and E260 series latching relays.

11 E200 series switch disconnectors

From 1 to 4 poles.
Up to 125 A.

12 E210 series on-off switches, push buttons and indicator lamps

E211 and E218 series on-off switches.
E213 series change over switches.
E214 series group switches.
E215 and E217 series push buttons.
E219 series single, double and triple indicator lights.

13 D-Line digital and AT analogue time switches

D1 and D2 weekly digital time switches.
D365 yearly digital time switches.
AT analogue time switches.

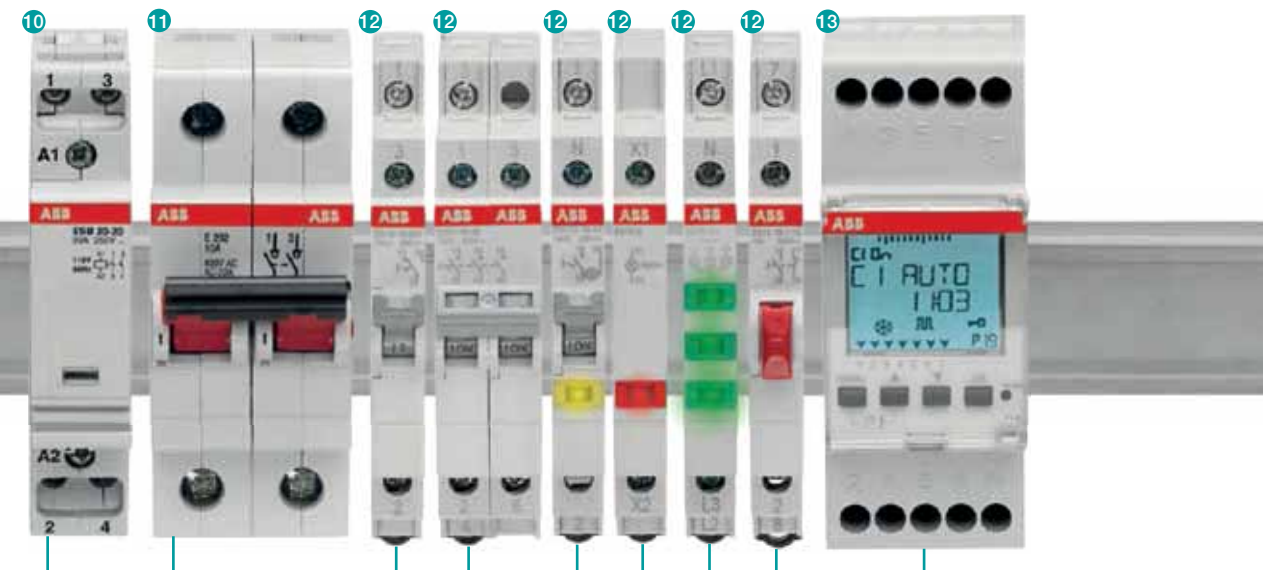

Currents up to 125A.
From 1 to 4 poles.
Option to include an add-on of up to 3 auxiliary contacts.

Extremely quiet.
Variety of control voltages.
Multiple combinations of NO and NC contacts.
Function modes selector:
Automatic/Manual/Disconnected (EN series).

Multiple command and control functions in the ultra-compact design (9mm width) of the E210 series.

Up to 3 E219 LED indicator lights in a width of just 9 mm. LED indicators guarantee an optimal illumination with very low consumption.

**14 TWA astronomical switches
and TW twilight switches**

TWA astronomical switches to activate lighting systems according to the rising and setting of the sun.

TW twilight switches to control lighting devices according to the level of the ambient light.

**15 E234 series electronic timers
and E232 series staircase switches**

Wide range of E234.

E232 staircase timers for household applications.



D-Line series weekly and annual digital time switches.
Multiple communication options.
Wide range of programs: standard, cyclic, casual and holiday.
White backlit LCD display.

Easy to program.
Ideal for public lighting, stores lighting, monuments, etc.

Connection and disconnection time delays.
Continuous and impulse signals among multiple options.

The best solution for every application

A world of advantages

1

Measurement

16 EQ digital electricity meters

C series, extremely compact meters.
B series, compact with communication features.
A series, functionality beyond comparison.
Functionalities associated to a "metal scale" assigned to each model (steel, bronze, silver, gold and platinum).

17 Digital and analogue measuring instruments

AMTD and AMT ammeters.
VLMD and VLM voltmeters.
FRZ frequency meters.
DMTME multimeters.
E233 and HTM hour counters.
Current and voltage transformers.



Single-phase and three-phase metering.
Direct reading up to 80A or indirect reading through current and/or voltage transformers.
High precision with an accuracy class up to 0.5.
Reading of generated/consumed and active/reactive energy.
Up to four tariffs.
Up to eight channels of load profiles.
Previous values for several quantities.
Possibility of built-in serial communication interfaces.
Multiple communication options.
Possibility of internal clock for advanced functionalities.

C11 single-phase digital electricity meter with ultra-compact design just one module wide.
C13 three-phase digital meter with ultra-compact design just three modules wide.
Both unique on the market.

Other functions

1

18 Extensive range of other modular devices

Modular sockets.
Light dimmers.
Priority switches and overload relays.
Control, isolating and safety transformers.
etc.

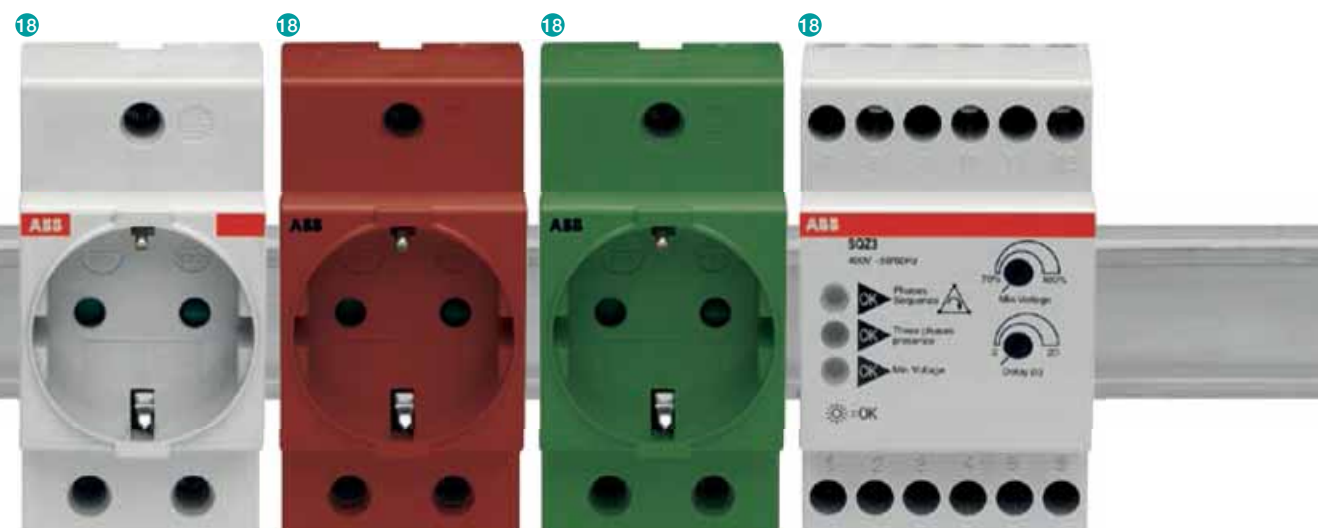

The range includes products complying with the most widespread standards (German, Italian, French...).

Different colours for easy identification.

Safety shutters and optional cover.

System pro M compact® Presentation

1 A wide product range suitable for all applications

For all applications in residential, industrial and commercial installations ABB System pro M compact® range offers many functionalities like:

- protection and switching
- checking and monitoring
- control and programming

Moreover, shape and dimensions of the devices allow a perfect integration in existing installations.

The technologically innovative bidirectional cylinder-lift terminal available in the System pro M compact® devices enables synchronous closing of the front and rear wiring input.

Highest safety standard for the installer thanks to protection against electric shock according to EN 41140.

Marking of devices is reliable and clear.

Both supply and connection with busbars from top or bottom is admitted.



The System pro M compact® range

MCBs

Miniature circuit-breakers.

RCDs

- Residual current circuit-breakers (RCCBs);
- RCD-blocks;
- Residual current circuit-breakers with overcurrent protection (RCBOs);
- Residual current relays (modular and front panel) with external toroid.

Auxiliary elements

A whole range of accessories and auxiliary elements.

SPDs

Surge protective devices.

Protection devices

In addition to MCBs and RCDs, ABB supplies other modular devices for protection such as fuse holders, fuses, switch disconnectors, insulation monitoring devices etc.

Command devices

This category includes devices that are operated manually to command the electric system: contactors, latching relays,

switch-isolators, switches, pushbuttons etc. Typically they are installed to control lights from several points of the same circuit or to pilot user devices with a high number of operations.

1

Load management devices

Overload relays, load management switches, anti black-out lamps, time switches and the other modular devices in this category react automatically to variations of parameters and other events in the system to allow for plant optimisation.

Measurement devices

Energy meters, network analyzers, multimeters are all found in this category of devices to provide different measurement data from used energy to network quality of the electric system.

Other devices

The System pro M compact® range also includes bells, transformers, modular sockets etc.

Various accessories



System pro M compact® Advantages

- 1 The System pro M compact® range offers enormous advantages in relation to installation. Advanced and smart solutions allow a far easier and safer installation and guarantee time saving.



MCBs are also available with an integrated auxiliary contact (1 NO or 1 NC). Existing installations can be easily upgraded to include auxiliary switch functionality.



RCD-blocks DDA 200 2P, 3P, 4P up to 40 A fit into two modules. Versions in 63 A sizes are supplied with two additional terminals for remote tripping.



Safety connections between DDA 200 and S 200 thanks to a safe plastic key system.



Availability of a wide range of RCBOs.



Universal signal/auxiliary and auxiliary contacts fit on S 200, F 200 and DS 200.



Supply from top or bottom either with cables or busbars.

The bi-directional cylinder-lift terminal allows easier and quicker connections. In addition it avoids errors because it prevents the use of free cable seats.

This high protection level against errors eliminates right from the start industrial accidents deriving from incorrect wiring.

The terminal guarantees a very high tightening torque for cables with a section up to 25 mm².

The housing of connection busbars in the rear seat guarantees easier wiring.

1



Safe terminal technology: the terminals offer protection from misconnection.



Error proof terminals: they avoid the use of free cable seats.



Supply from top or bottom also possible with busbars.



Without busbars two terminal spaces can be used for cables with different cross sections: incoming supply with supplementary terminal up to 50 mm² from the front side.



Special quick fastening for an easy removal of the devices from the assembly pressing upwards, both for MCBs S 200 and RCCBs F 200: the only in the market that can be removed without a screwdriver.



More working space between component rows.

System pro M compact®

Perfect places for our DIN rail components

1 Distribution Switchgear

ABB proposes different series of switchgear with different characteristics thought up to make it possible to select the most suitable switchgear for the installation requirements.

Different sizes for optimal use of the spaces available. Great savings in storage space is ensured by the rapid assembly kit containing so few pieces that skilled personnel is not required. IP degrees of protection for all types of application up to IP65. Extremely sturdy and flexible, it is made for plants up to 4000 A.

Switchgears are suitable for primary distribution (Power Center type) with air and moulded-case circuit-breakers and any internal segregations and for secondary distribution with moulded-case and modular circuit-breakers.



Automation Enclosures

ABB proposes an entire range of Automation enclosures that fits all your needs for all automation applications: on-board machine switchboards, automated production lines, heating plants, control and operation panel boards for complex industrial plant,

SR2 Enclosures

The range of SR2 enclosures is a complete offer of monobloc enclosures for constructing small and medium-sized electric automation, switching and control switchboards. The typical use of SR2 Enclosures is to make switchgear and controlgear switchboards for a very wide variety of industrial machines: from large machinery with automated production lines or parts of these, down to the typical installations of on-board machine switchboards, boilers, heating plants and so on.

AM2 Cabinets

The range of AM2 cabinets allows construction of electric switchboards for operation and control of technological plants, covering the middle market segment of automation switchboards.

These monobloc enclosures are suitable for making floor-mounted electric switchboards, offering numerous customization possibilities based on individual needs and habits.

1



System pro M compact®

Perfect places for our DIN rail components

1 IS2 Enclosures

ABB has a wide offer of cabinets for automation with the new IS2 series, now also available in kit versions. The IS2 panel boards are suitable for making electrical automation, control and operation panel boards, with the possibility of constructing batteries of cabinets side by side to control complex industrial plants. They are suitable for floor mounting with the possibility of lateral and rear access and adjustment of the back plate position.



Gemini

Gemini range is revolutionizing the market of low voltage electric insulating switchboards. The reason for this is that it is the first switchboard made of thermoplastic material, to which the co-injection molding technique gives the same mechanical characteristics as polyester. This means that it is extremely sturdy, with its rigid covering and expanded internal core. Moreover, it contains no fiberglass, a material that with time rises to the surface, jeopardizing operation and safety of switchboards made of polyester with which it is usually mixed. Gemini switchboards have a very high resistance to chemical and atmospheric agents. This is the reason why Gemini guarantees excellent performances even in particularly severe operating conditions.



Consumer Units

ABB offers a range of consumer units and switchboards for the installation of modular components that enables to implement any type of application for power distribution in the residential and tertiary environments operating under the highest safety conditions and with significant savings of time.

The several products that form this offer are distinguished by a design, which perfectly fits into any decor, choosing between the wall-mounting version and the flush-mounting version.

To execute the terminal part of an electric plant, ABB offers a range of products that includes empty enclosures and control devices, also in versions for installation in rigid and protective

conduits. Junction and wiring accessories boxes present a safe use even under the most difficult environmental conditions: in particular waterproof boxes guarantee full protection in operations for junction, branch connection and installation of equipments. In a "state of the art" electric plant, even details are carefully implemented. To secure total use safety and operational efficiency of the plant, minor components and accessories for erection of electrical equipment of ABB are made in compliance with the reference international Standards; metal section bars, cable-ties and fixing and cabling accessories are available in a wide assortment to satisfy any kind of application.

1



System pro M compact® Miniature circuit breakers

MCBs S 200

S 200 series, 6 kA	2/22
S 200 M series, 10 kA	2/38
S 200 M UC series, 10 kA	2/50
S 200 P series, 15/25 kA	2/59
S 200 PR series, 10 kA	2/74
S 200 S screwless series, 6 kA	2/77
S 200 U series, 10 kA	2/78
S 200 UP series, 10 kA	2/86
SU 200 PR series, 10 kA	2/92
S 200 UDC series, 60 V DC	2/95

2

MCBs SN 201

SN 201 L series, 4.5 kA	2/102
SN 201 series, 6 kA	2/103
SN 2001 M series, 10 kA	2/105

MCBs S 280

S 280 series, 6 kA	2/107
S 280 UC series, AC/DC	2/110

SMCBs S 750 DR

S 750 DR series	2/117
-----------------	-------

SMCBs S 700

S 700 series	2/120
S 700 + H2WR series	2/124
WT63	2/128

MCBs S 800

S800S series, 50 kA	2/134
S800N series, 36 kA	2/159
S800C series, 25 kA	2/165
S800B series, 16 kA	2/173
S800U series, 50 kA	2/182
S800PV series, 5 kA, DC	2/187

MCBs S 500

S500 series	2/196
S500UC series	2/199

System pro M compact®

Quick selection of MCBs for household and industrial applications

Easy! Find the right range and the corresponding catalogue page at a glance using this selection chart.

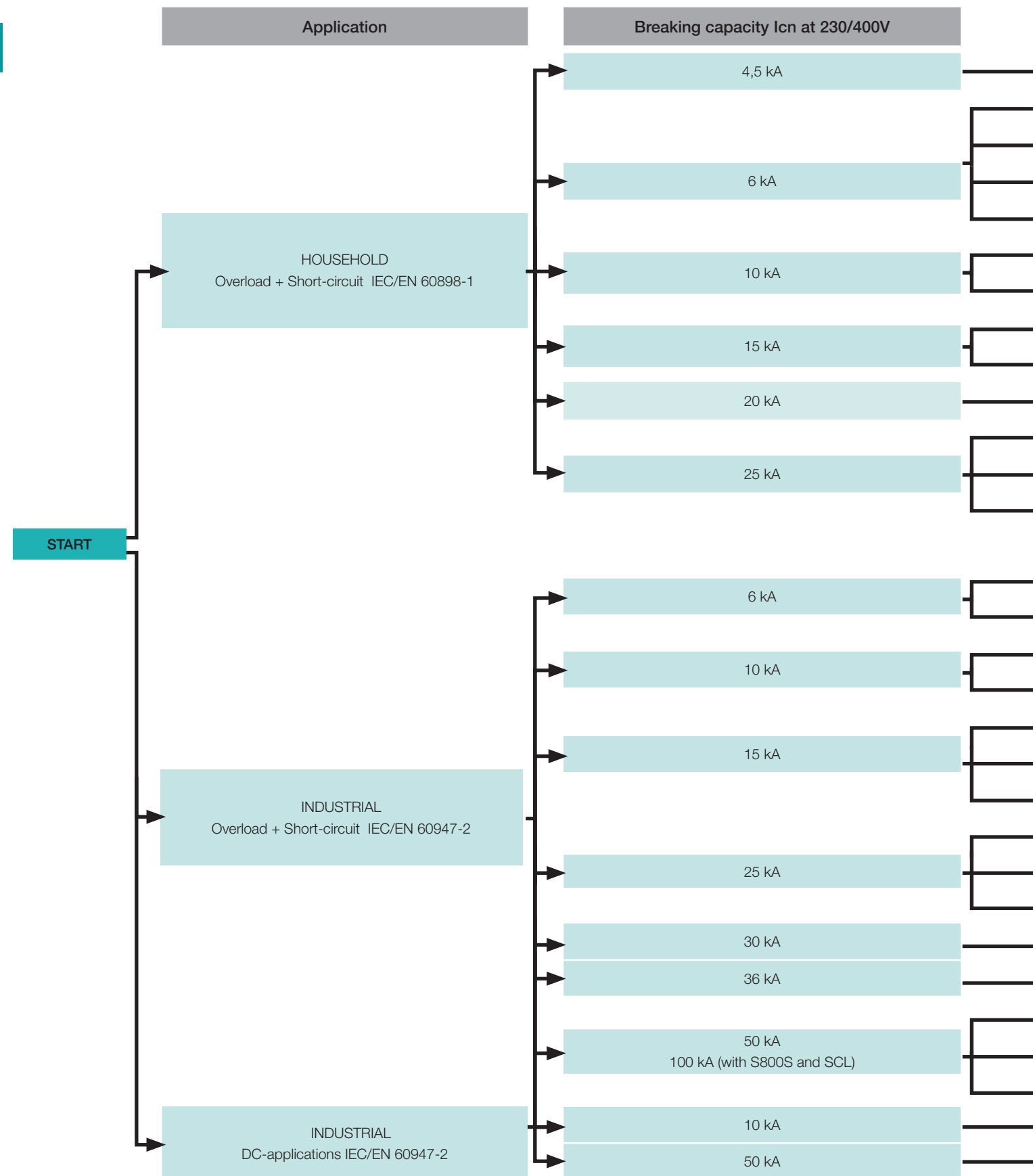

Rated current	Poles	Solution	Page
Up to 40 A	1P+N	SN 201 L	2/56
Up to 40 A	1P+N	SN 201	2/57
Up to 20 A	1P, 3P	S 200 S	2/73
Up to 63 A	All poles	S 200	2/12
Up to 100 A	All poles	S 280	2/102
Up to 40 A	1P+N	SN 201 M	2/59
Up to 63 A	All poles	S 200 M	2/32
Up to 63 A	All poles	S 200 P	2/57
Up to 125 A	All poles	S800C	2/106
Up to 125 A	All poles	S800N	2/103
Up to 25 A	All poles	S 200 P	2/57
Up to 63 A/100 A	All poles	S 750 DR/S 700 ①	2/112, 2/115
Up to 125 A	All poles	S800S	2/82

Up to 40 A	1P+N	SN 201 L	2/56
Up to 100 A	All poles	S 280	2/102
Up to 40 A	1P+N	SN 201, SN 201 M	2/57, 2/59
Up to 63 A	All poles	S 200, S 200 M	2/12, 2/32
Up to 40 A	All poles	S 200 M	2/32
Up to 63 A	All poles	S 200 P	2/57
Up to 63 A	1P, 2P, 3P, 4P	S 200 PR	2/70
Up to 25 A	All poles	S 200 P	2/57
Up to 63 A/100 A	All poles	S 750 DR/S 700 ①	2/112, 2/115
Up to 125 A	All poles	S800C	2/106
Up to 45 A	All poles	S500	2/120
Up to 125 A	All poles	S800N	2/103
Up to 125 A	All poles	S800S	2/86
Up to 125 A	All poles	S800SCL + S800S	2/106, 2/82
Up to 11 A	All poles	S500	2/120
Up to 63 A	1P, 2P, 3P, 4P	S 200 M UC	2/46
Up to 125 A	All poles	S800S-UC	2/46

① with specific short-circuit selectivity function

System pro M compact®

Quick selection of MCBs for UL applications (UL 489/CSA 22.2 No. 5)

2

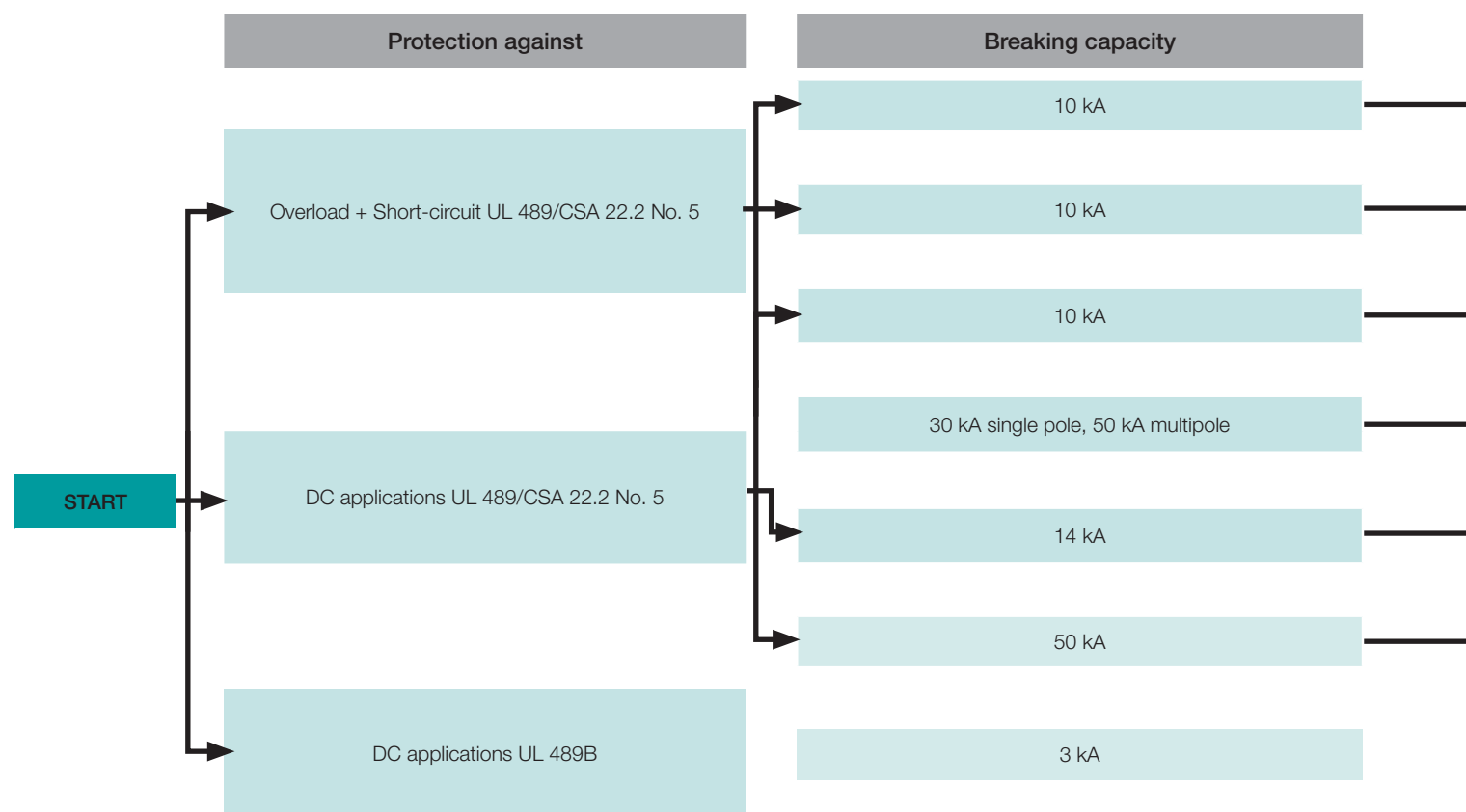

Rated current	Remark	Poles	Solution	Page
Up to 63 A		1P, 2P, 3P, 4P	S 200 U	2/76
Up to 25 A		1P, 2P, 3P, 4P	S 200 UP	2/82
Up to 63 A	Ring Tongue	1P, 2P, 3P, 4P	SU 200 PR	2/88
Up to 100 A		All poles	S800U	2/00
Up to 63 A		1P, 2P	S 200 UDC	2/91
Up to 100 A		1P, 2P, 3P, 4P	S 800 U	2/...
5 A		4P	S804U-PVS5	2/00

Miniature circuit-breakers

Selection table



2

Series			S 200	S 200 M	S 200 M UC	S 200 P			S 200 PR	S 200 S		
Characteristics			B,C,D, K,Z	B,C,D, K,Z	B,C, K, Z	B,C,D, K,Z	B,C,D, K,Z	B,C,D, K,Z	K	B,C		
Rated current	[A]		0.5 ≤ In ≤ 63	0.5 ≤ In ≤ 63	0.2 ≤ In ≤ 63	0.2 ≤ In ≤ 25	32 ≤ In ≤ 40	50 ≤ In ≤ 63	0.2 ≤ In ≤ 63	6 ≤ In ≤ 20		
Breaking capacity: [kA]												
Reference standard		Nr. poles	Ue[V]									
IEC/EN 60898	Icn		230/400	6	10	10	25	15	15	6		
IEC/EN 60947-2 Alternating current	Icu	1, 1P+N	133	20	25		40	25	25			
			230	10	15		25	15	15	15		
			253									
		2, 3, 4	230	20	25	10 ⑩/6 ⑪	40	25	25			
			400	10	15		25	15	15	15		
			440	10	15	10 ⑩/6 ⑪						
	2, 3, 4	500	690									
		Ics	1, 1P+N	133	15	18.7 ⑫		20	18.7	18.7		
				230	7.5	11.2 ⑬		12.5	11.2	7.5		
				253			7.5 ⑭/6 ⑮				7.5 ⑯ 11.2 ⑰	
2, 3, 4	230	400	440	15	18.7 ⑫		20	18.7	18.7			
				7.5	11.2 ⑬		12.5	11.2	7.5			
				7.5	11.2 ⑬	7.5 ⑭/6 ⑮				7.5 ⑯ 11.2 ⑰		
	2, 3, 4	500	690									
IEC/EN 60947-2 Direct current T=I/R≤5ms for all series, except S280 UC and S800S-UC, where T=I/R<15ms	Icu	1, 1P+N	24	20								
			60	10	10		15	10	10			
			125									
		2	220			10						
			250									
			48	20								
	3,4	125	250	440	10	10		15	10	10		
		3,4	375	500	750	1200						

- ① only up to 40 A; 10 kA up to 50/63 A
- ② only for "D" characteristic
- ③ values are not for all rated currents
- ④ 600 V DC for 100, 125 A
- ⑤ 1000 V DC for 100, 125 A
- ⑥ 3 poles
- ⑦ 4 poles
- ⑧ max. values. Detailed values on page 2/12
- ⑨ relevant product standard: E DIN VDE 0645 (based on IEC/EN 60898-1 and IEC/EN 60947-2)
- ⑩ by 250 V DC 1-pole, 600 V 3- and 4-pole
- ⑪ by 600 V DC 2-pole
- ⑫ ≤ 25 A
- ⑬ > 25 A
- ⑭ char. B, C
- ⑮ only 2 poles (connection in series)
- ⑯ UL 1077 only
- ⑰ ≤ 40 A
- ⑱ > 40 A
- ⑲ ≤ 35 A
- ⑳ 10-80 A



2

S 200 U			S 200 UP	SU 200 PR	S 200 UDC	SN 201 L	SN 201	SN 201 M	S 280	S 280 UC	
C,K,Z	C,K,Z	C,K,Z	C,K,Z	K	K,Z	B,C	B,C,D	B,C	B,C	B,K,Z	K,Z
$0.2 \leq I_n \leq 25$	$32 \leq I_n \leq 40$	$50 \leq I_n \leq 63$	$0.2 \leq I_n \leq 25$	$0.2 \leq I_n \leq 63$	$1 \leq I_n \leq 63$	$2 \leq I_n \leq 40$	$2 \leq I_n \leq 40$	$2 \leq I_n \leq 40$	$80 \leq I_n \leq 100$	$0.2 \leq I_n \leq 40$	$50 \leq I_n \leq 63$
						4.5	6	10	6		
40	25	25	40			10	15	20	15	10	6
25	15	15	25	15		6	10	10	6	6	4.5
40	25	25	40						10	10	6
25	15	15	25	15					6	6	4.5
20	18.7	18.7	20			6	10	10	15	7.5	6
12.5	11.2	7.5	12.5			4.5	6	7.5	6	6	4.5
				7.5 [Ⓢ] 11.2 [Ⓢ]							
20	18.7	18.7	20						10	7.5	6
12.5	11.2	7.5	12.5						6	6	4.5
				7.5 [Ⓢ] 11.2 [Ⓢ]							
15	10	10	15			10	15	15			
										6	4.5
15	10	10	15			10	15	15			
										6	4.5

Miniature circuit-breakers

Selection table



2

Series		S 200		S 200 M		S 200 M UC		S 200 P			S 200 PR		S 200 S	
Characteristics		B,C,D, K,Z		B,C,D, K,Z		B,C, K, Z		B,C,D, K,Z	B,C,D, K,Z	B,C,D, K,Z	K	B,C		
Rated current [A]		0.5 ≤ In ≤ 63		0.5 ≤ In ≤ 63		0.2 ≤ In ≤ 63		0.2 ≤ In ≤ 25	32 ≤ In ≤ 40	50 ≤ In ≤ 63	0.2 ≤ In ≤ 63	6 ≤ In ≤ 20		
IEC/EN 60947-2 Direct current T=I/R≤5ms for all series, except S280 UC and S800S-UC, where T=I/R<15ms	1cs	1, 1P+N	24	20				15	10	10				
			60	10	10									
			125											
	2	2	220			10								
			250											
			48	20										
			125	10	10			15	10	10				
			250											
			440			10								
	3,4	3,4	500											
			800											
			1200											
UL 1077/ C22.2 No 235 Alternating current	Int. cap. 1, 1P+N	120	10 ⑩				10	6	6					
		240												
	2, 3, 4	277	6 ⑩	6	10	10	6	6	10					
		480 Y/277	6 ⑩	6	10	10	6	6	10					
UL 1077/ C22.2 No 235 Direct current	Int. cap. 1, 1P+N	60	10 ⑩	10										
		125												
	2, 3, 4	250			10									
		500			10									
UL 489/ C22.2 No 5 Alternating current	Int. cap. 1	240												
		277												
	2, 3, 4	240												
UL 489/ C22.2 No 5 Direct current	Int. cap. 2	60												
		125												

① only up to 40 A; 10 kA up to 50/63 A
 ② only for "D" characteristic
 ③ values are not for all rated currents
 ④ 600 V DC for 100, 125 A
 ⑤ 1000 V DC for 100, 125 A
 ⑥ 3 poles
 ⑦ 4 poles
 ⑧ max. values. Detailed values on page 2/12

⑨ relevant product standard: E DIN VDE 0645 (based on IEC/EN 60898-1 and IEC/EN 60947-2)
 ⑩ by 250 V DC 1-pole, 600 V 3- and 4-pole
 ⑪ by 600 V DC 2-pole
 ⑫ ≤ 25 A
 ⑬ > 25 A
 ⑭ char. B, C
 ⑮ only 2 poles (connection in series)

⑯ UL 1077 only
 ⑰ ≤ 40 A
 ⑱ > 40 A
 ⑲ ≤ 35 A
 ⑳ 10-80 A



2

S 200 U			S 200 UP	SU 200 PR	S 200 UDC	SN 201 L	SN 201	SN 201 M	S 280	S 280 UC	
C,K,Z	C,K,Z	C,K,Z	C,K,Z	K	K,Z	B,C	B,C,D	B,C	B,C	B,K,Z	K,Z
$0.2 \leq I_n \leq 25$	$32 \leq I_n \leq 40$	$50 \leq I_n \leq 63$	$0.2 \leq I_n \leq 25$	$0.2 \leq I_n \leq 63$	$1 \leq I_n \leq 63$	$2 \leq I_n \leq 40$	$2 \leq I_n \leq 40$	$2 \leq I_n \leq 40$	$80 \leq I_n \leq 100$	$0.2 \leq I_n \leq 40$	$50 \leq I_n \leq 63$
15	10	10	15			10	15	15		6	4.5
15	10	10	15			10	15	15		6	4.5
										6	5
										6	5
										10	10
										4.5	4.5
										4.5	4.5
10	10	10	10	10	10						
				10	10 ⊕						
10	10	10	10	10	10						
			10	10	10 ⊕						
					14						
					14 ⊕						

Miniature circuit-breakers

Selection table



2

Series		S750 DR		S700		S800S				S800N		S800C			
Characteristics		E selec- tive, K selective		E selec- tive, K selective ⑧		B,C,D	K	KM	UCB	UCK	B,C,D	B,C,D,K			
Rated current [A]		16 ≤ In ≤ 63		10 ≤ In ≤ 100		6 ≤ In ≤ 125	6 ≤ In ≤ 125	20 ≤ In ≤ 80	10 ≤ In ≤ 125	10 ≤ In ≤ 125	6 ≤ In ≤ 125	10 ≤ In ≤ 125			
Breaking capacity [kA]															
Reference standard		Nr. poles		Ue[V]											
IEC/EN 60898		Icn		230/400		25 ⑩		25 ⑩		20 ⑩		15			
IEC/EN 60947-2 Alternating current		Icu		Ue[V]											
		1, 1P+N		133											
				230	25	50	50	50 ⑩		36	25				
				253											
		2, 3, 4		230		50	50	50 ⑩		36	25				
				400	25	50	50	50 ⑩		36	25				
				440											
		2, 3, 4		500		15 ⑬	15 ⑬								
				690		6 ⑬	6 ⑬			4.5					
		Ics		1, 1P+N		133									
						230	12.5	12.5 ⑩	40	40		30	18		
						253									
2, 3, 4				230		40	40	40 ⑩		30	18				
				400	12.5	12.5 ⑩	40	40	40 ⑩		30	18			
				440											
2, 3, 4		500		11 ⑬	11 ⑬										
		690		4 ⑬	4 ⑬			3							
IEC/EN 60947-2 Direct current T=I/R≤5ms for all series, except S280 UC and S800S-UC, where T=I/R<15ms		Icu		Ue[V]											
		1, 1P+N		24											
				60											
				125		30	30		20	10					
				220											
				250					50	50					
		2		48											
				125											
				250		30	30		20	10					
				440											
				500					50	50					
		3,4		375		30 ⑩	30 ⑩	30 ⑩	50	50	20 ⑩	10 ⑩			
				500		30 ⑪	30 ⑪		50	50	20 ⑪	10 ⑪			
750							50	50							
1200															

① only up to 40 A; 10 kA up to 50/63 A
 ② only for "D" characteristic
 ③ values are not for all rated currents
 ④ 600 V DC for 100, 125 A
 ⑤ 1000 V DC for 100, 125 A
 ⑥ 3 poles
 ⑦ 4 poles
 ⑧ max. values. Detailed values on page 2/12

⑨ relevant product standard: E DIN VDE 0645 (based on IEC/EN 60898-1 and IEC/EN 60947-2)
 ⑩ by 250 V DC 1-pole, 600 V 3- and 4-pole
 ⑪ by 600 V DC 2-pole
 ⑫ ≤ 25 A
 ⑬ > 25 A
 ⑭ char. B, C
 ⑮ only 2 poles (connection in series)

⑯ UL 1077 only
 ⑰ ≤ 40 A
 ⑱ > 40 A
 ⑲ ≤ 35 A
 ⑳ 10-80 A
 ㉑ for S804U-UCZ only)
 ㉒ for S804U-PVS only)



2

S800B	S800U	S800U-UCZ	S804U-PVS	S800PV-S	S500		S500UC
B,C,D,K	Z,K, UCZ, PVS			PV-S	K adjustable		K adjustable
$10 \leq I_n \leq 100/125$ ④	$5 \leq I_n \leq 100$	10-80	5	$10 \leq I_n \leq 125$	$0.1 \leq I_n \leq 11$	$10 \leq I_n \leq 45$	$0.1 \leq I_n \leq 45$
16	30				50	30	
16	50						
16	50				50	30	
					20	15	
					6	6	
10	25						
10	40				30	25	
10					30	25	
					15	11	
					3	3	
							30
							30
				5 ④			30
				5 ⑤			30

Miniature circuit-breakers

Selection table



2

Series		S 750 DR	S 700	S800S				S800S	S800C		
Characteristics		E selec- tive, K selective	E selec- tive, K selective ①	B,C,D	K	KM	UCB	UCK	B,C,D	B,C,D,K	
Rated current [A]		16 ≤ In ≤ 63	10 ≤ In ≤ 100	6 ≤ In ≤ 125	6 ≤ In ≤ 125	20 ≤ In ≤ 80	10 ≤ In ≤ 125	10 ≤ In ≤ 125	6 ≤ In ≤ 125	10 ≤ In ≤ 125	
IEC/EN 60947-2 Direct current T=I/R≤5ms for all series, except S280 UC and S800S-UC, where T=I/R<15ms	1cs 1P+N	24									
		60									
		125		30	30				20	10	
	2	220									
		250						50	50		
		48									
	3,4	125									
		250			30	30				20	10
		440									
	3,4	500						50	50		
		800									
		375			30 ②	30 ②	30 ②	50	50	20 ②	10 ②
3,4	500			30 ③	30 ③		50	50	20 ③	10 ③	
	750						50	50			
	1200										
UL 1077/ C22.2 No 235 Alternating current	Int. cap. 1P+N	1, 120									
		240									
	2, 3, 4	277									
		480 Y/277									
UL 1077/ C22.2 No 235 Direct current	Int. cap. 1P+N	1, 60									
		125									
	2, 3, 4	250									
		500									
UL 489/ C22.2 No 5 Alternating current	Int. cap. 1	240									
		277									
	2, 3, 4	240									
		480 Y/277									
UL 489/ C22.2 No 5 Direct current	Int. cap. 2	1, 60									
		125									
	4	600									
UL 498B	4	1000									

① only up to 40 A; 10 kA up to 50/63 A
 ② only for "D" characteristic
 ③ values are not for all rated currents
 ④ 600 V DC for 100, 125 A
 ⑤ 1000 V DC for 100, 125 A
 ⑥ 3 poles
 ⑦ 4 poles
 ⑧ max. values. Detailed values on page 2/12

⑨ relevant product standard: E DIN VDE 0645 (based on IEC/EN 60898-1 and IEC/EN 60947-2)
 ⑩ by 250 V DC 1-pole, 600 V 3- and 4-pole
 ⑪ by 600 V DC 2-pole
 ⑫ ≤ 25 A
 ⑬ > 25 A
 ⑭ char. B, C
 ⑮ only 2 poles (connection in series)

⑯ UL 1077 only
 ⑰ ≤ 40 A
 ⑱ > 40 A
 ⑲ ≤ 35 A
 ⑳ 10-80 A
 ㉑ for S804U-UCZ only
 ㉒ for S804U-PVS only



2

S800B	S800U	S800U-UCZ	S800U-PVS	S800PV-S	S500		S500UC
B,C,D,K	Z,K			PV-S	K adjustable		K adjustable
10 ≤ In ≤ 100/ 125 ④	10 ≤ In ≤ 100	10-80	5	10 ≤ In ≤ 125	0.1 ≤ In ≤ 11	10 ≤ In ≤ 45	0.1 ≤ In ≤ 45
				5 ④			
				5 ④			
					30 ④	18 ④	
					14 ④	14 ④	
					30 ④	18 ④	
					14 ④	14 ④	
							30 ④
							30 ④
	30						
	50						
		10 ④					
			6 ④				

MCB S 200. The details make the difference

A range designed to ensure efficiency and protection

2
Twin terminal for separate feeding of busbar and conductor

IP20 - finger safety.

Easy identification of the product and highly resistant laser marking.

Save your time – all important data available right away.

Easy product name, easy identification, easy life.

Quick identification thanks to laser printed EAN marking.

Contact position indication

Captive screws: don't lose what's important for you.

Whatever your application need is applicable with a wide range of accessories.

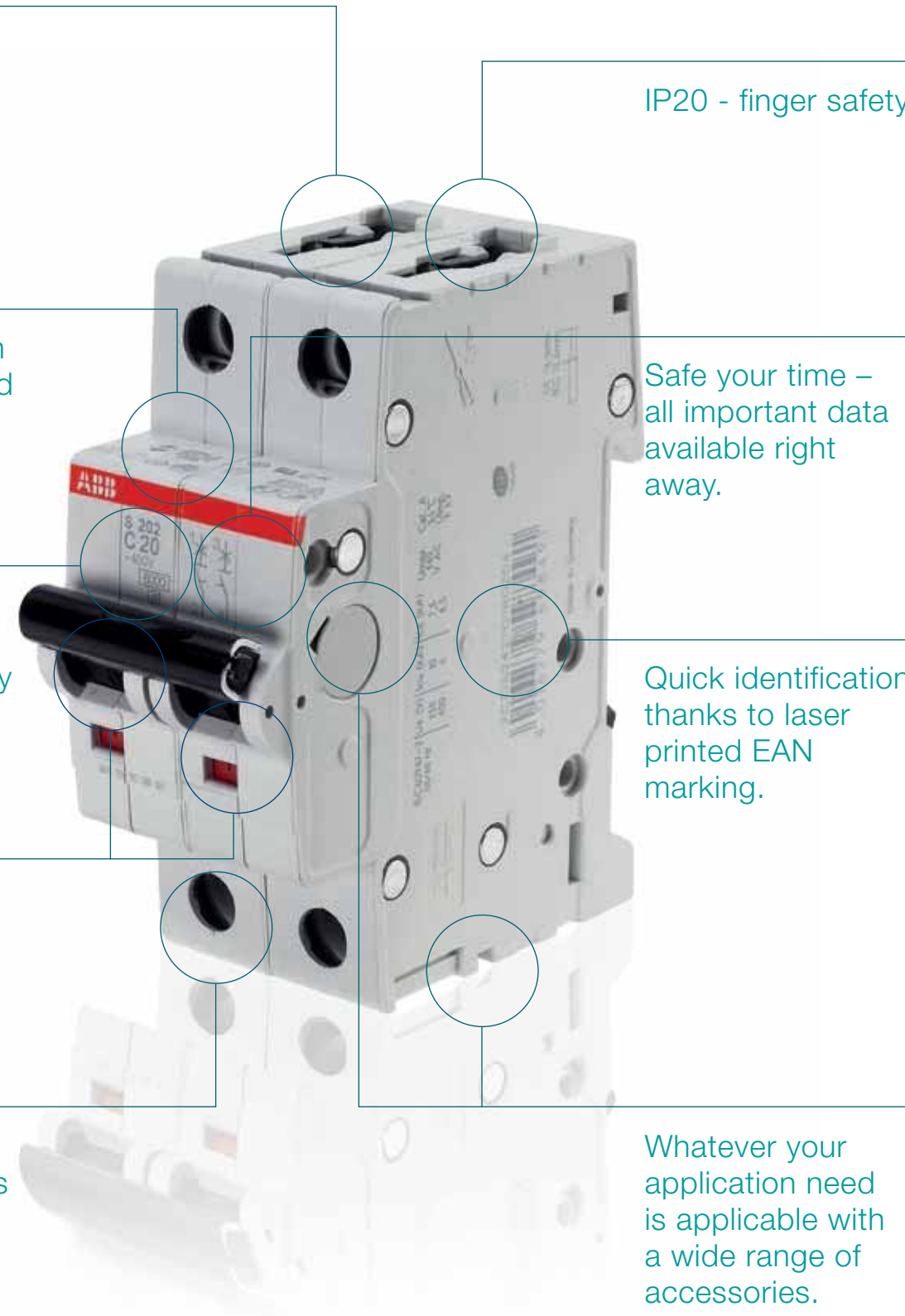



Contact position indication

All System pro *M* compact® MCBs are suited with a contact position indication (CPI) on the toggle. You can easily identify, if the MCB is in the ON or the OFF position – easy and safe maintenance work is possible.



Approvals printed on the dome

S 200 MCBs comply to IEC/EN 60898-1 and IEC/EN 60947-2 and carry all relevant approval marks for each market and segment they are destined to. The certification markings are also printed on the dome of the MCB. Thus make it possible to see the markings also in the mounted position. For control and acceptance procedure – certification marks visible on fitted devices on the dome.



2

Housing material

By using the state-of-the-art housing material, ABB is taking care of the environment. With the latest generation of thermoplastics it's possible to recycle the MCBs – especially the thermoplastic housing-material can be re-used. By using the latest generation of thermoplastics the material stability of all System pro *M* compact® MCBs is improved. S200 are 100% free of halogens – no environmental pollution.



Laser printing

All printings of the S 200 and S 200 M MCBs, like the approvals on the dome and the product identification, are printed by a laser. The laser printing ensures a friction, scratch and solvent resistant marking on the MCBs. Easy identification of the products in case of maintenance or replacements due to safe laser printing.

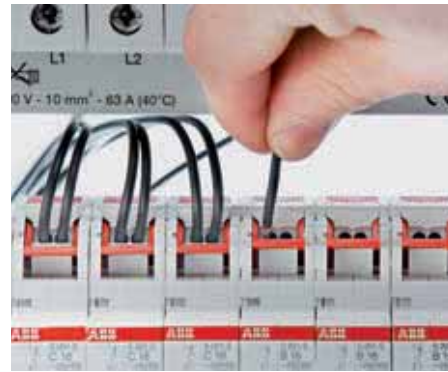

Screwless terminals

With its unique terminal screwless technology the S 200 S provides maximum flexibility in usage of cables. The screwless load side terminal enables fast installation. High forces in the screwless terminal safe time for retightening after transport of the assembled enclosure. If the wiring has to be changed only a soft push on the lever is required. S 200 S provides the highest standard of safety for installer. IP20 / IPXXB (finger safe) highest standard of touch protection.



IP 20 - finder safe terminals

The System pro *M* compact® MCB's are equipped with 35 mm² + 10 mm² cylinder lift twin terminals, a well proven and reliable technology - designed for sophisticated industrial use. The cross wiring can easily be done by inserting the System pro *M* compact® busbars into the rear terminal part and then the incoming wires into the front part of the terminal.

MCBs

S 200 technical features

2



S 200

		S 200	S 200 M
General Data	Standards	IEC/EN 60898-1, IEC/EN 60947-2 UL 1077	IEC/EN 60898-1, IEC/EN 60947-2 UL 1077, CSA 22.2 No. 235
	Poles	1P, 2P, 3P, 4P, 1P+N, 3P+N	
	Tripping characteristics	B, C, D, K, Z	
	Rated current I_n	A 0.5 .. 63 A	
	Rated frequency f	Hz 50 / 60 Hz	
	Rated insulation voltage U_i acc. to IEC/EN 60664-1	V 250 V AC (phase to ground), 500 V AC (phase to phase)	
	Overvoltage category	III	
	Pollution degree	3	
Data acc. to IEC/EN 60898-1 (except S 200 M UC data acc. to IEC/EN 60898-2)	Rated operational voltage U_n	V 1P: 230/400 V AC; 1P+N: 230 V AC ; 2...4P: 400 V AC; 3P+N: 400 V AC	
	Max. power frequency recovery voltage (U_{max})	V 1P: 253 V AC; 1P+N: 253 V AC; 2P: 440 V AC; 3...4P: 440 V AC; 3P+N: 440 V AC; 1P: 72 V DC; 2P: 125 V DC	
	Min. operating voltage	V 12 V AC - 12 V DC	
	Rated short-circuit capacity I_{cs}	kA 6 kA	10 kA
	Energy limiting class (B, C up to 40 A)	3	
	Rated impulse withstand voltage U_{imp} . (1.2/50 μ s)	kV 4 kV (test voltage 6.2 kV at sea level, 5 kV at 2,000 m)	
	Dielectric test voltage	kV 2 kV (50 / 60Hz, 1 min.)	
	Reference temperature for tripping characteristics	°C B, C, D: 30°C	
	Electrical endurance	ops. $I_n < 32A$: 20,000 ops (AC), $I_n \geq 32A$: 10,000 ops. (AC); 1,000 ops. (DC); (1 cycle 2s - ON, 13s - OFF, $I_n \leq 32A$), (1 cycle 2s - ON, 28s - OFF, $I_n > 32A$)	
	Data acc. to IEC/EN 60947-2	Rated operational voltage U_n	V 1P: 230 V AC; 1P+N: 230 V AC; 2...4P: 440 V AC; 3P+N: 440 V AC
Max. power frequency recovery voltage (U_{max})		V 1P: 253 V AC; 1P+N: 253 V AC; 2P...4P: 462 V AC; 3P+N: 462 V AC; 1P: 72 V DC; 2P: 125 V DC	
Min. operating voltage		V 12 V AC - 12 V DC	
Rated ultimate short-circuit breaking capacity I_{cu}		kA 10 kA	15 kA
Rated service short-circuit breaking capacity I_{cs}		kA 7.5 kA	$\leq 40 A$: 11.2 kA 50, 63 A: 7.5 kA
Rated impulse withstand voltage U_{imp} . (1.2/50 μ s)		kV 4 kV (test voltage 6.2 kV at sea level, 5 kV at 2,000 m)	
Dielectric test voltage		kV 2 kV (50 / 60Hz, 1 min.)	
Reference temperature for tripping characteristics		°C B, C, D: 55°C; K, Z: 20°C	
Electrical endurance		ops. $I_n < 32A$: 20,000 ops (AC), $I_n \geq 32A$: 10,000 ops. (AC); 1,000 ops. (DC); (1 cycle 2s - ON, 13s - OFF, $I_n \leq 32A$), (1 cycle 2s - ON, 28s - OFF, $I_n > 32A$)	

Note: Definitions acc. to standards on page 10/2
* Only acc. to IEC/EN 60898-1

S200 M UC	S 200 P	S 200 PR	S 200 S	S 200 U	S 200 UP	SU 200 PR	S 200 UDC
IEC/EN 60898-2, IEC/EN 60947-2	IEC/EN 60898-1, IEC/EN 60947-2	IEC/EN 60947-2	IEC/EN 60898-1	IEC/EN 60947-2		IEC/EN 60947-2	
	UL 1077, CSA 22.2 No. 235	UL 1077, CSA 22.2 No. 235		UL 489, CSA 22.2 No.5		UL 489, CSA 22.2 No. 235	UL 489
1P, 2P, 3P, 4P	1P, 2P, 3P, 4P, 1P+N, 3P+N	1P, 2P, 3P, 4P	1P, 3P	1P, 2P, 3P, 4P		1P, 2P, 3P, 4P	1P, 2P
B, C, K, Z	B, C, D, K, Z	K	B, C	C, K, Z		K	
0.2...63 A			6...20 A	0.2...63 A	0.2...25 A	0.2...63 A	1...63 A
0 / 50 / 60 Hz	50 / 60 Hz	50 / 60 Hz					DC
253 V AC (phase to ground), 440 V AC (phase to phase)	250 V AC (phase to ground), 500 V AC (phase to phase)		250 V AC (phase to ground), 440 V AC (phase to phase)				
							--
							--
			1P: 230 V AC, 3P: 440 V AC	--			
			1P: 253 V AC, 3P: 440 V AC	--			
			12 V AC	--			
10 kA	≤ 25 A: 25 kA > 25 A: 15 kA		6 kA	--			
				--			
				--			
				--			
30 °C			B, C: 30 °C	--			
			20,000 ops.	--			
1P: 253 V AC, 220 V DC 2...4P: 440 V AC, 440 V DC	1P: 230 V AC; 1P+N: 230 V AC; 2...4P: 400 V AC; 3P+N: 400 V AC	1P: 230 V AC 2...4P: 400 V AC		1P: 230 V AC 2...4P: 400 V AC		1P: 230 V AC 2...4P: 400 V AC	--
1P: 266 V AC, 250 V DC 2...4P: 462 V AC, 500 V DC	1P: 253 V AC; 1P+N: 253 V AC; 2P...4P: 440 V AC; 3P+N: 440 V AC; 1P: 72 V DC; 2P: 125 V DC	1P: 253 V AC 2...4P: 440 V AC		1P: 253/440 V AC; 2...4P: 440 V AC		1P: 253 V AC 2...4P: 440 V AC	--
		12 V AC		12 V AC			--
≤ 40 A: 10 kA AC; 10 kA DC > 40 A: 6 kA AC; 10 kA DC	≤ 25 A: 25 kA ≥ 32 A: 15 kA	15 kA		10 kA		15 kA	--
≤ 40 A: 10 kA AC; 10 kA DC > 40 A: 6 kA(AC); 10 kA DC	≤ 25 A: 12.5 kA ≤ 32...40 A: 11.2 kA 50, 63 A: 7.5 kA	≤ 40 A: 11.2 kA; > 40 A: 7.5 kA AC;		7.5 kA		≤ 40 A: 11.2 kA; > 40 A: 7.5 kA (AC);	--
							--
							--
B, C: 55 °C; K, Z: 20 °C		20 °C		C, K, Z: 20 °C		20 °C	--
In < 32A: 20,000 ops (AC); In ≥ 32A: 10,000 ops. (AC); 1,500 ops. (DC);	In < 32A: 20,000 ops (AC); In ≥ 32A: 10,000 ops. (AC); 1,000 ops. (DC); (1 cycle 2s - ON, 13s - OFF, In ≤ 32A), (1 cycle 2s - ON, 28s - OFF, In ≥ 32A)	In < 25A: 20,000 ops (AC); In ≥ 25A: 10,000 ops. (AC);				In < 25A: 20,000 ops (AC); In ≥ 25A: 10,000 ops. (AC);	--

MCBs

S 200 technical features

2



S 200

		S 200	S 200 M
Data acc. to UL / CSA	Rated voltage	V	480Y / 277 V AC;
			1P: 60 V DC; 2P...4P: 110 V DC
	Rated interrupting capacity acc. to UL 1077	kA	6 kA AC; 10 kA DC
	Short-circuit current rating acc. to UL 489		--
	Application		Suppl. prot. for general use. Application Codes: TC2, OL0, SC: U1
	Reference temperature for tripping characteristics	°C	B, C, D, K, Z: 25°C
	Electrical endurance	ops.	6,000 ops (AC), 6,000 ops. (DC); 1 cycle (1s - ON, 9s - OFF)
Mechanical Data	Housing		Insulation group II, RAL 7035
	Toggle		Insulation group II, black, sealable
	Contact position indication		Marking on toggle (I ON / 0 OFF), Real CPI (red ON / green OFF)
	Protection degree acc. to EN 60529		IP20*, IP40 in enclosure with cover
	Mechanical endurance	ops.	20,000 ops.
	Shock resistance acc. to IEC/EN 60068-2-27		25 g - 2 shocks - 13 ms
	Vibration resistance acc. to IEC/EN 60068-2-6		5g - 20 cycles at 5...150...5 Hz with load 0.8In
	Environmental conditions (damp heat) acc. to IEC/EN 60068-2-30	°C/ RH	28 cycles with 55°C/90-96% and 25°C/95-100%
Ambient temperature	°C	-25 ... +55°C	
Storage temperature	°C	-40 ... +70°C	

Note: Definitions acc. to standards on page 10/2;
 * Also fulfilling the requirement acc. to the protection degree IPXXB
 ** Only with accessory: IP20 terminal clip

S200 M UC	S 200 P	S 200 PR	S 200 S	S 200 U	S 200 UP	SU 200 PR	S 200 UDC
	480Y / 277 V AC	1P: 277 V AC; 2...4P: 480 / 277 V AC		1P: 240 V AC	1P: 277 V AC	1P: ≤ 35 A: 277 V AC; > 35 A: 240 V AC	1P: 60 V DC
				2...4P: 240 V AC	2...4P: 480Y / 277 V AC	2...4P: ≤ 35 A: 480 / 277 V AC; > 35 A: 240 V AC	2P: 125 V DC
	≤ 25 A: 10 kA > 25 A: 6 kA	10 kA		--			
				10 kA		10 kA	14 kA (UL)
		Ring tongue terminal, not for general use				Ring tongue terminal, not for general use	
		25 °C		C, K, Z: 25 °C		25 °C	
							6,000 ops. (1 cycle 1s - ON, 9s - OFF)
Insulation group I, RAL 7035			Insulation group II, RAL 7035				Insulation group I, RAL 7035
				IP20**, IP40 in enclosure with cover			
	30 g - 3 shocks - 11 ms	25 g - 2 shocks - 13 ms	25 g - 2 shocks - 13 ms			25 g - 2 shocks - 13 ms	

MCBs

S 200 technical features

2



S 200

		S 200	S 200 M		
Installation	Terminal	Failsafe bi-directional cylinder-lift terminal			
	Cross-section of conductors (top / bottom)	Solid / Stranded	mm ² 35 mm ² / 35 mm ²		
		Flexible	mm ²	25 mm ² / 25 mm ²	
			AWG	18 - 4 AWG	14 - 4 AWG
	Cross-section of busbars (top / bottom)	mm ²	10 mm ² / 10 mm ²		
		AWG	18 - 8 AWG	14 - 8 AWG	
	Tightening Torque	Nm	2.8 Nm		
		in-lbs.	18 in-lbs.		
	Screwdriver	No. 2 Pozidrive			
	Mounting	On DIN rail 35 mm acc. to EN 60715 by fast clip			
Mounting position	any				
Supply	optional				
Dimensions and weight	Mounting dimensions acc. to DIN 43880	Mounting dimension 1			
	Pole dimensions (H x D x W)	mm	88 x 69 x 17.5 mm		
	Pole weight	g	approx. 115 g		
Combination with aux. elements	Auxiliary contact	Yes			
	Signal contact	Yes			
	Shunt trip	Yes			
	Undervoltage release	Yes			
	Motor Operating Device	Yes			
	Integrated auxiliary switch	Yes			

MCBs

S 200 series 6000 B characteristic



S 201



S 202



S 203

S 200 B characteristic

Function: protection and control of the circuits against overloads and short-circuits; protection for people and large length of cables in TN and IT systems.

Applications: residential, commercial and industrial.

Standard: IEC/EN 60898-1, IEC/EN 60947-2

Icn=6 kA

Number of poles	Rated current	Bbn 4016779	Order details		Price 1 piece	Weight 1 piece	Pack unit
	In A		EAN	Type code			
1	6	464901	S 201-B 6	2CDS251001R0065		0.125	10
	10	463805	S 201-B 10	2CDS251001R0105		0.125	10
	13	465007	S 201-B 13	2CDS251001R0135		0.125	10
	16	578639	S 201-B 16	2CDS251001R1165		0.125	10
	20 [Ⓚ]	465106	S 201-B 20	2CDS251001R0205		0.125	10
	25	465205	S 201-B 25	2CDS251001R0255		0.125	10
	32 [Ⓚ]	465304	S 201-B 32	2CDS251001R0325		0.125	10
	40 [Ⓚ]	465403	S 201-B 40	2CDS251001R0405		0.125	10
	50	550925	S 201-B 50	2CDS251001R0505		0.125	10
	63	550932	S 201-B 63	2CDS251001R0635		0.125	10

Number of poles	Rated current	Bbn 4016779	Order details		Price 1 piece	Weight 1 piece	Pack unit
	In A		EAN	Type code			
2	6	466400	S 202-B 6	2CDS252001R0065		0.250	5
	10	466608	S 202-B 10	2CDS252001R0105		0.250	5
	13	466707	S 202-B 13	2CDS252001R0135		0.250	5
	16	466905	S 202-B 16	2CDS252001R0165		0.250	5
	20	467001	S 202-B 20	2CDS252001R0205		0.250	5
	25	467100	S 202-B 25	2CDS252001R0255		0.250	5
	32	467209	S 202-B 32	2CDS252001R0325		0.250	5
	40	467407	S 202-B 40	2CDS252001R0405		0.250	5
	50	550949	S 202-B 50	2CDS252001R0505		0.250	5
	63	550956	S 202-B 63	2CDS252001R0635		0.250	5

Number of poles	Rated current	Bbn 4016779	Order details		Price 1 piece	Weight 1 piece	Pack unit
	In A		EAN	Type code			
3	6	468602	S 203-B 6	2CDS253001R0065		0.375	1
	10	468701	S 203-B 10	2CDS253001R0105		0.375	1
	13	468909	S 203-B 13	2CDS253001R0135		0.375	1
	16	469005	S 203-B 16	2CDS253001R0165		0.375	1
	20 [Ⓚ]	469104	S 203-B 20	2CDS253001R0205		0.375	1
	25	469203	S 203-B 25	2CDS253001R0255		0.375	1
	32 [Ⓚ]	469302	S 203-B 32	2CDS253001R0325		0.375	1
	40 [Ⓚ]	469401	S 203-B 40	2CDS253001R0405		0.375	1
	50	550963	S 203-B 50	2CDS253001R0505		0.375	1
	63	550970	S 203-B 63	2CDS253001R0635		0.375	1

- [Ⓚ] suitable for flow-type heaters 12 kW
- [Ⓚ] suitable for flow-type heaters 18 kW
- [Ⓚ] suitable for flow-type heaters 21, 24 and 27 kW

Where to find more:
 Coordination Tables for S 200 MCBs: p.10/37 for back-up and p.10/50 for selectivity
 Worldwide Marks and Approvals of MCBs p.11/92

Frequently asked question - FAQ:
 Where can I get certificates, declarations and CAD drawings?
 You can find all of them on www.abb.com

Maybe you are also interested in:
 Auxiliary Elements for MCBs p.4/2
 Accessories for MCBs p.4/16
 Busbar Systems p.4/21



S 204



S 201 NA



S 203 NA

Number of poles	Rated current	Bbn 4016779	Order details		Price 1 piece	Weight 1 piece	Pack unit
	In A		EAN	Type code			
4	6	528955	S 204-B 6	2CDS254001R0065		0.500	1
	10	528962	S 204-B 10	2CDS254001R0105		0.500	1
	13	528979	S 204-B 13	2CDS254001R0135		0.500	1
	16	528986	S 204-B 16	2CDS254001R0165		0.500	1
	20	528993	S 204-B 20	2CDS254001R0205		0.500	1
	25	529006	S 204-B 25	2CDS254001R0255		0.500	1
	32	529013	S 204-B 32	2CDS254001R0325		0.500	1
	40	529020	S 204-B 40	2CDS254001R0405		0.500	1
	50	550987	S 204-B 50	2CDS254001R0505		0.500	1
	63	550994	S 204-B 63	2CDS254001R0635		0.500	1

2

With disconnecting neutral NA

Number of poles	Rated current	Bbn 4016779	Order details		Price 1 piece	Weight 1 piece	Pack unit
	In A		EAN	Type code			
1+NA	6	531580	S 201-B 6 NA	2CDS251103R0065		0.250	5
	10	531597	S 201-B 10 NA	2CDS251103R0105		0.250	5
	13	531603	S 201-B 13 NA	2CDS251103R0135		0.250	5
	16	531610	S 201-B 16 NA	2CDS251103R0165		0.250	5
	20 ①	531627	S 201-B 20 NA	2CDS251103R0205		0.250	5
	25	531634	S 201-B 25 NA	2CDS251103R0255		0.250	5
	32 ②	531641	S 201-B 32 NA	2CDS251103R0325		0.250	5
	40 ③	531658	S 201-B 40 NA	2CDS251103R0405		0.250	5
	50	536158	S 201-B 50 NA	2CDS251103R0505		0.250	5
	63	536141	S 201-B 63 NA	2CDS251103R0635		0.250	5

Number of poles	Rated current	Bbn 4016779	Order details		Price 1 piece	Weight 1 piece	Pack unit
	In A		EAN	Type code			
3+NA	6	532280	S 203-B 6 NA	2CDS253103R0065		0.500	1
	10	532297	S 203-B 10 NA	2CDS253103R0105		0.500	1
	13	532303	S 203-B 13 NA	2CDS253103R0135		0.500	1
	16	532310	S 203-B 16 NA	2CDS253103R0165		0.500	1
	20 ①	532327	S 203-B 20 NA	2CDS253103R0205		0.500	1
	25	532334	S 203-B 25 NA	2CDS253103R0255		0.500	1
	32 ②	532341	S 203-B 32 NA	2CDS253103R0325		0.500	1
	40 ③	532358	S 203-B 40 NA	2CDS253103R0405		0.500	1
	50	536165	S 203-B 50 NA	2CDS253103R0505		0.580	1
	63	536172	S 203-B 63 NA	2CDS253103R0635		0.580	1

① suitable for flow-type heaters 12 kW
 ② suitable for flow-type heaters 18 kW

③ suitable for flow-type heaters 21, 24 and 27 kW

MCBs

S 200 series 6000 C characteristic



S 201



S 202

S 200 C characteristic

Function: protection and control of the circuits against overloads and short-circuits; protection for resistive and inductive loads with low inrush current.

Applications: residential, commercial and industrial.

Standard: IEC/EN 60898-1, IEC/EN 60947-2

Icn=6 kA

Number of poles	Rated current	Bbn 4016779	Order details		Price 1 piece	Weight 1 piece	Pack unit
	In A		EAN	Type code			
1	0.5	523295	S 201-C 0.5	2CDS251001R0984		0.125	10
	1	523318	S 201-C 1	2CDS251001R0014		0.125	10
	1.6	523301	S 201-C 1.6	2CDS251001R0974		0.125	10
	2	523325	S 201-C 2	2CDS251001R0024		0.125	10
	3	523332	S 201-C 3	2CDS251001R0034		0.125	10
	4	523349	S 201-C 4	2CDS251001R0044		0.125	10
	6	464000	S 201-C 6	2CDS251001R0064		0.125	10
	8	464109	S 201-C 8	2CDS251001R0084		0.125	10
	10	464208	S 201-C 10	2CDS251001R0104		0.125	10
	13	464307	S 201-C 13	2CDS251001R0134		0.125	10
	16	464406	S 201-C 16	2CDS251001R0164		0.125	10
	20 ①	464505	S 201-C 20	2CDS251001R0204		0.125	10
	25	464604	S 201-C 25	2CDS251001R0254		0.125	10
	32 ②	464703	S 201-C 32	2CDS251001R0324		0.125	10
	40 ③	464802	S 201-C 40	2CDS251001R0404		0.125	10
	50	551007	S 201-C 50	2CDS251001R0504		0.125	10
63	551014	S 201-C 63	2CDS251001R0634		0.125	10	

Number of poles	Rated current	Bbn 4016779	Order details		Price 1 piece	Weight 1 piece	Pack unit
	In A		EAN	Type code			
2	0.5	523356	S 202-C 0.5	2CDS252001R0984		0.250	5
	1	523363	S 202-C 1	2CDS252001R0014		0.250	5
	1.6	523370	S 202-C 1.6	2CDS252001R0974		0.250	5
	2	523387	S 202-C 2	2CDS252001R0024		0.250	5
	3	523394	S 202-C 3	2CDS252001R0034		0.250	5
	4	523400	S 202-C 4	2CDS252001R0044		0.250	5
	6	465502	S 202-C 6	2CDS252001R0064		0.250	5
	8	465601	S 202-C 8	2CDS252001R0084		0.250	5
	10	465700	S 202-C 10	2CDS252001R0104		0.250	5
	13	465809	S 202-C 13	2CDS252001R0134		0.250	5
	16	465908	S 202-C 16	2CDS252001R0164		0.250	5
	20 ①	466004	S 202-C 20	2CDS252001R0204		0.250	5
	25	466103	S 202-C 25	2CDS252001R0254		0.250	5
	32 ②	466202	S 202-C 32	2CDS252001R0324		0.250	5
	40 ③	466301	S 202-C 40	2CDS252001R0404		0.250	5
	50	551045	S 202-C 50	2CDS252001R0504		0.250	5
63	551052	S 202-C 63	2CDS252001R0634		0.250	5	

- ① suitable for flow-type heaters 12 kW
- ② suitable for flow-type heaters 18 kW

- ③ suitable for flow-type heaters 21, 24 and 27 kW

Where to find more:

Coordination Tables for S 200 MCBs: p.10/37 for back-up and p.10/50 for selectivity

Worldwide Marks and Approvals of MCBs p.11/92

Frequently asked question - FAQ:

Where can I get certificates, declarations and CAD drawings?

You can find all of them on www.abb.com

Maybe you are also interested in:

Auxiliary Elements for MCBs p.4/2

Accessories for MCBs p.4/16

Busbar Systems p.4/21



S 203

2CDC0210569002



S 204

2CDC0210575002

2

Number of poles	Rated current	Bbn 4016779	Order details		Price 1 piece	Weight 1 piece kg	Pack unit pc.
	In A	EAN	Type code	Order code			
3	1	523424	S 203-C 1	2CDS253001R0014		0.375	1
	1.6	523431	S 203-C 1.6	2CDS253001R0974		0.375	1
	2	523448	S 203-C 2	2CDS253001R0024		0.375	1
	3	523455	S 203-C 3	2CDS253001R0034		0.375	1
	4	523462	S 203-C 4	2CDS253001R0044		0.375	1
	6	467506	S 203-C 6	2CDS253001R0064		0.375	1
	8	467605	S 203-C 8	2CDS253001R0084		0.375	1
	10	467803	S 203-C 10	2CDS253001R0104		0.375	1
	13	467902	S 203-C 13	2CDS253001R0134		0.375	1
	16	468008	S 203-C 16	2CDS253001R0164		0.375	1
	20 ①	468107	S 203-C 20	2CDS253001R0204		0.375	1
	25	468206	S 203-C 25	2CDS253001R0254		0.375	1
	32 ②	468305	S 203-C 32	2CDS253001R0324		0.375	1
	40 ③	468404	S 203-C 40	2CDS253001R0404		0.375	1
50	551069	S 203-C 50	2CDS253001R0504		0.375	1	
63	551076	S 203-C 63	2CDS253001R0634		0.375	1	

Number of poles	Rated current	Bbn 4016779	Order details		Price 1 piece	Weight 1 piece kg	Pack unit pc.
	In A	EAN	Type code	Order code			
4	0.5	529112	S 204-C 0.5	2CDS254001R0984		0.500	1
	1	529129	S 204-C 1	2CDS254001R0014		0.500	1
	1.6	529136	S 204-C 1.6	2CDS254001R0974		0.500	1
	2	529143	S 204-C 2	2CDS254001R0024		0.500	1
	3	529150	S 204-C 3	2CDS254001R0034		0.500	1
	4	529167	S 204-C 4	2CDS254001R0044		0.500	1
	6	529174	S 204-C 6	2CDS254001R0064		0.500	1
	8	529181	S 204-C 8	2CDS254001R0084		0.500	1
	10	529198	S 204-C 10	2CDS254001R0104		0.500	1
	13	529204	S 204-C 13	2CDS254001R0134		0.500	1
	16	529211	S 204-C 16	2CDS254001R0164		0.500	1
	20 ①	529228	S 204-C 20	2CDS254001R0204		0.500	1
	25	529235	S 204-C 25	2CDS254001R0254		0.500	1
	32 ②	529242	S 204-C 32	2CDS254001R0324		0.500	1
	40 ③	529259	S 204-C 40	2CDS254001R0404		0.500	1
	50	551106	S 204-C 50	2CDS254001R0504		0.500	1
	63	551113	S 204-C 63	2CDS254001R0634		0.500	1

① suitable for flow-type heaters 12 kW
 ② suitable for flow-type heaters 18 kW

③ suitable for flow-type heaters 21, 24 and 27 kW

MCBs

S 200 series 6000 C characteristic



S 201 NA



S 203 NA

With disconnecting neutral NA

Number of poles	Rated current	Bbn 4016779	Order details		Price 1 piece	Weight 1 piece	Pack unit
	In A	EAN	Type code	Order code			
1+NA	0.5	531665	S 201-C 0.5 NA	2CDS251103R0984		0.250	5
	1	531672	S 201-C 1 NA	2CDS251103R0014		0.250	5
	1.6	531689	S 201-C 1.6 NA	2CDS251103R0974		0.250	5
	2	531696	S 201-C 2 NA	2CDS251103R0024		0.250	5
	3	531702	S 201-C 3 NA	2CDS251103R0034		0.250	5
	4	531726	S 201-C 4 NA	2CDS251103R0044		0.250	5
	6	531733	S 201-C 6 NA	2CDS251103R0064		0.250	5
	8	531740	S 201-C 8 NA	2CDS251103R0084		0.250	5
	10	531757	S 201-C 10 NA	2CDS251103R0104		0.250	5
	13	531764	S 201-C 13 NA	2CDS251103R0134		0.250	5
	16	531771	S 201-C 16 NA	2CDS251103R0164		0.250	5
	20 ①	531788	S 201-C 20 NA	2CDS251103R0204		0.250	5
	25	531795	S 201-C 25 NA	2CDS251103R0254		0.250	5
	32 ②	531801	S 201-C 32 NA	2CDS251103R0324		0.250	5
	40 ③	531818	S 201-C 40 NA	2CDS251103R0404		0.250	5
	50	551021	S 201-C 50 NA	2CDS251103R0504		0.290	5
	63	551038	S 201-C 63 NA	2CDS251103R0634		0.290	5

Number of poles	Rated current	Bbn 4016779	Order details		Price 1 piece	Weight 1 piece	Pack unit
	In A	EAN	Type code	Order code			
3+NA	0.5	532365	S 203-C 0.5 NA	2CDS253103R0984		0.500	1
	1	532372	S 203-C 1 NA	2CDS253103R0014		0.500	1
	1.6	532389	S 203-C 1.6 NA	2CDS253103R0974		0.500	1
	2	532402	S 203-C 2 NA	2CDS253103R0024		0.500	1
	3	532419	S 203-C 3 NA	2CDS253103R0034		0.500	1
	4	532426	S 203-C 4 NA	2CDS253103R0044		0.500	1
	6	532433	S 203-C 6 NA	2CDS253103R0064		0.500	1
	8	532440	S 203-C 8 NA	2CDS253103R0084		0.500	1
	10	532457	S 203-C 10 NA	2CDS253103R0104		0.500	1
	13	532464	S 203-C 13 NA	2CDS253103R0134		0.500	1
	16	532471	S 203-C 16 NA	2CDS253103R0164		0.500	1
	20 ①	532488	S 203-C 20 NA	2CDS253103R0204		0.500	1
	25	532495	S 203-C 25 NA	2CDS253103R0254		0.500	1
	32 ②	532501	S 203-C 32 NA	2CDS253103R0324		0.500	1
	40 ③	532518	S 203-C 40 NA	2CDS253103R0404		0.500	1
	50	551083	S 203-C 50 NA	2CDS253103R0504		0.580	1
	63	551090	S 203-C 63 NA	2CDS253103R0634		0.580	1

- ① suitable for flow-type heaters 12 kW
- ② suitable for flow-type heaters 18 kW
- ③ suitable for flow-type heaters 21, 24 and 27 kW

Where to find more:
 Coordination Tables for S 200 MCBs: p.10/37 for back-up and p.10/50 for selectivity
 Worldwide Marks and Approvals of MCBs p.11/92

Frequently asked question - FAQ:
 Where can I get certificates, declarations and CAD drawings?
 You can find all of them on www.abb.com

Maybe you are also interested in:
 Auxiliary Elements for MCBs p.4/2
 Accessories for MCBs p.4/16
 Busbar Systems p.4/21

MCBs

S 200 series 6000 D characteristic



S 201



S 202

S 200 D characteristic

Function: protection and control of the circuits against overloads and short-circuits; protection for circuits which supply loads with high inrush current at the circuit closing (LV/LV transformers, breakdown lamps).

Applications: residential, commercial and industrial.

Standard: IEC/EN 60898-1, IEC/EN 60947-2

Icn=6 kA

2

Number of poles	Rated current	Bbn 4016779	Order details		Price 1 piece	Weight 1 piece kg	Pack unit pc.
	In A	EAN	Type code	Order code			
1	0.5	529938	S 201-D 0.5	2CDS251001R0981		0.125	10
	1	529945	S 201-D 1	2CDS251001R0011		0.125	10
	1.6	529952	S 201-D 1.6	2CDS251001R0971		0.125	10
	2	529969	S 201-D 2	2CDS251001R0021		0.125	10
	3	529976	S 201-D 3	2CDS251001R0031		0.125	10
	4	529983	S 201-D 4	2CDS251001R0041		0.125	10
	6	529990	S 201-D 6	2CDS251001R0061		0.125	10
	8	530002	S 201-D 8	2CDS251001R0081		0.125	10
	10	530019	S 201-D 10	2CDS251001R0101		0.125	10
	13	530026	S 201-D 13	2CDS251001R0131		0.125	10
	16	530033	S 201-D 16	2CDS251001R0161		0.125	10
	20 ①	530040	S 201-D 20	2CDS251001R0201		0.125	10
	25	530057	S 201-D 25	2CDS251001R0251		0.125	10
	32 ②	530064	S 201-D 32	2CDS251001R0321		0.125	10
	40 ③	530071	S 201-D 40	2CDS251001R0401		0.125	10
	50	551991	S 201-D 50	2CDS251001R0501		0.125	10
63	552004	S 201-D 63	2CDS251001R0631		0.125	10	

Number of poles	Rated current	Bbn 4016779	Order details		Price 1 piece	Weight 1 piece kg	Pack unit pc.
	In A	EAN	Type code	Order code			
2	0.5	530484	S 202-D 0.5	2CDS252001R0981		0.250	5
	1	530491	S 202-D 1	2CDS252001R0011		0.250	5
	1.6	530507	S 202-D 1.6	2CDS252001R0971		0.250	5
	2	530514	S 202-D 2	2CDS252001R0021		0.250	5
	3	530521	S 202-D 3	2CDS252001R0031		0.250	5
	4	530538	S 202-D 4	2CDS252001R0041		0.250	5
	6	530545	S 202-D 6	2CDS252001R0061		0.250	5
	8	530552	S 202-D 8	2CDS252001R0081		0.250	5
	10	530583	S 202-D 10	2CDS252001R0101		0.250	5
	13	530606	S 202-D 13	2CDS252001R0131		0.250	5
	16	530613	S 202-D 16	2CDS252001R0161		0.250	5
	20	530637	S 202-D 20	2CDS252001R0201		0.250	5
	25	530644	S 202-D 25	2CDS252001R0251		0.250	5
	32	530651	S 202-D 32	2CDS252001R0321		0.250	5
	40	530668	S 202-D 40	2CDS252001R0401		0.250	5
	50	552035	S 202-D 50	2CDS252001R0501		0.250	5
63	552042	S 202-D 63	2CDS252001R0631		0.250	5	

① suitable for flow-type heaters 12 kW
 ② suitable for flow-type heaters 18 kW

③ suitable for flow-type heaters 21, 24 and 27 kW

MCBs

S 200 series 6000 D characteristic

2



S 203



S 204

Number of poles	Rated current	Bbn 4016779	Order details		Price 1 piece	Weight 1 piece	Pack unit
	In A		EAN	Type code			
3	0.5	530811	S 203-D 0.5	2CDS253001R0981		0.375	1
	1	530828	S 203-D 1	2CDS253001R0011		0.375	1
	1.6	530835	S 203-D 1.6	2CDS253001R0971		0.375	1
	2	530842	S 203-D 2	2CDS253001R0021		0.375	1
	3	530859	S 203-D 3	2CDS253001R0031		0.375	1
	4	530866	S 203-D 4	2CDS253001R0041		0.375	1
	6	530880	S 203-D 6	2CDS253001R0061		0.375	1
	8	530897	S 203-D 8	2CDS253001R0081		0.375	1
	10	530903	S 203-D 10	2CDS253001R0101		0.375	1
	13	530910	S 203-D 13	2CDS253001R0131		0.375	1
	16	530927	S 203-D 16	2CDS253001R0161		0.375	1
	20 ①	530934	S 203-D 20	2CDS253001R0201		0.375	1
	25	530941	S 203-D 25	2CDS253001R0251		0.375	1
	32 ②	530958	S 203-D 32	2CDS253001R0321		0.375	1
	40 ③	530965	S 203-D 40	2CDS253001R0401		0.375	1
	50	552059	S 203-D 50	2CDS253001R0501		0.375	1
	63	552066	S 203-D 63	2CDS253001R0631		0.375	1

Number of poles	Rated current	Bbn 4016779	Order details		Price 1 piece	Weight 1 piece	Pack unit
	In A		EAN	Type code			
4	0.5	531122	S 204-D 0.5	2CDS254001R0981		0.500	1
	1	531139	S 204-D 1	2CDS254001R0011		0.500	1
	1.6	531146	S 204-D 1.6	2CDS254001R0971		0.500	1
	2	531153	S 204-D 2	2CDS254001R0021		0.500	1
	3	531160	S 204-D 3	2CDS254001R0031		0.500	1
	4	531177	S 204-D 4	2CDS254001R0041		0.500	1
	6	531184	S 204-D 6	2CDS254001R0061		0.500	1
	8	531191	S 204-D 8	2CDS254001R0081		0.500	1
	10	531207	S 204-D 10	2CDS254001R0101		0.500	1
	13	531214	S 204-D 13	2CDS254001R0131		0.500	1
	16	531221	S 204-D 16	2CDS254001R0161		0.500	1
	20	531238	S 204-D 20	2CDS254001R0201		0.500	1
	25	531290	S 204-D 25	2CDS254001R0251		0.500	1
	32	531306	S 204-D 32	2CDS254001R0321		0.500	1
	40	531313	S 204-D 40	2CDS254001R0401		0.500	1
	50	552097	S 204-D 50	2CDS254001R0501		0.500	1
	63	552103	S 204-D 63	2CDS254001R0631		0.500	1

- ① suitable for flow-type heaters 12 kW
- ② suitable for flow-type heaters 18 kW
- ③ suitable for flow-type heaters 21, 24 and 27 kW

Where to find more:

Coordination Tables for S 200 MCBs: p.10/37 for back-up and p.10/50 for selectivity
Worldwide Marks and Approvals of MCBs p.11/92

Frequently asked question - FAQ:

Where can I get certificates, declarations and CAD drawings?
You can find all of them on www.abb.com

Maybe you are also interested in:

Auxiliary Elements for MCBs p.4/2
Accessories for MCBs p.4/16
Busbar Systems p.4/21



S 201 NA



S 203 NA

With disconnecting neutral NA

Number of poles	Rated current	Bbn 4016779	Order details		Price 1 piece	Weight 1 piece kg	Pack unit pc.
	In A	EAN	Type code	Order code			
1+NA	0.5	531979	S 201-D 0.5 NA	2CDS251103R0981		0.250	5
	1	531986	S 201-D 1 NA	2CDS251103R0011		0.250	5
	1.6	531993	S 201-D 1.6 NA	2CDS251103R0971		0.250	5
	2	532006	S 201-D 2 NA	2CDS251103R0021		0.250	5
	3	532013	S 201-D 3 NA	2CDS251103R0031		0.250	5
	4	532020	S 201-D 4 NA	2CDS251103R0041		0.250	5
	6	532037	S 201-D 6 NA	2CDS251103R0061		0.250	5
	8	532044	S 201-D 8 NA	2CDS251103R0081		0.250	5
	10	532051	S 201-D 10 NA	2CDS251103R0101		0.250	5
	13	532068	S 201-D 13 NA	2CDS251103R0131		0.250	5
	16	532099	S 201-D 16 NA	2CDS251103R0161		0.250	5
	20 ①	532105	S 201-D 20 NA	2CDS251103R0201		0.250	5
	25	532112	S 201-D 25 NA	2CDS251103R0251		0.250	5
	32 ②	532129	S 201-D 32 NA	2CDS251103R0321		0.250	5
	40 ③	532136	S 201-D 40 NA	2CDS251103R0401		0.250	5
	50	552011	S 201-D 50 NA	2CDS251103R0501		0.290	5
63	552028	S 201-D 63 NA	2CDS251103R0631		0.290	5	

2

Number of poles	Rated current	Bbn 4016779	Order details		Price 1 piece	Weight 1 piece kg	Pack unit pc.
	In A	EAN	Type code	Order code			
3+NA	0.5	532761	S 203-D 0.5 NA	2CDS253103R0981		0.500	2
	1	532778	S 203-D 1 NA	2CDS253103R0011		0.500	2
	1.6	532785	S 203-D 1.6 NA	2CDS253103R0971		0.500	2
	2	532792	S 203-D 2 NA	2CDS253103R0021		0.500	2
	3	532808	S 203-D 3 NA	2CDS253103R0031		0.500	2
	4	532815	S 203-D 4 NA	2CDS253103R0041		0.500	2
	6	532822	S 203-D 6 NA	2CDS253103R0061		0.500	2
	8	532839	S 203-D 8 NA	2CDS253103R0081		0.500	2
	10	532846	S 203-D 10 NA	2CDS253103R0101		0.500	2
	13	532860	S 203-D 13 NA	2CDS253103R0131		0.500	2
	16	532877	S 203-D 16 NA	2CDS253103R0161		0.500	2
	20 ①	532884	S 203-D 20 NA	2CDS253103R0201		0.500	2
	25	532891	S 203-D 25 NA	2CDS253103R0251		0.500	2
	32 ②	532907	S 203-D 32 NA	2CDS253103R0321		0.500	2
	40 ③	532914	S 203-D 40 NA	2CDS253103R0401		0.500	2
	50	552073	S 203-D 50 NA	2CDS253103R0501		0.580	2
63	552080	S 203-D 63 NA	2CDS253103R0631		0.580	2	

① suitable for flow-type heaters 12 kW
 ② suitable for flow-type heaters 18 kW

③ suitable for flow-type heaters 21, 24 and 27 kW

MCBs

S 200 series 6000 K characteristic



S 201



S 202

S 200 K (power) characteristic

Function: protection and control of the circuits like motors, transformer and auxiliary circuits, against overloads and short-circuits.

Advantages: no nuisance tripping in the case of functional peak currents up to 10xIn, depending on the series; through its highly sensitive thermostatic bimetal trip, the K-type characteristic offers protection to damageable elements in the overcurrent range; it also provides the best protection to cables and lines.

Applications: commercial and industrial.

Standard: IEC/EN 60947-2

Icu=10 kA

Number of poles	Rated current	Bbn 4016779	Order details		Price 1 piece	Weight 1 piece kg	Pack unit pc.
	In A	EAN	Type code	Order code			
1	0.5	507196	S 201-K 0.5	2CDS251001R0157		0.125	10
	1	507202	S 201-K 1	2CDS251001R0217		0.125	10
	1.6	507219	S 201-K 1.6	2CDS251001R0257		0.125	10
	2	507226	S 201-K 2	2CDS251001R0277		0.125	10
	3	507233	S 201-K 3	2CDS251001R0317		0.125	10
	4	507240	S 201-K 4	2CDS251001R0337		0.125	10
	6	507257	S 201-K 6	2CDS251001R0377		0.125	10
	8	507264	S 201-K 8	2CDS251001R0407		0.125	10
	10	496117	S 201-K 10	2CDS251001R0427		0.125	10
	13	507271	S 201-K 13	2CDS251001R0447		0.125	10
	16	496124	S 201-K 16	2CDS251001R0467		0.125	10
	20	507288	S 201-K 20	2CDS251001R0487		0.125	10
	25	507295	S 201-K 25	2CDS251001R0517		0.125	10
	32	496131	S 201-K 32	2CDS251001R0537		0.125	10
	40	507301	S 201-K 40	2CDS251001R0557		0.125	10
	50	551120	S 201-K 50	2CDS251001R0577		0.125	10
	63	551137	S 201-K 63	2CDS251001R0607		0.125	10

Number of poles	Rated current	Bbn 4016779	Order details		Price 1 piece	Weight 1 piece kg	Pack unit pc.
	In A	EAN	Type code	Order code			
2	0.5	507318	S 202-K 0.5	2CDS252001R0157		0.250	5
	1	507325	S 202-K 1	2CDS252001R0217		0.250	5
	1.6	507332	S 202-K 1.6	2CDS252001R0257		0.250	5
	2	507349	S 202-K 2	2CDS252001R0277		0.250	5
	3	507356	S 202-K 3	2CDS252001R0317		0.250	5
	4	507363	S 202-K 4	2CDS252001R0337		0.250	5
	6	507370	S 202-K 6	2CDS252001R0377		0.250	5
	8	507387	S 202-K 8	2CDS252001R0407		0.250	5
	10	507394	S 202-K 10	2CDS252001R0427		0.250	5
	13	507400	S 202-K 13	2CDS252001R0447		0.250	5
	16	507417	S 202-K 16	2CDS252001R0467		0.250	5
	20	507424	S 202-K 20	2CDS252001R0487		0.250	5
	25	507431	S 202-K 25	2CDS252001R0517		0.250	5
	32	507448	S 202-K 32	2CDS252001R0537		0.250	5
	40	507455	S 202-K 40	2CDS252001R0557		0.250	5
	50	551168	S 202-K 50	2CDS252001R0577		0.250	5
	63	551175	S 202-K 63	2CDS252001R0607		0.250	5

- ① suitable for flow-type heaters 12 kW
- ② suitable for flow-type heaters 18 kW
- ③ suitable for flow-type heaters 21, 24 and 27 kW

Where to find more:
 Coordination Tables for S 200 MCBs: p.10/37 for back-up and p.10/50 for selectivity
 Worldwide Marks and Approvals of MCBs p.11/92

Frequently asked question - FAQ:
 Where can I get certificates, declarations and CAD drawings?
 You can find all of them on www.abb.com

Maybe you are also interested in:
 Auxiliary Elements for MCBs p.4/2
 Accessories for MCBs p.4/16
 Busbar Systems p.4/21



S 203



S 204

Number of poles	Rated current	Bbn 4016779	Order details		Price 1 piece	Weight 1 piece	Pack unit
	In A	EAN	Type code	Order code			
3	0.5	507462	S 203-K 0.5	2CDS253001R0157		0.375	1
	1	507479	S 203-K 1	2CDS253001R0217		0.375	1
	1.6	507486	S 203-K 1.6	2CDS253001R0257		0.375	1
	2	507493	S 203-K 2	2CDS253001R0277		0.375	1
	3	507509	S 203-K 3	2CDS253001R0317		0.375	1
	4	507516	S 203-K 4	2CDS253001R0337		0.375	1
	6	507523	S 203-K 6	2CDS253001R0377		0.375	1
	8	507530	S 203-K 8	2CDS253001R0407		0.375	1
	10	496148	S 203-K 10	2CDS253001R0427		0.375	1
	13	507547	S 203-K 13	2CDS253001R0447		0.375	1
	16	496155	S 203-K 16	2CDS253001R0467		0.375	1
	20	507554	S 203-K 20	2CDS253001R0487		0.375	1
	25	507561	S 203-K 25	2CDS253001R0517		0.375	1
	32	496162	S 203-K 32	2CDS253001R0537		0.375	1
	40	507578	S 203-K 40	2CDS253001R0557		0.375	1
50	551182	S 203-K 50	2CDS253001R0577		0.375	1	
63	551199	S 203-K 63	2CDS253001R0607		0.375	1	

2

Number of poles	Rated current	Bbn 4016779	Order details		Price 1 piece	Weight 1 piece	Pack unit
	In A	EAN	Type code	Order code			
4	0.5	529266	S 204-K 0.5	2CDS254001R0157		0.500	1
	1	529273	S 204-K 1	2CDS254001R0217		0.500	1
	1.6	529280	S 204-K 1.6	2CDS254001R0257		0.500	1
	2	529297	S 204-K 2	2CDS254001R0277		0.500	1
	3	529303	S 204-K 3	2CDS254001R0317		0.500	1
	4	529310	S 204-K 4	2CDS254001R0337		0.500	1
	6	529327	S 204-K 6	2CDS254001R0377		0.500	1
	8	529334	S 204-K 8	2CDS254001R0407		0.500	1
	10	529341	S 204-K 10	2CDS254001R0427		0.500	1
	13	529358	S 204-K 13	2CDS254001R0447		0.500	1
	16	529365	S 204-K 16	2CDS254001R0467		0.500	1
	20	529372	S 204-K 20	2CDS254001R0487		0.500	1
	25	529389	S 204-K 25	2CDS254001R0517		0.500	1
	32	529396	S 204-K 32	2CDS254001R0537		0.500	1
	40	529402	S 204-K 40	2CDS254001R0557		0.500	1
50	551229	S 204-K 50	2CDS254001R0577		0.500	1	
63	551236	S 204-K 63	2CDS254001R0607		0.500	1	

MCBs

S 200 series 6000 K characteristic

2



S 201 NA



S 203 NA

With disconnecting neutral NA

Number of poles	Rated current	Bbn 4016779	Order details		Price 1 piece	Weight 1 piece	Pack unit
	In A	EAN	Type code	Order code			
1+NA	0.5	531825	S 201-K 0.5 NA	2CDS251103R0157		0.250	5
	1	531832	S 201-K 1 NA	2CDS251103R0217		0.250	5
	1.6	531849	S 201-K 1.6 NA	2CDS251103R0257		0.250	5
	2	531856	S 201-K 2 NA	2CDS251103R0277		0.250	5
	3	531863	S 201-K 3 NA	2CDS251103R0317		0.250	5
	4	531870	S 201-K 4 NA	2CDS251103R0337		0.250	5
	6	531887	S 201-K 6 NA	2CDS251103R0377		0.250	5
	8	531894	S 201-K 8 NA	2CDS251103R0407		0.250	5
	10	531900	S 201-K 10 NA	2CDS251103R0427		0.250	5
	13	531917	S 201-K 13 NA	2CDS251103R0447		0.250	5
	16	531924	S 201-K 16 NA	2CDS251103R0467		0.250	5
	20	531931	S 201-K 20 NA	2CDS251103R0487		0.250	5
	25	531948	S 201-K 25 NA	2CDS251103R0517		0.250	5
	32	531955	S 201-K 32 NA	2CDS251103R0537		0.250	5
	40	531962	S 201-K 40 NA	2CDS251103R0557		0.250	5
	50	551144	S 201-K 50 NA	2CDS251103R0577		0.250	5
	63	551151	S 201-K 63 NA	2CDS251103R0607		0.250	5

Number of poles	Rated current	Bbn 4016779	Order details		Price 1 piece	Weight 1 piece	Pack unit
	In A	EAN	Type code	Order code			
3+NA	0.5	532617	S 203-K 0.5 NA	2CDS253103R0157		0.500	1
	1	532624	S 203-K 1 NA	2CDS253103R0217		0.500	1
	1.6	532631	S 203-K 1.6 NA	2CDS253103R0257		0.500	1
	2	532648	S 203-K 2 NA	2CDS253103R0277		0.500	1
	3	532655	S 203-K 3 NA	2CDS253103R0317		0.500	1
	4	532662	S 203-K 4 NA	2CDS253103R0337		0.500	1
	6	532679	S 203-K 6 NA	2CDS253103R0377		0.500	1
	8	532686	S 203-K 8 NA	2CDS253103R0407		0.500	1
	10	532693	S 203-K 10 NA	2CDS253103R0427		0.500	1
	13	532709	S 203-K 13 NA	2CDS253103R0447		0.500	1
	16	532716	S 203-K 16 NA	2CDS253103R0467		0.500	1
	20	532723	S 203-K 20 NA	2CDS253103R0487		0.500	1
	25	532730	S 203-K 25 NA	2CDS253103R0517		0.500	1
	32	532747	S 203-K 32 NA	2CDS253103R0537		0.500	1
	40	532754	S 203-K 40 NA	2CDS253103R0557		0.500	1
	50	551205	S 203-K 50 NA	2CDS253103R0577		0.500	1
	63	551212	S 203-K 63 NA	2CDS253103R0607		0.500	1

Where to find more:

Coordination Tables for S 200 MCBs: p.10/37 for back-up and p.10/50 for selectivity

Worldwide Marks and Approvals of MCBs p.11/92

Frequently asked question - FAQ:

Where can I get certificates, declarations and CAD drawings?

You can find all of them on www.abb.com

Maybe you are also interested in:

Auxiliary Elements for MCBs p.4/2

Accessories for MCBs p.4/16

Busbar Systems p.4/21

MCBs

S 200 series 6000 Z characteristic



S 201



S 202

S 200 Z characteristic

Function: protection and control of the electronic circuits against lower and long duration overloads and short-circuits.

Applications: commercial and industrial.

Standard: IEC/EN 60947-2

Icu=10 kA

2

Number of poles	Rated current	Bbn 4016779	Order details		Price 1 piece	Weight 1 piece	Pack unit
	In A	EAN	Type code	Order code			
1	0.5	530309	S 201-Z 0.5	2CDS251001R0158		0.125	10
	1	530330	S 201-Z 1	2CDS251001R0218		0.125	10
	1.6	530347	S 201-Z 1.6	2CDS251001R0258		0.125	10
	2	530354	S 201-Z 2	2CDS251001R0278		0.125	10
	3	530361	S 201-Z 3	2CDS251001R0318		0.125	10
	4	530378	S 201-Z 4	2CDS251001R0338		0.125	10
	6	530408	S 201-Z 6	2CDS251001R0378		0.125	10
	8	530415	S 201-Z 8	2CDS251001R0408		0.125	10
	10	530422	S 201-Z 10	2CDS251001R0428		0.125	10
	16	530439	S 201-Z 16	2CDS251001R0468		0.125	10
	20	530446	S 201-Z 20	2CDS251001R0488		0.125	10
	25	530453	S 201-Z 25	2CDS251001R0518		0.125	10
	32	530460	S 201-Z 32	2CDS251001R0538		0.125	10
	40	530477	S 201-Z 40	2CDS251001R0558		0.125	10
	50	551915	S 201-Z 50	2CDS251001R0578		0.125	10
	63	551922	S 201-Z 63	2CDS251001R0608		0.125	10

Number of poles	Rated current	Bbn 4016779	Order details		Price 1 piece	Weight 1 piece	Pack unit
	In A	EAN	Type code	Order code			
2	0.5	530682	S 202-Z 0.5	2CDS252001R0158		0.250	5
	1	530675	S 202-Z 1	2CDS252001R0218		0.250	5
	1.6	530699	S 202-Z 1.6	2CDS252001R0258		0.250	5
	2	530705	S 202-Z 2	2CDS252001R0278		0.250	5
	3	530712	S 202-Z 3	2CDS252001R0318		0.250	5
	4	530729	S 202-Z 4	2CDS252001R0338		0.250	5
	6	530736	S 202-Z 6	2CDS252001R0378		0.250	5
	8	530743	S 202-Z 8	2CDS252001R0408		0.250	5
	10	530750	S 202-Z 10	2CDS252001R0428		0.250	5
	16	530767	S 202-Z 16	2CDS252001R0468		0.250	5
	20	530774	S 202-Z 20	2CDS252001R0488		0.250	5
	25	530781	S 202-Z 25	2CDS252001R0518		0.250	5
	32	530798	S 202-Z 32	2CDS252001R0538		0.250	5
	40	530804	S 202-Z 40	2CDS252001R0558		0.250	5
	50	551939	S 202-Z 50	2CDS252001R0578		0.250	5
	63	551946	S 202-Z 63	2CDS252001R0608		0.250	5

MCBs

S 200 series 6000 Z characteristic



S 203



S 204

Number of poles	Rated current In A	Bbn 4016779 EAN	Order details		Price 1 piece	Weight 1 piece kg	Pack unit pc.
			Type code	Order code			
3	0.5	530972	S 203-Z 0.5	2CDS253001R0158		0.375	1
	1	530989	S 203-Z 1	2CDS253001R0218		0.375	1
	1.6	530996	S 203-Z 1.6	2CDS253001R0258		0.375	1
	2	531009	S 203-Z 2	2CDS253001R0278		0.375	1
	3	531016	S 203-Z 3	2CDS253001R0318		0.375	1
	4	531023	S 203-Z 4	2CDS253001R0338		0.375	1
	6	531030	S 203-Z 6	2CDS253001R0378		0.375	1
	8	531047	S 203-Z 8	2CDS253001R0408		0.375	1
	10	531054	S 203-Z 10	2CDS253001R0428		0.375	1
	16	531061	S 203-Z 16	2CDS253001R0468		0.375	1
	20	531078	S 203-Z 20	2CDS253001R0488		0.375	1
	25	531085	S 203-Z 25	2CDS253001R0518		0.375	1
	32	531092	S 203-Z 32	2CDS253001R0538		0.375	1
	40	531108	S 203-Z 40	2CDS253001R0558		0.375	1
	50	551953	S 203-Z 50	2CDS253001R0578		0.375	1
	63	551960	S 203-Z 63	2CDS253001R0608		0.375	1

Number of poles	Rated current In A	Bbn 4016779 EAN	Order details		Price 1 piece	Weight 1 piece kg	Pack unit pc.
			Type code	Order code			
4	0.5	530248	S 204-Z 0.5	2CDS254001R0158		0.500	1
	1	531320	S 204-Z 1	2CDS254001R0218		0.500	1
	1.6	531443	S 204-Z 1.6	2CDS254001R0258		0.500	1
	2	531436	S 204-Z 2	2CDS254001R0278		0.500	1
	3	531337	S 204-Z 3	2CDS254001R0318		0.500	1
	4	531344	S 204-Z 4	2CDS254001R0338		0.500	1
	6	531351	S 204-Z 6	2CDS254001R0378		0.500	1
	8	531368	S 204-Z 8	2CDS254001R0408		0.500	1
	10	531375	S 204-Z 10	2CDS254001R0428		0.500	1
	16	531382	S 204-Z 16	2CDS254001R0468		0.500	1
	20	531399	S 204-Z 20	2CDS254001R0488		0.500	1
	25	531405	S 204-Z 25	2CDS254001R0518		0.500	1
	32	531412	S 204-Z 32	2CDS254001R0538		0.500	1
	40	531429	S 204-Z 40	2CDS254001R0558		0.500	1
	50	551977	S 204-Z 50	2CDS254001R0578		0.500	1
	63	551984	S 204-Z 63	2CDS254001R0608		0.500	1

Where to find more:

Coordination Tables for S 200 MCBs:
p.10/37 for back-up and p.10/50 for selectivity
Worldwide Marks and Approvals of MCBs p.11/92

Frequently asked question - FAQ:

Where can I get certificates, declarations and CAD drawings?
You can find all of them on www.abb.com

Maybe you are also interested in:

Auxiliary Elements for MCBs p.4/2
Accessories for MCBs p.4/16
Busbar Systems p.4/21



S 201 NA

2CDS21103R0158



S 203 NA

2CDS21103R0158

With disconnecting neutral NA

Number of poles	Rated current	Bbn 4016779	Order details		Price 1 piece	Weight 1 piece kg	Pack unit pc.
	In A	EAN	Type code	Order code			
1+NA	0.5	532143	S 201-Z 0.5 NA	2CDS251103R0158		0.260	5
	1	532150	S 201-Z 1 NA	2CDS251103R0218		0.260	5
	1.6	532167	S 201-Z 1.6 NA	2CDS251103R0258		0.260	5
	2	532174	S 201-Z 2 NA	2CDS251103R0278		0.260	5
	3	532181	S 201-Z 3 NA	2CDS251103R0318		0.260	5
	4	532198	S 201-Z 4 NA	2CDS251103R0338		0.260	5
	6	532204	S 201-Z 6 NA	2CDS251103R0378		0.260	5
	8	532211	S 201-Z 8 NA	2CDS251103R0408		0.260	5
	10	532228	S 201-Z 10 NA	2CDS251103R0428		0.260	5
	16	532235	S 201-Z 16 NA	2CDS251103R0468		0.260	5
	20	532242	S 201-Z 20 NA	2CDS251103R0488		0.260	5
	25	532259	S 201-Z 25 NA	2CDS251103R0518		0.260	5
	32	532266	S 201-Z 32 NA	2CDS251103R0538		0.260	5
	40	532273	S 201-Z 40 NA	2CDS251103R0558		0.260	5
	50	552127	S 201-Z 50 NA	2CDS251103R0578		0.320	5
63	552134	S 201-Z 63 NA	2CDS251103R0608		0.320	5	

2

Number of poles	Rated current	Bbn 4016779	Order details		Price 1 piece	Weight 1 piece kg	Pack unit pc.
	In A	EAN	Type code	Order code			
3+NA	0.5	53292 1	S 203-Z 0.5 NA	2CDS253103R0158		0.520	1
	1	53293 8	S 203-Z 1 NA	2CDS253103R0218		0.520	1
	1.6	53294 5	S 203-Z 1.6 NA	2CDS253103R0258		0.520	1
	2	53295 2	S 203-Z 2 NA	2CDS253103R0278		0.520	1
	3	53297 6	S 203-Z 3 NA	2CDS253103R0318		0.520	1
	4	53298 3	S 203-Z 4 NA	2CDS253103R0338		0.520	1
	6	53299 0	S 203-Z 6 NA	2CDS253103R0378		0.520	1
	8	53300 3	S 203-Z 8 NA	2CDS253103R0408		0.520	1
	10	53301 0	S 203-Z 10 NA	2CDS253103R0428		0.520	1
	16	53302 7	S 203-Z 16 NA	2CDS253103R0468		0.520	1
	20	53305 8	S 203-Z 20 NA	2CDS253103R0488		0.520	1
	25	53306 5	S 203-Z 25 NA	2CDS253103R0518		0.520	1
	32	53307 2	S 203-Z 32 NA	2CDS253103R0538		0.520	1
	40	53308 9	S 203-Z 40 NA	2CDS253103R0558		0.520	1
	50	55214 1	S 203-Z 50 NA	2CDS253103R0578		0.640	1
	63	55216 5	S 203-Z 63 NA	2CDS253103R0608		0.640	1

MCBs

S 200 series M 10000 B characteristic



S 201 M



S 202 M



S 203 M



S 204 M

Where to find more:
 Coordination Tables for S 200M
 MCBs: p.10/37 for back-up and
 p.10/56 for selectivity
 Worldwide Marks and Approvals of
 MCBs p.11/92

Frequently asked question - FAQ:
 Where can I get certificates, declara-
 tions and CAD drawings?
 You can find all of them on
 www.abb.com

Maybe you are also interested in:
 Auxiliary Elements for MCBs p.4/2
 Accessories for MCBs p.4/16
 Busbar Systems p.4/21

S 200 M-B characteristic

Function: protection and control of the circuits against overloads and short-circuits; protection for people and large length of cables in TN and IT systems.

Applications: residential, commercial and industrial.

Standard: IEC/EN 60898-1, IEC/EN 60947-2

Icn=10 kA

Number of poles	Rated current	Bbn 4016779	Order details		Price 1 piece	Weight 1 piece	Pack unit
	In A		EAN	Type code			
1	6	549424	S 201 M-B 6	2CDS271001R0065		0.125	10
	10	549431	S 201 M-B 10	2CDS271001R0105		0.125	10
	13	549448	S 201 M-B 13	2CDS271001R0135		0.125	10
	16	549455	S 201 M-B 16	2CDS271001R0165		0.125	10
	20 ①	549462	S 201 M-B 20	2CDS271001R0205		0.125	10
	25	549479	S 201 M-B 25	2CDS271001R0255		0.125	10
	32 ②	549486	S 201 M-B 32	2CDS271001R0325		0.125	10
	40 ③	549493	S 201 M-B 40	2CDS271001R0405		0.125	10
	50	543811	S 201 M-B 50	2CDS271001R0505		0.125	10
	63	543828	S 201 M-B 63	2CDS271001R0635		0.125	10

Number of poles	Rated current	Bbn 4016779	Order details		Price 1 piece	Weight 1 piece	Pack unit
	In A		EAN	Type code			
2	6	549585	S 202 M-B 6	2CDS272001R0065		0.250	5
	10	549592	S 202 M-B 10	2CDS272001R0105		0.250	5
	13	549608	S 202 M-B 13	2CDS272001R0135		0.250	5
	16	549615	S 202 M-B 16	2CDS272001R0165		0.250	5
	20	549622	S 202 M-B 20	2CDS272001R0205		0.250	5
	25	549639	S 202 M-B 25	2CDS272001R0255		0.250	5
	32	549646	S 202 M-B 32	2CDS272001R0325		0.250	5
	40	549653	S 202 M-B 40	2CDS272001R0405		0.250	5
	50	543859	S 202 M-B 50	2CDS272001R0505		0.250	5
	63	543866	S 202 M-B 63	2CDS272001R0635		0.250	5

Number of poles	Rated current	Bbn 4016779	Order details		Price 1 piece	Weight 1 piece	Pack unit
	In A		EAN	Type code			
3	6	549660	S 203 M-B 6	2CDS273001R0065		0.375	1
	10	549677	S 203 M-B 10	2CDS273001R0105		0.375	1
	13	549684	S 203 M-B 13	2CDS273001R0135		0.375	1
	16	549691	S 203 M-B 16	2CDS273001R0165		0.375	1
	20 ①	549707	S 203 M-B 20	2CDS273001R0205		0.375	1
	25	549714	S 203 M-B 25	2CDS273001R0255		0.375	1
	32 ②	549721	S 203 M-B 32	2CDS273001R0325		0.375	1
	40 ③	549738	S 203 M-B 40	2CDS273001R0405		0.375	1
	50	543873	S 203 M-B 50	2CDS273001R0505		0.375	1
	63	543880	S 203 M-B 63	2CDS273001R0635		0.375	1

- ① suitable for flow-type heaters 12 kW
- ② suitable for flow-type heaters 18 kW
- ③ suitable for flow-type heaters 21, 24 and 27 kW



S 201 M NA



S 203 M NA

Number of poles	Rated current	Bbn 4016779	Order details		Price 1 piece	Weight 1 piece	Pack unit
	In A		EAN	Type code			
4	6	549820	S 204 M-B 6	2CDS274001R0065		0.500	1
	10	549837	S 204 M-B 10	2CDS274001R0105		0.500	1
	13	549844	S 204 M-B 13	2CDS274001R0135		0.500	1
	16	549851	S 204 M-B 16	2CDS274001R0165		0.500	1
	20	549868	S 204 M-B 20	2CDS274001R0205		0.500	1
	25	549875	S 204 M-B 25	2CDS274001R0255		0.500	1
	32	549882	S 204 M-B 32	2CDS274001R0325		0.500	1
	40	549899	S 204 M-B 40	2CDS274001R0405		0.500	1
	50	543910	S 204 M-B 50	2CDS274001R0505		0.500	1
	63	543927	S 204 M-B 63	2CDS274001R0635		0.500	1

2

With disconnecting neutral NA

Number of poles	Rated current	Bbn 4016779	Order details		Price 1 piece	Weight 1 piece	Pack unit
	In A		EAN	Type code			
1+NA	6	549509	S 201 M-B 6 NA	2CDS271103R0065		0.250	5
	10	549516	S 201 M-B 10 NA	2CDS271103R0105		0.250	5
	13	549523	S 201 M-B 13 NA	2CDS271103R0135		0.250	5
	16	549530	S 201 M-B 16 NA	2CDS271103R0165		0.250	5
	20 ①	549547	S 201 M-B 20 NA	2CDS271103R0205		0.250	5
	25	549554	S 201 M-B 25 NA	2CDS271103R0255		0.250	5
	32 ②	549561	S 201 M-B 32 NA	2CDS271103R0325		0.250	5
	40 ③	549578	S 201 M-B 40 NA	2CDS271103R0405		0.250	5
	50	543835	S 201 M-B 50 NA	2CDS271103R0505		0.250	5
	63	543842	S 201 M-B 63 NA	2CDS271103R0635		0.250	5

Number of poles	Rated current	Bbn 4016779	Order details		Price 1 piece	Weight 1 piece	Pack unit
	In A		EAN	Type code			
3+NA	6	549745	S 203 M-B 6 NA	2CDS273103R0065		0.500	1
	10	549752	S 203 M-B 10 NA	2CDS273103R0105		0.500	1
	13	549769	S 203 M-B 13 NA	2CDS273103R0135		0.500	1
	16	549776	S 203 M-B 16 NA	2CDS273103R0165		0.500	1
	20 ①	549783	S 203 M-B 20 NA	2CDS273103R0205		0.500	1
	25	549790	S 203 M-B 25 NA	2CDS273103R0255		0.500	1
	32 ②	549806	S 203 M-B 32 NA	2CDS273103R0325		0.500	1
	40 ③	549813	S 203 M-B 40 NA	2CDS273103R0405		0.500	1
	50	543897	S 203 M-B 50 NA	2CDS273103R0505		0.500	1
	63	543903	S 203 M-B 63 NA	2CDS273103R0635		0.580	1

① suitable for flow-type heaters 12 kW ③ suitable for flow-type heaters 21, 24 and 27 kW
 ② suitable for flow-type heaters 18 kW

MCBs

S 200 series M 10000 C characteristic



S 201 M



S 202 M

S 200 M-C characteristic

Function: protection and control of the circuits against overloads and short-circuits; protection for resistive and inductive loads with low inrush current.

Applications: residential, commercial and industrial.

Standard: IEC/EN 60898-1, IEC/EN 60947-2

Icn=10 kA

Number of poles	Rated current	Bbn 4016779	Order details		Price 1 piece	Weight 1 piece	Pack unit
	In A		EAN	Type code			
1	0.5	549905	S 201 M-C 0.5	2CDS271001R0984		0.125	10
	1	549929	S 201 M-C 1	2CDS271001R0014		0.125	10
	1.6	549912	S 201 M-C 1.6	2CDS271001R0974		0.125	10
	2	549936	S 201 M-C 2	2CDS271001R0024		0.125	10
	3	549943	S 201 M-C 3	2CDS271001R0034		0.125	10
	4	549950	S 201 M-C 4	2CDS271001R0044		0.125	10
	6	549967	S 201 M-C 6	2CDS271001R0064		0.125	10
	8	549974	S 201 M-C 8	2CDS271001R0084		0.125	10
	10	549981	S 201 M-C 10	2CDS271001R0104		0.125	10
	13	549998	S 201 M-C 13	2CDS271001R0134		0.125	10
	16	550000	S 201 M-C 16	2CDS271001R0164		0.125	10
	20 ^①	550017	S 201 M-C 20	2CDS271001R0204		0.125	10
	25	550024	S 201 M-C 25	2CDS271001R0254		0.125	10
	32 ^②	550031	S 201 M-C 32	2CDS271001R0324		0.125	10
	40 ^②	550048	S 201 M-C 40	2CDS271001R0404		0.125	10
	50	543934	S 201 M-C 50	2CDS271001R0504		0.125	10
63	543941	S 201 M-C 63	2CDS271001R0634		0.125	10	

Number of poles	Rated current	Bbn 4016779	Order details		Price 1 piece	Weight 1 piece	Pack unit
	In A		EAN	Type code			
2	0.5	550208	S 202 M-C 0.5	2CDS272001R0984		0.250	5
	1	550222	S 202 M-C 1	2CDS272001R0014		0.250	5
	1.6	550215	S 202 M-C 1.6	2CDS272001R0974		0.250	5
	2	550239	S 202 M-C 2	2CDS272001R0024		0.250	5
	3	550246	S 202 M-C 3	2CDS272001R0034		0.250	5
	4	550253	S 202 M-C 4	2CDS272001R0044		0.250	5
	6	550260	S 202 M-C 6	2CDS272001R0064		0.250	5
	8	550277	S 202 M-C 8	2CDS272001R0084		0.250	5
	10	550284	S 202 M-C 10	2CDS272001R0104		0.250	5
	13	550291	S 202 M-C 13	2CDS272001R0134		0.250	5
	16	550307	S 202 M-C 16	2CDS272001R0164		0.250	5
	20	550314	S 202 M-C 20	2CDS272001R0204		0.250	5
	25	550321	S 202 M-C 25	2CDS272001R0254		0.250	5
	32	550338	S 202 M-C 32	2CDS272001R0324		0.250	5
	40	550345	S 202 M-C 40	2CDS272001R0404		0.250	5
	50	543972	S 202 M-C 50	2CDS272001R0504		0.250	5
63	543989	S 202 M-C 63	2CDS272001R0634		0.250	5	

- ^① suitable for flow-type heaters 12 kW
- ^② suitable for flow-type heaters 18 kW
- ^③ suitable for flow-type heaters 21, 24 and 27 kW

Where to find more:

Coordination Tables for S 200M MCBs: p.10/37 for back-up and p.10/56 for selectivity
Worldwide Marks and Approvals of MCBs p.11/92

Frequently asked question - FAQ:

Where can I get certificates, declarations and CAD drawings? You can find all of them on www.abb.com

Maybe you are also interested in:

Auxiliary Elements for MCBs p.4/2
Accessories for MCBs p.4/16
Busbar Systems p.4/21



S 203 M



S 204 M

Number of poles	Rated current	Bbn 4016779	Order details		Price 1 piece	Weight 1 piece kg	Pack unit pc.
	In A	EAN	Type code	Order code			
3	0.5	550352	S 203 M-C 0.5	2CDS273001R0984		0.375	1
	1	550376	S 203 M-C 1	2CDS273001R0014		0.375	1
	1.6	550369	S 203 M-C 1.6	2CDS273001R0974		0.375	1
	2	550383	S 203 M-C 2	2CDS273001R0024		0.375	1
	3	550390	S 203 M-C 3	2CDS273001R0034		0.375	1
	4	550406	S 203 M-C 4	2CDS273001R0044		0.375	1
	6	550413	S 203 M-C 6	2CDS273001R0064		0.375	1
	8	550420	S 203 M-C 8	2CDS273001R0084		0.375	1
	10	550437	S 203 M-C 10	2CDS273001R0104		0.375	1
	13	550444	S 203 M-C 13	2CDS273001R0134		0.375	1
	16	550451	S 203 M-C 16	2CDS273001R0164		0.375	1
	20 ①	550468	S 203 M-C 20	2CDS273001R0204		0.375	1
	25	550475	S 203 M-C 25	2CDS273001R0254		0.375	1
	32 ②	550482	S 203 M-C 32	2CDS273001R0324		0.375	1
	40 ③	550499	S 203 M-C 40	2CDS273001R0404		0.375	1
	50	543996	S 203 M-C 50	2CDS273001R0504		0.375	1
63	544009	S 203 M-C 63	2CDS273001R0634		0.375	1	

2

Number of poles	Rated current	Bbn 4016779	Order details		Price 1 piece	Weight 1 piece kg	Pack unit pc.
	In A	EAN	Type code	Order code			
4	0.5	550659	S 204 M-C 0.5	2CDS274001R0984		0.500	1
	1	550673	S 204 M-C 1	2CDS274001R0014		0.500	1
	1.6	550666	S 204 M-C 1.6	2CDS274001R0974		0.500	1
	2	550680	S 204 M-C 2	2CDS274001R0024		0.500	1
	3	550697	S 204 M-C 3	2CDS274001R0034		0.500	1
	4	550703	S 204 M-C 4	2CDS274001R0044		0.500	1
	6	550710	S 204 M-C 6	2CDS274001R0064		0.500	1
	8	550727	S 204 M-C 8	2CDS274001R0084		0.500	1
	10	550734	S 204 M-C 10	2CDS274001R0104		0.500	1
	13	550741	S 204 M-C 13	2CDS274001R0134		0.500	1
	16	550758	S 204 M-C 16	2CDS274001R0164		0.500	1
	20	550765	S 204 M-C 20	2CDS274001R0204		0.500	1
	25	550772	S 204 M-C 25	2CDS274001R0254		0.500	1
	32	550789	S 204 M-C 32	2CDS274001R0324		0.500	1
	40	550796	S 204 M-C 40	2CDS274001R0404		0.500	1
	50	544030	S 204 M-C 50	2CDS274001R0504		0.500	1
63	544047	S 204 M-C 63	2CDS274001R0634		0.500	1	

① suitable for flow-type heaters 12 kW
 ② suitable for flow-type heaters 18 kW

③ suitable for flow-type heaters 21, 24 and 27 kW

MCBs

S 200 series M 10000 C characteristic

2



S 201 M NA



S 203 M NA

With disconnecting neutral NA

Number of poles	Rated current In A	Bbn 4016779 EAN	Order details		Price 1 piece	Weight 1 piece kg	Pack unit pc.
			Type code	Order code			
1+NA	0,5	550055	S 201 M-C 0.5 NA	2CDS271103R0984		0.250	5
	1	550079	S 201 M-C 1 NA	2CDS271103R0014		0.250	5
	1.6	550062	S 201 M-C 1.6 NA	2CDS271103R0974		0.250	5
	2	550086	S 201 M-C 2 NA	2CDS271103R0024		0.250	5
	3	550093	S 201 M-C 3 NA	2CDS271103R0034		0.250	5
	4	550109	S 201 M-C 4 NA	2CDS271103R0044		0.250	5
	6	550116	S 201 M-C 6 NA	2CDS271103R0064		0.250	5
	8	550123	S 201 M-C 8 NA	2CDS271103R0084		0.250	5
	10	550130	S 201 M-C 10 NA	2CDS271103R0104		0.250	5
	13	550147	S 201 M-C 13 NA	2CDS271103R0134		0.250	5
	16	550154	S 201 M-C 16 NA	2CDS271103R0164		0.250	5
	20 ①	550161	S 201 M-C 20 NA	2CDS271103R0204		0.250	5
	25	550178	S 201 M-C 25 NA	2CDS271103R0254		0.250	5
	32 ②	550185	S 201 M-C 32 NA	2CDS271103R0324		0.250	5
	40 ③	550192	S 201 M-C 40 NA	2CDS271103R0404		0.250	5
	50	543958	S 201 M-C 50 NA	2CDS271103R0504		0.250	5
63	543965	S 201 M-C 63 NA	2CDS271103R0634		0.250	5	

Number of poles	Rated current In A	Bbn 4016779 EAN	Order details		Price 1 piece	Weight 1 piece kg	Pack unit pc.
			Type code	Order code			
3+NA	0,5	550512	S 203 M-C 0.5 NA	2CDS273103R0984		0.500	1
	1	550529	S 203 M-C 1 NA	2CDS273103R0014		0.500	1
	1.6	550505	S 203 M-C 1.6 NA	2CDS273103R0974		0.500	1
	2	550536	S 203 M-C 2 NA	2CDS273103R0024		0.500	1
	3	550543	S 203 M-C 3 NA	2CDS273103R0034		0.500	1
	4	550550	S 203 M-C 4 NA	2CDS273103R0044		0.500	1
	6	550567	S 203 M-C 6 NA	2CDS273103R0064		0.500	1
	8	550574	S 203 M-C 8 NA	2CDS273103R0084		0.500	1
	10	550581	S 203 M-C 10 NA	2CDS273103R0104		0.500	1
	13	550598	S 203 M-C 13 NA	2CDS273103R0134		0.500	1
	16	550604	S 203 M-C 16 NA	2CDS273103R0164		0.500	1
	20 ①	550611	S 203 M-C 20 NA	2CDS273103R0204		0.500	1
	25	550628	S 203 M-C 25 NA	2CDS273103R0254		0.500	1
	32 ②	550635	S 203 M-C 32 NA	2CDS273103R0324		0.500	1
	40 ③	550642	S 203 M-C 40 NA	2CDS273103R0404		0.500	1
	50	544016	S 203 M-C 50 NA	2CDS273103R0504		0.580	1
63	544023	S 203 M-C 63 NA	2CDS273103R0634		0.580	1	

- ① suitable for flow-type heaters 12 kW
- ② suitable for flow-type heaters 18 kW
- ③ suitable for flow-type heaters 21, 24 and 27 kW

Where to find more:
 Coordination Tables for S 200M MCBs: p.10/37 for back-up and p.10/56 for selectivity
 Worldwide Marks and Approvals of MCBs p.11/92

Frequently asked question - FAQ:
 Where can I get certificates, declarations and CAD drawings?
 You can find all of them on www.abb.com

Maybe you are also interested in:
 Auxiliary Elements for MCBs p.4/2
 Accessories for MCBs p.4/16
 Busbar Systems p.4/21

MCBs

S 200 series M 10000 D characteristic



S 201 M



S 202 M

S 200 M-D characteristic

Function: protection and control of the circuits against overloads and short-circuits; protection for circuits which supply loads with high inrush current at the circuit closing (LV/LV transformers, breakdown lamps).

Applications: residential, commercial and industrial.

Standard: IEC/EN 60898-1, IEC/EN 60947-2

Icn=10 kA

2

Number of poles	Rated current	Bbn 4016779	Order details		Price 1 piece	Weight 1 piece kg	Pack unit pc.
	In A	EAN	Type code	Order code			
1	0.5	599832	S 201 M-D 0.5	2CDS271001R0981		0.125	10
	1	500313	S 201 M-D 1	2CDS271001R0011		0.125	10
	1.6	599825	S 201 M-D 1.6	2CDS271001R0971		0.125	10
	2	599337	S 201 M-D 2	2CDS271001R0021		0.125	10
	3	599351	S 201 M-D 3	2CDS271001R0031		0.125	10
	4	599357	S 201 M-D 4	2CDS271001R0041		0.125	10
	6	599399	S 201 M-D 6	2CDS271001R0061		0.125	10
	8	599405	S 201 M-D 8	2CDS271001R0081		0.125	10
	10	599429	S 201 M-D 10	2CDS271001R0101		0.125	10
	13	663267	S 201 M-D 13	2CDS271001R0131		0.125	10
	16	599450	S 201 M-D 16	2CDS271001R0161		0.125	10
	20 ①	500467	S 201 M-D 20	2CDS271001R0201		0.125	10
	25	599498	S 201 M-D 25	2CDS271001R0251		0.125	10
	32 ②	599566	S 201 M-D 32	2CDS271001R0321		0.125	10
	40 ③	599610	S 201 M-D 40	2CDS271001R0401		0.125	10
	50	599702	S 201 M-D 50	2CDS271001R0501		0.125	10
	63	599818	S 201 M-D 63	2CDS271001R0631		0.125	10

Number of poles	Rated current	Bbn 4016779	Order details		Price 1 piece	Weight 1 piece kg	Pack unit pc.
	In A	EAN	Type code	Order code			
2	0.5	600880	S 202 M-D 0.5	2CDS272001R0981		0.250	5
	1	600361	S 202 M-D 1	2CDS272001R0011		0.250	5
	1.6	600873	S 202 M-D 1.6	2CDS272001R0971		0.250	5
	2	600385	S 202 M-D 2	2CDS272001R0021		0.250	5
	3	600408	S 202 M-D 3	2CDS272001R0031		0.250	5
	4	600422	S 202 M-D 4	2CDS272001R0041		0.250	5
	6	600446	S 202 M-D 6	2CDS272001R0061		0.250	5
	8	600453	S 202 M-D 8	2CDS272001R0081		0.250	5
	10	600477	S 202 M-D 10	2CDS272001R0101		0.250	5
	13	663274	S 202 M-D 13	2CDS272001R0131		0.250	5
	16	600507	S 202 M-D 16	2CDS272001R0161		0.250	5
	20	600514	S 202 M-D 20	2CDS272001R0201		0.250	5
	25	600545	S 202 M-D 25	2CDS272001R0251		0.250	5
	32	600613	S 202 M-D 32	2CDS272001R0321		0.250	5
	40	600668	S 202 M-D 40	2CDS272001R0401		0.250	5
	50	600750	S 202 M-D 50	2CDS272001R0501		0.250	5
	63	600866	S 202 M-D 63	2CDS272001R0631		0.250	5

① suitable for flow-type heaters 12 kW ③ suitable for flow-type heaters 21, 24 and 27 kW
 ② suitable for flow-type heaters 18 kW

MCBs

S 200 series M 10000 D characteristic

2



S 203 M



S 204 M

Number of poles	Rated current	Bbn 4016779	Order details		Price 1 piece	Weight 1 piece	Pack unit
	In A		EAN	Type code			
3	0.5	601412	S 203 M-D 0.5	2CDS273001R0981		0.375	1
	1	600897	S 203 M-D 1	2CDS273001R0011		0.375	1
	1.6	601405	S 203 M-D 1.6	2CDS273001R0971		0.375	1
	2	600910	S 203 M-D 2	2CDS273001R0021		0.375	1
	3	600934	S 203 M-D 3	2CDS273001R0031		0.375	1
	4	600958	S 203 M-D 4	2CDS273001R0041		0.375	1
	6	600972	S 203 M-D 6	2CDS273001R0061		0.375	1
	8	600989	S 203 M-D 8	2CDS273001R0081		0.375	1
	10	601009	S 203 M-D 10	2CDS273001R0101		0.375	1
	13	663281	S 203 M-D 13	2CDS273001R0131		0.375	1
	16	601030	S 203 M-D 16	2CDS273001R0161		0.375	1
	20 ①	601047	S 203 M-D 20	2CDS273001R0201		0.375	1
	25	601078	S 203 M-D 25	2CDS273001R0251		0.375	1
	32 ②	601146	S 203 M-D 32	2CDS273001R0321		0.375	1
	40 ③	601191	S 203 M-D 40	2CDS273001R0401		0.375	1
	50	601283	S 203 M-D 50	2CDS273001R0501		0.375	1
63	601399	S 203 M-D 63	2CDS273001R0631		0.375	1	

Number of poles	Rated current	Bbn 4016779	Order details		Price 1 piece	Weight 1 piece	Pack unit
	In A		EAN	Type code			
4	0.5	602143	S 204 M-D 0.5	2CDS274001R0981		0.500	1
	1	601634	S 204 M-D 1	2CDS274001R0011		0.500	1
	1.6	602136	S 204 M-D 1.6	2CDS274001R0971		0.500	1
	2	601658	S 204 M-D 2	2CDS274001R0021		0.500	1
	3	601672	S 204 M-D 3	2CDS274001R0031		0.500	1
	4	601696	S 204 M-D 4	2CDS274001R0041		0.500	1
	6	601719	S 204 M-D 6	2CDS274001R0061		0.500	1
	8	601726	S 204 M-D 8	2CDS274001R0081		0.500	1
	10	601740	S 204 M-D 10	2CDS274001R0101		0.500	1
	13	663298	S 204 M-D 13	2CDS274001R0131		0.500	1
	16	601771	S 204 M-D 16	2CDS274001R0161		0.500	1
	20	601788	S 204 M-D 20	2CDS274001R0201		0.500	1
	25	601818	S 204 M-D 25	2CDS274001R0251		0.500	1
	32	601887	S 204 M-D 32	2CDS274001R0321		0.500	1
	40	601931	S 204 M-D 40	2CDS274001R0401		0.500	1
	50	602013	S 204 M-D 50	2CDS274001R0501		0.500	1
63	602129	S 204 M-D 63	2CDS274001R0631		0.500	1	

① suitable for flow-type heaters 12 kW
 ② suitable for flow-type heaters 18 kW

③ suitable for flow-type heaters 21, 24 and 27 kW

Where to find more:

Coordination Tables for S 200M MCBs: p.10/37 for back-up and p.10/56 for selectivity
 Worldwide Marks and Approvals of MCBs p.11/92

Frequently asked question - FAQ:

Where can I get certificates, declarations and CAD drawings?
 You can find all of them on www.abb.com

Maybe you are also interested in:

Auxiliary Elements for MCBs p.4/2
 Accessories for MCBs p.4/16
 Busbar Systems p.4/21



S 201 M NA



S 203 M NA

With disconnecting neutral NA

Number of poles	Rated current	Bbn 4016779	Order details		Price 1 piece	Weight 1 piece kg	Pack unit pc.
	In A	EAN	Type code	Order code			
1+NA	0.5	600354	S 201 M-D 0.5 NA	2CDS271103R0981		0.250	5
	1	599849	S 201 M-D 1 NA	2CDS271103R0011		0.250	5
	1.6	600347	S 201-M D 1.6 NA	2CDS271103R0971		0.250	5
	2	599863	S 201 M-D 2 NA	2CDS271103R0021		0.250	5
	3	599887	S 201 M-D 3 NA	2CDS271103R0031		0.250	5
	4	599900	S 201 M-D 4 NA	2CDS271103R0041		0.250	5
	6	599924	S 201 M-D 6 NA	2CDS271103R0061		0.250	5
	8	599931	S 201 M-D 8 NA	2CDS271103R0081		0.250	5
	10	599948	S 201 M-D 10 NA	2CDS271103R0101		0.250	5
	13	663304	S 201 M-D 13 NA	2CDS271103R0131		0.250	5
	16	599979	S 201 M-D 16 NA	2CDS271103R0161		0.250	5
	20 ①	599986	S 201 M-D 20 NA	2CDS271103R0201		0.250	5
	25	600019	S 201 M-D 25 NA	2CDS271103R0251		0.250	5
	32 ②	600088	S 201 M-D 32 NA	2CDS271103R0321		0.250	5
	40 ③	600132	S 201 M-D 40 NA	2CDS271103R0401		0.250	5
	50	600224	S 201 M-D 50 NA	2CDS271103R0501		0.290	5
	63	600330	S 201 M-D 63 NA	2CDS271103R0631		0.290	5

2

Number of poles	Rated current	Bbn 4016779	Order details		Price 1 piece	Weight 1 piece kg	Pack unit pc.
	In A	EAN	Type code	Order code			
3+NA	0.5	663311	S 203 M-D 0.5 NA	2CDS273103R0981		0.500	1
	1	663328	S 203 M-D 1 NA	2CDS273103R0011		0.500	1
	1.6	663335	S 203 M-D 1.6 NA	2CDS273103R0971		0.500	1
	2	663342	S 203 M-D 2 NA	2CDS273103R0021		0.500	1
	3	663359	S 203 M-D 3 NA	2CDS273103R0031		0.500	1
	4	663366	S 203 M-D 4 NA	2CDS273103R0041		0.500	1
	6	663373	S 203 M-D 6 NA	2CDS273103R0061		0.500	1
	8	663380	S 203 M-D 8 NA	2CDS273103R0081		0.500	1
	10	663397	S 203 M-D 10 NA	2CDS273103R0101		0.500	1
	13	663403	S 203 M-D 13 NA	2CDS273103R0131		0.500	1
	16	663410	S 203 M-D 16 NA	2CDS273103R0161		0.500	1
	20 ①	663427	S 203 M-D 20 NA	2CDS273103R0201		0.500	1
	25	663434	S 203 M-D 25 NA	2CDS273103R0251		0.500	1
	32 ②	663441	S 203 M-D 32 NA	2CDS273103R0321		0.500	1
	40 ③	663458	S 203 M-D 40 NA	2CDS273103R0401		0.500	1
	50	663465	S 203 M-D 50 NA	2CDS273103R0501		0.580	1
	63	663472	S 203 M-D 63 NA	2CDS273103R0631		0.580	1

① suitable for flow-type heaters 12 kW ③ suitable for flow-type heaters 21, 24 and 27 kW
 ② suitable for flow-type heaters 18 kW

MCBs

S 200 series M 10000 K characteristic

2



S 201 M



S 202 M

S 200 M-K (power) characteristic

Function: protection and control of the circuits like motors, transformer and auxiliary circuits, against overloads and short-circuits.

Advantages: no nuisance tripping in the case of functional peak currents up to 10xI_n, depending on the series; through its highly sensitive thermostatic bimetal trip, the K-type characteristic offers protection to damageable elements in the overcurrent range; it also provides the best protection to cables and lines.

Applications: commercial and industrial.

Standard: IEC/EN 60947-2

I_{cu}=15 kA for 0.5 A ≤ I_n ≤ 40 A

I_{cu}=10 kA for 50 A ≤ I_n ≤ 63 A

Number of poles	Rated current	Bbn 4016779	Order details		Price 1 piece	Weight 1 piece	Pack unit
	In A		EAN	Type code			
1	0.5	599436	S 201 M-K 0.5	2CDS271001R0157		0.125	10
	1	599474	S 201 M-K 1	2CDS271001R0217		0.125	10
	1.6	599504	S 201 M-K 1.6	2CDS271001R0257		0.125	10
	2	599528	S 201 M-K 2	2CDS271001R0277		0.125	10
	3	599542	S 201 M-K 3	2CDS271001R0317		0.125	10
	4	599573	S 201 M-K 4	2CDS271001R0337		0.125	10
	6	599597	S 201 M-K 6	2CDS271001R0377		0.125	10
	8	599627	S 201 M-K 8	2CDS271001R0407		0.125	10
	10	599641	S 201 M-K 10	2CDS271001R0427		0.125	10
	13	659390	S 201 M-K 13	2CDS271001R0447		0.125	10
	16	599665	S 201 M-K 16	2CDS271001R0467		0.125	10
	20	599689	S 201 M-K 20	2CDS271001R0487		0.125	10
	25	599719	S 201 M-K 25	2CDS271001R0517		0.125	10
	32	599733	S 201 M-K 32	2CDS271001R0537		0.125	10
	40	599757	S 201 M-K 40	2CDS271001R0557		0.125	10
	50	599771	S 201 M-K 50	2CDS271001R0577		0.125	10
63	599795	S 201 M-K 63	2CDS271001R0607		0.125	10	

Number of poles	Rated current	Bbn 4016779	Order details		Price 1 piece	Weight 1 piece	Pack unit
	In A		EAN	Type code			
2	0.5	600484	S 202 M-K 0.5	2CDS272001R0157		0.250	5
	1	600521	S 202 M-K 1	2CDS272001R0217		0.250	5
	1.6	600552	S 202 M-K 1.6	2CDS272001R0257		0.250	5
	2	600576	S 202 M-K 2	2CDS272001R0277		0.250	5
	3	600590	S 202 M-K 3	2CDS272001R0317		0.250	5
	4	600620	S 202 M-K 4	2CDS272001R0337		0.250	5
	6	600644	S 202 M-K 6	2CDS272001R0377		0.250	5
	8	600675	S 202 M-K 8	2CDS272001R0407		0.250	5
	10	600699	S 202 M-K 10	2CDS272001R0427		0.250	5
	13	659406	S 202 M-K 13	2CDS272001R0447		0.250	5
	16	600712	S 202 M-K 16	2CDS272001R0467		0.250	5
	20	600736	S 202 M-K 20	2CDS272001R0487		0.250	5
	25	600767	S 202 M-K 25	2CDS272001R0517		0.250	5
	32	600781	S 202 M-K 32	2CDS272001R0537		0.250	5
	40	600804	S 202 M-K 40	2CDS272001R0557		0.250	5
	50	600828	S 202 M-K 50	2CDS272001R0577		0.250	5
63	600842	S 202 M-K 63	2CDS272001R0607		0.250	5	

Where to find more:

Coordination Tables for S 200M MCBs: p.10/37 for back-up and p.10/56 for selectivity
Worldwide Marks and Approvals of MCBs p.11/92

Frequently asked question - FAQ:

Where can I get certificates, declarations and CAD drawings?
You can find all of them on www.abb.com

Maybe you are also interested in:

Auxiliary Elements for MCBs p.4/2
Accessories for MCBs p.4/16
Busbar Systems p.4/21



S 203 M



S 204 M

Number of poles	Rated current	Bbn 4016779	Order details		Price 1 piece	Weight 1 piece kg	Pack unit pc.
	In A	EAN	Type code	Order code			
3	0.5	601016	S 203 M-K 0.5	2CDS273001R0157		0.375	1
	1	601054	S 203 M-K 1	2CDS273001R0217		0.375	1
	1.6	601085	S 203 M-K 1.6	2CDS273001R0257		0.375	1
	2	601108	S 203 M-K 2	2CDS273001R0277		0.375	1
	3	601122	S 203 M-K 3	2CDS273001R0317		0.375	1
	4	601153	S 203 M-K 4	2CDS273001R0337		0.375	1
	6	601177	S 203 M-K 6	2CDS273001R0377		0.375	1
	8	601207	S 203 M-K 8	2CDS273001R0407		0.375	1
	10	601221	S 203 M-K 10	2CDS273001R0427		0.375	1
	13	659413	S 203 M-K 13	2CDS273001R0447		0.375	1
	16	601245	S 203 M-K 16	2CDS273001R0467		0.375	1
	20	601269	S 203 M-K 20	2CDS273001R0487		0.375	1
	25	601290	S 203 M-K 25	2CDS273001R0517		0.375	1
	32	601313	S 203 M-K 32	2CDS273001R0537		0.375	1
	40	601337	S 203 M-K 40	2CDS273001R0557		0.375	1
	50	601351	S 203 M-K 50	2CDS273001R0577		0.375	1
63	601375	S 203 M-K 63	2CDS273001R0607		0.375	1	

2

Number of poles	Rated current	Bbn 4016779	Order details		Price 1 piece	Weight 1 piece kg	Pack unit pc.
	In A	EAN	Type code	Order code			
4	0.5	601757	S 204 M-K 0.5	2CDS274001R0157		0.500	1
	1	601795	S 204 M-K 1	2CDS274001R0217		0.500	1
	1.6	601825	S 204 M-K 1.6	2CDS274001R0257		0.500	1
	2	601849	S 204 M-K 2	2CDS274001R0277		0.500	1
	3	601863	S 204 M-K 3	2CDS274001R0317		0.500	1
	4	601894	S 204 M-K 4	2CDS274001R0337		0.500	1
	6	601917	S 204 M-K 6	2CDS274001R0377		0.500	1
	8	601948	S 204 M-K 8	2CDS274001R0407		0.500	1
	10	601962	S 204 M-K 10	2CDS274001R0427		0.500	1
	13	659420	S 204 M-K 13	2CDS274001R0447		0.500	1
	16	601986	S 204 M-K 16	2CDS274001R0467		0.500	1
	20	602006	S 204 M-K 20	2CDS274001R0487		0.500	1
	25	602020	S 204 M-K 25	2CDS274001R0517		0.500	1
	32	602044	S 204 M-K 32	2CDS274001R0537		0.500	1
	40	602068	S 204 M-K 40	2CDS274001R0557		0.500	1
	50	602082	S 204 M-K 50	2CDS274001R0577		0.500	1
63	602105	S 204 M-K 63	2CDS274001R0607		0.500	1	

MCBs

S 200 series M 10000 K characteristic



S 201 M NA



S 203 M NA

With disconnecting neutral NA

Number of poles	Rated current	Bbn 4016779	Order details		Price 1 piece	Weight 1 piece kg	Pack unit pc.
	In A	EAN	Type code	Order code			
1+NA	0.5	599955	S 201 M-K 0.5 NA	2CDS271103R0157		0.250	5
	1	599993	S 201 M-K 1 NA	2CDS271103R0217		0.250	5
	1.6	600026	S 201 M-K 1.6 NA	2CDS271103R0257		0.250	5
	2	600040	S 201 M-K 2 NA	2CDS271103R0277		0.250	5
	3	600064	S 201 M-K 3 NA	2CDS271103R0317		0.250	5
	4	600095	S 201 M-K 4 NA	2CDS271103R0337		0.250	5
	6	600118	S 201 M-K 6 NA	2CDS271103R0377		0.250	5
	8	600149	S 201 M-K 8 NA	2CDS271103R0407		0.250	5
	10	600163	S 201 M-K10 NA	2CDS271103R0427		0.250	5
	13	659437	S 201 M-K13 NA	2CDS271103R0447		0.250	5
	16	600187	S 201 M-K16 NA	2CDS271103R0467		0.250	5
	20	600200	S 201 M-K20 NA	2CDS271103R0487		0.250	5
	25	600231	S 201 M-K25 NA	2CDS271103R0517		0.250	5
	32	600255	S 201 M-K32 NA	2CDS271103R0537		0.250	5
	40	600279	S 201 M-K40 NA	2CDS271103R0557		0.250	5
	50	600293	S 201 M-K50 NA	2CDS271103R0577		0.250	5
63	600316	S 201 M-K63 NA	2CDS271103R0607		0.250	5	

Number of poles	Rated current	Bbn 4016779	Order details		Price 1 piece	Weight 1 piece kg	Pack unit pc.
	In A	EAN	Type code	Order code			
3+NA	0.5	659444	S 203 M-K 0.5 NA	2CDS273103R0157		0.500	1
	1	650451	S 203 M-K 1 NA	2CDS273103R0217		0.500	1
	1.6	659468	S 203 M-K 1.6 NA	2CDS273103R0257		0.500	1
	2	659475	S 203 M-K 2 NA	2CDS273103R0277		0.500	1
	3	659482	S 203 M-K 3 NA	2CDS273103R0317		0.500	1
	4	659499	S 203 M-K 4 NA	2CDS273103R0337		0.500	1
	6	659505	S 203 M-K 6 NA	2CDS273103R0377		0.500	1
	8	659512	S 203 M-K 8 NA	2CDS273103R0407		0.500	1
	10	659529	S 203 M-K 10 NA	2CDS273103R0427		0.500	1
	13	659536	S 203 M-K 13 NA	2CDS273103R0447		0.500	1
	16	659543	S 203 M-K 16 NA	2CDS273103R0467		0.500	1
	20	659550	S 203 M-K 20 NA	2CDS273103R0487		0.500	1
	25	659567	S 203 M-K 25 NA	2CDS273103R0517		0.500	1
	32	659574	S 203 M-K 32 NA	2CDS273103R0537		0.500	1
	40	659581	S 203 M-K 40 NA	2CDS273103R0557		0.500	1
	50	659604	S 203 M-K 50 NA	2CDS273103R0577		0.500	1
63	659611	S 203 M-K 63 NA	2CDS273103R0607		0.500	1	

Where to find more:

Coordination Tables for S 200M
 MCBs: p.10/37 for back-up and
 p.10/56 for selectivity
 Worldwide Marks and Approvals of
 MCBs p.11/92

Frequently asked question - FAQ:

Where can I get certificates, declara-
 tions and CAD drawings?
 You can find all of them on
www.abb.com

Maybe you are also interested in:

Auxiliary Elements for MCBs p.4/2
 Accessories for MCBs p.4/16
 Busbar Systems p.4/21

MCBs

S 200 series M 10000 Z characteristic



S 201 M



S 202 M

S 200 M-Z characteristic

Function: protection and control of the electronic circuits against lower and long duration overloads and short-circuits.

Applications: commercial and industrial.

Standard: IEC/EN 60947-2, VDE 0660 Part 101

Icu=10 kA (acc. to VDE 0660 Part 101)

2

Number of poles	Rated current	Bbn 4016779	Order details		Price 1 piece	Weight 1 piece	Pack unit
	In A	EAN	Type code	Order code			
1	0.5	599443	S 201 M-Z 0.5	2CDS271001R0158		0.125	10
	1	599481	S 201 M-Z 1	2CDS271001R0218		0.125	10
	1.6	599511	S 201 M-Z 1.6	2CDS271001R0258		0.125	10
	2	599535	S 201 M-Z 2	2CDS271001R0278		0.125	10
	3	599559	S 201 M-Z 3	2CDS271001R0318		0.125	10
	4	599580	S 201 M-Z 4	2CDS271001R0338		0.125	10
	6	599603	S 201 M-Z 6	2CDS271001R0378		0.125	10
	8	599634	S 201 M-Z 8	2CDS271001R0408		0.125	10
	10	599658	S 201 M-Z 10	2CDS271001R0428		0.125	10
	16	599672	S 201 M-Z 16	2CDS271001R0468		0.125	10
	20	599696	S 201 M-Z 20	2CDS271001R0488		0.125	10
	25	599726	S 201 M-Z 25	2CDS271001R0518		0.125	10
	32	599740	S 201 M-Z 32	2CDS271001R0538		0.125	10
	40	599764	S 201 M-Z 40	2CDS271001R0558		0.125	10
	50	599788	S 201 M-Z 50	2CDS271001R0578		0.125	10
63	599801	S 201 M-Z 63	2CDS271001R0608		0.125	10	

Number of poles	Rated current	Bbn 4016779	Order details		Price 1 piece	Weight 1 piece	Pack unit
	In A	EAN	Type code	Order code			
2	0.5	600491	S 202 M-Z 0.5	2CDS272001R0158		0.250	5
	1	600538	S 202 M-Z 1	2CDS272001R0218		0.250	5
	1.6	600569	S 202 M-Z 1.6	2CDS272001R0258		0.250	5
	2	600583	S 202 M-Z 2	2CDS272001R0278		0.250	5
	3	600606	S 202 M-Z 3	2CDS272001R0318		0.250	5
	4	600637	S 202 M-Z 4	2CDS272001R0338		0.250	5
	6	600651	S 202 M-Z 6	2CDS272001R0378		0.250	5
	8	600682	S 202 M-Z 8	2CDS272001R0408		0.250	5
	10	600705	S 202 M-Z 10	2CDS272001R0428		0.250	5
	16	600729	S 202 M-Z 16	2CDS272001R0468		0.250	5
	20	600743	S 202 M-Z 20	2CDS272001R0488		0.250	5
	25	600774	S 202 M-Z 25	2CDS272001R0518		0.250	5
	32	600798	S 202 M-Z 32	2CDS272001R0538		0.250	5
	40	600811	S 202 M-Z 40	2CDS272001R0558		0.250	5
	50	600835	S 202 M-Z 50	2CDS272001R0578		0.250	5
63	600859	S 202 M-Z 63	2CDS272001R0608		0.250	5	

MCBs

S 200 series M 10000 Z characteristic



S 203 M



S 204 M

Number of poles	Rated current	Bbn 4016779	Order details		Price 1 piece	Weight 1 piece	Pack unit
	In A		EAN	Type code			
3	0.5	601023	S 203 M-Z 0.5	2CDS273001R0158		0.375	1
	1	601061	S 203 M-Z 1	2CDS273001R0218		0.375	1
	1.6	601092	S 203 M-Z 1.6	2CDS273001R0258		0.375	1
	2	601115	S 203 M-Z 2	2CDS273001R0278		0.375	1
	3	601139	S 203 M-Z 3	2CDS273001R0318		0.375	1
	4	601160	S 203 M-Z 4	2CDS273001R0338		0.375	1
	6	601184	S 203 M-Z 6	2CDS273001R0378		0.375	1
	8	601214	S 203 M-Z 8	2CDS273001R0408		0.375	1
	10	601238	S 203 M-Z 10	2CDS273001R0428		0.375	1
	16	601252	S 203 M-Z 16	2CDS273001R0468		0.375	1
	20	601276	S 203 M-Z 20	2CDS273001R0488		0.375	1
	25	601306	S 203 M-Z 25	2CDS273001R0518		0.375	1
	32	601320	S 203 M-Z 32	2CDS273001R0538		0.375	1
	40	601344	S 203 M-Z 40	2CDS273001R0558		0.375	1
	50	601368	S 203 M-Z 50	2CDS273001R0578		0.375	1
	63	601382	S 203 M-Z 63	2CDS273001R0608		0.375	1

Number of poles	Rated current	Bbn 4016779	Order details		Price 1 piece	Weight 1 piece	Pack unit
	In A		EAN	Type code			
4	0.5	601764	S 204 M-Z 0.5	2CDS274001R0158		0.500	1
	1	601810	S 204 M-Z 1	2CDS274001R0218		0.500	1
	1.6	601832	S 204 M-Z 1.6	2CDS274001R0258		0.500	1
	2	601856	S 204 M-Z 2	2CDS274001R0278		0.500	1
	3	601870	S 204 M-Z 3	2CDS274001R0318		0.500	1
	4	601900	S 204 M-Z 4	2CDS274001R0338		0.500	1
	6	601924	S 204 M-Z 6	2CDS274001R0378		0.500	1
	8	601955	S 204 M-Z 8	2CDS274001R0408		0.500	1
	10	601979	S 204 M-Z 10	2CDS274001R0428		0.500	1
	16	601993	S 204 M-Z 16	2CDS274001R0468		0.500	1
	20	659628	S 204 M-Z 20	2CDS274001R0488		0.500	1
	25	602037	S 204 M-Z 25	2CDS274001R0518		0.500	1
	32	602051	S 204 M-Z 32	2CDS274001R0538		0.500	1
	40	602075	S 204 M-Z 40	2CDS274001R0558		0.500	1
	50	602099	S 204 M-Z 50	2CDS274001R0578		0.500	1
	63	602112	S 204 M-Z 63	2CDS274001R0608		0.500	1

① U_{Bmax} 125 V ... with 2 poles connected in series

Where to find more:

Coordination Tables for S 200M
 MCBs: p.10/37 for back-up and
 p.10/56 for selectivity
 Worldwide Marks and Approvals of
 MCBs p.11/92

Frequently asked question - FAQ:

Where can I get certificates, declarations and CAD drawings?
 You can find all of them on
www.abb.com

Maybe you are also interested in:

Auxiliary Elements for MCBs p.4/2
 Accessories for MCBs p.4/16
 Busbar Systems p.4/21



S 201 M NA



S 203 M NA

With disconnecting neutral NA

Number of poles	Rated current	Bbn 4016779	Order details		Price 1 piece	Weight 1 piece kg	Pack unit pc.
	In A	EAN	Type code	Order code			
1+NA	0.5	599962	S 201 M-Z 0.5 NA	2CDS271103R0158		0.260	5
	1	600002	S 201 M-Z 1 NA	2CDS271103R0218		0.260	5
	1.6	600033	S 201 M-Z 1.6 NA	2CDS271103R0258		0.260	5
	2	600057	S 201 M-Z 2 NA	2CDS271103R0278		0.260	5
	3	600071	S 201 M-Z 3 NA	2CDS271103R0318		0.260	5
	4	600101	S 201 M-Z 4 NA	2CDS271103R0338		0.260	5
	6	600125	S 201 M-Z 6 NA	2CDS271103R0378		0.260	5
	8	600156	S 201 M-Z 8 NA	2CDS271103R0408		0.260	5
	10	600170	S 201 M-Z 10 NA	2CDS271103R0428		0.260	5
	16	600194	S 201 M-Z 16 NA	2CDS271103R0468		0.260	5
	20	600217	S 201 M-Z 20 NA	2CDS271103R0488		0.260	5
	25	600248	S 201 M-Z 25 NA	2CDS271103R0518		0.260	5
	32	600262	S 201 M-Z 32 NA	2CDS271103R0538		0.260	5
	40	600286	S 201 M-Z 40 NA	2CDS271103R0558		0.260	5
	50	600309	S 201 M-Z 50 NA	2CDS271103R0578		0.320	5
	63	600323	S 201 M-Z 63 NA	2CDS271103R0608		0.320	5

2

Number of poles	Rated current	Bbn 4016779	Order details		Price 1 piece	Weight 1 piece kg	Pack unit pc.
	In A	EAN	Type code	Order code			
3+NA	0.5	601474	S 203 M-Z 0.5 NA	2CDS273103R0158		0.520	1
	1	601481	S 203 M-Z 1 NA	2CDS273103R0218		0.520	1
	1.6	601498	S 203 M-Z 1.6 NA	2CDS273103R0258		0.520	1
	2	601504	S 203 M-Z 2 NA	2CDS273103R0278		0.520	1
	3	601511	S 203 M-Z 3 NA	2CDS273103R0318		0.520	1
	4	601528	S 203 M-Z 4 NA	2CDS273103R0338		0.520	1
	6	601535	S 203 M-Z 6 NA	2CDS273103R0378		0.520	1
	8	601542	S 203 M-Z 8 NA	2CDS273103R0408		0.520	1
	10	601559	S 203 M-Z 10 NA	2CDS273103R0428		0.520	1
	16	601566	S 203 M-Z 16 NA	2CDS273103R0468		0.520	1
	20	601573	S 203 M-Z 20 NA	2CDS273103R0488		0.520	1
	25	601580	S 203 M-Z 25 NA	2CDS273103R0518		0.520	1
	32	601597	S 203 M-Z 32 NA	2CDS273103R0538		0.520	1
	40	601603	S 203 M-Z 40 NA	2CDS273103R0558		0.520	1
	50	601610	S 203 M-Z 50 NA	2CDS273103R0578		0.640	1
	63	601627	S 203 M-Z 63 NA	2CDS273103R0608		0.640	1

MCBs

S 200 series M UC 10000 B characteristic

Universal current range



S 201 M UC



S 202 M UC

S 200 M UC B characteristic

Function: protection and control of the circuits against overloads and short-circuits; protection for people and big length cables in TN and IT systems; version dedicated to application in direct current circuits for voltages up to 220 V DC 1 pole and 440 V DC 2, 3 and 4 poles.

Applications: Industrial.

Standard: IEC/EN 60898-2, IEC/EN 60947-2, UL1077, CSA 22.2 No. 335

(for DC applications, please note polarity of device)

Icu=10 kA

Number of poles	Rated current	Bbn 401361	Order details		Price 1 piece	Weight 1 piece	Pack unit
	In A		EAN	Type code			
1	6	4430596	S201M-B6UC	2CDS271061R0065		10	0.125
	10	4430602	S201M-B10UC	2CDS271061R0105		10	0.125
	13	4430619	S201M-B13UC	2CDS271061R0135		10	0.125
	16	4430626	S201M-B16UC	2CDS271061R0165		10	0.125
	20	4430633	S201M-B20UC	2CDS271061R0205		10	0.125
	25	4430640	S201M-B25UC	2CDS271061R0255		10	0.125
	32	4430657	S201M-B32UC	2CDS271061R0325		10	0.125
	40	4430664	S201M-B40UC	2CDS271061R0405		10	0.125
	50	4430671	S201M-B50UC	2CDS271061R0505		10	0.125
	63	4430688	S201M-B63UC	2CDS271061R0635		10	0.125

Number of poles	Rated current	Bbn 401361	Order details		Price 1 piece	Weight 1 piece	Pack unit
	In A		EAN	Type code			
2	6	4432811	S202M-B6UC	2CDS272061R0065		5	0.250
	10	4432828	S202M-B10UC	2CDS272061R0105		5	0.250
	13	4432835	S202M-B13UC	2CDS272061R0135		5	0.250
	16	4432842	S202M-B16UC	2CDS272061R0165		5	0.250
	20	4432859	S202M-B20UC	2CDS272061R0205		5	0.250
	25	4432866	S202M-B25UC	2CDS272061R0255		5	0.250
	32	4432873	S202M-B32UC	2CDS272061R0325		5	0.250
	40	4432880	S202M-B40UC	2CDS272061R0405		5	0.250
	50	4432897	S202M-B50UC	2CDS272061R0505		5	0.250
	63	4432903	S202M-B63UC	2CDS272061R0635		5	0.250

Where to find more:

Coordination Tables for S 200M MCBs: p.10/37 for back-up and p.10/56 for selectivity
Worldwide Marks and Approvals of MCBs p.11/92

Frequently asked question - FAQ:

Where can I get certificates, declarations and CAD drawings?
You can find all of them on www.abb.com

Maybe you are also interested in:

Auxiliary Elements for MCBs p.4/2
Accessories for MCBs p.4/16
Busbar Systems p.4/21



S 203 M UC

2CDS273061R050011



S 204 M UC

2CDS274061R050011

Number of poles	Rated current	Bbn 401361	Order details		Price 1 piece	Weight 1 piece	Pack unit
	In A	EAN	Type code	Order code			
3	6	4435034	S203M-B6UC	2CDS273061R0065		1	0.375
	10	4435041	S203M-B10UC	2CDS273061R0105		1	0.375
	13	4435058	S203M-B13UC	2CDS273061R0135		1	0.375
	16	4435065	S203M-B16UC	2CDS273061R0165		1	0.375
	20	4435072	S203M-B20UC	2CDS273061R0205		1	0.375
	25	4435089	S203M-B25UC	2CDS273061R0255		1	0.375
	32	4435096	S203M-B32UC	2CDS273061R0325		1	0.375
	40	4435102	S203M-B40UC	2CDS273061R0405		1	0.375
	50	4435119	S203M-B50UC	2CDS273061R0505		1	0.375
	63	4435126	S203M-B63UC	2CDS273061R0635		1	0.375

2

Number of poles	Rated current	Bbn 401361	Order details		Price 1 piece	Weight 1 piece	Pack unit
	In A	EAN	Type code	Order code			
4	6	4437250	S204M-B6UC	2CDS274061R0065		1	0.500
	10	4437267	S204M-B10UC	2CDS274061R0105		1	0.500
	13	4437274	S204M-B13UC	2CDS274061R0135		1	0.500
	16	4437281	S204M-B16UC	2CDS274061R0165		1	0.500
	20	4437298	S204M-B20UC	2CDS274061R0205		1	0.500
	25	4437304	S204M-B25UC	2CDS274061R0255		1	0.500
	32	4437311	S204M-B32UC	2CDS274061R0325		1	0.500
	40	4437328	S204M-B40UC	2CDS274061R0405		1	0.500
	50	4437335	S204M-B50UC	2CDS274061R0505		1	0.500
	63	4437342	S204M-B63UC	2CDS274061R0635		1	0.500

MCBs

S 200 series M UC 10000 C characteristic

Universal current range



S 201 M UC



S 202 M UC

S 200 M UC C characteristic

Function: protection and control of the circuits against overloads and short-circuits; protection for people and big length cables in TN and IT systems; version dedicated to application in direct current circuits for voltages up to 220 V DC 1 pole and 440 V DC 2, 3 and 4 poles.

Applications: Industrial.

Standard: IEC/EN 60898-2, IEC/EN 60947-2, UL1077, CSA 22.2 No. 335

(for DC applications, please note polarity of device)

Icu=10 kA

Number of poles	Rated current	Bbn 401361	Order details		Price 1 piece	Weight 1 piece	Pack unit
	In A		EAN	Type code			
1	0.5	4430695	S201M-C0.5UC	2CDS271061R0984		10	0.125
	1	4430701	S201M-C1UC	2CDS271061R0014		10	0.125
	1.6	4430718	S201M-C1.6UC	2CDS271061R0974		10	0.125
	2	4430725	S201M-C2UC	2CDS271061R0024		10	0.125
	3	4430732	S201M-C3UC	2CDS271061R0034		10	0.125
	4	4430749	S201M-C4UC	2CDS271061R0044		10	0.125
	6	4430756	S201M-C6UC	2CDS271061R0064		10	0.125
	8	4430763	S201M-C8UC	2CDS271061R0084		10	0.125
	10	4430770	S201M-C10UC	2CDS271061R0104		10	0.125
	13	4430787	S201M-C13UC	2CDS271061R0134		10	0.125
	16	4430794	S201M-C16UC	2CDS271061R0164		10	0.125
	20	4430800	S201M-C20UC	2CDS271061R0204		10	0.125
	25	4430817	S201M-C25UC	2CDS271061R0254		10	0.125
	32	4430824	S201M-C32UC	2CDS271061R0324		10	0.125
	40	4430831	S201M-C40UC	2CDS271061R0404		10	0.125
	50	4430848	S201M-C50UC	2CDS271061R0504		10	0.125
63	4430855	S201M-C63UC	2CDS271061R0634		10	0.125	

Number of poles	Rated current	Bbn 401361	Order details		Price 1 piece	Weight 1 piece	Pack unit
	In A		EAN	Type code			
2	0.5	4432910	S202M-C0.5UC	2CDS272061R0984		5	0.250
	1	4432927	S202M-C1UC	2CDS272061R0014		5	0.250
	1.6	4432934	S202M-C1.6UC	2CDS272061R0974		5	0.250
	2	4432941	S202M-C2UC	2CDS272061R0024		5	0.250
	3	4432958	S202M-C3UC	2CDS272061R0034		5	0.250
	4	4432965	S202M-C4UC	2CDS272061R0044		5	0.250
	6	4432972	S202M-C6UC	2CDS272061R0064		5	0.250
	8	4432989	S202M-C8UC	2CDS272061R0084		5	0.250
	10	4432996	S202M-C10UC	2CDS272061R0104		5	0.250
	13	4433009	S202M-C13UC	2CDS272061R0134		5	0.250
	16	4433016	S202M-C16UC	2CDS272061R0164		5	0.250
	20	4433023	S202M-C20UC	2CDS272061R0204		5	0.250
	25	4433030	S202M-C25UC	2CDS272061R0254		5	0.250
	32	4433047	S202M-C32UC	2CDS272061R0324		5	0.250
	40	4433054	S202M-C40UC	2CDS272061R0404		5	0.250
	50	4433061	S202M-C50UC	2CDS272061R0504		5	0.250
63	4433078	S202M-C63UC	2CDS272061R0634		5	0.250	

Where to find more:

Coordination Tables for S 200M MCBs: p.10/37 for back-up and p.10/56 for selectivity
Worldwide Marks and Approvals of MCBs p.11/92

Frequently asked question - FAQ:

Where can I get certificates, declarations and CAD drawings?
You can find all of them on www.abb.com

Maybe you are also interested in:

Auxiliary Elements for MCBs p.4/2
Accessories for MCBs p.4/16
Busbar Systems p.4/21



S 203 M UC

2CDS273061R0984



S 204 M UC

2CDS274061R0984

Number of poles	Rated current	Bbn 401361	Order details		Price 1 piece	Weight 1 piece	Pack unit
	In A	EAN	Type code	Order code			
3	0.5	4435133	S203M-C0.5UC	2CDS273061R0984		1	0.375
	1	4435140	S203M-C1UC	2CDS273061R0014		1	0.375
	1.6	4435157	S203M-C1.6UC	2CDS273061R0974		1	0.375
	2	4435164	S203M-C2UC	2CDS273061R0024		1	0.375
	3	4435171	S203M-C3UC	2CDS273061R0034		1	0.375
	4	4435188	S203M-C4UC	2CDS273061R0044		1	0.375
	6	4435195	S203M-C6UC	2CDS273061R0064		1	0.375
	8	4435201	S203M-C8UC	2CDS273061R0084		1	0.375
	10	4435218	S203M-C10UC	2CDS273061R0104		1	0.375
	13	4435225	S203M-C13UC	2CDS273061R0134		1	0.375
	16	4435232	S203M-C16UC	2CDS273061R0164		1	0.375
	20	4435249	S203M-C20UC	2CDS273061R0204		1	0.375
	25	4435256	S203M-C25UC	2CDS273061R0254		1	0.375
	32	4435263	S203M-C32UC	2CDS273061R0324		1	0.375
	40	4435270	S203M-C40UC	2CDS273061R0404		1	0.375
	50	4435287	S203M-C50UC	2CDS273061R0504		1	0.375
63	4435294	S203M-C63UC	2CDS273061R0634		1	0.375	

2

Number of poles	Rated current	Bbn 401361	Order details		Price 1 piece	Weight 1 piece	Pack unit
	In A	EAN	Type code	Order code			
4	0.5	4437359	S204M-C0.5UC	2CDS274061R0984		1	0.500
	1	4437366	S204M-C1UC	2CDS274061R0014		1	0.500
	1.6	4437373	S204M-C1.6UC	2CDS274061R0974		1	0.500
	2	4437380	S204M-C2UC	2CDS274061R0024		1	0.500
	3	4437397	S204M-C3UC	2CDS274061R0034		1	0.500
	4	4437403	S204M-C4UC	2CDS274061R0044		1	0.500
	6	4437410	S204M-C6UC	2CDS274061R0064		1	0.500
	8	4437427	S204M-C8UC	2CDS274061R0084		1	0.500
	10	4437434	S204M-C10UC	2CDS274061R0104		1	0.500
	13	4437441	S204M-C13UC	2CDS274061R0134		1	0.500
	16	4437458	S204M-C16UC	2CDS274061R0164		1	0.500
	20	4437465	S204M-C20UC	2CDS274061R0204		1	0.500
	25	4437472	S204M-C25UC	2CDS274061R0254		1	0.500
	32	4437489	S204M-C32UC	2CDS274061R0324		1	0.500
	40	4437496	S204M-C40UC	2CDS274061R0404		1	0.500
	50	4437502	S204M-C50UC	2CDS274061R0504		1	0.500
63	4437519	S204M-C63UC	2CDS274061R0634		1	0.500	

MCBs

S 200 series M UC – Universal current range K characteristic



S 201 M UC

S 200 M UC K characteristic

Function: protection and control of the circuits against overloads and short-circuits; protection for people and big length cables in TN and IT systems; version dedicated to application in direct current circuits for voltages up to 220 V DC 1 pole and 440 V DC 2, 3 and 4 poles.

Applications: Industrial.

Standard: IEC/EN 60898-2, IEC/EN 60947-2, UL1077, CSA 22.2 No. 335

(for DC applications, please note polarity of device)

Icu=10 kA

Number of poles	Rated current In A	Bbn 401361 EAN	Order details		Price 1 piece	Weight 1 piece kg	Pack unit pc.
			Type code	Order code			
1	0.2	4430862	S201M-K0.2UC	2CDS271061R0087		10	0.125
	0.3	4430879	S201M-K0.3UC	2CDS271061R0117		10	0.125
	0.5	4430886	S201M-K0.5UC	2CDS271061R0157		10	0.125
	0.75	4430893	S201M-K0.75UC	2CDS271061R0187		10	0.125
	1	4430909	S201M-K1UC	2CDS271061R0217		10	0.125
	1.6	4430916	S201M-K1.6UC	2CDS271061R0257		10	0.125
	2	4430923	S201M-K2UC	2CDS271061R0277		10	0.125
	3	4430930	S201M-K3UC	2CDS271061R0317		10	0.125
	4	4430947	S201M-K4UC	2CDS271061R0337		10	0.125
	5	4430954	S201M-K5UC	2CDS271061R0357		10	0.125
	6	4430961	S201M-K6UC	2CDS271061R0377		10	0.125
	8	4430978	S201M-K8UC	2CDS271061R0407		10	0.125
	10	4430985	S201M-K10UC	2CDS271061R0427		10	0.125
	13	4430992	S201M-K13UC	2CDS271061R0447		10	0.125
	15	4431005	S201M-K15UC	2CDS271061R0457		10	0.125
	16	4431012	S201M-K16UC	2CDS271061R0467		10	0.125
	20	4431029	S201M-K20UC	2CDS271061R0487		10	0.125
	25	4431036	S201M-K25UC	2CDS271061R0517		10	0.125
	30	4431043	S201M-K30UC	2CDS271061R0527		10	0.125
	32	4431050	S201M-K32UC	2CDS271061R0537		10	0.125
	35	4431067	S201M-K35UC	2CDS271061R0547		10	0.125
40	4431074	S201M-K40UC	2CDS271061R0557		10	0.125	
50	4431081	S201M-K50UC	2CDS271061R0577		10	0.125	
60	4431098	S201M-K60UC	2CDS271061R0587		10	0.125	
63	4431104	S201M-K63UC	2CDS271061R0607		10	0.125	

Where to find more:

Coordination Tables for S 200M
MCBs: p.10/37 for back-up and
p.10/56 for selectivity
Worldwide Marks and Approvals of
MCBs p.11/92

Frequently asked question - FAQ:

Where can I get certificates, declara-
tions and CAD drawings?
You can find all of them on
www.abb.com

Maybe you are also interested in:

Auxiliary Elements for MCBs p.4/2
Accessories for MCBs p.4/16
Busbar Systems p.4/21



S 202 M UC

2CDS272061R0087

Number of poles	Rated current In A	Bbn 401361 EAN	Order details		Price 1 piece	Weight 1 piece kg	Pack unit pc.
			Type code	Order code			
2	0.2	4433085	S202M-K0.2UC	2CDS272061R0087		5	0.250
	0.3	4433092	S202M-K0.3UC	2CDS272061R0117		5	0.250
	0.5	4433108	S202M-K0.5UC	2CDS272061R0157		5	0.250
	0.75	4433115	S202M-K0.75UC	2CDS272061R0187		5	0.250
	1	4433122	S202M-K1UC	2CDS272061R0217		5	0.250
	1.6	4433139	S202M-K1.6UC	2CDS272061R0257		5	0.250
	2	4433146	S202M-K2UC	2CDS272061R0277		5	0.250
	3	4433153	S202M-K3UC	2CDS272061R0317		5	0.250
	4	4433160	S202M-K4UC	2CDS272061R0337		5	0.250
	5	4433177	S202M-K5UC	2CDS272061R0357		5	0.250
	6	4433184	S202M-K6UC	2CDS272061R0377		5	0.250
	8	4433191	S202M-K8UC	2CDS272061R0407		5	0.250
	10	4433207	S202M-K10UC	2CDS272061R0427		5	0.250
	13	4433214	S202M-K13UC	2CDS272061R0447		5	0.250
	15	4433221	S202M-K15UC	2CDS272061R0457		5	0.250
	16	4433238	S202M-K16UC	2CDS272061R0467		5	0.250
	20	4433245	S202M-K20UC	2CDS272061R0487		5	0.250
	25	4433252	S202M-K25UC	2CDS272061R0517		5	0.250
	30	4433269	S202M-K30UC	2CDS272061R0527		5	0.250
	32	4433276	S202M-K32UC	2CDS272061R0537		5	0.250
	35	4433283	S202M-K35UC	2CDS272061R0547		5	0.250
	40	4433290	S202M-K40UC	2CDS272061R0557		5	0.250
	50	4433306	S202M-K50UC	2CDS272061R0577		5	0.250
	60	4433313	S202M-K60UC	2CDS272061R0587		5	0.250
	63	4433320	S202M-K63UC	2CDS272061R0607		5	0.250

2



S 203 M UC

2CDS273061R0087

Number of poles	Rated current In A	Bbn 401361 EAN	Order details		Price 1 piece	Weight 1 piece kg	Pack unit pc.
			Type code	Order code			
3	0.2	4435300	S203M-K0.2UC	2CDS273061R0087		1	0.375
	0.3	4435317	S203M-K0.3UC	2CDS273061R0117		1	0.375
	0.5	4435324	S203M-K0.5UC	2CDS273061R0157		1	0.375
	0.75	4435331	S203M-K0.75UC	2CDS273061R0187		1	0.375
	1	4435348	S203M-K1UC	2CDS273061R0217		1	0.375
	1.6	4435355	S203M-K1.6UC	2CDS273061R0257		1	0.375
	2	4435362	S203M-K2UC	2CDS273061R0277		1	0.375
	3	4435379	S203M-K3UC	2CDS273061R0317		1	0.375
	4	4435386	S203M-K4UC	2CDS273061R0337		1	0.375
	5	4435393	S203M-K5UC	2CDS273061R0357		1	0.375
	6	4435409	S203M-K6UC	2CDS273061R0377		1	0.375
	8	4435416	S203M-K8UC	2CDS273061R0407		1	0.375
	10	4435423	S203M-K10UC	2CDS273061R0427		1	0.375
	13	4435430	S203M-K13UC	2CDS273061R0447		1	0.375
	15	4435447	S203M-K15UC	2CDS273061R0457		1	0.375
	16	4435454	S203M-K16UC	2CDS273061R0467		1	0.375
	20	4435461	S203M-K20UC	2CDS273061R0487		1	0.375
	25	4435478	S203M-K25UC	2CDS273061R0517		1	0.375
	30	4435485	S203M-K30UC	2CDS273061R0527		1	0.375
	32	4435492	S203M-K32UC	2CDS273061R0537		1	0.375
	35	4435508	S203M-K35UC	2CDS273061R0547		1	0.375
	40	4435515	S203M-K40UC	2CDS273061R0557		1	0.375
	50	4435522	S203M-K50UC	2CDS273061R0577		1	0.375
	60	4435539	S203M-K60UC	2CDS273061R0587		1	0.375
	63	4435546	S203M-K63UC	2CDS273061R0607		1	0.375

MCBs

S 200 series M UC – Universal current range K characteristic



S 204 M UC

2CDS210385011

Number of poles	Rated current In A	Bbn 401361 EAN	Order details		Price 1 piece	Weight 1 piece kg	Pack unit pc.
			Type code	Order code			
4	0.2	4437526	S204M-K0.2UC	2CDS274061R0087		1	0.500
	0.3	4437533	S204M-K0.3UC	2CDS274061R0117		1	0.500
	0.5	4437540	S204M-K0.5UC	2CDS274061R0157		1	0.500
	0.75	4437557	S204M-K0.75UC	2CDS274061R0187		1	0.500
	1	4437564	S204M-K1UC	2CDS274061R0217		1	0.500
	1.6	4437571	S204M-K1.6UC	2CDS274061R0257		1	0.500
	2	4437588	S204M-K2UC	2CDS274061R0277		1	0.500
	3	4437595	S204M-K3UC	2CDS274061R0317		1	0.500
	4	4437601	S204M-K4UC	2CDS274061R0337		1	0.500
	5	4437618	S204M-K5UC	2CDS274061R0357		1	0.500
	6	4437625	S204M-K6UC	2CDS274061R0377		1	0.500
	8	4437632	S204M-K8UC	2CDS274061R0407		1	0.500
	10	4437649	S204M-K10UC	2CDS274061R0427		1	0.500
	13	4437656	S204M-K13UC	2CDS274061R0447		1	0.500
	15	4437663	S204M-K15UC	2CDS274061R0457		1	0.500
	16	4437670	S204M-K16UC	2CDS274061R0467		1	0.500
	20	4437687	S204M-K20UC	2CDS274061R0487		1	0.500
	25	4437694	S204M-K25UC	2CDS274061R0517		1	0.500
	30	4437700	S204M-K30UC	2CDS274061R0527		1	0.500
	32	4437717	S204M-K32UC	2CDS274061R0537		1	0.500
35	4437724	S204M-K35UC	2CDS274061R0547		1	0.500	
40	4437731	S204M-K40UC	2CDS274061R0557		1	0.500	
50	4437748	S204M-K50UC	2CDS274061R0577		1	0.500	
60	4437755	S204M-K60UC	2CDS274061R0587		1	0.500	
63	4437762	S204M-K63UC	2CDS274061R0607		1	0.500	

Where to find more:

Coordination Tables for S 200M
MCBs: p.10/37 for back-up and
p.10/56 for selectivity
Worldwide Marks and Approvals of
MCBs p.11/92

Frequently asked question - FAQ:

Where can I get certificates, declara-
tions and CAD drawings?
You can find all of them on
www.abb.com

Maybe you are also interested in:

Auxiliary Elements for MCBs p.4/2
Accessories for MCBs p.4/16
Busbar Systems p.4/21

MCBs

S 200 series M UC – Universal current range Z characteristic



S 201 M UC



S 202 M UC

S 200 M UC Z characteristic

Function: protection and control of the circuits against overloads and short-circuits; protection for people and big length cables in TN and IT systems; version dedicated to application in direct current circuits for voltages up to 220 V DC 1 pole and 440 V DC 2, 3 and 4 poles.

Applications: Industrial.

Standard: IEC/EN 60898-2, IEC/EN 60947-2, UL1077, CSA 22.2 No. 335

(for DC applications, please note polarity of device)

Icu=10 kA

2

Number of poles	Rated current	Bbn 401361	Order details		Price 1 piece	Weight 1 piece	Pack unit
	In A	EAN	Type code	Order code		kg	
1	0.5	4431111	S201M-Z0.5UC	2CDS271061R0158		10	0.125
	1	4431128	S201M-Z1UC	2CDS271061R0218		10	0.125
	1.6	4431135	S201M-Z1.6UC	2CDS271061R0258		10	0.125
	2	4431142	S201M-Z2UC	2CDS271061R0278		10	0.125
	3	4431159	S201M-Z3UC	2CDS271061R0318		10	0.125
	4	4431166	S201M-Z4UC	2CDS271061R0338		10	0.125
	5	4431173	S201M-Z5UC	2CDS271061R0358		10	0.125
	6	4431180	S201M-Z6UC	2CDS271061R0378		10	0.125
	8	4431197	S201M-Z8UC	2CDS271061R0408		10	0.125
	10	4431203	S201M-Z10UC	2CDS271061R0428		10	0.125
	15	4431227	S201M-Z15UC	2CDS271061R0458		10	0.125
	16	4431234	S201M-Z16UC	2CDS271061R0468		10	0.125
	20	4431241	S201M-Z20UC	2CDS271061R0488		10	0.125
	25	4431258	S201M-Z25UC	2CDS271061R0518		10	0.125
	30	4431265	S201M-Z30UC	2CDS271061R0528		10	0.125
	32	4431272	S201M-Z32UC	2CDS271061R0538		10	0.125
	35	4431289	S201M-Z35UC	2CDS271061R0548		10	0.125
	40	4431296	S201M-Z40UC	2CDS271061R0558		10	0.125
	50	4431302	S201M-Z50UC	2CDS271061R0578		10	0.125
60	4431319	S201M-Z60UC	2CDS271061R0588		10	0.125	
63	4431326	S201M-Z63UC	2CDS271061R0608		10	0.125	
2	0.5	4433337	S202M-Z0.5UC	2CDS272061R0158		5	0.250
	1	4433344	S202M-Z1UC	2CDS272061R0218		5	0.250
	1.6	4433351	S202M-Z1.6UC	2CDS272061R0258		5	0.250
	2	4433368	S202M-Z2UC	2CDS272061R0278		5	0.250
	3	4433375	S202M-Z3UC	2CDS272061R0318		5	0.250
	4	4433382	S202M-Z4UC	2CDS272061R0338		5	0.250
	5	4433399	S202M-Z5UC	2CDS272061R0358		5	0.250
	6	4433405	S202M-Z6UC	2CDS272061R0378		5	0.250
	8	4433412	S202M-Z8UC	2CDS272061R0408		5	0.250
	10	4433429	S202M-Z10UC	2CDS272061R0428		5	0.250
	15	4433443	S202M-Z15UC	2CDS272061R0458		5	0.250
	16	4433450	S202M-Z16UC	2CDS272061R0468		5	0.250
	20	4433467	S202M-Z20UC	2CDS272061R0488		5	0.250
	25	4433474	S202M-Z25UC	2CDS272061R0518		5	0.250
	30	4433481	S202M-Z30UC	2CDS272061R0528		5	0.250
	32	4433498	S202M-Z32UC	2CDS272061R0538		5	0.250
	35	4433504	S202M-Z35UC	2CDS272061R0548		5	0.250
	40	4433511	S202M-Z40UC	2CDS272061R0558		5	0.250
	50	4433528	S202M-Z50UC	2CDS272061R0578		5	0.250
60	4433535	S202M-Z60UC	2CDS272061R0588		5	0.250	
63	4433542	S202M-Z63UC	2CDS272061R0608		5	0.250	

MCBs

S 200 series M UC – Universal current range Z characteristic

2



S 203 M UC



S 204 M UC

Number of poles	Rated current In A	Bbn 401361 EAN	Order details		Price 1 piece	Weight 1 piece kg	Pack unit pc.
			Type code	Order code			
3	0.5	4435553	S203M-Z0.5UC	2CDS273061R0158		1	0.375
	1	4435560	S203M-Z1UC	2CDS273061R0218		1	0.375
	1.6	4435577	S203M-Z1.6UC	2CDS273061R0258		1	0.375
	2	4435584	S203M-Z2UC	2CDS273061R0278		1	0.375
	3	4435591	S203M-Z3UC	2CDS273061R0318		1	0.375
	4	4435607	S203M-Z4UC	2CDS273061R0338		1	0.375
	5	4435614	S203M-Z5UC	2CDS273061R0358		1	0.375
	6	4435621	S203M-Z6UC	2CDS273061R0378		1	0.375
	8	4435638	S203M-Z8UC	2CDS273061R0408		1	0.375
	10	4435645	S203M-Z10UC	2CDS273061R0428		1	0.375
	15	4435669	S203M-Z15UC	2CDS273061R0458		1	0.375
	16	4435676	S203M-Z16UC	2CDS273061R0468		1	0.375
	20	4435683	S203M-Z20UC	2CDS273061R0488		1	0.375
	25	4435690	S203M-Z25UC	2CDS273061R0518		1	0.375
	30	4435706	S203M-Z30UC	2CDS273061R0528		1	0.375
	32	4435713	S203M-Z32UC	2CDS273061R0538		1	0.375
	35	4435720	S203M-Z35UC	2CDS273061R0548		1	0.375
	40	4435737	S203M-Z40UC	2CDS273061R0558		1	0.375
	50	4435744	S203M-Z50UC	2CDS273061R0578		1	0.375
	60	4435751	S203M-Z60UC	2CDS273061R0588		1	0.375
63	4435768	S203M-Z63UC	2CDS273061R0608		1	0.375	

Number of poles	Rated current In A	Bbn 401361 EAN	Order details		Price 1 piece	Weight 1 piece kg	Pack unit pc.
			Type code	Order code			
4	0.5	4437779	S204M-Z0.5UC	2CDS274061R0158		1	0.500
	1	4437786	S204M-Z1UC	2CDS274061R0218		1	0.500
	1.6	4437793	S204M-Z1.6UC	2CDS274061R0258		1	0.500
	2	4437809	S204M-Z2UC	2CDS274061R0278		1	0.500
	3	4437816	S204M-Z3UC	2CDS274061R0318		1	0.500
	4	4437823	S204M-Z4UC	2CDS274061R0338		1	0.500
	5	4437830	S204M-Z5UC	2CDS274061R0358		1	0.500
	6	4437847	S204M-Z6UC	2CDS274061R0378		1	0.500
	8	4437854	S204M-Z8UC	2CDS274061R0408		1	0.500
	10	4437861	S204M-Z10UC	2CDS274061R0428		1	0.500
	15	4437885	S204M-Z15UC	2CDS274061R0458		1	0.500
	16	4437892	S204M-Z16UC	2CDS274061R0468		1	0.500
	20	4437908	S204M-Z20UC	2CDS274061R0488		1	0.500
	25	4437915	S204M-Z25UC	2CDS274061R0518		1	0.500
	30	4437922	S204M-Z30UC	2CDS274061R0528		1	0.500
	32	4437939	S204M-Z32UC	2CDS274061R0538		1	0.500
	35	4437946	S204M-Z35UC	2CDS274061R0548		1	0.500
	40	4437953	S204M-Z40UC	2CDS274061R0558		1	0.500
	50	4437960	S204M-Z50UC	2CDS274061R0578		1	0.500
	60	4437977	S204M-Z60UC	2CDS274061R0588		1	0.500
63	4437984	S204M-Z63UC	2CDS274061R0608		1	0.500	

Where to find more:
Coordination Tables for S 200M MCBs: p.10/37 for back-up and p.10/56 for selectivity
Worldwide Marks and Approvals of MCBs p.11/92

Frequently asked question - FAQ:
Where can I get certificates, declarations and CAD drawings?
You can find all of them on www.abb.com

Maybe you are also interested in:
Auxiliary Elements for MCBs p.4/2
Accessories for MCBs p.4/16
Busbar Systems p.4/21

MCBs

S 200 series P 25000 - 15000 B characteristic



S 201 P



S 202 P



S 203 P

S 200 P-B characteristic

Function: protection and control of the circuits against overloads and short-circuits; protection for people and large length of cables in TN and IT systems.

Applications: commercial and industrial.

Standard: IEC/EN 60898-1

Icn=25 kA for 0.5 A ≤ In ≤ 25 A

Icn=15 kA for 32 A ≤ In ≤ 63 A

2

Number of poles	Rated current	Bbn 4016779	Order details		Price 1 piece	Weight 1 piece kg	Pack unit pc.
	In A	EAN	Type code	Order code			
1	6	589574	S 201 P-B 6	2CDS281001R0065		0.14	10
	10	589581	S 201 P-B 10	2CDS281001R0105		0.14	10
	13	589598	S 201 P-B 13	2CDS281001R0135		0.14	10
	16	589260	S 201 P-B 16	2CDS281001R0165		0.14	10
	20	589604	S 201 P-B 20	2CDS281001R0205		0.14	10
	25	589611	S 201 P-B 25	2CDS281001R0255		0.14	10
	32	589628	S 201 P-B 32	2CDS281001R0325		0.14	10
	40	589635	S 201 P-B 40	2CDS281001R0405		0.14	10
	50	589659	S 201 P-B 50	2CDS281001R0505		0.14	10
	63	589666	S 201 P-B 63	2CDS281001R0635		0.14	10

Number of poles	Rated current	Bbn 4016779	Order details		Price 1 piece	Weight 1 piece kg	Pack unit pc.
	In A	EAN	Type code	Order code			
2	6	589673	S 202 P-B 6	2CDS282001R0065		0.28	5
	10	589680	S 202 P-B 10	2CDS282001R0105		0.28	5
	13	589697	S 202 P-B 13	2CDS282001R0135		0.28	5
	16	589703	S 202 P-B 16	2CDS282001R0165		0.28	5
	20	589710	S 202 P-B 20	2CDS282001R0205		0.28	5
	25	589727	S 202 P-B 25	2CDS282001R0255		0.28	5
	32	589734	S 202 P-B 32	2CDS282001R0325		0.28	5
	40	589741	S 202 P-B 40	2CDS282001R0405		0.28	5
	50	589758	S 202 P-B 50	2CDS282001R0505		0.28	5
	63	589765	S 202 P-B 63	2CDS282001R0635		0.28	5

Number of poles	Rated current	Bbn 4016779	Order details		Price 1 piece	Weight 1 piece kg	Pack unit pc.
	In A	EAN	Type code	Order code			
3	6	589772	S 203 P-B 6	2CDS283001R0065		0.42	1
	10	589789	S 203 P-B 10	2CDS283001R0105		0.42	1
	13	589796	S 203 P-B 13	2CDS283001R0135		0.42	1
	16	589802	S 203 P-B 16	2CDS283001R0165		0.42	1
	20	589819	S 203 P-B 20	2CDS283001R0205		0.42	1
	25	589826	S 203 P-B 25	2CDS283001R0255		0.42	1
	32	589833	S 203 P-B 32	2CDS283001R0325		0.42	1
	40	589840	S 203 P-B 40	2CDS283001R0405		0.42	1
	50	589857	S 203 P-B 50	2CDS283001R0505		0.42	1
	63	589864	S 203 P-B 63	2CDS283001R0635		0.42	1

Where to find more:

Coordination Tables for S 200P MCBs: p.10/37 for back-up and p.10/62 for selectivity
Worldwide Marks and Approvals of MCBs p.11/92

Frequently asked question - FAQ:

Where can I get certificates, declarations and CAD drawings?
You can find all of them on www.abb.com

Maybe you are also interested in:

Auxiliary Elements for MCBs p.4/2
Accessories for MCBs p.4/16
Busbar Systems p.4/21

MCBs

S 200 series P 25000 - 15000 B characteristic



S 204 P



S 201 P NA



S 203 P NA

Number of poles	Rated current In A	Bbn 4016779	Order details		Price 1 piece	Weight 1 piece kg	Pack unit pc.
		EAN	Type code	Order code			
4	6	589871	S 204 P-B 6	2CDS284001R0065		0.56	1
	10	589888	S 204 P-B 10	2CDS284001R0105		0.56	1
	13	589895	S 204 P-B 13	2CDS284001R0135		0.56	1
	16	589901	S 204 P-B 16	2CDS284001R0165		0.56	1
	20	589918	S 204 P-B 20	2CDS284001R0205		0.56	1
	25	589925	S 204 P-B 25	2CDS284001R0255		0.56	1
	32	589932	S 204 P-B 32	2CDS284001R0325		0.56	1
	40	589949	S 204 P-B 40	2CDS284001R0405		0.56	1
	50	589956	S 204 P-B 50	2CDS284001R0505		0.56	1
	63	589963	S 204 P-B 63	2CDS284001R0635		0.56	1

With disconnecting neutral NA

Number of poles	Rated current In A	Bbn 4016779	Order details		Price 1 piece	Weight 1 piece kg	Pack unit pc.
		EAN	Type code	Order code			
1+NA	6	589970	S 201 P-B 6 NA	2CDS281103R0065		0.28	5
	10	589987	S 201 P-B 10 NA	2CDS281103R0105		0.28	5
	13	589994	S 201 P-B 13 NA	2CDS281103R0135		0.28	5
	16	590006	S 201 P-B 16 NA	2CDS281103R0165		0.28	5
	20	590013	S 201 P-B 20 NA	2CDS281103R0205		0.28	5
	25	590020	S 201 P-B 25 NA	2CDS281103R0255		0.28	5
	32	590037	S 201 P-B 32 NA	2CDS281103R0325		0.28	5
	40	590044	S 201 P-B 40 NA	2CDS281103R0405		0.28	5
	50	590051	S 201 P-B 50 NA	2CDS281103R0505		0.28	5
	63	590068	S 201 P-B 63 NA	2CDS281103R0635		0.28	5

Number of poles	Rated current In A	Bbn 4016779	Order details		Price 1 piece	Weight 1 piece kg	Pack unit pc.
		EAN	Type code	Order code			
3+NA	6	590075	S 203 P-B 6 NA	2CDS283103R0065		0.56	1
	10	590082	S 203 P-B 10 NA	2CDS283103R0105		0.56	1
	13	590099	S 203 P-B 13 NA	2CDS283103R0135		0.56	1
	16	590105	S 203 P-B 16 NA	2CDS283103R0165		0.56	1
	20	590112	S 203 P-B 20 NA	2CDS283103R0205		0.56	1
	25	590129	S 203 P-B 25 NA	2CDS283103R0255		0.56	1
	32	590136	S 203 P-B 32 NA	2CDS283103R0325		0.56	1
	40	590143	S 203 P-B 40 NA	2CDS283103R0405		0.56	1
	50	590150	S 203 P-B 50 NA	2CDS283103R0505		0.56	1
	63	590167	S 203 P-B 63 NA	2CDS283103R0635		0.56	1

Where to find more:

Coordination Tables for S 200P
MCBs: p.10/37 for back-up and
p.10/62 for selectivity
Worldwide Marks and Approvals of
MCBs p.11/92

Frequently asked question - FAQ:

Where can I get certificates, declara-
tions and CAD drawings?
You can find all of them on
www.abb.com

Maybe you are also interested in:

Auxiliary Elements for MCBs p.4/2
Accessories for MCBs p.4/16
Busbar Systems p.4/21

MCBs

S 200 series P 25000 - 15000 C characteristic



S 201 P



S 202 P

S 200 P-C characteristic

Function: protection and control of the circuits against overloads and short-circuits; protection for resistive and inductive loads with low inrush current.

Applications: commercial and industrial.

Standard: IEC/EN 60898-1

I_{cn}=25 kA for 0.5 A ≤ I_n ≤ 25 A

I_{cn}=15 kA for 32 A ≤ I_n ≤ 63 A

2

Number of poles	Rated current	Bbn 4016779	Order details		Price 1 piece	Weight 1 piece kg	Pack unit pc.
	In A	EAN	Type code	Order code			
1	0.5	590174	S 201 P-C 0.5	2CDS281001R0984		0.14	10
	1	590181	S 201 P-C 1	2CDS281001R0014		0.14	10
	1.6	590198	S 201 P-C 1.6	2CDS281001R0974		0.14	10
	2	590204	S 201 P-C 2	2CDS281001R0024		0.14	10
	3	590211	S 201 P-C 3	2CDS281001R0034		0.14	10
	4	590228	S 201 P-C 4	2CDS281001R0044		0.14	10
	6	590235	S 201 P-C 6	2CDS281001R0064		0.14	10
	8	590242	S 201 P-C 8	2CDS281001R0084		0.14	10
	10	590259	S 201 P-C 10	2CDS281001R0104		0.14	10
	13	590266	S 201 P-C 13	2CDS281001R0134		0.14	10
	16	590273	S 201 P-C 16	2CDS281001R0164		0.14	10
	20	590280	S 201 P-C 20	2CDS281001R0204		0.14	10
	25	590297	S 201 P-C 25	2CDS281001R0254		0.14	10
	32	590303	S 201 P-C 32	2CDS281001R0324		0.14	10
	40	590310	S 201 P-C 40	2CDS281001R0404		0.14	10
	50	590327	S 201 P-C 50	2CDS281001R0504		0.14	10
	63	590334	S 201 P-C 63	2CDS281001R0634		0.14	10

Number of poles	Rated current	Bbn 4016779	Order details		Price 1 piece	Weight 1 piece kg	Pack unit pc.
	In A	EAN	Type code	Order code			
2	0.5	590341	S 202 P-C 0.5	2CDS282001R0984		0.28	5
	1	590358	S 202 P-C 1	2CDS282001R0014		0.28	5
	1.6	590365	S 202 P-C 1.6	2CDS282001R0974		0.28	5
	2	590372	S 202 P-C 2	2CDS282001R0024		0.28	5
	3	590389	S 202 P-C 3	2CDS282001R0034		0.28	5
	4	590396	S 202 P-C 4	2CDS282001R0044		0.28	5
	6	590402	S 202 P-C 6	2CDS282001R0064		0.28	5
	8	590419	S 202 P-C 8	2CDS282001R0084		0.28	5
	10	590426	S 202 P-C 10	2CDS282001R0104		0.28	5
	13	590433	S 202 P-C 13	2CDS282001R0134		0.28	5
	16	590440	S 202 P-C 16	2CDS282001R0164		0.28	5
	20	590457	S 202 P-C 20	2CDS282001R0204		0.28	5
	25	590464	S 202 P-C 25	2CDS282001R0254		0.28	5
	32	590471	S 202 P-C 32	2CDS282001R0324		0.28	5
	40	590488	S 202 P-C 40	2CDS282001R0404		0.28	5
	50	590495	S 202 P-C 50	2CDS282001R0504		0.28	5
	63	590501	S 202 P-C 63	2CDS 282 001 R0634		0.28	5

MCBs

S 200 series P 25000 - 15000 C characteristic



S 203 P



S 204 P

Number of poles	Rated current	Bbn 4016779	Order details		Price 1 piece	Weight 1 piece	Pack unit
	In A		EAN	Type code			
3	0.5	590518	S 203 P-C 0.5	2CDS283001R0984		0.42	1
	1	590525	S 203 P-C 1	2CDS283001R0014		0.42	1
	1.6	590532	S 203 P-C 1.6	2CDS283001R0974		0.42	1
	2	590549	S 203 P-C 2	2CDS283001R0024		0.42	1
	3	590556	S 203 P-C 3	2CDS283001R0034		0.42	1
	4	590563	S 203 P-C 4	2CDS283001R0044		0.42	1
	6	590570	S 203 P-C 6	2CDS283001R0064		0.42	1
	8	590587	S 203 P-C 8	2CDS283001R0084		0.42	1
	10	590594	S 203 P-C 10	2CDS283001R0104		0.42	1
	13	590600	S 203 P-C 13	2CDS283001R0134		0.42	1
	16	590617	S 203 P-C 16	2CDS283001R0164		0.42	1
	20	590624	S 203 P-C 20	2CDS283001R0204		0.42	1
	25	590631	S 203 P-C 25	2CDS283001R0254		0.42	1
	32	590648	S 203 P-C 32	2CDS283001R0324		0.42	1
	40	590655	S 203 P-C 40	2CDS283001R0404		0.42	1
	50	590662	S 203 P-C50	2CDS283001R0504		0.42	1
63	590679	S 203 P-C63	2CDS283001R0634		0.42	1	

Number of poles	Rated current	Bbn 4016779	Order details		Price 1 piece	Weight 1 piece	Pack unit
	In A		EAN	Type code			
4	0.5	590686	S 204 P-C 0.5	2CDS284001R0984		0.56	1
	1	590693	S 204 P-C 1	2CDS284001R0014		0.56	1
	1.6	590709	S 204 P-C 1.6	2CDS284001R0974		0.56	1
	2	590716	S 204 P-C 2	2CDS284001R0024		0.56	1
	3	590723	S 204 P-C 3	2CDS284001R0034		0.56	1
	4	590730	S 204 P-C 4	2CDS284001R0044		0.56	1
	6	590747	S 204 P-C 6	2CDS284001R0064		0.56	1
	8	590754	S 204 P-C 8	2CDS284001R0084		0.56	1
	10	590761	S 204 P-C 10	2CDS284001R0104		0.56	1
	13	590778	S 204 P-C 13	2CDS284001R0134		0.56	1
	16	590785	S 204 P-C 16	2CDS284001R0164		0.56	1
	20	590792	S 204 P-C 20	2CDS284001R0204		0.56	1
	25	590808	S 204 P-C 25	2CDS284001R0254		0.56	1
	32	590815	S 204 P-C 32	2CDS284001R0324		0.56	1
	40	590822	S 204 P-C 40	2CDS284001R0404		0.56	1
	50	590839	S 204 P-C 50	2CDS284001R0504		0.56	1
63	590846	S 204 P-C 63	2CDS284001R0634		0.56	1	

Where to find more:

Coordination Tables for S 200P
 MCBs: p.10/37 for back-up and
 p.10/62 for selectivity
 Worldwide Marks and Approvals of
 MCBs p.11/92

Frequently asked question - FAQ:

Where can I get certificates, declara-
 tions and CAD drawings?
 You can find all of them on
www.abb.com

Maybe you are also interested in:

Auxiliary Elements for MCBs p.4/2
 Accessories for MCBs p.4/16
 Busbar Systems p.4/21



S 201 P NA

2CSC400002D021



S 203 P NA

2CSC400002D021

With disconnecting neutral NA

Number of poles	Rated current	Bbn 4016779	Order details		Price 1 piece	Weight 1 piece kg	Pack unit pc.
	In A	EAN	Type code	Order code			
1+NA	0.5	590853	S 201 P-C 0.5 NA	2CDS281103R0984		0.28	5
	1	590860	S 201 P-C 1 NA	2CDS281103R0014		0.28	5
	1.6	590877	S 201 P-C 1.6 NA	2CDS281103R0974		0.28	5
	2	590884	S 201 P-C 2 NA	2CDS281103R0024		0.28	5
	3	590891	S 201 P-C 3 NA	2CDS281103R0034		0.28	5
	4	590907	S 201 P-C 4 NA	2CDS281103R0044		0.28	5
	6	590914	S 201 P-C 6 NA	2CDS281103R0064		0.28	5
	8	590921	S 201 P-C 8 NA	2CDS281103R0084		0.28	5
	10	590938	S 201 P-C 10 NA	2CDS281103R0104		0.28	5
	13	590945	S 201 P-C 13 NA	2CDS281103R0134		0.28	5
	16	590952	S 201 P-C 16 NA	2CDS281103R0164		0.28	5
	20	590969	S 201 P-C 20 NA	2CDS281103R0204		0.28	5
	25	590976	S 201 P-C 25 NA	2CDS281103R0254		0.28	5
	32	590983	S 201 P-C 32 NA	2CDS281103R0324		0.28	5
	40	590990	S 201 P-C 40 NA	2CDS281103R0404		0.28	5
	50	591003	S 201 P-C 50 NA	2CDS281103R0504		0.28	5
63	591010	S 201 P-C 63 NA	2CDS281103R0634		0.28	5	

2

Number of poles	Rated current	Bbn 4016779	Order details		Price 1 piece	Weight 1 piece kg	Pack unit pc.
	In A	EAN	Type code	Order code			
3+NA	0.5	591027	S 203 P-C 0.5 NA	2CDS283103R0984		0.56	1
	1	591034	S 203 P-C 1 NA	2CDS283103R0014		0.56	1
	1.6	591041	S 203 P-C 1.6 NA	2CDS283103R0974		0.56	1
	2	591058	S 203 P-C 2 NA	2CDS283103R0024		0.56	1
	3	591065	S 203 P-C 3 NA	2CDS283103R0034		0.56	1
	4	591072	S 203 P-C 4 NA	2CDS283103R0044		0.56	1
	6	591089	S 203 P-C 6 NA	2CDS283103R0064		0.56	1
	8	591096	S 203 P-C 8 NA	2CDS283103R0084		0.56	1
	10	591102	S 203 P-C 10 NA	2CDS283103R0104		0.56	1
	13	591119	S 203 P-C 13 NA	2CDS283103R0134		0.56	1
	16	591126	S 203 P-C 16 NA	2CDS283103R0164		0.56	1
	20	591133	S 203 P-C 20 NA	2CDS283103R0204		0.56	1
	25	591140	S 203 P-C 25 NA	2CDS283103R0254		0.56	1
	32	591157	S 203 P-C 32 NA	2CDS283103R0324		0.56	1
	40	591164	S 203 P-C 40 NA	2CDS283103R0404		0.56	1
	50	591171	S 203 P-C 50 NA	2CDS283103R0504		0.56	1
63	591188	S 203 P-C 63 NA	2CDS283103R0634		0.56	1	

MCBs

S 200 series P 25000 - 15000 D characteristic

2



S 201 P



S 202 P

S 200 P-D characteristic

Function: protection and control of the circuits against overloads and short-circuits; protection for circuits which supply loads with high inrush current at the circuit closing (LV/LV transformers, breakdown lamps).

Applications: commercial and industrial.

Standard: IEC/EN 60898-1

Icn=25 kA for 0.5 A ≤ In ≤ 25 A

Icn=15 kA for 32 A ≤ In ≤ 63 A

Number of poles	Rated current	Bbn 4016779	Order details		Price 1 piece	Weight 1 piece	Pack unit
	In A		EAN	Type code			
1	0.5	591195	S 201 P-D 0.5	2CDS281001R0981		0.14	10
	1	591201	S 201 P-D 1	2CDS281001R0011		0.14	10
	1.6	591218	S 201 P-D 1.6	2CDS281001R0971		0.14	10
	2	591225	S 201 P-D 2	2CDS281001R0021		0.14	10
	3	591232	S 201 P-D 3	2CDS281001R0031		0.14	10
	4	591249	S 201 P-D 4	2CDS281001R0041		0.14	10
	6	591256	S 201 P-D 6	2CDS281001R0061		0.14	10
	8	591263	S 201 P-D 8	2CDS281001R0081		0.14	10
	10	591270	S 201 P-D 10	2CDS281001R0101		0.14	10
	13	591287	S 201 P-D 13	2CDS281001R0131		0.14	10
	16	591294	S 201 P-D 16	2CDS281001R0161		0.14	10
	20	591300	S 201 P-D 20	2CDS281001R0201		0.14	10
	25	591317	S 201 P-D 25	2CDS281001R0251		0.14	10
	32	591324	S 201 P-D 32	2CDS281001R0321		0.14	10
	40	591331	S 201 P-D 40	2CDS281001R0401		0.14	10
50	591348	S 201 P-D 50	2CDS281001R0501		0.14	10	
63	591355	S 201 P-D 63	2CDS281001R0631		0.14	10	

Number of poles	Rated current	Bbn 4016779	Order details		Price 1 piece	Weight 1 piece	Pack unit
	In A		EAN	Type code			
2	0.5	591362	S 202 P-D 0.5	2CDS282001R0981		0.28	5
	1	591379	S 202 P-D 1	2CDS282001R0011		0.28	5
	1.6	591386	S 202 P-D 1.6	2CDS282001R0971		0.28	5
	2	591393	S 202 P-D 2	2CDS282001R0021		0.28	5
	3	591409	S 202 P-D 3	2CDS282001R0031		0.28	5
	4	591416	S 202 P-D 4	2CDS282001R0041		0.28	5
	6	591423	S 202 P-D 6	2CDS282001R0061		0.28	5
	8	591430	S 202 P-D 8	2CDS282001R0081		0.28	5
	10	591447	S 202 P-D 10	2CDS282001R0101		0.28	5
	13	591454	S 202 P-D 13	2CDS282001R0131		0.28	5
	16	591461	S 202 P-D 16	2CDS282001R0161		0.28	5
	20	591478	S 202 P-D 20	2CDS282001R0201		0.28	5
	25	591485	S 202 P-D 25	2CDS282001R0251		0.28	5
	32	591492	S 202 P-D 32	2CDS282001R0321		0.28	5
	40	591508	S 202 P-D 40	2CDS282001R0401		0.28	5
50	591515	S 202 P-D 50	2CDS282001R0501		0.28	5	
63	591522	S 202 P-D 63	2CDS282001R0631		0.28	5	

Where to find more:

Coordination Tables for S 200P MCBs: p.10/37 for back-up and p.10/62 for selectivity
Worldwide Marks and Approvals of MCBs p.11/92

Frequently asked question - FAQ:

Where can I get certificates, declarations and CAD drawings?
You can find all of them on www.abb.com

Maybe you are also interested in:

Auxiliary Elements for MCBs p.4/2
Accessories for MCBs p.4/16
Busbar Systems p.4/21

MCBs

S 200 series P 25000 - 15000 D characteristic



S 203 P



S 204 P

Number of poles	Rated current	Bbn 4016779	Order details		Price 1 piece	Weight 1 piece	Pack unit
	In A	EAN	Type code	Order code			
3	0.5	591539	S 203 P-D 0.5	2CDS283001R0981		0.42	1
	1	591546	S 203 P-D 1	2CDS283001R0011		0.42	1
	1.6	591553	S 203 P-D 1.6	2CDS283001R0971		0.42	1
	2	591560	S 203 P-D 2	2CDS283001R0021		0.42	1
	3	591577	S 203 P-D 3	2CDS283001R0031		0.42	1
	4	591584	S 203 P-D 4	2CDS283001R0041		0.42	1
	6	591591	S 203 P-D 6	2CDS283001R0061		0.42	1
	8	591607	S 203 P-D 8	2CDS283001R0081		0.42	1
	10	591614	S 203 P-D 10	2CDS283001R0101		0.42	1
	13	591621	S 203 P-D 13	2CDS283001R0131		0.42	1
	16	591638	S 203 P-D 16	2CDS283001R0161		0.42	1
	20	591645	S 203 P-D 20	2CDS283001R0201		0.42	1
	25	591652	S 203 P-D 25	2CDS283001R0251		0.42	1
	32	591669	S 203 P-D 32	2CDS283001R0321		0.42	1
	40	591676	S 203 P-D 40	2CDS283001R0401		0.42	1
	50	591683	S 203 P-D50	2CDS283001R0501		0.42	1
63	591690	S 203 P-D63	2CDS283001R0631		0.42	1	

2

Number of poles	Rated current	Bbn 4016779	Order details		Price 1 piece	Weight 1 piece	Pack unit
	In A	EAN	Type code	Order code			
4	0.5	591706	S 204 P-D 0.5	2CDS284001R0981		0.56	1
	1	591713	S 204 P-D 1	2CDS284001R0011		0.56	1
	1.6	591720	S 204 P-D 1.6	2CDS284001R0971		0.56	1
	2	591737	S 204 P-D 2	2CDS284001R0021		0.56	1
	3	591744	S 204 P-D 3	2CDS284001R0031		0.56	1
	4	591751	S 204 P-D 4	2CDS284001R0041		0.56	1
	6	591768	S 204 P-D 6	2CDS284001R0061		0.56	1
	8	591775	S 204 P-D 8	2CDS284001R0081		0.56	1
	10	591782	S 204 P-D 10	2CDS284001R0101		0.56	1
	13	591799	S 204 P-D 13	2CDS284001R0131		0.56	1
	16	591805	S 204 P-D 16	2CDS284001R0161		0.56	1
	20	591812	S 204 P-D 20	2CDS284001R0201		0.56	1
	25	591829	S 204 P-D 25	2CDS284001R0251		0.56	1
	32	591836	S 204 P-D 32	2CDS284001R0321		0.56	1
	40	591843	S 204 P-D 40	2CDS284001R0401		0.56	1
	50	591850	S 204 P-D 50	2CDS284001R0501		0.56	1
63	591867	S 204 P-D 63	2CDS284001R0631		0.56	1	

MCBs

S 200 series P 25000 - 15000 D characteristic



S 201 P NA



S 203 P NA

With disconnecting neutral NA

Number of poles	Rated current In A	Bbn 4016779 EAN	Order details		Price 1 piece	Weight 1 piece kg	Pack unit pc.
			Type code	Order code			
1+NA	0.5	591874	S 201 P-D 0.5 NA	2CDS281103R0981		0.28	5
	1	591881	S 201 P-D 1 NA	2CDS281103R0011		0.28	5
	1.6	591898	S 201 P-D 1.6 NA	2CDS281103R0971		0.28	5
	2	591904	S 201 P-D 2 NA	2CDS281103R0021		0.28	5
	3	591911	S 201 P-D 3 NA	2CDS281103R0031		0.28	5
	4	591928	S 201 P-D 4 NA	2CDS281103R0041		0.28	5
	6	591935	S 201 P-D 6 NA	2CDS281103R0061		0.28	5
	8	591942	S 201 P-D 8 NA	2CDS281103R0081		0.28	5
	10	591959	S 201 P-D 10 NA	2CDS281103R0101		0.28	5
	13	591966	S 201 P-D 13 NA	2CDS281103R0131		0.28	5
	16	591973	S 201 P-D 16 NA	2CDS281103R0161		0.28	5
	20	591980	S 201 P-D 20 NA	2CDS281103R0201		0.28	5
	25	591997	S 201 P-D 25 NA	2CDS281103R0251		0.28	5
	32	592000	S 201 P-D 32 NA	2CDS281103R0321		0.28	5
	40	592017	S 201 P-D 40 NA	2CDS281103R0401		0.28	5
	50	592024	S 201 P-D 50 NA	2CDS281103R0501		0.28	5
63	592031	S 201 P-D 63 NA	2CDS281103R0631		0.28	5	

Number of poles	Rated current In A	Bbn 4016779 EAN	Order details		Price 1 piece	Weight 1 piece kg	Pack unit pc.
			Type code	Order code			
3+NA	0.5	592048	S 203 P-D 0.5 NA	2CDS283103R0981		0.56	1
	1	592055	S 203 P-D 1 NA	2CDS283103R0011		0.56	1
	1.6	592062	S 203 P-D 1.6 NA	2CDS283103R0971		0.56	1
	2	592079	S 203 P-D 2 NA	2CDS283103R0021		0.56	1
	3	592086	S 203 P-D 3 NA	2CDS283103R0031		0.56	1
	4	592093	S 203 P-D 4 NA	2CDS283103R0041		0.56	1
	6	592109	S 203 P-D 6 NA	2CDS283103R0061		0.56	1
	8	592116	S 203 P-D 8 NA	2CDS283103R0081		0.56	1
	10	592123	S 203 P-D 10 NA	2CDS283103R0101		0.56	1
	13	592130	S 203 P-D 13 NA	2CDS283103R0131		0.56	1
	16	592147	S 203 P-D 16 NA	2CDS283103R0161		0.56	1
	20	592154	S 203 P-D 20 NA	2CDS283103R0201		0.56	1
	25	592161	S 203 P-D 25 NA	2CDS283103R0251		0.56	1
	32	592178	S 203 P-D 32 NA	2CDS283103R0321		0.56	1
	40	592185	S 203 P-D 40 NA	2CDS283103R0401		0.56	1
	50	592192	S 203 P-D 50 NA	2CDS283103R0501		0.56	1
63	592208	S 203 P-D 63 NA	2CDS283103R0631		0.56	1	

Where to find more:

Coordination Tables for S 200P
MCBs: p.10/37 for back-up and
p.10/62 for selectivity
Worldwide Marks and Approvals of
MCBs p.11/92

Frequently asked question - FAQ:

Where can I get certificates, declara-
tions and CAD drawings?
You can find all of them on
www.abb.com

Maybe you are also interested in:

Auxiliary Elements for MCBs p.4/2
Accessories for MCBs p.4/16
Busbar Systems p.4/21

MCBs

S 200 series P 25000 - 15000 K characteristic



S 201 P

S 200 P-K (power) characteristic

Function: protection and control of the circuits like motors, transformers and auxiliary circuits, against overloads and short-circuits.

Advantages: no nuisance tripping in the case of functional peak currents up to $10 \times I_n$, depending on the series; through its highly sensitive thermostatic bimetal trip, the K-type characteristic offers protection to damageable elements in the overcurrent range; it also provides the best protection to cables and lines.

Applications: commercial and industrial.

Standard: IEC/EN 60947-2

$I_{cu}=25$ kA for $0.5 A \leq I_n \leq 25 A$; $I_{cu}=15$ kA for $32 A \leq I_n \leq 63 A$

2

Number of poles	Rated current	Bbn 4016779	Order details		Price 1 piece	Weight 1 piece kg	Pack unit pc.
	In A	EAN	Type code	Order code			
1	0.2	592215	S 201 P-K 0.2	2CDS281001R0087		0.14	10
	0.3	592222	S 201 P-K 0.3	2CDS281001R0117		0.14	10
	0.5	592239	S 201 P-K 0.5	2CDS281001R0157		0.14	10
	0.75	592246	S 201 P-K 0.75	2CDS281001R0187		0.14	10
	1	592253	S 201 P-K 1	2CDS281001R0217		0.14	10
	1.6	592260	S 201 P-K 1.6	2CDS281001R0257		0.14	10
	2	592277	S 201 P-K 2	2CDS281001R0277		0.14	10
	3	592284	S 201 P-K 3	2CDS281001R0317		0.14	10
	4	592291	S 201 P-K 4	2CDS281001R0337		0.14	10
	6	592307	S 201 P-K 6	2CDS281001R0377		0.14	10
	8	592314	S 201 P-K 8	2CDS281001R0407		0.14	10
	10	592321	S 201 P-K 10	2CDS281001R0427		0.14	10
	13	592338	S 201 P-K 13	2CDS281001R0447		0.14	10
	16	592345	S 201 P-K 16	2CDS281001R0467		0.14	10
	20	592352	S 201 P-K 20	2CDS281001R0487		0.14	10
	25	592369	S 201 P-K 25	2CDS281001R0517		0.14	10
	32	592376	S 201 P-K 32	2CDS281001R0537		0.14	10
40	592383	S 201 P-K 40	2CDS281001R0557		0.14	10	
50	592390	S 201 P-K 50	2CDS281001R0577		0.14	10	
63	592406	S 201 P-K 63	2CDS281001R0607		0.14	10	

MCBs

S 200 series P 25000 - 15000 K characteristic



S 202 P



S 203 P

Number of poles	Rated current	Bbn 4016779	Order details		Price 1 piece	Weight 1 piece	Pack unit
	In A		EAN	Type code			
2	0.2	592413	S 202 P-K 0.2	2CDS282001R0087		0.28	5
	0.3	592420	S 202 P-K 0.3	2CDS282001R0117		0.28	5
	0.5	592437	S 202 P-K 0.5	2CDS282001R0157		0.28	5
	0.75	592444	S 202 P-K 0.75	2CDS282001R0187		0.28	5
	1	592451	S 202 P-K 1	2CDS282001R0217		0.28	5
	1.6	592468	S 202 P-K 1.6	2CDS282001R0257		0.28	5
	2	592475	S 202 P-K 2	2CDS282001R0277		0.28	5
	3	592482	S 202 P-K 3	2CDS282001R0317		0.28	5
	4	592499	S 202 P-K 4	2CDS282001R0337		0.28	5
	6	592505	S 202 P-K 6	2CDS282001R0377		0.28	5
	8	592512	S 202 P-K 8	2CDS282001R0407		0.28	5
	10	592529	S 202 P-K 10	2CDS282001R0427		0.28	5
	13	592536	S 202 P-K 13	2CDS282001R0447		0.28	5
	16	592543	S 202 P-K 16	2CDS282001R0467		0.28	5
	20	592550	S 202 P-K 20	2CDS282001R0487		0.28	5
	25	592567	S 202 P-K 25	2CDS282001R0517		0.28	5
	32	592574	S 202 P-K 32	2CDS282001R0537		0.28	5
40	592581	S 202 P-K 40	2CDS282001R0557		0.28	5	
50	592598	S 202 P-K 50	2CDS282001R0577		0.28	5	
63	592604	S 202 P-K 63	2CDS282001R0607		0.28	5	

Number of poles	Rated current	Bbn 4016779	Order details		Price 1 piece	Weight 1 piece	Pack unit
	In A		EAN	Type code			
3	0.2	592611	S 203 P-K 0.2	2CDS283001R0087		0.42	1
	0.3	592628	S 203 P-K 0.3	2CDS283001R0117		0.42	1
	0.5	592635	S 203 P-K 0.5	2CDS283001R0157		0.42	1
	0.75	592642	S 203 P-K 0.75	2CDS283001R0187		0.42	1
	1	592659	S 203 P-K 1	2CDS283001R0217		0.42	1
	1.6	592666	S 203 P-K 1.6	2CDS283001R0257		0.42	1
	2	592673	S 203 P-K 2	2CDS283001R0277		0.42	1
	3	592680	S 203 P-K 3	2CDS283001R0317		0.42	1
	4	592697	S 203 P-K 4	2CDS283001R0337		0.42	1
	6	592703	S 203 P-K 6	2CDS283001R0377		0.42	1
	8	592710	S 203 P-K 8	2CDS283001R0407		0.42	1
	10	592727	S 203 P-K 10	2CDS283001R0427		0.42	1
	13	592734	S 203 P-K 13	2CDS283001R0447		0.42	1
	16	592741	S 203 P-K 16	2CDS283001R0467		0.42	1
	20	592758	S 203 P-K 20	2CDS283001R0487		0.42	1
	25	592765	S 203 P-K 25	2CDS283001R0517		0.42	1
	32	592772	S 203 P-K 32	2CDS283001R0537		0.42	1
40	592789	S 203 P-K 40	2CDS283001R0557		0.42	1	
50	592796	S 203 P-K 50	2CDS283001R0577		0.42	1	
63	592802	S 203 P-K 63	2CDS283001R0607		0.42	1	

Where to find more:
 Coordination Tables for S 200P
 MCBs: p.10/37 for back-up and
 p.10/62 for selectivity
 Worldwide Marks and Approvals of
 MCBs p.11/92

Frequently asked question - FAQ:
 Where can I get certificates, declara-
 tions and CAD drawings?
 You can find all of them on
www.abb.com

Maybe you are also interested in:
 Auxiliary Elements for MCBs p.4/2
 Accessories for MCBs p.4/16
 Busbar Systems p.4/21



S 204 P



S 201 P NA

Number of poles	Rated current	Bbn 4016779	Order details		Price 1 piece	Weight 1 piece	Pack unit
	In A	EAN	Type code	Order code			
4	0.2	592819	S 204 P-K 0.2	2CDS284001R0087		0.56	1
	0.3	592826	S 204 P-K 0.3	2CDS284001R0117		0.56	1
	0.5	592833	S 204 P-K 0.5	2CDS284001R0157		0.56	1
	0.75	592840	S 204 P-K 0.75	2CDS284001R0187		0.56	1
	1	592857	S 204 P-K 1	2CDS284001R0217		0.56	1
	1.6	592864	S 204 P-K 1.6	2CDS284001R0257		0.56	1
	2	592871	S 204 P-K 2	2CDS284001R0277		0.56	1
	3	592888	S 204 P-K 3	2CDS284001R0317		0.56	1
	4	592895	S 204 P-K 4	2CDS284001R0337		0.56	1
	6	592901	S 204 P-K 6	2CDS284001R0377		0.56	1
	8	592918	S 204 P-K 8	2CDS284001R0407		0.56	1
	10	592925	S 204 P-K 10	2CDS284001R0427		0.56	1
	13	592932	S 204 P-K 13	2CDS284001R0447		0.56	1
	16	592949	S 204 P-K 16	2CDS284001R0467		0.56	1
	20	592956	S 204 P-K 20	2CDS284001R0487		0.56	1
	25	592963	S 204 P-K 25	2CDS284001R0517		0.56	1
	32	592970	S 204 P-K 32	2CDS284001R0537		0.56	1
	40	592987	S 204 P-K 40	2CDS284001R0557		0.56	1
	50	592994	S 204 P-K 50	2CDS284001R0577		0.56	1
63	593007	S 204 P-K 63	2CDS284001R0607		0.56	1	

2

With disconnecting neutral NA

Number of poles	Rated current	Bbn 4016779	Order details		Price 1 piece	Weight 1 piece	Pack unit
	In A	EAN	Type code	Order code			
1+NA	0.2	593014	S 201 P-K 0.2 NA	2CDS281103R0087		0.28	5
	0.3	593021	S 201 P-K 0.3 NA	2CDS281103R0117		0.28	5
	0.5	593038	S 201 P-K 0.5 NA	2CDS281103R0157		0.28	5
	0.75	593045	S 201 P-K 0.75 NA	2CDS281103R0187		0.28	5
	1	593052	S 201 P-K 1 NA	2CDS281103R0217		0.28	5
	1.6	593069	S 201 P-K 1.6 NA	2CDS281103R0257		0.28	5
	2	593076	S 201 P-K 2 NA	2CDS281103R0277		0.28	5
	3	593083	S 201 P-K 3 NA	2CDS281103R0317		0.28	5
	4	593090	S 201 P-K 4 NA	2CDS281103R0337		0.28	5
	6	593106	S 201 P-K 6 NA	2CDS281103R0377		0.28	5
	8	593113	S 201 P-K 8 NA	2CDS281103R0407		0.28	5
	10	593120	S 201 P-K 10 NA	2CDS281103R0427		0.28	5
	13	593137	S 201 P-K 13 NA	2CDS281103R0447		0.28	5
	16	593144	S 201 P-K 16 NA	2CDS281103R0467		0.28	5
	20	593151	S 201 P-K 20 NA	2CDS281103R0487		0.28	5
	25	593168	S 201 P-K 25 NA	2CDS281103R0517		0.28	5
	32	593175	S 201 P-K 32 NA	2CDS281103R0537		0.28	5
	40	593182	S 201 P-K 40 NA	2CDS281103R0557		0.28	5
	50	593199	S 201 P-K 50 NA	2CDS281103R0577		0.28	5
63	593205	S 201 P-K 63 NA	2CDS281103R0607		0.28	5	

MCBs

S 200 series P 25000 - 15000 K characteristic



S 203 P NA

Number of poles	Rated current	Bbn 4016779	Order details		Price 1 piece	Weight 1 piece kg	Pack unit pc.
	In A	EAN	Type code	Order code			
3+NA	0.2	593212	S 203 P-K 0.2 NA	2CDS283103R0087		0.56	2
	0.3	593229	S 203 P-K 0.3 NA	2CDS283103R0117		0.56	2
	0.5	593236	S 203 P-K 0.5 NA	2CDS283103R0157		0.56	2
	0.75	593243	S 203 P-K 0.75 NA	2CDS283103R0187		0.56	2
	1	593250	S 203 P-K 1 NA	2CDS283103R0217		0.56	2
	1.6	593267	S 203 P-K 1.6 NA	2CDS283103R0257		0.56	2
	2	593274	S 203 P-K 2 NA	2CDS283103R0277		0.56	2
	3	593281	S 203 P-K 3 NA	2CDS283103R0317		0.56	2
	4	593298	S 203 P-K 4 NA	2CDS283103R0337		0.56	2
	6	593304	S 203 P-K 6 NA	2CDS283103R0377		0.56	2
	8	593311	S 203 P-K 8 NA	2CDS283103R0407		0.56	2
	10	593328	S 203 P-K 10 NA	2CDS283103R0427		0.56	2
	13	593335	S 203 P-K 13 NA	2CDS283103R0447		0.56	2
	16	593342	S 203 P-K 16 NA	2CDS283103R0467		0.56	2
	20	593359	S 203 P-K 20 NA	2CDS283103R0487		0.56	2
	25	593366	S 203 P-K 25 NA	2CDS283103R0517		0.56	2
	32	593373	S 203 P-K 32 NA	2CDS283103R0537		0.56	2
40	593380	S 203 P-K 40 NA	2CDS283103R0557		0.56	2	
50	593397	S 203 P-K 50 NA	2CDS283103R0577		0.56	2	
63	593403	S 203 P-K 63 NA	2CDS283103R0607		0.56	2	

Where to find more:

Coordination Tables for S 200P
 MCBs: p.10/37 for back-up and
 p.10/62 for selectivity
 Worldwide Marks and Approvals of
 MCBs p.11/92

Frequently asked question - FAQ:

Where can I get certificates, declarations and CAD drawings?
 You can find all of them on
www.abb.com

Maybe you are also interested in:

Auxiliary Elements for MCBs p.4/2
 Accessories for MCBs p.4/16
 Busbar Systems p.4/21

MCBs

S 200 series P 25000 - 15000 Z characteristic



S 201 P



S 202 P

S 200 P-Z characteristic

Function: protection and control of the electronic circuits against lower and long duration overloads and short-circuits.

Applications: commercial and industrial.

Standard: IEC/EN 60947-2

Icu=25 kA for 0.5 A ≤ In ≤ 25 A; Icu=15 kA for 32 A ≤ In ≤ 63 A

2

Number of poles	Rated current	Bbn 4016779	Order details		Price 1 piece	Weight 1 piece	Pack unit
	In A	EAN	Type code	Order code			
1	0.5	593410	S 201 P-Z 0.5	2CDS281001R0158		0.14	10
	1	593427	S 201 P-Z 1	2CDS281001R0218		0.14	10
	1.6	593434	S 201 P-Z 1.6	2CDS281001R0258		0.14	10
	2	593441	S 201 P-Z 2	2CDS281001R0278		0.14	10
	3	593458	S 201 P-Z 3	2CDS281001R0318		0.14	10
	4	593465	S 201 P-Z 4	2CDS281001R0338		0.14	10
	6	593472	S 201 P-Z 6	2CDS281001R0378		0.14	10
	8	593489	S 201 P-Z 8	2CDS281001R0408		0.14	10
	10	593496	S 201 P-Z 10	2CDS281001R0428		0.14	10
	16	593502	S 201 P-Z 16	2CDS281001R0468		0.14	10
	20	593519	S 201 P-Z 20	2CDS281001R0488		0.14	10
	25	593526	S 201 P-Z 25	2CDS281001R0518		0.14	10
	32	593533	S 201 P-Z 32	2CDS281001R0538		0.14	10
	40	593540	S 201 P-Z 40	2CDS281001R0558		0.14	10
	50	593557	S 201 P-Z 50	2CDS281001R0578		0.14	10
63	593564	S 201 P-Z 63	2CDS281001R0608		0.14	10	

Number of poles	Rated current	Bbn 4016779	Order details		Price 1 piece	Weight 1 piece	Pack unit
	In A	EAN	Type code	Order code			
2	0.5	593571	S 202 P-Z 0.5	2CDS282001R0158		0.28	5
	1	593588	S 202 P-Z 1	2CDS282001R0218		0.28	5
	1.6	593595	S 202 P-Z 1.6	2CDS282001R0258		0.28	5
	2	593601	S 202 P-Z 2	2CDS282001R0278		0.28	5
	3	593618	S 202 P-Z 3	2CDS282001R0318		0.28	5
	4	593625	S 202 P-Z 4	2CDS282001R0338		0.28	5
	6	593632	S 202 P-Z 6	2CDS282001R0378		0.28	5
	8	593649	S 202 P-Z 8	2CDS282001R0408		0.28	5
	10	593656	S 202 P-Z 10	2CDS282001R0428		0.28	5
	16	593663	S 202 P-Z 16	2CDS282001R0468		0.28	5
	20	593670	S 202 P-Z 20	2CDS282001R0488		0.28	5
	25	593687	S 202 P-Z 25	2CDS282001R0518		0.28	5
	32	593694	S 202 P-Z 32	2CDS282001R0538		0.28	5
	40	593700	S 202 P-Z 40	2CDS282001R0558		0.28	5
	50	593717	S 202 P-Z 50	2CDS282001R0578		0.28	5
63	593724	S 202 P-Z 63	2CDS282001R0608		0.28	5	

MCBs

S 200 series P 25000 - 15000 Z characteristic



S 203 P



S 204 P

Number of poles	Rated current In A	Bbn 4016779 EAN	Order details		Price 1 piece	Weight 1 piece kg	Pack unit pc.
			Type code	Order code			
3	0.5	593731	S 203 P-Z 0.5	2CDS283001R0158		0.42	1
	1	593748	S 203 P-Z 1	2CDS283001R0218		0.42	1
	1.6	593755	S 203 P-Z 1.6	2CDS283001R0258		0.42	1
	2	593762	S 203 P-Z 2	2CDS283001R0278		0.42	1
	3	593779	S 203 P-Z 3	2CDS283001R0318		0.42	1
	4	593786	S 203 P-Z 4	2CDS283001R0338		0.42	1
	6	593793	S 203 P-Z 6	2CDS283001R0378		0.42	1
	8	593809	S 203 P-Z 8	2CDS283001R0408		0.42	1
	10	593816	S 203 P-Z 10	2CDS283001R0428		0.42	1
	16	593823	S 203 P-Z 16	2CDS283001R0468		0.42	1
	20	593830	S 203 P-Z 20	2CDS283001R0488		0.42	1
	25	593847	S 203 P-Z 25	2CDS283001R0518		0.42	1
	32	593854	S 203 P-Z 32	2CDS283001R0538		0.42	1
	40	593861	S 203 P-Z 40	2CDS283001R0558		0.42	1
	50	593878	S 203 P-Z 50	2CDS283001R0578		0.42	1
	63	593885	S 203 P-Z 63	2CDS283001R0608		0.42	1

Number of poles	Rated current In A	Bbn 4016779 EAN	Order details		Price 1 piece	Weight 1 piece kg	Pack unit pc.
			Type code	Order code			
4	0.5	593892	S 204 P-Z 0.5	2CDS284001R0158		0.56	1
	1	593908	S 204 P-Z 1	2CDS284001R0218		0.56	1
	1.6	593915	S 204 P-Z 1.6	2CDS284001R0258		0.56	1
	2	593922	S 204 P-Z 2	2CDS284001R0278		0.56	1
	3	593939	S 204 P-Z 3	2CDS284001R0318		0.56	1
	4	593946	S 204 P-Z 4	2CDS284001R0338		0.56	1
	6	593953	S 204 P-Z 6	2CDS284001R0378		0.56	1
	8	593960	S 204 P-Z 8	2CDS284001R0408		0.56	1
	10	593977	S 204 P-Z 10	2CDS284001R0428		0.56	1
	16	593984	S 204 P-Z 16	2CDS284001R0468		0.56	1
	20	593991	S 204 P-Z 20	2CDS284001R0488		0.56	1
	25	594004	S 204 P-Z 25	2CDS284001R0518		0.56	1
	32	594011	S 204 P-Z 32	2CDS284001R0538		0.56	1
	40	594028	S 204 P-Z 40	2CDS284001R0558		0.56	1
	50	594035	S 204 P-Z 50	2CDS284001R0578		0.56	1
	63	594042	S 204 P-Z 63	2CDS284001R0608		0.56	1

Where to find more:

Coordination Tables for S 200P
MCBs: p.10/37 for back-up and
p.10/62 for selectivity
Worldwide Marks and Approvals of
MCBs p.11/92

Frequently asked question - FAQ:

Where can I get certificates, declara-
tions and CAD drawings?
You can find all of them on
www.abb.com

Maybe you are also interested in:

Auxiliary Elements for MCBs p.4/2
Accessories for MCBs p.4/16
Busbar Systems p.4/21



S 201 P NA

2CSC400003F0201



S 203 P NA

2CSC400132F0201

With disconnecting neutral NA

Number of poles	Rated current	Bbn 4016779	Order details		Price 1 piece	Weight 1 piece	Pack unit
	In A	EAN	Type code	Order code			
1+NA	0.5	594059	S 201 P-Z 0.5 NA	2CDS281103R0158		0.28	5
	1	594066	S 201 P-Z 1 NA	2CDS281103R0218		0.28	5
	1.6	594073	S 201 P-Z 1.6 NA	2CDS281103R0258		0.28	5
	2	594080	S 201 P-Z 2 NA	2CDS281103R0278		0.28	5
	3	594097	S 201 P-Z 3 NA	2CDS281103R0318		0.28	5
	4	594103	S 201 P-Z 4 NA	2CDS281103R0338		0.28	5
	6	594110	S 201 P-Z 6 NA	2CDS281103R0378		0.28	5
	8	594127	S 201 P-Z 8 NA	2CDS281103R0408		0.28	5
	10	594134	S 201 P-Z 10 NA	2CDS281103R0428		0.28	5
	16	594141	S 201 P-Z 16 NA	2CDS281103R0468		0.28	5
	20	594158	S 201 P-Z 20 NA	2CDS281103R0488		0.28	5
	25	594165	S 201 P-Z 25 NA	2CDS281103R0518		0.28	5
	32	594172	S 201 P-Z 32 NA	2CDS281103R0538		0.28	5
	40	594189	S 201 P-Z 40 NA	2CDS281103R0558		0.28	5
	50	594196	S 201 P-Z 50 NA	2CDS281103R0578		0.28	5
63	594202	S 201 P-Z 63 NA	2CDS281103R0608		0.28	5	

2

Number of poles	Rated current	Bbn 4016779	Order details		Price 1 piece	Weight 1 piece	Pack unit
	In A	EAN	Type code	Order code			
3+NA	0.5	594219	S 203 P-Z 0.5 NA	2CDS283103R0158		0.56	1
	1	594226	S 203 P-Z 1 NA	2CDS283103R0218		0.56	1
	1.6	594233	S 203 P-Z 1.6 NA	2CDS283103R0258		0.56	1
	2	594240	S 203 P-Z 2 NA	2CDS283103R0278		0.56	1
	3	594257	S 203 P-Z 3 NA	2CDS283103R0318		0.56	1
	4	594264	S 203 P-Z 4 NA	2CDS283103R0338		0.56	1
	6	594271	S 203 P-Z 6 NA	2CDS283103R0378		0.56	1
	8	594288	S 203 P-Z 8 NA	2CDS283103R0408		0.56	1
	10	594295	S 203 P-Z 10 NA	2CDS283103R0428		0.56	1
	16	594301	S 203 P-Z 16 NA	2CDS283103R0468		0.56	1
	20	594318	S 203 P-Z 20 NA	2CDS283103R0488		0.56	1
	25	594325	S 203 P-Z 25 NA	2CDS283103R0518		0.56	1
	32	594332	S 203 P-Z 32 NA	2CDS283103R0538		0.56	1
	40	594349	S 203 P-Z 40 NA	2CDS283103R0558		0.56	1
	50	594356	S 203 P-Z 50 NA	2CDS283103R0578		0.56	1
63	594363	S 203 P-Z 63 NA	2CDS283103R0608		0.56	1	

MCBs

S 200 series PR - UL range 10000 K characteristic



S 201 PR

S 200 PR-K characteristic

Function: protection and control of the circuits against overloads and short-circuits; protection for resistive and inductive loads with low inrush current. The integrated captive connecting screws simplify the connection of electric lines, provides extra protection and saves time.

Applications: commercial and industrial.

Standard: IEC/EN 60947-2, UL1077, CSA 22.2 No. 235

Rated interrupting capacity 10 kA

Number of poles	Rated current	Bbn 4016779	Order details		Price 1 piece	Weight 1 piece kg	Pack unit pc.
	In A	EAN	Type code	Order code			
1	0.2	9846868	S201PR-K0.2	2CDS271427R0087		0.140	10
	0.3	9846875	S201PR-K0.3	2CDS271427R0117		0.140	10
	0.5	9846882	S201PR-K0.5	2CDS271427R0157		0.140	10
	0.75	9846899	S201PR-K0.75	2CDS271427R0187		0.140	10
	1	9846905	S201PR-K1	2CDS271427R0217		0.140	10
	1.6	9846912	S201PR-K1.6	2CDS271427R0257		0.140	10
	2	9846929	S201PR-K2	2CDS271427R0277		0.140	10
	3	9846936	S201PR-K3	2CDS271427R0317		0.140	10
	4	9846943	S201PR-K4	2CDS271427R0337		0.140	10
	5	9846950	S201PR-K5	2CDS271427R0357		0.140	10
	6	9846967	S201PR-K6	2CDS271427R0377		0.140	10
	8	9846974	S201PR-K8	2CDS271427R0407		0.140	10
	10	9846981	S201PR-K10	2CDS271427R0427		0.140	10
	13	9846998	S201PR-K13	2CDS271427R0447		0.140	10
	15	9847001	S201PR-K15	2CDS271427R0457		0.140	10
	16	9847018	S201PR-K16	2CDS271427R0467		0.140	10
	20	9847025	S201PR-K20	2CDS271427R0487		0.140	10
	25	9847032	S201PR-K25	2CDS271427R0517		0.140	10
	30	9847049	S201PR-K30	2CDS271427R0527		0.140	10
	32	9847056	S201PR-K32	2CDS271427R0537		0.140	10
35	9847063	S201PR-K35	2CDS271427R0547		0.140	10	
40	9847070	S201PR-K40	2CDS271427R0557		0.140	10	
50	9847087	S201PR-K50	2CDS271427R0577		0.140	10	
60	9847094	S201PR-K60	2CDS271427R0587		0.140	10	
63	9847100	S201PR-K63	2CDS271427R0607		0.140	10	

Where to find more:

Worldwide Marks and Approvals of MCBs p.11/92

Frequently asked question - FAQ:

Where can I get certificates, declarations and CAD drawings?
You can find all of them on www.abb.com



S 202 PR

2CDS210180012

Number of poles	Rated current	Bbn 4016779	Order details		Price 1 piece	Weight 1 piece kg	Pack unit pc.
	In A	EAN	Type code	Order code			
2	0.2	9847117	S202PR-K0.2	2CDS272427R0087		0.280	5
	0.3	9847124	S202PR-K0.3	2CDS272427R0117		0.280	5
	0.5	9847131	S202PR-K0.5	2CDS272427R0157		0.280	5
	0.75	9847148	S202PR-K0.75	2CDS272427R0187		0.280	5
	1	9847155	S202PR-K1	2CDS272427R0217		0.280	5
	1.6	9847162	S202PR-K1.6	2CDS272427R0257		0.280	5
	2	9847179	S202PR-K2	2CDS272427R0277		0.280	5
	3	9847186	S202PR-K3	2CDS272427R0317		0.280	5
	4	9847193	S202PR-K4	2CDS272427R0337		0.280	5
	5	9847209	S202PR-K5	2CDS272427R0357		0.280	5
	6	9847216	S202PR-K6	2CDS272427R0377		0.280	5
	8	9847223	S202PR-K8	2CDS272427R0407		0.280	5
	10	9847230	S202PR-K10	2CDS272427R0427		0.280	5
	13	9847247	S202PR-K13	2CDS272427R0447		0.280	5
	15	9847254	S202PR-K15	2CDS272427R0457		0.280	5
	16	9847261	S202PR-K16	2CDS272427R0467		0.280	5
	20	9847278	S202PR-K20	2CDS272427R0487		0.280	5
	25	9847285	S202PR-K25	2CDS272427R0517		0.280	5
	30	9847292	S202PR-K30	2CDS272427R0527		0.280	5
	32	9847308	S202PR-K32	2CDS272427R0537		0.280	5
35	9847315	S202PR-K35	2CDS272427R0547		0.280	5	
40	9847322	S202PR-K40	2CDS272427R0557		0.280	5	
50	9847339	S202PR-K50	2CDS272427R0577		0.280	5	
60	9847346	S202PR-K60	2CDS272427R0587		0.280	5	
63	9847353	S202PR-K63	2CDS272427R0607		0.280	5	

2

MCBs

S 200 series PR - UL range 10000 K characteristic

2



S 203 PR



S 204 PR

Number of poles	Rated current	Bbn 4016779	Order details		Price 1 piece	Weight 1 piece kg	Pack unit pc.
	In A	EAN	Type code	Order code			
3	0.2	9847360	S203PR-K0.2	2CDS273427R0087		0.420	3
	0.3	9847377	S203PR-K0.3	2CDS273427R0117		0.420	3
	0.5	9847384	S203PR-K0.5	2CDS273427R0157		0.420	3
	0.75	9847391	S203PR-K0.75	2CDS273427R0187		0.420	3
	1	9847407	S203PR-K1	2CDS273427R0217		0.420	3
	1.6	9847414	S203PR-K1.6	2CDS273427R0257		0.420	3
	2	9847421	S203PR-K2	2CDS273427R0277		0.420	3
	3	9847438	S203PR-K3	2CDS273427R0317		0.420	3
	4	9847445	S203PR-K4	2CDS273427R0337		0.420	3
	5	9847452	S203PR-K5	2CDS273427R0357		0.420	3
	6	9847469	S203PR-K6	2CDS273427R0377		0.420	3
	8	9847476	S203PR-K8	2CDS273427R0407		0.420	3
	10	9847483	S203PR-K10	2CDS273427R0427		0.420	3
	13	9847490	S203PR-K13	2CDS273427R0447		0.420	3
	15	9847506	S203PR-K15	2CDS273427R0457		0.420	3
	16	9847513	S203PR-K16	2CDS273427R0467		0.420	3
	20	9847520	S203PR-K20	2CDS273427R0487		0.420	3
	25	9847537	S203PR-K25	2CDS273427R0517		0.420	3
	30	9847544	S203PR-K30	2CDS273427R0527		0.420	3
	32	9847551	S203PR-K32	2CDS273427R0537		0.420	3
	35	9847568	S203PR-K35	2CDS273427R0547		0.420	3
40	9847575	S203PR-K40	2CDS273427R0557		0.420	3	
50	9847582	S203PR-K50	2CDS273427R0577		0.420	3	
60	9847599	S203PR-K60	2CDS273427R0587		0.420	3	
63	9847605	S203PR-K63	2CDS273427R0607		0.420	3	
4	0.2	9847612	S204PR-K0.2	2CDS274427R0087		0.560	2
	0.3	9847629	S204PR-K0.3	2CDS274427R0117		0.560	2
	0.5	9847636	S204PR-K0.5	2CDS274427R0157		0.560	2
	0.75	9847643	S204PR-K0.75	2CDS274427R0187		0.560	2
	1	9847650	S204PR-K1	2CDS274427R0217		0.560	2
	1.6	9847667	S204PR-K1.6	2CDS274427R0257		0.560	2
	2	9847674	S204PR-K2	2CDS274427R0277		0.560	2
	3	9847681	S204PR-K3	2CDS274427R0317		0.560	2
	4	9847698	S204PR-K4	2CDS274427R0337		0.560	2
	5	9847704	S204PR-K5	2CDS274427R0357		0.560	2
	6	9847711	S204PR-K6	2CDS274427R0377		0.560	2
	8	9847728	S204PR-K8	2CDS274427R0407		0.560	2
	10	9847735	S204PR-K10	2CDS274427R0427		0.560	2
	13	9847742	S204PR-K13	2CDS274427R0447		0.560	2
	15	9847759	S204PR-K15	2CDS274427R0457		0.560	2
	16	9847766	S204PR-K16	2CDS274427R0467		0.560	2
	20	9847773	S204PR-K20	2CDS274427R0487		0.560	2
	25	9847780	S204PR-K25	2CDS274427R0517		0.560	2
	30	9847797	S204PR-K30	2CDS274427R0527		0.560	2
	32	9847803	S204PR-K32	2CDS274427R0537		0.560	2
	35	9847810	S204PR-K35	2CDS274427R0547		0.560	2
40	9847827	S204PR-K40	2CDS274427R0557		0.560	2	
50	9847834	S204PR-K50	2CDS274427R0577		0.560	2	
60	9847841	S204PR-K60	2CDS274427R0587		0.560	2	
63	9847858	S204PR-K63	2CDS274427R0607		0.560	2	

Where to find more:
Worldwide Marks and Approvals of MCBs p.11/92

Frequently asked question - FAQ:
Where can I get certificates, declarations and CAD drawings?
You can find all of them on www.abb.com

MCBs

S 200 series S - screwless range 6000 B and C characteristics



S 201 S



S 203 S

S 200 S-B and S 200 S-C characteristic

Function: protection and control of the circuits against overloads and short-circuits.

Applications: residential, commercial and industrial.

Standard: IEC/EN 60898-1

Icn=6 kA

2

S 200 S-B characteristic

Number of poles	Rated current	Bbn 4016779	Order details		Price 1 piece	Weight 1 piece	Pack unit
	In A	EAN	Type code	Order code			
1	6	709385	S 201 S-B6	2CDS251002R0065		0.100	10
	10	709415	S 201 S-B10	2CDS251002R0105		0.100	10
	13	709439	S 201 S-B13	2CDS251002R0135		0.100	10
	16	709453	S 201 S-B16	2CDS251002R0165		0.100	10
	20	709477	S 201 S-B20	2CDS251002R0205		0.100	10

Number of poles	Rated current	Bbn 4016779	Order details		Price 1 piece	Weight 1 piece	Pack unit
	In A	EAN	Type code	Order code			
3	6	709484	S 203 S-B6	2CDS253002R0065		0.300	1
	10	709514	S 203 S-B10	2CDS253002R0105		0.300	1
	13	709538	S 203 S-B13	2CDS253002R0135		0.300	1
	16	709552	S 203 S-B16	2CDS253002R0165		0.300	1
	20	709576	S 203 S-B20	2CDS253002R0205		0.300	1

S 200 S-C characteristic

Number of poles	Rated current	Bbn 4016779	Order details		Price 1 piece	Weight 1 piece	Pack unit
	In A	EAN	Type code	Order code			
1	6	756891	S 201 S-C6	2CDS251002R0064		100	10
	8	709392	S 201 S-C8	2CDS251002R0084		100	10
	10	709408	S 201 S-C10	2CDS251002R0104		100	10
	13	709422	S 201 S-C13	2CDS251002R0134		100	10
	16	709446	S 201 S-C16	2CDS251002R0164		100	10
	20	709460	S 201 S-C20	2CDS251002R0204		100	10

Number of poles	Rated current	Bbn 4016779	Order details		Price 1 piece	Weight 1 piece	Pack unit
	In A	EAN	Type code	Order code			
3	6	709378	S 203 S-C6	2CDS253002R0064		300	1
	8	709491	S 203 S-C8	2CDS253002R0084		300	1
	10	709507	S 203 S-C10	2CDS253002R0104		300	1
	13	709521	S 203 S-C13	2CDS253002R0134		300	1
	16	709545	S 203 S-C16	2CDS253002R0164		300	1
	20	709569	S 203 S-C20	2CDS253002R0204		300	1

Where to find more:
Worldwide Marks and Approvals of MCBs p.11/92

Frequently asked question - FAQ:
Where can I get certificates, declarations and CAD drawings?
You can find all of them on www.abb.com

MCBs

S 200 series U - UL range 10000 C characteristic



S 201 U

S 200 U-C characteristic

Function: protection and control of the circuits like motors, transformers and auxiliary circuits, against overloads and short-circuits.

Advantages: no nuisance tripping in the case of functional peak currents up to $10xI_n$, depending on the series; through its highly sensitive thermostatic bimetal trip, the C-type characteristic offers protection to damageable elements in the overcurrent range; it also provides the best protection to cables and lines.

Applications: commercial and industrial.

Standard: IEC/EN 60947-2, UL 489, CSA 22.2 No. 5

Short-circuit current rating (SCCR acc. to UL 489): 10 kA

Number of poles	Rated current	Bbn 4016779	Order details		Price 1 piece	Weight 1 piece kg	Pack unit pc.
	In A	EAN	Type code	Order code			
1	0.5	4016779854726	S201U-C0.5	2CDS271417R0984		0.140	10
	1	4016779854740	S201U-C1	2CDS271417R0014		0.140	10
	1.6	4016779854757	S201U-C1.6	2CDS271417R0974		0.140	10
	2	4016779858366	S201U-C2	2CDS271417R0024		0.140	10
	3	4016779858373	S201U-C3	2CDS271417R0034		0.140	10
	4	4016779858380	S201U-C4	2CDS271417R0044		0.140	10
	5	4016779858397	S201U-C5	2CDS271417R0054		0.140	10
	6	4016779858403	S201U-C6	2CDS271417R0064		0.140	10
	8	4016779858410	S201U-C8	2CDS271417R0084		0.140	10
	10	4016779858427	S201U-C10	2CDS271417R0104		0.140	10
	13	4016779858434	S201U-C13	2CDS271417R0134		0.140	10
	15	4016779858441	S201U-C15	2CDS271417R0154		0.140	10
	16	4016779858458	S201U-C16	2CDS271417R0164		0.140	10
	20	4016779858465	S201U-C20	2CDS271417R0204		0.140	10
	25	4016779858472	S201U-C25	2CDS271417R0254		0.140	10
	30	4016779858489	S201U-C30	2CDS271417R0304		0.140	10
	32	4016779858496	S201U-C32	2CDS271417R0324		0.140	10
	40	4016779858502	S201U-C40	2CDS271417R0404		0.140	10
	50	4016779858519	S201U-C50	2CDS271417R0504		0.140	10
60	4016779858526	S201U-C60	2CDS271417R0604		0.140	10	
63	4016779858533	S201U-C63	2CDS271417R0634		0.140	10	

Where to find more:

Worldwide Marks and Approvals of MCBs p.11/92

Frequently asked question - FAQ:

Where can I get certificates, declarations and CAD drawings?
You can find all of them on www.abb.com

Maybe you are also interested in:

Auxiliary Elements for S 200 MCBs according to UL p.4/14
Accessories for MCBs p.4/16
Busbar Systems p.4/21



S 202 U

2CSC400010R0201



S 203 U

2CSC400010R0201

Number of poles	Rated current In A	Bbn 4016779 EAN	Order details		Price 1 piece	Weight 1 piece kg	Pack unit pc.
			Type code	Order code			
2	0.5	4016779858564	S202U-C0.5	2CDS272417R0984		0.280	5
	1	4016779858588	S202U-C1	2CDS272417R0014		0.280	5
	1.6	4016779858595	S202U-C1.6	2CDS272417R0974		0.280	5
	2	4016779858601	S202U-C2	2CDS272417R0024		0.280	5
	3	4016779858618	S202U-C3	2CDS272417R0034		0.280	5
	4	4016779858625	S202U-C4	2CDS272417R0044		0.280	5
	5	4016779858632	S202U-C5	2CDS272417R0054		0.280	5
	6	4016779858649	S202U-C6	2CDS272417R0064		0.280	5
	8	4016779858656	S202U-C8	2CDS272417R0084		0.280	5
	10	4016779858663	S202U-C10	2CDS272417R0104		0.280	5
	13	4016779858670	S202U-C13	2CDS272417R0134		0.280	5
	15	4016779858687	S202U-C15	2CDS272417R0154		0.280	5
	16	4016779858694	S202U-C16	2CDS272417R0164		0.280	5
	20	4016779858700	S202U-C20	2CDS272417R0204		0.280	5
	25	4016779858717	S202U-C25	2CDS272417R0254		0.280	5
	30	4016779858724	S202U-C30	2CDS272417R0304		0.280	5
	32	4016779858731	S202U-C32	2CDS272417R0324		0.280	5
40	4016779858748	S202U-C40	2CDS272417R0404		0.280	5	
50	4016779858755	S202U-C50	2CDS272417R0504		0.280	5	
60	4016779858762	S202U-C60	2CDS272417R0604		0.280	5	
63	4016779858779	S202U-C63	2CDS272417R0634		0.280	5	

2

Number of poles	Rated current In A	Bbn 4016779 EAN	Order details		Price 1 piece	Weight 1 piece kg	Pack unit pc.
			Type code	Order code			
3	0.5	4016779858809	S203U-C0.5	2CDS273417R0984		0.420	3
	1	4016779858823	S203U-C1	2CDS273417R0014		0.420	3
	1.6	4016779858830	S203U-C1.6	2CDS273417R0974		0.420	3
	2	4016779858847	S203U-C2	2CDS273417R0024		0.420	3
	3	4016779858854	S203U-C3	2CDS273417R0034		0.420	3
	4	4016779858861	S203U-C4	2CDS273417R0044		0.420	3
	5	4016779858878	S203U-C5	2CDS273417R0054		0.420	3
	6	4016779858885	S203U-C6	2CDS273417R0064		0.420	3
	8	4016779858892	S203U-C8	2CDS273417R0084		0.420	3
	10	4016779858908	S203U-C10	2CDS273417R0104		0.420	3
	13	4016779858915	S203U-C13	2CDS273417R0134		0.420	3
	15	4016779858922	S203U-C15	2CDS273417R0154		0.420	3
	16	4016779858939	S203U-C16	2CDS273417R0164		0.420	3
	20	4016779858946	S203U-C20	2CDS273417R0204		0.420	3
	25	4016779858953	S203U-C25	2CDS273417R0254		0.420	3
	30	4016779858960	S203U-C30	2CDS273417R0304		0.420	3
	32	4016779858977	S203U-C32	2CDS273417R0324		0.420	3
40	4016779858984	S203U-C40	2CDS273417R0404		0.420	3	
50	4016779858991	S203U-C50	2CDS273417R0504		0.420	3	
60	4016779859004	S203U-C60	2CDS273417R0604		0.420	3	
63	4016779859011	S203U-C63	2CDS273417R0634		0.420	3	

MCBs

S 200 series U - UL range 10000 C characteristic



S 204 U

2CSC4001TFE01

Number of poles	Rated current	Bbn 4016779	Order details		Price 1 piece	Weight 1 piece kg	Pack unit pc.
	In A	EAN	Type code	Order code			
4	0.5	4016779859042	S204U-C0.5	2CDS274417R0984		0.560	2
	1	4016779859066	S204U-C1	2CDS274417R0014		0.560	2
	1.6	4016779859073	S204U-C1.6	2CDS274417R0974		0.560	2
	2	4016779859080	S204U-C2	2CDS274417R0024		0.560	2
	3	4016779859097	S204U-C3	2CDS274417R0034		0.560	2
	4	4016779859103	S204U-C4	2CDS274417R0044		0.560	2
	5	4016779859110	S204U-C5	2CDS274417R0054		0.560	2
	6	4016779859127	S204U-C6	2CDS274417R0064		0.560	2
	8	4016779859134	S204U-C8	2CDS274417R0084		0.560	2
	10	4016779859141	S204U-C10	2CDS274417R0104		0.560	2
	13	4016779859158	S204U-C13	2CDS274417R0134		0.560	2
	15	4016779859165	S204U-C15	2CDS274417R0154		0.560	2
	16	4016779859172	S204U-C16	2CDS274417R0164		0.560	2
	20	4016779859189	S204U-C20	2CDS274417R0204		0.560	2
	25	4016779859196	S204U-C25	2CDS274417R0254		0.560	2
	30	4016779859202	S204U-C30	2CDS274417R0304		0.560	2
	32	4016779859219	S204U-C32	2CDS274417R0324		0.560	2
	40	4016779859226	S204U-C40	2CDS274417R0404		0.560	2
	50	4016779859233	S204U-C50	2CDS274417R0504		0.560	2
	60	4016779859240	S204U-C60	2CDS274417R0604		0.560	2
63	4016779859257	S204U-C63	2CDS274417R0634		0.560	2	

Where to find more:

Worldwide Marks and Approvals of MCBs p.11/92

Frequently asked question - FAQ:

Where can I get certificates, declarations and CAD drawings?
You can find all of them on www.abb.com

Maybe you are also interested in:

Auxiliary Elements for S 200 MCBs according to UL p.4/14
Accessories for MCBs p.4/16
Busbar Systems p.4/21

MCBs

S 200 series U - UL range 10000 K characteristic



S 201 U

S 200 U-K characteristic

Function: protection and control of the circuits like motors, transformers and auxiliary circuits, against overloads and short-circuits.

Advantages: no nuisance tripping in the case of functional peak currents up to $10 \times I_n$, depending on the series; through its highly sensitive thermostatic bimetal trip, the K-type characteristic offers protection to damageable elements in the overcurrent range; it also provides the best protection to cables and lines.

Applications: commercial and industrial.

Standard: IEC/EN 60947-2, UL 489, CSA 22.2 No. 5

Short-circuit current rating (SCCR acc. to UL 489): 10 kA

2

Number of poles	Rated current	Bbn 4016779	Order details		Price 1 piece	Weight 1 piece kg	Pack unit pc.
	In A	EAN	Type code	Order code			
1	0.2	619226	S 201 U-K 0.2	2CDS271417R0087		0.14	10
	0.3	619233	S 201 U-K 0.3	2CDS271417R0117		0.14	10
	0.5	619240	S 201 U-K 0.5	2CDS271417R0157		0.14	10
	0.75	619257	S 201 U-K 0.75	2CDS271417R0187		0.14	10
	1	619264	S 201 U-K 1	2CDS271417R0217		0.14	10
	1.6	619271	S 201 U-K 1.6	2CDS271417R0257		0.14	10
	2	619288	S 201 U-K 2	2CDS271417R0277		0.14	10
	3	619295	S 201 U-K 3	2CDS271417R0317		0.14	10
	4	619301	S 201 U-K 4	2CDS271417R0337		0.14	10
	5	619318	S 201 U-K 5	2CDS271417R0357		0.14	10
	6	619325	S 201 U-K 6	2CDS271417R0377		0.14	10
	8	619332	S 201 U-K 8	2CDS271417R0407		0.14	10
	10	619349	S 201 U-K 10	2CDS271417R0427		0.14	10
	13	619356	S 201 U-K 13	2CDS271417R0447		0.14	10
	15	619363	S 201 U-K 15	2CDS271417R0457		0.14	10
	16	619370	S 201 U-K 16	2CDS271417R0467		0.14	10
	20	619387	S 201 U-K 20	2CDS271417R0487		0.14	10
	25	619394	S 201 U-K 25	2CDS271417R0517		0.14	10
	30	619400	S 201 U-K 30	2CDS271417R0527		0.14	10
	32	619417	S 201 U-K 32	2CDS271417R0537		0.14	10
40	619424	S 201 U-K 40	2CDS271417R0557		0.14	10	
50	619431	S 201 U-K 50	2CDS271417R0577		0.14	10	
60	619448	S 201 U-K 60	2CDS271417R0587		0.14	10	
63	619455	S 201 U-K 63	2CDS271417R0607		0.14	10	

MCBs

S 200 series U - UL range 10000 K characteristic

2



S 202 U



S 203 U

Number of poles	Rated current	Bbn 4016779	Order details		Price 1 piece	Weight 1 piece kg	Pack unit pc.
	In A	EAN	Type code	Order code			
2	0.2	619462	S 202 U-K 0.2	2CDS272417R0087		0.28	5
	0.3	619479	S 202 U-K 0.3	2CDS272417R0117		0.28	5
	0.5	619486	S 202 U-K 0.5	2CDS272417R0157		0.28	5
	0.75	619493	S 202 U-K 0.75	2CDS272417R0187		0.28	5
	1	619509	S 202 U-K 1	2CDS272417R0217		0.28	5
	1.6	619516	S 202 U-K 1.6	2CDS272417R0257		0.28	5
	2	619523	S 202 U-K 2	2CDS272417R0277		0.28	5
	3	619530	S 202 U-K 3	2CDS272417R0317		0.28	5
	4	619547	S 202 U-K 4	2CDS272417R0337		0.28	5
	5	619554	S 202 U-K 5	2CDS272417R0357		0.28	5
	6	619561	S 202 U-K 6	2CDS272417R0377		0.28	5
	8	619578	S 202 U-K 8	2CDS272417R0407		0.28	5
	10	619585	S 202 U-K 10	2CDS272417R0427		0.28	5
	13	619592	S 202 U-K 13	2CDS272417R0447		0.28	5
	15	619608	S 202 U-K 15	2CDS272417R0457		0.28	5
	16	619615	S 202 U-K 16	2CDS272417R0467		0.28	5
	20	619622	S 202 U-K 20	2CDS272417R0487		0.28	5
	25	619639	S 202 U-K 25	2CDS272417R0517		0.28	5
	30	619646	S 202 U-K 30	2CDS272417R0527		0.28	5
	32	619653	S 202 U-K 32	2CDS272417R0537		0.28	5
40	619660	S 202 U-K 40	2CDS272417R0557		0.28	5	
50	619677	S 202 U-K 50	2CDS272417R0577		0.28	5	
60	619684	S 202 U-K 60	2CDS272417R0587		0.28	5	
63	619691	S 202 U-K 63	2CDS272417R0607		0.28	5	
3	0.2	619707	S 203 U-K 0.2	2CDS273417R0087		0.42	3
	0.3	619714	S 203 U-K 0.3	2CDS273417R0117		0.42	3
	0.5	619721	S 203 U-K 0.5	2CDS273417R0157		0.42	3
	0.75	619738	S 203 U-K 0.75	2CDS273417R0187		0.42	3
	1	619745	S 203 U-K 1	2CDS273417R0217		0.42	3
	1.6	619752	S 203 U-K 1.6	2CDS273417R0257		0.42	3
	2	619769	S 203 U-K 2	2CDS273417R0277		0.42	3
	3	619776	S 203 U-K 3	2CDS273417R0317		0.42	3
	4	619783	S 203 U-K 4	2CDS273417R0337		0.42	3
	5	619790	S 203 U-K 5	2CDS273417R0357		0.42	3
	6	619806	S 203 U-K 6	2CDS273417R0377		0.42	3
	8	619813	S 203 U-K 8	2CDS273417R0407		0.42	3
	10	619820	S 203 U-K 10	2CDS273417R0427		0.42	3
	13	619837	S 203 U-K 13	2CDS273417R0447		0.42	3
	15	619844	S 203 U-K 15	2CDS273417R0457		0.42	3
	16	619851	S 203 U-K 16	2CDS273417R0467		0.42	3
	20	619868	S 203 U-K 20	2CDS273417R0487		0.42	3
25	619875	S 203 U-K 25	2CDS273417R0517		0.42	3	
30	619882	S 203 U-K 30	2CDS273417R0527		0.42	3	
32	619899	S 203 U-K 32	2CDS273417R0537		0.42	3	
40	619905	S 203 U-K 40	2CDS273417R0557		0.42	3	
50	619912	S 203 U-K 50	2CDS273417R0577		0.42	3	
60	619929	S 203 U-K 60	2CDS 273 417 R0587		0.42	3	
63	619936	S 203 U-K 63	2CDS 273 417 R0607		0.42	3	

Where to find more:
Worldwide Marks and Approvals of MCBs p.11/92

Frequently asked question - FAQ:
Where can I get certificates, declarations and CAD drawings?
You can find all of them on www.abb.com

Maybe you are also interested in:
Auxiliary Elements for S 200 MCBs according to UL p.4/14
Accessories for MCBs p.4/16
Busbar Systems p.4/21

MCBs

S 200 series U - UL range 10000 K characteristic



S 204 U

Number of poles	Rated current	Bbn 4016779	Order details		Price 1 piece	Weight 1 piece kg	Pack unit pc.
	In A	EAN	Type code	Order code			
4	0.2	619943	S 204 U-K 0.2	2CDS274417R0087		0.56	2
	0.3	619479	S 204 U-K 0.3	2CDS274417R0117		0.56	2
	0.5	619967	S 204 U-K 0.5	2CDS274417R0157		0.56	2
	0.75	619974	S 204 U-K 0.75	2CDS274417R0187		0.56	2
	1	619509	S 204 U-K 1	2CDS274417R0217		0.56	2
	1.6	619998	S 204 U-K 1.6	2CDS274417R0257		0.56	2
	2	620000	S 204 U-K 2	2CDS274417R0277		0.56	2
	3	620017	S 204 U-K 3	2CDS274417R0317		0.56	2
	4	620024	S 204 U-K 4	2CDS274417R0337		0.56	2
	5	620031	S 204 U-K 5	2CDS274417R0357		0.56	2
	6	620048	S 204 U-K 6	2CDS274417R0377		0.56	2
	8	620055	S 204 U-K 8	2CDS274417R0407		0.56	2
	10	620062	S 204 U-K 10	2CDS274417R0427		0.56	2
	13	620079	S 204 U-K 13	2CDS274417R0447		0.56	2
	15	620086	S 204 U-K 15	2CDS274417R0457		0.56	2
	16	620093	S 204 U-K 16	2CDS274417R0467		0.56	2
	20	620109	S 204 U-K 20	2CDS274417R0487		0.56	2
	25	620116	S 204 U-K 25	2CDS274417R0517		0.56	2
	30	620123	S 204 U-K 30	2CDS274417R0527		0.56	2
	32	620130	S 204 U-K 32	2CDS274417R0537		0.56	2
40	620147	S 204 U-K 40	2CDS274417R0557		0.56	2	
50	620154	S 204 U-K 50	2CDS274417R0577		0.56	2	
60	620161	S 204 U-K 60	2CDS274417R0587		0.56	2	
63	620178	S 204 U-K 63	2CDS274417R0607		0.56	2	

2

MCBs

S 200 series U - UL range 10000 Z characteristic



S 201 U



S 202 U

S 200 U-Z characteristic

Function: protection and control of the electronic circuits against lower and long duration overloads and short-circuits.

Applications: commercial and industrial.

Standard: IEC/EN 60947-2, UL 489, CSA 22.2 No. 5

Short-circuit current rating (SCCR acc. to UL 489): 10 kA

Number of poles	Rated current	Bbn 4016779	Order details		Price 1 piece	Weight 1 piece kg	Pack unit pc.
	In A	EAN	Type code	Order code			
1	0.5	620185	S 201 U-Z 0.5	2CDS271417R0158		0.14	10
	1	620192	S 201 U-Z 1	2CDS271417R0218		0.14	10
	1.6	620208	S 201 U-Z 1.6	2CDS271417R0258		0.14	10
	2	620215	S 201 U-Z 2	2CDS271417R0278		0.14	10
	3	620222	S 201 U-Z 3	2CDS271417R0318		0.14	10
	4	620239	S 201 U-Z 4	2CDS271417R0338		0.14	10
	5	620246	S 201 U-Z 5	2CDS271417R0358		0.14	10
	6	620253	S 201 U-Z 6	2CDS271417R0378		0.14	10
	8	620260	S 201 U-Z 8	2CDS271417R0408		0.14	10
	10	620277	S 201 U-Z 10	2CDS271417R0428		0.14	10
	15	620291	S 201 U-Z 15	2CDS271417R0458		0.14	10
	16	620307	S 201 U-Z 16	2CDS271417R0468		0.14	10
	20	620314	S 201 U-Z 20	2CDS271417R0488		0.14	10
	25	620321	S 201 U-Z 25	2CDS271417R0518		0.14	10
	30	622851	S 201 U-Z 30	2CDS271417R0528		0.14	10
	32	620345	S 201 U-Z 32	2CDS271417R0538		0.14	10
	40	620352	S 201 U-Z 40	2CDS271417R0558		0.14	10
50	620369	S 201 U-Z 50	2CDS271417R0578		0.14	10	
60	620376	S 201 U-Z 60	2CDS271417R0588		0.14	10	
63	620383	S 201 U-Z 63	2CDS271417R0608		0.14	10	

Number of poles	Rated current	Bbn 4016779	Order details		Price 1 piece	Weight 1 piece kg	Pack unit pc.
	In A	EAN	Type code	Order code			
2	0.5	620390	S 202 U-Z 0.5	2CDS272417R0158		0.28	5
	1	620406	S 202 U-Z 1	2CDS272417R0218		0.28	5
	1.6	620413	S 202 U-Z 1.6	2CDS272417R0258		0.28	5
	2	620420	S 202 U-Z 2	2CDS272417R0278		0.28	5
	3	620437	S 202 U-Z 3	2CDS272417R0318		0.28	5
	4	620444	S 202 U-Z 4	2CDS272417R0338		0.28	5
	5	620451	S 202 U-Z 5	2CDS272417R0358		0.28	5
	6	620468	S 202 U-Z 6	2CDS272417R0378		0.28	5
	8	620475	S 202 U-Z 8	2CDS272417R0408		0.28	5
	10	620482	S 202 U-Z 10	2CDS272417R0428		0.28	5
	15	620505	S 202 U-Z 15	2CDS272417R0458		0.28	5
	16	620512	S 202 U-Z 16	2CDS272417R0468		0.28	5
	20	620529	S 202 U-Z 20	2CDS272417R0488		0.28	5
	25	620536	S 202 U-Z 25	2CDS272417R0518		0.28	5
	30	620543	S 202 U-Z 30	2CDS272417R0528		0.28	5
	32	620550	S 202 U-Z 32	2CDS272417R0538		0.28	5
	40	620567	S 202 U-Z 40	2CDS272417R0558		0.28	5
50	620574	S 202 U-Z 50	2CDS272417R0578		0.28	5	
60	620581	S 202 U-Z 60	2CDS272417R0588		0.28	5	
63	620598	S 202 U-Z 63	2CDS272417R0608		0.28	5	

Where to find more:

Worldwide Marks and Approvals of MCBs p.11/92

Frequently asked question - FAQ:

Where can I get certificates, declarations and CAD drawings?

You can find all of them on www.abb.com

Maybe you are also interested in:

Auxiliary Elements for S 200 MCBs

according to UL p.4/14

Accessories for MCBs p.4/16

Busbar Systems p.4/21

MCBs

S 200 series U - UL range 10000 Z characteristic



S 203 U



S 204 U

Number of poles	Rated current	Bbn 4016779	Order details		Price 1 piece	Weight 1 piece kg	Pack unit pc.
	In A	EAN	Type code	Order code			
3	0.5	620604	S 203 U-Z 0.5	2CDS273417R0158		0.42	3
	1	620611	S 203 U-Z 1	2CDS273417R0218		0.42	3
	1.6	620628	S 203 U-Z 1.6	2CDS273417R0258		0.42	3
	2	620635	S 203 U-Z 2	2CDS273417R0278		0.42	3
	3	620624	S 203 U-Z 3	2CDS273417R0318		0.42	3
	4	620659	S 203 U-Z 4	2CDS273417R0338		0.42	3
	5	620666	S 203 U-Z 5	2CDS273417R0358		0.42	3
	6	620673	S 203 U-Z 6	2CDS273417R0378		0.42	3
	8	620680	S 203 U-Z 8	2CDS273417R0408		0.42	3
	10	620697	S 203 U-Z 10	2CDS273417R0428		0.42	3
	15	620710	S 203 U-Z 15	2CDS273417R0458		0.42	3
	16	620727	S 203 U-Z 16	2CDS273417R0468		0.42	3
	20	620734	S 203 U-Z 20	2CDS273417R0488		0.42	3
	25	620741	S 203 U-Z 25	2CDS273417R0518		0.42	3
	30	620758	S 203 U-Z 30	2CDS273417R0528		0.42	3
	32	620765	S 203 U-Z 32	2CDS273417R0538		0.42	3
	40	620772	S 203 U-Z 40	2CDS273417R0558		0.42	3
	50	620789	S 203 U-Z 50	2CDS273417R0578		0.42	3
	60	620796	S 203 U-Z 60	2CDS273417R0588		0.42	3
	63	620802	S 203 U-Z 63	2CDS273417R0608		0.42	3

2

Number of poles	Rated current	Bbn 4016779	Order details		Price 1 piece	Weight 1 piece kg	Pack unit pc.
	In A	EAN	Type code	Order code			
4	0.5	620819	S 204 U-Z 0.5	2CDS274417R0158		0.56	2
	1	620826	S 204 U-Z 1	2CDS274417R0218		0.56	2
	1.6	620833	S 204 U-Z 1.6	2CDS274417R0258		0.56	2
	2	620840	S 204 U-Z 2	2CDS274417R0278		0.56	2
	3	620857	S 204 U-Z 3	2CDS274417R0318		0.56	2
	4	620864	S 204 U-Z 4	2CDS274417R0338		0.56	2
	5	620871	S 204 U-Z 5	2CDS274417R0358		0.56	2
	6	620888	S 204 U-Z 6	2CDS274417R0378		0.56	2
	8	620895	S 204 U-Z 8	2CDS274417R0408		0.56	2
	10	620901	S 204 U-Z 10	2CDS274417R0428		0.56	2
	15	620925	S 204 U-Z 15	2CDS274417R0458		0.56	2
	16	620932	S 204 U-Z 16	2CDS274417R0468		0.56	2
	20	620949	S 204 U-Z 20	2CDS274417R0488		0.56	2
	25	620956	S 204 U-Z 25	2CDS274417R0518		0.56	2
	30	620963	S 204 U-Z 30	2CDS274417R0528		0.56	2
	32	620970	S 204 U-Z 32	2CDS274417R0538		0.56	2
	40	620987	S 204 U-Z 40	2CDS274417R0558		0.56	2
	50	620994	S 204 U-Z 50	2CDS274417R0578		0.56	2
	60	621007	S 204 U-Z 60	2CDS274417R0588		0.56	2
	63	621014	S 204 U-Z 63	2CDS274417R0608		0.56	2

MCBs

S 200 series UP - UL range 10000 C characteristic

2



S 201 UP



S 202 UP

S 200 UP-C characteristic

Function: protection and control of the circuits like motors, transformers and auxiliary circuits, against overloads and short-circuits.

Advantages: no nuisance tripping in the case of functional peak currents up to 10xI_n, depending on the series; through its highly sensitive thermostatic bimetal trip, the C-type characteristic offers protection to damageable elements in the overcurrent range; it also provides the best protection to cables and lines.

Applications: commercial and industrial.

Standard: IEC/EN 60947-2, UL 489, CSA 22.2 No. 5

Short-circuit current rating (SCCR acc. to UL 489): 10 kA

Number of poles	Rated current	Bbn 4016779	Order details		Price 1 piece	Weight 1 piece kg	Pack unit pc.
	In A	EAN	Type code	Order code			
1	0,5	4016779862462	S201UP-C0,5	2CDS271317R0984		0,140	10
	1	4016779862486	S201UP-C1	2CDS271317R0014		0,140	10
	1,6	4016779862493	S201UP-C1,6	2CDS271317R0974		0,140	10
	2	4016779862509	S201UP-C2	2CDS271317R0024		0,140	10
	3	4016779862516	S201UP-C3	2CDS271317R0034		0,140	10
	4	4016779862523	S201UP-C4	2CDS271317R0044		0,140	10
	5	4016779862530	S201UP-C5	2CDS271317R0054		0,140	10
	6	4016779862547	S201UP-C6	2CDS271317R0064		0,140	10
	8	4016779862554	S201UP-C8	2CDS271317R0084		0,140	10
	10	4016779862561	S201UP-C10	2CDS271317R0104		0,140	10
	13	4016779862578	S201UP-C13	2CDS271317R0134		0,140	10
	15	4016779862585	S201UP-C15	2CDS271317R0154		0,140	10
	16	4016779862592	S201UP-C16	2CDS271317R0164		0,140	10
	20	4016779862608	S201UP-C20	2CDS271317R0204		0,140	10
	25	4016779862615	S201UP-C25	2CDS271317R0254		0,140	10
2	0,5	4016779862622	S202UP-C0,5	2CDS272317R0984		0,280	5
	1	4016779862646	S202UP-C1	2CDS272317R0014		0,280	5
	1,6	4016779862653	S202UP-C1,6	2CDS272317R0974		0,280	5
	2	4016779862660	S202UP-C2	2CDS272317R0024		0,280	5
	3	4016779862677	S202UP-C3	2CDS272317R0034		0,280	5
	4	4016779862684	S202UP-C4	2CDS272317R0044		0,280	5
	5	4016779862691	S202UP-C5	2CDS272317R0054		0,280	5
	6	4016779862707	S202UP-C6	2CDS272317R0064		0,280	5
	8	4016779862714	S202UP-C8	2CDS272317R0084		0,280	5
	10	4016779862721	S202UP-C10	2CDS272317R0104		0,280	5
	13	4016779862738	S202UP-C13	2CDS272317R0134		0,280	5
	15	4016779862745	S202UP-C15	2CDS272317R0154		0,280	5
	16	4016779862752	S202UP-C16	2CDS272317R0164		0,280	5
	20	4016779862769	S202UP-C20	2CDS272317R0204		0,280	5
	25	4016779862776	S202UP-C25	2CDS272317R0254		0,280	5

Where to find more:
Worldwide Marks and Approvals of MCBs p.11/92

Frequently asked question - FAQ:
Where can I get certificates, declarations and CAD drawings?
You can find all of them on www.abb.com

Maybe you are also interested in:
Auxiliary Elements for S 200 MCBs according to UL p.4/14
Accessories for MCBs p.4/16
Busbar Systems p.4/21

MCBs

S 200 series UP - UL range 10000 K characteristic



S 203 UP

2CSC400021R0201



S 204 UP

2CSC400021R0201

Number of poles	Rated current	Bbn 4016779	Order details		Price 1 piece	Weight 1 piece kg	Pack unit pc.	
	In A	EAN	Type code	Order code				
3	0,5	4016779862783	S203UP-C0,5	2CDS273317R0984		0,420	3	
	1	4016779862806	S203UP-C1	2CDS273317R0014		0,420	3	
	1,6	4016779862813	S203UP-C1,6	2CDS273317R0974		0,420	3	
	2	4016779862820	S203UP-C2	2CDS273317R0024		0,420	3	
	3	4016779862837	S203UP-C3	2CDS273317R0034		0,420	3	
	4	4016779862844	S203UP-C4	2CDS273317R0044		0,420	3	
	5	4016779862851	S203UP-C5	2CDS273317R0054		0,420	3	
	6	4016779862868	S203UP-C6	2CDS273317R0064		0,420	3	
	8	4016779862875	S203UP-C8	2CDS273317R0084		0,420	3	
	10	4016779862882	S203UP-C10	2CDS273317R0104		0,420	3	
	13	4016779862899	S203UP-C13	2CDS273317R0134		0,420	3	
	15	4016779862905	S203UP-C15	2CDS273317R0154		0,420	3	
	16	4016779862912	S203UP-C16	2CDS273317R0164		0,420	3	
	20	4016779862929	S203UP-C20	2CDS273317R0204		0,420	3	
	25	4016779862936	S203UP-C25	2CDS273317R0254		0,420	3	
	4	0,5	4016779862943	S204UP-C0,5	2CDS274317R0984		0,560	2
		1	4016779862967	S204UP-C1	2CDS274317R0014		0,560	2
1,6		4016779862974	S204UP-C1,6	2CDS274317R0974		0,560	2	
2		4016779862981	S204UP-C2	2CDS274317R0024		0,560	2	
3		4016779862998	S204UP-C3	2CDS274317R0034		0,560	2	
4		4016779863001	S204UP-C4	2CDS274317R0044		0,560	2	
5		4016779863018	S204UP-C5	2CDS274317R0054		0,560	2	
6		4016779863025	S204UP-C6	2CDS274317R0064		0,560	2	
8		4016779863032	S204UP-C8	2CDS274317R0084		0,560	2	
10		4016779863049	S204UP-C10	2CDS274317R0104		0,560	2	
13		4016779863056	S204UP-C13	2CDS274317R0134		0,560	2	
15		4016779863063	S204UP-C15	2CDS274317R0154		0,560	2	
16		4016779863070	S204UP-C16	2CDS274317R0164		0,560	2	
20		4016779863087	S204UP-C20	2CDS274317R0204		0,560	2	
25		4016779863094	S204UP-C25	2CDS274317R0254		0,560	2	

2

MCBs

S 200 series UP - UL range 10000 K characteristic



S 201 UP



S 202 UP

S 200 UP-K characteristic

Function: protection and control of the circuits like motors, transformers and auxiliary circuits, against overloads and short-circuits.

Advantages: no nuisance tripping in the case of functional peak currents up to 10xI_n, depending on the series; through its highly sensitive thermostatic bimetal trip, the K-type characteristic offers protection to damageable elements in the overcurrent range; it also provides the best protection to cables and lines.

Applications: commercial and industrial.

Standard: IEC/EN 60947-2, UL 489, CSA 22.2 No. 5

Short-circuit current rating (SCCR acc. to UL 489): 10 kA

Number of poles	Rated current	Bbn 4016779	Order details		Price 1 piece	Weight 1 piece	Pack unit
	In A	EAN	Type code	Order code			
1	0.2	615631	S 201 UP-K 0.2	2CDS271317R0087		0.14	10
	0.3	615648	S 201 UP-K 0.3	2CDS271317R0117		0.14	10
	0.5	615655	S 201 UP-K 0.5	2CDS271317R0157		0.14	10
	0.75	615662	S 201 UP-K 0.75	2CDS271317R0187		0.14	10
	1	615679	S 201 UP-K 1	2CDS271317R0217		0.14	10
	1.6	615686	S 201 UP-K 1.6	2CDS271317R0257		0.14	10
	2	615693	S 201 UP-K 2	2CDS271317R0277		0.14	10
	3	615709	S 201 UP-K 3	2CDS271317R0317		0.14	10
	4	615716	S 201 UP-K 4	2CDS271317R0337		0.14	10
	5	615723	S 201 UP-K 5	2CDS271317R0357		0.14	10
	6	615730	S 201 UP-K 6	2CDS271317R0377		0.14	10
	8	615747	S 201 UP-K 8	2CDS271317R0407		0.14	10
	10	615754	S 201 UP-K 10	2CDS271317R0427		0.14	10
	13	615761	S 201 UP-K 13	2CDS271317R0447		0.14	10
	15	615778	S 201 UP-K 15	2CDS271317R0457		0.14	10
	16	615785	S 201 UP-K 16	2CDS271317R0467		0.14	10
20	615792	S 201 UP-K 20	2CDS271317R0487		0.14	10	
25	615808	S 201 UP-K 25	2CDS271317R0517		0.14	10	
2	0.2	615877	S 202 UP-K 0.2	2CDS272317R0087		0.28	5
	0.3	615884	S 202 UP-K 0.3	2CDS272317R0117		0.28	5
	0.5	615891	S 202 UP-K 0.5	2CDS272317R0157		0.28	5
	0.75	615907	S 202 UP-K 0.75	2CDS272317R0187		0.28	5
	1	615914	S 202 UP-K 1	2CDS272317R0217		0.28	5
	1.6	615921	S 202 UP-K 1.6	2CDS272317R0257		0.28	5
	2	615938	S 202 UP-K 2	2CDS272317R0277		0.28	5
	3	615945	S 202 UP-K 3	2CDS272317R0317		0.28	5
	4	615952	S 202 UP-K 4	2CDS272317R0337		0.28	5
	5	615969	S 202 UP-K 5	2CDS272317R0357		0.28	5
	6	615976	S 202 UP-K 6	2CDS272317R0377		0.28	5
	8	615983	S 202 UP-K 8	2CDS272317R0407		0.28	5
	10	615990	S 202 UP-K 10	2CDS272317R0427		0.28	5
	13	616003	S 202 UP-K 13	2CDS272317R0447		0.28	5
	15	616010	S 202 UP-K 15	2CDS272317R0457		0.28	5
	16	616027	S 202 UP-K 16	2CDS272317R0467		0.28	5
20	616034	S 202 UP-K 20	2CDS272317R0487		0.28	5	
25	616041	S 202 UP-K 25	2CDS272317R0517		0.28	5	

Where to find more:

Worldwide Marks and Approvals of MCBs p.11/92

Frequently asked question - FAQ:

Where can I get certificates, declarations and CAD drawings? You can find all of them on www.abb.com

Maybe you are also interested in:

Auxiliary Elements for S 200 MCBs according to UL p.4/14
Accessories for MCBs p.4/16
Busbar Systems p.4/21

MCBs

S 200 series UP - UL range 10000 K characteristic



S 203 UP

2CSC400021R0201



S 204 UP

2CSC400021R0201

Number of poles	Rated current	Bbn 4016779	Order details		Price 1 piece	Weight 1 piece kg	Pack unit pc.
	In A	EAN	Type code	Order code			
3	0.2	616119	S 203 UP-K 0.2	2CDS273317R0087		0.42	3
	0.3	616126	S 203 UP-K 0.3	2CDS273317R0117		0.42	3
	0.5	616133	S 203 UP-K 0.5	2CDS273317R0157		0.42	3
	0.75	616140	S 203 UP-K 0.75	2CDS273317R0187		0.42	3
	1	616157	S 203 UP-K 1	2CDS273317R0217		0.42	3
	1.6	616164	S 203 UP-K 1.6	2CDS273317R0257		0.42	3
	2	616171	S 203 UP-K 2	2CDS273317R0277		0.42	3
	3	616188	S 203 UP-K 3	2CDS273317R0317		0.42	3
	4	616195	S 203 UP-K 4	2CDS273317R0337		0.42	3
	5	616201	S 203 UP-K 5	2CDS273317R0357		0.42	3
	6	616218	S 203 UP-K 6	2CDS273317R0377		0.42	3
	8	616225	S 203 UP-K 8	2CDS273317R0407		0.42	3
	10	616232	S 203 UP-K 10	2CDS273317R0427		0.42	3
	13	616249	S 203 UP-K 13	2CDS273317R0447		0.42	3
	15	616256	S 203 UP-K 15	2CDS273317R0457		0.42	3
	16	616263	S 203 UP-K 16	2CDS273317R0467		0.42	3
	20	616270	S 203 UP-K 20	2CDS273317R0487		0.42	3
25	616287	S 203 UP-K 25	2CDS273317R0517		0.42	3	
4	0.2	616355	S 204 UP-K 0.2	2CDS274317R0087		0.56	2
	0.3	616362	S 204 UP-K 0.3	2CDS274317R0117		0.56	2
	0.5	616379	S 204 UP-K 0.5	2CDS274317R0157		0.56	2
	0.75	616386	S 204 UP-K 0.75	2CDS274317R0187		0.56	2
	1	616393	S 204 UP-K 1	2CDS274317R0217		0.56	2
	1.6	616409	S 204 UP-K 1.6	2CDS274317R0257		0.56	2
	2	616416	S 204 UP-K 2	2CDS274317R0277		0.56	2
	3	616423	S 204 UP-K 3	2CDS274317R0317		0.56	2
	4	616430	S 204 UP-K 4	2CDS274317R0337		0.56	2
	5	616447	S 204 UP-K 5	2CDS274317R0357		0.56	2
	6	616454	S 204 UP-K 6	2CDS274317R0377		0.56	2
	8	616461	S 204 UP-K 8	2CDS274317R0407		0.56	2
	10	616478	S 204 UP-K 10	2CDS274317R0427		0.56	2
	13	616485	S 204 UP-K 13	2CDS274317R0447		0.56	2
	15	616492	S 204 UP-K 15	2CDS274317R0457		0.56	2
	16	616508	S 204 UP-K 16	2CDS274317R0467		0.56	2
	20	616515	S 204 UP-K 20	2CDS274317R0487		0.56	2
25	616522	S 204 UP-K 25	2CDS274317R0517		0.56	2	

2

MCBs

S 200 series UP - UL range 10000 Z characteristic



S 201 UP



S 202 UP

S 200 UP-Z characteristic

Function: protection and control of the electronic circuits against lower and long duration overloads and short-circuits.

Applications: commercial and industrial.

Standard: IEC/EN 60947-2, UL 489, CSA 22.2 No. 5

Short-circuit current rating (SCCR acc. to UL 489): 10 kA

Number of poles	Rated current	Bbn 4016779	Order details		Price 1 piece	Weight 1 piece kg	Pack unit pc.
	In A	EAN	Type code	Order code			
1	0.5	616591	S 201 UP-Z 0.5	2CDS271317R0158		0.14	10
	1	616607	S 201 UP-Z 1	2CDS271317R0218		0.14	10
	1.6	616614	S 201 UP-Z 1.6	2CDS271317R0258		0.14	10
	2	616621	S 201 UP-Z 2	2CDS271317R0278		0.14	10
	3	616638	S 201 UP-Z 3	2CDS271317R0318		0.14	10
	4	616645	S 201 UP-Z 4	2CDS271317R0338		0.14	10
	5	616652	S 201 UP-Z 5	2CDS271317R0358		0.14	10
	6	616669	S 201 UP-Z 6	2CDS271317R0378		0.14	10
	8	616676	S 201 UP-Z 8	2CDS271317R0408		0.14	10
	10	616683	S 201 UP-Z 10	2CDS271317R0428		0.14	10
	13	616690	S 201 UP-Z 13	2CDS271317R0448		0.14	10
	15	616706	S 201 UP-Z 15	2CDS271317R0458		0.14	10
	16	616713	S 201 UP-Z 16	2CDS271317R0468		0.14	10
	20	616720	S 201 UP-Z 20	2CDS271317R0488		0.14	10
	25	616737	S 201 UP-Z 25	2CDS271317R0518		0.14	10
	2	0.5	616805	S 202 UP-Z 0.5	2CDS272317R0158		0.28
1		616812	S 202 UP-Z 1	2CDS272317R0218		0.28	5
1.6		616829	S 202 UP-Z 1.6	2CDS272317R0258		0.28	5
2		616836	S 202 UP-Z 2	2CDS272317R0278		0.28	5
3		616843	S 202 UP-Z 3	2CDS272317R0318		0.28	5
4		616850	S 202 UP-Z 4	2CDS272317R0338		0.28	5
5		616867	S 202 UP-Z 5	2CDS272317R0358		0.28	5
6		616874	S 202 UP-Z 6	2CDS272317R0378		0.28	5
8		616881	S 202 UP-Z 8	2CDS272317R0408		0.28	5
10		616898	S 202 UP-Z 10	2CDS272317R0428		0.28	5
13		616904	S 202 UP-Z 13	2CDS272317R0448		0.28	5
15		616911	S 202 UP-Z 15	2CDS272317R0458		0.28	5
16		616928	S 202 UP-Z 16	2CDS272317R0468		0.28	5
20		616935	S 202 UP-Z 20	2CDS272317R0488		0.28	5
25		616942	S 202 UP-Z 25	2CDS272317R0518		0.28	5

Where to find more:
Worldwide Marks and Approvals of MCBs p.11/92

Frequently asked question - FAQ:
Where can I get certificates, declarations and CAD drawings?
You can find all of them on www.abb.com

Maybe you are also interested in:
Auxiliary Elements for S 200 MCBs according to UL p.4/14
Accessories for MCBs p.4/16
Busbar Systems p.4/21

MCBs

S 200 series UP - UL range 10000 Z characteristic



S 203 UP

2CSC40002F0201



S 204 UP

2CSC40002F0201

Number of poles	Rated current	Bbn 4016779	Order details		Price 1 piece	Weight 1 piece kg	Pack unit pc.
	In A	EAN	Type code	Order code			
3	0.5	617017	S 203 UP-Z 0.5	2CDS273317R0158		0.42	3
	1	617024	S 203 UP-Z 1	2CDS273317R0218		0.42	3
	1.6	617031	S 203 UP-Z 1.6	2CDS273317R0258		0.42	3
	2	617048	S 203 UP-Z 2	2CDS273317R0278		0.42	3
	3	617055	S 203 UP-Z 3	2CDS273317R0318		0.42	3
	4	617062	S 203 UP-Z 4	2CDS273317R0338		0.42	3
	5	617079	S 203 UP-Z 5	2CDS273317R0358		0.42	3
	6	617086	S 203 UP-Z 6	2CDS273317R0378		0.42	3
	8	617093	S 203 UP-Z 8	2CDS273317R0408		0.42	3
	10	617109	S 203 UP-Z 10	2CDS273317R0428		0.42	3
	13	617116	S 203 UP-Z 13	2CDS273317R0448		0.42	3
	15	617123	S 203 UP-Z 15	2CDS273317R0458		0.42	3
	16	617130	S 203 UP-Z 16	2CDS273317R0468		0.42	3
	20	617147	S 203 UP-Z 20	2CDS273317R0488		0.42	3
	25	617154	S 203 UP-Z 25	2CDS273317R0518		0.42	3
	4	0.5	617222	S 204 UP-Z 0.5	2CDS274317R0158		0.56
1		617239	S 204 UP-Z 1	2CDS274317R0218		0.56	2
1.6		617246	S 204 UP-Z 1.6	2CDS274317R0258		0.56	2
2		617253	S 204 UP-Z 2	2CDS274317R0278		0.56	2
3		617260	S 204 UP-Z 3	2CDS274317R0318		0.56	2
4		617277	S 204 UP-Z 4	2CDS274317R0338		0.56	2
5		617284	S 204 UP-Z 5	2CDS274317R0358		0.56	2
6		617291	S 204 UP-Z 6	2CDS274317R0378		0.56	2
8		617307	S 204 UP-Z 8	2CDS274317R0408		0.56	2
10		617314	S 204 UP-Z 10	2CDS274317R0428		0.56	2
13		617321	S 204 UP-Z 13	2CDS274317R0448		0.56	2
15		617338	S 204 UP-Z 15	2CDS274317R0458		0.56	2
16		617345	S 204 UP-Z 16	2CDS274317R0468		0.56	2
20		617352	S 204 UP-Z 20	2CDS274317R0488		0.56	2
25		617369	S 204 UP-Z 25	2CDS274317R0518		0.56	2

2

MCBs

SU 200 series PR - UL range 10000 K characteristic



SU 201 PR

SU 200 PR-K characteristic

Function: protection and control of the circuits against overloads and short-circuits; protection for resistive and inductive loads with low inrush current. The integrated captive connecting screws simplify the connection of electric lines, provides extra protection and saves time.

Applications: commercial and industrial.

Standard: IEC/EN 60947-2, UL489, CSA 22.2 No. 5

SCCR: 10 kA

Number of poles	Rated current	Bbn 4016779	Order details		Price 1 piece	Weight 1 piece kg	Pack unit pc.
	In A	EAN	Type code	Order code			
1	0.2	9847865	SU201PR-K0.2	2CDS271327R0087		0.140	10
	0.3	9847872	SU201PR-K0.3	2CDS271327R0117		0.140	10
	0.5	9847889	SU201PR-K0.5	2CDS271327R0157		0.140	10
	0.75	9847896	SU201PR-K0.75	2CDS271327R0187		0.140	10
	1	9847902	SU201PR-K1	2CDS271327R0217		0.140	10
	1.6	9847919	SU201PR-K1.6	2CDS271327R0257		0.140	10
	2	9847926	SU201PR-K2	2CDS271327R0277		0.140	10
	3	9847933	SU201PR-K3	2CDS271327R0317		0.140	10
	4	9847940	SU201PR-K4	2CDS271327R0337		0.140	10
	5	9847957	SU201PR-K5	2CDS271327R0357		0.140	10
	6	9847964	SU201PR-K6	2CDS271327R0377		0.140	10
	8	9847971	SU201PR-K8	2CDS271327R0407		0.140	10
	10	9847988	SU201PR-K10	2CDS271327R0427		0.140	10
	13	9847995	SU201PR-K13	2CDS271327R0447		0.140	10
	15	9848008	SU201PR-K15	2CDS271327R0457		0.140	10
	16	9848015	SU201PR-K16	2CDS271327R0467		0.140	10
	20	9848022	SU201PR-K20	2CDS271327R0487		0.140	10
	25	9848039	SU201PR-K25	2CDS271327R0517		0.140	10
	30	9848046	SU201PR-K30	2CDS271327R0527		0.140	10
	32	9848053	SU201PR-K32	2CDS271327R0537		0.140	10
35	9848060	SU201PR-K35	2CDS271327R0547		0.140	10	
40	9848077	SU201PR-K40	2CDS271327R0557		0.140	10	
50	9848084	SU201PR-K50	2CDS271327R0577		0.140	10	
60	9848091	SU201PR-K60	2CDS271327R0587		0.140	10	
63	9848107	SU201PR-K63	2CDS271327R0607		0.140	10	

Where to find more:

Worldwide Marks and Approvals of MCBs p.11/92

Frequently asked question - FAQ:

Where can I get certificates, declarations and CAD drawings?

You can find all of them on www.abb.com

Maybe you are also interested in:

Auxiliary Elements for S 200 MCBs

according to UL p.4/14

Accessories for MCBs p.4/16

Busbar Systems p.4/21

MCBs

SU 200 series PR - UL range 10000 K characteristic



SU 202 PR

2CDS272327R012

Number of poles	Rated current	Bbn 4016779	Order details		Price 1 piece	Weight 1 piece	Pack unit
	In A	EAN	Type code	Order code			
2	0.2	9848114	SU202PR-K0.2	2CDS272327R0087		0.280	5
	0.3	9848121	SU202PR-K0.3	2CDS272327R0117		0.280	5
	0.5	9848138	SU202PR-K0.5	2CDS272327R0157		0.280	5
	0.75	9848145	SU202PR-K0.75	2CDS272327R0187		0.280	5
	1	9848152	SU202PR-K1	2CDS272327R0217		0.280	5
	1.6	9848169	SU202PR-K1.6	2CDS272327R0257		0.280	5
	2	9848176	SU202PR-K2	2CDS272327R0277		0.280	5
	3	9848183	SU202PR-K3	2CDS272327R0317		0.280	5
	4	9848190	SU202PR-K4	2CDS272327R0337		0.280	5
	5	9848206	SU202PR-K5	2CDS272327R0357		0.280	5
	6	9848213	SU202PR-K6	2CDS272327R0377		0.280	5
	8	9848220	SU202PR-K8	2CDS272327R0407		0.280	5
	10	9848237	SU202PR-K10	2CDS272327R0427		0.280	5
	13	9848244	SU202PR-K13	2CDS272327R0447		0.280	5
	15	9848251	SU202PR-K15	2CDS272327R0457		0.280	5
	16	9848268	SU202PR-K16	2CDS272327R0467		0.280	5
	20	9848275	SU202PR-K20	2CDS272327R0487		0.280	5
	25	9848282	SU202PR-K25	2CDS272327R0517		0.280	5
	30	9848299	SU202PR-K30	2CDS272327R0527		0.280	5
	32	9848305	SU202PR-K32	2CDS272327R0537		0.280	5
35	9848312	SU202PR-K35	2CDS272327R0547		0.280	5	
40	9848329	SU202PR-K40	2CDS272327R0557		0.280	5	
50	9848336	SU202PR-K50	2CDS272327R0577		0.280	5	
60	9848343	SU202PR-K60	2CDS272327R0587		0.280	5	
63	9848350	SU202PR-K63	2CDS272327R0607		0.280	5	

2

MCBs

SU 200 series PR - UL range 10000 K characteristic

2



SU 203 PR



SU 204 PR

Number of poles	Rated current	Bbn 4016779	Order details		Price 1 piece	Weight 1 piece kg	Pack unit pc.
	In A	EAN	Type code	Order code			
3	0.2	9848367	SU203PR-K0.2	2CDS273327R0087		0.420	3
	0.3	9848374	SU203PR-K0.3	2CDS273327R0117		0.420	3
	0.5	9848381	SU203PR-K0.5	2CDS273327R0157		0.420	3
	0.75	9848398	SU203PR-K0.75	2CDS273327R0187		0.420	3
	1	9848404	SU203PR-K1	2CDS273327R0217		0.420	3
	1.6	9848411	SU203PR-K1.6	2CDS273327R0257		0.420	3
	2	9848428	SU203PR-K2	2CDS273327R0277		0.420	3
	3	9848435	SU203PR-K3	2CDS273327R0317		0.420	3
	4	9848442	SU203PR-K4	2CDS273327R0337		0.420	3
	5	9848459	SU203PR-K5	2CDS273327R0357		0.420	3
	6	9848466	SU203PR-K6	2CDS273327R0377		0.420	3
	8	9848473	SU203PR-K8	2CDS273327R0407		0.420	3
	10	9848480	SU203PR-K10	2CDS273327R0427		0.420	3
	13	9848497	SU203PR-K13	2CDS273327R0447		0.420	3
	15	9848503	SU203PR-K15	2CDS273327R0457		0.420	3
	16	9848510	SU203PR-K16	2CDS273327R0467		0.420	3
	20	9848527	SU203PR-K20	2CDS273327R0487		0.420	3
	25	9848534	SU203PR-K25	2CDS273327R0517		0.420	3
	30	9848541	SU203PR-K30	2CDS273327R0527		0.420	3
	32	9848558	SU203PR-K32	2CDS273327R0537		0.420	3
	35	9848565	SU203PR-K35	2CDS273327R0547		0.420	3
	40	9848572	SU203PR-K40	2CDS273327R0557		0.420	3
	50	9848589	SU203PR-K50	2CDS273327R0577		0.420	3
	60	9848596	SU203PR-K60	2CDS273327R0587		0.420	3
	63	9848602	SU203PR-K63	2CDS273327R0607		0.420	3
	4	0.2	9848619	SU204PR-K0.2	2CDS274327R0087		0.560
0.3		9848626	SU204PR-K0.3	2CDS274327R0117		0.560	2
0.5		9848633	SU204PR-K0.5	2CDS274327R0157		0.560	2
0.75		9848640	SU204PR-K0.75	2CDS274327R0187		0.560	2
1		9848657	SU204PR-K1	2CDS274327R0217		0.560	2
1.6		9848664	SU204PR-K1.6	2CDS274327R0257		0.560	2
2		9848671	SU204PR-K2	2CDS274327R0277		0.560	2
3		9848688	SU204PR-K3	2CDS274327R0317		0.560	2
4		9848695	SU204PR-K4	2CDS274327R0337		0.560	2
5		9848701	SU204PR-K5	2CDS274327R0357		0.560	2
6		9848718	SU204PR-K6	2CDS274327R0377		0.560	2
8		9848725	SU204PR-K8	2CDS274327R0407		0.560	2
10		9848732	SU204PR-K10	2CDS274327R0427		0.560	2
13		9848749	SU204PR-K13	2CDS274327R0447		0.560	2
15		9848756	SU204PR-K15	2CDS274327R0457		0.560	2
16		9848763	SU204PR-K16	2CDS274327R0467		0.560	2
20		9848770	SU204PR-K20	2CDS274327R0487		0.560	2
25		9848787	SU204PR-K25	2CDS274327R0517		0.560	2
30		9848794	SU204PR-K30	2CDS274327R0527		0.560	2
32		9848800	SU204PR-K32	2CDS274327R0537		0.560	2
35		9848817	SU204PR-K35	2CDS274327R0547		0.560	2
40		9848824	SU204PR-K40	2CDS274327R0557		0.560	2
50		9848831	SU204PR-K50	2CDS274327R0577		0.560	2
60		9848848	SU204PR-K60	2CDS274327R0587		0.560	2
63		9848855	SU204PR-K63	2CDS274327R0607		0.560	2

Where to find more:
Worldwide Marks and Approvals of MCBs p.11/92

Frequently asked question - FAQ:
Where can I get certificates, declarations and CAD drawings?
You can find all of them on www.abb.com

Maybe you are also interested in:
Auxiliary Elements for S 200 MCBs according to UL p.4/14
Accessories for MCBs p.4/16
Busbar Systems p.4/21

MCBs

S 200 series UDC - Universal current range, UL, K characteristic



S 201 UDC

2CDC 021 126 F0010

S 200 UDC-K characteristic

Function: protection and control of the circuits like motors, transformers and auxiliary circuits, against overloads and short-circuits.

Advantages: no nuisance tripping in the case of functional peak currents up to $10 \times I_n$, depending on the series; through its highly sensitive thermostatic bimetal trip, the K-type characteristic offers protection to damageable elements in the overcurrent range; it also provides the best protection to cables and lines.

Applications: commercial and industrial.

Standard: UL 489, CSA 22.2 No. 5

(only DC, please note polarity of device)

Short-circuit current rating (SCCR acc. to UL 489): 14 kA

2

Number of poles	Rated current	Bbn 4016779	Order details		Price 1 piece	Weight 1 piece kg	Pack unit pc.
	In A	EAN	Type code	Order code			
1	1	825924	S 201 UDC-K 1	2CDS271517R0217		0.150	10
	1,6	825948	S 201 UDC-K 1.6	2CDS271517R0257		0.150	10
	2	825955	S 201 UDC-K 2	2CDS271517R0277		0.150	10
	3	825962	S 201 UDC-K 3	2CDS271517R0317		0.150	10
	4	825979	S 201 UDC-K 4	2CDS271517R0337		0.150	10
	5	825986	S 201 UDC-K 5	2CDS271517R0357		0.150	10
	6	825993	S 201 UDC-K 6	2CDS271517R0377		0.150	10
	8	826006	S 201 UDC-K 8	2CDS271517R0407		0.150	10
	10	826013	S 201 UDC-K 10	2CDS271517R0427		0.150	10
	13	826020	S 201 UDC-K 13	2CDS271517R0447		0.150	10
	15	826037	S 201 UDC-K 15	2CDS271517R0457		0.150	10
	16	826044	S 201 UDC-K 16	2CDS271517R0467		0.150	10
	20	826051	S 201 UDC-K 20	2CDS271517R0487		0.150	10
	25	826068	S 201 UDC-K 25	2CDS271517R0517		0.150	10
	30	826075	S 201 UDC-K 30	2CDS271517R0527		0.150	10
	32	826082	S 201 UDC-K 32	2CDS271517R0537		0.150	10
	40	826099	S 201 UDC-K 40	2CDS271517R0557		0.150	10
	50	826105	S 201 UDC-K 50	2CDS271517R0577		0.150	10
	60	826112	S 201 UDC-K 60	2CDS271517R0587		0.150	10
63	826129	S 201 UDC-K 63	2CDS271517R0607		0.150	10	

MCBs

S 200 series UDC - Universal current range, UL, K characteristic



S 202 UDC

Number of poles	Rated current	Bbn 4016779	Order details		Price 1 piece	Weight 1 piece kg	Pack unit pc.
	In A	EAN	Type code	Order code			
2	1	825061	S 202 UDC-K 1	2CDS272517R0217		0.300	5
	1,6	825160	S 202 UDC-K 1.6	2CDS272517R0257		0.300	5
	2	825177	S 202 UDC-K 2	2CDS272517R0277		0.300	5
	3	825184	S 202 UDC-K 3	2CDS272517R0317		0.300	5
	4	825191	S 202 UDC-K 4	2CDS272517R0337		0.300	5
	5	825207	S 202 UDC-K 5	2CDS272517R0357		0.300	5
	6	825214	S 202 UDC-K 6	2CDS272517R0377		0.300	5
	8	825221	S 202 UDC-K 8	2CDS272517R0407		0.300	5
	10	825238	S 202 UDC-K 10	2CDS272517R0427		0.300	5
	13	825245	S 202 UDC-K 13	2CDS272517R0447		0.300	5
	15	825252	S 202 UDC-K 15	2CDS272517R0457		0.300	5
	16	825269	S 202 UDC-K 16	2CDS272517R0467		0.300	5
	20	825276	S 202 UDC-K 20	2CDS272517R0487		0.300	5
	25	825283	S 202 UDC-K 25	2CDS272517R0517		0.300	5
	30	825290	S 202 UDC-K 30	2CDS272517R0527		0.300	5
	32	825306	S 202 UDC-K 32	2CDS272517R0537		0.300	5
	40	825313	S 202 UDC-K 40	2CDS272517R0557		0.300	5
	50	825320	S 202 UDC-K 50	2CDS272517R0577		0.300	5
	60	825337	S 202 UDC-K 60	2CDS272517R0587		0.300	5
63	825344	S 202 UDC-K 63	2CDS272517R0607		0.300	5	

Where to find more:

Worldwide Marks and Approvals of MCBs p.11/92

Frequently asked question - FAQ:

Where can I get certificates, declarations and CAD drawings?
You can find all of them on www.abb.com

Maybe you are also interested in:

Auxiliary Elements for S 200 MCBs according to UL p.4/14
Accessories for MCBs p.4/16
Busbar Systems p.4/21

MCBs

S 200 series UDC - Universal current range, UL, Z characteristic



S 201 UDC



S 202 UDC

S 200 UDC-Z characteristic

Function: protection and control of the electronic circuits against lower and long duration overloads and short-circuits.

Applications: commercial and industrial.

Standard: UL 489, CSA 22.2 No. 5

(only DC, please note polarity of device)

Short-circuit current rating (SCCR acc. to UL 489): 14 kA

2

Number of poles	Rated current	Bbn 4016779	Order details		Price 1 piece	Weight 1 piece kg	Pack unit pc.
	In A	EAN	Type code	Order code			
1	1	826136	S 201 UDC-Z 1	2CDS271517R0218		0.150	10
	1,6	826143	S 201 UDC-Z 1.6	2CDS271517R0258		0.150	10
	2	826150	S 201 UDC-Z 2	2CDS271517R0278		0.150	10
	3	826167	S 201 UDC-Z 3	2CDS271517R0318		0.150	10
	4	826174	S 201 UDC-Z 4	2CDS271517R0338		0.150	10
	5	826181	S 201 UDC-Z 5	2CDS271517R0358		0.150	10
	6	826198	S 201 UDC-Z 6	2CDS271517R0378		0.150	10
	8	826204	S 201 UDC-Z 8	2CDS271517R0408		0.150	10
	10	826211	S 201 UDC-Z 10	2CDS271517R0428		0.150	10
	15	826228	S 201 UDC-Z 15	2CDS271517R0458		0.150	10
	16	826235	S 201 UDC-Z 16	2CDS271517R0468		0.150	10
	20	826242	S 201 UDC-Z 20	2CDS271517R0488		0.150	10
	25	826259	S 201 UDC-Z 25	2CDS271517R0518		0.150	10
	30	826266	S 201 UDC-Z 30	2CDS271517R0528		0.150	10
	32	826273	S 201 UDC-Z 32	2CDS271517R0538		0.150	10
	40	826280	S 201 UDC-Z 40	2CDS271517R0558		0.150	10
	50	826297	S 201 UDC-Z 50	2CDS271517R0578		0.150	10
60	826303	S 201 UDC-Z 60	2CDS271517R0588		0.150	10	
63	826310	S 201 UDC-Z 63	2CDS271517R0608		0.150	10	

Number of poles	Rated current	Bbn 4016779	Order details		Price 1 piece	Weight 1 piece kg	Pack unit pc.
	In A	EAN	Type code	Order code			
2	1	825351	S 202 UDC-Z 1	2CDS272517R0218		0.300	5
	1,6	825368	S 202 UDC-Z 1.6	2CDS272517R0258		0.300	5
	2	825375	S 202 UDC-Z 2	2CDS272517R0278		0.300	5
	3	825382	S 202 UDC-Z 3	2CDS272517R0318		0.300	5
	4	825399	S 202 UDC-Z 4	2CDS272517R0338		0.300	5
	5	825405	S 202 UDC-Z 5	2CDS272517R0358		0.300	5
	6	825412	S 202 UDC-Z 6	2CDS272517R0378		0.300	5
	8	825429	S 202 UDC-Z 8	2CDS272517R0408		0.300	5
	10	825436	S 202 UDC-Z 10	2CDS272517R0428		0.300	5
	15	825443	S 202 UDC-Z 15	2CDS272517R0458		0.300	5
	16	825450	S 202 UDC-Z 16	2CDS272517R0468		0.300	5
	20	825467	S 202 UDC-Z 20	2CDS272517R0488		0.300	5
	25	825474	S 202 UDC-Z 25	2CDS272517R0518		0.300	5
	30	825481	S 202 UDC-Z 30	2CDS272517R0528		0.300	5
	32	825498	S 202 UDC-Z 32	2CDS272517R0538		0.300	5
	40	825504	S 202 UDC-Z 40	2CDS272517R0558		0.300	5
	50	825511	S 202 UDC-Z 50	2CDS272517R0578		0.300	5
60	825528	S 202 UDC-Z 60	2CDS272517R0588		0.300	5	
63	825535	S 202 UDC-Z 63	2CDS272517R0608		0.300	5	

MCB SN 201. The details make the difference

A range designed to ensure efficiency and protection

Easy wiring with
1P+N busbars

2

Quick identification
thanks to laser
printed EAN
marking.

Easy identification
of the product and
highly resistant
laser marking.

Contact position
indicator on the
level, with Green/
Red indicator

A wide range of
accessories is
available

Label carrier for
easy identification

1P+N protection in
only one module





2

Space for insulated screwdrivers: the larger neutral hole allows the use of an insulated screwdriver to tighten the screws of both wire terminals, ensuring maximum safety of the operation.

Two bistable fixing devices for maximum ease of use: due to larger size of the DIN rail fixing system, made with 2 bistable fixing devices, the same screwdriver used for tightening the terminals can also be used for assembling and disassembling the device.



With the practical label carrier fitted in the new SN201 circuit-breakers you can give maximum visibility to the information relating to the protected loads.

The SN201 fully integrates with the range of System pro M compact® miniature circuit-breakers, sharing the wide selection of accessories available through a dedicated interface (half module), which also can be used as auxiliary contact.

Miniature circuit breakers

SN 201 series - 1P+N in one module housing

2



SN 201

General Data	Standards	
	Poles	
	Tripping characteristics	
	Rated current I_n	A
	Rated frequency f	Hz
	Rated insulation voltage U acc. to DIN EN 60664-1	V
	Overtoltage category	
	Pollution degree	
Data acc. to IEC/EN 60898-1	Rated operational voltage U_n	V
	Max. power frequency recovery voltage (U_{rrv})	V
	Min. operating voltage	V
	Rated short-circuit capacity I_{cs}	kA
	Rated making and breaking capacity of one individual pole I_{cm}	kA
	Energy limiting class (B, C up to 40A)	
	Rated impulse withstand voltage U_{imp} (1.2/50 μ s)	kV
	Dielectric test voltage	kV
	Reference temperature for tripping characteristics	°C
	Electrical endurance	operations
	Data acc. to IEC/EN 60947-2	Rated ultimate short-circuit breaking capacity I_{cu}
Rated service short-circuit breaking capacity I_{cs}		kA
Mechanical Data	Housing	
	Toggle	
	Contact position indication	
	Protection degree acc. to EN 60529	
	Mechanical endurance	operations
	Shock resistance acc. to IEC/EN 60068-2-27	
	Vibration resistance acc. to IEC/EN 60068-2-6	
	Environmental conditions (damp heat) acc. to IEC/EN 60068-2-30	°C/RH
	Ambient temperature (with daily average $\leq +35^\circ\text{C}$)	°C
	Storage temperature	°C
Installation	Cross-section of conductors (top/bottom) Stranded / Solid	mm ²
	Cross-section of conductors (top/bottom) Flexible	mm ²
	Tightening Torque	Nm
	Mounting	
	Mounting Position	
Dimensions and weight	Supply	
	Pole dimensions (H x D x W)	mm
Combination with aux. elements	Pole weight	g
	Auxiliary contact	
	Signal contact/auxiliary switch	
	Shunt trip	
	Undervoltage release	

① SN201 and SN201M series in B and D characteristic are available for rated current $I_n \geq 6$ A

SN 201 L	SN 201	SN 201 M
IEC/EN 60898		
1P + N		
B, C	B, C, D	B, C
2...40 A Ⓞ		
50 / 60 Hz		
500 V AC		
III		
2		
230 V AC		
254 V AC 1P: 60 V DC 1P+N: 125 V DC		
12 V AC - 12 V DC		
4.5 kA	6 kA	10 kA
4.5 kA	6 kA	6 kA
3		
4 kV (test voltage 6,2kV at sea level, 5kV at 2000m)		
2.5 kV (50 / 60Hz, 1 min.)		
30°C		
10.000 operations		
6 kA	10 kA	10 kA
4.5 kA	6 kA	7.5 kA
Insulation group II, RAL 7035		
Insulation group IIIA, black, sealable in ON/OFF positions		
Marking on toggle (I ON / 0 OFF)		
Housing: IP4X; Terminals: IP2X		
20.000 operations		
30 g - 2 shocks - 13 ms		
0,35mm or 5g - 20 cycles at 5...150...5 Hz without load		
28 cycles with 55°C/90-96% and 25°C/95-100%		
-25 ... +55°C		
-40 ... +70°C		
16 mm ² / 16 mm ²		
10 mm ² / 10 mm ²		
1.2 Nm		
On DIN rail 35 mm acc. to EN 60715 by fast clip		
any		
optional (supply from top/bottom)		
85 x 68.9 x 17.6 mm		
ca. 110 g		
Yes		
Yes		
Yes (with coupling interface)		
Yes (with coupling interface)		

2

MCBs

SN 201 L series 4500 B and C characteristic



SN 201 L

SN 201 L - B characteristic

Function: overload and short-circuit protection of circuits in final distribution; protection of long cable lengths in TN and IT systems.

Applications: residential.

Standard: IEC/EN 60898

Icn: 4.5 kA

Number of poles	Rated current	Bbn 8012542	Order details		Price 1 piece	Weight 1 piece	Pack unit
	In A	EAN	Type code	Order code			
1+N	2	087366	SN201 L B2	2CSS245101R0025		0.110	6
	4	087465	SN201 L B4	2CSS245101R0045		0.110	6
	6	087564	SN201 L B6	2CSS245101R0065		0.110	6
	10	087663	SN201 L B10	2CSS245101R0105		0.110	6
	16	087762	SN201 L B16	2CSS245101R0165		0.110	6
	20	087861	SN201 L B20	2CSS245101R0205		0.110	6
	25	087960	SN201 L B25	2CSS245101R0255		0.110	6
	32	088066	SN201 L B32	2CSS245101R0325		0.110	6
	40	088165	SN201 L B40	2CSS245101R0405		0.110	6

SN 201 L - C characteristic

Function: overload and short-circuit protection of circuits in final distribution; protection of resistive and inductive loads with low inrush current.

Applications: residential.

Standard: IEC/EN 60898

Icn: 4.5 kA

Number of poles	Rated current	Bbn 8012542	Order details		Price 1 piece	Weight 1 piece	Pack unit
	In A	EAN	Type code	Order code			
1+N	2	088264	SN201 L C2	2CSS245101R0024		0.110	6
	4	088363	SN201 L C4	2CSS245101R0044		0.110	6
	6	088462	SN201 L C6	2CSS245101R0064		0.110	6
	10	088561	SN201 L C10	2CSS245101R0104		0.110	6
	16	088660	SN201 L C16	2CSS245101R0164		0.110	6
	20	088769	SN201 L C20	2CSS245101R0204		0.110	6
	25	088868	SN201 L C25	2CSS245101R0254		0.110	6
	32	088967	SN201 L C32	2CSS245101R0324		0.110	6
	40	089063	SN201 L C40	2CSS245101R0404		0.110	6

Where to find more:

Coordination Tables for SN 201 MCBs: p.10/37 for back-up and p.10/44 for selectivity
Worldwide Marks and Approvals of MCBs p.11/92

Maybe you are also interested in:

Auxiliary Elements for MCBs p.4/2
Accessories for MCBs p.4/16
Busbar Systems p.4/31

MCBs

SN 201 series 6000 B and C characteristic



SN 201

2CSC400021P001

SN 201 - B characteristic

Function: overload and short-circuits protection of circuits in final distribution; protection of long cable lengths in TN and IT systems.

Applications: residential and commercial.

Standard: IEC/EN 60898

Icn: 6 kA

2

Number of poles	Rated current	Bbn 8012542	Order details		Price 1 piece	Weight 1 piece	Pack unit
	In A	EAN	Type code	Order code			
1+N	6	090762	SN201 B6	2CSS255101R0065		0.110	6
	10	090861	SN201 B10	2CSS255101R0105		0.110	6
	16	090960	SN201 B16	2CSS255101R0165		0.110	6
	20	091066	SN201 B20	2CSS255101R0205		0.110	6
	25	091165	SN201 B25	2CSS255101R0255		0.110	6
	32	091264	SN201 B32	2CSS255101R0325		0.110	6
	40	091363	SN201 B40	2CSS255101R0405		0.110	6

SN 201 - C characteristic

Function: overload and short-circuit protection of circuits in final distribution; protection of resistive and inductive loads with low inrush current.

Applications: residential and commercial.

Standard: IEC/EN 60898

Icn: 6 kA

Number of poles	Rated current	Bbn 8012542	Order details		Price 1 piece	Weight 1 piece	Pack unit
	In A	EAN	Type code	Order code			
1+N	2	091462	SN201 C2	2CSS255101R0024		0.110	6
	4	091561	SN201 C4	2CSS255101R0044		0.110	6
	6	091660	SN201 C6	2CSS255101R0064		0.110	6
	10	091769	SN201 C10	2CSS255101R0104		0.110	6
	13	091868	SN201 C13	2CSS255101R0134		0.110	6
	16	091967	SN201 C16	2CSS255101R0164		0.110	6
	20	092063	SN201 C20	2CSS255101R0204		0.110	6
	25	092162	SN201 C25	2CSS255101R0254		0.110	6
	32	092261	SN201 C32	2CSS255101R0324		0.110	6
	40	092360	SN201 C40	2CSS255101R0404		0.110	6

MCBs

SN 201 series 6000 D characteristic



SN 201

SN 201 - D characteristic

Function: protection and control of the circuits against overloads and short-circuits in final distribution; protection for circuits which supply loads with high inrush current at the circuit closing.

Applications: residential and commercial.

Standard: IEC/EN 60898

Icn: 6 kA

Number of poles	Rated current	Bbn 8012542	Order details		Price 1 piece	Weight 1 piece kg	Pack unit pc.
	In A	EAN	Type code	Order code			
1+N	6	092469	SN201 D6	2CSS255101R0061		0,110	6
	10	092568	SN201 D10	2CSS255101R0101		0,110	6
	16	092667	SN201 D16	2CSS255101R0161		0,110	6
	20	092766	SN201 D20	2CSS255101R0201		0,110	6
	25	092865	SN201 D25	2CSS255101R0251		0,110	6
	32	092964	SN201 D32	2CSS255101R0321		0,110	6
	40	093060	SN201 D40	2CSS255101R0401		0,110	6

Where to find more:

Coordination Tables for SN 201
 MCBs: p.10/37 for back-up and
 p.10/44 for selectivity
 Worldwide Marks and Approvals of
 MCBs p.11/92

Maybe you are also interested in:

Auxiliary Elements for MCBs p.4/2
 Accessories for MCBs p.4/16
 Busbar Systems p.4/31

MCBs

SN 201 M series 10000 B and C characteristic



SN 201 M

SN 201 M - B characteristic

Function: overloads and short-circuit protection of circuits in final distribution; protection of long cable lengths in TN and IT systems.

Applications: residential and commercial.

Standard: IEC/EN 60898

Icn: 10 kA

2

Number of poles	Rated current	Bbn 8012542	Order details		Price 1 piece	Weight 1 piece	Pack unit
	In A	EAN	Type code	Order code			
1+N	6	093152	SN201 M B6	2CSS275101R0065		0.110	6
	10	093251	SN201 M B10	2CSS275101R0105		0.110	6
	16	093350	SN201 M B16	2CSS275101R0165		0.110	6
	20	093459	SN201 M B20	2CSS275101R0205		0.110	6
	25	093558	SN201 M B25	2CSS275101R0255		0.110	6
	32	093657	SN201 M B32	2CSS275101R0325		0.110	6
	40	093756	SN201 M B40	2CSS275101R0405		0.110	6

SN 201 M - C characteristic

Function: overload and short-circuit protection of circuits in final distribution; protection of resistive and inductive loads with low inrush current.

Applications: residential and commercial.

Standard: IEC/EN 60898

Icn: 10 kA

Number of poles	Rated current	Bbn 8012542	Order details		Price 1 piece	Weight 1 piece	Pack unit
	In A	EAN	Type code	Order code			
1+N	2	093862	SN201 M C2	2CSS275101R0024		0.110	6
	4	093961	SN201 M C4	2CSS275101R0044		0.110	6
	6	094067	SN201 M C6	2CSS275101R0064		0.110	6
	10	094166	SN201 M C10	2CSS275101R0104		0.110	6
	16	094265	SN201 M C16	2CSS275101R0164		0.110	6
	20	094364	SN201 M C20	2CSS275101R0204		0.110	6
	25	094463	SN201 M C25	2CSS275101R0254		0.110	6
	32	094562	SN201 M C32	2CSS275101R0324		0.110	6
	40	094661	SN201 M C40	2CSS275101R0404		0.110	6

MCBs

S 280 series technical features



2

2CSC40002 D0211

S 280

		S 280 80 - 100 A	
General Data	Standards	IEC/EN 60898-1, IEC/EN 60947-2	
	Poles	1P, 2P, 3P, 4P	
	Tripping characteristics	B, C	
	Rated current I _n	A	80...100 A
	Rated frequency f	Hz	50 / 60 Hz
	Rated insulation voltage U _{acc.} to IEC/EN 60664-1	V	250 V AC (phase to ground), 500 V AC (phase to phase)
	Overvoltage category	III	
	Pollution degree	3	
Data acc. to IEC/EN 60898-1	Rated operational voltage U _n	V	1P: 230 V AC; 2...4P: 400 V AC
	Max. power frequency recovery voltage (U _{rec})	V	1P: 253 V AC; 2...4P: 440 V AC
	Min. operating voltage	V	12 V AC
	Rated short-circuit capacity I _{sc}	kA	6 kA
	Energy limiting class (B, C up to 40 A)	-	
	Rated impulse withstand voltage U _{imp} (1.2/50 μs)	kV	4 kV (test voltage 6.2 kV at sea level, 5 kV at 2,000 m)
	Dielectric test voltage	kV	2 kV (50 / 60 Hz, 1 min.)
	Reference temperature for tripping characteristics	°C	B, C: 30 °C
	Electrical endurance	ops.	4,000 ops.
	Data acc. to IEC/EN 60947-2	Rated operational voltage U _n	V
Max. power frequency recovery voltage (U _{rec})		V	1P: 253 V AC; 2...4P: 440 V AC
Min. operating voltage		V	12 V AC
Rated ultimate short-circuit breaking capacity I _{cu}		kA	6 kA
Rated service short-circuit breaking capacity I _{cs}		kA	6 kA
Rated impulse withstand voltage U _{imp} (1.2/50 μs)		kV	4 kV (test voltage 6.2 kV at sea level, 5 kV at 2,000 m)
Dielectric test voltage		kV	2 kV (50 / 60 Hz, 1 min.)
Reference temperature for tripping characteristics		°C	B, C: 55 °C
Electrical endurance		ops.	4,000 ops.
Mechanical Data	Housing	Insulation group I, RAL 7035	
	Toggle	Insulation group II, black, sealable	
	Contact position indication	Marking on toggle (I ON / 0 OFF), Real CPI (red ON / green OFF)	
	Protection degree acc. to IEC/EN 60529	IP20 ^① , IP40 in enclosure with cover	
	Mechanical endurance	ops.	10,000 ops.
	Shock resistance acc. to IEC/EN 60068-2-27	30 g - 3 shocks - 11 ms	
	Vibration resistance acc. to IEC/EN 60068-2-6	5 g - 20 cycles at 5...150...5 Hz with load 0.8 In	
	Environmental conditions (damp heat cyclic) acc. to IEC/EN 60068-2-30	°C/ RH	28 cycles with 55°C/90-96% and 25°C/95-100%
	Ambient temperature	°C	-25...+55°C
	Storage temperature	°C	-40...+70°C
	Installation	Terminal	Cage (shock protected)
Cross-section of conductors (top / bottom)		mm ²	Solid/stranded: 35/35 mm ² Flexible: 25/25 mm ²
Cross-section of busbars (top / bottom)		mm ²	16/16 mm ²
Tightening torque		Nm	2.5 Nm
Screwdriver		No. 2 Pozidrive	
Mounting		On DIN rail 35 mm acc. to EN 60715 by fast clip	
Mounting position		any	
Supply side		optional	
Dimensions and weight	Mounting dimensions acc. to DIN 43880	Mounting dimension 1	
	Pole dimensions (H x D x W)	mm	90 x 69 x 17.5 mm
	Pole weight	g	ca. 160 g
Combination with aux. elements	Auxiliary contact	Yes	
	Signal contact	Yes	
	Shunt trip	Yes	
	Undervoltage release	Yes	
	Motor operating device	No	

① Also fulfilling the requirement acc. to the protection degree IPXXB

Where to find more:

Back-up Coordination Tables for S 280 MCBs p.10/37
Worldwide Marks and Approvals of MCBs p.11/92

Maybe you are also interested in:
Auxiliary Elements for S 280 MCBs p.4/46

MCBs

S 280 series 6000 80-100 A; B and C characteristic



S 281

S 280 80-100A B characteristic

Function: protection and control of the circuits against overloads and short-circuits; protection for people and large length of cables in TN and IT systems.

Applications: commercial and industrial.

Standard: IEC/EN 60898-1, IEC/EN 60947-2

Icn=6 kA

2

Number of poles	Rated current	Bbn 8012542	Order details		Price 1 piece	Weight 1 piece	Pack unit
	In A	EAN	Type code	Order code			
1	80	499503	S281 B80	GHS2810001R0805		0.140	1/6
	100	499602	S281 B100	GHS2810001R0825		0.140	1/6
2	80	500100	S282 B80	GHS2820001R0805		0.275	1/3
	100	500209	S282 B100	GHS2820001R0825		0.275	1/3
3	80	500704	S283 B80	GHS2830001R0805		0.400	1/2
	100	500803	S283 B100	GHS2830001R0825		0.400	1/2
4	80	518006	S284 B80	GHS2840001R0805		0.525	1
	100	518105	S284 B100	GHS2840001R0825		0.525	1



S 282

S 280 80-100A C characteristic

Function: protection and control of the circuits against overloads and short-circuits; protection for resistive and inductive loads with low inrush current.

Applications: commercial and industrial.

Standard: IEC/EN 60898-1, IEC/EN 60947-2

Icn=6 kA

Number of poles	Rated current	Bbn 8012542	Order details		Price 1 piece	Weight 1 piece	Pack unit
	In A	EAN	Type code	Order code			
1	80	499305	S281 C80	GHS2810001R0804		0.140	1/6
	100	499404	S281 C100	GHS2810001R0824		0.140	1/6
2	80	499909	S282 C80	GHS2820001R0804		0.275	1/3
	100	500001	S282 C100	GHS2820001R0824		0.275	1/3
3	80	500506	S283 C80	GHS2830001R0804		0.400	1/2
	100	500605	S283 C100	GHS2830001R0824		0.400	1/2
4	80	517801	S284 C80	GHS2840001R0804		0.525	1
	100	517900	S284 C100	GHS2840001R0824		0.525	1



S 283



S 284

MCBs

S 280 UC series technical features



S 280 UC

		S 280 UC		
General Data	Standards	Acc. to IEC/EN 60898-2, IEC/EN 60947-2 UL 1077, CSA 22.2 No. 235		
	Poles	1P, 2P, 3P, 4P		
	Tripping characteristics	B, K, Z		
	Rated current I _n	A	0.2...63 A	
	Rated frequency f	Hz	50 / 60 Hz	
	Rated insulation voltage U _i acc. to IEC/EN 60664-1	V	250 V AC (phase to ground), 500 V AC (phase to phase)	
	Overvoltage category	III		
	Pollution degree	3		
	Data acc. to IEC/EN 60898-2	Rated operational voltage U _n	V	1P: 220 V DC, 230 V AC; 2P: 400 V DC, 400 V AC
		Max. power frequency recovery voltage (U _{max})	V	1P: 253 V AC, 242 V DC; 2...4P: 440 V AC, 484 V DC
Min. operating voltage		V	12 V AC - 12 V DC	
Rated short-circuit capacity I _{cs}		kA	≤ 40 A: 6 kA; > 40 A: 4.5 kA	
Energy limiting class (B, C up to 40 A)		3		
Rated impulse withstand voltage U _{imp} (1.2/50 μs)		kV	4 kV (test voltage 6.2 kV at sea level, 5 kV at 2,000 m)	
Dielectric test voltage		kV	2 kV (50 / 60 Hz, 1 min.)	
Reference temperature for tripping characteristics		°C	B: 30 °C; K, Z: 20 °C	
Electrical endurance		ops.	10,000 ops. (AC), 1,000 ops. (DC), (1 cycle 2s - ON, 13s - OFF, I _n ≤ 32A), (1 cycle 2s - ON, 28s - OFF, I _n > 32A)	
Data acc. to IEC/EN 60947-2		Rated operational voltage U _n	V	1P: 220 V DC; 2...4P: 440 V DC
	Max. power frequency recovery voltage (U _{max})	V	1P: 253 V AC, 242 V DC; 2...4P: 440 V AC, 484 V DC	
	Min. operating voltage	V	12 V AC	
	Rated ultimate short-circuit breaking capacity I _{cu}	kA	≤ 40 A: 6 kA; > 40 A: 4.5 kA	
	Rated service short-circuit breaking capacity I _{cs}	kA	≤ 40 A: 6 kA; > 40 A: 4.5 kA	
	Rated impulse withstand voltage U _{imp} (1.2/50 μs)	kV	4 kV (test voltage 6.2 kV at sea level, 5 kV at 2,000 m)	
	Dielectric test voltage	kV	2 kV (50 / 60 Hz, 1 min.)	
	Reference temperature for tripping characteristics	°C	B: 55 °C; K, Z: 20 °C	
	Electrical endurance	ops.	10,000 ops. (AC), 1,000 ops. (DC), (1 cycle 2s - ON, 13s - OFF, I _n ≤ 32A), (1 cycle 2s - ON, 28s - OFF, I _n > 32A)	
	Data acc. to UL / CSA	Rated voltage	V	1P: 250 V DC, 277 V AC; 2...4P: 500 V DC, 480 V AC
Rated interrupting capacity		kA	4.5 kA (10 kA 60 V DC 1 P, 125 V DC 2P)	
Application		Suppl. prot. for general use		
Reference temperature for tripping characteristics		°C	B, K, Z: 25 °C	
Electrical endurance		ops.	6,000 ops. (AC), 6,000 ops. (DC), (1 cycle 1s - ON, 9s - OFF)	

		S 280 UC	
Mechanical Data	Housing	Insulation group I, RAL 7035	
	Toggle	Insulation group II, black, sealable	
	Contact position indication	Marking on toggle (I ON / 0 OFF), Real CPI (red ON / green OFF)	
	Protection degree acc. to IEC/EN 60529	IP20 ^① , IP40 in enclosure with cover	
	Mechanical endurance	ops. 20,000 ops.	
	Shock resistance acc. to IEC/EN 60068-2-27	30 g - 3 shocks - 11 ms	
	Vibration resistance acc. to IEC/EN 60068-2-6	5 g - 20 cycles at 5...150...5 Hz with load 0.8 In	
	Environmental conditions (damp heat cyclic) acc. to IEC/EN 60068-2-30	°C/RH 28 cycles with 55°C/90-96% and 25°C/95-100%	
	Ambient temperature	°C -25 ... +55°C	
	Storage temperature	°C -40 ... +70°C	
Installation	Terminal	Cage (shock protected)	
	Cross-section of conductors (top / bottom)	mm ²	Solid/stranded: 25 mm ² / 25 mm ² Flexible: 16 mm ² / 16 mm ²
		AWG	18 - 4 AWG
	Cross-section of busbars (top / bottom)	mm ²	16 mm ² / 16 mm ²
		AWG	-
	Tightening torque	Nm	2.5 Nm
		in-lbs.	17.5 in-lbs.
	Screwdriver		No. 2 Pozidrive
Mounting		On DIN rail 35 mm acc. to EN 60715 by fast clip	
Mounting position		any	
Supply side		Please note polarity of device	
Dimensions and weight	Mounting dimensions acc. to DIN 43880	Mounting dimension 1	
	Pole dimensions (H x D x W)	mm 90 x 69 x 17.5 mm	
Combination with aux. elements	Pole weight	g ca. 140 g	
	Auxiliary contact, signal contact, shunt trip, undervoltage release	Yes	
	Motor operating device	No	

2

① Also fulfilling the requirement acc. to the protection degree IPXXB

MCBs

S 280 series UC universal current range, B characteristic



S 281 UC



S 282 UC

S 280 series UC B characteristic

Function: protection and control of the circuits against overloads and short-circuits; protection for people and large length of cables in TN and IT systems; version dedicated to application in direct current circuits for voltages up to 220 V DC 1 pole and 440 V DC 2, 3 and 4 poles.

Applications: industrial.

Standard: Acc. to IEC/EN 60898-2

Icn=6 kA

Number of poles	Rated current	Bbn 4016779	Order details		Price 1 piece	Weight 1 piece kg	Pack unit pc.
	In A	EAN	Type code	Order code			
1	6	162302	S281-UC B 6	GHS2810164R0065		0.130	10/40
	10	162401	S281-UC B10	GHS2810164R0105		0.130	10/40
	16	162500	S281-UC B16	GHS2810164R0165		0.130	10/40
	20	162609	S281-UC B20	GHS2810164R0205		0.130	10/40
	25	162708	S281-UC B25	GHS2810164R0255		0.130	10/40

Number of poles	Rated current	Bbn 4016779	Order details		Price 1 piece	Weight 1 piece kg	Pack unit pc.
	In A	EAN	Type code	Order code			
2	6	162807	S282-UC B 6	GHS2820164R0065		0.260	5/20
	10	162906	S282-UC B10	GHS2820164R0105		0.260	5/20
	16	163002	S282-UC B16	GHS2820164R0165		0.260	5/20
	20	163101	S282-UC B20	GHS2820164R0205		0.260	5/20
	25	163200	S282-UC B25	GHS2820164R0255		0.260	5/20

Where to find more:
Short Circuit Breaking Capacity for S 280 UC MCBs p.10/43

Maybe you are also interested in:
Auxiliary Elements for 280 and S280 UC series MCBs p4/49

MCBs

S 280 series UC universal current range, K characteristic



S 281 UC

S 280 series UC K (power) characteristic

Function: protection and control of the circuits like motors and auxiliary circuits, against overloads and short-circuits; version dedicated to application in direct current circuits for voltages up to 220 V DC 1 pole and 440 V DC 2, 3 and 4 poles.

Advantages: no nuisance tripping in the case of functional peak currents up to $8 \times I_n$, depending on the series; through its highly sensitive thermostatic bimetal trip, the K-type characteristic offers protection to damageable elements in the overcurrent range; it also provides the best protection to cables and lines.

Applications: industrial.

Standard: Acc. to IEC/EN 60947-2

Icu=6 kA for $0.2 \text{ A} \leq I_n \leq 40 \text{ A}$

Icu=4.5 kA for $50 \text{ A} \leq I_n \leq 63 \text{ A}$

2

Number of poles	Rated current	Bbn 4012233	Order details		Price 1 piece	Weight 1 piece kg	Pack unit pc.
	In A	EAN	Type code	Order code			
1	0.2	634200	S 281 UC-K 0.2	GHS2810164R0087		0.130	10/40
	0.3	634309	S 281 UC-K 0.3	GHS2810164R0117		0.130	10/40
	0.5	634408	S 281 UC-K 0.5	GHS2810164R0157		0.130	10/40
	0.75	635504	S 281 UC-K 0.75	GHS2810164R0187		0.130	10/40
	1	634606	S 281 UC-K 1	GHS2810164R0217		0.130	10/40
	1.6	634705	S 281 UC-K 1.6	GHS2810164R0257		0.130	10/40
	2	634804	S 281 UC-K 2	GHS2810164R0277		0.130	10/40
	3	634903	S 281 UC-K 3	GHS2810164R0317		0.130	10/40
	4	635009	S 281 UC-K 4	GHS2810164R0337		0.130	10/40
	6	635207	S 281 UC-K 6	GHS2810164R0377		0.130	10/40
	8	635108	S 281 UC-K 8	GHS2810164R0407		0.130	10/40
	10	635306	S 281 UC-K 10	GHS2810164R0427		0.130	10/40
	16	635405	S 281 UC-K 16	GHS2810164R0467		0.130	10/40
	20	635603	S 281 UC-K 20	GHS2810164R0487		0.130	10/40
	25	635702	S 281 UC-K 25	GHS2810164R0517		0.130	10/40
	32	635801	S 281 UC-K 32	GHS2810164R0537		0.130	10/40
	40	635900	S 281 UC-K 40	GHS2810164R0557		0.130	10/40
50	636006	S 281 UC-K 50	GHS2810164R0577		0.160	10/40	
63	636105	S 281 UC-K 63	GHS2810164R0607		0.160	10/40	

MCBs

S 280 series UC universal current range, K characteristic



S 282 UC



S 283 UC

Number of poles	Rated current	Bbn 4012233	Order details		Price 1 piece	Weight 1 piece	Pack unit
	In A	EAN	Type code	Order code			
2	0.2	636204	S 282 UC-K 0.2	GHS2820164R0087		0.260	5/20
	0.3	636303	S 282 UC-K 0.3	GHS2820164R0117		0.260	5/20
	0.5	636402	S 282 UC-K 0.5	GHS2820164R0157		0.260	5/20
	0.75	636501	S 282 UC-K 0.75	GHS2820164R0187		0.260	5/20
	1	636600	S 282 UC-K 1	GHS2820164R0217		0.260	5/20
	1.6	636709	S 282 UC-K 1.6	GHS2820164R0257		0.260	5/20
	2	652808	S 282 UC-K 2	GHS2820164R0277		0.260	5/20
	3	636808	S 282 UC-K 3	GHS2820164R0317		0.260	5/20
	4	636907	S 282 UC-K 4	GHS2820164R0337		0.260	5/20
	6	637003	S 282 UC-K 6	GHS2820164R0377		0.260	5/20
	8	637102	S 282 UC-K 8	GHS2820164R0407		0.260	5/20
	10	637201	S 282 UC-K 10	GHS2820164R0427		0.260	5/20
	16	637300	S 282 UC-K 16	GHS2820164R0467		0.260	5/20
	20	637409	S 282 UC-K 20	GHS2820164R0487		0.260	5/20
	25	637508	S 282 UC-K 25	GHS2820164R0517		0.260	5/20
	32	637607	S 282 UC-K 32	GHS2820164R0537		0.260	5/20
40	637706	S 282 UC-K 40	GHS2820164R0557		0.260	5/20	
50	637904	S 282 UC-K 50	GHS2820164R0577		0.320	5/20	
63	638000	S 282 UC-K 63	GHS2820164R0607		0.320	5/20	

Number of poles	Rated current	Bbn 4012233	Order details		Price 1 piece	Weight 1 piece	Pack unit
	In A	EAN	Type code	Order code			
3	0.2	738106	S 283 UC-K 0.2	GHS2830164R0087		0.390	3/12
	0.3	738205	S 283 UC-K 0.3	GHS2830164R0117		0.390	3/12
	0.5	738304	S 283 UC-K 0.5	GHS2830164R0157		0.390	3/12
	0.75	738403	S 283 UC-K 0.75	GHS2830164R0187		0.390	3/12
	1	738502	S 283 UC-K 1	GHS2830164R0217		0.390	3/12
	1.6	738601	S 283 UC-K 1.6	GHS2830164R0257		0.390	3/12
	2	738700	S 283 UC-K 2	GHS2830164R0277		0.390	3/12
	3	738809	S 283 UC-K 3	GHS2830164R0317		0.390	3/12
	4	738908	S 283 UC-K 4	GHS2830164R0337		0.390	3/12
	6	739004	S 283 UC-K 6	GHS2830164R0377		0.390	3/12
	8	739103	S 283 UC-K 8	GHS2830164R0407		0.390	3/12
	10	739202	S 283 UC-K 10	GHS2830164R0427		0.390	3/12
	16	739301	S 283 UC-K 16	GHS2830164R0467		0.390	3/12
	20	739400	S 283 UC-K 20	GHS2830164R0487		0.390	3/12
	25	739509	S 283 UC-K 25	GHS2830164R0517		0.390	3/12
	32	739608	S 283 UC-K 32	GHS2830164R0537		0.390	3/12
40	739707	S 283 UC-K 40	GHS2830164R0557		0.390	3/12	
50	739806	S 283 UC-K 50	GHS2830164R0577		0.480	3/12	
63	739905	S 283 UC-K 63	GHS2830164R0607		0.480	3/12	

Where to find more:
Short Circuit Breaking Capacity for S 280 UC MCBs p.10/43

Maybe you are also interested in:
Auxiliary Elements for 280 and S280 UC series MCBs p4/49



S 284 UC

2CSC400199R201

Number of poles	Rated current	Bbn 4012233	Order details		Price 1 piece	Weight 1 piece kg	Pack unit pc.
	In A	EAN	Type code	Order code			
4	0.2	741601	S 284 UC-K 0.2	GHS2840164R0087		0.520	2
	0.3	741700	S 284 UC-K 0.3	GHS2840164R0117		0.520	2
	0.5	741809	S 284 UC-K 0.5	GHS2840164R0157		0.520	2
	0.75	741908	S 284 UC-K 0.75	GHS2840164R0187		0.520	2
	1	742004	S 284 UC-K 1	GHS2840164R0217		0.520	2
	1.6	742103	S 284 UC-K 1.6	GHS2840164R0257		0.520	2
	2	742202	S 284 UC-K 2	GHS2840164R0277		0.520	2
	3	742301	S 284 UC-K 3	GHS2840164R0317		0.520	2
	4	742400	S 284 UC-K 4	GHS2840164R0337		0.520	2
	6	742509	S 284 UC-K 6	GHS2840164R0377		0.520	2
	8	742608	S 284 UC-K 8	GHS2840164R0407		0.520	2
	10	742707	S 284 UC-K 10	GHS2840164R0427		0.520	2
	16	742806	S 284 UC-K 16	GHS2840164R0467		0.520	2
	20	743001	S 284 UC-K 20	GHS2840164R0487		0.520	2
	25	743100	S 284 UC-K 25	GHS2840164R0517		0.520	2
	32	743209	S 284 UC-K 32	GHS2840164R0537		0.520	2
	40	743308	S 284 UC-K 40	GHS2840164R0557		0.520	2
50	743407	S 284 UC-K 50	GHS2840164R0577		0.640	2	
63	743506	S 284 UC-K 63	GHS2840164R0607		0.640	2	

2

MCBs

S 280 series UC universal current range, Z characteristic

2



S 281 UC

S 280 series UC Z characteristic

Function: protection and control of the electronic circuits against lower and long duration overloads and short-circuits; version dedicated to application in direct current circuits for voltages up to 220 V DC 1 pole and 440 V DC 2, 3 and 4 poles.

Applications: industrial.

Standard: Acc. to IEC/EN 60947-2

Icu=6 kA for 0.2 A ≤ In ≤ 40 A

Icu=4.5 kA for 50 A ≤ In ≤ 63 A



S 282 UC

Number of poles	Rated current	Bbn 4012233	Order details		Price 1 piece	Weight 1 piece kg	Pack unit pc.
	In A	EAN	Type code	Order code			
1	0.5	638604	S 281 UC-Z 0.5	GHS2810164R0158		0.130	10/40
	1	638703	S 281 UC-Z 1	GHS2810164R0218		0.130	10/40
	1.6	638802	S 281 UC-Z 1.6	GHS2810164R0258		0.130	10/40
	2	638901	S 281 UC-Z 2	GHS2810164R0278		0.130	10/40
	3	639007	S 281 UC-Z 3	GHS2810164R0318		0.130	10/40
	4	639106	S 281 UC-Z 4	GHS2810164R0338		0.130	10/40
	6	639205	S 281 UC-Z 6	GHS2810164R0378		0.130	10/40
	8	639403	S 281 UC-Z 8	GHS2810164R0408		0.130	10/40
	10	639502	S 281 UC-Z 10	GHS2810164R0428		0.130	10/40
	16	639601	S 281 UC-Z 16	GHS2810164R0468		0.130	10/40
	20	639700	S 281 UC-Z 20	GHS2810164R0488		0.130	10/40
	25	639809	S 281 UC-Z 25	GHS2810164R0518		0.130	10/40
	32	639908	S 281 UC-Z 32	GHS2810164R0538		0.130	10/40
	40	640003	S 281 UC-Z 40	GHS2810164R0558		0.130	10/40
	50	640102	S 281 UC-Z 50	GHS2810164R0578		0.160	10/40
	63	640201	S 281 UC-Z 63	GHS2810164R0608		0.160	10/40

Number of poles	Rated current	Bbn 4012233	Order details		Price 1 piece	Weight 1 piece kg	Pack unit pc.
	In A	EAN	Type code	Order code			
2	0.5	640300	S 282 UC-Z 0.5	GHS2820164R0158		0.260	5/20
	1	640409	S 282 UC-Z 1	GHS2820164R0218		0.260	5/20
	1.6	642304	S 282 UC-Z 1.6	GHS2820164R0258		0.260	5/20
	2	641000	S 282 UC-Z 2	GHS2820164R0278		0.260	5/20
	3	641109	S 282 UC-Z 3	GHS2820164R0318		0.260	5/20
	4	641208	S 282 UC-Z 4	GHS2820164R0338		0.260	5/20
	6	641307	S 282 UC-Z 6	GHS2820164R0378		0.260	5/20
	8	641406	S 282 UC-Z 8	GHS2820164R0408		0.260	5/20
	10	641505	S 282 UC-Z 10	GHS2820164R0428		0.260	5/20
	16	641604	S 282 UC-Z 16	GHS2820164R0468		0.260	5/20
	20	641703	S 282 UC-Z 20	GHS2820164R0488		0.260	5/20
	25	641802	S 282 UC-Z 25	GHS2820164R0518		0.260	5/20
	32	641901	S 282 UC-Z 32	GHS2820164R0538		0.260	5/20
	40	642007	S 282 UC-Z 40	GHS2820164R0558		0.260	5/20
	50	642106	S 282 UC-Z 50	GHS2820164R0578		0.320	5/20
	63	642205	S 282 UC-Z 63	GHS2820164R0608		0.320	5/20

Where to find more:
Short Circuit Breaking Capacity for
S 280 UC MCBs p.10/43

Maybe you are also interested in:
Auxiliary Elements for 280 and S280
UC series MCBs p4/49



S 283 UC

2CSC400478F0201



S 284 UC

2CSC400478F0201

Number of poles	Rated current	Bbn 4012233	Order details		Price 1 piece	Weight 1 piece	Pack unit
	In A	EAN	Type code	Order code			
3	0.5	740000	S 283 UC-Z 0.5	GHS2830164R0158		0.390	3/12
	1	740109	S 283 UC-Z 1	GHS2830164R0218		0.390	3/12
	1.6	740208	S 283 UC-Z 1.6	GHS2830164R0258		0.390	3/12
	2	740307	S 283 UC-Z 2	GHS2830164R0278		0.390	3/12
	3	740406	S 283 UC-Z 3	GHS2830164R0318		0.390	3/12
	4	740505	S 283 UC-Z 4	GHS2830164R0338		0.390	3/12
	6	740604	S 283 UC-Z 6	GHS2830164R0378		0.390	3/12
	8	740703	S 283 UC-Z 8	GHS2830164R0408		0.390	3/12
	10	740802	S 283 UC-Z 10	GHS2830164R0428		0.390	3/12
	16	740901	S 283 UC-Z 16	GHS2830164R0468		0.390	3/12
	20	741007	S 283 UC-Z 20	GHS2830164R0488		0.390	3/12
	25	741106	S 283 UC-Z 25	GHS2830164R0518		0.390	3/12
	32	741205	S 283 UC-Z 32	GHS2830164R0538		0.390	3/12
	40	741304	S 283 UC-Z 40	GHS2830164R0558		0.390	3/12
	50	741403	S 283 UC-Z 50	GHS2830164R0578		0.480	3/12
	63	741502	S 283 UC-Z 63	GHS2830164R0608		0.480	3/12

2

Number of poles	Rated current	Bbn 4012233	Order details		Price 1 piece	Weight 1 piece	Pack unit
	In A	EAN	Type code	Order code			
4	0.5	743605	S 284 UC-Z 0.5	GHS2840164R0158		0.520	2
	1	743704	S 284 UC-Z 1	GHS2840164R0218		0.520	2
	1.6	743803	S 284 UC-Z 1.6	GHS2840164R0258		0.520	2
	2	743902	S 284 UC-Z 2	GHS2840164R0278		0.520	2
	3	744008	S 284 UC-Z 3	GHS2840164R0318		0.520	2
	4	744107	S 284 UC-Z 4	GHS2840164R0338		0.520	2
	6	744206	S 284 UC-Z 6	GHS2840164R0378		0.520	2
	8	744305	S 284 UC-Z 8	GHS2840164R0408		0.520	2
	10	744404	S 284 UC-Z 10	GHS2840164R0428		0.520	2
	16	744503	S 284 UC-Z 16	GHS2840164R0468		0.520	2
	20	744602	S 284 UC-Z 20	GHS2840164R0488		0.520	2
	25	744701	S 284 UC-Z 25	GHS2840164R0518		0.520	2
	32	744800	S 284 UC-Z 32	GHS2840164R0538		0.520	2
	40	744909	S 284 UC-Z 40	GHS2840164R0558		0.520	2
	50	745005	S 284 UC-Z 50	GHS2840164R0578		0.640	2
	63	745104	S 284 UC-Z 63	GHS2840164R0608		0.640	2

SMCBs

S750 series DR technical features



S750 DR

2CSC 021 064 S7012

		S 750 DR	
General Data	Standards		IEC/EN 60947-2
	Poles		1P, 2P, 3P, 4P
	Tripping characteristics		E _{selective} , K _{selective}
	Rated current I _n	A	16...63
	Rated frequency f	Hz	50/60
Electrical Data acc. to IEC/EN 60947-2	Rated operational voltage U _r	V AC	230 (1-pole), 400 (2-, 3-, 4-pole)
	Rated breaking capacity I _{cu}	kA	25
	Rated service breaking capacity I _{cs}	kA	12.5
	Rated insulation voltage U _i	V	690
	Selectivity limit current I _{s1}		rated breaking capacity of downstream breaker (min.) – see selectivity tables
	Overvoltage category		IV
	Pollution degree		3
	Rated impulse withstand voltage U _{imp}	kV	6
	Impulse withstand voltage acc. to IEC 60364-5-53 (at 2000m above sea level)	kV	8
	Impulse withstand test voltage (1.2/50µs)	kV	9.8
Isolation function acc. to IEC 60364-5-53		yes	
	Dielectric test voltage (50/60 Hz, 1 min.)	kV	2 (50/60 Hz, 1 min.)
Mechanical Data	Contact position indication		via toggle (I-ON / 0-OFF), via trip indicator (red-ON / green-OFF)
	IP protection degree acc. to IEC/EN 60529		IP40 (when protected by cabinet cover)
	Shock resistance acc. to IEC / EN 60068-2-27		25 g, min. 3 shocks, duration 13 ms
	Vibration resistance acc. to IEC/EN 60068-2-6		2 g, 20 cycles 5...150...5 Hz
	Environmental conditions (damp heat cyclic) acc. to IEC/EN 60068-2-30	°C/RH	28 cycles: 55 / 90...96 – 25 / 95...100
	Ambient temperature	°C	-25 ... +55
	Storage temperature	°C	-40 ... +70
Installation	Wire connection (Top)		frame terminal to connect solid and rigid stranded conductors incl. flexible conductors 2.5...50 mm ²
	Wire connection (Bottom)		frame terminal to connect solid and rigid stranded conductors incl. flexible conductors 2.5...50 mm ²
	Max. torque	Nm	2.5...3
	Recommended Screwdriver		slotted: 1 x 5.5, Pozidrive: PZ 2
	Mounting		DIN rail 35 mm acc. to EN 60715
	Locking		integrated blocking device, additional locking by 3 mm padlock, 1mm seal wire or cabel binder
	Mounting position		any
	Supply		any
Dimensions and weight	Size acc. to DIN 43880		3
	Width	mm	27 (per pole)
	Pole dimensions (H x D x W)	mm	see drawings
	Pole weight	g	see order tables
Accessories			3 mm padlock

SMCBs

S750 series DR- selective main circuit-breakers, E_{selective} characteristic

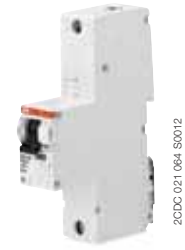

S751 DR



S752 DR



S753 DR



S754 DR

S750 series DR

Selective main circuit-breakers of the S 750 DR series are SMCBs based on DIN VDE 0641-21 with voltage-independent operating principle. This means that they do not rely on a control circuit to make or break contact (SHU) and are therefore particularly suitable for use in energy distribution systems with maximum availability requirements. They offer total selectivity to downstream MCB's and outstanding selectivity to upstream protective devices due to unique current limiting selectivity.

2

Number of poles	Rated current In A	Bbn 4016779 EAN	Order details		Price 1 piece	Weight 1 piece kg	Pack unit pc.
			Type code	Order code			
1	16	4016779878968	S751 DR-E16	2CDH781010R0162		0.35	3
	20	4016779878975	S751 DR-E20	2CDH781010R0202		0.35	3
	25	4016779878982	S751 DR-E25	2CDH781010R0252		0.35	3
	32	4016779878999	S751 DR-E32	2CDH781010R0322		0.35	3
	40	4016779879019	S751 DR-E40	2CDH781010R0402		0.35	3
	50	4016779879026	S751 DR-E50	2CDH781010R0502		0.35	3
	63	4016779879033	S751 DR-E63	2CDH781010R0632		0.35	3
2	16	4016779879361	S752 DR-E16	2CDH782010R0162		0.7	2
	20	4016779879378	S752 DR-E20	2CDH782010R0202		0.7	2
	25	4016779879385	S752 DR-E25	2CDH782010R0252		0.7	2
	32	4016779879392	S752 DR-E32	2CDH782010R0322		0.7	2
	40	4016779879415	S752 DR-E40	2CDH782010R0402		0.7	2
	50	4016779879422	S752 DR-E50	2CDH782010R0502		0.7	2
	63	4016779879439	S752 DR-E63	2CDH782010R0632		0.7	2
3	16	4016779879569	S753 DR-E16	2CDH783010R0162		1.05	1
	20	4016779879576	S753 DR-E20	2CDH783010R0202		1.05	1
	25	4016779879583	S753 DR-E25	2CDH783010R0252		1.05	1
	32	4016779879590	S753 DR-E32	2CDH783010R0322		1.05	1
	40	4016779879613	S753 DR-E40	2CDH783010R0402		1.05	1
	50	4016779879620	S753 DR-E50	2CDH783010R0502		1.05	1
	63	4016779879637	S753 DR-E63	2CDH783010R0632		1.05	1
4	16	4016779879767	S754 DR-E16	2CDH784010R0162		1.4	1
	20	4016779879774	S754 DR-E20	2CDH784010R0202		1.4	1
	25	4016779879781	S754 DR-E25	2CDH784010R0252		1.4	1
	32	4016779879798	S754 DR-E32	2CDH784010R0322		1.4	1
	40	4016779879811	S754 DR-E40	2CDH784010R0402		1.4	1
	50	4016779879828	S754 DR-E50	2CDH784010R0502		1.4	1
	63	4016779879835	S754 DR-E63	2CDH784010R0632		1.4	1

Where to find more:
Selectivity Coordination Tables for S 700 DR MCBs p.10/92
Worldwide Marks and Approvals of MCBs p.11/92

Due to the lack of international product standards for SMCB, S750DR products as given in this catalogue are certified acc. to IEC/ EN 60947-2. If requested, S750 (for 40mm busbar systems) and S750DR (for DIN rail mounting) are also available with a certification based on a German SMCB standard. Please contact your ABB office for further information .

SMCBs

S750 DR series - selective main circuit-breakers, K_{selective} characteristic

2



2CDC 021 064 S0012

S751 DR



2CDC 021 065 S0012

S752 DR



2CDC 021 066 S0012

S753 DR



2CDC 021 067 S0012

S754 DR

Number of poles	Rated current	Bbn 4016779	Order details		Price 1 piece	Weight 1 piece kg	Pack unit pc.
	In A	EAN	Type code	Order code			
1	16	4016779879064	S751 DR-K16	2CDH781010R0467		0.35	3
	20	4016779879071	S751 DR-K20	2CDH781010R0487		0.35	3
	25	4016779879088	S751 DR-K25	2CDH781010R0517		0.35	3
	32	4016779879095	S751 DR-K32	2CDH781010R0537		0.35	3
	40	4016779879118	S751 DR-K40	2CDH781010R0557		0.35	3
	50	4016779879125	S751 DR-K50	2CDH781010R0577		0.35	3
	63	4016779879132	S751 DR-K63	2CDH781010R0607		0.35	3
2	16	4016779879460	S752 DR-K16	2CDH782010R0467		0.7	2
	20	4016779879477	S752 DR-K20	2CDH782010R0487		0.7	2
	25	4016779879484	S752 DR-K25	2CDH782010R0517		0.7	2
	32	4016779879491	S752 DR-K32	2CDH782010R0537		0.7	2
	40	4016779879514	S752 DR-K40	2CDH782010R0557		0.7	2
	50	4016779879521	S752 DR-K50	2CDH782010R0577		0.7	2
	63	4016779879538	S752 DR-K63	2CDH782010R0607		0.7	2
3	16	4016779879668	S753 DR-K16	2CDH783010R0467		1.05	1
	20	4016779879675	S753 DR-K20	2CDH783010R0487		1.05	1
	25	4016779879682	S753 DR-K25	2CDH783010R0517		1.05	1
	32	4016779879699	S753 DR-K32	2CDH783010R0537		1.05	1
	40	4016779879712	S753 DR-K40	2CDH783010R0557		1.05	1
	50	4016779879729	S753 DR-K50	2CDH783010R0577		1.05	1
	63	4016779879736	S753 DR-K63	2CDH783010R0607		1.05	1
4	16	4016779879866	S754 DR-K16	2CDH784010R0467		1.4	1
	20	4016779879873	S754 DR-K20	2CDH784010R0487		1.4	1
	25	4016779879880	S754 DR-K25	2CDH784010R0517		1.4	1
	32	4016779879897	S754 DR-K32	2CDH784010R0537		1.4	1
	40	4016779879910	S754 DR-K40	2CDH784010R0557		1.4	1
	50	4016779879927	S754 DR-K50	2CDH784010R0577		1.4	1
	63	4016779879934	S754 DR-K63	2CDH784010R0607		1.4	1

Where to find more:
 Selectivity Coordination Tables for S
 700 DR MCBs p.10/92
 Worldwide Marks and Approvals of
 MCBs p.11/92

SMCBs

S700 series technical features



S700

		S 700
General Data	Standards	E DIN VDE 0645:2003-09, partly acc. to IEC EN 60947-2
	Poles	1P, 2P, 3P, 4P
	Tripping characteristics	$E_{selective}^*$ $K_{selective}$ 1.05 ... 1.2 x I _n E: 5 ... 6.25 x I _n K: 10 ... 14 x I _n (≤ 50 A), 8 ... 12 x I _n (≥ 63 A)
	thermal tripping	
	short-time delayed tripping	
	minimum tripping delay	ms 10
Electrical Data	Rated insulation voltage U _i acc. to IEC/EN 60664-1	V AC 690
	Rated current I _n	A E: 10...100; K: 16...100
	Rated frequency f	Hz 50 / 60
	Rated operational voltage U ⁿ	V AC 1P: 230 / 400; 2...4P: 400
	Rated breaking capacity I _{cn}	kA 25
	Selectivity limit current I _{s1}	Rated breaking capacity of the downstream MCB (see selectivity tables)
	Overvoltage category	IV
	Pollution degree	3
	Rated impulse withstand voltage U _{imp}	kV 6
	Impulse withstand voltage acc. to IEC 60364-5-53, clause 536.2 (at 2000m over sea level)	kV 8
	Impulse withstand test voltage (1.2/50μs) at sea level	
	new condition	kV 12.3
	after use	kV 9.8
	Isolation function acc. to IEC 60364-5-53	yes
Dielectric test voltage (50/60 Hz, 1 min.)	kV 2	
Mechanical Data	Contact position indication	Toggle (I ON / 0 OFF); Real CPI (red ON / green OFF)
	IP protection degree acc. to IEC/EN 60529	IP40 (in enclosure with cover, cut-out dimension 46mm)
	Mechanical switching cycles	
	without load	ops. 1000
	with rated current	ops. 1000
	Shock resistance acc. to IEC/EN 60068-2-27	25 g - 3 shocks - 13 ms
	Vibration resistance acc. to IEC/EN 60068-2-6	2 g, 20 cycles 5...150...5Hz
	Environmental conditions (damp heat cyclic) acc. to IEC/EN 60068-2-30	°C/RH 28 cycles: 55°C/90...96% - 25°C/95...100%
	Ambient temperature	°C -25 ... +55
	Storage temperature	°C -40 ... +70
Installation	Terminal type	Saddle terminal
	Terminal size top / bottom	mm ² Capable to connect solid and rigid stranded conductors incl. flexible conductors 2.5...50 / 70
	Terminal screws tightening torque	Nm 3...3.5
	Max. torque for surface mounting	Nm 2.5 ... 3 (only fl at-headed screws, no circlips)
	Recommended screwdriver	Slot: 1 x 5.5, cross slot: PZ 2
	Mounting	Surface mounting with 2 screws, DIN rail mounting (35 mm DIN rail acc. to EN 60715, 40 mm busbar systems 4/5-pole, 5/10 mm x 12 mm)
	Mounting position	any
	Supply side/load side	any
Dimensions and weight	Size acc. to DIN 43880	5 (mounting on DIN-Rail); 6 (mounting on busbar)
	Width	2 modules / pole
	Pole dimensions (H x D x W)	see drawings
	Pole weight	see order tables
Accessories		Optional: version with factory assembled auxiliary switch (2 change-over contacts) Terminal covers Handle covers Busbar adapters DIN rail adapters Locking devices

2

SMCBs

S700 series 25000 - selective main circuit-breakers, E_{selective} characteristic



S701



S702

S700 E characteristic

Breakers of the S700 series are selective main circuit-breakers (SMCB) for overcurrent protection in electrical installations. They have total selectivity to downstream mcb's and outstanding selectivity to upstream protective devices due to unique current limiting selectivity. Since S700 breakers are designed for overvoltage category IV and incorporate isolation function, they are predestinated for the use in any main distribution cabinet or meter board.

The S700 product range is completed by a broad range of accessories. With dedicated adapters, S700 products can be assembled on flat surfaces, on DIN rails or 40 mm busbar systems. To adapt S700 to different installations, they are available 1- to 4-pole with tripping characteristic E and K - optional with factory assembled auxiliary switch.

Number of poles	Rated current	Bbn 4012233	Order details		Price 1 piece	Weight 1 piece	Pack unit
	In A	EAN	Type code	Order code			
1	10	522507	S701-E 10	GHS7015001R0449		0.55	3
	16	522705	S701-E 16	GHS7015001R0469		0.55	3
	20	522903	S701-E 20	GHS7015001R0489		0.55	3
	25	523108	S701-E 25	GHS7015001R0519		0.55	3
	32	523207	S701-E 32	GHS7015001R0529		0.55	3
	35	523405	S701-E 35	GHS7015001R0539		0.55	3
	40	523603	S701-E 40	GHS7015001R0559		0.55	3
	50	523801	S701-E 50	GHS7015001R0579		0.55	3
	63	524006	S701-E 63	GHS7015001R0599		0.55	3
	80	524204	S701-E 80	GHS7015001R0629		0.55	3
100	524402	S701-E 100	GHS7015001R0639		0.55	3	

Number of poles	Rated current	Bbn 40 16779	Order details		Price 1 piece	Weight 1 piece	Pack unit
	In A	EAN	Type code	Order code			
2	16	105200	S702-E 16	GHS7025001R0469		1.1	2
	20	949007 ^①	S702-E 20	GHS7025001R0489		1.1	2
	25	104005	S702-E 25	GHS7025001R0519		1.1	2
	32	105408	S702-E 32	GHS7025001R0529		1.1	2
	35	105309	S702-E 35	GHS7025001R0539		1.1	2
	40	105507	S702-E 40	GHS7025001R0559		1.1	2
	50	105606	S702-E 50	GHS7025001R0579		1.1	2
	63	052009	S702-E 63	GHS7025001R0599		1.1	2
	80	109604	S702-E 80	GHS7025001R0629		1.1	2
	100	062503	S702-E 100	GHS7025001R0639		1.1	2

^① bbn-Nr. 40 12233

Where to find more:

Selectivity Coordination Tables for S 700 MCBs p.10/47
Worldwide Marks and Approvals of MCBs p.11/92

Maybe you are also interested in:

Auxiliary Elements for S 700 MCBs p.4/52

SMCBs
 S700 series 25000 - selective main circuit-breakers,
 E_{selective} characteristic

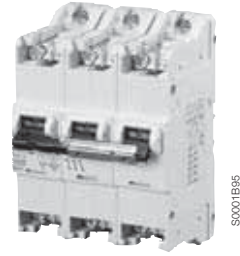

S703

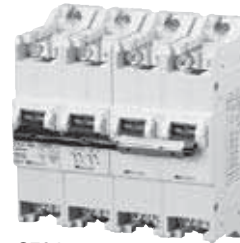

S704

Number of poles	Rated current	Bbn 4012233	Order details		Price 1 piece	Weight 1 piece	Pack unit
	In A	EAN	Type code	Order code			
3	16	865703	S703-E 16	GHS7035001R0469		1.65	1
	20	526307	S703-E 20	GHS7035001R0489		1.65	1
	25	526505	S703-E 25	GHS7035001R0519		1.65	1
	32	526604	S703-E 32	GHS7035001R0529		1.65	1
	35	526802	S703-E 35	GHS7035001R0539		1.65	1
	40	527007	S703-E 40	GHS7035001R0559		1.65	1
	50	527205	S703-E 50	GHS7035001R0579		1.65	1
	63	527403	S703-E 63	GHS7035001R0599		1.65	1
	80	527601	S703-E 80	GHS7035001R0629		1.65	1
	100	527809	S703-E 100	GHS7035001R0639		1.65	1

2

Number of poles	Rated current	Bbn 40 16779	Order details		Price 1 piece	Weight 1 piece	Pack unit
	In A	EAN	Type code	Order code			
4	16	110600	S704-E 16	GHS7045001R0469		2.2	1
	20	110709	S704-E 20	GHS7045001R0489		2.2	1
	25	104104	S704-E 25	GHS7045001R0519		2.2	1
	32	110808	S704-E 32	GHS7045001R0529		2.2	1
	35	104203	S704-E 35	GHS7045001R0539		2.2	1
	40	110907	S704-E 40	GHS7045001R0559		2.2	1
	50	111003	S704-E 50	GHS7045001R0579		2.2	1
	63	111102	S704-E 63	GHS7045001R0599		2.2	1
	80	111201	S704-E 80	GHS7045001R0629		2.2	1
	100	062602	S704-E 100	GHS7045001R0639		2.2	1

SMCBs

S700 series 25000 - selective main circuit-breakers, K_{selective} characteristic



S701



S702

S700 K characteristic

Breakers of the S700 series are selective main circuit-breakers (SMCB) for overcurrent protection in electrical installations. They have total selectivity to downstream mcb's and outstanding selectivity to upstream protective devices due to unique current limiting selectivity. Since S700 breakers are designed for overvoltage category IV and incorporate isolation function, they are predestinated for the use in any main distribution cabinet or meter board.

The S700 product range is completed by a broad range of accessories. With dedicated adapters, S700 products can be assembled on flat surfaces, on DIN rails or 40 mm busbar systems. To adapt S700 to different installations, they are available 1- to 4-pole with tripping characteristic E and K - optional with factory assembled auxiliary switch.

Number of poles	Rated current	Bbn 4012233	Order details		Price 1 piece	Weight 1 piece	Pack unit
	In A	EAN	Type code	Order code			
1	16	522606	S701-K 16	GHS7015001R0467		0.55	3
	20	522804	S701-K 20	GHS7015001R0487		0.55	3
	25	523009	S701-K 25	GHS7015001R0517		0.55	3
	35	523306	S701-K 35	GHS7015001R0537		0.55	3
	40	523504	S701-K 40	GHS7015001R0557		0.55	3
	50	523702	S701-K 50	GHS7015001R0577		0.55	3
	63	523900	S701-K 63	GHS7015001R0597		0.55	3
	80	524105	S701-K 80	GHS7015001R0627		0.55	3
	100	524303	S701-K 100	GHS7015001R0637		0.55	3

Number of poles	Rated current	Bbn 40 16779	Order details		Price 1 piece	Weight 1 piece	Pack unit
	In A	EAN	Type code	Order code			
2	16	109802	S702-K 16	GHS7025001R0467		1.1	2
	20	109703	S702-K 20	GHS7025001R0487		1.1	2
	25	109901	S702-K 25	GHS7025001R0517		1.1	2
	35	110006	S702-K 35	GHS7025001R0537		1.1	2
	40	110105	S702-K 40	GHS7025001R0557		1.1	2
	50	110204	S702-K 50	GHS7025001R0577		1.1	2
	63	110303	S702-K 63	GHS7025001R0597		1.1	2
	80	110402	S702-K 80	GHS7025001R0627		1.1	2
	100	110501	S702-K 100	GHS7025001R0637		1.1	2

Where to find more:

Selectivity Coordination Tables for S 700 MCBs p.10/47
Worldwide Marks and Approvals of MCBs p.11/92

Maybe you are also interested in:
Auxiliary Elements for S 700 MCBs p.4/52

SMCBs
 S700 series 25000 - selective main circuit-breakers,
 K_{selective} characteristic



S703

Number of poles	Rated current	Bbn 4012233	Order details		Price 1 piece	Weight 1 piece	Pack unit
	In A	EAN	Type code	Order code			
3	16	526109	S703-K 16	GHS7035001R0467		1.65	1
	20	526208	S703-K 20	GHS7035001R0487		1.65	1
	25	526406	S703-K 25	GHS7035001R0517		1.65	1
	35	526703	S703-K 35	GHS7035001R0537		1.65	1
	40	526901	S703-K 40	GHS7035001R0557		1.65	1
	50	527106	S703-K 50	GHS7035001R0577		1.65	1
	63	527304	S703-K 63	GHS7035001R0597		1.65	1
	80	527502	S703-K 80	GHS7035001R0627		1.65	1
	100	527700	S703-K 100	GHS7035001R0637		1.65	1

2



S704

Number of poles	Rated current	Bbn 40 16779	Order details		Price 1 piece	Weight 1 piece	Pack unit
	In A	EAN	Type code	Order code			
4	16	111300	S704-K 16	GHS7045001R0467		2.2	1
	20	111409	S704-K 20	GHS7045001R0487		2.2	1
	25	111508	S704-K 25	GHS7045001R0517		2.2	1
	35	111607	S704-K 35	GHS7045001R0537		2.2	1
	40	111706	S704-K 40	GHS7045001R0557		2.2	1
	50	965205 Ⓞ	S704-K 50	GHS7045001R0577		2.2	1
	63	955503 Ⓞ	S704-K 63	GHS7045001R0597		2.2	1
	80	111805	S704-K 80	GHS7045001R0627		2.2	1
	100	111904	S704-K 100	GHS7045001R0637		2.2	1

Ⓞ bbn-Nr. 40 12233

SMCBs

S700 series 25000 - selective main circuit-breakers,

$E_{\text{selective}}$ characteristic + H2WR



S701 + H2WR



S702 + H2WR

S700 E characteristic

Breakers of the S700 series are selective main circuit-breakers (SMCB) for overcurrent protection in electrical installations. They have total selectivity to downstream mcb's and outstanding selectivity to upstream protective devices due to unique current limiting selectivity. Since S700 breakers are designed for overvoltage category IV and incorporate isolation function, they are predestinated for the use in any main distribution cabinet or meter board.

The S700 product range is completed by a broad range of accessories. With dedicated adapters, S700 products can be assembled on flat surfaces, on DIN rails or 40 mm busbar systems. To adapt S700 to different installations, they are available 1- to 4-pole with tripping characteristic E and K - optional with factory assembled auxiliary switch (H2WR).

With factory assembled auxiliary switch (2 change-over contacts)

Number of poles	Rated current	Bbn 4012233	Order details		Price 1 piece	Weight 1 piece	Pack unit
	In A	EAN	Type code	Order code			
1	16	456609	S701-E 16+H2WR	GHS7010316R0469		0.65	3
	20	456708	S701-E 20+H2WR	GHS7010316R0489		0.65	3
	25	456807	S701-E 25+H2WR	GHS7010316R0519		0.65	3
	32	456906	S701-E 32+H2WR	GHS7010316R0529		0.65	3
	35	457002	S701-E 35+H2WR	GHS7010316R0539		0.65	3
	40	457101	S701-E 40+H2WR	GHS7010316R0559		0.65	3
	50	457200	S701-E 50+H2WR	GHS7010316R0579		0.65	3
	63	457309	S701-E 63+H2WR	GHS7010316R0599		0.65	3
	80	457408	S701-E 80+H2WR	GHS7010316R0629		0.65	3
	100	457507	S701-E 100+H2WR	GHS7010316R0639		0.65	3

Number of poles	Rated current	Bbn 4012233	Order details		Price 1 piece	Weight 1 piece	Pack unit
	In A	EAN	Type code	Order code			
2	16	458405	S702-E 16+H2WR	GHS7020316R0469		1.2	2
	20	458504	S702-E 20+H2WR	GHS7020316R0489		1.2	2
	25	458603	S702-E 25+H2WR	GHS7020316R0519		1.2	2
	32	458702	S702-E 32+H2WR	GHS7020316R0529		1.2	2
	35	458801	S702-E 35+H2WR	GHS7020316R0539		1.2	2
	40	458900	S702-E 40+H2WR	GHS7020316R0559		1.2	2
	50	459006	S702-E 50+H2WR	GHS7020316R0579		1.2	2
	63	459105	S702-E 63+H2WR	GHS7020316R0599		1.2	2
	80	459204	S702-E 80+H2WR	GHS7020316R0629		1.2	2
	100	459303	S702-E 100+H2WR	GHS7020316R0639		1.2	2

SMCBs
 S700 series 25000 - selective main circuit-breakers,
 E_{selective} characteristic + H2WR



S703 + H2WR



S704 + H2WR

Number of poles	Rated current	Bbn 4012233	Order details		Price 1 piece	Weight 1 piece	Pack unit
	In A	EAN	Type code	Order code			
3	16	460200	S703-E 16+H2WR	GHS7030316R0469		1.75	1
	20	460309	S703-E 20+H2WR	GHS7030316R0489		1.75	1
	25	460408	S703-E 25+H2WR	GHS7030316R0519		1.75	1
	32	460507	S703-E 32+H2WR	GHS7030316R0529		1.75	1
	35	460606	S703-E 35+H2WR	GHS7030316R0539		1.75	1
	40	460705	S703-E 40+H2WR	GHS7030316R0559		1.75	1
	50	460804	S703-E 50+H2WR	GHS7030316R0579		1.75	1
	63	460903	S703-E 63+H2WR	GHS7030316R0599		1.75	1
	80	461009	S703-E 80+H2WR	GHS7030316R0629		1.75	1
	100	461108	S703-E 100+H2WR	GHS7030316R0639		1.75	1

2

Number of poles	Rated current	Bbn 4012233	Order details		Price 1 piece	Weight 1 piece	Pack unit
	In A	EAN	Type code	Order code			
4	16	462006	S704-E 16+H2WR	GHS7040316R0469		2.3	1
	20	462105	S704-E 20+H2WR	GHS7040316R0489		2.3	1
	25	462204	S704-E 25+H2WR	GHS7040316R0519		2.3	1
	32	462303	S704-E 32+H2WR	GHS7040316R0529		2.3	1
	35	462402	S704-E 35+H2WR	GHS7040316R0539		2.3	1
	40	462501	S704-E 40+H2WR	GHS7040316R0559		2.3	1
	50	462600	S704-E 50+H2WR	GHS7040316R0579		2.3	1
	63	462709	S704-E 63+H2WR	GHS7040316R0599		2.3	1
	80	462808	S704-E 80+H2WR	GHS7040316R0629		2.3	1
	100	462907	S704-E 100+H2WR	GHS7040316R0639		2.3	1

SMCBs

S700 series 25000 - selective main circuit-breakers, K_{selective} characteristic + H2WR



S701 + H2WR



S702 + H2WR

S700 K characteristic

Breakers of the S700 series are selective main circuit-breakers (SMCB) for overcurrent protection in electrical installations. They have total selectivity to downstream mcb's and outstanding selectivity to upstream protective devices due to unique current limiting selectivity. Since S700 breakers are designed for overvoltage category IV and incorporate isolation function, they are predestinated for the use in any main distribution cabinet or meter board.

The S700 product range is completed by a broad range of accessories. With dedicated adapters, S700 products can be assembled on flat surfaces, on DIN rails or 40 mm busbar systems. To adapt S700 to different installations, they are available 1- to 4-pole with tripping characteristic E and K - optional with factory assembled auxiliary switch (H2WR).

With factory assembled auxiliary switch (2 change-over contacts)

Number of poles	Rated current	Bbn 4012233	Order details		Price 1 piece	Weight 1 piece	Pack unit
	In A	EAN	Type code	Order code			
1	16	455800	S701-K 16+H2WR	GHS7010316R0467		0.65	3
	20	455909	S701-K 20+H2WR	GHS7010316R0487		0.65	3
	25	456005	S701-K 25+H2WR	GHS7010316R0517		0.65	3
	35	456104	S701-K 35+H2WR	GHS7010316R0537		0.65	3
	40	456203	S701-K 40+H2WR	GHS7010316R0557		0.65	3
	50	456302	S701-K 50+H2WR	GHS7010316R0577		0.65	3
	63	456401	S701-K 63+H2WR	GHS7010316R0597		0.65	3
	80	499651	S701-K 80+H2WR	GHS7010316R0627		0.65	3
	100	499729	S701-K 100+H2WR	GHS7010316R0637		0.65	3

Number of poles	Rated current	Bbn 4012233	Order details		Price 1 piece	Weight 1 piece	Pack unit
	In A	EAN	Type code	Order code			
2	16	457606	S702-K 16+H2WR	GHS7020316R0467		1.2	2
	20	457705	S702-K 20+H2WR	GHS7020316R0487		1.2	2
	25	457804	S702-K 25+H2WR	GHS7020316R0517		1.2	2
	35	457903	S702-K 35+H2WR	GHS7020316R0537		1.2	2
	40	458009	S702-K 40+H2WR	GHS7020316R0557		1.2	2
	50	458108	S702-K 50+H2WR	GHS7020316R0577		1.2	2
	63	458207	S702-K 63+H2WR	GHS7020316R0597		1.2	2
	80	499750	S702-K 80+H2WR	GHS7020316R0627		1.2	2
	100	499767	S702-K 100+H2WR	GHS7020316R0637		1.2	2

SMCBs
 S700 series 25000 - selective main circuit-breakers,
 K_{selective} characteristic + H2WR



S703 + H2WR

Number of poles	Rated current	Bbn 4012233	Order details		Price 1 piece	Weight 1 piece	Pack unit
	In A	EAN	Type code	Order code			
3	16	459402	S703-K 16+H2WR	GHS7030316R0467		1.75	1
	20	459501	S703-K 20+H2WR	GHS7030316R0487		1.75	1
	25	459600	S703-K 25+H2WR	GHS7030316R0517		1.75	1
	35	459709	S703-K 35+H2WR	GHS7030316R0537		1.75	1
	40	459808	S703-K 40+H2WR	GHS7030316R0557		1.75	1
	50	459907	S703-K 50+H2WR	GHS7030316R0577		1.75	1
	63	460002	S703-K 63+H2WR	GHS7030316R0597		1.75	1
	80	499774	S703-K 80+H2WR	GHS7030316R0627		1.75	1
	100	499781	S703-K 100+H2WR	GHS7030316R0637		1.75	1

2



S704 + H2WR

Number of poles	Rated current	Bbn 4012233	Order details		Price 1 piece	Weight 1 piece	Pack unit
	In A	EAN	Type code	Order code			
4	16	461207	S704-K 16+H2WR	GHS7040316R0467		2.3	1
	20	461306	S704-K 20+H2WR	GHS7040316R0487		2.3	1
	25	461405	S704-K 25+H2WR	GHS7040316R0517		2.3	1
	35	461504	S704-K 35+H2WR	GHS7040316R0537		2.3	1
	40	461603	S704-K 40+H2WR	GHS7040316R0557		2.3	1
	50	461702	S704-K 50+H2WR	GHS7040316R0577		2.3	1
	63	461801	S704-K 63+H2WR	GHS7040316R0597		2.3	1
	80	499798	S704-K 80+H2WR	GHS7040316R0627		2.3	1
	100	499804	S704-K 100+H2WR	GHS7040316R0637		2.3	1

SMCBs

Selective short-circuit current limiter WT63

2



WT63



WT63-3 HS

WT63 characteristic

WT63 is a short-circuit current limiter for 690 V AC applications.

In combination with other ABB devices WT63 offers smart solutions for coordinated motor protection according to IEC/EN 60947-4-1. As a main limiting device, WT63 can increase the short-circuit breaking capability for several groups of motor circuits to high values at 690 V AC. For further information according to selection and installation see the coordination table.

Number of poles	Rated current	Bbn 4016779	Order details		Price 1 piece	Weight 1 piece	Pack unit
	In A	EAN	Type code	Order code		kg	pc.
3	63	510677	WT63-3	2CDH103012R0599		1.65	1

with factory assembled auxiliary switch (2 change-over contacts)

Number of poles	Rated current	Bbn 4016779	Order details		Price 1 piece	Weight 1 piece	Pack unit
	In A	EAN	Type code	Order code		kg	pc.
3	63	510684	WT63-3 HS	2CDH103816R0599		1.75	1

New DS202C. Protection with unrivalled compactness.

With only 2 modules, the DS202C series of 2P residual current circuit breakers with overcurrent protection (RCBOs) enables to save 50% of switchboard space compared to the conventional 4-modules solution. Available in a technologically advanced and comprehensive range, the DS202C can be applied in the tertiary sector, in large-sized industrial plants and in naval applications. The new series perfectly integrates with the System pro M compact® range, starting from the same profile, ensuring a nice and functional design in the installation. The maximum protection in only 2 modules. www.abb.com



2



MCBs

S800 series technical features



S800

		S800S	S803S-KM			
General	Standards	IEC 60947-2, EN 60898-1	IEC / EN 60947-2			
Data	Poles	1 ... 4	3			
	Tripping characteristics	B, C, D, K,	KM			
	Rated current I _b	A 6 ... 125	20 ... 80			
	Rated frequency f	Hz 50 / 60 Hz	50/60 Hz			
	Rated insulation voltage U _i acc. to IEC/EN 60664-1	V 690 V AC	690 V AC			
	Rated impulse withstand voltage U _{imp} (1.2/50µs)	kV 8	8			
	Overvoltage category	IV	IV			
	Pollution degree	3	3			
	Suitability for isolation	yes	yes			
	Data acc. to IEC/EN 60898-1	Rated operational voltage U _e	V 230/400V AC	-		
Min. operating voltage		V 12V AC	-			
Rated short-circuit capacity I _{sc}		kA 25kA (10 ... 80A)	-			
Energy limiting class		-	-			
Reference temperature for tripping characteristics		°C B, C, D: 30° C	-			
Electrical and Mechanical Endurance	ops.	10 ... 32A: 10'000 electrical / mechanical 40 ... 100A: 6'000 electrical / 4'000 mechanical 125A: 4'000 electrical / 6'000 mechanical	-			
	Service short-circuit capacity I _{cs}	kA 12.5kA (10 ... 80A)	-			
Data acc. to IEC/EN 60947-2	Rated operational voltage U _e	V 400/690V AC 1-pole: 125V DC; 2-pole: 250V DC; 3-pole: 375V DC; 4-pole: 500V DC	690V AC			
	Min. operating voltage	V 12V AC	12V AC			
	Rated ultimate short-circuit capacity I _{cu}	kA	AC 240/415V = 50kA AC 254/440V = 30kA AC 400/690V (up to 80A) = 6kA AC 400/690V (100 ... 125A) = 4.5kA DC 125V (1-pole) = 30kA DC 250V (2-pole) = 30kA DC 375V (3-pole) = 30kA DC 500V (4-pole) = 30kA	AC 240/415V = 50kA AC 254/440V = 30kA AC 400/690V (up to 80A) = 6kA AC 400/690V (100 ... 125A) = 4.5kA DC 375V (3-pole) = 30kA		
		Rated service short-circuit capacity I _{cs}	kA	240/415V = 40kA 254/440V (up to 80A) = 22.5kA 254/440V (100 ... 125A) = 15kA 400/690V (up to 80A) = 4kA 400/690V (100 ... 125A) = 3kA DC 125V (1-pole) = 30kA DC 250V (2-pole) = 30kA DC 375V (3-pole) = 30kA DC 500V (4-pole) = 30kA	DC 375V (3-pole) = 30kA	
			Dielectric test voltage	kV acc. to standard	acc. to standard	
			Reference temperature for tripping characteristics	°C B, C, D: 30° K: 40° C	only magnetic release	
			Electrical and Mechanical Endurance	ops.	6 ... 32A: 10'000 electrical / mechanical 40 ... 100A: 6'000 electrical / 4'000 mechanical 125A: 4'000 electrical / 6'000 mechanical	20 ... 32A: 10'000 electrical / mechanical 40 ... 80A: 6'000 electrical / 4'000 mechanical

① (DC) <= 100 A; S800-D125 only IEC 60947-2

S800S-UC	S800N	S800C	S800B
IEC / EN 60947-2	IEC 60947-2, EN 60898-1	EN 60947-2, EN 60898-1	IEC 60947-2
1 ... 4	1 ... 4	1 ... 4	1 ... 4
UCB, UCK	B, C, D	B, C, D, K	B, C, D, K
10 ... 125	6 ... 125	10 ... 125	32 ... 125 (Char. B, C) 32 ... 100 (Char. D, K)
DC	50/60 Hz	50/60 Hz	
750 V DC	690 V AC	500 V AC	440 V AC
8	8	8	4
IV	IV	IV	III
1- and 2-pole: 3 3- and 4-pole: 2	3	3	3
yes	yes	yes	yes
-	230/400V AC	230/400V AC	-
-	12V AC	12V AC	-
-	20kA (10 ... 80A)	15kA	-
-	-	-	-
-	B, C, D: 30° C	B, C, D: 30° C	-
-	10 ... 32A: 10'000 electrical / mechanical 40 ... 100A: 6'000 electrical / 4'000 mechanical 125A: 4'000 electrical / 6'000 mechanical	10 ... 32A: 10'000 electrical / mechanical 40 ... 100A: 6'000 electrical / 4'000 mechanical 125A: 4'000 electrical / 6'000 mechanical	-
-	10kA (10 ... 80A)	7.5kA	-
1-pole: 250V DC 2-pole: 500V DC 3- and 4-pole 750V DC	400/690V AC 1-pole: 125V DC; 2-pole: 250V DC; 3-pole: 375V DC; 4-pole: 500V DC	400/690V AC 1-pole: 125V DC; 2-pole: 250V DC; 3-pole: 375V DC; 4-pole: 500V DC	230/400V AC
-	12V AC	12V AC	12V AC
DC 250V (1-pole) = 50kA DC 500V (2-pole) = 50kA DC 750V (3-pole) = 50kA DC 750V (4-pole) = 50kA	AC240/415V = 36kA AC 254/440V = 20kA AC 400/690V = 4.5kA	AC 240/415V = 25kA AC 254/440V = 15kA	230/400V = 16kA
	DC 125V (1-pole) = 20kA DC 250V (2-pole) = 20kA DC 375V (3-pole) = 20kA DC 500V (4-pole) = 20kA	DC 125V (1-pole) = 10kA DC 250V (2-pole) = 10kA DC 375V (3-pole) = 10kA DC 500V (4-pole) = 10kA	
DC 250V (1-pole) = 50kA DC 500V (2-pole) = 50kA DC 750V (3-pole) = 50kA DC 750V (4-pole) = 50kA	240/415V = 30kA 254/440V (6 ... 80 A) = 15kA 254/440V (100 ... 125A) = 10kA 400/690V = 3kA	240/415V = 18kA 254/440V = 10kA	230/400V = 10kA
	DC 125V (1-pole) = 20kA DC 250V (2-pole) = 20kA DC 375V (3-pole) = 20kA DC 500V (4-pole) = 20kA	DC 125V (1-pole) = 10kA DC 250V (2-pole) = 10kA DC 375V (3-pole) = 10kA DC 500V (4-pole) = 10kA	
acc. to standard	acc. to standard	acc. to standard	acc. to standard
UCB: 30°C; UCK: 40° C	B, C, D: 30°	B, C, D: 30° K: 40° C	B, C, D: 30° K: 40° C
10 ... 100A: 1500 electric; 8500 mechanic 125A: 1000 electric, 7000 mechanic	6 ... 32A: 10'000 electrical / mechanical 40 ... 100A: 6'000 electrical / 4'000 mechanical 125A: 4'000 electrical / 6'000 mechanical	10 ... 32A: 10'000 electrical / mechanical 40 ... 100A: 6'000 electrical / 4'000 mechanical 125A: 4'000 electrical / 6'000 mechanical	32 ... 100A: 1500 electric; 8500 mechanic 125A: 1000 electric, 7000 mechanic

MCBs

S800 series technical features



		S800S	S803S-KM	
Mechanical Data	Housing	Material group I, RAL 7035		
	Toggle	black, lockable		
	Classification acc. To NF F 126-101, NF F 16-102	I3, F2		
	Protection degree acc. to EN 60529	IP20; IP40(actuating end only)		
	Mechanical endurance	ops.	10'000 cycles	
	Shock resistance acc. to IEC/EN 60068-2-30	IEC 61373 Cat. 1 Class B, 5g / 30ms acc. To IEC 60068-27 Test Ea		
	Vibration resistance acc. to IEC/EN 60068-2-6	IEC 60068-2-6 Test Fc; 2 - 13.2Hz / 1mm 13.2 - 100Hz / 0.7g with load 100% x le		
	Environmental conditions (damp heat) acc. to IEC/EN 60068-2-30	°C/ RH	12 + 12 cycle with 55°C / 90-96% and 25% / 95-100%	
	Environmental conditions (dry heat) acc. to IEC/EN 60068-2-2 Test B	°C/ RH	16 hours 55°C / 2 hours 70°C with damp heat 55%	
	Ambient temperature	°C	-25... + 60	
Storage temperature	°C	-40... + 70		
Installation	Terminal	Failsafe cage or ringlug terminal		
	Stranded Cross-section of conductors (top / bottom)	mm ²	1 ... 50	1 ... 50
		AWG		
	Flexible Cross-section of conductors (top/bottom)	mm ²	1 ... 70	1 ... 70
		AWG		
	Tightening torque	Nm	3,5	
		in- lbs.	31	
	Screwdriver		POZI 2	
	Mounting		EN 60715	
	Mounting position		any	
Supply		any		
Dimensions and weight	Pole dimensions (H x L x W)	mm	82.5 x 95 x 26.5	
	Pole weight	g	ca. 240 g	ca. 740 g
Combination with aux. elements	Auxiliary contact	Yes		
	Combined auxiliary- / signal contact	Yes		
	Shunt trip	Yes		
	Undervoltage release	Yes		
	Shunt open release	Yes		
Motor Operating Device	Yes			

① (DC) <= 100 A; S800-D125 only IEC 60947-2

High performance MCBs

S800S series 50000 with cage terminal, B characteristic

2



S801S



S802S

S800S-B characteristic

Function: protection and control of the circuits against overloads and short-circuits when a high breaking capacity is required; protection for people and big length cables in TN and IT systems; very useful when selectivity is needed vs an MCCB or back-up vs other MCBs wired downstream.

Applications: commercial and industrial.

Standard: IEC/EN 60898, IEC/EN 60947-2

Icn=25kA (10 ... 80A)

Icu=50 kA

Number of poles	Rated current	Bbn 7612271	Order details		Price 1 piece	Weight 1 piece kg	Pack unit pc.
	In A	EAN	Type code	Order code			
1	6	408107	S801S-B6	2CCS861001R0065		0.245	1
	8	411329	S801S-B8	2CCS861001R0085		0.245	1
	10	200008	S801S-B10	2CCS861001R0105		0.245	1
	13	200015	S801S-B13	2CCS861001R0135		0.245	1
	16	200022	S801S-B16	2CCS861001R0165		0.245	1
	20	200039	S801S-B20	2CCS861001R0205		0.245	1
	25	200046	S801S-B25	2CCS861001R0255		0.245	1
	32	200053	S801S-B32	2CCS861001R0325		0.245	1
	40	200060	S801S-B40	2CCS861001R0405		0.245	1
	50	200077	S801S-B50	2CCS861001R0505		0.245	1
	63	200084	S801S-B63	2CCS861001R0635		0.245	1
	80	200091	S801S-B80	2CCS861001R0805		0.245	1
	100	200107	S801S-B100	2CCS861001R0825		0.245	1
	125	200114	S801S-B125	2CCS861001R0845		0.245	1

Number of poles	Rated current	Bbn 7612271	Order details		Price 1 piece	Weight 1 piece kg	Pack unit pc.
	In A	EAN	Type code	Order code			
2	6	408114	S802S-B6	2CCS862001R0065		0.49	1
	8	411336	S802S-B8	2CCS862001R0085		0.49	1
	10	200121	S802S-B10	2CCS862001R0105		0.49	1
	13	200138	S802S-B13	2CCS862001R0135		0.49	1
	16	200145	S802S-B16	2CCS862001R0165		0.49	1
	20	200152	S802S-B20	2CCS862001R0205		0.49	1
	25	200169	S802S-B25	2CCS862001R0255		0.49	1
	32	200176	S802S-B32	2CCS862001R0325		0.49	1
	40	200183	S802S-B40	2CCS862001R0405		0.49	1
	50	200190	S802S-B50	2CCS862001R0505		0.49	1
	63	200206	S802S-B63	2CCS862001R0635		0.49	1
	80	200213	S802S-B80	2CCS862001R0805		0.49	1
	100	200220	S802S-B100	2CCS862001R0825		0.49	1
	125	200237	S802S-B125	2CCS862001R0845		0.49	1

Where to find more:

Coordination Tables for S 800S MCBs: p.10/37 for back-up and p.10/50 for selectivity. For additional information download Back-up and Selectivity of S800 MCBs technical document (code 2CC451039L0207)



Worldwide Marks and Approvals of MCBs p.11/92

Frequently asked question - FAQ:

Where can I get certificates and declaration? You can find all of them on www.abb.com

Maybe you are also interested in:

Auxiliary Elements for S 800 MCBs p.4/53 and p.4/62



S803S



S804S

Number of poles	Rated current	Bbn 7612271	Order details		Price 1 piece	Weight 1 piece kg	Pack unit pc.
	In A	EAN	Type code	Order code			
3	6	408121	S803S-B6	2CCS863001R0065		0.735	1
	8	411343	S803S-B8	2CCS863001R0085		0.735	1
	10	200244	S803S-B10	2CCS863001R0105		0.735	1
	13	200251	S803S-B13	2CCS863001R0135		0.735	1
	16	200268	S803S-B16	2CCS863001R0165		0.735	1
	20	200275	S803S-B20	2CCS863001R0205		0.735	1
	25	200282	S803S-B25	2CCS863001R0255		0.735	1
	32	200299	S803S-B32	2CCS863001R0325		0.735	1
	40	200305	S803S-B40	2CCS863001R0405		0.735	1
	50	200312	S803S-B50	2CCS863001R0505		0.735	1
	63	200329	S803S-B63	2CCS863001R0635		0.735	1
	80	200336	S803S-B80	2CCS863001R0805		0.735	1
	100	200343	S803S-B100	2CCS863001R0825		0.735	1
	125	200350	S803S-B125	2CCS863001R0845		0.735	1

2

Number of poles	Rated current	Bbn 7612271	Order details		Price 1 piece	Weight 1 piece kg	Pack unit pc.
	In A	EAN	Type code	Order code			
4	6	408138	S804S-B6	2CCS864001R0065		0.98	1
	8	411350	S804S-B8	2CCS864001R0085		0.98	1
	10	200367	S804S-B10	2CCS864001R0105		0.98	1
	13	200374	S804S-B13	2CCS864001R0135		0.98	1
	16	200381	S804S-B16	2CCS864001R0165		0.98	1
	20	200398	S804S-B20	2CCS864001R0205		0.98	1
	25	200404	S804S-B25	2CCS864001R0255		0.98	1
	32	200411	S804S-B32	2CCS864001R0325		0.98	1
	40	200428	S804S-B40	2CCS864001R0405		0.98	1
	50	200435	S804S-B50	2CCS864001R0505		0.98	1
	63	200442	S804S-B63	2CCS864001R0635		0.98	1
	80	200459	S804S-B80	2CCS864001R0805		0.98	1
	100	200466	S804S-B100	2CCS864001R0825		0.98	1
	125	200473	S804S-B125	2CCS864001R0845		0.98	1

High performance MCBs

S800S series 50000 with ring terminal connection, B characteristic

2



S801S



S802S

S800S-B characteristic

Function: protection and control of the circuits against overloads and short-circuits when a high breaking capacity is required; protection for people and big length cables in TN and IT systems; very useful when selectivity is needed vs an MCCB or back-up vs other MCBs wired downstream.

Applications: commercial and industrial.

Standard: IEC/EN 60898, IEC/EN 60947-2

Icn=25kA (10 ... 80A)

Icu=50 kA

Number of poles	Rated current	Bbn 7612271	Order details		Price 1 piece	Weight 1 piece	Pack unit
	In A	EAN	Type code	Order code			
1	6	408268	S801S-B6-R	2CCS861002R0065		0,245	1
	8	411480	S801S-B8-R	2CCS861002R0085		0,245	1
	10	209636	S801S-B10-R	2CCS861002R0105		0,245	1
	13	209643	S801S-B13-R	2CCS861002R0135		0,245	1
	16	209650	S801S-B16-R	2CCS861002R0165		0,245	1
	20	209667	S801S-B20-R	2CCS861002R0205		0,245	1
	25	209674	S801S-B25-R	2CCS861002R0255		0,245	1
	32	209681	S801S-B32-R	2CCS861002R0325		0,245	1
	40	206826	S801S-B40-R	2CCS861002R0405		0,245	1
	50	206833	S801S-B50-R	2CCS861002R0505		0,245	1
	63	206840	S801S-B63-R	2CCS861002R0635		0,245	1
	80	206857	S801S-B80-R	2CCS861002R0805		0,245	1
	100	206864	S801S-B100-R	2CCS861002R0825		0,245	1
	125	206871	S801S-B125-R	2CCS861002R0845		0,245	1

Number of poles	Rated current	Bbn 7612271	Order details		Price 1 piece	Weight 1 piece	Pack unit
	In A	EAN	Type code	Order code			
2	6	408275	S802S-B6-R	2CCS862002R0065		0,49	1
	8	411497	S802S-B8-R	2CCS862002R0085		0,49	1
	10	209698	S802S-B10-R	2CCS862002R0105		0,49	1
	13	209704	S802S-B13-R	2CCS862002R0135		0,49	1
	16	209711	S802S-B16-R	2CCS862002R0165		0,49	1
	20	209728	S802S-B20-R	2CCS862002R0205		0,49	1
	25	209735	S802S-B25-R	2CCS862002R0255		0,49	1
	32	209742	S802S-B32-R	2CCS862002R0325		0,49	1
	40	206888	S802S-B40-R	2CCS862002R0405		0,49	1
	50	206895	S802S-B50-R	2CCS862002R0505		0,49	1
	63	206901	S802S-B63-R	2CCS862002R0635		0,49	1
	80	206918	S802S-B80-R	2CCS862002R0805		0,49	1
	100	206925	S802S-B100-R	2CCS862002R0825		0,49	1
	125	206932	S802S-B125-R	2CCS862002R0845		0,49	1

Where to find more:

Coordination Tables for S 800S MCBs: p.10/37 for back-up and p.10/50 for selectivity. For additional information download Back-up and Selectivity of S800 MCBs technical document (code 2CCC451039L0207)



Worldwide Marks and Approvals of MCBs p.11/92

Frequently asked question - FAQ:

Where can I get certificates and declaration? You can find all of them on www.abb.com

Maybe you are also interested in:

Auxiliary Elements for S 800 MCBs p.4/53 and p.4/62



S803S



S804S

Number of poles	Rated current	Bbn 7612271	Order details		Price 1 piece	Weight 1 piece kg	Pack unit pc.
	In A	EAN	Type code	Order code			
3	6	408282	S803S-B6-R	2CCS863002R0065		0,735	1
	8	411503	S803S-B8-R	2CCS863002R0085		0,735	1
	10	209759	S803S-B10-R	2CCS863002R0105		0,735	1
	13	209766	S803S-B13-R	2CCS863002R0135		0,735	1
	16	209773	S803S-B16-R	2CCS863002R0165		0,735	1
	20	209780	S803S-B20-R	2CCS863002R0205		0,735	1
	25	209797	S803S-B25-R	2CCS863002R0255		0,735	1
	32	209803	S803S-B32-R	2CCS863002R0325		0,735	1
	40	206949	S803S-B40-R	2CCS863002R0405		0,735	1
	50	206956	S803S-B50-R	2CCS863002R0505		0,735	1
	63	206963	S803S-B63-R	2CCS863002R0635		0,735	1
	80	206970	S803S-B80-R	2CCS863002R0805		0,735	1
	100	206987	S803S-B100-R	2CCS863002R0825		0,735	1
	125	206994	S803S-B125-R	2CCS863002R0845		0,735	1

2

Number of poles	Rated current	Bbn 7612271	Order details		Price 1 piece	Weight 1 piece kg	Pack unit pc.
	In A	EAN	Type code	Order code			
4	6	408299	S804S-B6-R	2CCS864002R0065		0,98	1
	8	411510	S804S-B8-R	2CCS864002R0085		0,98	1
	10	209810	S804S-B10-R	2CCS864002R0105		0,98	1
	13	209827	S804S-B13-R	2CCS864002R0135		0,98	1
	16	209834	S804S-B16-R	2CCS864002R0165		0,98	1
	20	209841	S804S-B20-R	2CCS864002R0205		0,98	1
	25	209858	S804S-B25-R	2CCS864002R0255		0,98	1
	32	209865	S804S-B32-R	2CCS864002R0325		0,98	1
	40	207007	S804S-B40-R	2CCS864002R0405		0,98	1
	50	207014	S804S-B50-R	2CCS864002R0505		0,98	1
	63	207021	S804S-B63-R	2CCS864002R0635		0,98	1
	80	207038	S804S-B80-R	2CCS864002R0805		0,98	1
	100	207045	S804S-B100-R	2CCS864002R0825		0,98	1
	125	207052	S804S-B125-R	2CCS864002R0845		0,98	1

High performance MCBs

S800S series 50000 with cage terminal, C characteristic

2



S801S



S802S

S800S-C characteristic

Function: protection and control of the circuits against overloads and short-circuits when a high breaking capacity is required; protection for resistive and inductive loads with low inrush current; very useful when selectivity is needed vs an MCCB or back-up vs other MCBs wired downstream.

Applications: commercial and industrial.

Standard: IEC/EN 60898, IEC/EN 60947-2

Icn=25kA (10 ... 80A)

Icu=50 kA

Number of poles	Rated current	Bbn 7612271	Order details		Price 1 piece	Weight 1 piece kg	Pack unit pc.
	In A	EAN	Type code	Order code			
1	6	408145	S801S-C6	2CCS861001R0064		0.245	1
	8	411367	S801S-C8	2CCS861001R0084		0.245	1
	10	200480	S801S-C10	2CCS861001R0104		0.245	1
	13	200497	S801S-C13	2CCS861001R0134		0.245	1
	16	200503	S801S-C16	2CCS861001R0164		0.245	1
	20	200510	S801S-C20	2CCS861001R0204		0.245	1
	25	200527	S801S-C25	2CCS861001R0254		0.245	1
	32	200534	S801S-C32	2CCS861001R0324		0.245	1
	40	200541	S801S-C40	2CCS861001R0404		0.245	1
	50	200558	S801S-C50	2CCS861001R0504		0.245	1
	63	200565	S801S-C63	2CCS861001R0634		0.245	1
	80	200572	S801S-C80	2CCS861001R0804		0.245	1
	100	200589	S801S-C100	2CCS861001R0824		0.245	1
	125	200596	S801S-C125	2CCS861001R0844		0.245	1

Number of poles	Rated current	Bbn 7612271	Order details		Price 1 piece	Weight 1 piece kg	Pack unit pc.
	In A	EAN	Type code	Order code			
2	6	408152	S802S-C6	2CCS862001R0064		0.49	1
	8	411374	S802S-C8	2CCS862001R0084		0.49	1
	10	200602	S802S-C10	2CCS862001R0104		0.49	1
	13	200619	S802S-C13	2CCS862001R0134		0.49	1
	16	200626	S802S-C16	2CCS862001R0164		0.49	1
	20	200633	S802S-C20	2CCS862001R0204		0.49	1
	25	200640	S802S-C25	2CCS862001R0254		0.49	1
	32	200657	S802S-C32	2CCS862001R0324		0.49	1
	40	200664	S802S-C40	2CCS862001R0404		0.49	1
	50	200671	S802S-C50	2CCS862001R0504		0.49	1
	63	200688	S802S-C63	2CCS862001R0634		0.49	1
	80	200695	S802S-C80	2CCS862001R0804		0.49	1
	100	200701	S802S-C100	2CCS862001R0824		0.49	1
	125	200718	S802S-C125	2CCS862001R0844		0.49	1

Where to find more:

Coordination Tables for S 800S MCBs: p.10/37 for back-up and p.10/50 for selectivity. For additional information download Back-up and Selectivity of S800 MCBs technical document (code 2CCC451039L0207)



Worldwide Marks and Approvals of MCBs p.11/92

Frequently asked question - FAQ:

Where can I get certificates and declaration? You can find all of them on www.abb.com

Maybe you are also interested in:

Auxiliary Elements for S 800 MCBs p.4/53 and p.4/62



S803S

2CCS413008F0002



S804S

2CCS413008F0002

Number of poles	Rated current	Bbn 7612271	Order details		Price 1 piece	Weight 1 piece kg	Pack unit pc.
	In A	EAN	Type code	Order code			
3	6	408169	S803S-C6	2CCS863001R0064		0.735	1
	8	411381	S803S-C8	2CCS863001R0084		0.735	1
	10	200725	S803S-C10	2CCS863001R0104		0.735	1
	13	200732	S803S-C13	2CCS863001R0134		0.735	1
	16	200749	S803S-C16	2CCS863001R0164		0.735	1
	20	200756	S803S-C20	2CCS863001R0204		0.735	1
	25	200763	S803S-C25	2CCS863001R0254		0.735	1
	32	200770	S803S-C32	2CCS863001R0324		0.735	1
	40	200787	S803S-C40	2CCS863001R0404		0.735	1
	50	200794	S803S-C50	2CCS863001R0504		0.735	1
	63	200800	S803S-C63	2CCS863001R0634		0.735	1
	80	200817	S803S-C80	2CCS863001R0804		0.735	1
	100	200824	S803S-C100	2CCS863001R0824		0.735	1
	125	200831	S803S-C125	2CCS863001R0844		0.735	1

2

Number of poles	Rated current	Bbn 7612271	Order details		Price 1 piece	Weight 1 piece kg	Pack unit pc.
	In A	EAN	Type code	Order code			
4	6	408176	S804S-C6	2CCS864001R0064		0.98	1
	8	411398	S804S-C8	2CCS864001R0084		0.98	1
	10	200848	S804S-C10	2CCS864001R0104		0.98	1
	13	200855	S804S-C13	2CCS864001R0134		0.98	1
	16	200862	S804S-C16	2CCS864001R0164		0.98	1
	20	200879	S804S-C20	2CCS864001R0204		0.98	1
	25	200886	S804S-C25	2CCS864001R0254		0.98	1
	32	200893	S804S-C32	2CCS864001R0324		0.98	1
	40	200909	S804S-C40	2CCS864001R0404		0.98	1
	50	200916	S804S-C50	2CCS864001R0504		0.98	1
	63	200923	S804S-C63	2CCS864001R0634		0.98	1
	80	200930	S804S-C80	2CCS864001R0804		0.98	1
	100	200947	S804S-C100	2CCS864001R0824		0.98	1
	125	200954	S804S-C125	2CCS864001R0844		0.98	1

High performance MCBs

S800S series 50000 with ring terminal connection, C characteristic

2



S801S



S802S

S800S-C characteristic

Function: protection and control of the circuits against overloads and short-circuits when a high breaking capacity is required; protection for resistive and inductive loads with low inrush current; very useful when selectivity is needed vs an MCCB or back-up vs other MCBs wired downstream.

Applications: commercial and industrial.

Standard: IEC/EN 60947-2, IEC/EN 60898

Icn=25kA (10 ... 80A)

Icu=50 kA

Number of poles	Rated current	Bbn 7612271	Order details		Price 1 piece	Weight 1 piece kg	Pack unit pc.
	In A	EAN	Type code	Order code			
1	6	408305	S801S-C6-R	2CCS861002R0064		0,245	1
	8	411527	S801S-C8-R	2CCS861002R0084		0,245	1
	10	209872	S801S-C10-R	2CCS861002R0104		0,245	1
	13	209889	S801S-C13-R	2CCS861002R0134		0,245	1
	16	209896	S801S-C16-R	2CCS861002R0164		0,245	1
	20	209902	S801S-C20-R	2CCS861002R0204		0,245	1
	25	209919	S801S-C25-R	2CCS861002R0254		0,245	1
	32	209926	S801S-C32-R	2CCS861002R0324		0,245	1
	40	207069	S801S-C40-R	2CCS861002R0404		0,245	1
	50	207076	S801S-C50-R	2CCS861002R0504		0,245	1
	63	207083	S801S-C63-R	2CCS861002R0634		0,245	1
	80	207090	S801S-C80-R	2CCS861002R0804		0,245	1
	100	207106	S801S-C100-R	2CCS861002R0824		0,245	1
	125	207113	S801S-C125-R	2CCS861002R0844		0,245	1

Number of poles	Rated current	Bbn 7612271	Order details		Price 1 piece	Weight 1 piece kg	Pack unit pc.
	In A	EAN	Type code	Order code			
2	6	408312	S802S-C6-R	2CCS862002R0064		0,49	1
	8	411534	S802S-C8-R	2CCS862001R0084		0,49	1
	10	209933	S802S-C10-R	2CCS862002R0104		0,49	1
	13	209940	S802S-C13-R	2CCS862002R0134		0,49	1
	16	209957	S802S-C16-R	2CCS862002R0164		0,49	1
	20	209964	S802S-C20-R	2CCS862002R0204		0,49	1
	25	209971	S802S-C25-R	2CCS862002R0254		0,49	1
	32	209988	S802S-C32-R	2CCS862002R0324		0,49	1
	40	207120	S802S-C40-R	2CCS862002R0404		0,49	1
	50	207137	S802S-C50-R	2CCS862002R0504		0,49	1
	63	207144	S802S-C63-R	2CCS862002R0634		0,49	1
	80	207151	S802S-C80-R	2CCS862002R0804		0,49	1
	100	207168	S802S-C100-R	2CCS862002R0824		0,49	1
	125	207175	S802S-C125-R	2CCS862002R0844		0,49	1

Where to find more:

Coordination Tables for S 800S MCBs: p.10/37 for back-up and p.10/50 for selectivity. For additional information download Back-up and Selectivity of S800 MCBs technical document (code 2CCC451039L0207)



Worldwide Marks and Approvals of MCBs p.11/92

Frequently asked question - FAQ:

Where can I get certificates and declaration? You can find all of them on www.abb.com

Maybe you are also interested in:

Auxiliary Elements for S 800 MCBs p.4/53 and p.4/62



S803S



S804S

Number of poles	Rated current	Bbn 7612271	Order details		Price 1 piece	Weight 1 piece kg	Pack unit pc.
	In A	EAN	Type code	Order code			
3	6	408329	S803S-C6-R	2CCS863002R0064		0,735	1
	8	411541	S803S-C8-R	2CCS863002R0084		0,735	1
	10	209995	S803S-C10-R	2CCS863002R0104		0,735	1
	13	210007	S803S-C13-R	2CCS863002R0134		0,735	1
	16	210014	S803S-C16-R	2CCS863002R0164		0,735	1
	20	210021	S803S-C20-R	2CCS863002R0204		0,735	1
	25	210038	S803S-C25-R	2CCS863002R0254		0,735	1
	32	210045	S803S-C32-R	2CCS863002R0324		0,735	1
	40	207182	S803S-C40-R	2CCS863002R0404		0,735	1
	50	207199	S803S-C50-R	2CCS863002R0504		0,735	1
	63	207205	S803S-C63-R	2CCS863002R0634		0,735	1
	80	207212	S803S-C80-R	2CCS863002R0804		0,735	1
	100	207229	S803S-C100-R	2CCS863002R0824		0,735	1
	125	207236	S803S-C125-R	2CCS863002R0844		0,735	1

2

Number of poles	Rated current	Bbn 7612271	Order details		Price 1 piece	Weight 1 piece kg	Pack unit pc.
	In A	EAN	Type code	Order code			
4	6	408336	S804S-C6-R	2CCS864002R0064		0,98	1
	8	411558	S804S-C8-R	2CCS864002R0084		0,98	1
	10	210052	S804S-C10-R	2CCS864002R0104		0,98	1
	13	210069	S804S-C13-R	2CCS864002R0134		0,98	1
	16	210076	S804S-C16-R	2CCS864002R0164		0,98	1
	20	210083	S804S-C20-R	2CCS864002R0204		0,98	1
	25	210090	S804S-C25-R	2CCS864002R0254		0,98	1
	32	210106	S804S-C32-R	2CCS864002R0324		0,98	1
	40	207243	S804S-C40-R	2CCS864002R0404		0,98	1
	50	207250	S804S-C50-R	2CCS864002R0504		0,98	1
	63	207267	S804S-C63-R	2CCS864002R0634		0,98	1
	80	207274	S804S-C80-R	2CCS864002R0804		0,98	1
	100	207281	S804S-C100-R	2CCS864002R0824		0,98	1
	125	207298	S804S-C125-R	2CCS864002R0844		0,98	1

High performance MCBs

S800S series 50000 with cage terminal, D characteristic



S801S



S802S

S800S-D characteristic

Function: protection and control of the circuits against overloads and short-circuits when a high breaking capacity is required; protection for circuits which supply loads with high inrush current at the circuit closing (motors, LV / LV transformers, breakdown lamps); very useful when selectivity is needed vs an MCCB or back-up vs other MCBs wired downstream.

Applications: commercial and industrial.

Standard: IEC/EN 60898, IEC/EN 60947-2

Icn=25kA (10 ... 80A)

Icu=50 kA

Number of poles	Rated current	Bbn 7612271	Order details		Price 1 piece	Weight 1 piece kg	Pack unit pc.
	In A	EAN	Type code	Order code			
1	6	408183	S801S-D6	2CCS861001R0061		0.245	1
	8	411404	S801S-D8	2CCS861001R0081		0.245	1
	10	200961	S801S-D10	2CCS861001R0101		0.245	1
	13	200978	S801S-D13	2CCS861001R0131		0.245	1
	16	200985	S801S-D16	2CCS861001R0161		0.245	1
	20	200992	S801S-D20	2CCS861001R0201		0.245	1
	25	201005	S801S-D25	2CCS861001R0251		0.245	1
	32	201012	S801S-D32	2CCS861001R0321		0.245	1
	40	201029	S801S-D40	2CCS861001R0401		0.245	1
	50	201036	S801S-D50	2CCS861001R0501		0.245	1
	63	201043	S801S-D63	2CCS861001R0631		0.245	1
	80	201050	S801S-D80	2CCS861001R0801		0.245	1
	100	201067	S801S-D100	2CCS861001R0821		0.245	1
	125	201074	S801S-D125	2CCS861001R0841		0.245	1

Number of poles	Rated current	Bbn 7612271	Order details		Price 1 piece	Weight 1 piece kg	Pack unit pc.
	In A	EAN	Type code	Order code			
2	6	408190	S802S-D6	2CCS862001R0061		0.49	1
	8	411411	S802S-D8	2CCS862001R0081		0.49	1
	10	201081	S802S-D10	2CCS862001R0101		0.49	1
	13	201098	S802S-D13	2CCS862001R0131		0.49	1
	16	201104	S802S-D16	2CCS862001R0161		0.49	1
	20	201111	S802S-D20	2CCS862001R0201		0.49	1
	25	201128	S802S-D25	2CCS862001R0251		0.49	1
	32	201135	S802S-D32	2CCS862001R0321		0.49	1
	40	201142	S802S-D40	2CCS862001R0401		0.49	1
	50	201159	S802S-D50	2CCS862001R0501		0.49	1
	63	201166	S802S-D63	2CCS862001R0631		0.49	1
	80	201173	S802S-D80	2CCS862001R0801		0.49	1
	100	201180	S802S-D100	2CCS862001R0821		0.49	1
	125	201197	S802S-D125	2CCS862001R0841		0.49	1

Where to find more:

Coordination Tables for S 800S MCBs: p.10/37 for back-up and p.10/50 for selectivity. For additional information download Back-up and Selectivity of S800 MCBs technical document (code 2CCC451039L0207)



Worldwide Marks and Approvals of MCBs p.11/92

Frequently asked question - FAQ:

Where can I get certificates and declaration? You can find all of them on www.abb.com

Maybe you are also interested in:

Auxiliary Elements for S 800 MCBs p.4/53 and p.4/62



S803S

2CCS41301R0002



S804S

2CCS41301R0002

Number of poles	Rated current	Bbn 7612271	Order details		Price 1 piece	Weight 1 piece kg	Pack unit pc.
	In A	EAN	Type code	Order code			
3	6	408206	S803S-D6	2CCS863001R0061		0.735	1
	8	411428	S803S-D8	2CCS863001R0081		0.735	1
	10	201203	S803S-D10	2CCS863001R0101		0.735	1
	13	201210	S803S-D13	2CCS863001R0131		0.735	1
	16	201227	S803S-D16	2CCS863001R0161		0.735	1
	20	201234	S803S-D20	2CCS863001R0201		0.735	1
	25	201241	S803S-D25	2CCS863001R0251		0.735	1
	32	201258	S803S-D32	2CCS863001R0321		0.735	1
	40	201265	S803S-D40	2CCS863001R0401		0.735	1
	50	201272	S803S-D50	2CCS863001R0501		0.735	1
	63	201289	S803S-D63	2CCS863001R0631		0.735	1
	80	201296	S803S-D80	2CCS863001R0801		0.735	1
	100	201302	S803S-D100	2CCS863001R0821		0.735	1
	125	201319	S803S-D125	2CCS863001R0841		0.735	1

2

Number of poles	Rated current	Bbn 7612271	Order details		Price 1 piece	Weight 1 piece kg	Pack unit pc.
	In A	EAN	Type code	Order code			
4	6	408213	S804S-D6	2CCS864001R0061		0.98	1
	8	411435	S804S-D8	2CCS864001R0081		0.98	1
	10	201326	S804S-D10	2CCS864001R0101		0.98	1
	13	201333	S804S-D13	2CCS864001R0131		0.98	1
	16	201340	S804S-D16	2CCS864001R0161		0.98	1
	20	201357	S804S-D20	2CCS864001R0201		0.98	1
	25	201364	S804S-D25	2CCS864001R0251		0.98	1
	32	201371	S804S-D32	2CCS864001R0321		0.98	1
	40	201388	S804S-D40	2CCS864001R0401		0.98	1
	50	201395	S804S-D50	2CCS864001R0501		0.98	1
	63	201401	S804S-D63	2CCS864001R0631		0.98	1
	80	201418	S804S-D80	2CCS864001R0801		0.98	1
	100	201425	S804S-D100	2CCS864001R0821		0.98	1
	125	201432	S804S-D125	2CCS864001R0841		0.98	1

High performance MCBs

S800S series 50000 with ring terminal connection, D characteristic

2



S801S



S802S

S800S-D characteristic

Function: protection and control of the circuits against overloads and short-circuits when a high breaking capacity is required; protection for circuits which supply loads with high inrush current at the circuit closing (motors, LV / LV transformers, breakdown lamps); very useful when selectivity is needed vs an MCCB or back-up vs other MCBs wired downstream.

Applications: commercial and industrial.

Standard: IEC/EN 60947-2, IEC/EN 60898

Icn=25kA (10 ... 80A)

Icu=50 kA

Number of poles	Rated current	Bbn 7612271	Order details		Price 1 piece	Weight 1 piece	Pack unit
	In A	EAN	Type code	Order code			
1	6	408343	S801S-D6-R	2CCS861002R0061		0,245	1
	8	411565	S801S-D8-R	2CCS861002R0081		0,245	1
	10	210113	S801S-D10-R	2CCS861002R0101		0,245	1
	13	210120	S801S-D13-R	2CCS861002R0131		0,245	1
	16	210137	S801S-D16-R	2CCS861002R0161		0,245	1
	20	210144	S801S-D20-R	2CCS861002R0201		0,245	1
	25	210151	S801S-D25-R	2CCS861002R0251		0,245	1
	32	210168	S801S-D32-R	2CCS861002R0321		0,245	1
	40	207304	S801S-D40-R	2CCS861002R0401		0,245	1
	50	207311	S801S-D50-R	2CCS861002R0501		0,245	1
	63	207328	S801S-D63-R	2CCS861002R0631		0,245	1
	80	207335	S801S-D80-R	2CCS861002R0801		0,245	1
	100	207342	S801S-D100-R	2CCS861002R0821		0,245	1
	125	207359	S801S-D125-R	2CCS861002R0841		0,245	1

Number of poles	Rated current	Bbn 7612271	Order details		Price 1 piece	Weight 1 piece	Pack unit
	In A	EAN	Type code	Order code			
2	6	408350	S802S-D6-R	2CCS862002R0061		0,49	1
	8	411572	S802S-D8-R	2CCS862002R0081		0,49	1
	10	210175	S802S-D10-R	2CCS862002R0101		0,49	1
	13	210182	S802S-D13-R	2CCS862002R0131		0,49	1
	16	210199	S802S-D16-R	2CCS862002R0161		0,49	1
	20	210205	S802S-D20-R	2CCS862002R0201		0,49	1
	25	210212	S802S-D25-R	2CCS862002R0251		0,49	1
	32	210229	S802S-D32-R	2CCS862002R0321		0,49	1
	40	207366	S802S-D40-R	2CCS862002R0401		0,49	1
	50	207373	S802S-D50-R	2CCS862002R0501		0,49	1
	63	207380	S802S-D63-R	2CCS862002R0631		0,49	1
	80	207397	S802S-D80-R	2CCS862002R0801		0,49	1
	100	207403	S802S-D100-R	2CCS862002R0821		0,49	1
	125	207410	S802S-D125-R	2CCS862002R0841		0,49	1

Where to find more:

Coordination Tables for S 800S MCBs: p.10/37 for back-up and p.10/50 for selectivity. For additional information download Back-up and Selectivity of S800 MCBs technical document (code 2CCC451039L0207)



Worldwide Marks and Approvals of MCBs p.11/92

Frequently asked question - FAQ:

Where can I get certificates and declaration? You can find all of them on www.abb.com

Maybe you are also interested in:

Auxiliary Elements for S 800 MCBs p.4/53 and p.4/62



S803S

2CCS41308RF003



S804S

2CCS41308RF003

Number of poles	Rated current	Bbn 7612271	Order details		Price 1 piece	Weight 1 piece kg	Pack unit pc.
	In A	EAN	Type code	Order code			
3	6	408367	S803S-D6-R	2CCS863002R0061		0,735	1
	8	411589	S803S-D8-R	2CCS863002R0081		0,735	1
	10	210236	S803S-D10-R	2CCS863002R0101		0,735	1
	13	210243	S803S-D13-R	2CCS863002R0131		0,735	1
	16	210250	S803S-D16-R	2CCS863002R0161		0,735	1
	20	210267	S803S-D20-R	2CCS863002R0201		0,735	1
	25	210274	S803S-D25-R	2CCS863002R0251		0,735	1
	32	210281	S803S-D32-R	2CCS863002R0321		0,735	1
	40	207427	S803S-D40-R	2CCS863002R0401		0,735	1
	50	207434	S803S-D50-R	2CCS863002R0501		0,735	1
	63	207441	S803S-D63-R	2CCS863002R0631		0,735	1
	80	207458	S803S-D80-R	2CCS863002R0801		0,735	1
	100	207465	S803S-D100-R	2CCS863002R0821		0,735	1
	125	207472	S803S-D125-R	2CCS863002R0841		0,735	1

2

Number of poles	Rated current	Bbn 7612271	Order details		Price 1 piece	Weight 1 piece kg	Pack unit pc.
	In A	EAN	Type code	Order code			
4	6	408374	S804S-D6-R	2CCS864002R0061		0,98	1
	8	411596	S804S-D8-R	2CCS864002R0081		0,98	1
	10	210298	S804S-D10-R	2CCS864002R0101		0,98	1
	13	210304	S804S-D13-R	2CCS864002R0131		0,98	1
	16	210311	S804S-D16-R	2CCS864002R0161		0,98	1
	20	210328	S804S-D20-R	2CCS864002R0201		0,98	1
	25	210335	S804S-D25-R	2CCS864002R0251		0,98	1
	32	210342	S804S-D32-R	2CCS864002R0321		0,98	1
	40	207489	S804S-D40-R	2CCS864002R0401		0,98	1
	50	207496	S804S-D50-R	2CCS864002R0501		0,98	1
	63	207502	S804S-D63-R	2CCS864002R0631		0,98	1
	80	207519	S804S-D80-R	2CCS864002R0801		0,98	1
	100	207526	S804S-D100-R	2CCS864002R0821		0,98	1
	125	207533	S804S-D125-R	2CCS864002R0841		0,98	1

High performance MCBs

S800S series 50000 with cage terminal, K characteristic



S800S-K characteristic

Function: protection and control of the circuits like motors, transformer and auxiliary circuits, against overloads and short-circuits when a high breaking capacity is required; very useful when selectivity is needed vs an MCCB or back-up vs other MCBs wired downstream.

Advantages: no nuisance tripping in the case of functional peak currents up to 10xIn, depending on the series; through its highly sensitive thermostatic bimetal trip, the K-type characteristic offers protection to damageable elements in the overcurrent range; it also provides the best protection to cables and lines.

Applications: commercial and industrial.

Standard: IEC/EN 60947-2

Icu=50 kA

Number of poles	Rated current	Bbn 7612271	Order details		Price 1 piece	Weight 1 piece kg	Pack unit pc.
	In A	EAN	Type code	Order code			
1	6	408220	S801S-K6	2CCS861001R0067		0.245	1
	8	411442	S801S-K8	2CCS861001R0407		0.245	1
	10	201449	S801S-K10	2CCS861001R0427		0.245	1
	13	201456	S801S-K13	2CCS861001R0447		0.245	1
	16	201463	S801S-K16	2CCS861001R0467		0.245	1
	20	201470	S801S-K20	2CCS861001R0487		0.245	1
	25	201487	S801S-K25	2CCS861001R0517		0.245	1
	32	201494	S801S-K32	2CCS861001R0537		0.245	1
	40	201500	S801S-K40	2CCS861001R0557		0.245	1
	50	201517	S801S-K50	2CCS861001R0577		0.245	1
	63	201524	S801S-K63	2CCS861001R0597		0.245	1
	80	201531	S801S-K80	2CCS861001R0627		0.245	1
	100	201548	S801S-K100	2CCS861001R0637		0.245	1
	125	201555	S801S-K125	2CCS861001R0647		0.245	1

Number of poles	Rated current	Bbn 7612271	Order details		Price 1 piece	Weight 1 piece kg	Pack unit pc.
	In A	EAN	Type code	Order code			
2	6	408237	S802S-K6	2CCS862001R0067		0.49	1
	8	411459	S802S-K8	2CCS862001R0407		0.49	1
	10	201562	S802S-K10	2CCS862001R0427		0.49	1
	13	201579	S802S-K13	2CCS862001R0447		0.49	1
	16	201586	S802S-K16	2CCS862001R0467		0.49	1
	20	201593	S802S-K20	2CCS862001R0487		0.49	1
	25	201609	S802S-K25	2CCS862001R0517		0.49	1
	32	201616	S802S-K32	2CCS862001R0537		0.49	1
	40	201623	S802S-K40	2CCS862001R0557		0.49	1
	50	201630	S802S-K50	2CCS862001R0577		0.49	1
	63	201647	S802S-K63	2CCS862001R0597		0.49	1
	80	201654	S802S-K80	2CCS862001R0627		0.49	1
	100	201661	S802S-K100	2CCS862001R0637		0.49	1
	125	201678	S802S-K125	2CCS862001R0647		0.49	1



Where to find more:

Coordination Tables for S 800S MCBs: p.10/37 for back-up and p.10/50 for selectivity. For additional information download Back-up and Selectivity of S800 MCBs technical document (code 2CCC451039L0207)



Worldwide Marks and Approvals of MCBs p.11/92

Frequently asked question - FAQ:

Where can I get certificates and declaration? You can find all of them on www.abb.com

Maybe you are also interested in:

Auxiliary Elements for S 800 MCBs p.4/53 and p.4/62



S803S

2CCSC413018F0001



S804S

2CCSC413018F0001

Number of poles	Rated current	Bbn 7612271	Order details		Price 1 piece	Weight 1 piece kg	Pack unit pc.
	In A	EAN	Type code	Order code			
3	6	408244	S803S-K6	2CCS863001R0067		0.735	1
	8	411466	S803S-K8	2CCS863001R0407		0.735	1
	10	201685	S803S-K10	2CCS863001R0427		0.735	1
	13	201692	S803S-K13	2CCS863001R0447		0.735	1
	16	201708	S803S-K16	2CCS863001R0467		0.735	1
	20	201715	S803S-K20	2CCS863001R0487		0.735	1
	25	201722	S803S-K25	2CCS863001R0517		0.735	1
	32	201739	S803S-K32	2CCS863001R0537		0.735	1
	40	201746	S803S-K40	2CCS863001R0557		0.735	1
	50	201753	S803S-K50	2CCS863001R0577		0.735	1
	63	201760	S803S-K63	2CCS863001R0597		0.735	1
	80	201777	S803S-K80	2CCS863001R0627		0.735	1
	100	201784	S803S-K100	2CCS863001R0637		0.735	1
	125	201791	S803S-K125	2CCS863001R0647		0.735	1

2

Number of poles	Rated current	Bbn 7612271	Order details		Price 1 piece	Weight 1 piece kg	Pack unit pc.
	In A	EAN	Type code	Order code			
4	6	408251	S804S-K6	2CCS864001R0067		0.98	1
	8	411473	S804S-K8	2CCS864001R0407		0.98	1
	10	201807	S804S-K10	2CCS864001R0427		0.98	1
	13	201814	S804S-K13	2CCS864001R0447		0.98	1
	16	201821	S804S-K16	2CCS864001R0467		0.98	1
	20	201838	S804S-K20	2CCS864001R0487		0.98	1
	25	201845	S804S-K25	2CCS864001R0517		0.98	1
	32	201852	S804S-K32	2CCS864001R0537		0.98	1
	40	201869	S804S-K40	2CCS864001R0557		0.98	1
	50	201876	S804S-K50	2CCS864001R0577		0.98	1
	63	201883	S804S-K63	2CCS864001R0597		0.98	1
	80	201890	S804S-K80	2CCS864001R0627		0.98	1
	100	201906	S804S-K100	2CCS864001R0637		0.98	1
	125	201913	S804S-K125	2CCS864001R0647		0.98	1

High performance MCBs

S800S series 50000 with ring terminal connection, K characteristic

2



S801S



S802S

S800S-K characteristic

Function: protection and control of the circuits like motors, transformer and auxiliary circuits, against overloads and short-circuits when a high breaking capacity is required; very useful when selectivity is needed vs an MCCB or back-up vs other MCBs wired downstream.
 Advantages: no nuisance tripping in the case of functional peak currents up to 10xIn, depending on the series; through its highly sensitive thermostatic bimetal trip, the K-type characteristic offers protection to damageable elements in the overcurrent range; it also provides the best protection to cables and lines.

Applications: commercial and industrial.

Standard: IEC/EN 60947-2

Icu=50 kA

Number of poles	Rated current	Bbn 7612271	Order details		Price 1 piece	Weight 1 piece kg	Pack unit pc.
	In A	EAN	Type code	Order code			
1	6	408381	S801S-K6-R	2CCS861002R0067		0,245	1
	8	411602	S801S-K8-R	2CCS861002R0407		0,245	1
	10	209391	S801S-K10-R	2CCS861002R0427		0,245	1
	13	209407	S801S-K13-R	2CCS861002R0447		0,245	1
	16	209414	S801S-K16-R	2CCS861002R0467		0,245	1
	20	209421	S801S-K20-R	2CCS861002R0487		0,245	1
	25	209438	S801S-K25-R	2CCS861002R0517		0,245	1
	32	209445	S801S-K32-R	2CCS861002R0537		0,245	1
	40	207540	S801S-K40-R	2CCS861002R0557		0,245	1
	50	207557	S801S-K50-R	2CCS861002R0577		0,245	1
	63	207564	S801S-K63-R	2CCS861002R0597		0,245	1
	80	207571	S801S-K80-R	2CCS861002R0627		0,245	1
	100	207588	S801S-K100-R	2CCS861002R0637		0,245	1
	125	207595	S801S-K125-R	2CCS861002R0647		0,245	1

Number of poles	Rated current	Bbn 7612271	Order details		Price 1 piece	Weight 1 piece kg	Pack unit pc.
	In A	EAN	Type code	Order code			
2	6	408398	S802S-K6-R	2CCS862002R0067		0,49	1
	8	411619	S802S-K8-R	2CCS862002R0407		0,49	1
	10	209452	S802S-K10-R	2CCS862002R0427		0,49	1
	13	209469	S802S-K13-R	2CCS862002R0447		0,49	1
	16	209476	S802S-K16-R	2CCS862002R0467		0,49	1
	20	209483	S802S-K20-R	2CCS862002R0487		0,49	1
	25	209490	S802S-K25-R	2CCS862002R0517		0,49	1
	32	209506	S802S-K32-R	2CCS862002R0537		0,49	1
	40	207601	S802S-K40-R	2CCS862002R0557		0,49	1
	50	207618	S802S-K50-R	2CCS862002R0577		0,49	1
	63	207625	S802S-K63-R	2CCS862002R0597		0,49	1
	80	207632	S802S-K80-R	2CCS862002R0627		0,49	1
	100	207649	S802S-K100-R	2CCS862002R0637		0,49	1
	125	207656	S802S-K125-R	2CCS862002R0647		0,49	1

Where to find more:

Coordination Tables for S 800S MCBs: p.10/37 for back-up and p.10/50 for selectivity.
 For additional information download Back-up and Selectivity of S800 MCBs technical document (code 2CC451039L0207)



Worldwide Marks and Approvals of MCBs p.11/92

Frequently asked question - FAQ:

Where can I get certificates and declaration?
 You can find all of them on www.abb.com

Maybe you are also interested in:

Auxiliary Elements for S 800 MCBs p.4/53 and p.4/62



S803S

2CCS41308F0003



S804S

2CCS41308F0003

Number of poles	Rated current	Bbn 7612271	Order details		Price 1 piece	Weight 1 piece kg	Pack unit pc.
	In A	EAN	Type code	Order code			
3	6	408404	S803S-K6-R	2CCS863002R0067		0,735	1
	8	411626	S803S-K8-R	2CCS863002R0407		0,735	1
	10	209513	S803S-K10-R	2CCS863002R0427		0,735	1
	13	209520	S803S-K13-R	2CCS863002R0447		0,735	1
	16	209537	S803S-K16-R	2CCS863002R0467		0,735	1
	20	209544	S803S-K20-R	2CCS863002R0487		0,735	1
	25	209551	S803S-K25-R	2CCS863002R0517		0,735	1
	32	209568	S803S-K32-R	2CCS863002R0537		0,735	1
	40	207663	S803S-K40-R	2CCS863002R0557		0,735	1
	50	207670	S803S-K50-R	2CCS863002R0577		0,735	1
	63	207687	S803S-K63-R	2CCS863002R0597		0,735	1
	80	207694	S803S-K80-R	2CCS863002R0627		0,735	1
	100	207700	S803S-K100-R	2CCS863002R0637		0,735	1
	125	207717	S803S-K125-R	2CCS863002R0647		0,735	1

2

Number of poles	Rated current	Bbn 7612271	Order details		Price 1 piece	Weight 1 piece kg	Pack unit pc.
	In A	EAN	Type code	Order code			
4	6	408411	S804S-K6-R	2CCS864002R0067		0,98	1
	8	411633	S804S-K8-R	2CCS864002R0407		0,98	1
	10	209575	S804S-K10-R	2CCS864002R0427		0,98	1
	13	209582	S804S-K13-R	2CCS864002R0447		0,98	1
	16	209599	S804S-K16-R	2CCS864002R0467		0,98	1
	20	209605	S804S-K20-R	2CCS864002R0487		0,98	1
	25	209612	S804S-K25-R	2CCS864002R0517		0,98	1
	32	209629	S804S-K32-R	2CCS864002R0537		0,98	1
	40	207724	S804S-K40-R	2CCS864002R0557		0,98	1
	50	207731	S804S-K50-R	2CCS864002R0577		0,98	1
	63	207748	S804S-K63-R	2CCS864002R0597		0,98	1
	80	207755	S804S-K80-R	2CCS864002R0627		0,98	1
	100	207762	S804S-K100-R	2CCS864002R0637		0,98	1
	125	207779	S804S-K125-R	2CCS864002R0647		0,98	1

High performance MCBs

S800S series 50000 with cage terminal, KM and KM-R characteristic

2



S803S



S804S

S800S-KM characteristic with cage terminal

Function: protection and control of the circuits against overloads and short-circuits when a high breaking capacity is required; only magnetic version dedicated to protect motors; very useful when selectivity is needed vs an MCCB or back-up vs other MCBs wired downstream; version dedicated to application in direct current circuits.

Applications: commercial and industrial.

Standard: IEC/EN 60947-2

Icu=50 kA

Number of poles	Rated current	Bbn 7612271	Order details		Price 1 piece	Weight 1 piece kg	Pack unit pc.
	In A	EAN	Type code	Order code			
3	20	202194	S803S-KM20	2CCS863001R0486		0.735	1
	25	202200	S803S-KM25	2CCS863001R0516		0.735	1
	32	202217	S803S-KM32	2CCS863001R0536		0.735	1
	40	202224	S803S-KM40	2CCS863001R0556		0.735	1
	50	202231	S803S-KM50	2CCS863001R0576		0.735	1
	63	202248	S803S-KM63	2CCS863001R0596		0.735	1
	80	202255	S803S-KM80	2CCS863001R0626		0.735	1

S800S-KM-R characteristic with ring terminal connection

Function: protection and control of the circuits against overloads and short-circuits when a high breaking capacity is required; only magnetic version dedicated to protect motors; very useful when selectivity is needed vs an MCCB or back-up vs other MCBs wired downstream; version dedicated to application in direct current circuits.

Applications: commercial and industrial.

Standard: IEC/EN 60947-2

Icu=50 kA

Number of poles	Rated current	Bbn 7612271	Order details		Price 1 piece	Weight 1 piece kg	Pack unit pc.
	In A	EAN	Type code	Order code			
3	20	210830	S803S-KM20-R	2CCS863002R0486		0,735	1
	25	210847	S803S-KM25-R	2CCS863002R0516		0,735	1
	32	210854	S803S-KM32-R	2CCS863002R0536		0,735	1
	40	207786	S803S-KM40-R	2CCS863002R0556		0,735	1
	50	207793	S803S-KM50-R	2CCS863002R0576		0,735	1
	63	207809	S803S-KM63-R	2CCS863002R0596		0,735	1
	80	207816	S803S-KM80-R	2CCS863002R0626		0,735	1

Where to find more:

Coordination Tables for S 800S MCBs: p.10/37 for back-up and p.10/50 for selectivity. For additional information download Back-up and Selectivity of S800 MCBs technical document (code 2CCC451039L0207)



Worldwide Marks and Approvals of MCBs p.11/92

Frequently asked question - FAQ:

Where can I get certificates and declaration? You can find all of them on www.abb.com

Maybe you are also interested in:

Auxiliary Elements for S 800 MCBs p.4/53 and p.4/62

High performance MCBs

S800S series 50000 DC range with cage terminal, UC-B characteristic



S801S



S802S

S800S-UCB characteristic

Function: protection and control of the circuits against overloads and short-circuits when a high breaking capacity is required; protection for people and big length cables in TN and IT systems; very useful when selectivity is needed vs an MCCB or back-up vs other MCBs wired downstream; version dedicated to application in direct current circuits.

Applications: commercial and industrial.

Standard: IEC/EN 60947-2

Icu=50 kA

2

Number of poles	Rated current	Bbn 7612271	Order details		Price 1 piece	Weight 1 piece kg	Pack unit pc.
	In A	EAN	Type code	Order code			
1	10	202842	S801S-UCB10	2CCS861001R1105		0.245	1
	13	202859	S801S-UCB13	2CCS861001R1135		0.245	1
	16	202866	S801S-UCB16	2CCS861001R1165		0.245	1
	20	202873	S801S-UCB20	2CCS861001R1205		0.245	1
	25	202880	S801S-UCB25	2CCS861001R1255		0.245	1
	32	202897	S801S-UCB32	2CCS861001R1325		0.245	1
	40	202903	S801S-UCB40	2CCS861001R1405		0.245	1
	50	202910	S801S-UCB50	2CCS861001R1505		0.245	1
	63	202927	S801S-UCB63	2CCS861001R1635		0.245	1
	80	202934	S801S-UCB80	2CCS861001R1805		0.245	1
	100	202941	S801S-UCB100	2CCS861001R1825		0.245	1
	125	202958	S801S-UCB125	2CCS861001R1845		0.245	1

Number of poles	Rated current	Bbn 7612271	Order details		Price 1 piece	Weight 1 piece kg	Pack unit pc.
	In A	EAN	Type code	Order code			
2	10	202965	S802S-UCB10	2CCS862001R1105		0.49	1
	13	202972	S802S-UCB13	2CCS862001R1135		0.49	1
	16	202989	S802S-UCB16	2CCS862001R1165		0.49	1
	20	202996	S802S-UCB20	2CCS862001R1205		0.49	1
	25	203009	S802S-UCB25	2CCS862001R1255		0.49	1
	32	203016	S802S-UCB32	2CCS862001R1325		0.49	1
	40	203023	S802S-UCB40	2CCS862001R1405		0.49	1
	50	203030	S802S-UCB50	2CCS862001R1505		0.49	1
	63	203047	S802S-UCB63	2CCS862001R1635		0.49	1
	80	203054	S802S-UCB80	2CCS862001R1805		0.49	1
	100	203061	S802S-UCB100	2CCS862001R1825		0.49	1
	125	203078	S802S-UCB125	2CCS862001R1845		0.49	1

High performance MCBs

S800S series 50000 DC range with cage terminal, UC-B characteristic



S803S



S804S

Number of poles	Rated current	Bbn 7612271	Order details		Price 1 piece	Weight 1 piece	Pack unit
	In A	EAN	Type code	Order code			
3	10	203085	S803S-UCB10	2CCS863001R1105		0.735	1
	13	203092	S803S-UCB13	2CCS863001R1135		0.735	1
	16	203108	S803S-UCB16	2CCS863001R1165		0.735	1
	20	203115	S803S-UCB20	2CCS863001R1205		0.735	1
	25	203122	S803S-UCB25	2CCS863001R1255		0.735	1
	32	203139	S803S-UCB32	2CCS863001R1325		0.735	1
	40	203146	S803S-UCB40	2CCS863001R1405		0.735	1
	50	203153	S803S-UCB50	2CCS863001R1505		0.735	1
	63	203160	S803S-UCB63	2CCS863001R1635		0.735	1
	80	203177	S803S-UCB80	2CCS863001R1805		0.735	1
	100	203184	S803S-UCB100	2CCS863001R1825		0.735	1
	125	203191	S803S-UCB125	2CCS863001R1845		0.735	1

Number of poles	Rated current	Bbn 7612271	Order details		Price 1 piece	Weight 1 piece	Pack unit
	In A	EAN	Type code	Order code			
4	10	203207	S804S-UCB10	2CCS864001R1105		0.98	1
	13	203214	S804S-UCB13	2CCS864001R1135		0.98	1
	16	203221	S804S-UCB16	2CCS864001R1165		0.98	1
	20	203238	S804S-UCB20	2CCS864001R1205		0.98	1
	25	203245	S804S-UCB25	2CCS864001R1255		0.98	1
	32	203252	S804S-UCB32	2CCS864001R1325		0.98	1
	40	203269	S804S-UCB40	2CCS864001R1405		0.98	1
	50	203276	S804S-UCB50	2CCS864001R1505		0.98	1
	63	203283	S804S-UCB63	2CCS864001R1635		0.98	1
	80	203290	S804S-UCB80	2CCS864001R1805		0.98	1
	100	203306	S804S-UCB100	2CCS864001R1825		0.98	1
	125	203313	S804S-UCB125	2CCS864001R1845		0.98	1

Where to find more:

Coordination Tables for S 800S MCBs: p.10/37 for back-up and p.10/50 for selectivity. For additional information download Back-up and Selectivity of S800 MCBs technical document (code 2CCC451039L0207)



Worldwide Marks and Approvals of MCBs p.11/92

Frequently asked question - FAQ:

Where can I get certificates and declaration? You can find all of them on www.abb.com

Maybe you are also interested in:

Auxiliary Elements for S 800 MCBs p.4/53 and p.4/62

High performance MCBs

S800S series 50000 DC range with ring terminal connection, UC-B characteristic



S801S



S802S

S800S-UCB characteristic

Function: protection and control of the circuits against overloads and short-circuits when a high breaking capacity is required; protection for people and big length cables in TN and IT systems; very useful when selectivity is needed vs an MCCB or back-up vs other MCBs wired downstream; version dedicated to application in direct current circuits.

Applications: commercial and industrial.

Standard: IEC/EN 60947-2

Icu=50 kA

2

Number of poles	Rated current	Bbn 7612271	Order details		Price 1 piece	Weight 1 piece kg	Pack unit pc.
	In A	EAN	Type code	Order code			
1	10	210359	S801S-UCB10-R	2CCS861002R1105		0,245	1
	13	210366	S801S-UCB13-R	2CCS861002R1135		0,245	1
	16	210373	S801S-UCB16-R	2CCS861002R1165		0,245	1
	20	210380	S801S-UCB20-R	2CCS861002R1205		0,245	1
	25	210397	S801S-UCB25-R	2CCS861002R1255		0,245	1
	32	210403	S801S-UCB32-R	2CCS861002R1325		0,245	1
	40	208424	S801S-UCB40-R	2CCS861002R1405		0,245	1
	50	208431	S801S-UCB50-R	2CCS861002R1505		0,245	1
	63	208448	S801S-UCB63-R	2CCS861002R1635		0,245	1
	80	208455	S801S-UCB80-R	2CCS861002R1805		0,245	1
	100	208462	S801S-UCB100-R	2CCS861002R1825		0,245	1
	125	208479	S801S-UCB125-R	2CCS861002R1845		0,245	1

Number of poles	Rated current	Bbn 7612271	Order details		Price 1 piece	Weight 1 piece kg	Pack unit pc.
	In A	EAN	Type code	Order code			
2	10	210410	S802S-UCB10-R	2CCS862002R1105		0,49	1
	13	210427	S802S-UCB13-R	2CCS862002R1135		0,49	1
	16	210434	S802S-UCB16-R	2CCS862002R1165		0,49	1
	20	210441	S802S-UCB20-R	2CCS862002R1205		0,49	1
	25	210458	S802S-UCB25-R	2CCS862002R1255		0,49	1
	32	210465	S802S-UCB32-R	2CCS862002R1325		0,49	1
	40	208486	S802S-UCB40-R	2CCS862002R1405		0,49	1
	50	208493	S802S-UCB50-R	2CCS862002R1505		0,49	1
	63	208509	S802S-UCB63-R	2CCS862002R1635		0,49	1
	80	208516	S802S-UCB80-R	2CCS862002R1805		0,49	1
	100	208523	S802S-UCB100-R	2CCS862002R1825		0,49	1
	125	208530	S802S-UCB125-R	2CCS862002R1845		0,49	1

High performance MCBs

S800S series 50000 DC range with ring terminal connection, UC, B characteristic

2



S803S

2CCC413234F0001



S804S

2CCC413234F0001

Number of poles	Rated current	Bbn 7612271	Order details		Price 1 piece	Weight 1 piece	Pack unit
	In A	EAN	Type code	Order code			
3	10	210472	S803S-UCB10-R	2CCS863002R1105		0,735	1
	13	210489	S803S-UCB13-R	2CCS863002R1135		0,735	1
	16	210496	S803S-UCB16-R	2CCS863002R1165		0,735	1
	20	210502	S803S-UCB20-R	2CCS863002R1205		0,735	1
	25	210519	S803S-UCB25-R	2CCS863002R1255		0,735	1
	32	210526	S803S-UCB32-R	2CCS863002R1325		0,735	1
	40	208547	S803S-UCB40-R	2CCS863002R1405		0,735	1
	50	208554	S803S-UCB50-R	2CCS863002R1505		0,735	1
	63	208561	S803S-UCB63-R	2CCS863002R1635		0,735	1
	80	208578	S803S-UCB80-R	2CCS863002R1805		0,735	1
	100	208585	S803S-UCB100-R	2CCS863002R1825		0,735	1
	125	208592	S803S-UCB125-R	2CCS863002R1845		0,735	1

Number of poles	Rated current	Bbn 7612271	Order details		Price 1 piece	Weight 1 piece	Pack unit
	In A	EAN	Type code	Order code			
4	10	210533	S804S-UCB10-R	2CCS864002R1105		0,98	1
	13	210540	S804S-UCB13-R	2CCS864002R1135		0,98	1
	16	210557	S804S-UCB16-R	2CCS864002R1165		0,98	1
	20	210564	S804S-UCB20-R	2CCS864002R1205		0,98	1
	25	210571	S804S-UCB25-R	2CCS864002R1255		0,98	1
	32	210588	S804S-UCB32-R	2CCS864002R1325		0,98	1
	40	208608	S804S-UCB40-R	2CCS864002R1405		0,98	1
	50	208615	S804S-UCB50-R	2CCS864002R1505		0,98	1
	63	208622	S804S-UCB63-R	2CCS864002R1635		0,98	1
	80	208639	S804S-UCB80-R	2CCS864002R1805		0,98	1
	100	208646	S804S-UCB100-R	2CCS864002R1825		0,98	1
	125	208653	S804S-UCB125-R	2CCS864002R1845		0,98	1

Where to find more:

Coordination Tables for S 800S MCBs: p.10/37 for back-up and p.10/50 for selectivity. For additional information download Back-up and Selectivity of S800 MCBs technical document (code 2CCC451039L0207)



Worldwide Marks and Approvals of MCBs p.11/92

Frequently asked question - FAQ:

Where can I get certificates and declaration? You can find all of them on www.abb.com

Maybe you are also interested in:

Auxiliary Elements for S 800 MCBs p.4/53 and p.4/62

High performance MCBs

S800S series 50000 DC range with cage terminal, UC, K characteristic



S801S



S802S

S800S-UCK characteristic

Function: protection and control of the circuits like motors, transformer and auxiliary circuits, against overloads and short-circuits when a high breaking capacity is required; very useful when selectivity is needed vs an MCCB or back-up vs other MCBs wired downstream; version dedicated to application in direct current circuits.

Advantages: no nuisance tripping in the case of functional peak currents up to 10xI_n, depending on the series; through its highly sensitive thermostatic bimetal trip, the K-type characteristic offers protection to damageable elements in the overcurrent range; it also provides the best protection to cables and lines.

Applications: commercial and industrial.

Standard: IEC/EN 60947-2

Icu=50 kA

2

Number of poles	Rated current	Bbn 7612271	Order details		Price 1 piece	Weight 1 piece	Pack unit
	In A	EAN	Type code	Order code			
1	10	203320	S801S-UCK10	2CCS861001R1427		0.245	1
	13	203337	S801S-UCK13	2CCS861001R1447		0.245	1
	16	203344	S801S-UCK16	2CCS861001R1467		0.245	1
	20	203351	S801S-UCK20	2CCS861001R1487		0.245	1
	25	203368	S801S-UCK25	2CCS861001R1517		0.245	1
	32	203375	S801S-UCK32	2CCS861001R1537		0.245	1
	40	203382	S801S-UCK40	2CCS861001R1557		0.245	1
	50	203399	S801S-UCK50	2CCS861001R1577		0.245	1
	63	203405	S801S-UCK63	2CCS861001R1597		0.245	1
	80	203412	S801S-UCK80	2CCS861001R1627		0.245	1
	100	203429	S801S-UCK100	2CCS861001R1637		0.245	1
	125	203436	S801S-UCK125	2CCS861001R1647		0.245	1

Number of poles	Rated current	Bbn 7612271	Order details		Price 1 piece	Weight 1 piece	Pack unit
	In A	EAN	Type code	Order code			
2	10	203443	S802S-UCK10	2CCS862001R1427		0.49	1
	13	203450	S802S-UCK13	2CCS862001R1447		0.49	1
	16	203467	S802S-UCK16	2CCS862001R1467		0.49	1
	20	203474	S802S-UCK20	2CCS862001R1487		0.49	1
	25	203481	S802S-UCK25	2CCS862001R1517		0.49	1
	32	203498	S802S-UCK32	2CCS862001R1537		0.49	1
	40	203504	S802S-UCK40	2CCS862001R1557		0.49	1
	50	203511	S802S-UCK50	2CCS862001R1577		0.49	1
	63	203528	S802S-UCK63	2CCS862001R1597		0.49	1
	80	203535	S802S-UCK80	2CCS862001R1627		0.49	1
	100	203542	S802S-UCK100	2CCS862001R1637		0.49	1
	125	203559	S802S-UCK125	2CCS862001R1647		0.49	1

High performance MCBs

S800S series 50000 DC range with cage terminal, UC-K characteristic

2



S803S

2CCC41322F0001



S804S

2CCC41322F0001

Number of poles	Rated current	Bbn 7612271	Order details		Price 1 piece	Weight 1 piece kg	Pack unit pc.
	In A	EAN	Type code	Order code			
3	10	203566	S803S-UCK10	2CCS863001R1427		0.735	1
	13	203573	S803S-UCK13	2CCS863001R1447		0.735	1
	16	203580	S803S-UCK16	2CCS863001R1467		0.735	1
	20	203597	S803S-UCK20	2CCS863001R1487		0.735	1
	25	203603	S803S-UCK25	2CCS863001R1517		0.735	1
	32	203610	S803S-UCK32	2CCS863001R1537		0.735	1
	40	203627	S803S-UCK40	2CCS863001R1557		0.735	1
	50	203634	S803S-UCK50	2CCS863001R1577		0.735	1
	63	203641	S803S-UCK63	2CCS863001R1597		0.735	1
	80	203658	S803S-UCK80	2CCS863001R1627		0.735	1
	100	203665	S803S-UCK100	2CCS863001R1637		0.735	1
	125	203672	S803S-UCK125	2CCS863001R1647		0.735	1

Number of poles	Rated current	Bbn 7612271	Order details		Price 1 piece	Weight 1 piece kg	Pack unit pc.
	In A	EAN	Type code	Order code			
4	10	203689	S804S-UCK10	2CCS864001R1427		0.98	1
	13	203696	S804S-UCK13	2CCS864001R1447		0.98	1
	16	203702	S804S-UCK16	2CCS864001R1467		0.98	1
	20	203719	S804S-UCK20	2CCS864001R1487		0.98	1
	25	203726	S804S-UCK25	2CCS864001R1517		0.98	1
	32	203733	S804S-UCK32	2CCS864001R1537		0.98	1
	40	203740	S804S-UCK40	2CCS864001R1557		0.98	1
	50	203757	S804S-UCK50	2CCS864001R1577		0.98	1
	63	203764	S804S-UCK63	2CCS864001R1597		0.98	1
	80	203771	S804S-UCK80	2CCS864001R1627		0.98	1
	100	203788	S804S-UCK100	2CCS864001R1637		0.98	1
	125	203795	S804S-UCK125	2CCS864001R1647		0.98	1

Where to find more:

Coordination Tables for S 800S MCBs: p.10/37 for back-up and p.10/50 for selectivity. For additional information download Back-up and Selectivity of S800 MCBs technical document (code 2CCC451039L0207)



Worldwide Marks and Approvals of MCBs p.11/92

Frequently asked question - FAQ:

Where can I get certificates and declaration? You can find all of them on www.abb.com

Maybe you are also interested in:

Auxiliary Elements for S 800 MCBs p.4/53 and p.4/62

High performance MCBs

S800S series 50000 DC range with ring terminal connection, UC-K characteristic



S801S



S802S

S800S-UCK characteristic

Function: protection and control of the circuits like motors, transformer and auxiliary circuits, against overloads and short-circuits when a high breaking capacity is required; very useful when selectivity is needed vs an MCCB or back-up vs other MCBs wired downstream; version dedicated to application in direct current circuits.

Advantages: no nuisance tripping in the case of functional peak currents up to $10 \times I_n$, depending on the series; through its highly sensitive thermostatic bimetal trip, the K-type characteristic offers protection to damageable elements in the overcurrent range; it also provides the best protection to cables and lines.

Applications: commercial and industrial.

Standard: IEC/EN 60947-2

Icu=50 kA

2

Number of poles	Rated current	Bbn 7612271	Order details		Price 1 piece	Weight 1 piece	Pack unit
	In A	EAN	Type code	Order code			
1	10	210595	S801S-UCK10-R	2CCS861002R1427		0,245	1
	13	210601	S801S-UCK13-R	2CCS861002R1447		0,245	1
	16	210618	S801S-UCK16-R	2CCS861002R1467		0,245	1
	20	210625	S801S-UCK20-R	2CCS861002R1487		0,245	1
	25	210632	S801S-UCK25-R	2CCS861002R1517		0,245	1
	32	210649	S801S-UCK32-R	2CCS861002R1537		0,245	1
	40	208660	S801S-UCK40-R	2CCS861002R1557		0,245	1
	50	208677	S801S-UCK50-R	2CCS861002R1577		0,245	1
	63	208684	S801S-UCK63-R	2CCS861002R1597		0,245	1
	80	208691	S801S-UCK80-R	2CCS861002R1627		0,245	1
	100	208707	S801S-UCK100-R	2CCS861002R1637		0,245	1
	125	208714	S801S-UCK125-R	2CCS861002R1647		0,245	1

Number of poles	Rated current	Bbn 7612271	Order details		Price 1 piece	Weight 1 piece	Pack unit
	In A	EAN	Type code	Order code			
2	10	210656	S802S-UCK10-R	2CCS862002R1427		0,490	1
	13	210663	S802S-UCK13-R	2CCS862002R1447		0,490	1
	16	210670	S802S-UCK16-R	2CCS862002R1467		0,490	1
	20	210687	S802S-UCK20-R	2CCS862002R1487		0,490	1
	25	210694	S802S-UCK25-R	2CCS862002R1517		0,490	1
	32	210700	S802S-UCK32-R	2CCS862002R1537		0,490	1
	40	208721	S802S-UCK40-R	2CCS862002R1557		0,490	1
	50	208738	S802S-UCK50-R	2CCS862002R1577		0,490	1
	63	208745	S802S-UCK63-R	2CCS862002R1597		0,490	1
	80	208752	S802S-UCK80-R	2CCS862002R1627		0,490	1
	100	208769	S802S-UCK100-R	2CCS862002R1637		0,490	1
	125	208776	S802S-UCK125-R	2CCS862002R1647		0,490	1

High performance MCBs

S800S series 50000 DC range with ring terminal connection, UC-K characteristic

2



S803S

2CCC41328F0001



S804S

2CCC41328F0001

Number of poles	Rated current	Bbn 7612271	Order details		Price 1 piece	Weight 1 piece	Pack unit
	In A	EAN	Type code	Order code			
3	10	210717	S803S-UCK10-R	2CCS863002R1427		0,735	1
	13	210724	S803S-UCK13-R	2CCS863002R1447		0,735	1
	16	210731	S803S-UCK16-R	2CCS863002R1467		0,735	1
	20	210748	S803S-UCK20-R	2CCS863002R1487		0,735	1
	25	210755	S803S-UCK25-R	2CCS863002R1517		0,735	1
	32	210762	S803S-UCK32-R	2CCS863002R1537		0,735	1
	40	208783	S803S-UCK40-R	2CCS863002R1557		0,735	1
	50	208790	S803S-UCK50-R	2CCS863002R1577		0,735	1
	63	208806	S803S-UCK63-R	2CCS863002R1597		0,735	1
	80	208813	S803S-UCK80-R	2CCS863002R1627		0,735	1
	100	208820	S803S-UCK100-R	2CCS863002R1637		0,735	1
	125	208837	S803S-UCK125-R	2CCS863002R1647		0,735	1

Number of poles	Rated current	Bbn 7612271	Order details		Price 1 piece	Weight 1 piece	Pack unit
	In A	EAN	Type code	Order code			
4	10	210779	S804S-UCK10-R	2CCS864002R1427		0,98	1
	13	210786	S804S-UCK13-R	2CCS864002R1447		0,98	1
	16	210793	S804S-UCK16-R	2CCS864002R1467		0,98	1
	20	210809	S804S-UCK20-R	2CCS864002R1487		0,98	1
	25	210816	S804S-UCK25-R	2CCS864002R1517		0,98	1
	32	210823	S804S-UCK32-R	2CCS864002R1537		0,98	1
	40	208844	S804S-UCK40-R	2CCS864002R1557		0,98	1
	50	208851	S804S-UCK50-R	2CCS864002R1577		0,98	1
	63	208868	S804S-UCK63-R	2CCS864002R1597		0,98	1
	80	208875	S804S-UCK80-R	2CCS864002R1627		0,98	1
	100	208882	S804S-UCK100-R	2CCS864002R1637		0,98	1
	125	208899	S804S-UCK125-R	2CCS864002R1647		0,98	1

Where to find more:

Coordination Tables for S 800S MCBs: p.10/37 for back-up and p.10/50 for selectivity. For additional information download Back-up and Selectivity of S800 MCBs technical document (code 2CCC451039L0207)



Worldwide Marks and Approvals of MCBs p.11/92

Frequently asked question - FAQ:

Where can I get certificates and declaration? You can find all of them on www.abb.com

Maybe you are also interested in:

Auxiliary Elements for S 800 MCBs p.4/53 and p.4/62

High performance MCBs

S800N series 36000 with cage terminal, B characteristic



S801N



S802N

S800N-B characteristic

Function: protection and control of the circuits against overloads and short-circuits when a high breaking capacity is required; protection for people and big length cables in TN and IT systems; very useful when selectivity is needed vs an MCCB or back-up vs other MCBs wired downstream.

Applications: commercial and industrial.

Standard: IEC/EN 60898, IEC/EN 60947-2

Icn=20 kA (10 ... 80 A)

Icu=36 kA

2

Number of poles	Rated current	Bbn 7612271	Order details		Price 1 piece	Weight 1 piece kg	Pack unit pc.
	In A	EAN	Type code	Order code			
1	10	203801	S801N-B10	2CCS891001R0105	0.24	1	
	13	203818	S801N-B13	2CCS891001R0135			
	16	203825	S801N-B16	2CCS891001R0165			
	20	203832	S801N-B20	2CCS891001R0205			
	25	203849	S801N-B25	2CCS891001R0255			
	32	203856	S801N-B32	2CCS891001R0325			
	40	203863	S801N-B40	2CCS891001R0405			
	50	203870	S801N-B50	2CCS891001R0505			
	63	203887	S801N-B63	2CCS891001R0635			
	80	203894	S801N-B80	2CCS891001R0805			
	100	203900	S801N-B100	2CCS891001R0825			
	125	203917	S801N-B125	2CCS891001R0845			

Number of poles	Rated current	Bbn 7612271	Order details		Price 1 piece	Weight 1 piece kg	Pack unit pc.
	In A	EAN	Type code	Order code			
2	10	203924	S802N-B10	2CCS892001R0105	0.48	1	
	13	203931	S802N-B13	2CCS892001R0135			
	16	203948	S802N-B16	2CCS892001R0165			
	20	203955	S802N-B20	2CCS892001R0205			
	25	203962	S802N-B25	2CCS892001R0255			
	32	203979	S802N-B32	2CCS892001R0325			
	40	203986	S802N-B40	2CCS892001R0405			
	50	203993	S802N-B50	2CCS892001R0505			
	63	204006	S802N-B63	2CCS892001R0635			
	80	204013	S802N-B80	2CCS892001R0805			
	100	204020	S802N-B100	2CCS892001R0825			
	125	204037	S802N-B125	2CCS892001R0845			

Where to find more:

Coordination Tables for S 800N MCBs: p.10/37 for back-up and p.10/67 for selectivity. For additional information download Back-up and Selectivity of S800 MCBs technical document (code 2CCC451039L0207)



Worldwide Marks and Approvals of MCBs p.11/92

Frequently asked question - FAQ:

Where can I get certificates and declaration? You can find all of them on www.abb.com

Maybe you are also interested in:

Auxiliary Elements for S 800 MCBs p.4/53 and p.4/62

High performance MCBs

S800N series 36000 with cage terminal, B characteristic

2



S803N



S804N

Number of poles	Rated current	Bbn 7612271	Order details		Price 1 piece	Weight 1 piece	Pack unit
	In A	EAN	Type code	Order code			
3	10	204044	S803N-B10	2CCS893001R0105		0.72	1
	13	204051	S803N-B13	2CCS893001R0135		0.72	1
	16	204068	S803N-B16	2CCS893001R0165		0.72	1
	20	204075	S803N-B20	2CCS893001R0205		0.72	1
	25	204082	S803N-B25	2CCS893001R0255		0.72	1
	32	204099	S803N-B32	2CCS893001R0325		0.72	1
	40	204105	S803N-B40	2CCS893001R0405		0.72	1
	50	204112	S803N-B50	2CCS893001R0505		0.72	1
	63	204129	S803N-B63	2CCS893001R0635		0.72	1
	80	204136	S803N-B80	2CCS893001R0805		0.72	1
	100	204143	S803N-B100	2CCS893001R0825		0.72	1
	125	204150	S803N-B125	2CCS893001R0845		0.72	1

Number of poles	Rated current	Bbn 7612271	Order details		Price 1 piece	Weight 1 piece	Pack unit
	In A	EAN	Type code	Order code			
4	10	204167	S804N-B10	2CCS894001R0105		0.96	1
	13	204174	S804N-B13	2CCS894001R0135		0.96	1
	16	204181	S804N-B16	2CCS894001R0165		0.96	1
	20	204198	S804N-B20	2CCS894001R0205		0.96	1
	25	204204	S804N-B25	2CCS894001R0255		0.96	1
	32	204211	S804N-B32	2CCS894001R0325		0.96	1
	40	204228	S804N-B40	2CCS894001R0405		0.96	1
	50	204235	S804N-B50	2CCS894001R0505		0.96	1
	63	204242	S804N-B63	2CCS894001R0635		0.96	1
	80	204259	S804N-B80	2CCS894001R0805		0.96	1
	100	204266	S804N-B100	2CCS894001R0825		0.96	1
	125	204273	S804N-B125	2CCS894001R0845		0.96	1

Where to find more:

Coordination Tables for S 800N MCBs: p.10/37 for back-up and p.10/67 for selectivity.
For additional information download Back-up and Selectivity of S800 MCBs technical document (code 2CC451039L0207)



Worldwide Marks and Approvals of MCBs p.11/92

Frequently asked question - FAQ:

Where can I get certificates and declaration?
You can find all of them on www.abb.com

Maybe you are also interested in:

Auxiliary Elements for S 800 MCBs p.4/53 and p.4/62

High performance MCBs

S800N series 36000 with cage terminal, C characteristic



S801N



S802N

S800N-C characteristic

Function: protection and control of the circuits against overloads and short-circuits when a high breaking capacity is required; protection for resistive and inductive loads with low inrush current; very useful when selectivity is needed vs an MCCB or back-up vs other MCBs wired downstream.

Applications: commercial and industrial.

Standard: IEC/EN 60898, IEC/EN 60947-2

Icn=20 kA (10 ... 80 A)

Icu=36 kA

2

Number of poles	Rated current	Bbn 7612271	Order details		Price 1 piece	Weight 1 piece kg	Pack unit pc.
	In A	EAN	Type code	Order code			
1	10	204280	S801N-C10	2CCS891001R0104	0.24	1	
	13	204297	S801N-C13	2CCS891001R0134			
	16	204303	S801N-C16	2CCS891001R0164			
	20	204310	S801N-C20	2CCS891001R0204			
	25	204327	S801N-C25	2CCS891001R0254			
	32	204334	S801N-C32	2CCS891001R0324			
	40	204341	S801N-C40	2CCS891001R0404			
	50	204358	S801N-C50	2CCS891001R0504			
	63	204365	S801N-C63	2CCS891001R0634			
	80	204372	S801N-C80	2CCS891001R0804			
	100	204389	S801N-C100	2CCS891001R0824			
	125	204396	S801N-C125	2CCS891001R0844			

Number of poles	Rated current	Bbn 7612271	Order details		Price 1 piece	Weight 1 piece kg	Pack unit pc.
	In A	EAN	Type code	Order code			
2	10	204402	S802N-C10	2CCS892001R0104	0.48	1	
	13	204419	S802N-C13	2CCS892001R0134			
	16	204426	S802N-C16	2CCS892001R0164			
	20	204433	S802N-C20	2CCS892001R0204			
	25	204440	S802N-C25	2CCS892001R0254			
	32	204457	S802N-C32	2CCS892001R0324			
	40	204464	S802N-C40	2CCS892001R0404			
	50	204471	S802N-C50	2CCS892001R0504			
	63	204488	S802N-C63	2CCS892001R0634			
	80	204495	S802N-C80	2CCS892001R0804			
	100	204501	S802N-C100	2CCS892001R0824			
	125	204518	S802N-C125	2CCS892001R0844			

High performance MCBs

S800N series 36000 with cage terminal, C characteristic

2



S803N



S804N

Number of poles	Rated current	Bbn 7612271	Order details		Price 1 piece	Weight 1 piece	Pack unit
	In A		EAN	Type code			
3	10	204525	S803N-C10	2CCS893001R0104		0.72	1
	13	204532	S803N-C13	2CCS893001R0134		0.72	1
	16	204549	S803N-C16	2CCS893001R0164		0.72	1
	20	204556	S803N-C20	2CCS893001R0204		0.72	1
	25	204563	S803N-C25	2CCS893001R0254		0.72	1
	32	204570	S803N-C32	2CCS893001R0324		0.72	1
	40	204587	S803N-C40	2CCS893001R0404		0.72	1
	50	204594	S803N-C50	2CCS893001R0504		0.72	1
	63	204600	S803N-C63	2CCS893001R0634		0.72	1
	80	204617	S803N-C80	2CCS893001R0804		0.72	1
	100	204624	S803N-C100	2CCS893001R0824		0.72	1
	125	204631	S803N-C125	2CCS893001R0844		0.72	1

Number of poles	Rated current	Bbn 7612271	Order details		Price 1 piece	Weight 1 piece	Pack unit
	In A		EAN	Type code			
4	10	204648	S804N-C10	2CCS894001R0104		0.96	1
	13	204655	S804N-C13	2CCS894001R0134		0.96	1
	16	204662	S804N-C16	2CCS894001R0164		0.96	1
	20	204679	S804N-C20	2CCS894001R0204		0.96	1
	25	204686	S804N-C25	2CCS894001R0254		0.96	1
	32	204693	S804N-C32	2CCS894001R0324		0.96	1
	40	204709	S804N-C40	2CCS894001R0404		0.96	1
	50	204716	S804N-C50	2CCS894001R0504		0.96	1
	63	204723	S804N-C63	2CCS894001R0634		0.96	1
	80	204730	S804N-C80	2CCS894001R0804		0.96	1
	100	204747	S804N-C100	2CCS894001R0824		0.96	1
	125	204754	S804N-C125	2CCS894001R0844		0.96	1

Where to find more:

Coordination Tables for S 800N MCBs: p.10/37 for back-up and p.10/67 for selectivity.
For additional information download Back-up and Selectivity of S800 MCBs technical document (code 2CC451039L0207)



Worldwide Marks and Approvals of MCBs p.11/92

Frequently asked question - FAQ:

Where can I get certificates and declaration?
You can find all of them on www.abb.com

Maybe you are also interested in:

Auxiliary Elements for S 800 MCBs p.4/53 and p.4/62

High performance MCBs

S800N series 36000 with cage terminal, D characteristic



S801N



S802N

S800N-D characteristic

Function: protection and control of the circuits against overloads and short-circuits when a high breaking capacity is required; protection for circuits which supply loads with high inrush current at the circuit closing (motors, LV / LV transformers, breakdown lamps); very useful when selectivity is needed vs an MCCB or back-up vs other MCBs wired downstream.

Applications: commercial and industrial.

Standard: IEC/EN 60898, IEC/EN 60947-2

Icn=20 kA (10 ... 80 A)

Icu=36 kA

2

Number of poles	Rated current	Bbn 7612271	Order details		Price 1 piece	Weight 1 piece kg	Pack unit pc.
	In A	EAN	Type code	Order code			
1	10	204761	S801N-D10	2CCS891001R0101		0.245	1
	13	204778	S801N-D13	2CCS891001R0131		0.245	1
	16	204785	S801N-D16	2CCS891001R0161		0.245	1
	20	204792	S801N-D20	2CCS891001R0201		0.245	1
	25	204808	S801N-D25	2CCS891001R0251		0.245	1
	32	204815	S801N-D32	2CCS891001R0321		0.245	1
	40	204822	S801N-D40	2CCS891001R0401		0.245	1
	50	204839	S801N-D50	2CCS891001R0501		0.245	1
	63	204846	S801N-D63	2CCS891001R0631		0.245	1
	80	204853	S801N-D80	2CCS891001R0801		0.245	1
	100	204860	S801N-D100	2CCS891001R0821		0.245	1
	125	204877	S801N-D125	2CCS891001R0841		0.245	1

Number of poles	Rated current	Bbn 7612271	Order details		Price 1 piece	Weight 1 piece kg	Pack unit pc.
	In A	EAN	Type code	Order code			
2	10	204884	S802N-D10	2CCS892001R0101		0.49	1
	13	204891	S802N-D13	2CCS892001R0131		0.49	1
	16	204907	S802N-D16	2CCS892001R0161		0.49	1
	20	204914	S802N-D20	2CCS892001R0201		0.49	1
	25	204921	S802N-D25	2CCS892001R0251		0.49	1
	32	204938	S802N-D32	2CCS892001R0321		0.49	1
	40	204945	S802N-D40	2CCS892001R0401		0.49	1
	50	204952	S802N-D50	2CCS892001R0501		0.49	1
	63	204969	S802N-D63	2CCS892001R0631		0.49	1
	80	204976	S802N-D80	2CCS892001R0801		0.49	1
	100	204983	S802N-D100	2CCS892001R0821		0.49	1
	125	204990	S802N-D125	2CCS892001R0841		0.49	1

High performance MCBs

S800N series 36000 with cage terminal, D characteristic

2



S803N



S804N

Number of poles	Rated current	Bbn 7612271	Order details		Price 1 piece	Weight 1 piece	Pack unit
	In A	EAN	Type code	Order code			
3	10	205003	S803N-D10	2CCS893001R0101		0.735	1
	13	205010	S803N-D13	2CCS893001R0131		0.735	1
	16	205027	S803N-D16	2CCS893001R0161		0.735	1
	20	205034	S803N-D20	2CCS893001R0201		0.735	1
	25	205041	S803N-D25	2CCS893001R0251		0.735	1
	32	205058	S803N-D32	2CCS893001R0321		0.735	1
	40	205065	S803N-D40	2CCS893001R0401		0.735	1
	50	205072	S803N-D50	2CCS893001R0501		0.735	1
	63	205089	S803N-D63	2CCS893001R0631		0.735	1
	80	205096	S803N-D80	2CCS893001R0801		0.735	1
	100	205102	S803N-D100	2CCS893001R0821		0.735	1
	125	205119	S803N-D125	2CCS893001R0841		0.735	1

Number of poles	Rated current	Bbn 7612271	Order details		Price 1 piece	Weight 1 piece	Pack unit
	In A	EAN	Type code	Order code			
4	10	205126	S804N-D10	2CCS894001R0101		0.98	1
	13	205133	S804N-D13	2CCS894001R0131		0.98	1
	16	205140	S804N-D16	2CCS894001R0161		0.98	1
	20	205157	S804N-D20	2CCS894001R0201		0.98	1
	25	205164	S804N-D25	2CCS894001R0251		0.98	1
	32	205171	S804N-D32	2CCS894001R0321		0.98	1
	40	205188	S804N-D40	2CCS894001R0401		0.98	1
	50	205195	S804N-D50	2CCS894001R0501		0.98	1
	63	205201	S804N-D63	2CCS894001R0631		0.98	1
	80	205218	S804N-D80	2CCS894001R0801		0.98	1
	100	205225	S804N-D100	2CCS894001R0821		0.98	1
	125	205232	S804N-D125	2CCS894001R0841		0.98	1

Where to find more:

Coordination Tables for S 800N MCBs: p.10/37 for back-up and p.10/67 for selectivity.
For additional information download Back-up and Selectivity of S800 MCBs technical document (code 2CC451039L0207)



Worldwide Marks and Approvals of MCBs p.11/92

Frequently asked question - FAQ:

Where can I get certificates and declaration?
You can find all of them on www.abb.com

Maybe you are also interested in:

Auxiliary Elements for S 800 MCBs p.4/53 and p.4/62

High performance MCBs

S800C series 25000 with cage terminal, B characteristic



S801C



S802C

S800C-B characteristic

Function: protection and control of the circuits against overloads and short-circuits when a high breaking capacity is required; protection for people and big length cables in TN and IT systems; very useful when selectivity is needed vs an MCCB or back-up vs other MCBs wired downstream.

Applications: commercial and industrial.

Standard: IEC/EN 60947-2, IEC/EN 60898

Icn=15 kA

Icu=25 kA

2

Number of poles	Rated current	Bbn 7612271	Order details		Price 1 piece	Weight 1 piece kg	Pack unit pc.
	In A	EAN	Type code	Order code			
1	10	212087	S801C-B10	2CCS881001R0105		0.245	1
	13	212247	S801C-B13	2CCS881001R0135		0.245	1
	16	212407	S801C-B16	2CCS881001R0165		0.245	1
	20	212568	S801C-B20	2CCS881001R0205		0.245	1
	25	212728	S801C-B25	2CCS881001R0255		0.245	1
	32	212889	S801C-B32	2CCS881001R0325		0.245	1
	40	213046	S801C-B40	2CCS881001R0405		0.245	1
	50	213206	S801C-B50	2CCS881001R0505		0.245	1
	63	213367	S801C-B63	2CCS881001R0635		0.245	1
	80	213527	S801C-B80	2CCS881001R0805		0.245	1
	100	213688	S801C-B100	2CCS881001R0825		0.245	1
	125	213848	S801C-B125	2CCS881001R0845		0.245	1

Number of poles	Rated current	Bbn 7612271	Order details		Price 1 piece	Weight 1 piece kg	Pack unit pc.
	In A	EAN	Type code	Order code			
2	10	212094	S802C-B10	2CCS882001R0105		0.49	1
	13	212254	S802C-B13	2CCS882001R0135		0.49	1
	16	212414	S802C-B16	2CCS882001R0165		0.49	1
	20	212575	S802C-B20	2CCS882001R0205		0.49	1
	25	212735	S802C-B25	2CCS882001R0255		0.49	1
	32	212896	S802C-B32	2CCS882001R0325		0.49	1
	40	213053	S802C-B40	2CCS882001R0405		0.49	1
	50	213213	S802C-B50	2CCS882001R0505		0.49	1
	63	213374	S802C-B63	2CCS882001R0635		0.49	1
	80	213534	S802C-B80	2CCS882001R0805		0.49	1
	100	213695	S802C-B100	2CCS882001R0825		0.49	1
	125	213855	S802C-B125	2CCS882001R0845		0.49	1

Where to find more:

Back-up Coordination Tables for S 800C MCBs p.10/37.

For additional information download Back-up and Selectivity of S800 MCBs technical document (code 2CCC451039L0207)



Frequently asked question - FAQ:

Where can I get certificates and declaration?

You can find all of them on www.abb.com

Maybe you are also interested in:

Auxiliary Elements for S 800 MCBs p.4/53 and p.4/62

High performance MCBs

S800C series 25000 with cage terminal, B characteristic

2



S803C



S804C

Number of poles	Rated current	Bbn 7612271	Order details		Price 1 piece	Weight 1 piece kg	Pack unit pc.
	In A	EAN	Type code	Order code			
3	10	212100	S803C-B10	2CCS883001R0105		0.735	1
	13	212261	S803C-B13	2CCS883001R0135		0.735	1
	16	212421	S803C-B16	2CCS883001R0165		0.735	1
	20	212582	S803C-B20	2CCS883001R0205		0.735	1
	25	212742	S803C-B25	2CCS883001R0255		0.735	1
	32	212902	S803C-B32	2CCS883001R0325		0.735	1
	40	213060	S803C-B40	2CCS883001R0405		0.735	1
	50	213220	S803C-B50	2CCS883001R0505		0.735	1
	63	213381	S803C-B63	2CCS883001R0635		0.735	1
	80	213541	S803C-B80	2CCS883001R0805		0.735	1
	100	213701	S803C-B100	2CCS883001R0825		0.735	1
	125	213862	S803C-B125	2CCS883001R0845		0.735	1

Number of poles	Rated current	Bbn 7612271	Order details		Price 1 piece	Weight 1 piece kg	Pack unit pc.
	In A	EAN	Type code	Order code			
4	10	212117	S804C-B10	2CCS884001R0105		0.98	1
	13	212278	S804C-B13	2CCS884001R0135		0.98	1
	16	212438	S804C-B16	2CCS884001R0165		0.98	1
	20	212599	S804C-B20	2CCS884001R0205		0.98	1
	25	212759	S804C-B25	2CCS884001R0255		0.98	1
	32	212919	S804C-B32	2CCS884001R0325		0.98	1
	40	213077	S804C-B40	2CCS884001R0405		0.98	1
	50	213237	S804C-B50	2CCS884001R0505		0.98	1
	63	213398	S804C-B63	2CCS884001R0635		0.98	1
	80	213558	S804C-B80	2CCS884001R0805		0.98	1
	100	213718	S804C-B100	2CCS884001R0825		0.98	1
	125	213879	S804C-B125	2CCS884001R0845		0.98	1

Where to find more:

Back-up Coordination Tables for S 800C MCBs p.10/37.
 For additional information download Back-up and Selectivity of S800 MCBs technical document (code 2CCC451039L0207)



Frequently asked question - FAQ:

Where can I get certificates and declaration?
 You can find all of them on www.abb.com

Maybe you are also interested in:

Auxiliary Elements for S 800 MCBs p.4/53 and p.4/62

High performance MCBs

S800C series 25000 with cage terminal, C characteristic



S801C



S802C

S800C-C characteristic

Function: protection and control of the circuits against overloads and short-circuits when a high breaking capacity is required; protection for people and big length cables in TN and IT systems; very useful when selectivity is needed vs an MCCB or back-up vs other MCBs wired downstream.

Applications: commercial and industrial.

Standard: IEC/EN 60947-2, IEC/EN 60898

Icn=15 kA

Icu=25 kA

2

Number of poles	Rated current	Bbn 7612271	Order details		Price 1 piece	Weight 1 piece kg	Pack unit pc.
	In A	EAN	Type code	Order code			
1	10	212124	S801C-C10	2CCS881001R0104	0.245	1	
	13	212285	S801C-C13	2CCS881001R0134			
	16	212445	S801C-C16	2CCS881001R0164			
	20	212605	S801C-C20	2CCS881001R0204			
	25	212766	S801C-C25	2CCS881001R0254			
	32	212926	S801C-C32	2CCS881001R0324			
	40	213084	S801C-C40	2CCS881001R0404			
	50	213244	S801C-C50	2CCS881001R0504			
	63	213404	S801C-C63	2CCS881001R0634			
	80	213565	S801C-C80	2CCS881001R0804			
	100	213725	S801C-C100	2CCS881001R0824			
	125	213886	S801C-C125	2CCS881001R0844			

Number of poles	Rated current	Bbn 7612271	Order details		Price 1 piece	Weight 1 piece kg	Pack unit pc.
	In A	EAN	Type code	Order code			
2	10	212131	S802C-C10	2CCS882001R0104	0.49	1	
	13	212292	S802C-C13	2CCS882001R0134			
	16	212452	S802C-C16	2CCS882001R0164			
	20	212612	S802C-C20	2CCS882001R0204			
	25	212773	S802C-C25	2CCS882001R0254			
	32	212933	S802C-C32	2CCS882001R0324			
	40	213091	S802C-C40	2CCS882001R0404			
	50	213251	S802C-C50	2CCS882001R0504			
	63	213411	S802C-C63	2CCS882001R0634			
	80	213572	S802C-C80	2CCS882001R0804			
	100	213732	S802C-C100	2CCS882001R0824			
	125	213893	S802C-C125	2CCS882001R0844			

High performance MCBs

S800C series 25000 with cage terminal, C characteristic

2



S803C



S804C

Number of poles	Rated current	Bbn 7612271	Order details		Price 1 piece	Weight 1 piece kg	Pack unit pc.
	In A	EAN	Type code	Order code			
3	10	212148	S803C-C10	2CCS883001R0104		0.735	1
	13	212308	S803C-C13	2CCS883001R0134		0.735	1
	16	212469	S803C-C16	2CCS883001R0164		0.735	1
	20	212629	S803C-C20	2CCS883001R0204		0.735	1
	25	212780	S803C-C25	2CCS883001R0254		0.735	1
	32	212940	S803C-C32	2CCS883001R0324		0.735	1
	40	213107	S803C-C40	2CCS883001R0404		0.735	1
	50	213268	S803C-C50	2CCS883001R0504		0.735	1
	63	213428	S803C-C63	2CCS883001R0634		0.735	1
	80	213589	S803C-C80	2CCS883001R0804		0.735	1
	100	213749	S803C-C100	2CCS883001R0824		0.735	1
	125	213909	S803C-C125	2CCS883001R0844		0.735	1

Number of poles	Rated current	Bbn 7612271	Order details		Price 1 piece	Weight 1 piece kg	Pack unit pc.
	In A	EAN	Type code	Order code			
4	10	212155	S804C-C10	2CCS884001R0104		0.98	1
	13	212315	S804C-C13	2CCS884001R0134		0.98	1
	16	212476	S804C-C16	2CCS884001R0164		0.98	1
	20	212636	S804C-C20	2CCS884001R0204		0.98	1
	25	212797	S804C-C25	2CCS884001R0254		0.98	1
	32	212957	S804C-C32	2CCS884001R0324		0.98	1
	40	213114	S804C-C40	2CCS884001R0404		0.98	1
	50	213275	S804C-C50	2CCS884001R0504		0.98	1
	63	213435	S804C-C63	2CCS884001R0634		0.98	1
	80	213596	S804C-C80	2CCS884001R0804		0.98	1
	100	213756	S804C-C100	2CCS884001R0824		0.98	1
	125	213916	S804C-C125	2CCS884001R0844		0.98	1

Where to find more:

Back-up Coordination Tables for S 800C MCBs p.10/37.
 For additional information download Back-up and Selectivity of S800 MCBs technical document (code 2CCC451039L0207)



Frequently asked question - FAQ:

Where can I get certificates and declaration?
 You can find all of them on www.abb.com

Maybe you are also interested in:

Auxiliary Elements for S 800 MCBs p.4/53 and p.4/62

High performance MCBs

S800C series 25000 with cage terminal, D characteristic



S801C



S802C

S800C-D characteristic

Function: protection and control of the circuits against overloads and short-circuits when a high breaking capacity is required; protection for people and big length cables in TN and IT systems; very useful when selectivity is needed vs an MCCB or back-up vs other MCBs wired downstream.

Applications: commercial and industrial.

Standard: IEC/EN 60947-2, IEC/EN 60898

Icn=15kA

Icu=25 kA

2

Number of poles	Rated current	Bbn 7612271	Order details		Price 1 piece	Weight 1 piece kg	Pack unit pc.
	In A	EAN	Type code	Order code			
1	10	212162	S801C-D10	2CCS881001R0101		0.245	1
	13	212322	S801C-D13	2CCS881001R0131		0.245	1
	16	212483	S801C-D16	2CCS881001R0161		0.245	1
	20	212643	S801C-D20	2CCS881001R0201		0.245	1
	25	212803	S801C-D25	2CCS881001R0251		0.245	1
	32	212964	S801C-D32	2CCS881001R0321		0.245	1
	40	213121	S801C-D40	2CCS881001R0401		0.245	1
	50	213282	S801C-D50	2CCS881001R0501		0.245	1
	63	213442	S801C-D63	2CCS881001R0631		0.245	1
	80	213602	S801C-D80	2CCS881001R0801		0.245	1
	100	213763	S801C-D100	2CCS881001R0821		0.245	1
	125	213923	S801C-D125	2CCS881001R0841		0.245	1

Number of poles	Rated current	Bbn 7612271	Order details		Price 1 piece	Weight 1 piece kg	Pack unit pc.
	In A	EAN	Type code	Order code			
2	10	212179	S802C-D10	2CCS882001R0101		0.49	1
	13	212339	S802C-D13	2CCS882001R0131		0.49	1
	16	212490	S802C-D16	2CCS882001R0161		0.49	1
	20	212650	S802C-D20	2CCS882001R0201		0.49	1
	25	212810	S802C-D25	2CCS882001R0251		0.49	1
	32	212971	S802C-D32	2CCS882001R0321		0.49	1
	40	213138	S802C-D40	2CCS882001R0401		0.49	1
	50	213299	S802C-D50	2CCS882001R0501		0.49	1
	63	213459	S802C-D63	2CCS882001R0631		0.49	1
	80	213619	S802C-D80	2CCS882001R0801		0.49	1
	100	213770	S802C-D100	2CCS882001R0821		0.49	1
	125	213930	S802C-D125	2CCS882001R0841		0.49	1

High performance MCBs

S800C series 25000 with cage terminal, D characteristic

2



S803C



S804C

Number of poles	Rated current	Bbn 7612271	Order details		Price 1 piece	Weight 1 piece	Pack unit
	In A	EAN	Type code	Order code			
3	10	212186	S803C-D10	2CCS883001R0101		0.735	1
	13	212346	S803C-D13	2CCS883001R0131		0.735	1
	16	212506	S803C-D16	2CCS883001R0161		0.735	1
	20	212667	S803C-D20	2CCS883001R0201		0.735	1
	25	212827	S803C-D25	2CCS883001R0251		0.735	1
	32	212988	S803C-D32	2CCS883001R0321		0.735	1
	40	213145	S803C-D40	2CCS883001R0401		0.735	1
	50	213305	S803C-D50	2CCS883001R0501		0.735	1
	63	213466	S803C-D63	2CCS883001R0631		0.735	1
	80	213626	S803C-D80	2CCS883001R0801		0.735	1
	100	213787	S803C-D100	2CCS883001R0821		0.735	1
	125	213947	S803C-D125	2CCS883001R0841		0.735	1

Number of poles	Rated current	Bbn 7612271	Order details		Price 1 piece	Weight 1 piece	Pack unit
	In A	EAN	Type code	Order code			
4	10	212193	S804C-D10	2CCS884001R0101		0.98	1
	13	212353	S804C-D13	2CCS884001R0131		0.98	1
	16	212513	S804C-D16	2CCS884001R0161		0.98	1
	20	212674	S804C-D20	2CCS884001R0201		0.98	1
	25	212834	S804C-D25	2CCS884001R0251		0.98	1
	32	212995	S804C-D32	2CCS884001R0321		0.98	1
	40	213152	S804C-D40	2CCS884001R0401		0.98	1
	50	213312	S804C-D50	2CCS884001R0501		0.98	1
	63	213473	S804C-D63	2CCS884001R0631		0.98	1
	80	213633	S804C-D80	2CCS884001R0801		0.98	1
	100	213794	S804C-D100	2CCS884001R0821		0.98	1
	125	213954	S804C-D125	2CCS884001R0841		0.98	1

Where to find more:

Back-up Coordination Tables for S 800C MCBs p.10/37.
 For additional information download Back-up and Selectivity of S800 MCBs technical document (code 2CCC451039L0207)



Frequently asked question - FAQ:

Where can I get certificates and declaration?
 You can find all of them on www.abb.com

Maybe you are also interested in:

Auxiliary Elements for S 800 MCBs p.4/53 and p.4/62

High performance MCBs

S800C series 25000 with cage terminal, K characteristic



S801C



S802C

S800C-K characteristic

Function: protection and control of the circuits against overloads and short-circuits when a high breaking capacity is required; protection for people and big length cables in TN and IT systems; very useful when selectivity is needed vs an MCCB or back-up vs other MCBs wired downstream.

Applications: commercial and industrial.

Standard: IEC/EN 60947-2

Icu=25 kA

2

Number of poles	Rated current	Bbn 7612271	Order details		Price 1 piece	Weight 1 piece kg	Pack unit pc.
	In A	EAN	Type code	Order code			
1	10	212209	S801C-K10	2CCS881001R0427		0.245	1
	13	212360	S801C-K13	2CCS881001R0447		0.245	1
	16	212520	S801C-K16	2CCS881001R0467		0.245	1
	20	212681	S801C-K20	2CCS881001R0487		0.245	1
	25	212841	S801C-K25	2CCS881001R0517		0.245	1
	32	213008	S801C-K32	2CCS881001R0537		0.245	1
	40	213169	S801C-K40	2CCS881001R0557		0.245	1
	50	213329	S801C-K50	2CCS881001R0577		0.245	1
	63	213480	S801C-K63	2CCS881001R0597		0.245	1
	80	213640	S801C-K80	2CCS881001R0627		0.245	1
	100	213800	S801C-K100	2CCS881001R0637		0.245	1
	125	213961	S801C-K125	2CCS881001R0647		0.245	1

Number of poles	Rated current	Bbn 7612271	Order details		Price 1 piece	Weight 1 piece kg	Pack unit pc.
	In A	EAN	Type code	Order code			
2	10	212216	S802C-K10	2CCS882001R0427		0.49	1
	13	212377	S802C-K13	2CCS882001R0447		0.49	1
	16	212537	S802C-K16	2CCS882001R0467		0.49	1
	20	212698	S802C-K20	2CCS882001R0487		0.49	1
	25	212858	S802C-K25	2CCS882001R0517		0.49	1
	32	213015	S802C-K32	2CCS882001R0537		0.49	1
	40	213176	S802C-K40	2CCS882001R0557		0.49	1
	50	213336	S802C-K50	2CCS882001R0577		0.49	1
	63	213497	S802C-K63	2CCS882001R0597		0.49	1
	80	213657	S802C-K80	2CCS882001R0627		0.49	1
	100	213817	S802C-K100	2CCS882001R0637		0.49	1
	125	213978	S802C-K125	2CCS882001R0647		0.49	1

High performance MCBs

S800C series 25000 with cage terminal, K characteristic

2



S803C



S804C

Number of poles	Rated current	Bbn 7612271	Order details		Price 1 piece	Weight 1 piece	Pack unit
	In A	EAN	Type code	Order code			
3	10	212223	S803C-K10	2CCS883001R0427		0.735	1
	13	212384	S803C-K13	2CCS883001R0447		0.735	1
	16	212544	S803C-K16	2CCS883001R0467		0.735	1
	20	212704	S803C-K20	2CCS883001R0487		0.735	1
	25	212865	S803C-K25	2CCS883001R0517		0.735	1
	32	213022	S803C-K32	2CCS883001R0537		0.735	1
	40	213183	S803C-K40	2CCS883001R0557		0.735	1
	50	213343	S803C-K50	2CCS883001R0577		0.735	1
	63	213503	S803C-K63	2CCS883001R0597		0.735	1
	80	213664	S803C-K80	2CCS883001R0627		0.735	1
	100	213824	S803C-K100	2CCS883001R0637		0.735	1
	125	213985	S803C-K125	2CCS883001R0647		0.735	1

Number of poles	Rated current	Bbn 7612271	Order details		Price 1 piece	Weight 1 piece	Pack unit
	In A	EAN	Type code	Order code			
4	10	212230	S804C-K10	2CCS884001R0427		0.98	1
	13	212391	S804C-K13	2CCS884001R0447		0.98	1
	16	212551	S804C-K16	2CCS884001R0467		0.98	1
	20	212711	S804C-K20	2CCS884001R0487		0.98	1
	25	212872	S804C-K25	2CCS884001R0517		0.98	1
	32	213039	S804C-K32	2CCS884001R0537		0.98	1
	40	213190	S804C-K40	2CCS884001R0557		0.98	1
	50	213350	S804C-K50	2CCS884001R0577		0.98	1
	63	213510	S804C-K63	2CCS884001R0597		0.98	1
	80	213671	S804C-K80	2CCS884001R0627		0.98	1
	100	213831	S804C-K100	2CCS884001R0637		0.98	1
	125	213992	S804C-K125	2CCS884001R0647		0.98	1

Where to find more:

Back-up Coordination Tables for S 800C MCBs p.10/37.
 For additional information download Back-up and Selectivity of S800 MCBs technical document (code 2CCC451039L0207)



Frequently asked question - FAQ:

Where can I get certificates and declaration?
 You can find all of them on www.abb.com

Maybe you are also interested in:

Auxiliary Elements for S 800 MCBs p.4/53 and p.4/62

High performance MCBs

S800B series 16000 with cage terminal, B characteristic



S801B



S802B



S803B



S804B

S800B-B characteristic

Function: protection and control of the circuits against overloads and short-circuits. With its lower breaking capacity it is designed to meet the needs of the sub-distributions.

Applications: commercial and industrial.

Standard: IEC/EN 60947-2

Icu=16 kA

2

Number of poles	Rated current	Bbn 7612271	Order details		Price 1 piece	Weight 1 piece	Pack unit
	In A	EAN	Type code	Order code	kg	pc.	
1	32	15303	S801B-B32	2CCS811001R0325		0.24	1
	40	16539	S801B-B40	2CCS811001R0405		0.24	1
	50	16577	S801B-B50	2CCS811001R0505		0.24	1
	63	16614	S801B-B63	2CCS811001R0635		0.24	1
	80	16652	S801B-B80	2CCS811001R0805		0.24	1
	100	16690	S801B-B100	2CCS811001R0825		0.24	1
	125	16737	S801B-B125	2CCS811001R0845		0.24	1

Number of poles	Rated current	Bbn 7612271	Order details		Price 1 piece	Weight 1 piece	Pack unit
	In A	EAN	Type code	Order code	kg	pc.	
2	32	16508	S802B-B32	2CCS812001R0325		0.49	1
	40	16546	S802B-B40	2CCS812001R0405		0.49	1
	50	16584	S802B-B50	2CCS812001R0505		0.49	1
	63	16621	S802B-B63	2CCS812001R0635		0.49	1
	80	16669	S802B-B80	2CCS812001R0805		0.49	1
	100	16706	S802B-B100	2CCS812001R0825		0.49	1
	125	16744	S802B-B125	2CCS812001R0845		0.49	1

Number of poles	Rated current	Bbn 7612271	Order details		Price 1 piece	Weight 1 piece	Pack unit
	In A	EAN	Type code	Order code	kg	pc.	
3	32	16515	S803B-B32	2CCS813001R0325		0.74	1
	40	16553	S803B-B40	2CCS813001R0405		0.74	1
	50	16591	S803B-B50	2CCS813001R0505		0.74	1
	63	16638	S803B-B63	2CCS813001R0635		0.74	1
	80	16676	S803B-B80	2CCS813001R0805		0.74	1
	100	16713	S803B-B100	2CCS813001R0825		0.74	1
	125	16751	S803B-B125	2CCS813001R0845		0.74	1

Number of poles	Rated current	Bbn 7612271	Order details		Price 1 piece	Weight 1 piece	Pack unit
	In A	EAN	Type code	Order code	kg	pc.	
4	32	16522	S804B-B32	2CCS814001R0325		0.98	1
	40	16560	S804B-B40	2CCS814001R0405		0.98	1
	50	16607	S804B-B50	2CCS814001R0505		0.98	1
	63	16645	S804B-B63	2CCS814001R0635		0.98	1
	80	16683	S804B-B80	2CCS814001R0805		0.98	1
	100	16720	S804B-B100	2CCS814001R0825		0.98	1
	125	16768	S804B-B125	2CCS814001R0845		0.98	1

Where to find more:
Worldwide Marks and Approvals of MCBs p.11/92

Frequently asked question - FAQ:
Where can I get certificates and declaration?
You can find all of them on www.abb.com

Maybe you are also interested in:
Auxiliary Elements for S 800 MCBs p.4/53 and p.4/62

High performance MCBs

S800B series 16000 with cage terminal, C characteristic



S801B



S802B



S803B



S804B

Where to find more:
Worldwide Marks and Approvals of MCBs p.11/92

Frequently asked question - FAQ:
Where can I get certificates and declaration?
You can find all of them on www.abb.com

Maybe you are also interested in:
Auxiliary Elements for S 800 MCBs p.4/53 and p.4/62

S800B-C characteristic

Function: protection and control of the circuits against overloads and short-circuits. With its lower breaking capacity it is designed to meet the needs of the sub-distributions.

Applications: commercial and industrial.

Standard: IEC/EN 60947-2

Icu=16 kA

Number of poles	Rated current	Bbn 7612271	Order details		Price 1 piece	Weight 1 piece	Pack unit
	In A	EAN	Type code	Order code			
1	32	16225	S801B-C32	2CCS811001R0324		0.24	1
	40	16263	S801B-C40	2CCS811001R0404		0.24	1
	50	16300	S801B-C50	2CCS811001R0504		0.24	1
	63	16348	S801B-C63	2CCS811001R0634		0.24	1
	80	16386	S801B-C80	2CCS811001R0804		0.24	1
	100	16423	S801B-C100	2CCS811001R0824		0.24	1
	125	16461	S801B-C125	2CCS811001R0844		0.24	1

Number of poles	Rated current	Bbn 7612271	Order details		Price 1 piece	Weight 1 piece	Pack unit
	In A	EAN	Type code	Order code			
2	32	16232	S802B-C32	2CCS812001R0324		0.49	1
	40	16270	S802B-C40	2CCS812001R0404		0.49	1
	50	16317	S802B-C50	2CCS812001R0504		0.49	1
	63	16355	S802B-C63	2CCS812001R0634		0.49	1
	80	16393	S802B-C80	2CCS812001R0804		0.49	1
	100	16430	S802B-C100	2CCS812001R0824		0.49	1
	125	16478	S802B-C125	2CCS812001R0844		0.49	1

Number of poles	Rated current	Bbn 7612271	Order details		Price 1 piece	Weight 1 piece	Pack unit
	In A	EAN	Type code	Order code			
3	32	16249	S803B-C32	2CCS813001R0324		0.74	1
	40	16287	S803B-C40	2CCS813001R0404		0.74	1
	50	16324	S803B-C50	2CCS813001R0504		0.74	1
	63	16362	S803B-C63	2CCS813001R0634		0.74	1
	80	16409	S803B-C80	2CCS813001R0804		0.74	1
	100	16447	S803B-C100	2CCS813001R0824		0.74	1
	125	16485	S803B-C125	2CCS813001R0844		0.74	1

Number of poles	Rated current	Bbn 7612271	Order details		Price 1 piece	Weight 1 piece	Pack unit
	In A	EAN	Type code	Order code			
4	32	16256	S804B-C32	2CCS814001R0324		0.98	1
	40	16294	S804B-C40	2CCS814001R0404		0.98	1
	50	16331	S804B-C50	2CCS814001R0504		0.98	1
	63	16379	S804B-C63	2CCS814001R0634		0.98	1
	80	16416	S804B-C80	2CCS814001R0804		0.98	1
	100	16454	S804B-C100	2CCS814001R0824		0.98	1
	125	16492	S804B-C125	2CCS814001R0844		0.98	1

High performance MCBs

S800B series 16000 with cage terminal, D characteristic



S801B



S802B



S803B



S804B

S800B-D characteristic

Function: protection and control of the circuits against overloads and short-circuits. With its lower breaking capacity it is designed to meet the needs of the sub-distributions.

Applications: commercial and industrial.

Standard: IEC/EN 60947-2

Icu=16 kA

2

Number of poles	Rated current	Bbn 7612271	Order details		Price 1 piece	Weight 1 piece	Pack unit
	In A	EAN	Type code	Order code		kg	pc.
1	32	15945	S801B-D32	2CCS811001R0321		0.24	1
	40	15983	S801B-D40	2CCS811001R0401		0.24	1
	50	16027	S801B-D50	2CCS811001R0501		0.24	1
	63	16065	S801B-D63	2CCS811001R0631		0.24	1
	80	16102	S801B-D80	2CCS811001R0801		0.24	1
	100	16140	S801B-D100	2CCS811001R0821		0.24	1

Number of poles	Rated current	Bbn 7612271	Order details		Price 1 piece	Weight 1 piece	Pack unit
	In A	EAN	Type code	Order code		kg	pc.
2	32	15952	S802B-D32	2CCS812001R0321		0.49	1
	40	15990	S802B-D40	2CCS812001R0401		0.49	1
	50	16034	S802B-D50	2CCS812001R0501		0.49	1
	63	16072	S802B-D63	2CCS812001R0631		0.49	1
	80	16119	S802B-D80	2CCS812001R0801		0.49	1
	100	16157	S802B-D100	2CCS812001R0821		0.49	1

Number of poles	Rated current	Bbn 7612271	Order details		Price 1 piece	Weight 1 piece	Pack unit
	In A	EAN	Type code	Order code		kg	pc.
3	32	15969	S803B-D32	2CCS813001R0321		0.74	1
	40	16003	S803B-D40	2CCS813001R0401		0.74	1
	50	16041	S803B-D50	2CCS813001R0501		0.74	1
	63	16089	S803B-D63	2CCS813001R0631		0.74	1
	80	16126	S803B-D80	2CCS813001R0801		0.74	1
	100	16164	S803B-D100	2CCS813001R0821		0.74	1

Number of poles	Rated current	Bbn 7612271	Order details		Price 1 piece	Weight 1 piece	Pack unit
	In A	EAN	Type code	Order code		kg	pc.
4	32	15976	S804B-D32	2CCS814001R0321		0.98	1
	40	16010	S804B-D40	2CCS814001R0401		0.98	1
	50	16058	S804B-D50	2CCS814001R0501		0.98	1
	63	16096	S804B-D63	2CCS814001R0631		0.98	1
	80	16133	S804B-D80	2CCS814001R0801		0.98	1
	100	16171	S804B-D100	2CCS814001R0821		0.98	1

High performance MCBs

S800B series 16000 with cage terminal, K characteristic



S800B-K characteristic

Function: protection and control of the circuits against overloads and short-circuits. With its lower breaking capacity it is designed to meet the needs of the sub-distributions.

Applications: commercial and industrial.

Standard: IEC/EN 60947-2

Icu=16 kA

Number of poles	Rated current	Bbn 7612271	Order details		Price 1 piece	Weight 1 piece	Pack unit
	In A	EAN	Type code	Order code			
1	32	15600	S801B-K32	2CCS811001R0537		0.24	1
	40	15723	S801B-K40	2CCS811001R0557		0.24	1
	50	15730	S801B-K50	2CCS811001R0577		0.24	1
	63	15778	S801B-K63	2CCS811001R0597		0.24	1
	80	15815	S801B-K80	2CCS811001R0627		0.24	1
	100	15860	S801B-K100	2CCS811001R0637		0.24	1

Number of poles	Rated current	Bbn 7612271	Order details		Price 1 piece	Weight 1 piece	Pack unit
	In A	EAN	Type code	Order code			
2	32	15709	S802B-K32	2CCS812001R0537		0.49	1
	40	16775	S802B-K40	2CCS812001R0557		0.49	1
	50	15747	S802B-K50	2CCS812001R0577		0.49	1
	63	15785	S802B-K63	2CCS812001R0597		0.49	1
	80	15822	S802B-K80	2CCS812001R0627		0.49	1
	100	15877	S802B-K100	2CCS812001R0637		0.49	1

Number of poles	Rated current	Bbn 7612271	Order details		Price 1 piece	Weight 1 piece	Pack unit
	In A	EAN	Type code	Order code			
3	32	15716	S803B-K32	2CCS813001R0537		0.74	1
	40	16799	S803B-K40	2CCS813001R0557		0.74	1
	50	15754	S803B-K50	2CCS813001R0577		0.74	1
	63	15792	S803B-K63	2CCS813001R0597		0.74	1
	80	15846	S803B-K80	2CCS813001R0627		0.74	1
	100	15884	S803B-K100	2CCS813001R0637		0.74	1

Number of poles	Rated current	Bbn 7612271	Order details		Price 1 piece	Weight 1 piece	Pack unit
	In A	EAN	Type code	Order code			
4	32	16805	S804B-K32	2CCS814001R0537		0.98	1
	40	16812	S804B-K40	2CCS814001R0557		0.98	1
	50	15761	S804B-K50	2CCS814001R0577		0.98	1
	63	15808	S804B-K63	2CCS814001R0597		0.98	1
	80	15853	S804B-K80	2CCS814001R0627		0.98	1
	100	15891	S804B-K100	2CCS814001R0637		0.98	1



Where to find more:
Worldwide Marks and Approvals of MCBs p.11/92

Frequently asked question - FAQ:
Where can I get certificates and declaration?
You can find all of them on www.abb.com

Maybe you are also interested in:
Auxiliary Elements for S 800 MCBs p.4/53 and p.4/62

S200 MCB.

In the 1923 the first of its kind,
today the best.

Back then and still today we are a trendsetting pioneer and technical leader for easy, safe and reliable use of electricity. Our circuit breakers S 200 and S 200 M are a living proof. So, with the new colored real contact position indication you can see the status within a twinkle of an eye. The optimized plane terminal plates guarantee right connection and can be reached even when the MCB is already installed. These and a lot more benefits make the miniature circuit breakers an effective addition to the successful System pro M compact®. Here you can find a wide range of compatible components for all your installation needs. www.abb.com/lowvoltage



2



High performance MCBs

S800U series technical features



S800U

General Data	Standards		
	Poles		
	Tripping characteristics		
	Rated current I _e	A	
	Rated frequency f	Hz	
	Rated insulation voltage U _i acc. to IEC/EN 60664-1	V	
	Rated impulse withstand voltage U _{imp} (1.2/50μs)	kV	
	Overvoltage category		
	Pollution degree		
	Suitability for isolation		
Data acc. to IEC/EN 60947-2	Rated operational voltage U _e	V	
	Min. operating voltage	V	
	Rated ultimate short-circuit capacity I _{cu}	kA	
	Rated service short-circuit capacity I _{cs}	kA	
	Reference temperature for tripping characteristics	°C	
	Electrical and Mechanical Endurance	ops.	
Data acc. to UL / CSA	Rated voltage	V	
	Rated interrupting capacity acc. to UL 1077	kA	
	Short-circuit current rating acc. to UL 489	kA	
	Short-circuit current rating acc. to UL 489B	kA	
	Application		
	Reference temperature for tripping characteristics	°C	
Mechanical Data	Electrical and Mechanical endurance	ops.	
	Housing		
	Toggle		
	Classification acc. To NF F 126-101, NF F 16-102		
	Protection degree acc. to EN 60529		
	Mechanical endurance	ops.	
	Shock resistance acc. to IEC/EN 60068-2-30		
	Vibration resistance acc. to IEC/EN 60068-2-6		
	Environmental conditions (damp heat) acc. to IEC/EN 60068-2-30	°C/RH	
	Environmental conditions (dry heat) acc. to IEC/EN 60068-2-2 Test B	°C/RH	
Ambient temperature	°C		
Storage temperature	°C		

S800U	S804U-UCZ	S804U-PVS
UL489	UL489	UL489B (Photovoltaic)
1 ... 4	4	4
K, Z	UCZ	PVS
10 - 100	10 - 80	5
50 / 60 Hz	-	-
690 V AC	DC 1500	DC 1500
8	8	8
IV	IV	IV
3	3	3
yes	yes	yes
AC 240/415	-	-
AC 12	-	-
1-pole: AC 240V 30kA	-	-
multipole: AC 415V 50kA	-	-
1-pole: AC 240V 25kA	-	-
multipole: AC 415V 40kA	-	-
K, Z: 25°C	-	-
10 ... 32A: 10'000 electrical / mechanical 40 ... 100A: 6'000 electrical / 4'000 mechanical 125A: 4'000 electrical / 6'000 mechanical	-	-
AC 240	DC 600	DC 1000
1-pole 30kA multipole: 50kA	10kA	1.5kA
Building installation	Datacenter, Critical power	GFDI in PV-applicatoin
25°C	25°C	50°C
acc. to UL489 6000 electric; 4000 mechanic	acc. to UL489 6000 electric; 4000 mechanic	acc. to UL489B 1000 with current; 1000 without current
Material group I, RAL 7035	Material group I, RAL 7035	Material group I, RAL 7035
black, lockable	black, lockable	black, lockable
IP20; IP40 (actuating end only)		
-25... + 60	-25... + 60	-25... + 60
-40... +70	-40... +70	-40... +70

High performance MCBs

S800U series technical features

2



Installation	Terminal			
	Stranded Cross-section of conductors (top / bottom)	mm ²	AWG	
	Flexible Cross-section of conductors (top/bottom)	mm ²	AWG	
	Tightening torque	Nm	in-lbs.	
	Screwdriver			
	Mounting			
	Mounting position			
	Supply			
	Dimensions and weight	Pole dimensions (H x L x W)	mm	
		Pole weight	g	
Combination with aux. elements	Auxiliary contact			
	Combined auxiliary- / signal contact			
	Undervoltage release			
	Shunt open release			
	Motor Operating Device			

S800U	S804U-UCZ	S804U-PVS
Failsafe cage or ringlug terminal	Failsafe cage terminal	Failsafe cage terminal
Cu only 10 - 30A:14-2 AWG 40 - 100A: 1-8 AWG	Cu only 10 - 32A:14-2 AWG 40 - 80A: 1/0 - 8 AWG	14 AWG – 2 AWG Single conductor per terminal – copper only, 75C wire
10 - 30A:14-2 AWG 40 - 100A: 1-8 AWG	Cu only 10 - 32A:14-2 AWG 40 - 80A: 1/0 - 8 AWG	14 AWG – 2 AWG Single conductor per terminal – copper only, 75C wire
3,5	3,5	3,5
31	31	31
POZI 2	POZI 2	POZI 2
any	any	any
any	any	any
any	any	any
95 x 26.5 x 82.5	142 x 26.5 x 82.5	142 x 26.5 x 82.5
240	240	240
yes	yes	yes
yes	yes	yes
yes	yes	yes
yes	yes	yes
yes	yes	yes

2

High performance MCBs

S800U series 25000 with cage terminal, Z characteristic

2



S801U



S802U

S800U-Z characteristic

Function: protection and control of the circuits against overloads and short-circuits when a high breaking capacity is required; protection for people and big length cables in TN and IT systems; very useful when selectivity is needed vs an MCCB or back-up vs other MCBs wired downstream.

Applications: commercial and industrial.

Standard: UL489, CSA 22.2 NO.5-02, IEC/EN 60947-2

Icu=30 kA (1 pole), 50 kA (2...4 poles)

Number of poles	Rated current	Bbn 7612271	Order details		Price 1 piece	Weight 1 piece kg	Pack unit pc.
	In A	EAN	Type code	Order code			
1	10	214487	S801U-Z10	2CCS881017R0105		0.245	1
	15	214524	S801U-Z15	2CCS881017R0155		0.245	1
	20	214562	S801U-Z20	2CCS881017R0205		0.245	1
	25	214609	S801U-Z25	2CCS881017R0255		0.245	1
	30	214647	S801U-Z30	2CCS881017R0305		0.245	1
	40	214685	S801U-Z40	2CCS881017R0405		0.245	1
	50	214722	S801U-Z50	2CCS881017R0505		0.245	1
	60	214760	S801U-Z60	2CCS881017R0605		0.245	1
	70	214807	S801U-Z70	2CCS881017R0705		0.245	1
	80	214845	S801U-Z80	2CCS881017R0805		0.245	1
	90	214883	S801U-Z90	2CCS881017R0905		0.245	1
100	214920	S801U-Z100	2CCS881017R0825		0.245	1	

Number of poles	Rated current	Bbn 7612271	Order details		Price 1 piece	Weight 1 piece kg	Pack unit pc.
	In A	EAN	Type code	Order code			
2	10	214494	S802U-Z10	2CCS862017R0105		0.49	1
	15	214531	S802U-Z15	2CCS862017R0155		0.49	1
	20	214579	S802U-Z20	2CCS862017R0205		0.49	1
	25	214616	S802U-Z25	2CCS862017R0255		0.49	1
	30	214654	S802U-Z30	2CCS862017R0305		0.49	1
	40	214692	S802U-Z40	2CCS862017R0405		0.49	1
	50	214739	S802U-Z50	2CCS862017R0505		0.49	1
	60	214777	S802U-Z60	2CCS862017R0605		0.49	1
	70	214814	S802U-Z70	2CCS862017R0705		0.49	1
	80	214852	S802U-Z80	2CCS862017R0805		0.49	1
	90	214890	S802U-Z90	2CCS862017R0905		0.49	1
	100	214937	S802U-Z100	2CCS862017R0825		0.49	1

Where to find more:
Worldwide Marks and Approvals of MCBs p.11/92

Frequently asked question - FAQ:
Where can I get certificates and declaration?
You can find all of them on www.abb.com



S803U

2CCS413003F0021



S804U

2CCS413004F0021

Number of poles	Rated current	Bbn 7612271	Order details		Price 1 piece	Weight 1 piece kg	Pack unit pc.
	In A	EAN	Type code	Order code			
3	10	214500	S803U-Z10	2CCS863017R0105		0.735	1
	15	214548	S803U-Z15	2CCS863017R0155		0.735	1
	20	214586	S803U-Z20	2CCS863017R0205		0.735	1
	25	214623	S803U-Z25	2CCS863017R0255		0.735	1
	30	214661	S803U-Z30	2CCS863017R0305		0.735	1
	40	214708	S803U-Z40	2CCS863017R0405		0.735	1
	50	214746	S803U-Z50	2CCS863017R0505		0.735	1
	60	214784	S803U-Z60	2CCS863017R0605		0.735	1
	70	214821	S803U-Z70	2CCS863017R0705		0.735	1
	80	214869	S803U-Z80	2CCS863017R0805		0.735	1
	90	214906	S803U-Z90	2CCS863017R0905		0.735	1
	100	214944	S803U-Z100	2CCS863017R0825		0.735	1

2

Number of poles	Rated current	Bbn 7612271	Order details		Price 1 piece	Weight 1 piece kg	Pack unit pc.
	In A	EAN	Type code	Order code			
4	10	214517	S804U-Z10	2CCS864017R0105		0.98	1
	15	214555	S804U-Z15	2CCS864017R0155		0.98	1
	20	214593	S804U-Z20	2CCS864017R0205		0.98	1
	25	214630	S804U-Z25	2CCS864017R0255		0.98	1
	30	214678	S804U-Z30	2CCS864017R0305		0.98	1
	40	214715	S804U-Z40	2CCS864017R0405		0.98	1
	50	214753	S804U-Z50	2CCS864017R0505		0.98	1
	60	214791	S804U-Z60	2CCS864017R0605		0.98	1
	70	214838	S804U-Z70	2CCS864017R0705		0.98	1
	80	214876	S804U-Z80	2CCS864017R0805		0.98	1
	90	214913	S804U-Z90	2CCS864017R0905		0.98	1
	100	214951	S804U-Z100	2CCS864017R0825		0.98	1

High performance MCBs

S800U series 10000 UCZ characteristic



S804U

2CSC41337R0001

S800 UCZ characteristic

Function: this breaker is specially designed for networks up to 600 V d.c., e.g. datacenter. With its short-circuit current rating of 10 kA you will get a good solution regarding safety and reliability. This breaker is tested acc to UL489 (cIUSus).

Number of poles	Rated current	Bbn 7612271	Order details		Price 1 piece	Weight 1 piece kg	Pack unit pc.
	In A	EAN	Type code	Order code			
4	10	420703	S804U-UCZ10	2CSC248356		0.98	1
	15	420710	S804U-UCZ15	2CSC248357		0.98	1
	20	420727	S804U-UCZ20	2CSC248358		0.98	1
	25	420734	S804U-UCZ25	2CSC248359		0.98	1
	30	420741	S804U-UCZ30	2CSC248360		0.98	1
	40	420758	S804U-UCZ40	2CSC248361		0.98	1
	50	420765	S804U-UCZ50	2CSC248362		0.98	1
	60	420772	S804U-UCZ60	2CSC248363		0.98	1
	70	420789	S804U-UCZ70	2CSC248364		0.98	1
	80	420796	S804U-UCZ80	2CSC248365		0.98	1

Where to find more:
Worldwide Marks and Approvals of MCBs p.11/92

Frequently asked question - FAQ:
Where can I get certificates and declaration?
You can find all of them on www.abb.com

High performance MCBs

S800U series 25000 with cage terminal, K characteristic



S801U



S802U

S800U-K characteristic

Function: protection and control of the circuits against overloads and short-circuits when a high breaking capacity is required; protection for people and big length cables in TN and IT systems; very useful when selectivity is needed vs an MCCB or back-up vs other MCBs wired downstream.

Applications: commercial and industrial.

Standard: UL489, CSA 22.2 NO.5-02, IEC/EN 60947-2

Icu=30 kA (1-pole), 50 kA (2...4-pole)

2

Number of poles	Rated current	Bbn 7612271	Order details		Price 1 piece	Weight 1 piece kg	Pack unit pc.
	In A	EAN	Type code	Order code			
1	10	214005	S801U-K10	2CCS881017R0427		0.245	1
	15	214043	S801U-K15	2CCS881017R0457		0.245	1
	20	214081	S801U-K20	2CCS881017R0487		0.245	1
	25	214128	S801U-K25	2CCS881017R0517		0.245	1
	30	214166	S801U-K30	2CCS881017R0527		0.245	1
	40	214203	S801U-K40	2CCS881017R0557		0.245	1
	50	214241	S801U-K50	2CCS881017R0577		0.245	1
	60	214289	S801U-K60	2CCS881017R0587		0.245	1
	70	214326	S801U-K70	2CCS881017R0707		0.245	1
	80	214364	S801U-K80	2CCS881017R0627		0.245	1
	90	214401	S801U-K90	2CCS881017R0907		0.245	1
100	214449	S801U-K100	2CCS881017R0637		0.245	1	

Number of poles	Rated current	Bbn 7612271	Order details		Price 1 piece	Weight 1 piece kg	Pack unit pc.
	In A	EAN	Type code	Order code			
2	10	214012	S802U-K10	2CCS862017R0427		0.49	1
	15	214050	S802U-K15	2CCS862017R0457		0.49	1
	20	214098	S802U-K20	2CCS862017R0487		0.49	1
	25	214135	S802U-K25	2CCS862017R0517		0.49	1
	30	214173	S802U-K30	2CCS862017R0527		0.49	1
	40	214210	S802U-K40	2CCS862017R0557		0.49	1
	50	214258	S802U-K50	2CCS862017R0577		0.49	1
	60	214296	S802U-K60	2CCS862017R0587		0.49	1
	70	214333	S802U-K70	2CCS862017R0707		0.49	1
	80	214371	S802U-K80	2CCS862017R0627		0.49	1
	90	214418	S802U-K90	2CCS862017R0907		0.49	1
100	214456	S802U-K100	2CCS862017R0637		0.49	1	

High performance MCBs

S800U series 25000 with cage terminal, K characteristic



S803U



S804U

Number of poles	Rated current	Bbn 7612271	Order details		Price 1 piece	Weight 1 piece	Pack unit
	In A	EAN	Type code	Order code			
3	10	214029	S803U-K10	2CCS863017R0427		0.735	1
	15	214067	S803U-K15	2CCS863017R0457		0.735	1
	20	214104	S803U-K20	2CCS863017R0487		0.735	1
	25	214142	S803U-K25	2CCS863017R0517		0.735	1
	30	214180	S803U-K30	2CCS863017R0527		0.735	1
	40	214227	S803U-K40	2CCS863017R0557		0.735	1
	50	214265	S803U-K50	2CCS863017R0577		0.735	1
	60	214302	S803U-K60	2CCS863017R0587		0.735	1
	70	214340	S803U-K70	2CCS863017R0707		0.735	1
	80	214388	S803U-K80	2CCS863017R0627		0.735	1
	90	214425	S803U-K90	2CCS863017R0907		0.735	1
	100	214463	S803U-K100	2CCS863017R0637		0.735	1

Number of poles	Rated current	Bbn 7612271	Order details		Price 1 piece	Weight 1 piece	Pack unit
	In A	EAN	Type code	Order code			
4	10	214036	S804U-K10	2CCS864017R0427		0.98	1
	15	214074	S804U-K15	2CCS864017R0457		0.98	1
	20	214111	S804U-K20	2CCS864017R0487		0.98	1
	25	214159	S804U-K25	2CCS864017R0517		0.98	1
	30	214197	S804U-K30	2CCS864017R0527		0.98	1
	40	214234	S804U-K40	2CCS864017R0557		0.98	1
	50	214272	S804U-K50	2CCS864017R0577		0.98	1
	60	214319	S804U-K60	2CCS864017R0587		0.98	1
	70	214357	S804U-K70	2CCS864017R0707		0.98	1
	80	214395	S804U-K80	2CCS864017R0627		0.98	1
	90	214432	S804U-K90	2CCS864017R0907		0.98	1
	100	214470	S804U-K100	2CCS864017R0637		0.98	1

Where to find more:
Worldwide Marks and Approvals of MCBs p.11/92

Frequently asked question - FAQ:
Where can I get certificates and declaration?
You can find all of them on www.abb.com

High performance MCBs

S800U series 3000 PV-S characteristic



S804U

2CCP413379001

S800U PV-S characteristic

Function: string protection.

The new S804U-PVS5 is for string protection in photovoltaic systems.

In case of reverse currents, the breaker will trip. Thus the PV generator will not be damaged.

The breaker is tested acc. to UL489B for 1000 V d.c.

2

Number of poles	Rated current	Bbn 7612271	Order details		Price 1 piece	Weight 1 piece	Pack unit
	In A	EAN	Type code	Order code		kg	pc.
4	5	419929	S801U-PVS5	2CCP824017R1159		0.98	1

High performance MCBs

S800PV series technical features



		S800PV-S	
General	Standards		IEC / EN 60947-2
Data	Poles		2 ... 4
	Tripping characteristics		S
	Rated current I _n	A	10 ... 125
	Rated frequency f	Hz	-
	Rated insulation voltage U _i acc. to IEC/EN 60664-1	V	DC 1500
	Rated impulse withstand voltage U _{imp} . (1.2/50µs)	kV	8
	Overvoltage category		III
	Pollution degree		2
	Suitability for isolation		yes
Data acc. to IEC/EN 60898-1	Rated operational voltage U _e	V	-
	Min. operating voltage	V	-
	Rated short-circuit capacity I _{cn}	kA	-
	Energy limiting class		-
	Reference temperature for tripping characteristics	°C	-
	Electrical and Mechanical Endurance	ops.	-
	Service short-circuit capacity I _{cs}	kA	-
Data acc. to IEC/EN 60947-2	Rated operational voltage U _e	V	2-pole DC 800V: 10 ... 80A DC 600V: 100 ... 125A 3-pole DC 1200V: 10 ... 80A DC 1000V: 100 ... 125A 4-pole DC 1200V: 10 ... 125A
	Min. operating voltage	V	-
	Rated ultimate short-circuit capacity I _{cu}	kA	5
	Rated service short-circuit capacity I _{cs}	kA	5
	Reference temperature for tripping characteristics	°C	30°C
	Electrical and Mechanical Endurance	ops.	10 ... 100A: 1500 electric; 8500 mechanic 125A: 1000 electric, 7000 mechanic acc. to IEC 60947-2
	Mechanical Data	Housing	
Toggle			black, lockable
Classification acc. To NF F 126-101, NF F 16-102			-
Protection degree acc. to EN 60529			IP20; IP40 (actuating end only)
Mechanical endurance		ops.	10'000 cycles
Shock resistance acc. to IEC/EN 60068-2-30			IEC 61373 Cat. 1 Class B, 5g / 30ms acc. to IEC 60068-27 Test Ea
Vibration resistance acc. to IEC/EN 60068-2-6			IEC 60068-2-6 Test Fc; 2 - 13.2Hz /1mm 13.2 - 100Hz / 0.7g with load 100% x I _e
Environmental conditions (damp heat) acc. to IEC/EN 60068-2-30		°C/RH	12 + 12 cycle with 55°C / 90-96% and 25% / 95-100%
Environmental conditions (dry heat) acc. to IEC/EN 60068-2-2 Test B		°C/RH	16 hours 55°C / 2 hours 70°C with damp heat 55%
Ambient temperature		°C	-25 ... +60
Storage temperature		°C	-25 ... +70
Installation		Terminal	
	Stranded Cross-section of conductors (top / bottom)	mm ²	1 ... 50
	Flexible Cross-section of conductors (top/bottom)	mm ²	1 ... 70
	Tightening torque	Nm	3,5
		in-lbs.	31
	Screwdriver		POZI 2
	Mounting		any
	Mounting position		any
	Supply		any
Dimensions and weight	Pole dimensions (H x L x W)	mm	95 x 26.5 x 82.5
	Pole weight	g	240
Combination with aux. elements	Auxiliary contact		yes
	Combined auxiliary- / signal contact		yes
	Shunt trip		yes
	Undervoltage release		yes
	Shunt open release		yes
	Motor Operating Device		yes

High performance MCBs

S800PV series 5000 with cage terminal, S characteristic



S802PV



S803PV

S800PV-S characteristic

Function: protection and control of photovoltaic strings against overloads, short-circuits and reverse currents. Ideal replacement for fuses due to comfortable string failure identification and signalisation.

Applications: Photovoltaic systems.

Standard: IEC 60947-2

Icu=5 kA

2

Number of poles	Rated current	Bbn 7612271	Order details		Price 1 piece	Weight 1 piece	Pack unit
	In A	EAN	Type code	Order code			
2	10	210939	S802PV-S10	2CCP842001R1109		0.49	1
	13	210946	S802PV-S13	2CCP842001R1139		0.49	1
	16	210953	S802PV-S16	2CCP842001R1169		0.49	1
	20	210960	S802PV-S20	2CCP842001R1209		0.49	1
	25	210977	S802PV-S25	2CCP842001R1259		0.49	1
	32	210984	S802PV-S32	2CCP842001R1329		0.49	1
	40	210991	S802PV-S40	2CCP842001R1409		0.49	1
	50	211004	S802PV-S50	2CCP842001R1509		0.49	1
	63	211011	S802PV-S63	2CCP842001R1639		0.49	1
	80	211028	S802PV-S80	2CCP842001R1809		0.49	1
	100	214968	S802PV-S100	2CCP842001R1829		0.49	1
	125	214999	S802PV-S125	2CCP842001R1849		0.49	1

Number of poles	Rated current	Bbn 7612271	Order details		Price 1 piece	Weight 1 piece	Pack unit
	In A	EAN	Type code	Order code			
3	10	211035	S803PV-S10	2CCP843001R1109		0.735	1
	13	211042	S803PV-S13	2CCP843001R1139		0.735	1
	16	211059	S803PV-S16	2CCP843001R1169		0.735	1
	20	211066	S803PV-S20	2CCP843001R1209		0.735	1
	25	211073	S803PV-S25	2CCP843001R1259		0.735	1
	32	211080	S803PV-S32	2CCP843001R1329		0.735	1
	40	211097	S803PV-S40	2CCP843001R1409		0.735	1
	50	211103	S803PV-S50	2CCP843001R1509		0.735	1
	63	211110	S803PV-S63	2CCP843001R1639		0.735	1
	80	211127	S803PV-S80	2CCP843001R1809		0.735	1
	100	214975	S803PV-S100	2CCP843001R1829		0.740	1
	125	215002	S803PV-S125	2CCP843001R1849		0.740	1

Number of poles	Rated current	Bbn 7612271	Order details		Price 1 piece	Weight 1 piece	Pack unit
	In A	EAN	Type code	Order code			
4	10	211134	S804PV-S10	2CCP844001R1109		0.98	1
	13	211141	S804PV-S13	2CCP844001R1139		0.98	1
	16	211158	S804PV-S16	2CCP844001R1169		0.98	1
	20	211165	S804PV-S20	2CCP844001R1209		0.98	1
	25	211172	S804PV-S25	2CCP844001R1259		0.98	1
	32	211189	S804PV-S32	2CCP844001R1329		0.98	1
	40	211196	S804PV-S40	2CCP844001R1409		0.98	1
	50	211202	S804PV-S50	2CCP844001R1509		0.98	1
	63	211219	S804PV-S63	2CCP844001R1639		0.98	1
	80	211226	S804PV-S80	2CCP844001R1809		0.98	1
	100	214982	S804PV-S100	2CCP844001R1829		0.98	1
	125	215019	S804PV-S125	2CCP844001R1849		0.98	1

Where to find more:
Worldwide Marks and Approvals of MCBs p.11/92

Frequently asked question - FAQ:
Where can I get certificates and declaration?
You can find all of them on www.abb.com

Maybe you are also interested in:
Auxiliary Elements for S 800 MCBs p.4/53 and p.4/62
S800PV switch disconnecter p.6/15

MCBs

S500 series technical features



S500

2

		S500-K	
General Data	Tripping characteristics		K
	Standards		IEC 60947-2
	Poles		1 ... 3
	Rated current I_n	A	0.1 ... 45
	Rated frequency f	Hz	50/60
	Rated insulation voltage U_i acc. to IEC/EN 60664-1	V	AC 690 V
	Rated impulse withstand voltage U_{imp} (1.2/50 μ s)	kV	6
	Overvoltage category	II	
	Pollution degree	3	
	Suitability for isolation	yes	
Data acc. to IEC/EN 60898-1	Rated operational voltage U_e	V	–
	Min. operating voltage	V	–
	Rated short-circuit capacity I_{cn}	kA	–
	Reference temperature for tripping characteristics	°C	–
	Electrical and Mechanical Endurance	ops.	–
	Service short-circuit capacity I_{cs}	kA	–
Data acc. to IEC/EN 60947-2	Rated operational voltage U_e	V	400/690 V AC
	Min. operating voltage	V	12 V AC
	Rated ultimate short-circuit capacity I_{cu}		
	AC 230/400V	kA	0.1– 11 A: 50 kA; 10–45 A: 30 kA
	AC 250/440V		0.1–11 A: 30 kA; 10–45 A: 25 kA
	AC 3 x 500V		0.1–11 A: 20 kA; 10–45 A: 15 kA
	AC 400/690V		0.1–45 A: 6 kA
	Rated service short-circuit capacity I_{cs}		
	AC 230/400V	kA	0.1–11 A: 30 kA; 10–45 A: 25 kA
	AC 250/440V		0.1–45 A: 22 kA
	AC 3 x 500V		0.1–11 A: 15 kA; 10–45 A: 11 kA
	AC 400/690V		0.1–45 A: 3 kA
	Reference temperature for tripping characteristics	°C	40
	Electrical and Mechanical Endurance	ops.	0.1 ... 45 A: 1500 electric; 8500 mechanic
Data acc. to UL/CSA	Rated voltage	V	AC 600
	Rated interrupting capacity acc. to UL 1077	kA	
	AC 240/415V kA		<25A: 30kA; >25: 18kA
	AC 277/480V		14
	AC 346/600		6
	Reference temperature for tripping characteristics	°C	25
	Electrical and Mechanical endurance	ops.	acc. to UL1077. 6000 electric; 8500 mechanic

		S500-K	
Mechanical Data	Housing		Material group I, RAL 7035
	Toggle		black, lockable
	Classification acc. to NF F 16-101, NF F 16-102		I2, F1
	Protection degree acc. to EN 60529		IP20; IP40 (actuating end only)
	Vibration resistance acc. to IEC/EN 60068-2-30		IEC 61373 Cat. 1 Class B, 5 g/30 ms acc. to IEC 60068-27 Test Ea
	Vibration resistance acc. to IEC/EN 60068-2-6		IEC 60068-2-6 Test Fc; 2–13.2 Hz/1 mm 13.2–100 Hz/0.7 g with load 100 % x le
	Environmental conditions (damp heat) acc. to IEC/EN 60068-2-30 test Db		12 + 12 cycle with 55 °C/90–96 % r.g. and 25 %/95–100 % r.f.
	Environmental conditions (damp heat) acc. to IEC/EN 60068-2-2 Test B		16 hours 55 °C/2 hours 70 °C with damp heat 55 %
	Ambient temperature	°C	–25 ... +55
	Storage temperature	°C	–40 ... +70
	Terminal		Cage terminal
	Connections (top/bottom) – CU only	mm ²	1 ... 25
	Installation	Tightening torque	Nm
Screwdriver			POZI 2
Mounting			EN 60715
Mounting position			any
Supply			any
Dimensions and weight	Pole dimensions (H x L x W)	mm	91 x 92 x 25
	Pole weight	g	ca. 250
Combination with aux. elements	Auxiliary contact		Yes
	Signal contact		Yes
	Shunt trip		Yes
	Undervoltage release		Yes
	Shunt open release		Yes
	Motor Operating Device		Yes

2

MCBs

S500 series technical features



S500

2

		S500UC-K	
General Data	Tripping characteristics		K
	Standards		IEC 60947-2
	Poles		1 ... 4
	Rated current I _e	A	0.1 ... 45
	Rated frequency f	Hz	–
	Rated insulation voltage U _i acc. to IEC/EN 60664-1	V	1000V DC
	Rated impulse withstand voltage U _{imp} . (1.2/50µs)	kV	6
	Overvoltage category		II
	Pollution degree		2
	Suitability for isolation		yes
Data acc. to IEC/EN 60898-1	Rated operational voltage U _e	V	–
	Min. operating voltage	V	–
	Rated short-circuit capacity I _{cn}	kA	–
	Reference temperature for tripping characteristics	°C	–
	Electrical and Mechanical Endurance	ops.	–
	Service short-circuit capacity I _{cs}	kA	–
Data acc. to IEC/EN 60947-2	Rated operational voltage U _e	V	DC 250 V/pol, max. DC 750 V
	Min. operating voltage	V	–
	Rated ultimate short-circuit capacity I _{cu}		
	DC 250 V L/R 15 ms (1-pole)	kA	30 kA
	DC 500 V L/R 15 ms (2-pole in series)		30 kA
	DC 750 V L/R 15 ms (3- and 4-pole in series)		30 kA
	Rated service short-circuit capacity I _{cs}		
	DC 250 V L/R 15 ms (1-pole)	kA	30 kA
	DC 500 V L/R 15 ms (2-pole)		30 kA
	DC 750 V L/R 15 ms (3- and 4-pole)		30 kA
	Reference temperature for tripping characteristics	°C	40
	Electrical and Mechanical Endurance	ops.	0.1 ... 45 A: 1500 electric; 8500 mechanic
	Data acc. to UL/CSA	Rated voltage	V
Rated interrupting capacity acc. to UL 1077 kA			
DC 250V (1-pole)		kA	30 kA
DC 500V (2-pole in series)			30 kA
DC 750V (3- and 4-pole in series)			30 kA
Reference temperature for tripping characteristics		°C	25
Electrical and Mechanical endurance		ops.	acc. to UL1077. 6000 electric, 4000 mechanic

		S500UC-K	
Mechanical Data	Housing		Material group I, RAL 7035
	Toggle		black, lockable
	Classification acc. to NF F 16-101, NF F 16-102		I2, F1
	Protection degree acc. to EN 60529		IP20; IP40 (actuating end only)
	Vibration resistance acc. to IEC/EN 60068-2-6		IEC 61373 Cat. 1 Class B, 5 g/30 ms acc. to IEC 60068-27 Test Ea
	Vibration resistance acc. to IEC/EN 60068-2-6		IEC 60068-2-6 Test Fc; 2–13.2 Hz/1 mm 13.2–100 Hz/0.7 g with load 100 % x le
	Environmental conditions (damp heat) acc. to IEC/EN 60068-2-30 test Db		12 + 12 cycle with 55 °C/90 –96 % r.g. and 25 %/95 –100 % r.f.
	Environmental conditions (damp heat) acc. to IEC/EN 60068-2-2 Test B		16 hours 55 °C/2 hours 70 °C with damp heat 55 %
	Ambient temperature	°C	–25 ... +55
	Storage temperature	°C	–40 ... +70
	Terminal		Cage terminal
Connections (top/bottom) – CU only	mm ²	1 ... 25	
Installation	Tightening torque	Nm	2.5
	Screwdriver		POZI 2
	Mounting		EN 60715
	Mounting position		any
	Supply		any
Dimensions and weight	Pole dimensions (H x L x W)	mm	91 x 92 x 25
	Pole weight	g	ca. 250
Combination with aux. elements	Auxiliary contact		Yes
	Signal contact		Yes
	Shunt trip		Yes
	Undervoltage release		Yes
	Shunt open release		Yes
	Motor Operating Device		Yes

2

MCBs

S500 series technical features



S500

		S500HV-K	
General Data	Tripping characteristics		K
	Standards		IEC 60947-2
	Poles		1 ... 3
	Rated current I _e	A	1 ... 45
	Rated frequency f	Hz	50/60
	Rated insulation voltage U _i acc. to IEC/EN 60664-1	V	AC 1000 V
	Rated impulse withstand voltage U _{imp} . (1.2/50 μs)	kV	6
	Overvoltage category		II
	Pollution degree		2
	Suitability for isolation		yes
Data acc. to IEC/EN 60898-1	Rated operational voltage U _e	V	–
	Min. operating voltage	V	–
	Rated short-circuit capacity I _{cn}	kA	–
	Reference temperature for tripping characteristics	°C	–
	Electrical and Mechanical Endurance	ops.	–
	Service short-circuit capacity I _{cs}	kA	–
Data acc. to IEC/EN 60947-2	Rated operational voltage U _e	V	AC 580/1000 V
	Min. operating voltage	V	12 V AC
	Rated ultimate short-circuit capacity I _{cu}		
	AC 580/1000V	kA	1.5
	Rated service short-circuit capacity I _{cs}		
	AC 580/1000V	kA	1.5
	Reference temperature for tripping characteristics	°C	40
Data acc. to UL/CSA	Electrical and Mechanical Endurance	ops.	–
	Rated voltage	V	–
	Rated interrupting capacity acc. to UL 1077	kA	–
	AC 240/415V	kA	–
	AC 277/480V		–
	AC 346/600		–
Mechanical Data	Reference temperature for tripping characteristics		–
	Electrical and Mechanical endurance	ops.	–
	Housing		Material group I, RAL 7035
	Toggle		black, lockable
	Classification acc. to NF F 16-101, NF F 16-102		I2, F1
	Protection degree acc. to EN 60529		IP20; IP40 (actuating end only)
	Vibration resistance acc. to IEC/EN 60068-2-6		w
	Environmental conditions (damp heat) acc. to IEC/EN 60068-2-30 test Db		12 + 12 cycle with 55 °C/90 –96 % r.g. and 25 %/95 –100 % r.f.
	Environmental conditions (dry heat) acc. to IEC/EN 60068-2-2 Test B		16 hours 55 °C/2 hours 70 °C with damp heat 55 %
	Ambient temperature	°C	–25 ... +55
	Storage temperature	°C	–40 ... +70
Terminal		Cage terminal	
Connections (top/bottom) – CU only	mm ²	1 ... 25	

			S500HV-K
Installation	Tightening torque	Nm	2.5
	Screwdriver		POZI 2
	Mounting		EN 60715
	Mounting position		any
	Supply		any
Dimensions and weight	Pole dimensions (H x L x W)	mm	91 x 92 x 25
	Pole weight	g	ca. 250
Combination with aux. elements	Auxiliary contact		Yes
	Signal contact		Yes
	Shunt trip		Yes
	Undervoltage release		Yes
	Shunt open release		Yes
	Motor Operating Device		Yes

2

MCBs

S500 series with adjustable thermal release for motor protection, K characteristic



S501

S500-K (power) characteristic

Function: protection and control of the circuits like motors, transformer and auxiliary circuits, against overloads and short-circuits when an high breaking capacity is required; very useful when it is needed selectivity vs an MCCB or back-up vs other MCBs wired downstream; version with adjustable thermal release, dedicated to protect motors.

Advantages: No nuisance tripping in the case of functional peak currents up to $8xI_n$, depending on the series; through its highly sensitive thermostatic bimetal trip, the K-type characteristic offers protection to damageable elements in the overcurrent range; it also provides the best protection to cables and lines.

Applications: commercial and industrial.

Standard: IEC/EN 60947-2, UL 1077

Icu up to 50 kA

Number of poles	Rated current	Bbn 7612270	Order details		Price 1 piece	Weight 1 piece kg	Pack unit pc.
	In A	EAN	Type code	Order code			
1	0.1-0.15	303007	S501 K0.1 - 0.15	2CCF008856R0001		0.250	1
	0.14-0.21	303014	S501 K0.14 - 0.21	2CCF008857R0001		0.250	1
	0.2-0.3	303021	S501 K0.2 - 0.3	2CCF008858R0001		0.250	1
	0.28-0.42	303038	S501 K0.28 - 0.42	2CCF008859R0001		0.250	1
	0.38-0.58	303045	S501 K0.38 - 0.58	2CCF008860R0001		0.250	1
	0.53-0.8	303052	S501 K0.53 - 0.8	2CCF008861R0001		0.250	1
	0.73-1.1	303069	S501 K0.73 - 1.1	2CCF008862R0001		0.250	1
	1-1.5	303076	S501 K1 - 1.5	2CCF008863R0001		0.250	1
	1.4-2.1	303083	S501 K1.4 - 2.1	2CCF008864R0001		0.250	1
	2-3	303090	S501 K2-3	2CCF008865R0001		0.250	1
	2.8-4.2	303106	S501 K2.8 - 4.2	2CCF008866R0001		0.250	1
	3.8-5.8	303113	S501 K3.8 - 5.8	2CCF008867R0001		0.250	1
	5.3-8	303120	S501 K5.3 - 8	2CCF008868R0001		0.250	1
	7.3-11	303137	S501 K7.3 - 11	2CCF008869R0001		0.250	1
	10-15	303144	S501 K10 - 15	2CCF008870R0001		0.250	1
	14-20	303151	S501 K14 - 20	2CCF008871R0001		0.250	1
	18-26	303168	S501 K18 - 26	2CCF008872R0001		0.250	1
	23-32	303175	S501 K23 - 32	2CCF008873R0001		0.250	1
	29-37	303182	S501 K29 - 37	2CCF008874R0001		0.250	1
	34-41	303199	S501 K34 - 41	2CCF008877R0001		0.250	1
38-45	303205	S501 K38 - 45	2CCF008888R0001		0.250	1	

Where to find more:

Worldwide Marks and Approvals of MCBs p.11/92
 Technical catalogue of S500 MCBs (code 2CCC413003C0202)



Maybe you are also interested in:

Auxiliary Elements for S500 MCBs p.4/64

MCBs

S500 series with adjustable thermal release for motor protection, K characteristic



S502



S503

Number of poles	Rated current	Bbn 7612270	Order details		Price 1 piece	Weight 1 piece kg	Pack unit pc.
	In A	EAN	Type code	Order code			
2	0.1-0.15	303250	S502 K0.1 - 0.15	2CCF008894R0001		0.500	1
	0.14-0.21	303267	S502 K0.14 - 0.21	2CCF008895R0001		0.500	1
	0.2-0.3	303274	S502 K0.2 - 0.3	2CCF008896R0001		0.500	1
	0.28-0.42	303281	S502 K0.28 - 0.42	2CCF008897R0001		0.500	1
	0.38-0.58	303298	S502 K0.38 - 0.58	2CCF008898R0001		0.500	1
	0.53-0.8	303304	S502 K0.53 - 0.8	2CCF008899R0001		0.500	1
	0.73-1.1	303311	S502 K0.73 - 1.1	2CCF008900R0001		0.500	1
	1-1.5	303328	S502 K1 - 1.5	2CCF008901R0001		0.500	1
	1.4-2.1	303335	S502 K1.4 - 2.1	2CCF008902R0001		0.500	1
	2-3	303342	S502 K2-3	2CCF008903R0001		0.500	1
	2.8-4.2	303359	S502 K2.8 - 4.2	2CCF008904R0001		0.500	1
	3.8-5.8	303366	S502 K3.8 - 5.8	2CCF008905R0001		0.500	1
	5.3-8	303373	S502 K5.3 - 8	2CCF008906R0001		0.500	1
	7.3-11	303380	S502 K7.3 - 11	2CCF008907R0001		0.500	1
	10-15	303397	S502 K10 - 15	2CCF008908R0001		0.500	1
	14-20	303403	S502 K14 - 20	2CCF008909R0001		0.500	1
	18-26	303410	S502 K18 - 26	2CCF008910R0001		0.500	1
	23-32	303427	S502 K23 - 32	2CCF008911R0001		0.500	1
29-37	303434	S502 K29 - 37	2CCF008912R0001		0.500	1	
34-41	303441	S502 K34 - 41	2CCF008913R0001		0.500	1	
38-4	303458	S502 K38 - 45	2CCF008926R0001		0.500	1	

2

Number of poles	Rated current	Bbn 7612270	Order details		Price 1 piece	Weight 1 piece kg	Pack unit pc.
	In A	EAN	Type code	Order code			
3	0.1-0.15	303502	S503 K0.1 - 0.15	2CCF008932R0001		0.750	1
	0.14-0.21	303519	S503 K0.14 - 0.21	2CCF008933R0001		0.750	1
	0.2-0.3	303526	S503 K0.2 - 0.3	2CCF008934R0001		0.750	1
	0.28-0.42	303533	S503 K0.28 - 0.42	2CCF008935R0001		0.750	1
	0.38-0.58	303540	S503 K0.38 - 0.58	2CCF008936R0001		0.750	1
	0.53-0.8	303557	S503 K0.53 - 0.8	2CCF008937R0001		0.750	1
	0.73-1.1	303564	S503 K0.73 - 1.1	2CCF008938R0001		0.750	1
	1-1.5	303571	S503 K1 - 1.5	2CCF008939R0001		0.750	1
	1.4-2.1	303588	S503 K1.4 - 2.1	2CCF008940R0001		0.750	1
	2-3	303595	S503 K2-3	2CCF008941R0001		0.750	1
	2.8-4.2	303601	S503 K2.8 - 4.2	2CCF008942R0001		0.750	1
	3.8-5.8	303618	S503 K3.8 - 5.8	2CCF008943R0001		0.750	1
	5.3-8	303625	S503 K5.3 - 8	2CCF008944R0001		0.750	1
	7.3-11	303632	S503 K7.3 - 11	2CCF008945R0001		0.750	1
	10-15	303649	S503 K10 - 15	2CCF008946R0001		0.750	1
	14-20	303656	S503 K14 - 20	2CCF008947R0001		0.750	1
	18-26	303663	S503 K18 - 26	2CCF008948R0001		0.750	1
	23-32	303670	S503 K23 - 32	2CCF008949R0001		0.750	1
	29-37	303687	S503 K29 - 37	2CCF008950R0001		0.750	1
	34-41	303694	S503 K34 - 41	2CCF008951R0001		0.750	1
	38-45	303700	S503 K38 - 45	2CCF008964R0001		0.750	1

MCBs

S500UC series technical features



S501UC

		S500UC-K	
Standards		IEC/EN 60947-2, UL 1077 a, CAN/CSA-C22.2 a No. 35	
Rated current I _n		A	adjustable 0.1 ≤ I _n ≤ 3 / 2.8 ≤ I _n ≤ 11 / 10 ≤ I _n ≤ 45
Poles		1 ... 4	
Rated voltage U _e	DC	V	250 per pole (4P 750V)
Insulation voltage U _i		V	1000 VDC
Max. operating voltage U _b max.	DC	V	250 per pole (4P 750V)
Rated breaking capacity	ultimate I _{cu}	kA	30
acc. to IEC/EN 60947-2 1P@ 250 VDC 2P@500 VDC 3P, 4P@ 750 VDC			
Rated interrupting capacity acc. to	IR	kA	30
UL1077, CSA22.2 No.235 1P@60 VDC 2P, 3P, 4P@125 VDC			
Rated impulse withstand voltage U _{imp}		kV	6
Overvoltage category			
Thermomagnetic release characteristic	K: 8 I _n ≤ I _m ≤ 14 I _n	☐	
Toggle		grey sealable in ON-OFF position	
Protection degree	housing	IP4X	
	terminals	IP2X	
Tropicalization acc. to IEC/EN 60068-2	humid heat	°C/RH	DIN 50016
Reference temperature for setting of thermal element		°C	40
Ambient temperature (with daily average ≤ +35 °C)		°C	-25 ... +55
Terminal type		cage (shock protected)	
Terminal size top/bottom for cable	IEC	mm ²	1 ... 25
	UL/CSA	AWG	17-4
Tightening torque	IEC	Nm	2.5
Tool		Nr. 2 Posidriv	
Mounting		on DIN rail EN 60715	
Connection		from top and bottom	
Pole dimensions (H x D x W)		mm	91 x 92 x 25
Pole weight		g	250
Combinable with:	signal contact/auxiliary switch	yes	
	shunt trip	yes	
	undervoltage release	yes (factory fitted)	
	mechanical interlock	no	
	motor operating device	no	

① supplementary protection

Where to find more:

Worldwide Marks and Approvals of MCBs p.11/92
Technical catalogue of S500 MCBs (code 2CCC413003C0202)



Maybe you are also interested in:
Auxiliary Elements for S500 MCBs p.4/64

MCBs

S500UC series DC range, K characteristic



S501UC

S500UC series K (power) characteristic

Function: protection and control of the circuits like motors, transformer and auxiliary circuits, against overloads and short-circuits when an high breaking capacity is required; very useful when it is needed selectivity vs an MCCB or back-up vs other MCBs wired downstream; version with adjustable thermal release, dedicated to protect motors; version dedicated to application in direct current circuits.

Advantages: No nuisance tripping in the case of functional peak currents up to 8xIn, depending on the series; through its highly sensitive thermostatic bimetal trip, the K-type characteristic offers protection to damageable elements in the overcurrent range; it also provides the best protection to cables and lines.

Applications: commercial and industrial.

Standard: IEC/EN 60947-2, UL1077

Icu up to 30 kA

2

Number of poles	Rated current	Bbn 7612270	Order details		Price 1 piece	Weight 1 piece kg	Pack unit pc.
	In A	EAN	Type code	Order code			
1	0.1-0.15	302000	S501 UC-K0.1 - 0.15	2CCF008988R0001		0.250	1
	0.14-0.21	302017	S501 UC-K0.14 - 0.21	2CCF008991R0001		0.250	1
	0.2-0.3	302024	S501 UC-K0.2 - 0.3	2CCF008994R0001		0.250	1
	0.28-0.42	302031	S501 UC-K0.28 - 0.42	2CCF008997R0001		0.250	1
	0.38-0.58	302048	S501 UC-K0.38 - 0.58	2CCF009000R0001		0.250	1
	0.53-0.8	302055	S501 UC-K0.53 - 0.8	2CCF009003R0001		0.250	1
	0.73-1.1	302062	S501 UC-K0.73 - 1.1	2CCF009006R0001		0.250	1
	1-1.5	302079	S501 UC-K1 - 1.5	2CCF009009R0001		0.250	1
	1.4-2.1	302086	S501 UC-K1.4 - 2.1	2CCF009012R0001		0.250	1
	2-3	302093	S501 UC-K2-3	2CCF009015R0001		0.250	1
	2.8-4.2	302109	S501 UC-K2.8 - 4.2	2CCF009018R0001		0.250	1
	3.8-5.8	302116	S501 UC-K3.8 - 5.8	2CCF009021R0001		0.250	1
	5.3-8	302123	S501 UC-K5.3 - 8	2CCF009024R0001		0.250	1
	7.3-11	302130	S501 UC-K7.3 - 11	2CCF009027R0001		0.250	1
	10-15	302147	S501 UC-K10 - 15	2CCF009030R0001		0.250	1
	14-20	302154	S501 UC-K14 - 20	2CCF009033R0001		0.250	1
	18-26	302161	S501 UC-K18 - 26	2CCF009036R0001		0.250	1
	23-32	302178	S501 UC-K23 - 32	2CCF009039R0001		0.250	1
	29-37	302185	S501 UC-K29 - 37	2CCF009042R0001		0.250	1
	34-41	302192	S501 UC-K34 - 41	2CCF009045R0001		0.250	1
38-45	302208	S501 UC-K38 - 45	2CCF009048R0001		0.250	8	

MCBs

S500UC series DC range, K characteristic



Number of poles	Rated current	Bbn 7612270	Order details		Price 1 piece	Weight 1 piece	Pack unit
	In A	EAN	Type code	Order code			
2	0.1-0.15	302253	S502 UC-K0.1 - 0.15	2CCF008989R0001		0.500	1
	0.14-0.21	302260	S502 UC-K0.14 - 0.21	2CCF008992R0001		0.500	1
	0.2-0.3	302277	S502 UC-K0.2 - 0.3	2CCF008995R0001		0.500	1
	0.28-0.42	302284	S502 UC-K0.28 - 0.42	2CCF008998R0001		0.500	1
	0.38-0.58	302291	S502 UC-K0.38 - 0.58	2CCF009001R0001		0.500	1
	0.53-0.8	302307	S502 UC-K0.53 - 0.8	2CCF009004R0001		0.500	1
	0.73-1.1	302314	S502 UC-K0.73 - 1.1	2CCF009007R0001		0.500	1
	1-1.5	302321	S502 UC-K1 - 1.5	2CCF009010R0001		0.500	1
	1.4-2.1	302338	S502 UC-K1.4 - 2.1	2CCF009013R0001		0.500	1
	2-3	302345	S502 UC-K2-3	2CCF009016R0001		0.500	1
	2.8-4.2	302352	S502 UC-K2.8 - 4.2	2CCF009019R0001		0.500	1
	3.8-5.8	302369	S502 UC-K3.8 - 5.8	2CCF009022R0001		0.500	1
	5.3-8	302376	S502 UC-K5.3 - 8	2CCF009025R0001		0.500	1
	7.3-11	302383	S502 UC-K7.3 - 11	2CCF009028R0001		0.500	1
	10-15	302390	S502 UC-K10 - 15	2CCF009031R0001		0.500	1
	14-20	302406	S502 UC-K14 - 20	2CCF009034R0001		0.500	1
	18-26	302413	S502 UC-K18 - 26	2CCF009037R0001		0.500	1
	23-32	302420	S502 UC-K23 - 32	2CCF009040R0001		0.500	1
	29-37	302437	S502 UC-K29 - 37	2CCF009043R0001		0.500	1
	34-41	302444	S502 UC-K34 - 41	2CCF009046R0001		0.500	1
38-45	302451	S502 UC-K38 - 45	2CCF009049R0001		0.500	1	

Number of poles	Rated current	Bbn 7612270	Order details		Price 1 piece	Weight 1 piece	Pack unit
	In A	EAN	Type code	Order code			
3	0.1-0.15	302505	S503 UC-K0.1 - 0.15	2CCF008990R0001		0.750	1
	0.14-0.21	302512	S503 UC-K0.14 - 0.21	2CCF008993R0001		0.750	1
	0.2-0.3	302529	S503 UC-K0.2 - 0.3	2CCF008996R0001		0.750	1
	0.28-0.42	302536	S503 UC-K0.28 - 0.42	2CCF008999R0001		0.750	1
	0.38-0.58	302543	S503 UC-K0.38 - 0.58	2CCF009002R0001		0.750	1
	0.53-0.8	302550	S503 UC-K0.53 - 0.8	2CCF009005R0001		0.750	1
	0.73-1.1	302567	S503 UC-K0.73 - 1.1	2CCF009008R0001		0.750	1
	1-1.5	302574	S503 UC-K1 - 1.5	2CCF009011R0001		0.750	1
	1.4-2.1	302581	S503 UC-K1.4 - 2.1	2CCF009014R0001		0.750	1
	2-3	302598	S503 UC-K2-3	2CCF009017R0001		0.750	1
	2.8-4.2	302604	S503 UC-K2.8 - 4.2	2CCF009020R0001		0.750	1
	3.8-5.8	302611	S503 UC-K3.8 - 5.8	2CCF009023R0001		0.750	1
	5.3-8	302628	S503 UC-K5.3 - 8	2CCF009026R0001		0.750	1
	7.3-11	302635	S503 UC-K7.3 - 11	2CCF009029R0001		0.750	1
	10-15	302642	S503 UC-K10 - 15	2CCF009032R0001		0.750	1
	14-20	302659	S503 UC-K14 - 20	2CCF009035R0001		0.750	1
	18-26	302666	S503 UC-K18 - 26	2CCF009038R0001		0.750	1
	23-32	302673	S503 UC-K23 - 32	2CCF009041R0001		0.750	1
	29-37	302680	S503 UC-K29 - 37	2CCF009044R0001		0.750	1
	34-41	302697	S503 UC-K34 - 41	2CCF009047R0001		0.750	1
38-45	302703	S503 UC-K38 - 45	2CCF009050R0001		0.750	1	

Where to find more:
Worldwide Marks and Approvals of MCBs p.11/92
Technical catalogue of S500 MCBs (code 2CCC413003C0202)



Maybe you are also interested in:
Auxiliary Elements for S500 MCBs p.4/64

Number of poles	Rated current	Bbn 7612270	Order details		Price 1 piece	Weight 1 piece kg	Pack unit pc.
	In A	EAN	Type code	Order code			
4	0.1-0.15	302758	S504UC-K0,15	2CCF011771R0001		0,92	1
	0.14-0.21	302765	S504UC-K0,21	2CCF011772R0001		0,92	1
	0.2-0.3	302772	S504UC-K0,3	2CCF011576R0001		0,92	1
	0.28-0.42	302789	S504UC-K0,42	2CCF011773R0001		0,92	1
	0.38-0.58	302796	S504UC-K0,58	2CCF011774R0001		0,92	1
	0.53-0.8	302802	S504UC-K0,8	2CCF011775R0001		0,92	1
	0.73-1.1	302819	S504UC-K1,1	2CCF011776R0001		0,92	1
	1-1.5	302826	S504UC-K1,5	2CCF011777R0001		0,92	1
	1.4-2.1	302833	S504UC-K2,1	2CCF011778R0001		0,92	1
	2-3	302840	S504UC-K3	2CCF011779R0001		0,92	1
	2.8-4.2	302857	S504UC-K4,2	2CCF011780R0001		0,92	1
	3.8-5.8	302864	S504UC-K5,8	2CCF011781R0001		0,92	1
	5.3-8	302871	S504UC-K8	2CCF011782R0001		0,92	1
	7.3-11	302888	S504UC-K11	2CCF011509R0001		0,92	1
	10-15	302895	S504UC-K15	2CCF011783R0001		0,92	1
	14-20	302901	S504UC-K20	2CCF011784R0001		0,92	1
	18-26	302918	S504UC-K26	2CCF011785R0001		0,92	1
	23-32	302925	S504UC-K32	2CCF011786R0001		0,92	1
	29-37	302932	S504UC-K37	2CCF011787R0001		0,92	1
	34-41	302949	S504UC-K41	2CCF011788R0001		0,92	1
38-45	302956	S504UC-K45	2CCF011789R0001		0,92	1	

2

MCBs

S500HV series for applications up to 1000 VAC, K characteristic



S501HV



S502HV



S503HV

Icu = 1.5 kA

Number of poles	Rated current	Bbn 761227	Order details		Price 1 piece	Weight 1 piece	Pack unit
	In A		EAN	Type code			
1	1	0403454	S501HV-K1	580V	2CCF017747R0001	0.25	1
	3	0424160	S501HV-K3	580V	2CCF015787R0001	0.25	1
	4	0424184	S501HV-K4	580V	2CCF015790R0001	0.25	1
	6	0424214	S501HV-K6	580V	2CCF015793R0001	0.25	1
	8	0424245	S501HV-K8	580V	2CCF015796R0001	0.25	1
	10	0424276	S501HV-K10	580V	2CCF015799R0001	0.25	1
	13	0424306	S501HV-K13	580V	2CCF015802R0001	0.25	1
	16	0424337	S501HV-K16	580V	2CCF015805R0001	0.25	1
	20	0424368	S501HV-K20	580V	2CCF015808R0001	0.25	1
	25	0424399	S501HV-K25	580V	2CCF015811R0001	0.25	1
	32	0424429	S501HV-K32	580V	2CCF015814R0001	0.25	1
	40	0424450	S501HV-K40	580V	2CCF015817R0001	0.25	1
	45	0424481	S501HV-K45	580V	2CCF015820R0001	0.25	1

Number of poles	Rated current	Bbn 761227	Order details		Price 1 piece	Weight 1 piece	Pack unit
	In A		EAN	Type code			
2	1	1407810	S502HV-K1	1000V	2CCF017961R0001	0.50	1
	3	0424177	S502HV-K3	1000V	2CCF015788R0001	0.50	1
	4	0424191	S502HV-K4	1000V	2CCF015791R0001	0.50	1
	6	0424221	S502HV-K6	1000V	2CCF015794R0001	0.50	1
	8	0424252	S502HV-K8	1000V	2CCF015797R0001	0.50	1
	10	0424283	S502HV-K10	1000V	2CCF015800R0001	0.50	1
	13	0424313	S502HV-K13	1000V	2CCF015803R0001	0.50	1
	16	0424344	S502HV-K16	1000V	2CCF015806R0001	0.50	1
	20	0424375	S502HV-K20	1000V	2CCF015809R0001	0.50	1
	25	0424405	S502HV-K25	1000V	2CCF015812R0001	0.50	1
	32	0424436	S502HV-K32	1000V	2CCF015815R0001	0.50	1
	40	0424467	S502HV-K40	1000V	2CCF015818R0001	0.50	1
	45	0424498	S502HV-K45	1000V	2CCF015821R0001	0.50	1

Number of poles	Rated current	Bbn 761227	Order details		Price 1 piece	Weight 1 piece	Pack unit
	In A		EAN	Type code			
3	1	0403461	S503HV-K1	1000V	2CCF017748R0001	0.71	1
	3	0500499	S503HV-K3	1000V	2CCF015827R0001	0.71	1
	4	0424207	S503HV-K4	1000V	2CCF015792R0001	0.71	1
	6	0424238	S503HV-K6	1000V	2CCF015795R0001	0.71	1
	8	0424269	S503HV-K8	1000V	2CCF015798R0001	0.71	1
	10	0424290	S503HV-K10	1000V	2CCF015801R0001	0.71	1
	13	0424320	S503HV-K13	1000V	2CCF015804R0001	0.71	1
	16	0424351	S503HV-K16	1000V	2CCF015807R0001	0.71	1
	20	0424382	S503HV-K20	1000V	2CCF015810R0001	0.71	1
	25	0424412	S503HV-K25	1000V	2CCF015813R0001	0.71	1
	32	0424443	S503HV-K32	1000V	2CCF015816R0001	0.71	1
	40	0424474	S503HV-K40	1000V	2CCF015819R0001	0.71	1
	45	0424504	S503HV-K45	1000V	2CCF015822R0001	0.71	1

Where to find more:
Worldwide Marks and Approvals of MCBs p.11/92
Technical catalogue of S500 MCBs (code 2CCC413003C0202)



Maybe you are also interested in:
Auxiliary Elements for S500 MCBs p.4/64

System pro M compact®

Residual current devices

Quick selection of RCDs for household and industrial applications 3/2

RCCBs

F 200	3/8
F 200 for overseas markets	3/10
F 200 left neutral	3/11
F 200 AP-R (high immunity)	3/15
F 200 for high frequency and rail ways applications	3/17
F 200 B type	3/19
F 200 PV	3/21

3

RCD-blocks

DDA 200	3/24
DDA 200 special version 110 V and 400 V	3/28
DDA 200 AP-R	3/29
DDA 200 AE for emergency stop	3/30
DDA 200 selective	3/31
DDA 200 B APR	3/32

RCBOs

DS201 L	3/38
DS201	3/41
DS201 M	3/48
DS202C	3/56
DS202C M	3/58
DS 200	3/66
DS 200 M	3/71

RCD-blocks

DDA 800	3/78
---------	------

RCBOs

DS800S, DS800N	3/84
DS 271	3/92

Residual current relays

RD2	3/94
RD3	3/95
ELR front panel residual current relays	3/97
TR toroidal transformers	3/98

System pro M compact®

Quick selection of RCDs for household and industrial applications

Easy! Find the right range and the corresponding catalogue page at a glance using this selection chart.

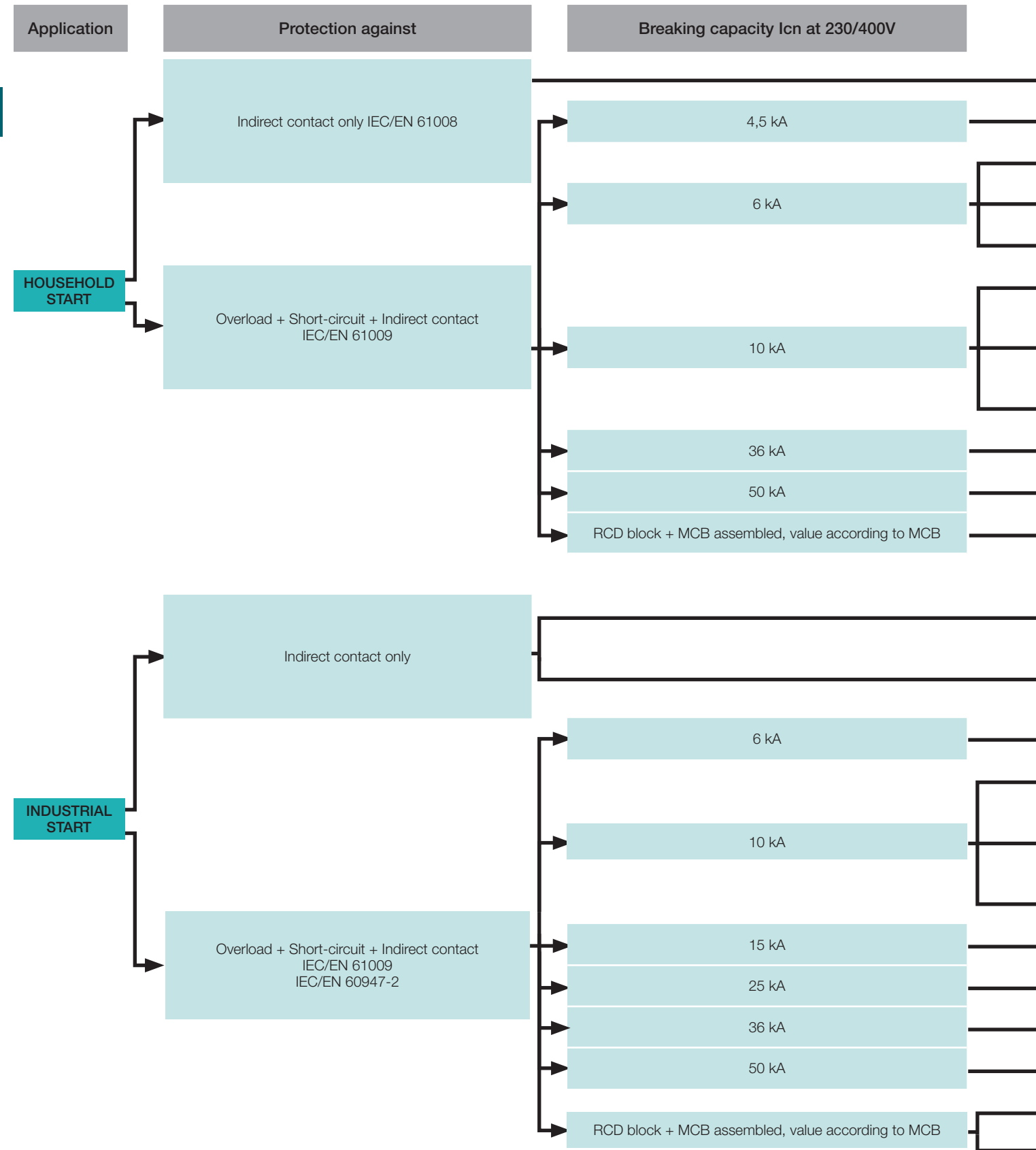

Rated current	Remark	Poles	Solution	Page
Up to 125 A		All poles	F200	3/6
Up to 32 A		1P+N	DS201 L	3/30
Up to 32 A	Reduced size	2P	DS202C	3/42
Up to 40 A	Reduced size	1P+N	DS201	3/32
Up to 63 A	Standard size	All poles	DS 200	3/48
Up to 32 A	Reduced size	2P	DS202C M	3/44
Up to 40 A	Reduced size	1P+N	DS201 M	3/36
	Voltage dependent	1P+N	DS 271	3/76
Up to 63 A	Standard size	All poles	DS 200 M	3/53
Up to 125 A		All poles	DS800N	3/68
Up to 125 A		All poles	DS800S	3/68
Up to 63 A	RCD: IEC/EN 61009 Ann. G	All poles	DDA 200 + S200	3/20 + 2/12

3

Up to 125 A	IEC/EN 61008	All poles	F200	3/6
According to MCB	IEC/EN 62020	All poles	RD2	3/78
	IEC/EN 60947-2 Ann. M	All poles	RD3	3/79
Up to 32 A		1P+N	DS201 L	3/30
Up to 32 A		2P	DS202C, DS202C M	3/42, 3/44
Up to 40 A		1P+N	DS201, DS201 M	3/32, 3/36
	Voltage dependent	1P+N	DS 271	3/76
Up to 63 A		All poles	DS 200	3/48
Up to 63 A		All poles	DS 200 M	3/53
Up to 100 A		All poles	DDA800 + S800C	3/74 + 2/106
Up to 125 A		All poles	DS800N	3/68
Up to 125 A		All poles	DS800S	3/68
Up to 63 A	RCD: IEC/EN 61009 Ann. G	All poles	DDA 200 + S200	3/20 + 2/12
Up to 100 A	RCD: IEC/EN 60947-2 Ann. B	All poles	DDA 800 + S800	3/62 + 2/82

RCCB F 200. The details make the difference

A range designed to ensure efficiency and protection

3

Test pushbutton to verify the correct functioning of the device.

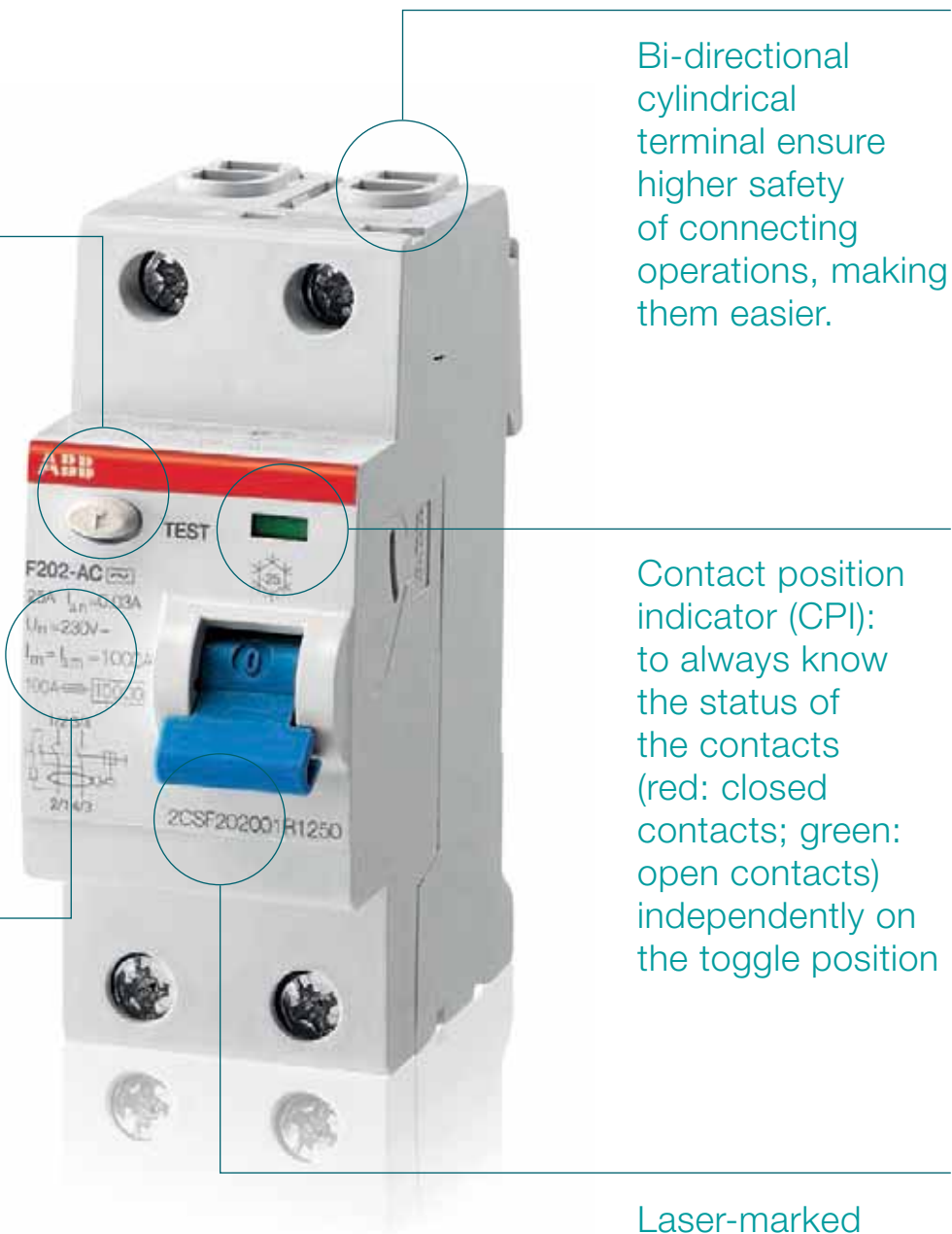

Bi-directional cylindrical terminal ensure higher safety of connecting operations, making them easier.

Contact position indicator (CPI): to always know the status of the contacts (red: closed contacts; green: open contacts) independently on the toggle position

Information on the device are laser printed to make them clearly visible and long lasting.

Laser-marked order code on the front to make easier future orders.



Two terminals are available, the fore one for cables up to 25 mm², the back one for cables up to 10 mm² or for busbars.



RCCBs F200 can be used in ambient conditions where the temperature of the surrounding atmosphere has values between -25°C (snowflake laser printed on the front of the device) and +55°C.



3

The availability of two terminals offers different connection solutions thanks to the possibility to connect two independent cables in the same device: the second terminal can be used for an auxiliary circuit or for the supply of devices with small section cables without connecting them together with the main circuit.



All the safety ensured by the international marks: approvals' marking in a visible area, even if RCDs is installed and with the panel-door closed.

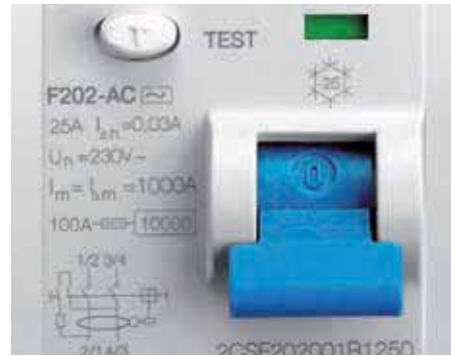

High performances:

- rated breaking capacity and rated residual breaking capacity laser printed on the device: $I_m = I_{\Delta m} = 1000 \text{ A}$
- coordination with a 100 A rated current SCPD (short-circuit protective device) = 10000 A.



The F 202 can be coupled with the autoreclosing unit F2C-ARH in order to ensure continuity of service for the whole installation of your home avo ding lack of supply.

RCCBs

F200 technical features



2CSC400002D0211

3

		Standards	
Electrical features	Type (wave form of the earth leakage sensed)		
	Poles		
	Rated current I _n		A
	Rated sensitivity I _{Δn}		A
	Rated voltage U _e	IEC	V
		UL/CSA	V
	Insulation voltage U _i		V
	Max. operating voltage of circuit test	IEC	V
		UL/CSA	V
	Min. operating voltage of circuit test		V
	Rated frequency		Hz
	Rated conditional short-circuit current I _{nc} =I _{Δn} ②	SCPD - fuse gG 100 A	kA
	Rated residual breaking capacity I _{Δm} =I _m		kA
	Rated impulse withstand voltage (1.2/50) U _{imp}		kV
	Dielectric test voltage at ind. freq. for 1 min.		kV
Overvoltage category			
Surge current resistance (wave 8/20)		A	
Mechanical features	Toggle		
	Contact position indicator (CPI)		
	Electrical life		
	Mechanical life		
	Protection degree	housing	
		terminals	
	Environmental conditions (damp heat) acc. to IEC/EN 60068-2-30		°C/RH
Ambient temperature (with daily average ≤ +35 °C)	IEC	°C	
Storage temperature		°C	
Installation	Terminal type		
	Terminal size top/bottom for cable	IEC	mm ²
		UL/CSA	AWG
	Terminal size top/bottom for busbar	IEC	mm ²
		UL/CSA	AWG
	Tightening torque	IEC	Nm
		UL/CSA	in-lbs.
	Tool		
	Mounting		
	Connection		
Withdrawal from busbar			
Dimensions and weight	Dimensions (H x D x W)	2P	mm
		4P	mm
	Weight	2P	g
		4P	g
Combination with auxiliary elements	Combinable with:	auxiliary contact	
		signal contact/auxiliary switch	
		shunt trip	
		undervoltage release	

① Ground-fault sensing and relaying equipment-component (up to 63 A)

② prior to connection of aluminium conductors (≥ 4 mm²) ensure that their contact points are cleaned, brushed and coated with grease

③ for S700-E/K 100A, S750-E 63A, S750DR-E/K 63A and other SCPD coordination values see p. 10/132

④ F200 left neutral has not the UL certification and the UL mark

F200 AC	F200 A	F200 A AP-R	F200 A S	F200 A 400 Hz	F200 A 16 2/3 Hz
IEC/EN 61008, UL 1053 ①					
AC	A	A	A	A	A
2P, 4P (for 125 A only 4P)					
16, 25, 40, 63, 80, 100, 125		25, 40, 63, 80, 100, 125	40, 63, 80, 100, 125	25, 40	63
0.01-0.03-0.1-0.3-0.5		0.03	0.1-0.3-0.5-1	0.03	0.03-0.3-0.5
230/400 - 240/415					
480V/277 (up to 100 A)					
500				-	-
254 (440 for 125 A); 440 for F 200 left neutral				254	254
277 (up to 100 A); 480 for F 200 left neutral ②				-	-
110 (185 for 125 A); 195 for F 200 left neutral				110	110
50...60				50...400	16 2/3
10 (for 125 A fuse is gG 125 A)					
1 (1.25 for 125 A)					
4					
2.5					
III, disconnecter abilities					
250		3000	5000	250	250
blue sealable in ON-OFF position					
yes					
10000 (2000 for 125 A)				10000	10000
20000 (5000 for 125 A)				20000	20000
IP4X					
IP2X					
28 cycles with 55°C/90-96% and 25°C/95-100%					
-25...+55 (-25...+40 for 125 A)				-25...+55	-25...+55
-40...+70					
failsafe bi-directional cylinder-lift terminal at top and bottom (shock protected) (cage for In > 63 A) ②					
25/25 (35/35 single slot terminal for In > 63 A)				25/25	25/25
18-4 (up to 63 A)				-	-
10/10 (not for In = 80-100 A)				10/10	10/10
18-8 (up to 63 A)				-	-
2.8 (3 for In = 125 A)				2.8	2.8
25 (up to 63 A)				-	-
Nr. 2 Pozidriv					
on DIN rail EN 60715 (35 mm) by means of fast clip device					
from top and bottom					
it is possible without using any tools only from the bottom (not for 125 A)					
85 x 69 x 35				-	-
85 x 69 x 70 (85 x 69.5 x 72 for 125 A)				85 x 69 x 70	85 x 69 x 70
200				-	-
350 (380 for In = 80 and 100 A and 460 for In = 125A)				350	350
yes (no for 125 A)				yes	yes
yes				yes	yes
yes (no for 125 A)				yes	yes
yes (no for 125 A)				yes	yes

3

RCCBs

F 200 series AC type



2CSC40004B0201

F 200 AC type

Function: protection against the effects of sinusoidal alternating earth fault currents; protection against indirect contacts and additional protection against direct contacts (with $I_{\Delta n}=30$ mA).

Application: residential, commercial, industrial.

Standard: IEC/EN 61008

Marking: according to EN 61008

Number of poles	Rated residual current $I_{\Delta n}$ mA	Rated current In A	Bbn 8012542 EAN	Order details		Price 1 piece	Weight 1 piece kg	Pack unit pc.	
				Type code	Order code				
2	10	16	779902	F202 AC-16/0.01	2CSF202001R0160		0.225	1/6	
		30	25	780007	F202 AC-25/0.03	2CSF202001R1250		0.225	1/6
			40	780106	F202 AC-40/0.03	2CSF202001R1400		0.225	1/6
			63	780205	F202 AC-63/0.03	2CSF202001R1630		0.225	1/6
			80	914204	F202 AC-80/0.03	2CSF202001R1800		0.225	1/6
			100	914303	F202 AC-100/0.03	2CSF202001R1900		0.225	1/6
	100	25	780304	F202 AC-25/0.1	2CSF202001R2250		0.225	1/6	
		40	780403	F202 AC-40/0.1	2CSF202001R2400		0.225	1/6	
		63	780502	F202 AC-63/0.1	2CSF202001R2630		0.225	1/6	
		80	914402	F202 AC-80/0.1	2CSF202001R2800		0.225	1/6	
		100	914501	F202 AC-100/0.1	2CSF202001R2900		0.225	1/6	
	300	25	780601	F202 AC-25/0.3	2CSF202001R3250		0.225	1/6	
		40	780700	F202 AC-40/0.3	2CSF202001R3400		0.225	1/6	
		63	780809	F202 AC-63/0.3	2CSF202001R3630		0.225	1/6	
		80	914600	F202 AC-80/0.3	2CSF202001R3800		0.225	1/6	
		100	914709	F202 AC-100/0.3	2CSF202001R3900		0.225	1/6	
	500	25	780908	F202 AC-25/0.5	2CSF202001R4250		0.225	1/6	
		40	781004	F202 AC-40/0.5	2CSF202001R4400		0.225	1/6	
		63	781103	F202 AC-63/0.5	2CSF202001R4630		0.225	1/6	
		80	914808	F202 AC-80/0.5	2CSF202001R4800		0.225	1/6	
100		914907	F202 AC-100/0.5	2CSF202001R4900		0.225	1/6		

Where to find more:

Coordination Tables for F 200 RCCBs p.10/132
Worldwide Marks and Approvals p.11/92
Technical guide of RCDs (code 2CSC420004B0201)



Frequently asked question - FAQ:

A complete list of answers is available in the RCDs FAQ document (code 2CSC420005B0201)



Maybe you are also interested in:

Auxiliary Elements for RCDs p.4/4
Accessories for RCDs p.4/16
Busbar Systems p.4/21



F204

2CSC400197R201



F204 125 A

2CSC400197R201

Number of poles	Rated residual current I _{Δn} mA	Rated current In A	Bbn 8012542 EAN	Order details		Price 1 piece	Weight 1 piece kg	Pack unit pc.
				Type code	Order code			
4	30	25	781202	F204 AC-25/0.03	2CSF204001R1250		0.375	1/3
		40	781301	F204 AC-40/0.03	2CSF204001R1400		0.375	1/3
		63	781400	F204 AC-63/0.03	2CSF204001R1630		0.375	1/3
		80	916604	F204 AC-80/0.03	2CSF204001R1800		0.405	1/3
		100	916703	F204 AC-100/0.03	2CSF204001R1900		0.405	1/3
		125	941507	F204 AC-125/0.03	2CSF204001R1950		0.500	1
	100	25	781509	F204 AC-25/0.1	2CSF204001R2250		0.375	1/3
		40	781608	F204 AC-40/0.1	2CSF204001R2400		0.375	1/3
		63	781707	F204 AC-63/0.1	2CSF204001R2630		0.375	1/3
		80	916802	F204 AC-80/0.1	2CSF204001R2800		0.405	1/3
		100	916901	F204 AC-100/0.1	2CSF204001R2900		0.405	1/3
		125	941606	F204 AC-125/0.1	2CSF204001R2950		0.500	1
	300	25	781806	F204 AC-25/0.3	2CSF204001R3250		0.375	1/3
		40	781905	F204 AC-40/0.3	2CSF204001R3400		0.375	1/3
		63	782001	F204 AC-63/0.3	2CSF204001R3630		0.375	1/3
		80	917007	F204 AC-80/0.3	2CSF204001R3800		0.405	1/3
		100	917106	F204 AC-100/0.3	2CSF204001R3900		0.405	1/3
		125	941705	F204 AC-125/0.3	2CSF204001R3950		0.500	1
500	25	782100	F204 AC-25/0.5	2CSF204001R4250		0.375	1/3	
	40	782209	F204 AC-40/0.5	2CSF204001R4400		0.375	1/3	
	63	782308	F204 AC-63/0.5	2CSF204001R4630		0.375	1/3	
	80	917205	F204 AC-80/0.5	2CSF204001R4800		0.405	1/3	
	100	917304	F204 AC-100/0.5	2CSF204001R4900		0.405	1/3	
	125	941804	F204 AC-125/0.5	2CSF204001R4950		0.500	1	

3

RCCBs

F 200 series AC type, for overseas markets



F202



F204

F 200 AC type (for overseas markets)

Function: protection against the effects of sinusoidal alternating earth fault currents; protection against indirect contacts and additional protection against direct contacts (with $I_{\Delta n}=30$ mA).

Application: residential, commercial, industrial.

Standard: IEC/EN 61008

Marking: according to IEC 61008

Number of poles	Rated residual current $I_{\Delta n}$ mA	Rated current In A	Bbn 8012542 EAN	Order details		Price 1 piece	Weight 1 piece kg	Pack unit pc.	
				Type code	Order code				
2	10	16	814603	F202 AC-16/0.01	2CSF202005R0160		0.225	1/6	
		30	25	814702	F202 AC-25/0.03	2CSF202005R1250		0.225	1/6
			40	814801	F202 AC-40/0.03	2CSF202005R1400		0.225	1/6
			63	814900	F202 AC-63/0.03	2CSF202005R1630		0.225	1/6
			80	935902	F202 AC-80/0.03	2CSF202005R1800		0.225	1/6
	100	936008	F202 AC-100/0.03	2CSF202005R1900		0.225	1/6		
	100	25	815006	F202 AC-25/0.1	2CSF202005R2250		0.225	1/6	
			40	815105	F202 AC-40/0.1	2CSF202005R2400		0.225	1/6
			63	815204	F202 AC-63/0.1	2CSF202005R2630		0.225	1/6
			80	936107	F202 AC-80/0.1	2CSF202005R2800		0.225	1/6
			100	936206	F202 AC-100/0.1	2CSF202005R2900		0.225	1/6
	300	25	815303	F202 AC-25/0.3	2CSF202005R3250		0.225	1/6	
			40	815402	F202 AC-40/0.3	2CSF202005R3400		0.225	1/6
			63	815501	F202 AC-63/0.3	2CSF202005R3630		0.225	1/6
80			936305	F202 AC-80/0.3	2CSF202005R3800		0.225	1/6	
100			936404	F202 AC-100/0.3	2CSF202005R3900		0.225	1/6	
500	80	936503	F202 AC-80/0.5	2CSF202005R4800		0.225	1/6		
		100	936602	F202 AC-100/0.5	2CSF202005R4900		0.225	1/6	

Number of poles	Rated residual current $I_{\Delta n}$ mA	Rated current In A	Bbn 8012542 EAN	Order details		Price 1 piece	Weight 1 piece kg	Pack unit pc.	
				Type code	Order code				
4	30	25	817109	F204 AC-25/0.03	2CSF204005R1250		0.375	1/3	
		40	817208	F204 AC-40/0.03	2CSF204005R1400		0.375	1/3	
			63	817307	F204 AC-63/0.03	2CSF204005R1630		0.375	1/3
			80	936701	F204 AC-80/0.03	2CSF204005R1800		0.405	1/3
			100	936800	F204 AC-100/0.03	2CSF204005R1900		0.405	1/3
	100	25	817406	F204 AC-25/0.1	2CSF204005R2250		0.375	1/3	
			40	817505	F204 AC-40/0.1	2CSF204005R2400		0.375	1/3
			63	817604	F204 AC-63/0.1	2CSF204005R2630		0.375	1/3
			80	936909	F204 AC-80/0.1	2CSF204005R2800		0.405	1/3
			100	937005	F204 AC-100/0.1	2CSF204005R2900		0.405	1/3
	300	25	817703	F204 AC-25/0.3	2CSF204005R3250		0.375	1/3	
			40	817802	F204 AC-40/0.3	2CSF204005R3400		0.375	1/3
			63	817901	F204 AC-63/0.3	2CSF204005R3630		0.375	1/3
			80	937104	F204 AC-80/0.3	2CSF204005R3800		0.405	1/3
			100	937203	F204 AC-100/0.3	2CSF204005R3900		0.405	1/3
	500	80	937302	F204 AC-80/0.5	2CSF204005R4800		0.405	1/3	
			100	937401	F204 AC-100/0.5	2CSF204005R4900		0.405	1/3

Where to find more:

Coordination Tables for F 200 RCCBs p.10/132
Worldwide Marks and Approvals p.11/92
Technical guide of RCDs (code 2CSC420004B0201)



Frequently asked question - FAQ:

A complete list of answers is available in the RCDs FAQ document (code 2CSC420005B0201)



Maybe you are also interested in:

Auxiliary Elements for RCDs p.4/4
Accessories for RCDs p.4/16
Busbar Systems p.4/21

RCCBs

F 200 series AC type left neutral



F204 left neutral



F204 left neutral 125 A

F 200 AC type with neutral pole on the left

Function: protection against the effects of sinusoidal alternating earth fault currents; protection against indirect contacts and additional protection against direct contacts (with $I_n=30$ mA). Product helpful where for installation habits, for wiring with busbars or cables, for special needs neutral on the left is needed.

Application: residential, commercial, industrial.

Standard: IEC/EN 61008

Marking: according to EN 61008

3

Number of poles	Rated residual current in mA	Rated current In A	Bbn 8012542 EAN	Order details		Price 1 piece	Weight 1 piece kg	Pack unit pc.	
				Type code	Order code				
4	30	25	815907	F204 AC-25/0.03	2CSF204023R1250		0.375	1/3	
		40	816003	F204 AC-40/0.03	2CSF204023R1400		0.375	1/3	
		63	816102	F204 AC-63/0.03	2CSF204023R1630		0.375	1/3	
		80	917403	F204 AC-80/0.03	2CSF204023R1800		0.405	1/3	
		100	917502	F204 AC-100/0.03	2CSF204023R1900		0.405	1/3	
		125	975106	F204 AC-125/0.03	2CSF204023R1950		0.500	1	
	100	25	816201	F204 AC-25/0.1	2CSF204023R2250		0.375	1/3	
			40	816300	F204 AC-40/0.1	2CSF204023R2400		0.375	1/3
			63	816409	F204 AC-63/0.1	2CSF204023R2630		0.375	1/3
	300	25	816508	F204 AC-25/0.3	2CSF204023R3250		0.375	1/3	
			40	816607	F204 AC-40/0.3	2CSF204023R3400		0.375	1/3
			63	816706	F204 AC-63/0.3	2CSF204023R3630		0.375	1/3
80			917601	F204 AC-80/0.3	2CSF204023R3800		0.405	1/3	
100			917700	F204 AC-100/0.3	2CSF204023R3900		0.405	1/3	
125			975304	F204 AC-125/0.3	2CSF204023R3950		0.500	1	
500	25	816805	F204 AC-25/0.5	2CSF204023R4250		0.375	1/3		
		40	816904	F204 AC-40/0.5	2CSF204023R4400		0.375	1/3	
		63	817000	F204 AC-63/0.5	2CSF204023R4630		0.375	1/3	

RCCBs

F 200 series A type



2CSC40004B0201

3

F202

F 200 A type

Function: protection against the effects of sinusoidal alternating and direct pulsating earth fault currents; protection against indirect contacts and additional protection against direct contacts (with $I_{\Delta n}=30$ mA).

Application: residential, commercial, industrial.

Standard: IEC/EN 61008

Marking: according to EN 61008

Number of poles	Rated residual current $I_{\Delta n}$ mA	Rated current In A	Bbn 8012542 EAN	Order details		Price 1 piece	Weight 1 piece kg	Pack unit pc.	
				Type code	Order code				
2	10	16	782407	F202 A-16/0.01	2CSF202101R0160		0.225	1/6	
		30	25	782506	F202 A-25/0.03	2CSF202101R1250		0.225	1/6
			40	782605	F202 A-40/0.03	2CSF202101R1400		0.225	1/6
			63	782704	F202 A-63/0.03	2CSF202101R1630		0.225	1/6
			80	915201	F202 A-80/0.03	2CSF202101R1800		0.225	1/6
	100	915300	F202 A-100/0.03	2CSF202101R1900		0.225	1/6		
	100	25	786900	F202 A-25/0.1	2CSF202101R2250		0.225	1/6	
			40	787006	F202 A-40/0.1	2CSF202101R2400		0.225	1/6
			63	787105	F202 A-63/0.1	2CSF202101R2630		0.225	1/6
			80	915409	F202 A-80/0.1	2CSF202101R2800		0.225	1/6
			100	915508	F202 A-100/0.1	2CSF202101R2900		0.225	1/6
	300	25	782803	F202 A-25/0.3	2CSF202101R3250		0.225	1/6	
			40	782902	F202 A-40/0.3	2CSF202101R3400		0.225	1/6
			63	783008	F202 A-63/0.3	2CSF202101R3630		0.225	1/6
			80	915607	F202 A-80/0.3	2CSF202101R3800		0.225	1/6
			100	915706	F202 A-100/0.3	2CSF202101R3900		0.225	1/6
	500	25	783107	F202 A-25/0.5	2CSF202101R4250		0.225	1/6	
			40	783206	F202 A-40/0.5	2CSF202101R4400		0.225	1/6
			63	783305	F202 A-63/0.5	2CSF202101R4630		0.225	1/6
			80	915805	F202 A-80/0.5	2CSF202101R4800		0.225	1/6
100			915904	F202 A-100/0.5	2CSF202101R4900		0.225	1/6	

Where to find more:

Coordination Tables for F 200 RCCBs p.10/132
Worldwide Marks and Approvals p.11/92
Technical guide of RCDs (code 2CSC420004B0201)



Frequently asked question - FAQ:

A complete list of answers is available in the RCDs FAQ document (code 2CSC420005B0201)



Maybe you are also interested in:

Auxiliary Elements for RCDs p.4/4
Accessories for RCDs p.4/16
Busbar Systems p.4/21



F204

2CSC40068F0201



F204 125 A

2CSC400197F0201

Number of poles	Rated residual current I Δ n mA	Rated current In A	Bbn 8012542 EAN	Order details		Price 1 piece	Weight 1 piece kg	Pack unit pc.
				Type code	Order code			
4	30	25	783404	F204 A-25/0.03	2CSF204101R1250		0.375	1/3
		40	783503	F204 A-40/0.03	2CSF204101R1400		0.375	1/3
		63	783602	F204 A-63/0.03	2CSF204101R1630		0.375	1/3
		80	917809	F204 A-80/0.03	2CSF204101R1800		0.405	1/3
		100	917908	F204 A-100/0.03	2CSF204101R1900		0.405	1/3
		125	941903	F204 A-125/0.03	2CSF204101R1950		0.500	1
	100	25	787204	F204 A-25/0.1	2CSF204101R2250		0.375	1/3
		40	787303	F204 A-40/0.1	2CSF204101R2400		0.375	1/3
		63	787402	F204 A-63/0.1	2CSF204101R2630		0.375	1/3
		80	918004	F204 A-80/0.1	2CSF204101R2800		0.405	1/3
		100	918103	F204 A-100/0.1	2CSF204101R2900		0.405	1/3
		125	942009	F204 A-125/0.1	2CSF204101R2950		0.500	1
	300	25	783701	F204 A-25/0.3	2CSF204101R3250		0.375	1/3
		40	783800	F204 A-40/0.3	2CSF204101R3400		0.375	1/3
		63	783909	F204 A-63/0.3	2CSF204101R3630		0.375	1/3
		80	918202	F204 A-80/0.3	2CSF204101R3800		0.405	1/3
		100	918301	F204 A-100/0.3	2CSF204101R3900		0.405	1/3
		125	942108	F204 A-125/0.3	2CSF204101R3950		0.500	1
500	25	784005	F204 A-25/0.5	2CSF204101R4250		0.375	1/3	
	40	784104	F204 A-40/0.5	2CSF204101R4400		0.375	1/3	
	63	784203	F204 A-63/0.5	2CSF204101R4630		0.375	1/3	
	80	918400	F204 A-80/0.5	2CSF204101R4800		0.405	1/3	
	100	918509	F204 A-100/0.5	2CSF204101R4900		0.405	1/3	
	125	942207	F204 A-125/0.5	2CSF204101R4950		0.500	1	

3

RCCBs

F 200 series A type left neutral



F204 left neutral



F204 left neutral 125 A

F 200 A type with neutral pole on the left

Function: protection against the effects of sinusoidal alternating and direct pulsating earth fault currents; protection against indirect contacts and additional protection against direct contacts (with $I_{\Delta n}=30$ mA). Product helpful where for installation habits, for wiring with busbars or cables, for special needs neutral on the left is needed.

Application: residential, commercial, industrial.

Standard: IEC/EN 61008

Marking: according to EN 61008

Number of poles	Rated residual current $I_{\Delta n}$ mA	Rated current In A	Bbn 8012542 EAN	Order details		Price 1 piece	Weight 1 piece kg	Pack unit pc.
				Type code	Order code			
4	30	25	820109	F204 A-25/0.03	2CSF204123R1250		0.375	1/3
		40	820208	F204 A-40/0.03	2CSF204123R1400		0.375	1/3
		63	820307	F204 A-63/0.03	2CSF204123R1630		0.375	1/3
		80	918608	F204 A-80/0.03	2CSF204123R1800		0.405	1/3
		100	918707	F204 A-100/0.03	2CSF204123R1900		0.405	1/3
		125	967705	F204 A-125/0.03	2CSF204123R1950		0.500	1
	100	25	820406	F204 A-25/0.1	2CSF204123R2250		0.375	1/3
		40	820505	F204 A-40/0.1	2CSF204123R2400		0.375	1/3
		63	820604	F204 A-63/0.1	2CSF204123R2630		0.375	1/3
	300	25	820703	F204 A-25/0.3	2CSF204123R3250		0.375	1/3
		40	820802	F204 A-40/0.3	2CSF204123R3400		0.375	1/3
		63	820901	F204 A-63/0.3	2CSF204123R3630		0.375	1/3
80		918806	F204 A-80/0.3	2CSF204123R3800		0.405	1/3	
100		918905	F204 A-100/0.3	2CSF204123R3900		0.405	1/3	
125		967804	F204 A-125/0.3	2CSF204123R3950		0.500	1	
500	25	821007	F204 A-25/0.5	2CSF204123R4250		0.375	1/3	
	40	821106	F204 A-40/0.5	2CSF204123R4400		0.375	1/3	
	63	821205	F204 A-63/0.5	2CSF204123R4630		0.375	1/3	

Where to find more:

Coordination Tables for F 200 RCCBs p.10/132
Worldwide Marks and Approvals p.11/92
Technical guide of RCDs (code 2CSC420004B0201)



Frequently asked question - FAQ:

A complete list of answers is available in the RCDs FAQ document (code 2CSC420005B0201)



Maybe you are also interested in:

Auxiliary Elements for RCDs p.4/4
Accessories for RCDs p.4/16
Busbar Systems p.4/21

RCCBs

F 200 series A type, AP-R (high immunity)



F202



F204



F204 125 A

F 200 AP-R, A type

Function: protection against the effects of sinusoidal alternating and direct pulsating earth fault currents, providing the best compromise between safety and continuity in the service thanks to the resistance to unwanted trippings; protection against indirect contacts and additional protection against direct contacts ($I_{\Delta n}=30$ mA).

Application: residential, commercial, industrial.

Standard: IEC/EN 61008

Surge current resistance (wave 8/20)=3000 A

Marking: according to EN 61008

3

Number of poles	Rated residual current $I_{\Delta n}$ mA	Rated current I_n A	Bbn 8012542 EAN	Order details		Price 1 piece	Weight 1 piece kg	Pack unit pc.
				Type code	Order code			
2	30	25	785101	F202 A-25/0.03 AP-R	2CSF202401R1250		0.225	1/6
		40	785200	F202 A-40/0.03 AP-R	2CSF202401R1400		0.225	1/6
		63	785309	F202 A-63/0.03 AP-R	2CSF202401R1630		0.225	1/6
		80	916406	F202 A-80/0.03 AP-R	2CSF202401R1800		0.225	1/6
		100	916505	F202 A-100/0.03 AP-R	2CSF202401R1900		0.225	1/6

Number of poles	Rated residual current $I_{\Delta n}$ mA	Rated current I_n A	Bbn 8012542 EAN	Order details		Price 1 piece	Weight 1 piece kg	Pack unit pc.
				Type code	Order code			
4	30	25	785408	F204 A-25/0.03 AP-R	2CSF204401R1250		0.375	1/3
		40	785507	F204 A-40/0.03 AP-R	2CSF204401R1400		0.375	1/3
		63	785606	F204 A-63/0.03 AP-R	2CSF204401R1630		0.375	1/3
		80	919407	F204 A-80/0.03 AP-R	2CSF204401R1800		0.405	1/3
		100	919506	F204 A-100/0.03 AP-R	2CSF204401R1900		0.405	1/3
		125	967903	F204 A-125/0.03 AP-R	2CSF204401R1950		0.500	1

RCCBs

F 200 series A type, selective



F202

F 200 A selective type

Function: protection against the effects of sinusoidal alternating and direct pulsating earth fault currents with an intentional tripping delay, which permits to realize the selectivity with downstream instantaneous devices (for more information about selectivity see the technical guide); protection against indirect contacts.

Application: commercial, industrial.

Standard: IEC/EN 61008

Surge current resistance (wave 8/20)=5000 A

Marking: according to EN 61008

Number of poles	Rated residual current $I_{\Delta n}$ mA	Rated current In A	Bbn 8012542 EAN	Order details		Price 1 piece	Weight 1 piece kg	Pack unit pc.
				Type code	Order code			
2	100	40	822905	F202 A S-40/0.1	2CSF202201R2400	0.225	1/6	
		63	823001	F202 A S-63/0.1	2CSF202201R2630	0.225	1/6	
		100	916000	F202 A S-100/0.1	2CSF202201R2900	0.225	1/6	
	300	40	784302	F202 A S-40/0.3	2CSF202201R3400	0.225	1/6	
		63	784401	F202 A S-63/0.3	2CSF202201R3630	0.225	1/6	
		100	916109	F202 A S-100/0.3	2CSF202201R3900	0.225	1/6	
	500	40	784500	F202 A S-40/0.5	2CSF202201R4400	0.225	1/6	
		63	784609	F202 A S-63/0.5	2CSF202201R4630	0.225	1/6	
		100	916208	F202 A S-100/0.5	2CSF202201R4900	0.225	1/6	
	1000	40	823100	F202 A S-40/1	2CSF202201R5400	0.225	1/6	
		63	823209	F202 A S-63/1	2CSF202201R5630	0.225	1/6	
		100	916307	F202 A S-100/1	2CSF202201R5900	0.225	1/6	



F204

Number of poles	Rated residual current $I_{\Delta n}$ mA	Rated current In A	Bbn 8012542 EAN	Order details		Price 1 piece	Weight 1 piece kg	Pack unit pc.
				Type code	Order code			
4	100	40	823308	F204 A S-40/0.1	2CSF204201R2400	0.375	1/3	
		63	823407	F204 A S-63/0.1	2CSF204201R2630	0.375	1/3	
		100	919001	F204 A S-100/0.1	2CSF204201R2900	0.405	1/3	
	300	40	784708	F204 A S-40/0.3	2CSF204201R3400	0.375	1/3	
		63	784807	F204 A S-63/0.3	2CSF204201R3630	0.375	1/3	
		100	919100	F204 A S-100/0.3	2CSF204201R3900	0.405	1/3	
	125	968207	F204 A S-125/0.3	2CSF204201R3950	0.500	1		
		500	40	784906	F204 A S-40/0.5	2CSF204201R4400	0.375	1/3
			63	785002	F204 A S-63/0.5	2CSF204201R4630	0.375	1/3
	100		919209	F204 A S-100/0.5	2CSF204201R4900	0.405	1/3	
	125	968405	F204 A S-125/0.5	2CSF204201R4950	0.500	1		
		1000	40	823506	F204 A S-40/1	2CSF204201R5400	0.375	1/3
			63	823605	F204 A S-63/1	2CSF204201R5630	0.375	1/3
	100		919308	F204 A S-100/1	2CSF204201R5900	0.405	1/3	



F204 125 A

Where to find more:

Coordination Tables for F 200 RCCBs p.10/132
Worldwide Marks and Approvals p.11/92
Technical guide of RCDs (code 2CSC420004B0201)



Frequently asked question - FAQ:

A complete list of answers is available in the RCDs FAQ document (code 2CSC420005B0201)



Maybe you are also interested in:

Auxiliary Elements for RCDs p.4/4
Accessories for RCDs p.4/16
Busbar Systems p.4/21

RCCBs

F 200 series A type for high frequency and railways applications



F202



F204

F 200 A type for high frequency (400 Hz)

Function: protection against the effects of sinusoidal alternating and direct pulsating earth fault currents; protection against indirect contacts and additional protection against direct (with $I_{\Delta n}=30$ mA) contacts.

Advantages: increasing the frequency generates an increase of the magnetic reluctance of the toroidal transformer of standard RCCB and what follows is the value of the increasing operating residual current at 400 Hz reaching values 3 or more times higher than those of the residual current at 50Hz. The RCCB F 200 400 Hz guarantees protection against indirect contacts and additional protection against direct contacts (with $I_{\Delta n}=30$ mA) considering that the operating residual current doesn't increase with the increase of the network frequency.

Application: commercial, industrial.

Standard: IEC/EN 61008

Marking: according to EN 61008

3

Number of poles	Rated residual current $I_{\Delta n}$ mA	Rated current In A	Bbn 8012542 EAN	Order details		Price 1 piece	Weight 1 piece kg	Pack unit pc.
				Type code	Order code			
4	30	25	968603	F204 A-25/0.03 400Hz	2CSF204197R1250		0.375	1/3
		40	968702	F204 A-40/0.03 400Hz	2CSF204197R1400			

F200 A type 16 2/3 Hz

Function: protection against the effects of sinusoidal alternating and direct pulsating earth fault currents; protection against indirect contacts and additional protection against direct contacts (with $I_{\Delta n}=30$ mA).

The RCCB F200 16 2/3 Hz can work at rated frequency of 16 2/3 Hz which is common in railways applications

Application: railways

Standard: IEC/ EN 61008

Marking: according to EN 61008

Number of poles	Rated residual current $I_{\Delta n}$ mA	Rated current In A	Bbn 8012542 EAN	Order details		Price 1 piece	Weight 1 piece kg	Pack unit pc.
				Type code	Order code			
2	30	63	734536	F202 A-63/0.03 16-2/3Hz	2CSF202196R1630		0.225	1/6
		300	733638	F202 A-63/0.3 16-2/3Hz	2CSF202196R3630			
		500	734437	F202 A-63/0.5 16-2/3Hz	2CSF202196R4630			
Number of poles	Rated residual current $I_{\Delta n}$ mA	Rated current In A	Bbn 8012542 EAN	Order details		Price 1 piece	Weight 1 piece kg	Pack unit pc.
				Type code	Order code			
4	30	63	733539	F204 A-63/0.03 16-2/3Hz	2CSF204196R1630		0.375	1/3
		300	734338	F204 A-63/0.3 16-2/3Hz	2CSF204196R3630			
		500	733430	F204 A-63/0.5 16-2/3Hz	2CSF204196R4630			

RCCBs

F 200 series - B type for continuous, selective continuous type fault currents technical features



2CSC4000197F001

3

F200

Technical features	F 200 B type			
Type (wave form of the detected dispersion current)		B		
Rated current I _n	[A]	40	63	125
No. of poles		4		
Rated voltage U _n	[V]	230/400		
Working range of test circuit	[V]	185 V AC-440 V AC		
Rated conditional short-circuit current I _{nc}	[kA]	10		
Rated conditional residual short-circuit current I _{Δc}	[kA]	10		
Rated making and breaking capacity I _m	[A]	500	800	1250
Rated residual making and breaking capacity I _{Δm}	[A]	500	800	1250
Surge current resistance		ring wave 0,5 ms/100 kHz: 200 A, impulse 8/20 μs: 3 kA (impulse 8/20 μs: 5 kA for F200 type B S - selective)		
Rated sensitivity I _{Δn}	[A]	0.03	0.03-0.3	0.03-0.3-0.5
Working frequency range	[Hz]	0-1000		
Min. operating voltage				
for detecting type A/AC residual currents	[V]	0 V		
for detecting type B residual currents	[V]	30 V a.c.		
Own consumption	[W]	max. 3.5		
Dissipated power P _v	[W]	2.9	7.2	28
Short-circuit fuse acc. to VDE 0636/IEC 60269-1		80 A/gL	100 A/gG	125 A/gL
Tripping time F200 type B	[ms]	1 x I _{Δn} ≤ 300 ms; 5 x I _{Δn} ≤ 40 ms		
Tripping time F200 type B S	[ms]	1 x I _{Δn} > 130 ms ≤ 500 ms; 5 x I _{Δn} > 50 ms ≤ 150 ms		
Toggle		Blue sealable in ON/OFF position		
Impact resistance		20 g/20 ms		
Protection degree		IP40 (after installation in distribution board)		
Supply		terminal 1, 3, 5, 7		
Ambient temperature	[°C]	-25...+40		
Resistance to climate changes acc. to IEC 68-2-30		25 °C/55 °C; 93%/97% relative humidity, 28 cycles		
Cables max. size	[mm ²]	1x1.5-50 mm ² ; 2x1.5-16 mm ²		
Terminal size	[mm ²]	50		
Tightening torque	[Nm]	3		
Mechanical life		> 5000		
Electrical life		> 2000		
Electromagnetic compatibility		IEC 61453; DIN VDE 0664 Pt.30		
Mounting		on DIN rail EN 60715 (35 mm) by means of fast clip device		
Dimensions (H x P x L)	[mm]	85 x 69,5 x 70		
Weight 4P	[g]	500		

Where to find more:

Coordination Tables for F 200 RCCBs
p.10/132
Worldwide Marks and Approvals
p.11/92
Technical guide of RCDs (code
2CSC420004B0201)



Frequently asked question - FAQ:

A complete list of answers is available
in the RCDs FAQ document (code
2CSC420005B0201)



Maybe you are also interested in:

Auxiliary Elements for RCDs p.4/4
Accessories for RCDs p.4/16
Busbar Systems p.4/21

RCCBs

F 200 series B type, B type selective



F204

F 200 B type for smooth DC earth fault current

Function: protection against the effects of sinusoidal alternating, direct pulsating and pulsating DC or smooth DC earth fault currents; protection against indirect contacts and additional protection against direct contacts (with $I_{\Delta n}=30$ mA).

Application: industrial.

Standard: IEC/EN 61008, IEC 62423

Marking: according to EN 61008

3

Number of poles	Rated residual current $I_{\Delta n}$ mA	Rated current I_n A	Bbn 8012542 EAN	Order details		Price 1 piece	Weight 1 piece kg	Pack unit pc.
				Type code	Order code			
4	30	40	988403	F204 B-40/0.03	2CSF204501R1400		0.500	1
		63	988502	F204 B-63/0.03	2CSF204501R1630		0.500	1
		125 [Ⓛ]	988700	F204 B-125/0.03	2CSF204523R1950		0.500	1
	300	63	989004	F204 B-63/0.3	2CSF204501R3630		0.500	1
		125 [Ⓛ]	989202	F204 B-125/0.3	2CSF204523R3950		0.500	1
	500	125 [Ⓛ]	730439	F204 B-125/0.5	2CSF204523R4950		0.500	1

[Ⓛ] Devices with rated current $I_n=125$ A are with neutral on the left



F204

F 200 B selective type for smooth DC earth fault current

Function: protection against the effects of sinusoidal alternating, direct pulsating and pulsating DC or smooth DC earth fault currents with an intentional tripping delay, which permits to realize the selectivity with downstream instantaneous devices (for more information about selectivity see the technical guide); protection against indirect contacts.

Application: industrial.

Standard: IEC/EN 61008, IEC 62423

Surge current resistance (wave 8/20)=5000 A

Marking: according to EN 61008

Number of poles	Rated residual current $I_{\Delta n}$ mA	Rated current I_n A	Bbn 8012542 EAN	Order details		Price 1 piece	Weight 1 piece kg	Pack unit pc.
				Type code	Order code			
4	300	63	989301	F204 B S-63/0.3	2CSF204801R3630		0.500	1
		125 [Ⓛ]	989509	F204 B S-125/0.3	2CSF204823R3950		0.500	1
	500	125 [Ⓛ]	731238	F204 B S-125/0.5	2CSF204823R4950		0.500	1

[Ⓛ] Devices with rated current $I_n=125$ A are with neutral on the left

RCCBs

F 200 series PV B type technical features



2CSC40002D0211

3

F200 PV B

	F 200 PV B	
Rated current I _n	25A	63 A
Rated sensitivity I _{Δn}	0.03 - 0.3 A	
Working frequency range	0 - 1000 Hz	
Rated voltage U _n	230 V AC	
Rated frequency	50 Hz	
Min. operating voltage		
for detecting type A/AC residual currents	0 V (mains voltage-independent)	
for detecting type B residual currents	30 V AC	
Own consumption	max. 1.2 W	
Working range of test circuit	100 V AC – 250 V AC	
No. of poles:	2-pole	
Dissipated power P _v	1.2 W	7.2 W
Short-circuit fuse to VDE 0636 / IEC 60269-1	100 A/gG	
Tripping times F200PV B type	1xI _{Δn} ≤ 300 ms; 5xI _{Δn} ≤ 40 ms	
Rated making and breaking capacity I _m	500 A	800 A
Rated residual making and breaking capacity I _{Δm}	500 A	800 A
Rated short circuit current I _{nc}	10 kA	
Rated conditional residual short-circuit current I _{Δc}	10 kA	
Surge current resistance	Ring wave 0.5 ms / 100 kHz: 200 A, impulse 8/20 μs: 3 kA	
Impact resistance	20 g / 20 ms duration	
Enclosure protection type	IP40 (after installation in distribution board)	
Input side	Terminals 5, 7	
Ambient temperature	-25°C to 40°C	
Resistance to climate changes according to IEC 68-2-30	damp / heat cyclic (25°C / 55°C; 93% / 97% rel.hum., 28 cycles)	
Cables max. size	1x1.5-50 mm ² (1-wire connect.); 2x1.5-16 mm ² (2-wire connect.)	
Tightening torque of fastening screws	3 Nm	
Mechanical life	> 5000 switching cycles	
Electrical life	> 2000 switching cycles	
Electromagnetic compatibility	IEC 61453; DIN VDE 0664 Pt.30 (interference resistance-industrial environment)	
Mounting	On DIN rail EN 60715 (35 mm) by means of fast clip device; any mounting position	
Toggle	Blue sealable in ON/OFF position.	
Dimensions (H x D x W)	85 x 69 x 72 mm	
Weight	500 g	

Where to find more:

Coordination Tables for F 200 RCCBs
p.10/132
Worldwide Marks and Approvals
p.11/92
Technical guide of RCDs (code
2CSC420004B0201)



Frequently asked question - FAQ:

A complete list of answers is available
in the RCDs FAQ document (code
2CSC420005B0201)



Maybe you are also interested in:

Auxiliary Elements for RCDs p.4/4
Accessories for RCDs p.4/16
Busbar Systems p.4/21

RCCBs

F 200 series PV B type



F202 PV B

F200 PV B type for smooth DC earth fault current for photovoltaic applications

Function: protection against the effects of sinusoidal alternating, direct pulsating and pulsating DC or smooth DC earth fault currents; protection against indirect contacts and additional protection against direct contacts (with $I_{\Delta n}=30\text{mA}$).

Where an electrical installation includes a PV power supply system without at least simple separation between the AC side and the DC side, an RCD installed to provide fault protection by automatic disconnection of supply should be type B according to IEC 60755, amendment 2 (according to IEC 60364-7 art. 712.413.1.1.1.2)

Application: particularly suitable for use in solar energy (photovoltaic) systems

standard: IEC/EN 61008, IEC 62423

Marking: according to EN 61008

3

Number of poles	Rated residual current $I_{\Delta n}$ mA	Rated current In A	Bbn 8012542 EAN	Order details		Price 1 piece	Weight 1 piece kg	Pack unit pc.
				Type code	Order code			
2	30	25	071235	F202PV B-25/0,03	2CSF202601R1250		0.500	1
		63	368632	F202PV B-63/0,03	2CSF202601R1630		0.500	1
	300	25	910831	F202PV B-25/0,3	2CSF202601R3250		0.500	1
		63	659037	F202PV B-63/0,3	2CSF202601R3630		0.500	1

RCD-blocks

DDA 200 technical features



2CSC400 002 D0211

3

DDA 200

Standards		
Operating characteristic: type		
Rated current I _n		[A]
Poles		
Rated voltage U _e	2P	[V]
	3P	
	4P	
Insulation voltage U _i		[V]
Operating voltage of circuit test U _t	2P	[V]
	3P	
	4P	
Rated frequency		Hz
Rated breaking capacity according to	IEC EN 61009	[A]
Rated breaking capacity according to	IEC EN 60947-2	[A]
Rated residual breaking capacity I _{Δm}		[kA]
Rated impulse withstand capacity (1,2/50) U _{imp}		[kV]
Dielectric test voltage at ind. freq. for 1 min.		[kV]
Surge current resistance (wave 8/20)		[A]
Rated sensitivity I _{Δn}		[A]
Toggle		
Electrical life		
Mechanical life		
Protection degree	housing	
	terminals	
Environmental conditions (damp heat) acc. to IEC/EN 60068-2-30		[°C/RH]
Ambient temperature (with daily average ≤ +35 °C)		[°C]
Storage temperature		[°C]
Terminal type	2P	
	3P/4P I _n =25 and 40 A	
	3P/4P I _n =63 A	
Terminal size	2P	[mm ²]
	3P/4P I _n =25 and 40 A	[mm ²]
	3P/4P I _n =63 A	[mm ²]
Tightening torque	2P	[Nm]
	3P/4P I _n =25 and 40 A	[Nm]
	3P/4P I _n =63 A	[Nm]
Mounting		
Dimensions	2P	[mm]
H x P x L	3P/4P I _n =25 and 40 A	[mm]
	3P/4P I _n =63 A	[mm]
Weight	2P	[g]
	3P/4P I _n =25 and 40 A	[g]
	3P/4P I _n =63 A	[g]
Combinable with	S 200 L	
	S 200	
	S 200 M	
	S 200 P	

① All RCD-blocks DDA 200 with rated current 63 A are provided with two additional terminals for remote tripping.

② DDA200 A AE is provided with two additional terminals for remote release in positive safety.

A remote control circuit should be connected to those terminals where circuit breakers or push buttons with normally closed contacts should be inserted.

DDA 200 AC	DDA 200 A	DDA 200 A AP-R	DDA 200 A AE	DDA 200 A S	DDA 200 B
IEC EN 61009 App.G					IEC EN 62423
AC	A	A	A	A	B
25, 40, 63 ①		25, 40, 63 ①	63 ②	63 ①	25-40-63
2P, 3P, 4P					2P, 3P, 4P
230 (400 for special execution @400 V)			230	230	230
230/400			400	400	400
230/400			230/400	230/400	230/400
500					
110-254 (400 for special execution @400 V)			184-264	110-254	195-254 (170-254 for 30 mA)
195-440 (110-254 for special execution @110 V)			310-440	195-440	310-440 (300-440 for 30 mA)
195-440 (110-254 for special execution @110 V)			184-264	195-440	195-254 (300-440 for 30 mA)
50...60					
same of the coupled MCB					
same of the coupled MCB					
same of the coupled MCB					
4					
2,5					
250		3000	250	5000	3000 (5000 for selective types)
0.01-0.03-0.1-0.3-0.5-1		0.03	0.03-0.3-0.5-1	0.1-0.3-0.5-1	0.03 - 0.3 - 0.5
blue					
10000					
20000					
IP4X					
IP2X					
28 cycles with 55°C/90-96% and 25°C/95-100%					
-25...+55					
-40...+70					
bi-directional cylinder-lift					
cage type					-
bi-directional cylinder-lift					
(rigid or flexible) up to 25					
(rigid or flexible) up to 16					-
(rigid or flexible) up to 25					
2.8					
1.2					-
2.8					
on DIN rail EN 60715 (35 mm) by means of fast clip device					
85 x 69 x 35					85 x 69 x 70
85 x 69 x 35					85 x 69 x 70
85 x 69 x 70					85 x 69 x 70
175					350
175					375
325					395
yes					
yes					
yes					
yes					

3

RCD-blocks

DDA 200 series AC type



DDA 202



DDA 203

DDA 200 AC type

Function: RCD-block for assembly on site with MCBs S 200 series. Protection against the effects of sinusoidal alternating earth fault currents; protection against indirect contacts and additional protection against direct contacts (with $I_{\Delta n}=30$ mA).

Application: residential, commercial, industrial.

Standard: IEC/EN 61009 Ann. G

Number of poles	Rated residual current $I_{\Delta n}$ mA	Rated current In A	Bbn 8012542 EAN	Order details		Price 1 piece	Weight 1 piece kg	Pack unit pc.
				Type code	Order code			
2	10	25	791003	DDA202 AC-25/0.01	2CSB202001R0250		0.180	1
		30	791102	DDA202 AC-25/0.03	2CSB202001R1250		0.180	1
		40	791201	DDA202 AC-40/0.03	2CSB202001R1400		0.180	1
		63 ^②	791300	DDA202 AC-63/0.03	2CSB202001R1630		0.180	1
	100	25	791409	DDA202 AC-25/0.1	2CSB202001R2250		0.180	1
		40	791508	DDA202 AC-40/0.1	2CSB202001R2400		0.180	1
		63 ^②	791607	DDA202 AC-63/0.1	2CSB202001R2630		0.180	1
	300	25	791706	DDA202 AC-25/0.3	2CSB202001R3250		0.180	1
		40	791805	DDA202 AC-40/0.3	2CSB202001R3400		0.180	1
		63 ^②	791904	DDA202 AC-63/0.3	2CSB202001R3630		0.180	1
	500	25	792000	DDA202 AC-25/0.5	2CSB202001R4250		0.180	1
		40	792109	DDA202 AC-40/0.5	2CSB202001R4400		0.180	1
63 ^②		792208	DDA202 AC-63/0.5	2CSB202001R4630		0.180	1	
1000	25	808305	DDA202 AC-25/1	2CSB202001R5250		0.180	1	
	40	808404	DDA202 AC-40/1	2CSB202001R5400		0.180	1	
	63 b	792307	DDA202 AC-63/1	2CSB202001R5630		0.180	1	
2000	63	792406	DDA202 AC-63/2	2CSB202001R6630		0.180	1	

Number of poles	Rated residual current $I_{\Delta n}$ mA	Rated current In A	Bbn 8012542 EAN	Order details		Price 1 piece	Weight 1 piece kg	Pack unit pc.
				Type code	Order code			
3	30	25	792505	DDA203 AC-25/0.03	2CSB203001R1250		0.220	1
		40	792604	DDA203 AC-40/0.03	2CSB203001R1400		0.220	1
		63 ^②	792703	DDA203 AC-63/0.03	2CSB203001R1630		0.260	1
	100	25	792802	DDA203 AC-25/0.1	2CSB203001R2250		0.220	1
		40	792901	DDA203 AC-40/0.1	2CSB203001R2400		0.220	1
		63 ^②	793007	DDA203 AC-63/0.1	2CSB203001R2630		0.260	1
	300	25	793106	DDA203 AC-25/0.3	2CSB203001R3250		0.220	1
		40	793205	DDA203 AC-40/0.3	2CSB203001R3400		0.220	1
		63 ^②	793304	DDA203 AC-63/0.3	2CSB203001R3630		0.260	1
	500	25	793403	DDA203 AC-25/0.5	2CSB203001R4250		0.220	1
		40	793502	DDA203 AC-40/0.5	2CSB203001R4400		0.220	1
		63 ^②	793601	DDA203 AC-63/0.5	2CSB203001R4630		0.260	1
	1000	25	808503	DDA203 AC-25/1	2CSB203001R5250		0.220	1
		40	808602	DDA203 AC-40/1	2CSB203001R5400		0.220	1
		63 ^②	793700	DDA203 AC-63/1	2CSB203001R5630		0.260	1
	2000	63	793809	DDA203 AC-63/2	2CSB203001R6630		0.260	1

^① version with test button working at 110VAC - 254VAC is available. For selection tables refer to special version paragraph.
^② provided with additional terminals for remote tripping

Where to find more:
 Worldwide Marks and Approvals p.11/92
 Technical guide of RCDs (code 2CSC420004B0201)



Frequently asked question - FAQ:
 A complete list of answers is available in the RCDs FAQ document (code 2CSC420005B0201)



Maybe you are also interested in:
 Auxiliary Elements for RCDs p.4/4
 Accessories for RCDs p.4/16
 Busbar Systems p.4/21



DDA 204

2CSB4001R5F0201

Number of poles	Rated residual current I _{Δn} mA	Rated current In A	Bbn 8012542 EAN	Order details		Price 1 piece	Weight 1 piece kg	Pack unit pc.
				Type code	Order code			
4	30	25	793908	DDA204 AC-25/0.03	2CSB204001R1250		0.260	1
		40	794004	DDA204 AC-40/0.03	2CSB204001R1400		0.260	1
		63 ①②	794103	DDA204 AC-63/0.03	2CSB204001R1630		0.305	1
	100	25	794202	DDA204 AC-25/0.1	2CSB204001R2250		0.260	1
		40	794301	DDA204 AC-40/0.1	2CSB204001R2400		0.260	1
		63 ②	794400	DDA204 AC-63/0.1	2CSB204001R2630		0.305	1
	300	25	794509	DDA204 AC-25/0.3	2CSB204001R3250		0.260	1
		40	794608	DDA204 AC-40/0.3	2CSB204001R3400		0.260	1
		63 ②	794707	DDA204 AC-63/0.3	2CSB204001R3630		0.305	1
500	25	794806	DDA204 AC-25/0.5	2CSB204001R4250		0.260	1	
	40	794905	DDA204 AC-40/0.5	2CSB204001R4400		0.260	1	
	63 ②	795001	DDA204 AC-63/0.5	2CSB204001R4630		0.305	1	
1000	25	808701	DDA204 AC-25/1	2CSB204001R5250		0.260	1	
	40	808800	DDA204 AC-40/1	2CSB204001R5400		0.260	1	
	63 ②	795100	DDA204 AC-63/1	2CSB204001R5630		0.305	1	
2000	63	795209	DDA204 AC-63/2	2CSB204001R6630		0.305	1	

3

① version with test button working at 110VAC - 254VAC is available. For selection tables refer to special version paragraph.
 ② provided with additional terminals for remote tripping

RCD-blocks

DDA 200 series A type



DDA 202



DDA 203

DDA 200 A type

Function: RCD-block for assembly on site with MCBs S 200 series. Protection against the effects of sinusoidal alternating and direct pulsating earth fault currents; protection against indirect contacts and additional protection against direct contacts (with $I_{\Delta n}=30$ mA).

Application: residential, commercial, industrial.

Standard: IEC/EN 61009 Ann. G

Number of poles	Rated residual current $I_{\Delta n}$ mA	Rated current		Bbn 8012542		Order details	Price 1 piece	Weight 1 piece kg	Pack unit pc.
		In A	EAN	Type code	Order code				
2	10	25	795308	DDA202 A-25/0.01	2CSB202101R0250	0.180	1		
		30	795407	DDA202 A-25/0.03	2CSB202101R1250	0.180	1		
		40	795506	DDA202 A-40/0.03	2CSB202101R1400	0.180	1		
		63 ②	795605	DDA202 A-63/0.03	2CSB202101R1630	0.180	1		
	100	25	795704	DDA202 A-25/0.1	2CSB202101R2250	0.180	1		
		40	795803	DDA202 A-40/0.1	2CSB202101R2400	0.180	1		
		63 ②	795902	DDA202 A-63/0.1	2CSB202101R2630	0.180	1		
	300	25	796008	DDA202 A-25/0.3	2CSB202101R3250	0.180	1		
		40	796107	DDA202 A-40/0.3	2CSB202101R3400	0.180	1		
		63 ②	796206	DDA202 A-63/0.3	2CSB202101R3630	0.180	1		
	500	25	796305	DDA202 A-25/0.5	2CSB202101R4250	0.180	1		
		40	796404	DDA202 A-40/0.5	2CSB202101R4400	0.180	1		
63 ②		796503	DDA202 A-63/0.5	2CSB202101R4630	0.180	1			
1000	25	808909	DDA202 A-25/1	2CSB202101R5250	0.180	1			
	40	809005	DDA202 A-40/1	2CSB202101R5400	0.180	1			
	63 ②	796602	DDA202 A-63/1	2CSB202101R5630	0.180	1			

Number of poles	Rated residual current $I_{\Delta n}$ mA	Rated current		Bbn 8012542		Order details	Price 1 piece	Weight 1 piece kg	Pack unit pc.
		In A	EAN	Type code	Order code				
3	30	25	796701	DDA203 A-25/0.03	2CSB203101R1250	0.220	1		
		40 ①	796800	DDA203 A-40/0.03	2CSB203101R1400	0.220	1		
		63 ①②	796909	DDA203 A-63/0.03	2CSB203101R1630	0.260	1		
	100	25	797005	DDA203 A-25/0.1	2CSB203101R2250	0.220	1		
		40	797104	DDA203 A-40/0.1	2CSB203101R2400	0.220	1		
		63 ②	797203	DDA203 A-63/0.1	2CSB203101R2630	0.260	1		
	300	25	797302	DDA203 A-25/0.3	2CSB203101R3250	0.220	1		
		40	797401	DDA203 A-40/0.3	2CSB203101R3400	0.220	1		
		63 ②	797500	DDA203 A-63/0.3	2CSB203101R3630	0.260	1		
	500	25	797609	DDA203 A-25/0.5	2CSB203101R4250	0.220	1		
		40	797708	DDA203 A-40/0.5	2CSB203101R4400	0.220	1		
		63 ②	797807	DDA203 A-63/0.5	2CSB203101R4630	0.260	1		
	1000	25	809104	DDA203 A-25/1	2CSB203101R5250	0.220	1		
		40	809203	DDA203 A-40/1	2CSB203101R5400	0.220	1		
		63 ②	797906	DDA203 A-63/1	2CSB203101R5630	0.260	1		

① version with test button working at 110VAC - 254VAC is available. For selection tables refer to special version paragraph.
② provided with additional terminals for remote tripping

Where to find more:
Worldwide Marks and Approvals p.11/92
Technical guide of RCDs (code 2CSC420004B0201)



Frequently asked question - FAQ:
A complete list of answers is available in the RCDs FAQ document (code 2CSC420005B0201)



Maybe you are also interested in:
Auxiliary Elements for RCDs p.4/4
Accessories for RCDs p.4/16
Busbar Systems p.4/21



DDA 204

2CSB204101R5630

Number of poles	Rated residual current I _{Δn} mA	Rated current In A	Bbn 8012542 EAN	Order details		Price 1 piece	Weight 1 piece kg	Pack unit pc.
				Type code	Order code			
4	30	25	798002	DDA204 A-25/0.03	2CSB204101R1250		0.260	1
		40	798101	DDA204 A-40/0.03	2CSB204101R1400		0.260	1
		63 ①②	798200	DDA204 A-63/0.03	2CSB204101R1630		0.305	1
	100	25	798309	DDA204 A-25/0.1	2CSB204101R2250		0.260	1
		40	798408	DDA204 A-40/0.1	2CSB204101R2400		0.260	1
		63 ②	798507	DDA204 A-63/0.1	2CSB204101R2630		0.305	1
	300	25	798606	DDA204 A-25/0.3	2CSB204101R3250		0.260	1
		40	798705	DDA204 A-40/0.3	2CSB204101R3400		0.260	1
		63 ②	798804	DDA204 A-63/0.3	2CSB204101R3630		0.305	1
500	25	798903	DDA204 A-25/0.5	2CSB204101R4250		0.260	1	
	40	799009	DDA204 A-40/0.5	2CSB204101R4400		0.260	1	
	63 ②	799108	DDA204 A-63/0.5	2CSB204101R4630		0.305	1	
1000	25	809302	DDA204 A-25/1	2CSB204101R5250		0.260	1	
	40	809401	DDA204 A-40/1	2CSB204101R5400		0.260	1	
	63 ②	799207	DDA204 A-63/1	2CSB204101R5630		0.305	1	

3

① version with test button working at 110VAC - 254VAC is available. For selection tables refer to special version paragraph.
 ② provided with additional terminals for remote tripping

RCD-blocks

DDA 200 special version 110 V and 400 V



DDA 202



DDA 203



DDA 204

DDA 200 special version 110 V and 400 V

Function: special version of RCD-blocks to assembly on site with MCBs S 200 series. Special version are available with protection against the effects of sinusoidal alternating and/or direct pulsating earth fault currents, protection against indirect contacts and additional protection against direct contacts (with $I_{\Delta n}=30$ mA).

DDA200 110 V is a particular RCD-block with voltage range for test button $U_t = 110-245$ V.

RCD- blocks work for naval applications where the IT system is typically used and the voltage between the phase and the neutral conductor is 115 - 125 V. DDA200 110 V ($U_t = 110-245$ V) are suitable for naval applications.

Special version is also available for 400 V in the two poles version working in two-phase industrial systems where voltage between phases is 400 V.

Applications: naval, industrial.

Standards: IEC EN 61009 Ann. G

110 V version

AC type

Number of poles	Rated residual current $I_{\Delta n}$ mA	Rated current In A	Bbn 8012542 EAN	Order details		Price 1 piece	Weight 1 piece kg	Pack unit pc.
				Type code	Order code			
4	30	63 ①	929901	DDA 204 AC-63/0.03 110V	2CSB204099R1630		0.350	1

A type

Number of poles	Rated residual current $I_{\Delta n}$ mA	Rated current In A	Bbn 8012542 EAN	Order details		Price 1 piece	Weight 1 piece kg	Pack unit pc.
				Type code	Order code			
3	30	40	811701	DDA 203 A-40/0.03 110V	2CSB203199R1400		0.350	1
		63 ①	811800	DDA 203 A-63/0.03 110V	2CSB203199R1630		0.350	1
4	30	63 ①	812104	DDA 204 A-63/0.03 110V	2CSB204199R1630		0.350	1

400 V version

A type

Number of poles	Rated residual current $I_{\Delta n}$ mA	Rated current In A	Bbn 8012542 EAN	Order details		Price 1 piece	Weight 1 piece kg	Pack unit pc.
				Type code	Order code			
2	30	63 ①	954934	DDA 202 A-63/0.03 400V	2CSB202192R1630		0.200	1

① provided with additional terminals for remote tripping

Where to find more:
Worldwide Marks and Approvals p.11/92
Technical guide of RCDs (code 2CSC420004B0201)



Frequently asked question - FAQ:
A complete list of answers is available in the RCDs FAQ document (code 2CSC420005B0201)



Maybe you are also interested in:
Auxiliary Elements for RCDs p.4/4
Accessories for RCDs p.4/16
Busbar Systems p.4/21

RCD-blocks

DDA 200 series A type, AP-R (high immunity)



DDA 202



DDA 203



DDA 204

DDA 200 AP-R, A type

Function: RCD-block for assembly on site with MCBs S 200 series. Protection against the effects of sinusoidal alternating and direct pulsating earth fault currents, providing the best compromise between safety and continuity in the service thanks to the resistance to unwanted trippings; protection against indirect contacts and additional protection against direct contacts (with $I_{\Delta n}=30$ mA).

Application: residential, commercial, industrial.

Standard: IEC/EN 61009 Ann. G

Surge current resistance (wave 8/20)=3000 A

3

Number of poles	Rated residual current $I_{\Delta n}$ mA	Rated current In A	Bbn 8012542 EAN	Order details		Price 1 piece	Weight 1 piece kg	Pack unit pc.
				Type code	Order code			
2	30	25	801108	DDA202 A-25/0.03 AP-R	2CSB202401R1250		0.180	1
		40	801207	DDA202 A-40/0.03 AP-R	2CSB202401R1400		0.180	1
		63 ①	801306	DDA202 A-63/0.03 AP-R	2CSB202401R1630		0.180	1

Number of poles	Rated residual current $I_{\Delta n}$ mA	Rated current In A	Bbn 8012542 EAN	Order details		Price 1 piece	Weight 1 piece kg	Pack unit pc.
				Type code	Order code			
3	30	25	811008	DDA203 A-25/0.03 AP-R	2CSB203401R1250		0.220	1
		40	811107	DDA203 A-40/0.03 AP-R	2CSB203401R1400		0.220	1
		63 ①	811206	DDA203 A-63/0.03 AP-R	2CSB203401R1630		0.260	1

Number of poles	Rated residual current $I_{\Delta n}$ mA	Rated current In A	Bbn 8012542 EAN	Order details		Price 1 piece	Weight 1 piece kg	Pack unit pc.
				Type code	Order code			
4	30	25	801405	DDA204 A-25/0.03 AP-R	2CSB204401R1250		0.260	1
		40	801504	DDA204 A-40/0.03 AP-R	2CSB204401R1400		0.260	1
		63 ①	801603	DDA204 A-63/0.03 AP-R	2CSB204401R1630		0.305	1

① provided with additional terminals for remote tripping

RCD-blocks

DDA 200 series A type, AE (for emergency stop)



3 DDA 202

DDA 200 AE, A type

Function: RCD-block for assembly on site with MCBs S 200 series. Protection against the effects of sinusoidal alternating and direct pulsating earth fault currents; protection against indirect contacts and additional protection against direct contacts (with $I_n=30$ mA).

The RCD-block is provided with two additional terminals to be used in emergency circuits for remote opening in positive safety. A remote control circuit should be connected to those terminals where NC push buttons should be inserted in series.

ATTENTION!

It's allowed to use multiple NC buttons to control one DDA200 AE but it's not permitted to use one button in a control circuit for more RCD-blocks DDA200 AE. DDA200 AE must be supplied by the top side.

Application: commercial, industrial.

Standard: IEC/EN 61009 Ann. G



DDA 203

Number of poles	Rated residual current In mA	Rated current In A	Bbn 8012542 EAN	Order details		Price 1 piece	Weight 1 piece kg	Pack unit pc.
				Type code	Order code			
2	30	63	801702	DDA202 A-63/0.03 AE	2CSB202701R1630		0.180	1
	300	63	801801	DDA202 A-63/0.3 AE	2CSB202701R3630		0.180	1
	500	63	801900	DDA202 A-63/0.5 AE	2CSB202701R4630		0.180	1
	1000	63	802006	DDA202 A-63/1 AE	2CSB202701R5630		0.180	1



DDA 204

Number of poles	Rated residual current In mA	Rated current In A	Bbn 8012542 EAN	Order details		Price 1 piece	Weight 1 piece kg	Pack unit pc.
				Type code	Order code			
3	30	63	802105	DDA203 A-63/0.03 AE	2CSB203701R1630		0.260	1
	300	63	802204	DDA203 A-63/0.3 AE	2CSB203701R3630		0.260	1
	500	63	802303	DDA203 A-63/0.5 AE	2CSB203701R4630		0.260	1
	1000	63	802402	DDA203 A-63/1 AE	2CSB203701R5630		0.260	1

Number of poles	Rated residual current In mA	Rated current In A	Bbn 8012542 EAN	Order details		Price 1 piece	Weight 1 piece kg	Pack unit pc.
				Type code	Order code			
4	30	63	802501	DDA204 A-63/0.03 AE	2CSB204701R1630		0.305	1
	300	63	802600	DDA204 A-63/0.3 AE	2CSB204701R3630		0.305	1
	500	63	802709	DDA204 A-63/0.5 AE	2CSB204701R4630		0.305	1
	1000	63	802808	DDA204 A-63/1 AE	2CSB204701R5630		0.305	1

Where to find more:

Wiring Scheme for DDA 200 AE series p.10/140
Worldwide Marks and Approvals p.11/92
Technical guide of RCDs (code 2CSC420004B0201)



Frequently asked question - FAQ:

A complete list of answers is available in the RCDs FAQ document (code 2CSC420005B0201)



Maybe you are also interested in:

Auxiliary Elements for RCDs p.4/4
Accessories for RCDs p.4/16
Busbar Systems p.4/21

RCD-blocks

DDA 200 series A type, selective



DDA 202



DDA 203



DDA 204

DDA 200 A selective type

Function: RCD-block for assembly on site with MCBs S 200 series. Protection against the effects of sinusoidal alternating and direct pulsating earth fault currents with an intentional tripping delay, which permits to realize the selectivity with downstream instantaneous devices (for more information about selectivity see the technical guide).

Application: commercial, industrial.

Standard: IEC/EN 61009 Ann. G

Surge current resistance (wave 8/20)=5000 A

3

Number of poles	Rated residual current I _{Δn} mA	Rated current I _n A	Bbn 8012542 EAN	Order details		Price 1 piece	Weight 1 piece kg	Pack unit pc.
				Type code	Order code			
2	100	63	799306	DDA202 A S-63/0.1	2CSB202201R2630		0.180	1
	300	63	799405	DDA202 A S-63/0.3	2CSB202201R3630		0.180	1
	500	63	799504	DDA202 A S-63/0.5	2CSB202201R4630		0.180	1
	1000	63	799603	DDA202 A S-63/1	2CSB202201R5630		0.180	1

Number of poles	Rated residual current I _{Δn} mA	Rated current I _n A	Bbn 8012542 EAN	Order details		Price 1 piece	Weight 1 piece kg	Pack unit pc.
				Type code	Order code			
3	100	63	799702	DDA203 A S-63/0.1	2CSB203201R2630		0.260	1
	300	63	799801	DDA203 A S-63/0.3	2CSB203201R3630		0.260	1
	500	63	799900	DDA203 A S-63/0.5	2CSB203201R4630		0.260	1
	1000	63	800002	DDA203 A S-63/1	2CSB203201R5630		0.260	1

Number of poles	Rated residual current I _{Δn} mA	Rated current I _n A	Bbn 8012542 EAN	Order details		Price 1 piece	Weight 1 piece kg	Pack unit pc.
				Type code	Order code			
4	100	63	800101	DDA204 A S-63/0.1	2CSB204201R2630		0.305	1
	300	63	800200	DDA204 A S-63/0.3	2CSB204201R3630		0.305	1
	500	63	800309	DDA204 A S-63/0.5	2CSB204201R4630		0.305	1
	1000	63	800408	DDA204 A S-63/1	2CSB204201R5630		0.305	1

Attention: All DDA 200 A S are provided with additional terminals for remote tripping

Where to find more:

Worldwide Marks and Approvals p.11/92
 Technical guide of RCDs (code 2CSC420004B0201)



Frequently asked question - FAQ:

A complete list of answers is available in the RCDs FAQ document (code 2CSC420005B0201)



Maybe you are also interested in:

Auxiliary Elements for RCDs p.4/4
 Accessories for RCDs p.4/16
 Busbar Systems p.4/21

RCD-blocks

DDA 200 series B type



DDA 202

3



DDA 203



DDA 204

DDA 200 type B for continuous type fault currents

RCD-blocks type B are also sensitive to continuous or mainly continuous (continuous with weak ondulation) current pulsating earth fault currents. They are also sensitive to alternate sinusoidal and direct pulsating earth fault currents as with type A circuit breakers.

They satisfy the requirements of type A devices and thus the requirements for type AC devices which can be considered an extension. For this reason the differential blocks type B are sometimes referred as "universal type", as sensitive to "all" kind of residual current shape.

DDA 200 type B can be coupled with all the S 200 series MCBs.

They are used for protection in installations with electronic equipments according to EN 50178.

Applications: tertiary and industrial.

Standards: IEC EN 61009 Ann. G, IEC 62423 ed.2

Surge current resistance (8/20 wave): 3000 A

Number of poles	Rated residual current I _{Δn} mA	Rated current In A	Bbn 8012542 EAN	Order details		Price 1 piece	Weight 1 piece kg	Pack unit pc.
				Type code	Order code			
2	30	25	748021	DDA202 B APR-25/0,03	2CSB202592R1250		0.350	1
		40	515128	DDA202 B APR-40/0,03	2CSB202592R1400		0.350	1
		63	610922	DDA202 B APR-63/0,03	2CSB202592R1630		0.350	1
	300	25	733324	DDA202 B APR-25/0,3	2CSB202592R3250		0.350	1
		63	732426	DDA202 B APR-63/0,3	2CSB202592R3630		0.350	1

Number of poles	Rated residual current I _{Δn} mA	Rated current In A	Bbn 8012542 EAN	Order details		Price 1 piece	Weight 1 piece kg	Pack unit pc.
				Type code	Order code			
3	30	63	733225	DDA203 B APR-63/0,03	2CSB203592R1630		0.375	1
	300	63	732327	DDA203 B APR-63/0,3	2CSB203592R3630		0.375	1

Number of poles	Rated residual current I _{Δn} mA	Rated current In A	Bbn 8012542 EAN	Order details		Price 1 piece	Weight 1 piece kg	Pack unit pc.	
				Type code	Order code				
4	30	25	732228	DDA204 B APR-25/0,03	2CSB204592R1250		0.395	1	
		40	020325	DDA204 B APR-40/0,03	2CSB204592R1400		0.395	1	
		63	733027	DDA204 B APR-63/0,03	2CSB204592R1630		0.395	1	
	300	25	732129	DDA204 B APR-25/0,3	2CSB204592R3250		0.395	1	
			63	732921	DDA204 B APR-63/0,3	2CSB204592R3630		0.395	1
	500	63	732020	DDA204 B APR-63/0,5	2CSB204592R4630		0.395	1	

Where to find more:

Worldwide Marks and Approvals p.11/92
 Technical guide of RCDs (code 2CSC420004B0201)



Frequently asked question - FAQ:

A complete list of answers is available in the RCDs FAQ document (code 2CSC420005B0201)



Maybe you are also interested in:

Auxiliary Elements for RCDs p.4/4
 Accessories for RCDs p.4/16
 Busbar Systems p.4/21



DDA 203

2CSB203892R3630



DDA 204

2CSB204892R3630

DDA 200 type B for selective continuous type fault currents

Function: protection against the effects of alternate sinusoidal, direct pulsating, continuous current and continuous current pulsating earth fault currents with an intentional trip delay that permits selectivity with instantaneous type devices placed downstream (for further information on selectivity, see chapter 10).

DDA 200 type B can be coupled with all the S 200 series MCBs.

They are used for protection in installations with electronic equipments according to EN 50178.

Applications: tertiary and industrial.

Standards: IEC EN 61009 Ann. G, IEC 62423 ed.2

Surge current resistance (8/20 wave): 5000 A

3

Number of poles	Rated residual current I _{Δn} mA	Rated current I _n A	Bbn 8012542 EAN	Order details		Price 1 piece	Weight 1 piece kg	Pack unit pc.
				Type code	Order code			
3	300	63	733126	DDA203 B S-63/0,3	2CSB203892R3630		0.375	1

Number of poles	Rated residual current I _{Δn} mA	Rated current I _n A	Bbn 8012542 EAN	Order details		Price 1 piece	Weight 1 piece kg	Pack unit pc.
				Type code	Order code			
4	300	63	732822	DDA204 B S-63/0,3	2CSB204892R3630		0.395	1

RCBO DS201 and DS202C. The details make the difference A range designed to ensure efficiency and protection

3

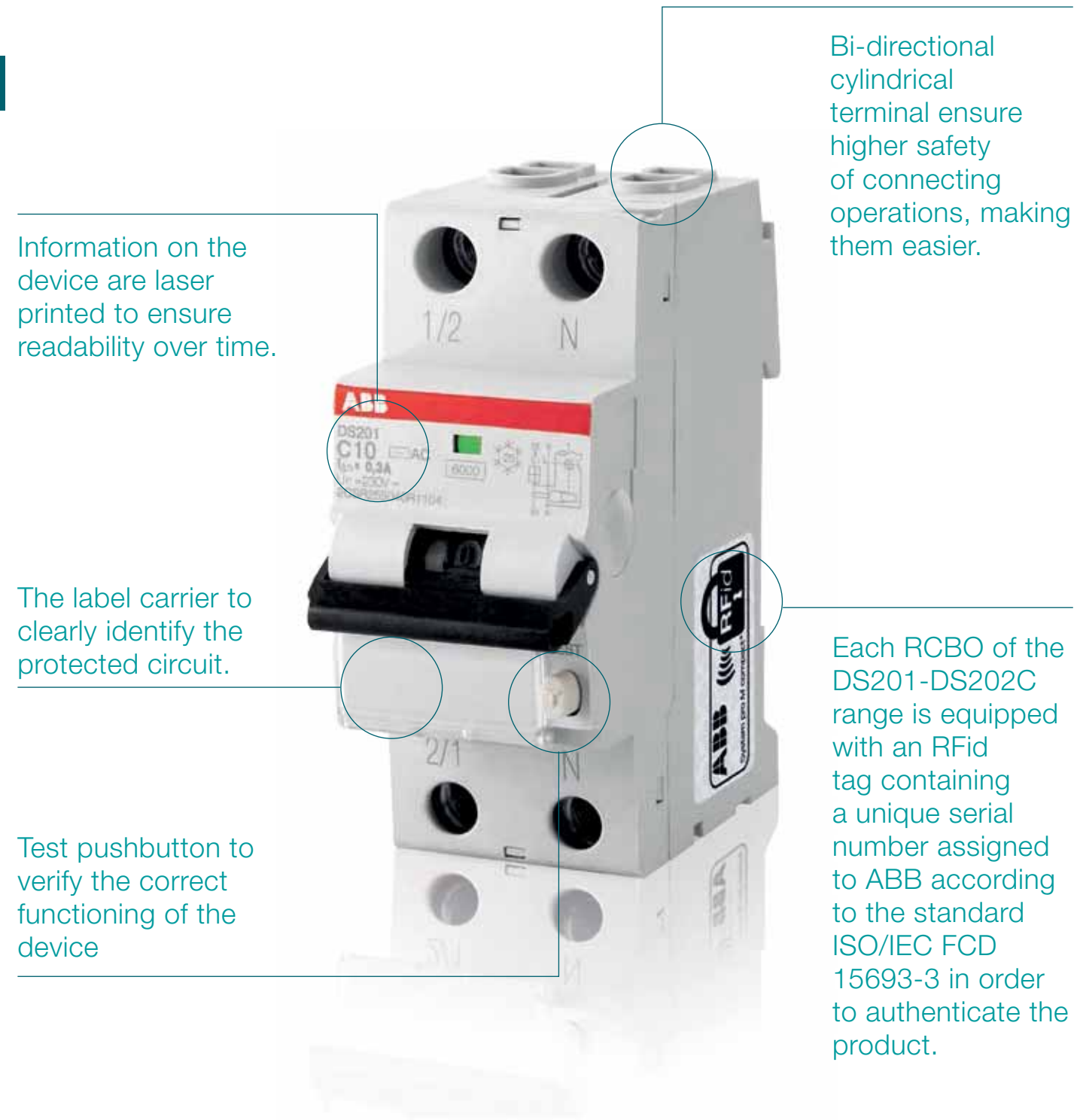



Any earth fault can be immediately identified through the blue indicator, that signals the differential tripping and which cannot be activated in case of manual operation on the toggle. This prevents any misinterpretations of the device and system status.



Contact position indicator (CPI): to always know the status of the contacts (red: closed contacts; green: open contacts).



The terminals available on DS201-DS202C make easier the supply operation in parallel with busbars as they are composed by two different seats, a front seat for 25 mm² cables and a back seat for 10 mm² busbars.

3

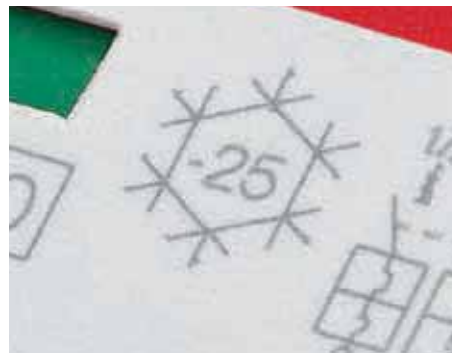

All the devices of the DS201 and DS202C series have been tested in a wide range of temperatures: from -25 °C (as indicated by the snowflake marked on the front side) up to +55°C.



Label carrier for clear and reliable identification. With the practical label carrier fitted in the new circuit breakers you can give maximum visibility to the information relating to the protected loads.



All the quality ensured by the main international marks is clearly visible on the device even if installed in the switchboard.



Product description and EAN code laser printed on the lateral side of the device for an easier stock management.

RCBOs

DS201 technical features



2CSC400002D0211

3

DS201 L

		Standards		
Electrical features	Type (wave form of the earth leakage sensed)			
	Poles			
	Rated current I_n		A	
	Rated sensitivity $I_{\Delta n}$		A	
	Rated voltage U_e		V	
	Insulation voltage U_i		V	
	Max. operating voltage of circuit test		V	
	Min. operating voltage of circuit test		V	
	Rated frequency		Hz	
	Rated breaking capacity acc. to IEC/EN 61009		ultimate I_{cn}	A
	Rated breaking capacity acc. to IEC/EN 60947-2		ultimate I_{cu}	kA
	1P+N @230 VAC		service I_{cs}	kA
	Rated residual breaking capacity $I_{\Delta m}$			kA
	Rated impulse withstand voltage (1.2/50) U_{imp}			kV
	Dielectric test voltage at ind. freq. for 1 min.			kV
	Thermomagnetic release characteristic		B: $3 I_n \leq I_m \leq 5 I_n$ C: $5 I_n \leq I_m \leq 10 I_n$ K: $10 I_n \leq I_m \leq 14 I_n$	
	Surge current resistance (wave 8/20)			A
Mechanical features	Toggle			
	Flag indicators			
	Electrical life			
	Mechanical life			
	Protection degree		housing terminals	
	Environmental conditions (damp heat) acc. to IEC/EN 60068-2-30			°C/RH
	Reference temperature for setting of thermal element			°C
	Ambient temperature (with daily average $\leq +35$ °C)			°C
	Storage temperature			°C
	Installation	Terminal type		top bottom
Terminal size top/bottom for cables		mm ²		
Terminal size top/bottom for busbar		mm ²		
Tightening torque top/bottom		Nm		
Mounting				
Connection				
Dimensions and weight	Dimensions (H x D x W)		mm	
	Weight		g	
Combination with auxiliary elements	Combinable with:		auxiliary contact signal contact shunt trip undervoltage release	

DS201 L	DS201			DS201 M				
IEC / EN 61009								
AC	A	APR	AC	A	APR	AC	A	APR
1P+N								
$6 \leq I_n \leq 32$			$1 \leq I_n \leq 40$			$4 \leq I_n \leq 40$		
0.03-0.3	0.01-0.03-0.3	0.03	0.03-0.1-0.3-1	0.01-0.03-0.1-0.3	0.03-0.1-0.3	0.03-0.1-0.3	0.01-0.03-0.1-0.3	0.03-0.1-0.3
230-240								
500								
254								
110								
50...60								
4500			6000			10000		
6			10			10		
4.5			6			7.5		
4.5			6			6		
4								
2.5								
■	■	■	■	■	■	■	■	■
■	■	■	■	■	■	■	■	■
250 (3000 for APR versions)								
black sealable in ON-OFF position								
differential trip indicator (blue)								
contact position indicator (green/red)								
10000								
20000								
IP4X								
IP2X								
28 cycles with 55°C/90-96% and 25°C/95-100%								
30								
-25...+55								
-40...+70								
failsafe bi-directional cylinder-lift terminal at top and bottom (shock protected)								
failsafe bi-directional cylinder-lift terminal at top and bottom (shock protected)								
25/25								
10/10								
2.8								
on DIN rail EN 60715 (35 mm) by means of fast clip device								
from top and bottom								
85 x 69 x 35								
239								
yes								
yes								
yes								
yes								

3

RCBOs

DS201 L series 4500 AC type, C characteristic



2CSC420004B0201

3 DS201 L

DS201 L AC type, C characteristic

Function: protection of end user single-phase circuits against overload and short-circuit currents; protection against the effects of sinusoidal alternating earth fault currents; protection against indirect contact and additional protection against direct contact ($I_{\Delta n}=30$ mA).

Application: residential, commercial, industrial.

Standard: IEC/EN 61009

$I_{cn}=4.5$ kA

Number of poles	Rated residual current $I_{\Delta n}$ mA	Rated current In A	Bbn 8012542 EAN	Order details		Price 1 piece	Weight 1 piece kg	Pack unit pc.	
				Type code	Order code				
1+N	30	6	171201	DS201 L C6 AC30	2CSR245040R1064		0.240	5	
		10	171300	DS201 L C10 AC30	2CSR245040R1104		0.240	5	
		16	171409	DS201 L C16 AC30	2CSR245040R1164		0.240	5	
		20	171508	DS201 L C20 AC30	2CSR245040R1204		0.240	5	
		25	171607	DS201 L C25 AC30	2CSR245040R1254		0.240	5	
		32	171706	DS201 L C32 AC30	2CSR245040R1324		0.240	5	
	300	300	6	171805	DS201 L C6 AC300	2CSR245040R3064		0.240	5
			10	171904	DS201 L C10 AC300	2CSR245040R3104		0.240	5
			16	172000	DS201 L C16 AC300	2CSR245040R3164		0.240	5
			20	172109	DS201 L C20 AC300	2CSR245040R3204		0.240	5
			25	172208	DS201 L C25 AC300	2CSR245040R3254		0.240	5
			32	172307	DS201 L C32 AC300	2CSR245040R3324		0.240	5

Where to find more:

Worldwide Marks and Approvals
p.11/92
Technical guide of RCDs (code
2CSC420004B0201)



Frequently asked question - FAQ:

A complete list of answers is available
in the RCDs FAQ document (code
2CSC420005B0201)



Maybe you are also interested in:

Auxiliary Elements for RCDs p.4/4
Accessories for RCDs p.4/16
Busbar Systems p.4/21

RCBOs

DS201 L series 4500 A type, C characteristic



DS201 L

DS201 L A type, C characteristic

Function: protection of end user single-phase circuits against overload and short-circuit currents; protection against the effects of sinusoidal alternating and direct pulsating earth fault currents; protection against indirect contact and additional protection against direct contact ($I_{\Delta n}=30$ mA).

Application: residential, commercial, industrial.

Standard: IEC/EN 61009

$I_{cn}=4.5$ kA

3

Number of poles	Rated residual current $I_{\Delta n}$ mA	Rated current I_n A	Bbn 8012542 EAN	Order details		Price 1 piece	Weight 1 piece kg	Pack unit pc.	
				Type code	Order code				
1+N	10	6	163404	DS201 L C6 A10	2CSR245140R0064		0.240	5	
		10	171003	DS201 L C10 A10	2CSR245140R0104		0.240	5	
		16	171102	DS201 L C16 A10	2CSR245140R0164		0.240	5	
	30	6	172406	DS201 L C6 A30	2CSR245140R1064		0.240	5	
			10	172505	DS201 L C10 A30	2CSR245140R1104		0.240	5
			16	172604	DS201 L C16 A30	2CSR245140R1164		0.240	5
		20	172703	DS201 L C20 A30	2CSR245140R1204		0.240	5	
			25	173809	DS201 L C25 A30	2CSR245140R1254		0.240	5
			32	173908	DS201 L C32 A30	2CSR245140R1324		0.240	5
	300	6	174004	DS201 L C6 A300	2CSR245140R3064		0.240	5	
			10	174103	DS201 L C10 A300	2CSR245140R3104		0.240	5
			16	174202	DS201 L C16 A300	2CSR245140R3164		0.240	5
20		174301	DS201 L C20 A300	2CSR245140R3204		0.240	5		
		25	174707	DS201 L C25 A300	2CSR245140R3254		0.240	5	
		32	174806	DS201 L C32 A300	2CSR245140R3324		0.240	5	

RCBOs

DS201 L series 4500 APR type, C characteristic



2CSC400005B0202

3 DS201 L

DS201 L APR type, C characteristic

Function: protection against the effects of sinusoidal alternating and direct pulsating earth fault currents, providing an optimal trade-off between safety and continuity of service, thanks to the resistance to unwanted tripping; protection against indirect contact and additional protection against direct contact ($I_{\Delta n}=30\text{mA}$); protection and isolation of resistive and inductive loads.

Application: residential, commercial, industrial.

Standard: IEC/EN 61009

$I_{cn}=4.5\text{ kA}$

Number of poles	Rated residual current $I_{\Delta n}$ mA	Rated current I_n A	Bbn 8012542 EAN	Order details		Price 1 piece	Weight 1 piece kg	Pack unit pc.
				Type code	Order code			
1+N	30	6	174905	DS201 L C6 APR30	2CSR245440R1064		0.240	5
		10	175001	DS201 L C10 APR30	2CSR245440R1104		0.240	5
		16	175100	DS201 L C16 APR30	2CSR245440R1164		0.240	5
		20	175209	DS201 L C20 APR30	2CSR245440R1204		0.240	5
		25	175605	DS201 L C25 APR30	2CSR245440R1254		0.240	5
		32	175704	DS201 L C32 APR30	2CSR245440R1324		0.240	5

Where to find more:

Worldwide Marks and Approvals
p.11/92
Technical guide of RCDs (code
2CSC420004B0201)



Frequently asked question - FAQ:

A complete list of answers is available
in the RCDs FAQ document (code
2CSC420005B0201)



Maybe you are also interested in:

Auxiliary Elements for RCDs p.4/4
Accessories for RCDs p.4/16
Busbar Systems p.4/21

RCBOs

DS201 series 6000 AC type, B characteristic



DS201

DS201 AC type, B characteristic

Function: protection of end user single-phase circuits against overload and short-circuit currents; protection against the effects of sinusoidal alternating earth fault currents; protection against indirect contact and additional protection against direct contact ($I_{\Delta n}=30$ mA).

Application: residential, commercial, industrial.

Standard: IEC/EN 61009

$I_{cn}=6$ kA

3

Number of poles	Rated residual current $I_{\Delta n}$ mA	Rated current In A	Bbn 8012542 EAN	Order details		Price 1 piece	Weight 1 piece kg	Pack unit pc.	
				Type code	Order code				
1+N	30	6	279709	DS201 B6 AC30	2CSR255040R1065		0.240	5	
		10	280309	DS201 B10 AC30	2CSR255040R1105		0.240	5	
		13	285205	DS201 B13 AC30	2CSR255040R1135		0.240	5	
		16	285304	DS201 B16 AC30	2CSR255040R1165		0.240	5	
		20	285403	DS201 B20 AC30	2CSR255040R1205		0.240	5	
		25	285502	DS201 B25 AC30	2CSR255040R1255		0.240	5	
		32	285601	DS201 B32 AC30	2CSR255040R1325		0.240	5	
		40	285700	DS201 B40 AC30	2CSR255040R1405		0.240	5	
	100	30	6	285809	DS201 B6 AC100	2CSR255040R2065		0.240	5
			10	285908	DS201 B10 AC100	2CSR255040R2105		0.240	5
			13	286004	DS201 B13 AC100	2CSR255040R2135		0.240	5
			16	286103	DS201 B16 AC100	2CSR255040R2165		0.240	5
			20	286202	DS201 B20 AC100	2CSR255040R2205		0.240	5
			25	286301	DS201 B25 AC100	2CSR255040R2255		0.240	5
			32	286400	DS201 B32 AC100	2CSR255040R2325		0.240	5
			40	286509	DS201 B40 AC100	2CSR255040R2405		0.240	5
	300	30	6	286608	DS201 B6 AC300	2CSR255040R3065		0.240	5
			10	286707	DS201 B10 AC300	2CSR255040R3105		0.240	5
			13	293903	DS201 B13 AC300	2CSR255040R3135		0.240	5
			16	294009	DS201 B16 AC300	2CSR255040R3165		0.240	5
			20	294108	DS201 B20 AC300	2CSR255040R3205		0.240	5
			25	294207	DS201 B25 AC300	2CSR255040R3255		0.240	5
			32	294306	DS201 B32 AC300	2CSR255040R3325		0.240	5
			40	294405	DS201 B40 AC300	2CSR255040R3405		0.240	5

RCBOs

DS201 series 6000 AC type, C characteristic



2CSC400002D021

3

DS201

DS201 AC type, C characteristic

Function: protection of end user single-phase circuits against overload and short-circuit currents; protection against the effects of sinusoidal alternating earth fault currents; protection against indirect contact and additional protection against direct contact ($I_{\Delta n}=30$ mA).

Application: residential, commercial, industrial.

Standard: IEC/EN 61009

$I_{cn}=6$ kA

Number of poles	Rated residual current $I_{\Delta n}$ mA	Rated current In A	Bbn 8012542		Order details		Price 1 piece	Weight 1 piece kg	Pack unit pc.
			EAN	Order code	Type code	Order code			
1+N	30	6	294504	DS201 C6 AC30	2CSR255040R1064		0.240	5	
		10	294603	DS201 C10 AC30	2CSR255040R1104		0.240	5	
		13	294702	DS201 C13 AC30	2CSR255040R1134		0.240	5	
		16	294801	DS201 C16 AC30	2CSR255040R1164		0.240	5	
		20	294900	DS201 C20 AC30	2CSR255040R1204		0.240	5	
		25	295006	DS201 C25 AC30	2CSR255040R1254		0.240	5	
		32	296003	DS201 C32 AC30	2CSR255040R1324		0.240	5	
		40	296102	DS201 C40 AC30	2CSR255040R1404		0.240	5	
	100	6	296201	DS201 C6 AC100	2CSR255040R2064		0.240	5	
		10	296409	DS201 C10 AC100	2CSR255040R2104		0.240	5	
		13	370802	DS201 C13 AC100	2CSR255040R2134		0.240	5	
		16	370901	DS201 C16 AC100	2CSR255040R2164		0.240	5	
		20	371601	DS201 C20 AC100	2CSR255040R2204		0.240	5	
		25	371700	DS201 C25 AC100	2CSR255040R2254		0.240	5	
		32	371809	DS201 C32 AC100	2CSR255040R2324		0.240	5	
		40	498100	DS201 C40 AC100	2CSR255040R2404		0.240	5	
	300	6	498209	DS201 C6 AC300	2CSR255040R3064		0.240	5	
		10	498308	DS201 C10 AC300	2CSR255040R3104		0.240	5	
		13	505907	DS201 C13 AC300	2CSR255040R3134		0.240	5	
		16	506003	DS201 C16 AC300	2CSR255040R3164		0.240	5	
		20	506102	DS201 C20 AC300	2CSR255040R3204		0.240	5	
		25	506201	DS201 C25 AC300	2CSR255040R3254		0.240	5	
		32	618300	DS201 C32 AC300	2CSR255040R3324		0.240	5	
		40	638407	DS201 C40 AC300	2CSR255040R3404		0.240	5	
	1000	6	996606	DS201 C6 AC1000	2CSR255040R5064		0.240	5	
		10	996705	DS201 C10 AC1000	2CSR255040R5104		0.240	5	
		16	996804	DS201 C16 AC1000	2CSR255040R5164		0.240	5	
		20	996903	DS201 C20 AC1000	2CSR255040R5204		0.240	5	
25		997009	DS201 C25 AC1000	2CSR255040R5254		0.240	5		
32		997108	DS201 C32 AC1000	2CSR255040R5324		0.240	5		
40		997207	DS201 C40 AC1000	2CSR255040R5404		0.240	5		

Where to find more:

Worldwide Marks and Approvals p.11/92
 Technical guide of RCDs (code 2CSC420004B0201)



Frequently asked question - FAQ:

A complete list of answers is available in the RCDs FAQ document (code 2CSC420005B0201)



Maybe you are also interested in:

Auxiliary Elements for RCDs p.4/4
 Accessories for RCDs p.4/16
 Busbar Systems p.4/21

RCBOs

DS201 series 6000 APR type, C characteristic



DS201

DS201 APR type, C characteristic

Function: protection against the effects of sinusoidal alternating and direct pulsating earth fault currents, providing an optimal trade-off between safety and continuity of service thanks to the resistance to unwanted tripping; protection against indirect contact and additional protection against direct contact ($I_{\Delta n}=30$ mA); protection and isolation of resistive and inductive loads.

Application: residential, commercial, industrial.

Standard: IEC/EN 61009

$I_{cn}=6$ kA

3

Number of poles	Rated residual current $I_{\Delta n}$ mA	Rated current I_n A	Bbn 8012542 EAN	Order details		Price 1 piece	Weight 1 piece kg	Pack unit pc.	
				Type code	Order code				
1+N	30	6	997306	DS201 C6 APR30	2CSR255440R1064		0.240	5	
		10	997405	DS201 C10 APR30	2CSR255440R1104		0.240	5	
		13	997504	DS201 C13 APR30	2CSR255440R1134		0.240	5	
		16	997603	DS201 C16 APR30	2CSR255440R1164		0.240	5	
		20	997702	DS201 C20 APR30	2CSR255440R1204		0.240	5	
		25	997801	DS201 C25 APR30	2CSR255440R1254		0.240	5	
		32	997900	DS201 C32 APR30	2CSR255440R1324		0.240	5	
		40	998006	DS201 C40 APR30	2CSR255440R1404		0.240	5	
	100	30	6	126454	DS201 C6 APR100	2CSR255440R2064		0.240	5
			10	126553	DS201 C10 APR100	2CSR255440R2104		0.240	5
			13	126652	DS201 C13 APR100	2CSR255440R2134		0.240	5
			16	126751	DS201 C16 APR100	2CSR255440R2164		0.240	5
			20	126850	DS201 C20 APR100	2CSR255440R2204		0.240	5
			25	126959	DS201 C25 APR100	2CSR255440R2254		0.240	5
			32	127055	DS201 C32 APR100	2CSR255440R2324		0.240	5
			40	127154	DS201 C40 APR100	2CSR255440R2404		0.240	5
	300	30	6	998105	DS201 C6 APR300	2CSR255440R3064		0.240	5
			10	998204	DS201 C10 APR300	2CSR255440R3104		0.240	5
			13	998303	DS201 C13 APR300	2CSR255440R3134		0.240	5
			16	998402	DS201 C16 APR300	2CSR255440R3164		0.240	5
			20	998501	DS201 C20 APR300	2CSR255440R3204		0.240	5
			25	998600	DS201 C25 APR300	2CSR255440R3254		0.240	5
			32	998709	DS201 C32 APR300	2CSR255440R3324		0.240	5
			40	998808	DS201 C40 APR300	2CSR255440R3404		0.240	5

RCBOs

DS201 series 6000 A type, B characteristic



2CSC420004B0201

3

DS201

DS201 A type, B characteristic

Function: protection of end user single-phase circuits against overload and short-circuit currents; protection against the effects of sinusoidal alternating and direct pulsating earth fault currents; protection against indirect contact and additional protection against direct contact ($I_{\Delta n}=30$ mA).

Application: residential, commercial, industrial.

Standard: IEC/EN 61009

$I_{cn}=6$ kA

Number of poles	Rated residual current In mA	Rated current In A	Bbn 8012542 EAN	Order details		Price 1 piece	Weight 1 piece kg	Pack unit pc.	
				Type code	Order code				
1+N	10	10	995708	DS201 B10 A10	2CSR255140R0105		0.240	5	
		13	995807	DS201 B13 A10	2CSR255140R0135		0.240	5	
		16	995906	DS201 B16 A10	2CSR255140R0165		0.240	5	
	30		6	638506	DS201 B6 A30	2CSR255140R1065		0.240	5
			10	647805	DS201 B10 A30	2CSR255140R1105		0.240	5
			13	655503	DS201 B13 A30	2CSR255140R1135		0.240	5
			16	655602	DS201 B16 A30	2CSR255140R1165		0.240	5
			20	655701	DS201 B20 A30	2CSR255140R1205		0.240	5
			25	766902	DS201 B25 A30	2CSR255140R1255		0.240	5
			32	814504	DS201 B32 A30	2CSR255140R1325		0.240	5
			40	910602	DS201 B40 A30	2CSR255140R1405		0.240	5
	100		6	990307	DS201 B6 A100	2CSR255140R2065		0.240	5
			10	990406	DS201 B10 A100	2CSR255140R2105		0.240	5
			13	990505	DS201 B13 A100	2CSR255140R2135		0.240	5
			16	990604	DS201 B16 A100	2CSR255140R2165		0.240	5
			20	990703	DS201 B20 A100	2CSR255140R2205		0.240	5
			25	990802	DS201 B25 A100	2CSR255140R2255		0.240	5
			32	990901	DS201 B32 A100	2CSR255140R2325		0.240	5
			40	991007	DS201 B40 A100	2CSR255140R2405		0.240	5
	300		6	991908	DS201 B6 A300	2CSR255140R3065		0.240	5
			10	992004	DS201 B10 A300	2CSR255140R3105		0.240	5
			13	992103	DS201 B13 A300	2CSR255140R3135		0.240	5
			16	992202	DS201 B16 A300	2CSR255140R3165		0.240	5
			20	992301	DS201 B20 A300	2CSR255140R3205		0.240	5
			25	992400	DS201 B25 A300	2CSR255140R3255		0.240	5
			32	992509	DS201 B32 A300	2CSR255140R3325		0.240	5
			40	992608	DS201 B40 A300	2CSR255140R3405		0.240	5

Where to find more:

Worldwide Marks and Approvals p.11/92
 Technical guide of RCDs (code 2CSC420004B0201)



Frequently asked question - FAQ:

A complete list of answers is available in the RCDs FAQ document (code 2CSC420005B0201)



Maybe you are also interested in:

Auxiliary Elements for RCDs p.4/4
 Accessories for RCDs p.4/16
 Busbar Systems p.4/21

RCBOs

DS201 series 6000 A type, C characteristic



DS201

DS201 A type, C characteristic

Function: protection of end user single-phase circuits against overload and short-circuit currents; protection against the effects of sinusoidal alternating and direct pulsating earth fault currents; protection against indirect contact and additional protection against direct contact ($I_{\Delta n}=30$ mA).

Application: residential, commercial, industrial.

Standard: IEC/EN 61009

I_{cn}=6 kA

3

Number of poles	Rated residual current I _{Δn} mA	Rated current I _n A	Bbn 8012542 EAN	Order details		Price 1 piece	Weight 1 piece kg	Pack unit pc.	
				Type code	Order code				
1+N	10	10	996002	DS201 C10 A10	2CSR255140R0104		0.240	5	
		13	996101	DS201 C13 A10	2CSR255140R0134		0.240	5	
		16	996200	DS201 C16 A10	2CSR255140R0164		0.240	5	
	30		2	123958	DS201 C2 A30	2CSR255140R1024		0.240	5
			4	942306	DS201 C4 A30	2CSR255140R1044		0.240	5
			6	942405	DS201 C6 A30	2CSR255140R1064		0.240	5
			8	124054	DS201 C8 A30	2CSR255140R1084		0.240	5
			10	952503	DS201 C10 A30	2CSR255140R1104		0.240	5
			13	976004	DS201 C13 A30	2CSR255140R1134		0.240	5
			16	976103	DS201 C16 A30	2CSR255140R1164		0.240	5
			20	976202	DS201 C20 A30	2CSR255140R1204		0.240	5
			25	976301	DS201 C25 A30	2CSR255140R1254		0.240	5
			32	990109	DS201 C32 A30	2CSR255140R1324		0.240	5
			40	990208	DS201 C40 A30	2CSR255140R1404		0.240	5
			100		6	991106	DS201 C6 A100	2CSR255140R2064	
	10	991205			DS201 C10 A100	2CSR255140R2104		0.240	5
	13	991304			DS201 C13 A100	2CSR255140R2134		0.240	5
	16	991403			DS201 C16 A100	2CSR255140R2164		0.240	5
	20	991502			DS201 C20 A100	2CSR255140R2204		0.240	5
	25	991601			DS201 C25 A100	2CSR255140R2254		0.240	5
	32	991700			DS201 C32 A100	2CSR255140R2324		0.240	5
	40	991809			DS201 C40 A100	2CSR255140R2404		0.240	5
	300		2	124153	DS201 C2 A300	2CSR255140R3024		0.240	5
			4	124252	DS201 C4 A300	2CSR255140R3044		0.240	5
			6	992707	DS201 C6 A300	2CSR255140R3064		0.240	5
			8	124351	DS201 C8 A300	2CSR255140R3084		0.240	5
			10	992806	DS201 C10 A300	2CSR255140R3104		0.240	5
			13	992905	DS201 C13 A300	2CSR255140R3134		0.240	5
			16	993001	DS201 C16 A300	2CSR255140R3164		0.240	5
			20	993100	DS201 C20 A300	2CSR255140R3204		0.240	5
25			993209	DS201 C25 A300	2CSR255140R3254		0.240	5	
32			993308	DS201 C32 A300	2CSR255140R3324		0.240	5	
40			993407	DS201 C40 A300	2CSR255140R3404		0.240	5	

RCBOs

DS201 series 6000 A type, K characteristic



2CSC420004B0201

3

DS201

DS201 A type, K characteristic

Function: protection of end user single-phase circuits against overload and short-circuit currents; protection against the effects of sinusoidal alternating and direct pulsating earth fault currents; protection against indirect contact and additional protection against direct contact (I Δ n=30 mA).

Application: residential, commercial, industrial.

Standard: IEC/EN 60947-2

Icn=6 kA

Number of poles	Rated residual current In mA	Rated current In A	Bbn 8012542 EAN	Order details		Price 1 piece	Weight 1 piece kg	Pack unit pc.	
				Type code	Order code				
1+N	10	10	996309	DS201 K10 A10	2CSR255140R0107		0.240	5	
		13	996408	DS201 K13 A10	2CSR255140R0137		0.240	5	
		16	996507	DS201 K16 A10	2CSR255140R0167		0.240	5	
	30		1	993506	DS201 K1 A30	2CSR255140R1017		0.240	5
			2	993605	DS201 K2 A30	2CSR255140R1027		0.240	5
			4	993704	DS201 K4 A30	2CSR255140R1047		0.240	5
			6	993803	DS201 K6 A30	2CSR255140R1067		0.240	5
			8	123750	DS201 K8 A30	2CSR255140R1087		0.240	5
			10	993902	DS201 K10 A30	2CSR255140R1107		0.240	5
			13	994008	DS201 K13 A30	2CSR255140R1137		0.240	5
			16	994107	DS201 K16 A30	2CSR255140R1167		0.240	5
			20	994206	DS201 K20 A30	2CSR255140R1207		0.240	5
			25	994305	DS201 K25 A30	2CSR255140R1257		0.240	5
			32	994404	DS201 K32 A30	2CSR255140R1327		0.240	5
			40	994503	DS201 K40 A30	2CSR255140R1407		0.240	5
	300		1	994602	DS201 K1 A300	2CSR255140R3017		0.240	5
			2	994701	DS201 K2 A300	2CSR255140R3027		0.240	5
			4	994800	DS201 K4 A300	2CSR255140R3047		0.240	5
			6	994909	DS201 K6 A300	2CSR255140R3067		0.240	5
			8	123859	DS201 K8 A300	2CSR255140R3087		0.240	5
			10	995005	DS201 K10 A300	2CSR255140R3107		0.240	5
			13	995104	DS201 K13 A300	2CSR255140R3137		0.240	5
			16	995203	DS201 K16 A300	2CSR255140R3167		0.240	5
			20	995302	DS201 K20 A300	2CSR255140R3207		0.240	5
			25	995401	DS201 K25 A300	2CSR255140R3257		0.240	5
			32	995500	DS201 K32 A300	2CSR255140R3327		0.240	5
			40	995609	DS201 K40 A300	2CSR255140R3407		0.240	5

Where to find more:

Worldwide Marks and Approvals p.11/92
 Technical guide of RCDs (code 2CSC420004B0201)



Frequently asked question - FAQ:

A complete list of answers is available in the RCDs FAQ document (code 2CSC420005B0201)



Maybe you are also interested in:

Auxiliary Elements for RCDs p.4/4
 Accessories for RCDs p.4/16
 Busbar Systems p.4/21

RCBOs

DS201 M series 10000 AC type, B characteristic



DS201 M AC type, B characteristic

Function: protection of end user single-phase circuits against overload and short-circuit currents; protection against the effects of sinusoidal alternating earth fault currents; protection against indirect contact and additional protection against direct contact ($I_{\Delta n}=30$ mA).

Application: residential, commercial, industrial.

Standard: IEC/EN 61009

$I_{cn}=10$ kA

3

Number of poles	Rated residual current $I_{\Delta n}$ mA	Rated current In A	Bbn 8012542 EAN	Order details		Price 1 piece	Weight 1 piece kg	Pack unit pc.	
				Type code	Order code				
1+N	30	6	998907	DS201 M B6 AC30	2CSR275040R1065		0.240	5	
		10	999003	DS201 M B10 AC30	2CSR275040R1105		0.240	5	
		13	999102	DS201 M B13 AC30	2CSR275040R1135		0.240	5	
		16	999201	DS201 M B16 AC30	2CSR275040R1165		0.240	5	
		20	999300	DS201 M B20 AC30	2CSR275040R1205		0.240	5	
		25	999409	DS201 M B25 AC30	2CSR275040R1255		0.240	5	
		32	999508	DS201 M B32 AC30	2CSR275040R1325		0.240	5	
		40	999607	DS201 M B40 AC30	2CSR275040R1405		0.240	5	
	100	30	6	106159	DS201 M B6 AC100	2CSR275040R2065		0.240	5
			10	106258	DS201 M B10 AC100	2CSR275040R2105		0.240	5
			13	106357	DS201 M B13 AC100	2CSR275040R2135		0.240	5
			16	106456	DS201 M B16 AC100	2CSR275040R2165		0.240	5
			20	106555	DS201 M B20 AC100	2CSR275040R2205		0.240	5
			25	106654	DS201 M B25 AC100	2CSR275040R2255		0.240	5
			32	106753	DS201 M B32 AC100	2CSR275040R2325		0.240	5
			40	106852	DS201 M B40 AC100	2CSR275040R2405		0.240	5
	300	30	6	107750	DS201 M B6 AC300	2CSR275040R3065		0.240	5
			10	107859	DS201 M B10 AC300	2CSR275040R3105		0.240	5
			13	107958	DS201 M B13 AC300	2CSR275040R3135		0.240	5
			16	108054	DS201 M B16 AC300	2CSR275040R3165		0.240	5
			20	108153	DS201 M B20 AC300	2CSR275040R3205		0.240	5
			25	108252	DS201 M B25 AC300	2CSR275040R3255		0.240	5
			32	108351	DS201 M B32 AC300	2CSR275040R3325		0.240	5
			40	108450	DS201 M B40 AC300	2CSR275040R3405		0.240	5

RCBOs

DS201 M series AC type, C characteristic



2CSC420004B0201

DS201 M AC type, C characteristic

Function: protection of end user single-phase circuits against overload and short-circuit currents; protection against the effects of sinusoidal alternating earth fault currents; protection against indirect contact and additional protection against direct contact ($I_{\Delta n}=30$ mA).

Application: residential, commercial, industrial.

Standard: IEC/EN 61009

$I_{cn}=10$ kA

Number of poles	Rated residual current $I_{\Delta n}$ mA	Rated current In A	Bbn 8012542 EAN	Order details		Price 1 piece	Weight 1 piece kg	Pack unit pc.	
				Type code	Order code				
1+N	30	6	999706	DS201 M C6 AC30	2CSR275040R1064		0.240	5	
		10	999805	DS201 M C10 AC30	2CSR275040R1104		0.240	5	
		13	999904	DS201 M C13 AC30	2CSR275040R1134		0.240	5	
		16	105657	DS201 M C16 AC30	2CSR275040R1164		0.240	5	
		20	105756	DS201 M C20 AC30	2CSR275040R1204		0.240	5	
		25	105855	DS201 M C25 AC30	2CSR275040R1254		0.240	5	
		32	105954	DS201 M C32 AC30	2CSR275040R1324		0.240	5	
		40	106050	DS201 M C40 AC30	2CSR275040R1404		0.240	5	
	100	100	6	106951	DS201 M C6 AC100	2CSR275040R2064		0.240	5
			10	107057	DS201 M C10 AC100	2CSR275040R2104		0.240	5
			13	107156	DS201 M C13 AC100	2CSR275040R2134		0.240	5
			16	107255	DS201 M C16 AC100	2CSR275040R2164		0.240	5
			20	107354	DS201 M C20 AC100	2CSR275040R2204		0.240	5
			25	107453	DS201 M C25 AC100	2CSR275040R2254		0.240	5
			32	107552	DS201 M C32 AC100	2CSR275040R2324		0.240	5
			40	107651	DS201 M C40 AC100	2CSR275040R2404		0.240	5
	300	300	6	108559	DS201 M C6 AC300	2CSR275040R3064		0.240	5
			10	108658	DS201 M C10 AC300	2CSR275040R3104		0.240	5
			13	108757	DS201 M C13 AC300	2CSR275040R3134		0.240	5
			16	108856	DS201 M C16 AC300	2CSR275040R3164		0.240	5
			20	108955	DS201 M C20 AC300	2CSR275040R3204		0.240	5
			25	109051	DS201 M C25 AC300	2CSR275040R3254		0.240	5
			32	109150	DS201 M C32 AC300	2CSR275040R3324		0.240	5
			40	109259	DS201 M C40 AC300	2CSR275040R3404		0.240	5

Where to find more:

Worldwide Marks and Approvals
p.11/92
Technical guide of RCDs (code
2CSC420004B0201)



Frequently asked question - FAQ:

A complete list of answers is available
in the RCDs FAQ document (code
2CSC420005B0201)



Maybe you are also interested in:

Auxiliary Elements for RCDs p.4/4
Accessories for RCDs p.4/16
Busbar Systems p.4/21

RCBOs

DS201 T series 6000 A type, B, C and K characteristics



DS201 T

DS201 T A type

Function: protection of end user single-phase circuits against overload and short-circuit currents; protection against the effects of sinusoidal alternating and direct pulsating earth fault currents; protection against indirect contact and additional protection against direct contact ($I_{\Delta n}=30$ mA). DS201 T range is able to meet the most strict requirements for railway application in the rolling stock traction business.

Application: railway, rolling stock, traction.

Standard: IEC/EN 61009

I_{cn} =6 kA

3

B characteristic

Number of poles	Rated residual current $I_{\Delta n}$ mA	Rated current In A	Bbn 8012542 EAN	Order details		Price 1 piece	Weight 1 piece kg	Pack unit pc.
				Type code	Order code			
1+N	30	6		DS201T B6 A30	2CSR255148R1065		0.240	1
		10		DS201T B10 A30	2CSR255148R1105		0.240	1
		13		DS201T B13 A30	2CSR255148R1135		0.240	1
		16		DS201T B16 A30	2CSR255148R1165		0.240	1
		20		DS201T B20 A30	2CSR255148R1205		0.240	1
		25		DS201T B25 A30	2CSR255148R1255		0.240	1
		32		DS201T B32 A30	2CSR255148R1325		0.240	1
		40		DS201T B40 A30	2CSR255148R1405		0.240	1

C characteristic

Number of poles	Rated residual current $I_{\Delta n}$ mA	Rated current In A	Bbn 8012542 EAN	Order details		Price 1 piece	Weight 1 piece kg	Pack unit pc.
				Type code	Order code			
1+N	30	6	001430	DS201T C6 A30	2CSR255148R1064		0.240	1
		10	001331	DS201T C10 A30	2CSR255148R1104		0.240	1
		13	001232	DS201T C13 A30	2CSR255148R1134		0.240	1
		16	629832	DS201T C16 A30	2CSR255148R1164		0.240	1
		20	648437	DS201T C20 A30	2CSR255148R1204		0.240	1
		25	648338	DS201T C25 A30	2CSR255148R1254		0.240	1
		32	297031	DS201T C32 A30	2CSR255148R1324		0.240	1
		40	953234	DS201T C40 A30	2CSR255148R1404		0.240	1

K characteristic

Number of poles	Rated residual current $I_{\Delta n}$ mA	Rated current In A	Bbn 8012542 EAN	Order details		Price 1 piece	Weight 1 piece kg	Pack unit pc.
				Type code	Order code			
1+N	30	6	959434	DS201T K6 A30	2CSR255148R1067		0.240	1
		10	959137	DS201T K10 A30	2CSR255148R1107		0.240	1
		13	958833	DS201T K13 A30	2CSR255148R1137		0.240	1
		16	958536	DS201T K16 A30	2CSR255148R1167		0.240	1
		20	960539	DS201T K20 A30	2CSR255148R1207		0.240	1
		25	960331	DS201T K25 A30	2CSR255148R1257		0.240	1
		32	960133	DS201T K32 A30	2CSR255148R1327		0.240	1
		40	959731	DS201T K40 A30	2CSR255148R1407		0.240	1

RCBOs

DS201 M series 10000 APR type, C characteristic



3

DS201 M

DS201 M APR type, C characteristic

Function: protection against the effects of sinusoidal alternating and direct pulsating earth fault currents, providing an optimal compromise between safety and continuity of service, thanks to the resistance to unwanted tripping; protection against indirect contact and additional protection against direct contact ($I_{\Delta n}=30$ mA); protection and isolation of resistive and inductive loads.

Application: residential, commercial, industrial.

Standard: IEC/EN 61009

$I_{cn}=10$ kA

Number of poles	Rated residual current $I_{\Delta n}$ mA	Rated current In A	Bbn 8012542 EAN	Order details		Price 1 piece	Weight 1 piece kg	Pack unit pc.	
				Type code	Order code				
1+N	30	6	114154	DS201 M C6 APR30	2CSR275440R1064		0.240	5	
		10	114253	DS201 M C10 APR30	2CSR275440R1104		0.240	5	
		13	114352	DS201 M C13 APR30	2CSR275440R1134		0.240	5	
		16	114451	DS201 M C16 APR30	2CSR275440R1164		0.240	5	
		20	114550	DS201 M C20 APR30	2CSR275440R1204		0.240	5	
		25	114659	DS201 M C25 APR30	2CSR275440R1254		0.240	5	
		32	114758	DS201 M C32 APR30	2CSR275440R1324		0.240	5	
		40	114857	DS201 M C40 APR30	2CSR275440R1404		0.240	5	
	100	100	6	127253	DS201 M C6 APR100	2CSR275440R2064		0.240	5
			10	127352	DS201 M C10 APR100	2CSR275440R2104		0.240	5
			13	127451	DS201 M C13 APR100	2CSR275440R2134		0.240	5
			16	127550	DS201 M C16 APR100	2CSR275440R2164		0.240	5
			20	127659	DS201 M C20 APR100	2CSR275440R2204		0.240	5
			25	127758	DS201 M C25 APR100	2CSR275440R2254		0.240	5
			32	127857	DS201 M C32 APR100	2CSR275440R2324		0.240	5
			40	127956	DS201 M C40 APR100	2CSR275440R2404		0.240	5
	300	300	6	114956	DS201 M C6 APR300	2CSR275440R3064		0.240	5
			10	115052	DS201 M C10 APR300	2CSR275440R3104		0.240	5
			13	115151	DS201 M C13 APR300	2CSR275440R3134		0.240	5
			16	115250	DS201 M C16 APR300	2CSR275440R3164		0.240	5
			20	115359	DS201 M C20 APR300	2CSR275440R3204		0.240	5
			25	115458	DS201 M C25 APR300	2CSR275440R3254		0.240	5
			32	115557	DS201 M C32 APR300	2CSR275440R3324		0.240	5
			40	115656	DS201 M C40 APR300	2CSR275440R3404		0.240	5

Where to find more:

Worldwide Marks and Approvals p.11/92
 Technical guide of RCDs (code 2CSC420004B0201)



Frequently asked question - FAQ:

A complete list of answers is available in the RCDs FAQ document (code 2CSC420005B0201)



Maybe you are also interested in:

Auxiliary Elements for RCDs p.4/4
 Accessories for RCDs p.4/16
 Busbar Systems p.4/21

RCBOs

DS201 M series 10000 A type, B characteristic



DS201 M A type, B characteristic

Function: protection of end user single-phase circuits against overload and short-circuit currents; protection against the effects of sinusoidal alternating and direct pulsating earth fault currents; protection against indirect contact and additional protection against direct contact ($I_{\Delta n}=30$ mA).

Application: residential, commercial, industrial.

Standard: IEC/EN 61009

$I_{cn}=10$ kA

3

Number of poles	Rated residual current $I_{\Delta n}$ mA	Rated current I_n A	Bbn 8012542 EAN	Order details		Price 1 piece	Weight 1 piece kg	Pack unit pc.
				Type code	Order code			
1+N	10	10	124450	DS201 M B10 A10	2CSR275140R0105		0.240	5
		16	124559	DS201 M B16 A10	2CSR275140R0165		0.240	5
	30	6	109358	DS201 M B6 A30	2CSR275140R1065		0.240	5
		10	109457	DS201 M B10 A30	2CSR275140R1105		0.240	5
		13	109556	DS201 M B13 A30	2CSR275140R1135		0.240	5
		16	109655	DS201 M B16 A30	2CSR275140R1165		0.240	5
		20	109754	DS201 M B20 A30	2CSR275140R1205		0.240	5
		25	109853	DS201 M B25 A30	2CSR275140R1255		0.240	5
		32	109952	DS201 M B32 A30	2CSR275140R1325		0.240	5
		40	110057	DS201 M B40 A30	2CSR275140R1405		0.240	5
	100	6	111054	DS201 M B6 A100	2CSR275140R2065		0.240	5
		10	111153	DS201 M B10 A100	2CSR275140R2105		0.240	5
		13	111252	DS201 M B13 A100	2CSR275140R2135		0.240	5
		16	111351	DS201 M B16 A100	2CSR275140R2165		0.240	5
		20	111450	DS201 M B20 A100	2CSR275140R2205		0.240	5
		25	111559	DS201 M B25 A100	2CSR275140R2255		0.240	5
		32	111658	DS201 M B32 A100	2CSR275140R2325		0.240	5
		40	111757	DS201 M B40 A100	2CSR275140R2405		0.240	5
	300	6	112556	DS201 M B6 A300	2CSR275140R3065		0.240	5
		10	112655	DS201 M B10 A300	2CSR275140R3105		0.240	5
		13	112754	DS201 M B13 A300	2CSR275140R3135		0.240	5
		16	112853	DS201 M B16 A300	2CSR275140R3165		0.240	5
		20	112952	DS201 M B20 A300	2CSR275140R3205		0.240	5
		25	113058	DS201 M B25 A300	2CSR275140R3255		0.240	5
		32	113157	DS201 M B32 A300	2CSR275140R3325		0.240	5
		40	113256	DS201 M B40 A300	2CSR275140R3405		0.240	5

RCBOs

DS201 M series 10000 A type, C characteristic



3 DS201 M

DS201 M A type, C characteristic

Function: protection of end user single-phase circuits against overload and short-circuit currents; protection against the effects of sinusoidal alternating and direct pulsating earth fault currents; protection against indirect contact and additional protection against direct contact ($I_{\Delta n}=30$ mA).

Application: residential, commercial, industrial.

Standard: IEC/EN 61009

$I_{cn}=10$ kA

Number of poles	Rated residual current $I_{\Delta n}$ mA	Rated current In A	Bbn 8012542 EAN	Order details		Price 1 piece	Weight 1 piece kg	Pack unit pc.
				Type code	Order code			
1+N	10	10	124658	DS201 M C10 A10	2CSR275140R0104		0.240	5
		16	124757	DS201 M C16 A10	2CSR275140R0164		0.240	5
	30	4	110156	DS201 M C4 A30	2CSR275140R1044		0.240	5
		6	110255	DS201 M C6 A30	2CSR275140R1064		0.240	5
		10	110354	DS201 M C10 A30	2CSR275140R1104		0.240	5
		13	110453	DS201 M C13 A30	2CSR275140R1134		0.240	5
		16	110552	DS201 M C16 A30	2CSR275140R1164		0.240	5
		20	110651	DS201 M C20 A30	2CSR275140R1204		0.240	5
		25	110750	DS201 M C25 A30	2CSR275140R1254		0.240	5
		32	110859	DS201 M C32 A30	2CSR275140R1324		0.240	5
	40	110958	DS201 M C40 A30	2CSR275140R1404		0.240	5	
	100	6	111856	DS201 M C6 A100	2CSR275140R2064		0.240	5
		10	111955	DS201 M C10 A100	2CSR275140R2104		0.240	5
		16	112051	DS201 M C16 A100	2CSR275140R2164		0.240	5
		20	112150	DS201 M C20 A100	2CSR275140R2204		0.240	5
		25	112259	DS201 M C25 A100	2CSR275140R2254		0.240	5
		32	112358	DS201 M C32 A100	2CSR275140R2324		0.240	5
		40	112457	DS201 M C40 A100	2CSR275140R2404		0.240	5
	300	6	113355	DS201 M C6 A300	2CSR275140R3064		0.240	5
		10	113454	DS201 M C10 A300	2CSR275140R3104		0.240	5
		13	113553	DS201 M C13 A300	2CSR275140R3134		0.240	5
		16	113652	DS201 M C16 A300	2CSR275140R3164		0.240	5
		20	113751	DS201 M C20 A300	2CSR275140R3204		0.240	5
		25	113850	DS201 M C25 A300	2CSR275140R3254		0.240	5
		32	113959	DS201 M C32 A300	2CSR275140R3324		0.240	5
		40	114055	DS201 M C40 A300	2CSR275140R3404		0.240	5

Where to find more:

Worldwide Marks and Approvals p.11/92
 Technical guide of RCDs (code 2CSC420004B0201)



Frequently asked question - FAQ:

A complete list of answers is available in the RCDs FAQ document (code 2CSC420005B0201)



Maybe you are also interested in:

Auxiliary Elements for RCDs p.4/4
 Accessories for RCDs p.4/16
 Busbar Systems p.4/21

CMS Current Measurement System. A new level of efficiency and availability.

To minimize energy and downtime costs, CMS offers an unique and highly efficient branch monitoring solution. The ultra-compact CMS sensors can be easily integrated in existing and new installations within power distribution units. This provides an unprecedented transparency of the consumption which increases the energy efficiency and service continuity of the plants. www.abb.com/lowvoltage



3



RCBOs

DS202C technical features



3

DS202 C

	Standards		
Electrical features	Type (wave form of the earth leakage sensed)		
	Poles		
	Rated current I_n		A
	Rated sensitivity $I_{\Delta n}$		A
	Rated voltage U_e		V
	Insulation voltage U_i		V
	Max. operating voltage of circuit test		V
	Min. operating voltage of circuit test		V
	Rated frequency		Hz
	Rated breaking capacity acc. to IEC/EN 61009	ultimate I_{cn}	A
	Rated breaking capacity acc. to IEC/EN 60947-2	ultimate I_{cu}	kA
	2P @230 VAC	service I_{cs}	kA
	Rated residual breaking capacity $I_{\Delta m}$		kA
	Rated impulse withstand voltage (1.2/50) U_{imp}		kV
	Dielectric test voltage at ind. freq. for 1 min.		kV
	Thermomagnetic release characteristic	B: $3 I_n \leq I_m \leq 5 I_n$ C: $5 I_n \leq I_m \leq 10 I_n$	
	Surge current resistance (wave 8/20)		A
Mechanical features	Toggle		
	Flag indicators		
	Electrical life		
	Mechanical life		
	Protection degree	housing terminals	
	Environmental conditions (damp heat) acc. to IEC/EN 60068-2-30		°C/RH
	Reference temperature for setting of thermal element		°C
	Ambient temperature (with daily average $\leq +35$ °C)		°C
	Storage temperature		°C
	Installation	Terminal type	top bottom
Terminal size top/bottom for cables			mm ²
Terminal size top/bottom for busbar			mm ²
Tightening torque top/bottom			Nm
Mounting Connection			
Dimensions and weight	Dimensions (H x D x W)		mm
	Weight		g
Combination with auxiliary elements	Combinable with:		
			auxiliary contact
			signal contact
			shunt trip undervoltage release

DS202C	DS202C M
IEC / EN 61009	
A	A
2P	APR
$6 \leq I_n \leq 32$	
0.03-0.3	0.01-0.03-0.3
230-240	0.03-0.3
500	
254	
110	
50...60	
6000	10000
10	10
6	7.5
6	6
4	
2.5	
■	■
■	■
250 (3000 for APR versions)	
black sealable in ON-OFF position	
differential trip indicator (blue)	
contact position indicator (green/red)	
10000	
20000	
IP4X	
IP2X	
28 cycles with 55°C/90-96% and 25°C/95-100%	
30	
-25...+55	
-40...+70	
failsafe bi-directional cylinder-lift terminal at top and bottom (shock protected)	
failsafe bi-directional cylinder-lift terminal at top and bottom (shock protected)	
25/25	
10/10	
2.8	
on DIN rail EN 60715 (35 mm) by means of fast clip device	
from top and bottom	
85 x 69 x 35	
239	
yes	
yes	
yes	
yes	

3

RCBOs

DS202C series 6000 A type, B characteristic



3

DS202C

DS202C A type, B characteristic

Function: protection of end user single-phase circuits against overload and short-circuit currents; protection against the effects of sinusoidal alternating and direct pulsating earth fault currents; protection against indirect contact and additional protection against direct contact ($I_{\Delta n}=30$ mA).

Application: residential, commercial, industrial.

Standard: IEC/EN 61009

$I_{cn}=6$ kA

Number of poles	Rated residual current $I_{\Delta n}$ mA	Rated current In A	Bbn 8012542 EAN	Order details		Price 1 piece	Weight 1 piece kg	Pack unit pc.
				Type code	Order code			
2	30	6	132257	DS202C B6 A30	2CSR252140R1065		0.240	5
		10	132356	DS202C B10 A30	2CSR252140R1105		0.240	5
		13	132455	DS202C B13 A30	2CSR252140R1135		0.240	5
		16	132554	DS202C B16 A30	2CSR252140R1165		0.240	5
		20	132653	DS202C B20 A30	2CSR252140R1205		0.240	5
		25	132752	DS202C B25 A30	2CSR252140R1255		0.240	5
		32	132851	DS202C B32 A30	2CSR252140R1325		0.240	5
	300	6	132950	DS202C B6 A300	2CSR252140R3065		0.240	5
		10	133056	DS202C B10 A300	2CSR252140R3105		0.240	5
		13	133155	DS202C B13 A300	2CSR252140R3135		0.240	5
		16	133254	DS202C B16 A300	2CSR252140R3165		0.240	5
		20	133353	DS202C B20 A300	2CSR252140R3205		0.240	5
		25	133452	DS202C B25 A300	2CSR252140R3255		0.240	5
		32	133551	DS202C B32 A300	2CSR252140R3325		0.240	5

Where to find more:

Worldwide Marks and Approvals
p.11/92
Technical guide of RCDs (code
2CSC420004B0201)



Frequently asked question - FAQ:

A complete list of answers is available
in the RCDs FAQ document (code
2CSC420005B0201)



Maybe you are also interested in:

Auxiliary Elements for RCDs p.4/4
Accessories for RCDs p.4/16
Busbar Systems p.4/21

RCBOs

DS202C series 6000 A type, C characteristic



DS202C A type, C characteristic

Function: protection of end user single-phase circuits against overload and short-circuit currents; protection against the effects of sinusoidal alternating and direct pulsating earth fault currents; protection against indirect contact and additional protection against direct contact ($I_{\Delta n}=30$ mA).

Application: residential, commercial, industrial.

Standard: IEC/EN 61009

Icn=6 kA

3

Number of poles	Rated residual current in mA	Rated current in A	Bbn 8012542 EAN	Order details		Price 1 piece	Weight 1 piece kg	Pack unit pc.
				Type code	Order code			
2	30	6	122357	DS202C C6 A30	2CSR252140R1064		0.240	5
		10	122456	DS202C C10 A30	2CSR252140R1104		0.240	5
		13	122555	DS202C C13 A30	2CSR252140R1134		0.240	5
		16	122654	DS202C C16 A30	2CSR252140R1164		0.240	5
		20	122753	DS202C C20 A30	2CSR252140R1204		0.240	5
		25	122852	DS202C C25 A30	2CSR252140R1254		0.240	5
		32	122951	DS202C C32 A30	2CSR252140R1324		0.240	5
	300	6	123057	DS202C C6 A300	2CSR252140R3064		0.240	5
		10	123156	DS202C C10 A300	2CSR252140R3104		0.240	5
		13	123255	DS202C C13 A300	2CSR252140R3134		0.240	5
		16	123354	DS202C C16 A300	2CSR252140R3164		0.240	5
		20	123453	DS202C C20 A300	2CSR252140R3204		0.240	5
		25	123552	DS202C C25 A300	2CSR252140R3254		0.240	5
		32	123651	DS202C C32 A300	2CSR252140R3324		0.240	5

RCBOs

DS202C M series 10000 A type, B characteristic



3 DS202C M

DS202C M A type, B characteristic

Function: protection of end user single-phase circuits against overload and short-circuit currents; protection against the effects of sinusoidal alternating and direct pulsating earth fault currents; protection against indirect contact and additional protection against direct contact ($I\Delta n=30$ mA).

Application: residential, commercial, industrial.

Standard: IEC/EN 61009

$I_{cn}=10$ kA

Number of poles	Rated residual current $I\Delta n$ mA	Rated current In A	Bbn 8012542 EAN	Order details		Price 1 piece	Weight 1 piece kg	Pack unit pc.	
				Type code	Order code				
2	10	10	124856	DS202C M B10 A10	2CSR272140R0105		0.240	5	
		13	117759	DS202C M B13 A10	2CSR272140R0135		0.240	5	
		16	117858	DS202C M B16 A10	2CSR272140R0165		0.240	5	
	30	30	6	118152	DS202C M B6 A30	2CSR272140R1065		0.240	5
			10	118251	DS202C M B10 A30	2CSR272140R1105		0.240	5
			13	118350	DS202C M B13 A30	2CSR272140R1135		0.240	5
			16	118459	DS202C M B16 A30	2CSR272140R1165		0.240	5
			20	118558	DS202C M B20 A30	2CSR272140R1205		0.240	5
			25	118657	DS202C M B25 A30	2CSR272140R1255		0.240	5
	300	300	32	118756	DS202C M B32 A30	2CSR272140R1325		0.240	5
			6	119555	DS202C M B6 A300	2CSR272140R3065		0.240	5
			10	119654	DS202C M B10 A300	2CSR272140R3105		0.240	5
			13	119753	DS202C M B13 A300	2CSR272140R3135		0.240	5
			16	119852	DS202C M B16 A300	2CSR272140R3165		0.240	5
			20	119951	DS202C M B20 A300	2CSR272140R3205		0.240	5
25			120056	DS202C M B25 A300	2CSR272140R3255		0.240	5	
32			120155	DS202C M B32 A300	2CSR272140R3325		0.240	5	

Where to find more:

Worldwide Marks and Approvals p.11/92
 Technical guide of RCDs (code 2CSC420004B0201)



Frequently asked question - FAQ:

A complete list of answers is available in the RCDs FAQ document (code 2CSC420005B0201)



Maybe you are also interested in:

Auxiliary Elements for RCDs p.4/4
 Accessories for RCDs p.4/16
 Busbar Systems p.4/21

RCBOs

DS202C M series 10000 A type, C characteristic



DS202C M

DS202C M A type, C characteristic

Function: protection of end user single-phase circuits against overload and short-circuit currents; protection against the effects of sinusoidal alternating and direct pulsating earth fault currents; protection against indirect contact and additional protection against direct contact ($I_{\Delta n}=30$ mA).

Application: residential, commercial, industrial.

Standard: IEC/EN 61009

$I_{cn}=10$ kA

3

Number of poles	Rated residual current $I_{\Delta n}$ mA	Rated current I_n A	Bbn 8012542 EAN	Order details		Price 1 piece	Weight 1 piece kg	Pack unit pc.	
				Type code	Order code				
2	10	13	117957	DS202C M C13 A10	2CSR272140R0134		0.240	5	
		16	118053	DS202C M C16 A10	2CSR272140R0164		0.240	5	
	30	6	118855	DS202C M C6 A30	2CSR272140R1064		0.240	5	
		10	118954	DS202C M C10 A30	2CSR272140R1104		0.240	5	
		13	119050	DS202C M C13 A30	2CSR272140R1134		0.240	5	
		16	119159	DS202C M C16 A30	2CSR272140R1164		0.240	5	
		20	119258	DS202C M C20 A30	2CSR272140R1204		0.240	5	
		25	119357	DS202C M C25 A30	2CSR272140R1254		0.240	5	
	300	32	119456	DS202C M C32 A30	2CSR272140R1324		0.240	5	
			6	120254	DS202C M C6 A300	2CSR272140R3064		0.240	5
			10	120353	DS202C M C10 A300	2CSR272140R3104		0.240	5
			13	120452	DS202C M C13 A300	2CSR272140R3134		0.240	5
			16	120551	DS202C M C16 A300	2CSR272140R3164		0.240	5
			20	120650	DS202C M C20 A300	2CSR272140R3204		0.240	5
			25	120759	DS202C M C25 A300	2CSR272140R3254		0.240	5
			32	120858	DS202C M C32 A300	2CSR272140R3324		0.240	5

RCBOs

DS202C M series 10000 APR type, B characteristic



3

DS202C M

DS202C M APR type, B characteristic

Function: protection of end user single-phase circuits against overload and short-circuit currents; protection against the effects of sinusoidal alternating and direct pulsating earth fault currents; protection against indirect contact and additional protection against direct contact ($I_{\Delta n}=30$ mA).

Application: residential, commercial, industrial.

Standard: IEC/EN 61009

$I_{cn}=10$ kA

Number of poles	Rated residual current $I_{\Delta n}$ mA	Rated current In A	Bbn 8012542 EAN	Order details		Price 1 piece	Weight 1 piece kg	Pack unit pc.
				Type code	Order code			
2	30	6	120957	DS202C M B6 APR30	2CSR272440R1065		0.240	5
		10	121053	DS202C M B10 APR30	2CSR272440R1105		0.240	5
		13	121152	DS202C M B13 APR30	2CSR272440R1135		0.240	5
		16	121251	DS202C M B16 APR30	2CSR272440R1165		0.240	5
		20	121350	DS202C M B20 APR30	2CSR272440R1205		0.240	5
		25	121459	DS202C M B25 APR30	2CSR272440R1255		0.240	5
		32	121558	DS202C M B32 APR30	2CSR272440R1325		0.240	5
	300	6	124955	DS202C M B6 APR300	2CSR272440R3065		0.240	5
		10	125051	DS202C M B10 APR300	2CSR272440R3105		0.240	5
		13	125150	DS202C M B13 APR300	2CSR272440R3135		0.240	5
		16	125259	DS202C M B16 APR300	2CSR272440R3165		0.240	5
		20	125358	DS202C M B20 APR300	2CSR272440R3205		0.240	5
		25	125457	DS202C M B25 APR300	2CSR272440R3255		0.240	5
		32	125556	DS202C M B32 APR300	2CSR272440R3325		0.240	5

Where to find more:

Worldwide Marks and Approvals
p.11/92
Technical guide of RCDs (code
2CSC420004B0201)



Frequently asked question - FAQ:

A complete list of answers is available
in the RCDs FAQ document (code
2CSC420005B0201)



Maybe you are also interested in:

Auxiliary Elements for RCDs p.4/4
Accessories for RCDs p.4/16
Busbar Systems p.4/21

RCBOs

DS202C M series 10000 APR type, C characteristic



DS202C M

DS202C M APR type, C characteristic

Function: protection of end user single-phase circuits against overload and short-circuit currents; protection against the effects of sinusoidal alternating and direct pulsating earth fault currents; protection against indirect contact and additional protection against direct contact ($I_{\Delta n}=30$ mA).

Application: residential, commercial, industrial.

Standard: IEC/EN 61009

$I_{cn}=10$ kA

3

Number of poles	Rated residual current $I_{\Delta n}$ mA	Rated current In A	Bbn 8012542 EAN	Order details		Price 1 piece	Weight 1 piece kg	Pack unit pc.
				Type code	Order code			
2	30	6	121657	DS202C M C6 APR30	2CSR272440R1064		0.240	5
		10	121756	DS202C M C10 APR30	2CSR272440R1104		0.240	5
		13	121855	DS202C M C13 APR30	2CSR272440R1134		0.240	5
		16	121954	DS202C M C16 APR30	2CSR272440R1164		0.240	5
		20	122050	DS202C M C20 APR30	2CSR272440R1204		0.240	5
		25	122159	DS202C M C25 APR30	2CSR272440R1254		0.240	5
		32	122258	DS202C M C32 APR30	2CSR272440R1324		0.240	5

RCBOs

DS 200 technical features



2CSC400191R0001

3 DS 200

		Standards		
Electrical features	Operating characteristic: type (wave form of the earth leakage sensed)			
	Poles			
	Rated sensitivity $I_{\Delta n}$			A
	Rated current I_n			A
	Rated voltage U_e		2P	V
			3P, 4P	V
	Insulation voltage U_i			V
	Max. operating voltage of circuit test			V
	Min. operating voltage of circuit test			V
	Rated frequency			Hz
	Rated breaking capacity acc. to IEC/EN 61009		ultimate I_{cn}	A
	Rated breaking capacity		ultimate I_{cu}	kA
	acc. to IEC/EN 60947-2 1P+N @230 VAC, 2P, 3P, 4P @400 VAC		service I_{cs}	kA
	Rated residual breaking capacity $I_{\Delta m}$			kA
	Rated impulse withstand voltage (1.2/50) U_{imp}			kV
	Dielectric test voltage at ind. freq. for 1 min.			kV
	Overvoltage category			
Thermomagnetic release characteristic		B: $3 I_n \leq I_m \leq 5 I_n$ C: $5 I_n \leq I_m \leq 10 I_n$ K: $10 I_n \leq I_m \leq 14 I_n$		
Surge current resistance (wave 8/20)			A	
Mechanical features	Toggle		2P, 3P, 4P	
	Electrical life			
	Mechanical life			
	Protection degree		housing terminals	
	Environmental conditions (damp heat) acc. to IEC/EN 60068-2-30			
	Reference temperature for setting of thermal element			
	Ambient temperature (with daily average $\leq +35$ °C)			
Storage temperature			°C	
Installation	Terminal type		top bottom 2P 3P/4P $I_n \leq 40$ A 3P/4P $50 A \leq I_n \leq 63$ A	
	Terminal size top/bottom per cable		2P 3P/4P $I_n \leq 40$ A 3P/4P $50 A \leq I_n \leq 63$ A	
	Tightening torque top/bottom		2P 3P/4P $I_n \leq 40$ A 3P/4P $50 A \leq I_n \leq 63$ A	
	Mounting			
	Connection			
				mm ²
				mm ²
				mm ²
				Nm
				Nm
			Nm	

① Available depending on type and characteristic curve. For 2P RCBOs A type B-C curves up to 32 A, refer to DS202C 2 protected poles RCBOs in only two modules
 ② Prior to connection of aluminium conductors (≥ 4 mm²) ensure that their contact points are cleaned, brushed and coated with grease

DS 200 AC	DS 200 A	DS 200 M AC	DS 200 M A
IEC/EN 61009, IEC/EN 60947-2			
AC	A	AC	A
2P, 3P, 4P			
0.03			
6 ≤ ln ≤ 63 ①			
230-240			
230/400 - 240/415			
500			
254 (440 for 3P and 4P)			
110 (195 for 3P and 4P)			
50...60			
6000	6000	10000	10000
10	10	15	15
7.5	7.5	11.2	11.2
6	6	10	10
6			
2.5			
III, disconnecter abilities			
■	■	■	■
■	■	■	■
	■		
250			
black (MCB) sealable in ON-OFF position + blue (RCD)			
10000			
20000			
IP4X			
IP2X			
28 cycles with 55°C/90-96% and 25°C/95-100%			
30			
-25...+55			
-40...+70			
failsafe bidirectional cylinder-lift terminal (shock protected) ②			
failsafe bidirectional cylinder-lift terminal (shock protected) ②			
cage (shock protected)			
failsafe bidirectional cylinder-lift terminal (shock protected) ②			
(rigid and flexible) up to 25/25			
(rigid and flexible) up to 25/16			
(rigid and flexible) up to 25/25			
2.8/2.8			
2.8/1.2			
2.8/2.8			
on DIN rail EN 60715 (35 mm) by means of fast clip device			
715 (35 mm) by means of fast clip device from top and bottom			

3

RCBOs

DS 200 technical features



3

DS 200

Dimensions and weight	Dimensions (H x D x W)	2P	mm
		3P $I_n \leq 40$ A	mm
		4P $I_n \leq 40$ A	mm
		3P 50 A $\leq I_n \leq 63$ A	mm
		4P 50 A $\leq I_n \leq 63$ A	mm
Weight		2P	g
		3P $I_n \leq 40$ A	g
		4P $I_n \leq 40$ A	g
		3P 50 A $\leq I_n \leq 63$ A	g
		4P 50 A $\leq I_n \leq 63$ A	g
Combination with auxiliary elements	Combinable with:	auxiliary contact	
		signal contact/auxiliary switch	
		shunt trip	
		undervoltage release	

	DS 200 AC	DS 200 A	DS 200 M AC	DS 200 M A
	85 x 69 x 70			
	85 x 69 x 87.5			
	85 x 69 x 105			
	85 x 69 x 122.5			
	85 x 69 x 140			
	475			
	625			
	775			
	775			
	925			
	yes			
	yes			
	yes			
	yes			

3

RCBOs

DS 200 series 6000 - AC type, B characteristic



DS 202



DS 203



DS 204

DS 200 AC type, B characteristic

Function: protection against overload and short-circuit currents; protection against the effects of sinusoidal alternating earth fault currents; protection against indirect contacts and additional protection against direct contacts.

Application: commercial, industrial.

Standard: IEC/EN 61009 and IEC/EN 60947-2

Icn=6 kA

Number of poles	Rated residual current I _{Δn} mA	Rated current In A	Bbn 8012542 EAN	Order details		Price 1 piece	Weight 1 piece kg	Pack unit pc.
				Type code	Order code			
2	30	6	863502	DS202 AC-B6/0.03	2CSR252001R1065		0.440	1
		10	863601	DS202 AC-B10/0.03	2CSR252001R1105		0.440	1
		13	863700	DS202 AC-B13/0.03	2CSR252001R1135		0.440	1
		16	863809	DS202 AC-B16/0.03	2CSR252001R1165		0.440	1
		20	863908	DS202 AC-B20/0.03	2CSR252001R1205		0.440	1
		25	864004	DS202 AC-B25/0.03	2CSR252001R1255		0.440	1
		32	864103	DS202 AC-B32/0.03	2CSR252001R1325		0.440	1
		40	864202	DS202 AC-B40/0.03	2CSR252001R1405		0.440	1
		50 ①	864301	DS202 AC-B50/0.03	2CSR252001R1505		0.440	1
63 ①	864400	DS202 AC-B63/0.03	2CSR252001R1635		0.440	1		

Number of poles	Rated residual current I _{Δn} mA	Rated current In A	Bbn 8012542 EAN	Order details		Price 1 piece	Weight 1 piece kg	Pack unit pc.
				Type code	Order code			
3	30	6	865506	DS203 AC-B6/0.03	2CSR253001R1065		0.610	1
		10	865605	DS203 AC-B10/0.03	2CSR253001R1105		0.610	1
		13	865704	DS203 AC-B13/0.03	2CSR253001R1135		0.610	1
		16	865803	DS203 AC-B16/0.03	2CSR253001R1165		0.610	1
		20	865902	DS203 AC-B20/0.03	2CSR253001R1205		0.610	1
		25	866008	DS203 AC-B25/0.03	2CSR253001R1255		0.610	1
		32	866107	DS203 AC-B32/0.03	2CSR253001R1325		0.610	1
		40	866206	DS203 AC-B40/0.03	2CSR253001R1405		0.610	1
		50 ①	866305	DS203 AC-B50/0.03	2CSR253001R1505		0.650	1
63 ①	866404	DS203 AC-B63/0.03	2CSR253001R1635		0.650	1		

Number of poles	Rated residual current I _{Δn} mA	Rated current In A	Bbn 8012542 EAN	Order details		Price 1 piece	Weight 1 piece kg	Pack unit pc.
				Type code	Order code			
4	30	6	867500	DS204 AC-B6/0.03	2CSR254001R1065		0.780	1
		10	867609	DS204 AC-B10/0.03	2CSR254001R1105		0.780	1
		13	867708	DS204 AC-B13/0.03	2CSR254001R1135		0.780	1
		16	867807	DS204 AC-B16/0.03	2CSR254001R1165		0.780	1
		20	867906	DS204 AC-B20/0.03	2CSR254001R1205		0.780	1
		25	868002	DS204 AC-B25/0.03	2CSR254001R1255		0.780	1
		32	868101	DS204 AC-B32/0.03	2CSR254001R1325		0.780	1
		40	868200	DS204 AC-B40/0.03	2CSR254001R1405		0.780	1
		50 ①	868309	DS204 AC-B50/0.03	2CSR254001R1505		0.825	1
63 ①	868408	DS204 AC-B63/0.03	2CSR254001R1635		0.825	1		

① provided with additional terminals for remote tripping

Where to find more:

Worldwide Marks and Approvals p.11/92
 Technical guide of RCDs (code 2CSC420004B0201)



Frequently asked question - FAQ:

A complete list of answers is available in the RCDs FAQ document (code 2CSC420005B0201)



Maybe you are also interested in:

Auxiliary Elements for RCDs p.4/4
 Accessories for RCDs p.4/16
 Busbar Systems p.4/21

RCBOs

DS 200 series 6000 - AC type, C characteristic



DS 202



DS 203



DS 204

DS 200 AC type, C characteristic

Function: protection against overload and short-circuit currents; protection against the effects of sinusoidal alternating earth fault currents; protection against indirect contacts and additional protection against direct contacts.

Application: commercial, industrial.

Standard: IEC/EN 61009 and IEC/EN 60947-2

Icn=6 kA

3

Number of poles	Rated residual current I _{Δn} mA	Rated current In A	Bbn 8012542 EAN	Order details		Price 1 piece	Weight 1 piece kg	Pack unit pc.
				Type code	Order code			
2	30	6	869504	DS202 AC-C6/0.03	2CSR252001R1064		0.440	1
		10	869603	DS202 AC-C10/0.03	2CSR252001R1104		0.440	1
		13	869702	DS202 AC-C13/0.03	2CSR252001R1134		0.440	1
		16	869801	DS202 AC-C16/0.03	2CSR252001R1164		0.440	1
		20	869900	DS202 AC-C20/0.03	2CSR252001R1204		0.440	1
		25	870005	DS202 AC-C25/0.03	2CSR252001R1254		0.440	1
		32	870104	DS202 AC-C32/0.03	2CSR252001R1324		0.440	1
		40	870203	DS202 AC-C40/0.03	2CSR252001R1404		0.440	1
		50 ^①	870302	DS202 AC-C50/0.03	2CSR252001R1504		0.440	1
		63 ^①	870401	DS202 AC-C63/0.03	2CSR252001R1634		0.440	1

Number of poles	Rated residual current I _{Δn} mA	Rated current In A	Bbn 8012542 EAN	Order details		Price 1 piece	Weight 1 piece kg	Pack unit pc.
				Type code	Order code			
3	30	6	871507	DS203 AC-C6/0.03	2CSR253001R1064		0.610	1
		10	871606	DS203 AC-C10/0.03	2CSR253001R1104		0.610	1
		13	871705	DS203 AC-C13/0.03	2CSR253001R1134		0.610	1
		16	871804	DS203 AC-C16/0.03	2CSR253001R1164		0.610	1
		20	871903	DS203 AC-C20/0.03	2CSR253001R1204		0.610	1
		25	872009	DS203 AC-C25/0.03	2CSR253001R1254		0.610	1
		32	872108	DS203 AC-C32/0.03	2CSR253001R1324		0.610	1
		40	872207	DS203 AC-C40/0.03	2CSR253001R1404		0.610	1
		50 ^①	872306	DS203 AC-C50/0.03	2CSR253001R1504		0.650	1
		63 ^①	872405	DS203 AC-C63/0.03	2CSR253001R1634		0.650	1

Number of poles	Rated residual current I _{Δn} mA	Rated current In A	Bbn 8012542 EAN	Order details		Price 1 piece	Weight 1 piece kg	Pack unit pc.
				Type code	Order code			
4	30	6	873501	DS204 AC-C6/0.03	2CSR254001R1064		0.780	1
		10	873600	DS204 AC-C10/0.03	2CSR254001R1104		0.780	1
		13	873709	DS204 AC-C13/0.03	2CSR254001R1134		0.780	1
		16	873808	DS204 AC-C16/0.03	2CSR254001R1164		0.780	1
		20	873907	DS204 AC-C20/0.03	2CSR254001R1204		0.780	1
		25	874003	DS204 AC-C25/0.03	2CSR254001R1254		0.780	1
		32	874102	DS204 AC-C32/0.03	2CSR254001R1324		0.780	1
		40	874201	DS204 AC-C40/0.03	2CSR254001R1404		0.780	1
		50 ^①	874300	DS204 AC-C50/0.03	2CSR254001R1504		0.825	1
		63 ^①	874409	DS204 AC-C63/0.03	2CSR254001R1634		0.825	1

^① provided with additional terminals for remote tripping

RCBOs

DS 200 series 6000 - A type, B characteristic



DS 202



DS 203



DS 204

DS 200 A type, B characteristic

Function: protection against overload and short-circuit currents; protection against the effects of sinusoidal alternating and direct pulsating earth fault currents; protection against indirect contacts and additional protection against direct contacts.

Application: commercial, industrial.

Standard: IEC/EN 61009 and IEC/EN 60947-2

Icn=6 kA

Number of poles	Rated residual current $I_{\Delta n}$ mA	Rated current In A	Bbn 8012542 EAN	Order details		Price 1 piece	Weight 1 piece kg	Pack unit pc.
				Type code	Order code			
2	30	40	858201	DS202 A-B40/0.03	2CSR252101R1405		0.440	1
		50 ^①	858300	DS202 A-B50/0.03	2CSR252101R1505		0.440	1
		63 ^①	858409	DS202 A-B63/0.03	2CSR252101R1635		0.440	1

Number of poles	Rated residual current $I_{\Delta n}$ mA	Rated current In A	Bbn 8012542 EAN	Order details		Price 1 piece	Weight 1 piece kg	Pack unit pc.
				Type code	Order code			
3	30	6	858508	DS203 A-B6/0.03	2CSR253101R1065		0.610	1
		10	858607	DS203 A-B10/0.03	2CSR253101R1105		0.610	1
		13	858706	DS203 A-B13/0.03	2CSR253101R1135		0.610	1
		16	858805	DS203 A-B16/0.03	2CSR253101R1165		0.610	1
		20	858904	DS203 A-B20/0.03	2CSR253101R1205		0.610	1
		25	859000	DS203 A-B25/0.03	2CSR253101R1255		0.610	1
		32	859109	DS203 A-B32/0.03	2CSR253101R1325		0.610	1
		40	859208	DS203 A-B40/0.03	2CSR253101R1405		0.610	1
		50 ^①	859307	DS203 A-B50/0.03	2CSR253101R1505		0.650	1
63 ^①	859406	DS203 A-B63/0.03	2CSR253101R1635		0.650	1		

Number of poles	Rated residual current $I_{\Delta n}$ mA	Rated current In A	Bbn 8012542 EAN	Order details		Price 1 piece	Weight 1 piece kg	Pack unit pc.
				Type code	Order code			
4	30	6	859505	DS204 A-B6/0.03	2CSR254101R1065		0.780	1
		10	859604	DS204 A-B10/0.03	2CSR254101R1105		0.780	1
		13	859703	DS204 A-B13/0.03	2CSR254101R1135		0.780	1
		16	859802	DS204 A-B16/0.03	2CSR254101R1165		0.780	1
		20	859901	DS204 A-B20/0.03	2CSR254101R1205		0.780	1
		25	860006	DS204 A-B25/0.03	2CSR254101R1255		0.780	1
		32	860105	DS204 A-B32/0.03	2CSR254101R1325		0.780	1
		40	860204	DS204 A-B40/0.03	2CSR254101R1405		0.780	1
		50 ^①	860303	DS204 A-B50/0.03	2CSR254101R1505		0.825	1
63 ^①	860402	DS204 A-B63/0.03	2CSR254101R1635		0.825	1		

^① provided with additional terminals for remote tripping

Where to find more:

Worldwide Marks and Approvals p.11/92
 Technical guide of RCDs (code 2CSC420004B0201)



Frequently asked question - FAQ:

A complete list of answers is available in the RCDs FAQ document (code 2CSC420005B0201)



Maybe you are also interested in:

Auxiliary Elements for RCDs p.4/4
 Accessories for RCDs p.4/16
 Busbar Systems p.4/21

RCBOs

DS 200 series 6000 - A type, C characteristic



DS 202



DS 203



DS 204

DS 200 A type, C characteristic

Function: protection against overload and short-circuit currents; protection against the effects of sinusoidal alternating and direct pulsating earth fault currents; protection against indirect contacts and additional protection against direct contacts.

Application: commercial, industrial.

Standard: IEC/EN 61009 and IEC/EN 60947-2

Icn=6 kA

3

Number of poles	Rated residual current I _{Δn} mA	Rated current In A	Bbn 8012542 EAN	Order details		Price 1 piece	Weight 1 piece kg	Pack unit pc.
				Type code	Order code			
2	30	40	861201	DS202 A-C40/0.03	2CSR252101R1404		0.440	1
		50 [Ⓣ]	861300	DS202 A-C50/0.03	2CSR252101R1504		0.440	1
		63 [Ⓣ]	861409	DS202 A-C63/0.03	2CSR252101R1634		0.440	1

Number of poles	Rated residual current I _{Δn} mA	Rated current In A	Bbn 8012542 EAN	Order details		Price 1 piece	Weight 1 piece kg	Pack unit pc.
				Type code	Order code			
3	30	6	861508	DS203 A-C6/0.03	2CSR253101R1064		0.610	1
		10	861607	DS203 A-C10/0.03	2CSR253101R1104		0.610	1
		13	861706	DS203 A-C13/0.03	2CSR253101R1134		0.610	1
		16	861805	DS203 A-C16/0.03	2CSR253101R1164		0.610	1
		20	861904	DS203 A-C20/0.03	2CSR253101R1204		0.610	1
		25	862000	DS203 A-C25/0.03	2CSR253101R1254		0.610	1
		32	862109	DS203 A-C32/0.03	2CSR253101R1324		0.610	1
		40	862208	DS203 A-C40/0.03	2CSR253101R1404		0.610	1
		50 [Ⓣ]	862307	DS203 A-C50/0.03	2CSR253101R1504		0.650	1
63 [Ⓣ]	862406	DS203 A-C63/0.03	2CSR253101R1634		0.650	1		

Number of poles	Rated residual current I _{Δn} mA	Rated current In A	Bbn 8012542 EAN	Order details		Price 1 piece	Weight 1 piece kg	Pack unit pc.
				Type code	Order code			
4	30	6	862505	DS204 A-C6/0.03	2CSR254101R1064		0.780	1
		10	862604	DS204 A-C10/0.03	2CSR254101R1104		0.780	1
		13	862703	DS204 A-C13/0.03	2CSR254101R1134		0.780	1
		16	862802	DS204 A-C16/0.03	2CSR254101R1164		0.780	1
		20	862901	DS204 A-C20/0.03	2CSR254101R1204		0.780	1
		25	863007	DS204 A-C25/0.03	2CSR254101R1254		0.780	1
		32	863106	DS204 A-C32/0.03	2CSR254101R1324		0.780	1
		40	863205	DS204 A-C40/0.03	2CSR254101R1404		0.780	1
		50 [Ⓣ]	863304	DS204 A-C50/0.03	2CSR254101R1504		0.825	1
63 [Ⓣ]	863403	DS204 A-C63/0.03	2CSR254101R1634		0.825	1		

[Ⓣ] provided with additional terminals for remote tripping

RCBOs

DS 200 series 6000 - A type, K characteristic



DS 202

3

DS 200 A type, K characteristic

Function: protection and control against overloads and short-circuit in systems where motors, transformers and auxiliary circuits are present. Advantages: no unwanted release in case of currents peak up to 8 x I_n, according to the series; thanks to the high sensibility bimetal, the K curve switches offer protection of the sensible elements from overcurrents; they also allow the best protection of cables and lines.

Application: commercial, industrial.

Standard: IEC/EN 60947-2

I_{cn}=6 kA



DS 203



DS 204

Number of poles	Rated residual current I _{Δn} mA	Rated current In A	Bbn 8012542 EAN	Order details		Price 1 piece	Weight 1 piece kg	Pack unit pc.
				Type code	Order code			
2	30	6	930303	DS202 A-K6/0.03	2CSR252101R1067		0.475	1
		10	900702	DS202 A-K10/0.03	2CSR252101R1107		0.475	1
		13	930402	DS202 A-K13/0.03	2CSR252101R1137		0.475	1
		16	930501	DS202 A-K16/0.03	2CSR252101R1167		0.475	1
		20	930600	DS202 A-K20/0.03	2CSR252101R1207		0.475	1
		25	930709	DS202 A-K25/0.03	2CSR252101R1257		0.475	1
		32	930808	DS202 A-K32/0.03	2CSR252101R1327		0.475	1
		40	930907	DS202 A-K40/0.03	2CSR252101R1407		0.475	1
		50 ^①	931003	DS202 A-K50/0.03	2CSR252101R1507		0.475	1
		63 ^①	931102	DS202 A-K63/0.03	2CSR252101R1637		0.475	1

Number of poles	Rated residual current I _{Δn} mA	Rated current In A	Bbn 8012542 EAN	Order details		Price 1 piece	Weight 1 piece kg	Pack unit pc.
				Type code	Order code			
4	30	6	931201	DS204 A-K6/0.03	2CSR254101R1067		0.775	1
		10	931300	DS204 A-K10/0.03	2CSR254101R1107		0.775	1
		13	931409	DS204 A-K13/0.03	2CSR254101R1137		0.775	1
		16	931508	DS204 A-K16/0.03	2CSR254101R1167		0.775	1
		20	931607	DS204 A-K20/0.03	2CSR254101R1207		0.775	1
		25	931706	DS204 A-K25/0.03	2CSR254101R1257		0.775	1
		32	931805	DS204 A-K32/0.03	2CSR254101R1327		0.775	1
		40	931904	DS204 A-K40/0.03	2CSR254101R1407		0.775	1
		50 ^①	932000	DS204 A-K50/0.03	2CSR254101R1507		0.775	1
		63 ^①	932109	DS204 A-K63/0.03	2CSR254101R1637		0.775	1

^① provided with additional terminals for remote tripping

Where to find more:

Worldwide Marks and Approvals p.11/92
 Technical guide of RCDs (code 2CSC420004B0201)



Frequently asked question - FAQ:

A complete list of answers is available in the RCDs FAQ document (code 2CSC420005B0201)



Maybe you are also interested in:

Auxiliary Elements for RCDs p.4/4
 Accessories for RCDs p.4/16
 Busbar Systems p.4/21

RCBOs

DS 200 M series 10000 - AC type, B characteristic



DS 202 M



DS 203 M



DS 204 M

DS 200 M AC type, B characteristic

Function: protection against overload and short-circuit currents; protection against the effects of sinusoidal alternating earth fault currents; protection against indirect contacts and additional protection against direct contacts.

Application: commercial, industrial.

Standard: IEC/EN 61009

Icn=10 kA

3

Number of poles	Rated residual current I _{Δn} mA	Rated current In A	Bbn 8012542 EAN	Order details		Price 1 piece	Weight 1 piece kg	Pack unit pc.
				Type code	Order code			
2	30	6	932208	DS202 M AC-B6/0.03	2CSR272001R1065		0.440	1
		10	932307	DS202 M AC-B10/0.03	2CSR272001R1105		0.440	1
		13	932406	DS202 M AC-B13/0.03	2CSR272001R1135		0.440	1
		16	932505	DS202 M AC-B16/0.03	2CSR272001R1165		0.440	1
		20	932604	DS202 M AC-B20/0.03	2CSR272001R1205		0.440	1
		25	932703	DS202 M AC-B25/0.03	2CSR272001R1255		0.440	1
		32	932802	DS202 M AC-B32/0.03	2CSR272001R1325		0.440	1
		40	932901	DS202 M AC-B40/0.03	2CSR272001R1405		0.440	1
		50 ①	933007	DS202 M AC-B50/0.03	2CSR272001R1505		0.440	1
		63 ①	933106	DS202 M AC-B63/0.03	2CSR272001R1635		0.440	1

Number of poles	Rated residual current I _{Δn} mA	Rated current In A	Bbn 8012542 EAN	Order details		Price 1 piece	Weight 1 piece kg	Pack unit pc.
				Type code	Order code			
3	30	6	933205	DS203 M AC-B6/0.03	2CSR273001R1065		0.610	1
		10	933304	DS203 M AC-B10/0.03	2CSR273001R1105		0.610	1
		13	933403	DS203 M AC-B13/0.03	2CSR273001R1135		0.610	1
		16	933502	DS203 M AC-B16/0.03	2CSR273001R1165		0.610	1
		20	933601	DS203 M AC-B20/0.03	2CSR273001R1205		0.610	1
		25	933700	DS203 M AC-B25/0.03	2CSR273001R1255		0.610	1
		32	933809	DS203 M AC-B32/0.03	2CSR273001R1325		0.610	1
		40	933908	DS203 M AC-B40/0.03	2CSR273001R1405		0.610	1
		50 ①	934004	DS203 M AC-B50/0.03	2CSR273001R1505		0.650	1
		63 ①	934103	DS203 M AC-B63/0.03	2CSR273001R1635		0.650	1

Number of poles	Rated residual current I _{Δn} mA	Rated current In A	Bbn 8012542 EAN	Order details		Price 1 piece	Weight 1 piece kg	Pack unit pc.
				Type code	Order code			
4	30	6	934202	DS204 M AC-B6/0.03	2CSR274001R1065		0.780	1
		10	934301	DS204 M AC-B10/0.03	2CSR274001R1105		0.780	1
		13	934400	DS204 M AC-B13/0.03	2CSR274001R1135		0.780	1
		16	934509	DS204 M AC-B16/0.03	2CSR274001R1165		0.780	1
		20	934608	DS204 M AC-B20/0.03	2CSR274001R1205		0.780	1
		25	934707	DS204 M AC-B25/0.03	2CSR274001R1255		0.780	1
		32	934806	DS204 M AC-B32/0.03	2CSR274001R1325		0.780	1
		40	934905	DS204 M AC-B40/0.03	2CSR274001R1405		0.780	1
		50 ①	935001	DS204 M AC-B50/0.03	2CSR274001R1505		0.825	1
		63 ①	935100	DS204 M AC-B63/0.03	2CSR274001R1635		0.825	1

① provided with additional terminals for remote tripping

RCBOs

DS 200 M series 10000 - AC type, C characteristic



DS 202 M

3



DS 203 M



DS 204 M

DS 200 M AC type, C characteristic

Function: protection against overload and short-circuit currents; protection against the effects of sinusoidal alternating earth fault currents; protection against indirect contacts and additional protection against direct contacts.

Application: commercial, industrial.

Standard: IEC/EN 61009

Icn=10 kA

Number of poles	Rated residual current I _{Δn} mA	Rated current In A	Bbn 8012542 EAN	Order details		Price 1 piece	Weight 1 piece kg	Pack unit pc.
				Type code	Order code			
2	30	6	851509	DS202 M AC-C6/0.03	2CSR272001R1064		0.440	1
		10	851608	DS202 M AC-C10/0.03	2CSR272001R1104		0.440	1
		13	851707	DS202 M AC-C13/0.03	2CSR272001R1134		0.440	1
		16	851806	DS202 M AC-C16/0.03	2CSR272001R1164		0.440	1
		20	851905	DS202 M AC-C20/0.03	2CSR272001R1204		0.440	1
		25	852001	DS202 M AC-C25/0.03	2CSR272001R1254		0.440	1
		32	852100	DS202 M AC-C32/0.03	2CSR272001R1324		0.440	1
		40	852209	DS202 M AC-C40/0.03	2CSR272001R1404		0.440	1
		50 ①	852308	DS202 M AC-C50/0.03	2CSR272001R1504		0.440	1
63 ①	852407	DS202 M AC-C63/0.03	2CSR272001R1634		0.440	1		

Number of poles	Rated residual current I _{Δn} mA	Rated current In A	Bbn 8012542 EAN	Order details		Price 1 piece	Weight 1 piece kg	Pack unit pc.
				Type code	Order code			
3	30	6	852506	DS203 M AC-C6/0.03	2CSR273001R1064		0.610	1
		10	852605	DS203 M AC-C10/0.03	2CSR273001R1104		0.610	1
		13	852704	DS203 M AC-C13/0.03	2CSR273001R1134		0.610	1
		16	852803	DS203 M AC-C16/0.03	2CSR273001R1164		0.610	1
		20	852902	DS203 M AC-C20/0.03	2CSR273001R1204		0.610	1
		25	853008	DS203 M AC-C25/0.03	2CSR273001R1254		0.610	1
		32	853107	DS203 M AC-C32/0.03	2CSR273001R1324		0.610	1
		40	853206	DS203 M AC-C40/0.03	2CSR273001R1404		0.610	1
		50 ①	853305	DS203 M AC-C50/0.03	2CSR273001R1504		0.650	1
63 ①	853404	DS203 M AC-C63/0.03	2CSR273001R1634		0.650	1		

Number of poles	Rated residual current I _{Δn} mA	Rated current In A	Bbn 8012542 EAN	Order details		Price 1 piece	Weight 1 piece kg	Pack unit pc.
				Type code	Order code			
4	30	6	853503	DS204 M AC-C6/0.03	2CSR274001R1064		0.780	1
		10	853602	DS204 M AC-C10/0.03	2CSR274001R1104		0.780	1
		13	853701	DS204 M AC-C13/0.03	2CSR274001R1134		0.780	1
		16	853800	DS204 M AC-C16/0.03	2CSR274001R1164		0.780	1
		20	853909	DS204 M AC-C20/0.03	2CSR274001R1204		0.780	1
		25	854005	DS204 M AC-C25/0.03	2CSR274001R1254		0.780	1
		32	854104	DS204 M AC-C32/0.03	2CSR274001R1324		0.780	1
		40	854203	DS204 M AC-C40/0.03	2CSR274001R1404		0.780	1
		50 ①	854302	DS204 M AC-C50/0.03	2CSR274001R1504		0.825	1
63 ①	854401	DS204 M AC-C63/0.03	2CSR274001R1634		0.825	1		

① provided with additional terminals for remote tripping

Where to find more:
Worldwide Marks and Approvals p.11/92
Technical guide of RCDs (code 2CSC420004B0201)



Frequently asked question - FAQ:
A complete list of answers is available in the RCDs FAQ document (code 2CSC420005B0201)



Maybe you are also interested in:
Auxiliary Elements for RCDs p.4/4
Accessories for RCDs p.4/16
Busbar Systems p.4/21

RCBOs

DS 200 M series 10000 - A type, B characteristic



DS 202 M



DS 203 M



DS 204 M

DS 200 M A type, B characteristic

Function: protection against overload and short-circuit currents; protection against the effects of sinusoidal alternating and direct pulsating earth fault currents; protection against indirect contacts and additional protection against direct contacts.

Application: commercial, industrial.

Standard: IEC/EN 61009

I_{cn}=10 kA

3

Number of poles	Rated residual current I _{Δn} mA	Rated current In A	Bbn 8012542 EAN	Order details		Price 1 piece	Weight 1 piece kg	Pack unit pc.
				Type code	Order code			
2	30	40	846208	DS202 M A-B40/0.03	2CSR272101R1405		0.440	1
		50 ^⓪	846307	DS202 M A-B50/0.03	2CSR272101R1505		0.440	1
		63 ^⓪	846406	DS202 M A-B63/0.03	2CSR272101R1635		0.440	1

Number of poles	Rated residual current I _{Δn} mA	Rated current In A	Bbn 8012542 EAN	Order details		Price 1 piece	Weight 1 piece kg	Pack unit pc.
				Type code	Order code			
3	30	6	846505	DS203 M A-B6/0.03	2CSR273101R1065		0.610	1
		10	846604	DS203 M A-B10/0.03	2CSR273101R1105		0.610	1
		13	846703	DS203 M A-B13/0.03	2CSR273101R1135		0.610	1
		16	846802	DS203 M A-B16/0.03	2CSR273101R1165		0.610	1
		20	846901	DS203 M A-B20/0.03	2CSR273101R1205		0.610	1
		25	847007	DS203 M A-B25/0.03	2CSR273101R1255		0.610	1
		32	847106	DS203 M A-B32/0.03	2CSR273101R1325		0.610	1
		40	847205	DS203 M A-B40/0.03	2CSR273101R1405		0.610	1
		50 ^⓪	847304	DS203 M A-B50/0.03	2CSR273101R1505		0.650	1
63 ^⓪	847403	DS203 M A-B63/0.03	2CSR273101R1635		0.650	1		

Number of poles	Rated residual current I _{Δn} mA	Rated current In A	Bbn 8012542 EAN	Order details		Price 1 piece	Weight 1 piece kg	Pack unit pc.
				Type code	Order code			
4	30	6	847502	DS204 M A-B6/0.03	2CSR274101R1065		0.780	1
		10	847601	DS204 M A-B10/0.03	2CSR274101R1105		0.780	1
		13	847700	DS204 M A-B13/0.03	2CSR274101R1135		0.780	1
		16	847809	DS204 M A-B16/0.03	2CSR274101R1165		0.780	1
		20	847908	DS204 M A-B20/0.03	2CSR274101R1205		0.780	1
		25	848004	DS204 M A-B25/0.03	2CSR274101R1255		0.780	1
		32	848103	DS204 M A-B32/0.03	2CSR274101R1325		0.780	1
		40	848202	DS204 M A-B40/0.03	2CSR274101R1405		0.780	1
		50 ^⓪	848301	DS204 M A-B50/0.03	2CSR274101R1505		0.825	1
63 ^⓪	848400	DS204 M A-B63/0.03	2CSR274101R1635		0.825	1		

^⓪ provided with additional terminals for remote tripping

RCBOs

DS 200 M series 10000 - A type, C characteristic



DS 202 M

3



DS 203 M



DS 204 M



DS 200 M A type, C characteristic



Function: protection against overload and short-circuit currents; protection against the effects of sinusoidal alternating and direct pulsating earth fault currents; protection against indirect contacts and additional protection against direct contacts.

Application: commercial, industrial.

Standard: IEC/EN 61009

Icn=10 kA

Number of poles	Rated residual current $I_{\Delta n}$ mA	Rated current In A	Bbn 8012542		Order details		Price 1 piece	Weight 1 piece kg	Pack unit pc.
			EAN	Type code	Order code				
2	30	40	849209	DS202 M A-C40/0.03	2CSR272101R1404		0.440	1	
		50 	849308	DS202 M A-C50/0.03	2CSR272101R1504		0.440	1	
		63 	849407	DS202 M A-C63/0.03	2CSR272101R1634		0.440	1	

Number of poles	Rated residual current $I_{\Delta n}$ mA	Rated current In A	Bbn 8012542		Order details		Price 1 piece	Weight 1 piece kg	Pack unit pc.
			EAN	Type code	Order code				
3	30	6	849506	DS203 M A-C6/0.03	2CSR273101R1064		0.610	1	
		10	849605	DS203 M A-C10/0.03	2CSR273101R1104		0.610	1	
		13	849704	DS203 M A-C13/0.03	2CSR273101R1134		0.610	1	
		16	849803	DS203 M A-C16/0.03	2CSR273101R1164		0.610	1	
		20	849902	DS203 M A-C20/0.03	2CSR273101R1204		0.610	1	
		25	850007	DS203 M A-C25/0.03	2CSR273101R1254		0.610	1	
		32	850106	DS203 M A-C32/0.03	2CSR273101R1324		0.610	1	
		40	850205	DS203 M A-C40/0.03	2CSR273101R1404		0.610	1	
		50 	850304	DS203 M A-C50/0.03	2CSR273101R1504		0.650	1	
63 	850403	DS203 M A-C63/0.03	2CSR273101R1634		0.650	1			

Number of poles	Rated residual current $I_{\Delta n}$ mA	Rated current In A	Bbn 8012542		Order details		Price 1 piece	Weight 1 piece kg	Pack unit pc.
			EAN	Type code	Order code				
4	30	6	850502	DS204 M A-C6/0.03	2CSR274101R1064		0.780	1	
		10	850601	DS204 M A-C10/0.03	2CSR274101R1104		0.780	1	
		13	850700	DS204 M A-C13/0.03	2CSR274101R1134		0.780	1	
		16	850809	DS204 M A-C16/0.03	2CSR274101R1164		0.780	1	
		20	850908	DS204 M A-C20/0.03	2CSR274101R1204		0.780	1	
		25	851004	DS204 M A-C25/0.03	2CSR274101R1254		0.780	1	
		32	851103	DS204 M A-C32/0.03	2CSR274101R1324		0.780	1	
		40	851202	DS204 M A-C40/0.03	2CSR274101R1404		0.780	1	
		50 	851301	DS204 M A-C50/0.03	2CSR274101R1504		0.825	1	
63 	851400	DS204 M A-C63/0.03	2CSR274101R1634		0.825	1			

 provided with additional terminals for remote tripping

Where to find more:

Worldwide Marks and Approvals
p.11/92
Technical guide of RCDs (code
2CSC420004B0201)



Frequently asked question - FAQ:

A complete list of answers is available
in the RCDs FAQ document (code
2CSC420005B0201)



Maybe you are also interested in:

Auxiliary Elements for RCDs p.4/4
Accessories for RCDs p.4/16
Busbar Systems p.4/21

Is it possible to switch off AC/DC? Certainly.

The S 200 M UC impresses with its performance range and the accordingly large amount of approvals. Its high inbuilt short circuit breaking capacity across the entire model line, its flexible application for both direct and alternating currents and its approval and compliance in accordance with all major international and local standards make it truly unique. The miniature circuit breaker is a valuable addition to the existing System pro M compact® range which allows all known components to be combined effortlessly with the new model line. Whether warehousing and project engineering, planning and installation or maintaining your equipment, the S 200 M UC is a simple and flexible solution. For more information, see www.abb.com



3



RCD-blocks

DDA 800 technical features



DDA 800

2CSC400177F0201

3

		Standards		
Electrical features	Type (wave form of the earth leakage sensed)			
	Poles			
	Rated current I _n		A	
	Rated sensitivity I _{Δn}		A	
	Rated voltage U _e		V	
	Insulation voltage U _i		V	
	Max. operating voltage of circuit test		V	
	Min. operating voltage of circuit test		V	
	Rated frequency		Hz	
	Rated breaking capacity (I _{cn}) acc. to IEC /EN 60947-2		A	
	Rated residual breaking capacity I _{Δm}	with S 800 C		kA
		with S 800 N		kA
		with S 800 S		kA
	Rated impulse withstand voltage (1.2/50) U _{imp}		kV	
	Dielectric test voltage at ind. freq. for 1 min.		kV	
Surge current resistance (wave 8/20)		A		
Mechanical features	Toggle			
	Electrical life			
	Mechanical life			
	Protection degree	housing		
		terminals		
	Environmental conditions (damp heat) acc. to IEC/EN 60068-2-30		°C/RH	
	Ambient temperature (with daily average ≤ +35 °C)		°C	
	Storage temperature		°C	
	Terminal size for cables	flexible		mm ²
		rigid		mm ²
Tightening torque		Nm		
Mounting				
Dimensions and weight	Dimensions (H x D x W)	2P	mm	
		3P	mm	
		4P	mm	
	Weight	2P	g	
		3P	g	
4P		g		
Combination with MCBs	Combinable with:	S 800 N		
		S 800 S		

* only on 3P and 4P versions

DDA 800 AC	DDA 800 A		DDA 800 A AP-R	DDA 800 A S	
IEC/EN 60947-2 Ann. B					
AC	A		A	A	
2P, 3P, 4P					
63	63	100	63-100	63	100
0.03-0.3	0.03-0.3-0.5	0.3-0.5	0.03	0.3-1	0.3-0.5*-1
230/400 - 240/415 - 400/690					
690					
690					
195					
50...60					
according to the breaking capacity of the associated MCB					
according to the Icu of the associated MCB					
according to the Icu of the associated MCB					
according to the Icu of the associated MCB					
6					
2.5					
250			3000	5000	
blue operating just from OFF position					
10000					
20000					
IP4X					
IP2X					
28 cycles with 55°C/90-96% and 25°C/95-100%					
-25...+60					
-40...+70					
6...50					
6...70					
min. 3 / max. 4					
on DIN rail EN 60715 (35 mm) by means of rapid fixing device					
108.2 x 82.3 x 81					
108.2 x 82.3 x 117					
108.2 x 82.3 x 117					
300 for 63 A - 415 for 100 A					
400 for 63 A - 640 for 100 A					
460 for 63 A - 765 for 100 A					
yes					
yes					

3

RCD-blocks

DDA 800 AC type for MCBs S800



DDA 802

3



DDA 803



DDA 804

DDA 800 AC type for MCBs S800

Function: RCD-block for assembly on site with MCBs S800 series up to 63 A. Protection against the effects of sinusoidal alternating earth fault currents; protection against indirect contacts and additional protection against direct contacts (with $I_{\Delta n}=30$ mA).

Application: commercial, industrial.

Standard: IEC/EN 60947-2 Ann. B

Number of poles	Rated residual current $I_{\Delta n}$ mA	Rated current In A	Bbn 8012542 EAN	Order details		Price 1 piece	Weight 1 piece kg	Pack unit pc.
				Type code	Order code			
2	30	63	919704	DDA802AC-63/0.03	2CSB802001R1630		0.300	1
	300	63	919902	DDA802AC-63/0.3	2CSB802001R3630			

Number of poles	Rated residual current $I_{\Delta n}$ mA	Rated current In A	Bbn 8012542 EAN	Order details		Price 1 piece	Weight 1 piece kg	Pack unit pc.
				Type code	Order code			
3	30	63	922001	DDA803AC-63/0.03	2CSB803001R1630		0.400	1
	300	63	922209	DDA803AC-63/0.3	2CSB803001R3630			

Number of poles	Rated residual current $I_{\Delta n}$ mA	Rated current In A	Bbn 8012542 EAN	Order details		Price 1 piece	Weight 1 piece kg	Pack unit pc.
				Type code	Order code			
4	30	63	924401	DDA804AC-63/0.03	2CSB804001R1630		0.460	1
	300	63	924609	DDA804AC-63/0.3	2CSB804001R3630			

Where to find more:
Technical guide of RCDs (code 2CSC420004B0201)



Frequently asked question - FAQ:
A complete list of answers is available in the RCDs FAQ document 1 (code 2CSC420005B0201)



Maybe you are also interested in:
Auxiliary Elements and Accessories for S800 and DDA 800 p.4/62

RCD-blocks

DDA 800 A type for MCBs S800



DDA 802



DDA 803



DDA 804

DDA 800 A type for MCBs S800

Function: RCD-block for assembly on site with MCBs S800 up to 100 A. Protection against the effects of sinusoidal alternating and direct pulsating earth fault currents; protection against indirect contacts and additional protection against direct contacts (with $I_n=30$ mA).

Application: commercial, industrial.

Standard: IEC/EN 60947-2 Ann. B

3

Number of poles	Rated residual current In mA	Rated current In A	Bbn 8012542 EAN	Order details		Price 1 piece	Weight 1 piece kg	Pack unit pc.
				Type code	Order code			
2	30	63	920007	DDA802 A-63/0.03	2CSB802101R1630		0.300	1
	300	63	920205	DDA802 A-63/0.3	2CSB802101R3630		0.300	1
		100	545033	DDA802 A-100/0.3	2CSB802101R3000		0.415	1
	500	63	920403	DDA802 A-63/0.5	2CSB802101R4630		0.300	1
100		542636	DDA802 A-100/0.5	2CSB802101R4000		0.415	1	

Number of poles	Rated residual current In mA	Rated current In A	Bbn 8012542 EAN	Order details		Price 1 piece	Weight 1 piece kg	Pack unit pc.
				Type code	Order code			
3	30	63	922308	DDA803 A-63/0.03	2CSB803101R1630		0.400	1
	300	63	922506	DDA803 A-63/0.3	2CSB803101R3630		0.400	1
		100	544135	DDA803 A-100/0.3	2CSB803101R3000		0.640	1
	500	63	922704	DDA803 A-63/0.5	2CSB803101R4630		0.400	1
100		541738	DDA803 A-100/0.5	2CSB803101R4000		0.640	1	

Number of poles	Rated residual current In mA	Rated current In A	Bbn 8012542 EAN	Order details		Price 1 piece	Weight 1 piece kg	Pack unit pc.
				Type code	Order code			
4	30	63	924807	DDA804 A-63/0.03	2CSB804101R1630		0.460	1
	300	63	925002	DDA804 A-63/0.3	2CSB804101R3630		0.460	1
		100	547532	DDA804 A-100/0.3	2CSB804101R3000		0.765	1
	500	63	925200	DDA804 A-63/0.5	2CSB804101R4630		0.460	1
100		544937	DDA804 A-100/0.5	2CSB804101R4000		0.765	1	

RCD-blocks

DDA 800 A type AP-R (high immunity) for MCBs S800



DDA 802

3



DDA 803



DDA 804

DDA 800 A AP-R type for MCBs S800

Function: RCD-block for assembly on site with MCBs S800 up to 100 A. Protection against the effects of sinusoidal alternating and direct pulsating earth fault currents, providing the best compromise between safety and continuity in the service thanks to the resistance to unwanted trippings; protection against indirect contacts and additional protection against direct contacts (with $I_{\Delta n}=30$ mA).

Application: commercial, industrial.

Standard: IEC/EN 60947-2 Ann. B

Number of poles	Rated residual current $I_{\Delta n}$ mA	Rated current In A	Bbn 8012542 EAN	Order details		Price 1 piece	Weight 1 piece kg	Pack unit pc.
				Type code	Order code			
2	30	63	921400	DDA802 A-63/0.03 AP-R	2CSB802401R1630		0.300	1
		100	544630	DDA802 A-100/0.03 AP-R	2CSB802401R1000		0.415	1

Number of poles	Rated residual current $I_{\Delta n}$ mA	Rated current In A	Bbn 8012542 EAN	Order details		Price 1 piece	Weight 1 piece kg	Pack unit pc.
				Type code	Order code			
3	30	63	923800	DDA803 A-63/0.03 AP-R	2CSB803401R1630		0.400	1
		100	542230	DDA803 A-100/0.03 AP-R	2CSB803401R1000		0.640	1

Number of poles	Rated residual current $I_{\Delta n}$ mA	Rated current In A	Bbn 8012542 EAN	Order details		Price 1 piece	Weight 1 piece kg	Pack unit pc.
				Type code	Order code			
4	30	63	927709	DDA804 A-63/0.03 AP-R	2CSB804401R1630		0.460	1
		100	547136	DDA804 A-100/0.03 AP-R	2CSB804401R1000		0.765	1

Where to find more:

Technical guide of RCDs (code 2CSC420004B0201)



Frequently asked question - FAQ:

A complete list of answers is available in the RCDs FAQ document t (code 2CSC420005B0201)



Maybe you are also interested in:

Auxiliary Elements and Accessories for S800 and DDA 800 p.4/62

RCD-blocks

DDA 800 A type selective for MCBs S800



DDA 802



DDA 803



DDA 804

DDA 800 A selective type for MCBs S800

Function: RCD-block for assembly on site with MCBs S800 series up to 100 A. Protection against the effects of sinusoidal alternating and direct pulsating earth fault currents with an intentional tripping delay, which permits to realize the selectivity with downstream instantaneous devices (for more information about selectivity see the technical guide).

Application: commercial, industrial.

Standard: IEC/EN 60947-2 Ann. B

3

Number of poles	Rated residual current In mA	Rated current In A	Bbn 8012542 EAN	Order details		Price 1 piece	Weight 1 piece kg	Pack unit pc.
				Type code	Order code			
2	300	63	920601	DDA802 A S-63/0.3	2CSB802201R3630		0.300	1
		100	542537	DDA802 A S-100/0.3	2CSB802201R3000		0.415	1
	1000	63	920809	DDA802 A S-63/1	2CSB802201R5630		0.300	1
		100	547433	DDA802 A S-100/1	2CSB802201R5000		0.415	1

Number of poles	Rated residual current In mA	Rated current In A	Bbn 8012542 EAN	Order details		Price 1 piece	Weight 1 piece kg	Pack unit pc.
				Type code	Order code			
3	300	63	922902	DDA803 A S-63/0.3	2CSB803201R3630		0.400	1
		100	544838	DDA803 A S-100/0.3	2CSB803201R3000		0.640	1
	500	100	542438	DDA803 A S-100/0.5	2CSB803201R4000		0.640	1
		1000	63	923206	DDA803 A S-63/1	2CSB803201R5630		0.400
			100	547334	DDA803 A S-100/1	2CSB803201R5000		0.640

Number of poles	Rated residual current In mA	Rated current In A	Bbn 8012542 EAN	Order details		Price 1 piece	Weight 1 piece kg	Pack unit pc.
				Type code	Order code			
4	300	63	926207	DDA804 A S-63/0.3	2CSB804201R3630		0.460	1
		100	544739	DDA804 A S-100/0.3	2CSB804201R3000		0.765	1
	500	100	542339	DDA804 A S-100/0.5	2CSB804201R4000		0.765	1
		1000	63	926504	DDA804 A S-63/1	2CSB804201R5630		0.460
			100	547235	DDA804 A S-100/1	2CSB804201R5000		0.765

RCBOs

DS800S technical features



























DS800S

3

		Standards		
Electrical features	Operating characteristic: type (wave form of the earth leakage sensed)			
	Poles			
	Rated sensitivity $I_{\Delta n}$			A
	Rated current I_n			A
	Rated voltage U_e			V
	Insulation voltage U_i			V
	Max. operating voltage of circuit test			V
	Min. operating voltage of circuit test			V
	Rated frequency			Hz
	Short-circuit breaking capacity ultimate I_{cu}			240/415 V kA
	acc. to IEC/EN 60947-2			254/440 V kA
	(AC) 50/60 Hz			289/500 V kA
	Short-circuit breaking capacity service I_{cs}			400/690 V kA
	acc. to IEC/EN 60947-2			240/415 V kA
	(AC) 50/60 Hz			254/440 V kA
	Rated impulse withstand voltage (1.2/50) U_{imp}			289/500 V kA
	Dielectric test voltage at ind. freq. for 1 min.			400/690 V kA
	Thermomagnetic release characteristic			kV
				kV
				B: $3 I_n \leq I_m \leq 5 I_n$
			C: $5 I_n \leq I_m \leq 10 I_n$	
			D: $10 I_n \leq I_m \leq 20 I_n$	
			K: $8 I_n \leq I_m \leq 14 I_n$	
Surge current resistance acc. to VDE 0432 Part 2 (wave 8/20)			A	
Mechanical features	Toggle			
	Electrical life			
	Mechanical life			
	Protection degree			housing terminals
	Environmental conditions (damp heat) acc. to IEC/EN 60068-2-30			°C/RH
	Ambient temperature (with daily average $\leq + 35$ °C)			°C
Installation	Storage temperature			°C
	Terminal size for cables			flexible mm ² rigid mm ²
	Tightening torque			Nm
	Mounting			
Dimensions and weight	Dimensions (H x D x W)			2P mm 3P mm 4P mm
	Weight			2P g 3P g 4P g
	Combination with auxiliary elements			auxiliary contact signal contact/auxiliary switch shunt trip undervoltage release

(*) 1A on 2P and 4P versions, while 0.3A only on 4P ones.

	DS800S A	DS800N A	DS800S A S	DS800N A S	DS800S A AP-R	DS800N A AP-R
IEC/EN 60947-2						
A			A		A	
2P, 3P, 4P			2P,4P		2P, 3P, 4P	
0.3			0.3-1(*)		0.03	
125						
230/400-240/415-400/690						
690						
690						
195						
50...60						
50	36		50	36	50	36
30	20		30	20	30	20
10	10		10	10	10	10
4.5	4.5		4.5	4.5	4.5	4.5
40	30		40	30	40	30
15	10		15	10	15	10
5	5		5	5	5	5
3	3		3	3	3	3
6						
2.5						
						
						
						
						
250	250		5000	5000	3000	3000
black (MCB) sealable in ON-OFF position + blue (RCD) operating just from OFF position						
10000						
20000						
IP4X						
IP2X						
28 cycles with 55°C/90-96% and 25°C/95-100%						
-25...+60						
-40...+70						
6...50						
6...70						
min. 3 / max. 4						
on DIN rail EN 60715 (35 mm) by means of rapid fixing device						
108,2 x 82,3 x 133.5						
108,2 x 82,3 x 196						
108,2 x 82,3 x 223						
790						
1140						
1440						
yes						
yes						
yes						
yes						

3

RCBOs

DS800S series 50000 A type B, C, D and K characteristics



DS802S



DS803S



DS804S

DS800S, A type

Function: protection against overload and short-circuit currents; protection against the effects of sinusoidal alternating earth fault currents; protection against indirect contacts; command and isolation of resistive and inductive loads.

Application: industrial.

Standard: IEC/EN 60947-2

Icu=50 kA

Number of poles	Curve	Rated residual current In mA	Rated current In A	Bbn 7612271 EAN	Order details		Price 1 piece	Weight 1 piece kg	Pack unit pc.
					Type code	Order code			
2	B	300	125	211721	DS802S-B125/0.3A	2CCA862005R0845		0.790	1
	C	300	125	211738	DS802S-C125/0.3A	2CCA862005R0844		0.790	1
	D	300	125	211745	DS802S-D125/0.3A	2CCA862005R0841		0.790	1
	K	300	125	211752	DS802S-K125/0.3A	2CCA862005R0647		0.790	1

Number of poles	Curve	Rated residual current In mA	Rated current In A	Bbn 7612271 EAN	Order details		Price 1 piece	Weight 1 piece kg	Pack unit pc.
					Type code	Order code			
3	B	300	125	211769	DS803S-B125/0.3A	2CCA863005R0845		1.14	1
	C	300	125	211776	DS803S-C125/0.3A	2CCA863005R0844		1.14	1
	D	300	125	211783	DS803S-D125/0.3A	2CCA863005R0841		1.14	1
	K	300	125	211790	DS803S-K125/0.3A	2CCA863005R0647		1.14	1

Number of poles	Curve	Rated residual current In mA	Rated current In A	Bbn 7612271 EAN	Order details		Price 1 piece	Weight 1 piece kg	Pack unit pc.
					Type code	Order code			
4	B	300	125	211806	DS804S-B125/0.3A	2CCA864005R0845		1.44	1
	C	300	125	211813	DS804S-C125/0.3A	2CCA864005R0844		1.44	1
	D	300	125	211820	DS804S-D125/0.3A	2CCA864005R0841		1.44	1
	K	300	125	211837	DS804S-K125/0.3A	2CCA864005R0647		1.44	1

RCBOs

DS800N series 36000 A type B, C and D characteristics



DS802N



DS803N



DS804N

DS800N, A type

Function: protection against overload and short-circuit currents; protection against the effects of sinusoidal alternating earth fault currents; protection against indirect contacts; command and isolation of resistive and inductive loads.

Application: industrial.

Standard: IEC/EN 60947-2

Icu=36 kA

3

Number of poles	Curve	Rated residual current I Δ n mA	Rated current In A	Bbn 7612271 EAN	Order details		Price 1 piece	Weight 1 piece kg	Pack unit pc.
					Type code	Order code			
2	B	300	125	211844	DS802N-B125/0.3A	2CCA892005R0845		0.790	1
	C	300	125	211851	DS802N-C125/0.3A	2CCA892005R0844		0.790	1
	D	300	125	211868	DS802N-D125/0.3A	2CCA892005R0841		0.790	1

Number of poles	Curve	Rated residual current I Δ n mA	Rated current In A	Bbn 7612271 EAN	Order details		Price 1 piece	Weight 1 piece kg	Pack unit pc.
					Type code	Order code			
3	B	300	125	211875	DS803N-B125/0.3A	2CCA893005R0845		1.14	1
	C	300	125	211882	DS803N-C125/0.3A	2CCA893005R0844		1.14	1
	D	300	125	211899	DS803N-D125/0.3A	2CCA893005R0841		1.14	1

Number of poles	Curve	Rated residual current I Δ n mA	Rated current In A	Bbn 7612271 EAN	Order details		Price 1 piece	Weight 1 piece kg	Pack unit pc.
					Type code	Order code			
4	B	300	125	211905	DS804N-B125/0.3A	2CCA894005R0845		1.44	1
	C	300	125	211912	DS804N-C125/0.3A	2CCA894005R0844		1.44	1
	D	300	125	211929	DS804N-D125/0.3A	2CCA894005R0841		1.44	1

RCBOs

DS800S series 50000 A type selective B, C, D and K characteristics



DS802S



DS803S



DS804S

DS800S, A selective type

Function: protection against overload and short-circuit currents; protection against the effects of sinusoidal alternating earth fault currents with an intentional tripping delay, which allows to realize the selectivity with downstream instantaneous devices (for more information about selectivity see the technical guide); protection against indirect contacts; command and isolation of resistive and inductive loads.

Application: industrial.

Standard: IEC/EN 60947-2

Icu=50 kA

Number of poles	Curve	Rated residual current In mA	Rated current In A	Bbn 7612271 EAN	Order details		Price 1 piece	Weight 1 piece kg	Pack unit pc.
					Type code	Order code			
2	B	1000	125	211516	DS802S-B125/1AS	2CCC862006R0845		0.790	1
	C	1000	125	211523	DS802S-C125/1AS	2CCC862006R0844		0.790	1
	D	1000	125	211530	DS802S-D125/1AS	2CCC862006R0841		0.790	1
	K	1000	125	211547	DS802S-K125/1AS	2CCC862006R0647		0.790	1

Number of poles	Curve	Rated residual current In mA	Rated current In A	Bbn 7612271 EAN	Order details		Price 1 piece	Weight 1 piece kg	Pack unit pc.
					Type code	Order code			
4	B	300	125	211554	DS804S-B125/0.3AS	2CCC864005R0845		1.44	1
		1000	125	211592	DS804S-B125/1AS	2CCC864006R0845		1.44	1
	C	300	125	211561	DS804S-C125/0.3AS	2CCC864005R0844		1.44	1
		1000	125	211608	DS804S-C125/1AS	2CCC864006R0844		1.44	1
	D	300	125	211578	DS804S-D125/0.3AS	2CCC864005R0841		1.44	1
		1000	125	211615	DS804S-D125/1AS	2CCC864006R0841		1.44	1
	K	300	125	211685	DS804S-K125/0.3AS	2CCC864005R0647		1.44	1
		1000	125	211622	DS804S-K125/1AS	2CCC864006R0647		1.44	1

RCBOs

DS800N series $\boxed{36000}$ A type selective B, C and D characteristics



DS802N



DS803N



DS804N

DS800N, A selective type

Function: protection against overload and short-circuit currents; protection against the effects of sinusoidal alternating earth fault currents with an intentional tripping delay, which allows to realize the selectivity with downstream instantaneous devices (for more information about selectivity see the technical guide); protection against indirect contacts; command and isolation of resistive and inductive loads.

Application: industrial.

Standard: IEC/EN 60947-2

Icu=36 kA

3

Number of poles	Curve	Rated residual current $I_{\Delta n}$ mA	Rated current I_n A	Bbn 7612271 EAN	Order details		Price 1 piece	Weight 1 piece kg	Pack unit pc.
					Type code	Order code			
2	B	1000	125	211639	DS802N-B125/1AS	2CCC892006R0845		0.790	1
	C	1000	125	211646	DS802N-C125/1AS	2CCC892006R0844		0.790	1
	D	1000	125	211653	DS802N-D125/1AS	2CCC892006R0841		0.790	1

Number of poles	Curve	Rated residual current $I_{\Delta n}$ mA	Rated current I_n A	Bbn 7612271 EAN	Order details		Price 1 piece	Weight 1 piece kg	Pack unit pc.
					Type code	Order code			
4	B	300	125	211660	DS804N-B125/0.3AS	2CCC894005R0845		1.44	1
		1000	125	211691	DS804N-B125/1AS	2CCC894006R0845		1.44	1
	C	300	125	211677	DS804N-C125/0.3AS	2CCC894005R0844		1.44	1
		1000	125	211707	DS804N-C125/1AS	2CCC894006R0844		1.44	1
	D	300	125	211684	DS804N-D125/0.3AS	2CCC894005R0841		1.44	1
		1000	125	211714	DS804N-D125/1AS	2CCC894006R0841		1.44	1

RCBOs

DS800S series 50000 A type, AP-R (high immunity) B, C, D and K characteristics



DS802S

DS800S AP-R, A type

Function: protection against the effects of sinusoidal alternating earth fault currents, providing the best compromise between safety and continuity in the service thanks to the resistance to unwanted trippings; protection against indirect contacts and additional protection against direct contacts ($I_{\Delta n}=30$ mA); protection and isolation of resistive and inductive loads.

Application: industrial.

Standard: IEC/EN 60947-2

Icu=50 kA



DS803S



DS804S

Number of poles	Curve	Rated residual current $I_{\Delta n}$ mA	Rated current In A	Bbn 7612271 EAN	Order details		Price 1 piece	Weight 1 piece kg	Pack unit pc.
					Type code	Order code			
2	B	30	125	211301	DS802SB125/.03AP-R	2CCB862004R0845		0.790	1
	C	30	125	211318	DS802SC125/.03AP-R	2CCB862004R0844		0.790	1
	D	30	125	211325	DS802SD125/.03AP-R	2CCB862004R0841		0.790	1
	K	30	125	211332	DS802SK125/.03AP-R	2CCB862004R0647		0.790	1

Number of poles	Curve	Rated residual current $I_{\Delta n}$ mA	Rated current In A	Bbn 7612271 EAN	Order details		Price 1 piece	Weight 1 piece kg	Pack unit pc.
					Type code	Order code			
3	B	30	125	211349	DS803SB125/.03AP-R	2CCB863004R0845		1.14	1
	C	30	125	211356	DS803SC125/.03AP-R	2CCB863004R0844		1.14	1
	D	30	125	211363	DS803SD125/.03AP-R	2CCB863004R0841		1.14	1
	K	30	125	211370	DS803SK125/.03AP-R	2CCB863004R0647		1.14	1

Number of poles	Curve	Rated residual current $I_{\Delta n}$ mA	Rated current In A	Bbn 7612271 EAN	Order details		Price 1 piece	Weight 1 piece kg	Pack unit pc.
					Type code	Order code			
4	B	30	125	211387	DS804SB125/.03AP-R	2CCB864004R0845		1.44	1
	C	30	125	211394	DS804SC125/.03AP-R	2CCB864004R0844		1.44	1
	D	30	125	211400	DS804SD125/.03AP-R	2CCB864004R0841		1.44	1
	K	30	125	211417	DS804SK125/.03AP-R	2CCB864004R0647		1.44	1

RCBOs

DS800N series $\boxed{36000}$ A type, AP-R (high immunity) B, C and D characteristics



DS802N



DS803N



DS804N

DS800N AP-R, A type

Function: protection against the effects of sinusoidal alternating earth fault currents, providing the best compromise between safety and continuity in the service thanks to the resistance to unwanted trippings; protection against indirect contacts and additional protection against direct contacts ($I_{\Delta n}=30$ mA); protection and isolation of resistive and inductive loads.

Application: industrial.

Standard: IEC/EN 60947-2

Icu=36 kA

3

Number of poles	Curve	Rated residual current $I_{\Delta n}$ mA	Rated current In A	Bbn 7612271 EAN	Order details		Price 1 piece	Weight 1 piece kg	Pack unit pc.
					Type code	Order code			
2	B	30	125	211424	DS802NB125/.03AP-R	2CCB892004R0845		0.790	1
	C	30	125	211431	DS802NC125/.03AP-R	2CCB892004R0844		0.790	1
	D	30	125	211448	DS802ND125/.03AP-R	2CCB892004R0841		0.790	1

Number of poles	Curve	Rated residual current $I_{\Delta n}$ mA	Rated current In A	Bbn 7612271 EAN	Order details		Price 1 piece	Weight 1 piece kg	Pack unit pc.
					Type code	Order code			
3	B	30	125	211455	DS803NB125/.03AP-R	2CCB893004R0845		1.14	1
	C	30	125	211462	DS803NC125/.03AP-R	2CCB893004R0844		1.14	1
	D	30	125	211479	DS803ND125/.03AP-R	2CCB893004R0841		1.14	1

Number of poles	Curve	Rated residual current $I_{\Delta n}$ mA	Rated current In A	Bbn 7612271 EAN	Order details		Price 1 piece	Weight 1 piece kg	Pack unit pc.
					Type code	Order code			
4	B	30	125	211486	DS804NB125/.03AP-R	2CCB894004R0845		1.44	1
	C	30	125	211493	DS804NC125/.03AP-R	2CCB894004R0844		1.44	1
	D	30	125	211509	DS804ND125/.03AP-R	2CCB894004R0841		1.44	1

RCBOs

DS 271 technical features



		Standards	
Electrical features	Type (wave form of the earth leakage sensed)		
	Poles		
	Rated current I_n		A
	Rated sensitivity $I_{\Delta n}$		A
	Rated voltage U_e		V
	Insulation voltage U_i		V
	Max. operating voltage		V
	Min. operating voltage		V
	Rated frequency		Hz
	Rated breaking capacity acc. to IEC/EN 61009	ultimate I_{cn}	kA
	Rated breaking capacity acc. to IEC/EN 60947-2 1P+N @230 VAC, 2P, 3P, 4P @400 VAC	ultimate I_{cu} service I_{cs}	kA
	Rated residual breaking capacity $I_{\Delta m}$		kA
	Rated impulse withstand voltage (1.2/50) U_{imp}		kV
	Dielectric test voltage at ind. freq. for 1 min.		kV
	Thermomagnetic release characteristic	B: $3 I_n \leq I_m \leq 5 I_n$ C: $5 I_n \leq I_m \leq 10 I_n$	
	Surge current resistance (wave 8/20)		A
Mechanical features	Toggle		
	Electrical life		
	Mechanical life		
	Protection degree	housing terminals	
	Environmental conditions (damp heat) acc. to IEC/EN 60068-2-30		°C/RH
	Reference temperature for setting of thermal element		°C
	Ambient temperature (with daily average $\leq +35$ °C)		°C
	Storage temperature		°C
Installation	Terminal type	top bottom	
	Terminal size top/bottom for cables	1P+N line side load side	mm ² mm ² mm ²
	Tightening torque top/bottom	1P+N	Nm
	Mounting		
	Dimensions and weight	Dimensions (H x D x W) Weight	1P+N 1P+N
Combination- with auxiliary- elements	Combinable with:	auxiliary contact signal contact shunt trip undervoltage release	

DS 271 AC	DS 271 A
IEC 61009	
AC	A
1P+N	
$6 \leq I_n \leq 40$	
0.01-0.03-0.1-0.3	
230-240	
500	
254	
85	
50...60	
10	
-	
7.5	
6	
5	
2.5	
■	■
■	■
250	
black sealable in on-off position	
10000	
20000	
IP4X	
IP2X	
28 cycles with 55°C/90-96% and 25°C/95-100%	
30	
-25...+55	
-25...+70	
cage (shock protected)	
cage (shock protected)	
-	
L1: 1 up to 25; N: flexible 4; FE: flexible 0.75	
L1 and N: 1 up to 10	
2 top; 1.2 bottom	
on DIN rail EN 60715 (35 mm) by means of fast clip device	
120 x 67.6 x 17.5	
205	
no	
no	
no	
no	

3

RCBOs

DS 271 series 10000 AC type B and C characteristics



DS 271

DS 271 AC type, B and C characteristics

Function: protection against overload and short-circuit currents; protection against the effects of sinusoidal alternating earth fault currents; protection against indirect contacts and additional protection against direct contacts ($I_{\Delta n}=30$ mA).

Application: residential, commercial, industrial.

Standard: IEC 61009, BSEN61009-2-2

$I_{cn}=10$ kA

Charac- teristics/ curve	Rated residual current $I_{\Delta n}$ mA	Rated current		Bbn 8012542		Order details	Price 1 piece	Weight 1 piece kg	Pack unit pc.
		In A	EAN	Type code	Order code				
B	10	6	036753	DS271 AC-B6/0.01 ELN	2CSR175092R0065		0.205	1	
		10	036852	DS271 AC-B10/0.01 ELN	2CSR175092R0105		0.205	1	
		16	036951	DS271 AC-B16/0.01 ELN	2CSR175092R0165		0.205	1	
		20	037057	DS271 AC-B20/0.01 ELN	2CSR175092R0205		0.205	1	
		25	037156	DS271 AC-B25/0.01 ELN	2CSR175092R0255		0.205	1	
		32	037255	DS271 AC-B32/0.01 ELN	2CSR175092R0325		0.205	1	
	30	6	037354	DS271 AC-B6/0.03 ELN	2CSR175092R1065		0.205	1	
		10	037453	DS271 AC-B10/0.03 ELN	2CSR175092R1105		0.205	1	
		16	037552	DS271 AC-B16/0.03 ELN	2CSR175092R1165		0.205	1	
		20	037651	DS271 AC-B20/0.03 ELN	2CSR175092R1205		0.205	1	
		25	037750	DS271 AC-B25/0.03 ELN	2CSR175092R1255		0.205	1	
		32	037859	DS271 AC-B32/0.03 ELN	2CSR175092R1325		0.205	1/20	

Charac- teristics/ curve	Rated residual current $I_{\Delta n}$ mA	Rated current		Bbn 8012542		Order details	Price 1 piece	Weight 1 piece kg	Pack unit pc.
		In A	EAN	Type code	Order code				
C	10	6	038559	DS271 AC-C6/0.01 ELN	2CSR175092R0064		0.205	1	
		10	038658	DS271 AC-C10/0.01 ELN	2CSR175092R0104		0.205	1	
		16	038757	DS271 AC-C16/0.01 ELN	2CSR175092R0164		0.205	1/20	
		20	038856	DS271 AC-C20/0.01 ELN	2CSR175092R0204		0.205	1	
		25	038955	DS271 AC-C25/0.01 ELN	2CSR175092R0254		0.205	1	
		32	039051	DS271 AC-C32/0.01 ELN	2CSR175092R0324		0.205	1/20	
	30	6	039150	DS271 AC-C6/0.03 ELN	2CSR175092R1064		0.205	1	
		10	039259	DS271 AC-C10/0.03 ELN	2CSR175092R1104		0.205	1	
		16	039358	DS271 AC-C16/0.03 ELN	2CSR175092R1164		0.205	1	
		20	039457	DS271 AC-C20/0.03 ELN	2CSR175092R1204		0.205	1	
		25	039556	DS271 AC-C25/0.03 ELN	2CSR175092R1254		0.205	1	
		32	039655	DS271 AC-C32/0.03 ELN	2CSR175092R1324		0.205	1	
		40	128755	DS271 AC-C40/0.03 ELN	2CSR175092R1404		0.205	1	
		100	6	039754	DS271 AC-C6/0.1 ELN	2CSR175092R2064		0.205	1
	10		039853	DS271 AC-C10/0.1 ELN	2CSR175092R2104		0.205	1/20	
	16		039952	DS271 AC-C16/0.1 ELN	2CSR175092R2164		0.205	1/20	
	20		040057	DS271 AC-C20/0.1 ELN	2CSR175092R2204		0.205	1/20	
	25		040156	DS271 AC-C25/0.1 ELN	2CSR175092R2254		0.205	1	
	32		040255	DS271 AC-C32/0.1 ELN	2CSR175092R2324		0.205	1	
	300	6	040354	DS271 AC-C6/0.3 ELN	2CSR175092R3064		0.205	1	
		10	040453	DS271 AC-C10/0.3 ELN	2CSR175092R3104		0.205	1	
		16	040552	DS271 AC-C16/0.3 ELN	2CSR175092R3164		0.205	1	
		20	040651	DS271 AC-C20/0.3 ELN	2CSR175092R3204		0.205	1	
		25	040750	DS271 AC-C25/0.3 ELN	2CSR175092R3254		0.205	1	
32		040859	DS271 AC-C32/0.3 ELN	2CSR175092R3324		0.205	1		
40		128854	DS271 AC-C40/0.3 ELN	2CSR175092R3404		0.205	1		

Where to find more:

Worldwide Marks and Approvals of RCDs p.11/92
Technical guide of RCDs (code 2CSC420004B0201)



Frequently asked question - FAQ:

A complete list of answers is available in the RCDs FAQ document (code 2CSC420005B0201)



RCBOs

DS 271 series 10000 A type B and C characteristics



DS 271

DS 271 A type, B and C characteristics

Function: protection against overload and short-circuit currents; protection against the effects of sinusoidal alternating and direct pulsating earth fault currents; protection against indirect contacts and additional protection against direct contacts ($I_{\Delta n}=30$ mA).

Application: commercial, industrial.

Standard: IEC 61009, BSEN61009-2-2

$I_{cn}=10$ kA

3

Charac- teristics/ curve	Rated residual current $I_{\Delta n}$ mA	Rated current In A	Bbn 8012542 EAN	Order details		Price 1 piece	Weight 1 piece kg	Pack unit pc.
				Type code	Order code			
B	10	6	032557	DS271 A-B6/0.01 ELN	2CSR175192R0065		0.205	1
		10	032656	DS271 A-B10/0.01 ELN	2CSR175192R0105		0.205	1
		16	032755	DS271 A-B16/0.01 ELN	2CSR175192R0165		0.205	1
		20	032854	DS271 A-B20/0.01 ELN	2CSR175192R0205		0.205	1
		25	032953	DS271 A-B25/0.01 ELN	2CSR175192R0255		0.205	1
		32	033059	DS271 A-B32/0.01 ELN	2CSR175192R0325		0.205	1
	30	6	033158	DS271 A-B6/0.03 ELN	2CSR175192R1065		0.205	1
		10	033257	DS271 A-B10/0.03 ELN	2CSR175192R1105		0.205	1
		16	033356	DS271 A-B16/0.03 ELN	2CSR175192R1165		0.205	1
		20	033455	DS271 A-B20/0.03 ELN	2CSR175192R1205		0.205	1
		25	033554	DS271 A-B25/0.03 ELN	2CSR175192R1255		0.205	1
		32	033653	DS271 A-B32/0.03 ELN	2CSR175192R1325		0.205	1

Charac- teristics/ curve	Rated residual current $I_{\Delta n}$ mA	Rated current In A	Bbn 8012542 EAN	Order details		Price 1 piece	Weight 1 piece kg	Pack unit pc.
				Type code	Order code			
C	10	6	034353	DS271 A-C6/0.01 ELN	2CSR175192R0064		0.205	1
		10	034452	DS271 A-C10/0.01 ELN	2CSR175192R0104		0.205	1
		16	034551	DS271 A-C16/0.01 ELN	2CSR175192R0164		0.205	1
		20	034650	DS271 A-C20/0.01 ELN	2CSR175192R0204		0.205	1
		25	034759	DS271 A-C25/0.01 ELN	2CSR175192R0254		0.205	1
		32	034858	DS271 A-C32/0.01 ELN	2CSR175192R0324		0.205	1
	30	6	034957	DS271 A-C6/0.03 ELN	2CSR175192R1064		0.205	1
		10	035053	DS271 A-C10/0.03 ELN	2CSR175192R1104		0.205	1/20
		16	035152	DS271 A-C16/0.03 ELN	2CSR175192R1164		0.205	1/20
		20	035251	DS271 A-C20/0.03 ELN	2CSR175192R1204		0.205	1/20
		25	035350	DS271 A-C25/0.03 ELN	2CSR175192R1254		0.205	1
		32	035459	DS271 A-C32/0.03 ELN	2CSR175192R1324		0.205	1
		40	128557	DS271 A-C40/0.03 ELN	2CSR175192R1404		0.205	1
		100	6	035558	DS271 A-C6/0.1 ELN	2CSR175192R2064		0.205
	10		035657	DS271 A-C10/0.1 ELN	2CSR175192R2104		0.205	1
	16		035756	DS271 A-C16/0.1 ELN	2CSR175192R2164		0.205	1
	20		035855	DS271 A-C20/0.1 ELN	2CSR175192R2204		0.205	1
	25		035954	DS271 A-C25/0.1 ELN	2CSR175192R2254		0.205	1
	32		036050	DS271 A-C32/0.1 ELN	2CSR175192R2324		0.205	1
	300	6	036159	DS271 A-C6/0.3 ELN	2CSR175192R3064		0.205	1
		10	036258	DS271 A-C10/0.3 ELN	2CSR175192R3104		0.205	1
		16	036357	DS271 A-C16/0.3 ELN	2CSR175192R3164		0.205	1
		20	036456	DS271 A-C20/0.3 ELN	2CSR175192R3204		0.205	1
		25	036555	DS271 A-C25/0.3 ELN	2CSR175192R3254		0.205	1
		32	036654	DS271 A-C32/0.3 ELN	2CSR175192R3324		0.205	1
		40	128656	DS271 A-C40/0.3 ELN	2CSR175192R3404		0.205	1

Residual current relays

RD2



2CSC420004B0201

3

RD2

Technical features		
Operating voltage	[V]	230÷400 a.c. (RD2) and 48÷150 a.c./d.c. (RD2-48)
Frequency	[Hz]	50÷60
Type		A
Operating temperature	[°C]	-5...+40
Power consumption	[W]	<3.4, 230 V a.c.
Sensitivity settings $I_{\Delta n}$	[A]	0.03; 0.1; 0.3; 0.5; 1; 2
Tripping time settings	[s]	Fast (instantaneous); 0.3; 0.5; 1; 2; 5
Contact capacity	[A]	10 at 250 V a.c. (ohmic)
Contact type		NC-C-NO
Modules	[No.]	2
Protection degree		IP20
Standards		IEC/EN 62020

RD2 residual current relays

Residual current relays with external toroidal transformer can detect leakage currents. Through minidip it is possible to set sensitivity and intervention time.

Operating voltage	Bbn 8012542	Order details		Price 1 piece	Weight 1 piece	Pack unit
V	EAN	Type code	Order code		kg	pc.
230...400 a.c.	058007	RD2	2CSM142120R1201		0.125	1
48...150 a.c./d.c.	537809	RD2-48	2CSM242120R1201		0.125	1

Where to find more:

Wiring Diagrams for RD2 p.11/8
Technical guide of RCDs (code
2CSC420004B0201)



Maybe you are also interested in:

Toroidal Transformers p.3/97

Residual current relays

RD3



RD3



RD3M



RD3P

Technical features	RD3/RD3-48	RD3M/RD3M-48	RD3P/RD3P-48
Operating voltage	RD3: 230-400 Vac +10% / -15%	RD3M: 230-400 Vac +10% / -15%	RD3P: 230-400 Vac +10% / -15%
	RD3-48: 12-48 Vac/ Vdc +10% / -15%	RD3M-48: 12-48 Vac/ Vdc +10% / -15%	RD3P-48: 12-48 Vac/ Vdc +10% / -15%
Auxiliary supply frequency	50-60 Hz		
Frequency filter	-	Yes	Yes
Type	A (up to $I_{\Delta n}=5$ A) AC (for higher current)		
Operating temperature	-25...+70 °C		
Power consumption	<3.6 W (RD3, RD3M, RD3P), <600 mW RD3-48, RD3M-48, RD3P-48)		
Sensitivity settings $I_{\Delta n}$	0.03-0.1-0.3-0.5-1-2-3-5-10-30 A		
Tripping time settings Δt	0-0.06-0.2-0.3-0.5-1-2-3-5-10 s		
Pre-alarm threshold	-	60%	60%
Max. resistance connection between toroidal transformer and relay	3 Ω		
Max. length connection of remote reset button	15 m		
Output Contact capacity (7-8-9); (10-11-12)	8 A, 250 V a.c.		
Led bar indicator	-	-	Yes
Max. cable terminals section	2.5 mm ²		
Modules	3		
Dimensions	52.8 × 85 × 64.7 mm		
Protection degree	IP20		
Standards	IEC/EN 60947-2 annex. M		

3

RD3 residual current relays

The RD3 family of electronic residual current relays provides residual current protection and monitoring functions according to IEC/EN 60947-2:2006 annex M and can be used in conjunction with all S 200 automatic devices and Tmax range moulded case devices up to T5, for industrial installations.

The RD3 residual current relays can provide status indications through two output contacts.

Operating voltage	Bbn 8012542	Order details		Price 1 piece	Weight 1 piece	Pack unit
V	EAN	Type code	Order code		kg	pc.
12-48 a.c./d.c.	748236	RD3-48	2CSJ201001R0001		0.13	1
230-400 a.c.	734833	RD3	2CSJ201001R0002		0.25	1
12-48 a.c./d.c.	733935	RD3M-48	2CSJ202001R0001		0.13	1
230-400 a.c.	747031	RD3M	2CSJ202001R0002		0.25	1
12-48 a.c./d.c.	734734	RD3P-48	2CSJ203001R0001		0.13	1
230-400 a.c.	733836	RD3P	2CSJ203001R0002		0.25	1

Where to find more:
Wiring Diagrams for RD3 p.11/9
Technical guide of RCDs (code
2CSC420004B0201)



Frequently asked question - FAQ:
Tripping time, Cumulative time, Non
intervention time for RD3 p.10/159

Maybe you are also interested in:
Toroidal Transformers p.3/97

Front panel residual current relays ELR

Technical features		ELR48P	ELR72	ELR72P	ELR96	ELR96P	ELR96PF	ELR96PD
Operating voltage	[V]	24, 48, 110, 230 a.c./ 24, 48, 115 d.c.	24, 48, 110, 230 a.c./ 24, 48, 110 d.c.	24, 48, 110 230, 400 a.c./ 24, 48 d.c.	24, 48, 110, 230, 400 a.c./ 24, 48 d.c.	24, 48, 110, 230, 400 a.c./ 24, 48 d.c.	110, 230, 400 a.c.	110, 230, 400 a.c.
Frequency	[Hz]	50 – 60						
Frequency filter		-	-	-	-	-	Yes	Yes
Type		A						
Operating temperature	[°C]	-10...+60						
Power consumption	[W]	<7						
Sensitivity setting IΔn	[A]	from 0,03 to 30						
Tripping time setting Dt	[s]	from 0 to 5						
Contacts	[no.]	2	1	2	1	2	2	2
Contact capacity	[A]	5 (250 V a.c.)						
Dimensions	[mm]	48 x 48	72 x 72	72 x 72	96 x 96	96 x 96	96x96	96 x 96
Digital display		-	-	-	-	-	-	Yes
Protection degree (with cover)		IP52						
Protection degree (without cover)		IP40						
Protection degree (terminals)		IP20						
Standards		IEC EN 60947-2 Annex M						

Where to find more:
Wiring Diagrams for ELR p.11/9
Technical guide of RCDs (code
2CSC420004B0201)



Frequently asked question - FAQ:
Tripping time, Cumulative time, Non
intervention time for RD3 p.10/160

Maybe you are also interested in:
Toroidal Transformers p.3/97



ELR48P



ELR72



ELR96



ELR96PD

ELR front panel residual current relay

Front panel residual current relays are electronic devices used in combination with an external toroidal transformer. They are according to the protection standard IEC/EN 60947-2 Annex-M. The sensitivity can be set from 0.03 A to 30 A, while the tripping time from 0 to 5 seconds. Residual current relays are available in versions 48x48 mm, 72x72 mm, and 96x96 mm. The Fail Safe function is available for versions ELR48P, ELR72P and ELR96P: the contacts switch when there is no auxiliary power.

The ELR96PF version is equipped with Fail Safe function, fault memory LED, and a frequency filter, that ensure continuity of service in the presence of harmonics.

ELR96PD has (in addition to these functions) a digital display for an instantaneous view of the residual current $I_{\Delta n}$.

3

Operating voltage	Bbn 8012542	Order details		Price 1 piece	Weight 1 piece	Pack unit
V	EAN	Type code	Order code		kg	pc.
110 V a.c./d.c. - 230 V a.c.	748229	ELR48P	2CSG252211R1202		0.112	1
24-48 V a.c./d.c.	734826	ELR48V24P	2CSG452211R1202		0.112	1
110 V a.c./d.c. - 230 V a.c.	733928	ELR72	2CSG252120R1202		0.322	1
24-48 V a.c./d.c.	747024	ELR72V24	2CSG452120R1202		0.322	1
110-230-400 V a.c.	734727	ELR72P	2CSG152424R1202		0.322	1
24-48 V a.c./d.c.	733829	ELR72V24P	2CSG452424R1202		0.322	1
110-230-400 V a.c.	734628	ELR96	2CSG152130R1202		0.383	1
24-48 V a.c./d.c.	733720	ELR96V24	2CSG452130R1202		0.383	1
110-230-400 V a.c.	734529	ELR96P	2CSG152434R1202		0.383	1
24-48 V a.c./d.c.	733621	ELR96V24P	2CSG452434R1202		0.383	1
110-230-400 V a.c.	734420	ELR96PF	2CSG152435R1202		0.383	1
110-230-400 V a.c.	733522	ELR96PD	2CSG152436R1202		0.383	1

Toroidal transformers

TR



3

TR

Toroidal transformers

Dimension Ø	Bbn 8012542	Order details		Price 1 piece	Weight 1 piece	Pack unit
mm	EAN	Type code	Order code		kg	pc.
29 (modular version)	020707	TRM	2CSM02900R1211		0.170	1
35	020301	TR1	2CSG035100R1211		0.212	1
60	020400	TR2	2CSG060100R1211		0.274	1
80	020509	TR3	2CSG080100R1211		0.454	1
110	020608	TR4	2CSG110100R1211		0.530	1
110 (openable version)	743408	TR4/A	2CSG110200R1211		0.600	1
160	743507	TR160	2CSG160100R1211		1.350	1
160 (openable version)	743606	TR160A	2CSG160200R1211		1.600	1
210	024804	TR5	2CSG210100R1211		1.534	1
210 (openable version)	065708	TR5/A	2CSG210200R1211		1.856	1

Where to find more:

Technical Details for Toroidal Transformers p.10/160

Maybe you are also interested in:

RD2 and RD3 residual current relays

p.3/94

ELR residual current relays p.3/96

System pro *M* compact®

Auxiliary elements and accessories

Index

Selection tables	4/2
Auxiliary elements for MCBs S 200, SN 201, RCDs F 200, DS 200 and Switch Disconnectors SD 200 series	4/8
Accessories for MCBs, RCDs and Switch Disconnectors	4/18
Motor operating and autoreclosing devices for RCDs, MCBs and Switch Disconnectors	4/19
Busbar systems selection table	4/23
Busbars and accessories for MCBs and RCDs	4/24
Auxiliary elements for MCBs S 280 series selection table	4/48
Auxiliary elements for MCBs S 280 and S 280 UC series	4/51
Auxiliary elements for S 700	4/53
Auxiliary elements and accessories for MCBs S800 and RCD-blocks DDA 800 series	4/55
Auxiliary elements for MCBs S500	4/66
UNIFIX rapid wiring system	4/67

Auxiliary elements and accessories for MCBs and RCDs

Selection tables

Combination of auxiliary elements with S 200, DDA 200 + S 200 or DS 200

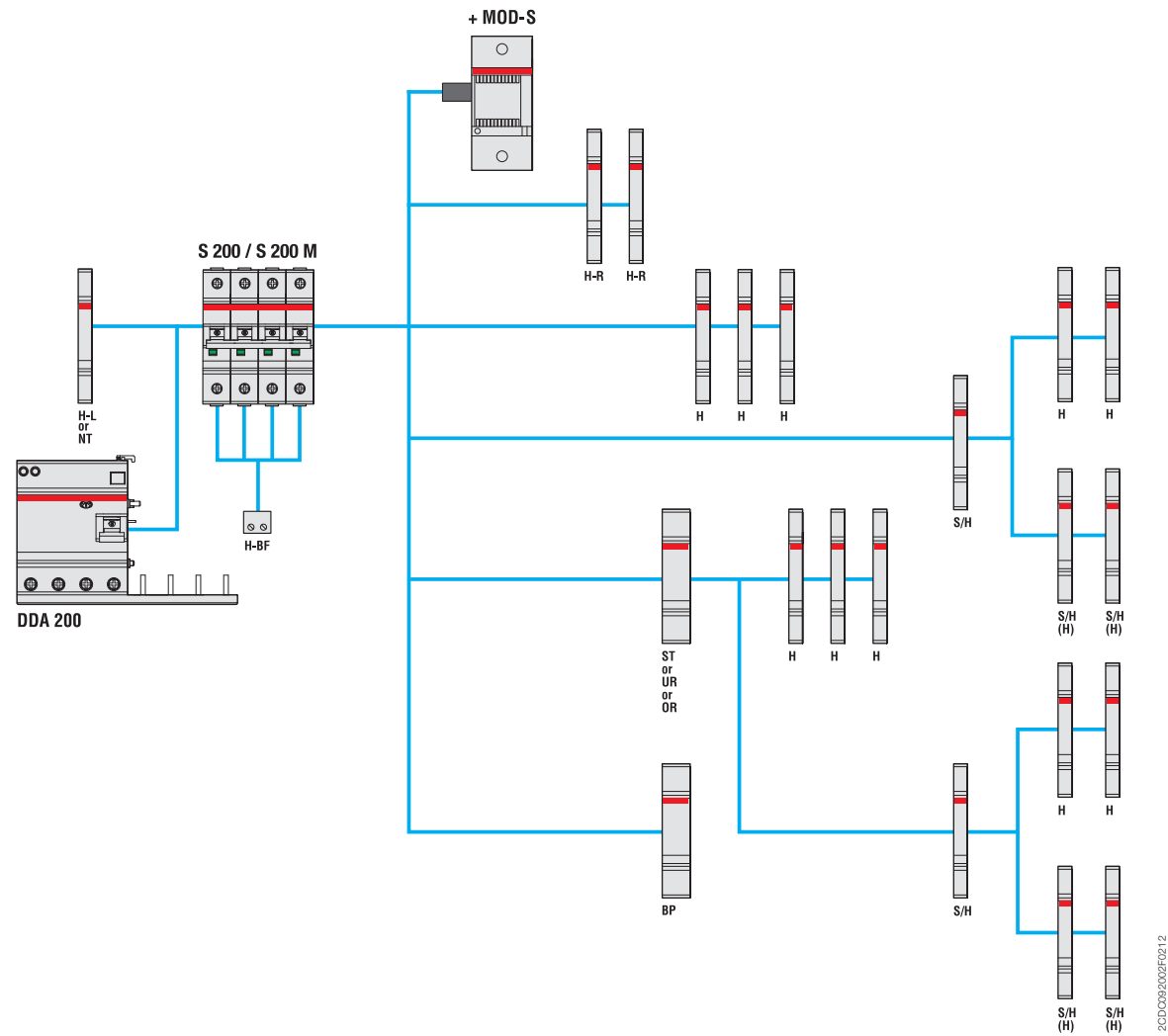

H	Auxiliary contact	S2C-H6R
H-R	Auxiliary contact	S2C-H6-...R
S/H	Signal/Auxiliary contact	S2C-S/H6R
S/H (H)	Signal/Auxiliary contact used as auxiliary contact	S2C-S/H6R
ST	Shunt trip for S 200 MCB	S2C-A...
UR	Undervoltage release	S2C-UA
OR	Overvoltage release	S2C-OVP
H-L	Auxiliary contact for S 200 MCBs to be mounted on the left	S2C-H...L
H-BF	Auxiliary contact for MCBs bottom fitting (1 for each pole of MCB)	S2C-H01/S2C-H10
BP	Mechanical tripping device	S2C-BP
NT	Switched neutral	S2C-Nt

In case of using rotary operating mechanism S2C-DH (only right side mountable) the auxiliary devices left side and bottom fitting auxiliary contact could be used.

Combination of S 200 with motor operating device

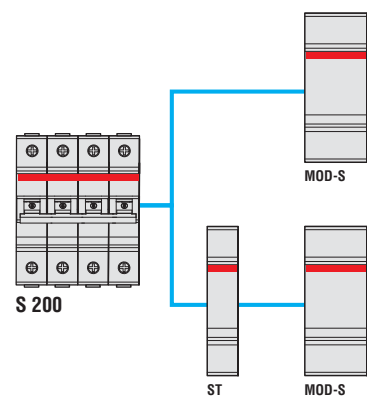

2CSC400011F0202

Combination of auxiliary elements with SN 201

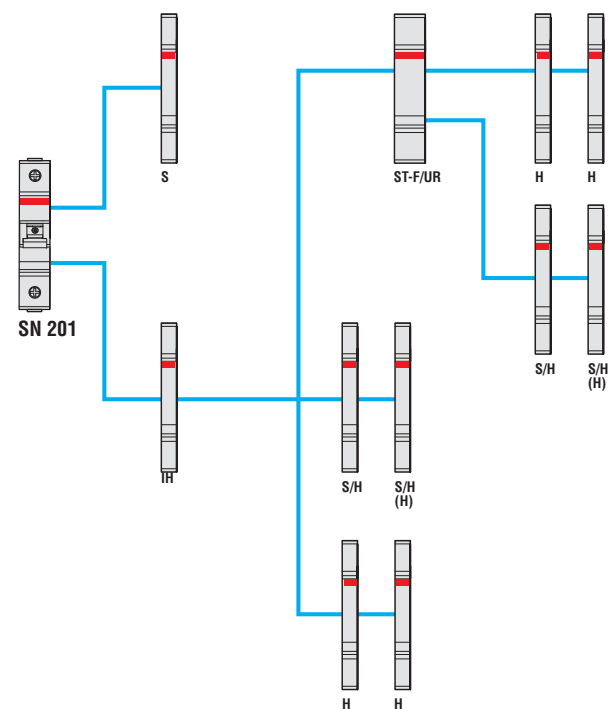

2CSC400011F0202

4

ST	Shunt trip for S 200 MCB S	S2C-A...
MOD-S*	Motor operating device	S2C-CM...

* in case of using S 200 coupled with DDA 200, MOD-S doesn't operate in case of earth-leakage fault

IH	Coupling interface/ auxiliary contact	SN201-IH
S	Signal contact	SN201-S
H	Auxiliary contact	S2C-H6R
S/H	Signal/auxiliary contact	S2C-S/H6R
S/H (H)	Signal/auxiliary contact used as auxiliary contact	S2C-S/H6R
ST-F	Shunt trip of F200 RCD	F2C-A
UR	Undervoltage release	S2C-UA

Auxiliary elements and accessories for MCBs and RCDs

Selection tables

Combination of home automatic resetting unit with F 200

Combination of auxiliary elements with F 200

4

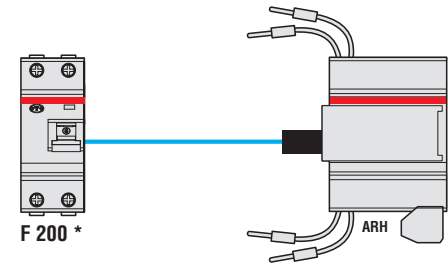

2CSC400011F2002

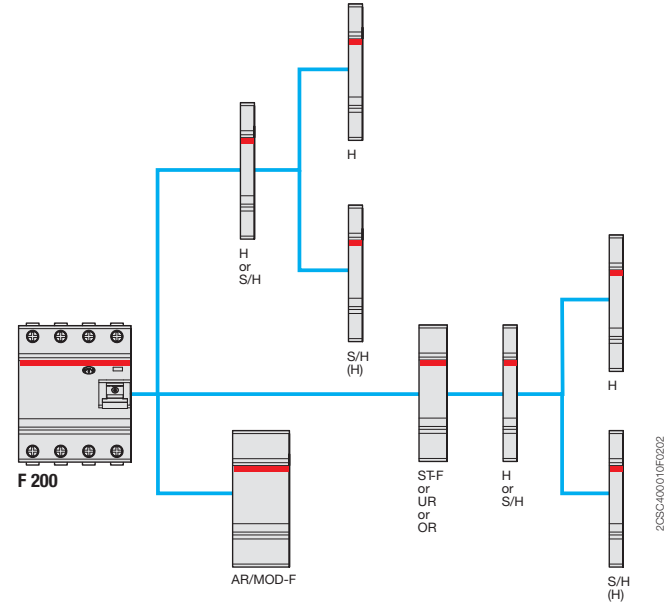

2CSC400010F2002

ARH	Home automatic resetting unit	F2C-ARH
------------	-------------------------------	---------

* F 202 30 mA or 100 mA (depending on ARH model), max 63 A

H	Auxiliary contact	S2C-H6R
S/H	Signal/Auxiliary contact	S2C-S/H6R
S/H (H)	Signal/Auxiliary contact used as auxiliary contact	S2C-S/H6R
UR	Undervoltage release	S2C-UA
OR	Overvoltage release	S2C-OVP
AR	Auto reclosing unit	F2C-ARI
MOD-F	Motor operating device	F2C-CM
ST-F	Shunt trip for F 200 RCCB	F2C-A

Combination of auxiliary elements with F 204 125 A, B type, PV B

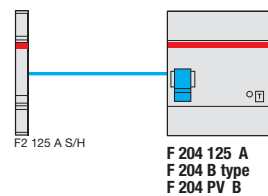

2CSC400012F0202

F2-125A-B-S/H Signal/Auxiliary contact

Combination of auxiliary elements with DS201, DS202C

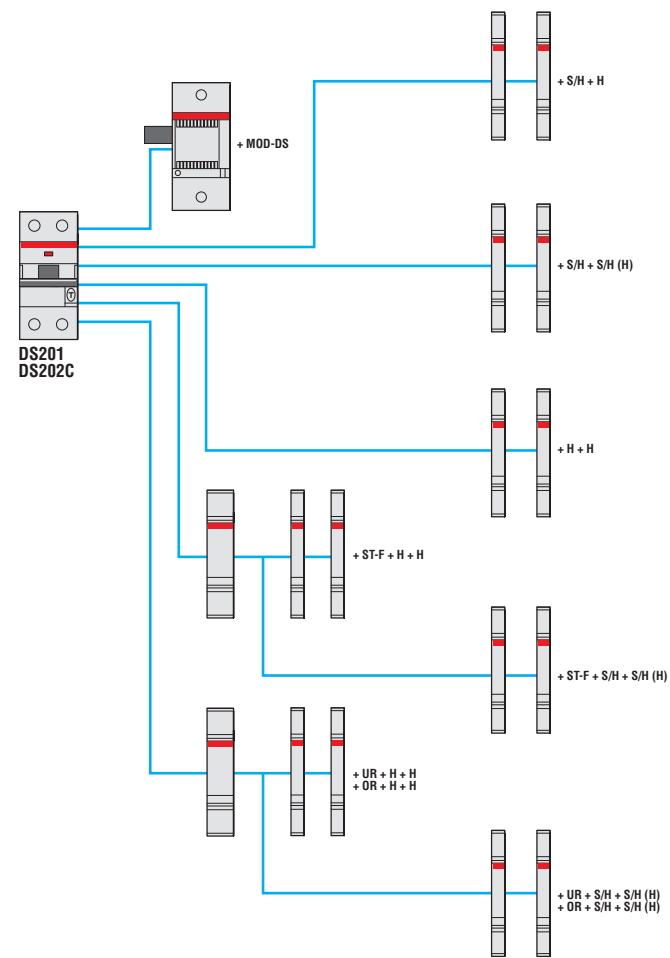

4

H	Auxiliary contact	S2C-H6R
S/H	Signal/Auxiliary contact	S2C-S/H6R
S/H (H)	Signal/Auxiliary contact used as auxiliary contact	S2C-S/H6R
ST-F	Shunt trip for F 200 RCCB	F2C-A
UR	Undervoltage release	S2C-UA
OR	Overvoltage release	S2C-OVP
MOD-DS	Motor operating device	DS2C-CM

Auxiliary elements and accessories for MCBs and RCDs

Selection tables

Combination of auxiliary elements with S 200 PR

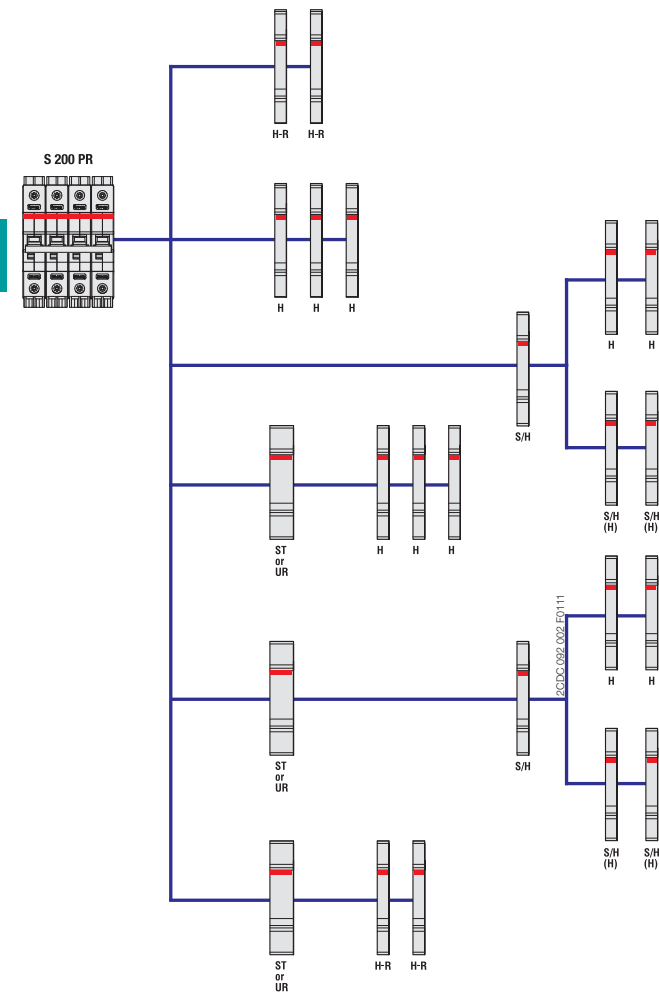

Combination of auxiliary elements with SU 200 PR

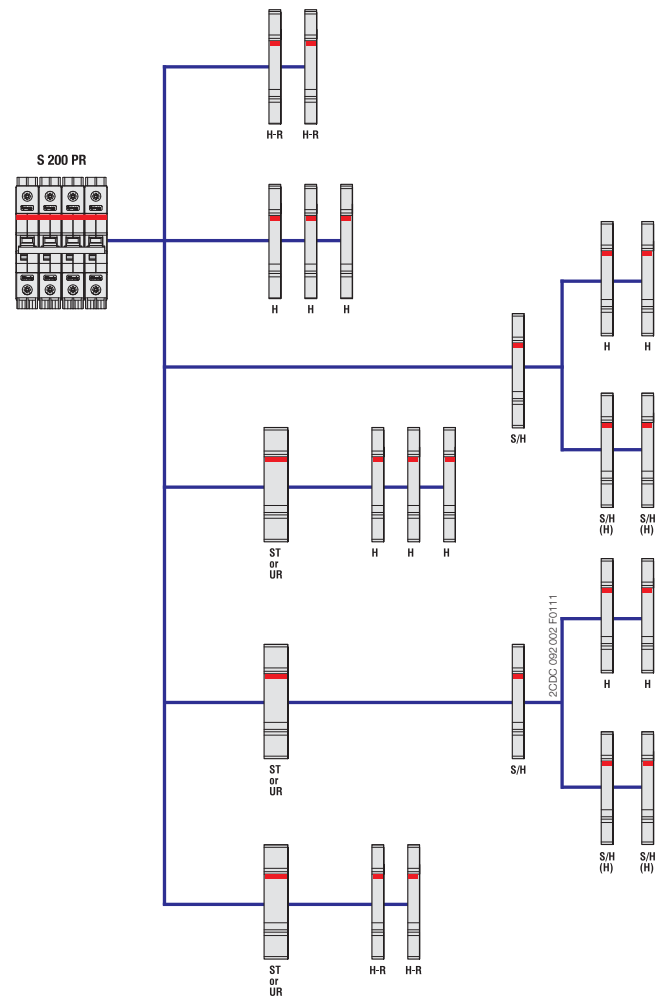

H	Auxiliary contact	S2C-H6R
H-R	Auxiliary contact	S2C-H6-...R
S/H	Signal/Auxiliary contact	S2C-S/H6R
S/H (H)	Signal/Auxiliary contact used as auxiliary contact	S2C-S/H6R
ST	Shunt trip	S2C-A...
UR	Undervoltage release	S2C-UA

H	Auxiliary contact	S2C-H6RU
S	Signal contact	S2C-S/H6RU
ST	Shunt trip	S2C-A...U

Auxiliary elements and accessories for Switch Disconnectors SD 200 Selection tables

Combination of auxiliary elements with SD 200

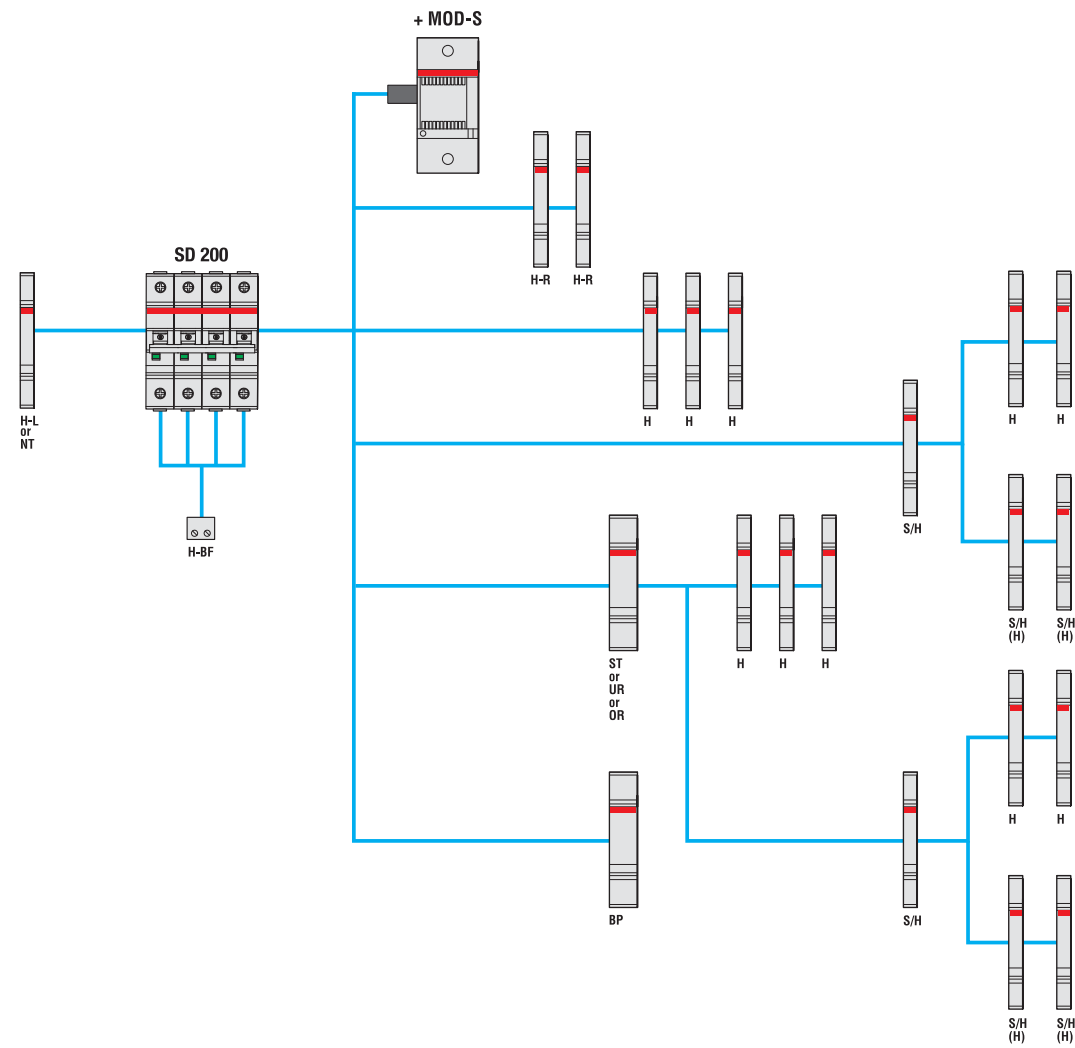

4

H	Auxiliary contact	S2C-H6R
H-R	Auxiliary contact	S2C-H6-...R
S/H	Signal/Auxiliary contact	S2C-S/H6R
S/H (H)	Signal/Auxiliary contact used as auxiliary contact	S2C-S/H6R
NT	Switched neutral	S2C-Nt
MOD-S	Motor operating device	S2C-CM
OR	Overvoltage release	S2C-OVP
BP	Mechanical tripping device	S2C-BP
ST	Shunt trip	S2C-A...
UR	Undervoltage release	S2C-UA

Auxiliary elements for MCBs S 200, SN 201, RCDs F 200, DS 200 and Switch Disconnectors SD 200 series



Auxiliary elements

4

Auxiliary contact and signal/auxiliary contact		
S2C-H6R, S2C-H11L, S2C-H20L, S2C-H02L and S2C-S/H6R		
Conventional free air thermal current	A	10
Min. operational current/voltage*		10 mA at 12 V; 5 mA at 24 V
Rated conditional short-circuit current	V	230 V AC 1,000 A with S201 K4
Overvoltage category		III
Rated impuls withstand voltage (1.2/50µs)	kV	4
Cross-section of conductors	mm ²	0.75...2.5 (up to 2 x 1.5 mm ² for S2C-H11L, S2C-H20L and S2C-H02L)
Tightening torque	Nm	1.2 (max. 0.8 for S2C-H11L, S2C-H20L and S2C-H02L)
Contact stability in vibration test according to IEC/EN 60 068-2-6		5g, 20 sweep cycles 5...150...5 Hz at 24 V AC/DC, 5 mA auto-matic reclosing < 10 ms
Mechanical service life		10000 operations
Dimensions (H x D x W)	mm	85 x 69 x 8.8

Auxiliary contact and signal/auxiliary contact		
S2C-H6-11R, S2C-H6-20R, S2C-H6-02R		
Rated current	A	10
Min. rated operational current/voltage*		10 mA at 12 V; 5 mA at 24 V
Overvoltage category		III
Rated impuls withstand voltage (1.2/50µs)	kV	4
Cross-section of conductors	mm ²	0.75...2.5
Tightening torque	Nm	1.2
Mechanical service life		10000 operations
Dimensions (H x D x W)	mm	85 x 69 x 8.8

* ensures safe contacting without current interruption by pollution layer



S2C-S/H6R



S2C-H6-xxR

Signal/auxiliary contacts

Function S2C-S/H6R: choice through a selector between indication of the position of the device's contacts and signalling of the fault (overcurrent/short-circuit for MCBs and RCBOs; earth fault for RCCBs and RCBOs). Suitable for MCBs S 200 series, RCCBs F 200 series, RCBOs DS201, DS202C, DS 200 and SD 200 switch disconnectors series.

Function S2C-H6R: indication of the position of the device's contacts. Suitable for MCBs S200 series. To be mounted on the left side of the MCBs thanks to the special pin. Suitable for SD 200 switch disconnectors series. They are not suitable to be mounted together with RCD-block DDA200.

Function S2C-H6-xxR: indication of the position of the MCB contact. Mounted on the right side. Suitable for SD 200 switch disconnectors series. They are not suitable to be mounted together with other right side mounted auxiliary contacts.

4

Description	Bbn 4016779	Order details		Price 1 piece	Weight 1 piece kg	Pack unit pc.
	EAN	Type code	Order code			
Signal contact/ auxiliary switch 1CO	563819	S2C-S/H6R	2CDS200922R0001		0.04	1
Auxiliary contact 1CO	563826	S2C-H6R	2CDS200912R0001		0.04	1
Auxiliary contact 1NO/1NC	697941	S2C-H6-11R	2CDS200946R0001		0.04	1
Auxiliary contact 2NO	697958	S2C-H6-20R	2CDS200946R0002		0.04	1
Auxiliary contact 2NC	697965	S2C-H6-02R	2CDS200946R0003		0.04	1

Auxiliary contacts mounting on the left side

Description	Bbn 4016779	Order details		Price 1 piece	Weight 1 piece kg	Pack unit pc.
	EAN	Type code	Order code			
Auxiliary contact 1 NO/1NC	648820	S2C-H11L	2CDS200936R0001		0.04	1
Auxiliary contact 2 NO	648837	S2C-H20L	2CDS200936R0002		0.04	1
Auxiliary contact 2 NC	648844	S2C-H02L	2CDS200936R0003		0.04	1

Auxiliary elements for MCBs S 200, SN 201, RCDs F 200, DS 200 and Switch Disconnectors SD 200 series



S2C-H

Bottom-fitting auxiliary contact		
S2C-H10 and S2C-H01		
Contact element		1NO (1 make contact), 1NC (1 normally closed contact), leading make contact, late closing
Utilization category		AC14 2A/230V - DC 12 identical DC13/DC13 1A /50V, 2A/30V
Min. operational current/voltage*	V	10 mA at 12 V AC/DC
Rated conditional short-circuit current		230 VAC 1000 A, fault protection with S 201-K2 or Z2
Electrical serviceable life		> 4000 switchover cycles
Standard		VDE 0106 Part 101
Connection cross-section	mm ²	0.75 to 2.5
Tightening torque	Nm	0.5

* ensures safe contacting without current interruption by pollution layer

Bottom-fitting auxiliary contacts for S 200, S 200 M, S 200 P, S 200 S, SD 200

Description	Bbn	Order details		Price 1 piece	Weight 1 piece	Pack unit
	4016779	Type code	Order code			
	EAN			kg	pc.	
1 NC	64551 5	S 2C-H01	2CDS 200 970 R0001		0.01	1
1 NO	64552 2	S 2C-H10	2CDS 200 970 R0002		0.01	1

packing unit 15 parts

Description	Bbn	Order details		Price 1 piece	Weight 1 piece	Pack unit
	4016779	Type code	Order code			
	EAN			kg	pc.	
1 NC	64677 2	S 2C-H01 15x	2CDS 200 970 R0011		0.01	15
1 NO	64681 9	S 2C-H10 15x	2CDS 200 970 R0012		0.01	15

Auxiliary contact bridge for bottom-fitting auxiliary contacts

Wire jumper for integrated auxiliary contact (MCB S 200 H or auxiliary contacts S2C-H01/S2C-H10 for series connections (HKB) or parallel connections (HKB1).

Description	Bbn	Order details		Price 1 piece	Weight 1 piece	Pack unit
	8012542	Type code	Order code			
	EAN			kg	pc.	
1/2 mod.	523134	HKB	GH V036 0504 R0100		0.001	1000
1 mod.	524209	HKB 1	GH V036 0504 R0101		0.001	1000

Signal and auxiliary contacts

		SN201-S	SN201-IH
Terminals	mm ²	2x1,5	
Tightening torque	N	1.2	
Dimensions	mm	H: 85 x D: 68 x W: 8.9	H: 85 x D: 68,7 x W: 8.9
Rated voltage	V	230	
Rated current	A	2	



2CSS200924R0001

SN201-S



2CSS200924R0001

SN201-IH

Utilization category / contact capacity

S2C-H6R, S2C-S/H6R, SN201-S, SN201-IH				
AC14	Ue	V	400	230
	Ie	A	1	2
DC12	Ue	V	220	110
	Ie	A	1	1,5
DC13	Ue	V	60	24
	Ie	A	2	4

4

Signal contact for SN201 MCBs

Function: indication of the device contact positions only after the automatic release of the MCBs due to overcurrent.

Description	Bbn 8012542	Order details		Price 1 piece	Weight 1 piece	Pack unit
	EAN	Type code	Order code		kg	pc.
Signal contact 1C0	104957	SN201-S	2CSS200924R0001		0.040	1

Auxiliary contact / interface module for SN201 MCBs

Function: indication of the device contact positions. The auxiliary contact can be used as an interface module between SN201 and other compact auxiliary elements.

Description	Bbn 8012542	Order details		Price 1 piece	Weight 1 piece	Pack unit
	EAN	Type code	Order code		kg	pc.
Interface module/Aux. Contact 1C0	104858	SN201-IH	2CSS200923R0001		0.050	1

Signal and auxiliary contacts for F 200 125A and F 200 B

F2 125A-S/H			
Rated current	AC	A	6
	DC	A	1
Min. rated voltage Ub min	AC	V	230
	DC	V	110
Connection cross section		mm ²	1...1.5
Tightening torque		Nm	0.8
Dimensions (H x D x W)		mm	85 x 69 x 8.8

Auxiliary/Signal contact for F 200 125A and F 200 B

Function: choice through a selector between indication of the position of the device's contacts and signalling of the earth fault. Suitable for RCCBs F 200 125A and F 200 B series

Description	Bbn 8012542	Order details		Price 1 piece	Weight 1 piece	Pack unit
	EAN	Type code	Order code		kg	pc.
Auxiliary/Signal contact 1C0+1NC	600527	F2-125A-B-S/H	2CSF200922R0001		0.04	1

Clamping cover for F200 125A-F200 B type

Description	Bbn 4016779	Order details		Price 1 piece	Weight 1 piece	Pack unit
	EAN	Type code	Order code		kg	pc.
	999638	CPV B	2CSF200988R0001			1

Auxiliary elements for MCBs S 200, SN 201, RCDs F 200, DS 200 and Switch Disconnectors SD 200 series



S2C-A

Shunt trip for S 200 MCBs								
S2C-A1								
Rated voltage	AC	V	12...60					
	DC	V	12...60					
Max release duration		ms	<10					
Min. release voltage	AC	V	7					
	DC	V	10					
Consumption on release	Ub	V	12	12	24	24	60	60
			DC	AC	DC	AC	DC	AC
	lb max	A	2.2	2.5	4.5	5	14	8.8
Coil resistance		Ω	3.7					
Terminals		mm ²	16					
Tightening torque		Nm	2.5					
Dimensions (H x D x W)		mm	85 x 69 x 17.5					
S2C-A2								
Rated voltage	AC	V	110...415					
	DC	V	110...250					
Max release duration		ms	<10					
Min. release voltage	AC	V	55					
	DC	V	80					
Consumption on release	Ub	V	110	110	220	230	415	
			DC	AC	DC	AC	AC	
	lb max	A	0.35	0.5	1.1	1.0	2.7	
Coil resistance		Ω	225					
Terminals		mm ²	16					
Tightening torque		Nm	2.5					
Dimensions (H x D x W)		mm	85 x 69 x 17.5					

Shunt trips

Function: remote opening of the device when a voltage is applied. Suitable for MCBs S 200 series, RCBOs DS 200 series, SD 200 switch disconnectors series.

Rated voltage	Bbn 4016779	Order details		Price 1 piece	Weight 1 piece	Pack unit
	EAN	Type code	Order code		kg	pc.
AC/DC 12...60 V	570992	S2C-A1	2CDS200909R0001		0.15	1
AC 110...415 V/DC110...250 V	571005	S2C-A2	2CDS200909R0002		0.15	1



F2C-A

2CSS40019F2C2

Shunt trip for F 200 RCCBs

			F2C-A1				
Rated voltage	AC	V	12...60				
	DC	V	12...60				
Max release duration		ms	10				
Min. release voltage	AC	V	6				
	DC	V	4.5				
Consumption on release	Ub	V	12 DC	12 AC	24 DC	60 DC	60 AC
	Ib max	A	0.88	0.65	1.58	5.8	5
Coil resistance		Ω	5.5				
Terminals		mm ²	2x1.5				
Tightening torque		Nm	0.2				
Dimensions (H x D x W)		mm	85 x 69 x 17.5				
			F2C-A2				
Rated voltage	AC	V	110...415				
	DC	V	110...250				
Max release duration		ms	10				
Min. release voltage	AC	V	75				
	DC	V	55				
Consumption on release	Ub	V	110 DC	110 AC	250 DC	415 AC	
	Ib max	A	0.05	0.03	0.1	0.16	
Coil resistance		Ω	1355				
Terminals		mm ²	2x1.5				
Tightening torque		Nm	0.2				
Dimensions (H x D x W)		mm	85 x 69 x 17.5				

4

Function: remote opening of the device when a voltage is applied. Suitable for RCCBs F 200 series and RCBOs DS201 and DS202C.

It can be used with MCBs SN201 series by means of SN201-IH interface module.

Rated voltage	Bbn	Order details		Price	Weight	Pack
	8012542	Type code	Order code	1 piece	1 piece	unit
	EAN				kg	pc.
AC/DC 12...60V	974901	F2C-A1	2CSS200933R0011		0.15	1
AC 110...415V / DC 110...250V	975007	F2C-A2	2CSS200933R0012		0.15	1

Auxiliary elements for MCBs S 200, SN 201, RCDs F 200, DS 200 and Switch Disconnectors SD 200 series



S2C-UA

2CSC40002D0211

4

		S2C-UA 12 DC	S2C-UA 24 AC	S2C-UA 24 DC	S2C-UA 48 AC	S2C-UA 48 DC
Standards		IEC/EN 60947-1				
Rated voltage	AC		24		48	
	DC	12		24		48
Frequency	Hz	50...60				
Release trip	V	0.35 Un ≥ V ≥ 0.7 Un				
Terminals	mm ²	2x1.5				
Consumption	VA	2.2	3.6	2	3.6	2.1
Resistance to corrosion	°C/ RH	constant atmosphere: 23/83 - 40/93 - 55/20; variable atmosphere: 25/95 - 40/93				
	Protection degree	IPXXB/IP2X				
Tightening torque	Nm	0.4				
Dimensions (H x D x W)	mm	85 x 69 x 17.5				
		S2C-UA 110 AC	S2C-UA 110 DC	S2C-UA 230 AC	S2C-UA 230 DC	S2C-UA 400 AC
Standards		IEC/EN 60947-1				
Rated voltage	AC	110		230		400
	DC		110		230	
Frequency	Hz	50...60				
Release trip	V	0.35 Un M V M 0.7 Un				
Terminals	mm ²	2x1.5				
Consumption	VA	3.5	2.2	3.7	2.3	2.4
Resistance to corrosion	°C/ RH	constant atmosphere: 23/83 - 40/93 - 55/20; variable atmosphere: 25/95 - 40/93				
	Protection degree	IPXXB/IP2X				
Tightening torque	Nm	0.4				
Dimensions (H x D x W)	mm	85 x 69 x 17.5				

Undervoltage releases

Function: protection of the load in the event of a voltage drop (between 70% and 35% of its rated value); positive safety (device's tripping when the voltage is disconnected) emergency stop by means of a button. Suitable for MCBs S 200 series, RCCBs F200 series and RCBOs DS201, DS202C, DS 200 series, SD 200 switch disconnectors series. It can be used with MCBs SN201 series by means of SN201-IH interface module.

Rated voltage	Bbn 8012542	Order details		Price 1 piece	Weight 1 piece	Pack unit
	EAN	Type code	Order code			
12VDC	839705	S2C-UA 12 DC	2CSS200911R0001		0.09	1
24VAC	839804	S2C-UA 24 AC	2CSS200911R0002		0.09	1
24VDC	896401	S2C-UA 24 DC	2CSS200911R0007		0.09	1
48VAC	839903	S2C-UA 48 AC	2CSS200911R0003		0.09	1
48VDC	896500	S2C-UA 48 DC	2CSS200911R0008		0.09	1
110VAC	840008	S2C-UA 110 AC	2CSS200911R0004		0.09	1
110VDC	896609	S2C-UA 110 DC	2CSS200911R0009		0.09	1
230VAC	840107	S2C-UA 230 AC	2CSS200911R0005		0.09	1
230VDC	896708	S2C-UA 230 DC	2CSS200911R0010		0.09	1
400VAC	840206	S2C-UA 400 AC	2CSS200911R0006		0.09	1



2CSS40077R001

S2C-OVP



2CSS40005R001

S2C-Nt

Overvoltage release		S2C - OVP2	S2C - OVP1
Rated voltage	VAC	230	
Rated frequency	Hz	50	
Max non-tripping voltage AC	V	253	
Max tripping voltage AC	V	290	275
Tripping time	@ 290V AC	s	t<1
	@ 380V AC	s	t<0.1
Peak current	@ 315V AC	A	1
	@ 440V AC	A	1.8
Max duration of impulse command	ms	7	
Operating temperature	°C	-5...+40	

4

Overvoltage releases

Function: monitoring voltage between the neutral and phase; when an overvoltage reaches the threshold value, the OVP device causes the tripping of the associated MCB or RCCB.

Suitable for MCBs of the S200 series up to 63 A, and RCCBs of the F200 series up to 100 A and RCBOs DS201 and DS202C series. Suitable for SD 200 switch disconnectors series.

Description	Bbn	Order details		Price	Weight	Pack
	8012542	Type code	Order code	1 piece	1 piece	unit
	EAN				kg	pc.
Overvoltage release (max tripping voltage AC: 275V)	748137	S2C-OVP1	2CSS200910R0005		0.100	1/5
Overvoltage release (max tripping voltage AC: 290V)	952039	S2C-OVP2	2CSS200993R0005		0.100	1/5

Hand operated neutral left side mounted

		S2C-Nt
Rated current	A	max. 40
Terminal	mm ²	10; box terminal
Tightening torque	Nm	1.2
Dimensions (H x D x W)	mm	85 x 69 x 8.8

Hand operated neutral

The hand operated neutral has to be mounted to the left side of the MCB and be snapped on the DIN rail. It is used for measuring duties where the neutral conductor must be in the open position. Due to the special design of the handle - when switching ON the MCB - the neutral will make before the MCB is closed. Suitable for SD 200 switch disconnectors series.

The S2C - Nt is not to switch with a tool (screw driver).

Description	Bbn	Order details		Price	Weight	Pack
	4016779	Type code	Order code	1 piece	1 piece	unit
	EAN				kg	pc.
Max 40A	647625	S2C-Nt	2CDS200918R0001		0.06	1

Auxiliary elements for MCBs S 200, SN 201, RCDs F 200, DS 200 and Switch Disconnectors SD 200 series



S 2C-S6R U

2CSC400024F0201

4



S 2C-H6R U

2CSC400024F0201

Auxiliary contact and signal contact		
S2C-H6R U, S2C-S/6R U		
Conventional free air thermal current	A	10
Min. operational current/voltage*		10 mA at 12 V; 5 mA at 24 V
Rated conditional short-circuit current	V	230 V AC 1,000 A with S201 K4
Overvoltage category		III
Rated impuls withstand voltage (1,2/50µs)	kV	4
Connection cross section	mm ²	0.75...2.5
Tightening torque	Nm	1.2
Contact stability in vibration test		5g, 20 sweep cycles 5...150...5 Hz according to DIN IEC 68-2-6 at 24 V AC/DC, 5 mA automatic reclosing < 10 ms
Mechanical service life		10000 operations
Dimensions (H x D x W)	mm	100 x 69 x 8.8

* ensures safe contacting without current interruption by pollution layer.

Accessories for S 200 U/S 200 UP/S 200 UDC

Auxiliary contact (switch)

Description	Bbn	Order details		Price	Weight	Pack
	4016779	Type code	Order code	1 piece	1 piece	unit
	EAN				kg	pc.
only for range U/UP/UDC	61561 7	S 2C-H6R U	2CDS 200 914 R0001		0.035	1

Signal contact (bell alarm)

Description	Bbn	Order details		Price	Weight	Pack
	4016779	Type code	Order code	1 piece	1 piece	unit
	EAN				kg	pc.
only for range U/UP/UDC	64677 2	S 2C-S6R U	2CDS 200 924 R0001		0.035	1



2CSC400018R0001

S 2C-A1 U

				S2C-A1 U				
Rated voltage	AC	V	12...60					
	DC	V	12...60					
Max release duration		ms	<10					
Min. release voltage	AC	V	7					
	DC	V	10					
Consumption on release	Ub	V	12	12	24	24	60	60
			DC	AC	DC	AC	DC	AC
	Ib max	A	2.2	2.5	4.5	5	14	8.8
Coil resistance		Ω	3.7					
Terminals		mm ²	25					
Tightening torque		Nm	2.8					
Dimensions (H x D x W)		mm	100 x 69 x 17.5					
				S2C-A2 U				
Rated voltage	AC	V	110...415					
	DC	V	110...250					
Max release duration		ms	<10					
Min. release voltage	AC	V	55					
	DC	V	80					
Consumption on release	Ub	V	110	110	220	230	415	
			DC	AC	DC	AC	AC	
	Ib max	A	0.35	0.5	1.1	1.0	2.7	
Coil resistance		Ω	225					
Terminals		mm ²	25					
Tightening torque		Nm	2.8					
Dimensions (H x D x W)		mm	100 x 69 x 17.5					

4

Shunt trip only for range U/UP/UDC

Description	Bbn 4016779	Order details		Price 1 piece	Weight 1 piece	Pack unit
	EAN	Type code	Order code		kg	pc.
12 - 60 V AC/DC	64472 3	S 2C-A1 U	2CDS 200 908 R0001		0.15	1
110-415 V AC,110-250V DC	64473 0	S 2C-A2 U	2CDS 200 908 R0002		0.15	1

Accessories for MCBs, RCDs and Switch Disconnectors



2CSC2102480011

S 2C-TC20 U

IP20 Terminal cover						
Description	Bbn	Order details		Price	Weight	Pack
	4016779	Type code	Order code	1 piece	1 piece	unit
	EAN			kg	pc.	
only for range U/UP/UDC	87756 5	S 2C-TC20 U	2CDS 200 917 R0001		0.0002	20

Mechanical tripping device

Function: it causes the automatic tripping of the circuit-breakers which it is associated to, when the panel or the door of the electrical switchboard are opened or removed.

Suitable for MCBs S 200 series (on both sides of the devices) and for DS 200 (only on the right side, because on the left side there's RCD-block DDA 200). Suitable for SD 200 switch disconnectors series.

Rated voltage	Bbn	Order details		Price	Weight	Pack
	8012542	Type code	Order code	1 piece	1 piece	unit
	EAN			kg	pc.	
Mechanical tripping device	941309	S2C-BP	2CSS200998R0001		0.048	1

Plug-in base

Function: it is possible to transform a standard circuit-breaker of the S 200 and F 200 range in a plug-in device which can be pulled out of the circuit where it is installed in one operation. Suitable for MCBs S 200 series and for RCCBs F 200 series up to 63 A and RCBOs DS201 and DS202C.

Rated voltage	Bbn	Order details		Price	Weight	Pack
	8012542	Type code	Order code	1 piece	1 piece	unit
	EAN			kg	pc.	
Plug-in base	940708	S2C-EST	2CSS200999R0001		0.115	1



2CSC100790201

S 2C-BP



2CSC1001680201

S 2C-EST

Motor operating and autoreclosing devices for MCBs, RCDs and Switch Disconnectors



S2C-CM

Motor operating devices			S2C-CM	F2C-CM
Supply		V	12 ... 30 V a.c. +10% - 15% (50-60Hz); 12 ... 48 V d.c. +10% - 15%	
Power consumption during the operation	12 V a.c.	VA	< 15	
	24 V a.c.	VA	< 22	
	30 V a.c.	VA	< 25	
	12 ... 48 V d.c.	VA	< 20	
Power consumption at rest		VA	< 1.5	
Make-time at ambient temperature		sec	< 1	
Opening time at ambient temperature		sec	< 0.5	
Number of operations			< 20.000	
Operating temperature		°C	- 25 ... + 55	
Cables length of control circuit		m	< 1500	
Cables cross-section		mm ²	< 2.5	
Signal contact (terminals 3 – 4 – 5)			1NA + 1NC (change-over contact) 5 A (250 V AC) (inductive-ohmic load)	
Auxiliary contact (terminals 6 – 7 – 8) Current carrying capacity			1NA + 1NC (change-over contact) 3 A (250 V AC) (inductive-ohmic load)	
Remote control*			By means of dry contacts	
Remote control terminals			Terminal 9 = make contact; Terminal 10 = opening contact Terminal 11 = common reference for control contacts, +5V d.c. (supplied by the motor operating device)	

4

* Note: In case of the device opening due to a fault, please wait 8 seconds before attempting to reclose the motor operator.

Motor operating and autoreclosing devices for MCBs, RCDs and Switch Disconnectors

4

Motor operating devices		DS2C-CM	
Supply	V	12 ... 30 V a.c. +10% - 15% (50-60Hz); 12 ... 48 V d.c. +10% - 15%	
Insulation voltage	V	2500 for 1 minute	
Power consumption during the operation	12 V a.c.	VA	< 15
	24 V a.c.	VA	< 22
	30 V a.c.	VA	< 25
	12 ... 48 V d.c.	VA	< 20
Power consumption at rest	VA	< 1.5	
Remote control *		by means of dry contacts	
Make-time at ambient temperature	sec	< 1	
Opening time at ambient temperature	sec	< 0.5	
Time before attempting to reclose the motor operator	sec	8	
Number of operations		< 20.000	
Operating temperature	°C	- 25 ... + 55	
Storage temperature	°C	- 40 ... + 70	
Mounting		on DIN rail EN 60715 by means of fast clip device	
Protection degree (EN 60529)		terminals: IP2X	
		enclosure: IP4X	
Cables length of control circuit	m	< 1500	
Cables cross-section	mm ²	< 2.5	
Signal contact (terminals 3 – 4 – 5)		1NO + 1NC (change-over contact)	
Current carrying capacity		5 A (250 V AC) (resistive load)	
Auxiliary contact (terminals 6 – 7 – 8)		1NO + 1NC (change-over contact)	
Current carrying capacity		3 A (250 V AC) (resistive load)	
Remote control terminals		Terminal 9 = make contact; Terminal 10 = opening contact Terminal 11 = common reference for control contacts, +5 V d.c. (supplied by the motor operating device)	

* Note: In case of the device opening due to a fault, please wait 8 seconds before attempting to reclose the motor operator.

Motor operating devices

Function: S2C-CM, F2C-CM and DS2C-CM allow the remote control (opening or closing) of the coupled device. Suitable for S200 MCBs up to 63 A, F 200 RCCBs up to 100 A and RCBOs DS201 and DS202C.

Description	Bbn 8012542	Order details		Price 1 piece	Weight 1 piece	Pack unit
	EAN	Type code	Order code			
Motor operating device for 1P S200 MCBs	026259	S2C-CM1	2CSS201997R0013		0.166	1
Motor operating device for 2P and 3P S200 MCBs	026358	S2C-CM2/3	2CSS203997R0013		0.166	1
Motor operating device for 4P S200 MCBs	026457	S2C-CM4	2CSS204997R0013		0.166	1
Motor operating device for 2P and 4P F200 RCCBs	026556	F2C-CM	2CSF200997R0013		0.166	1
Motor operating device for 1P+N and 2P DS201, DS202C RCBOs	135951	DS2C-CM	2CSR201997R0013		0.166	1

Where to find more:

Wiring Diagrams for Motor Operating and Autoreclosing units p.11/13



F2C-ARI

2CSF40024F001

Auto-reclosing unit			F2C-ARI	F2C-ARI30
Supply	V		12 ... 30 V a.c. +10% - 15% (50-60Hz); 12 ... 48 V d.c. +10% - 15%	
Number of automatic reset attempts			3	
Time of reset of the auto-reset meter	sec		16	45
Power consumption during the operation	12 V a.c.	VA	< 15	
	24 V a.c.	VA	< 22	
	30 V a.c.	VA	< 25	
	12...48 V d.c.	VA	< 20	
Power consumption at rest	VA		< 1.5	
Waiting time between auto-reset attempts	sec		3	30
Closing time at ambient temperature	sec		< 1	
Opening time at ambient temperature	sec		< 0.5	
Number of operations			< 20.000	
Operating temperature	°C		- 25 ... + 55	
Cables length of control circuit	m		< 1500	
Cables cross-section	mm ²		< 2.5	
Signaling contact to signal a locked state following three auto-reset attempts (terminals 3–4–5)			1NA + 1NC (change-over contact)	
Current carrying capacity			5 A (250 V AC) (ohmic load)	
Auxiliary contact (terminals 6–7–8)			1NA + 1NC (change-over contact)	
Current carrying capacity			3 A (250 V AC) (ohmic load)	
Remote control			By means of dry contacts	
Remote control terminals			Terminal 9 = closing and remote reset contact for locked state; Terminal 10 = opening contact Terminal 11 = common reference for control contacts, +5V d.c. (supplied by the motor operating device)	

4

Auto-reclosing units

Function: F2C-ARI and F2C-ARI30 allow the auto-reclosing of the coupled device in case of unwanted tripping. Suitable for F 200 RCCBs up to 100 A.

Description	Bbn	Order details		Price 1 piece	Weight 1 piece kg	Pack unit pc.
	8012542	Type code	Order code			
Auto-reclosing unit for 2P and 4P F200 RCCBs	026655	F2C-ARI	2CSF200996R0013		0.166	1
Auto-reclosing unit for 2P and 4P F200 RCCBs (30")	064350	F2C-ARI30	2CSF200995R0013		0.166	1

Where to find more:
Wiring Diagrams for Motor Operating
and Autoreclosing units p.11/13

Motor operating and autoreclosing devices for MCBs, RCDs and Switch Disconnectors



F2C-ARH

2CSF400678F0001



F2C-ARH-T

2CSF40014F0202

Home automatic resetting unit		
F2C-ARH /F2C-ARH-T		
Power supply	VAC	230
Number of automatic reclosing attempts		1
Reset time for counter of automatic reclosing attempts	sec	12
Power absorbed during the operation	VA	(t<0.5s) 20 max
Power consumption in stand-by	W	0.4 max
Number of operations		≤ 10.000
Operating temperature	°C	-25 ... + 55
Signal contact cable section (terminals 1-2)	mm ²	≤ 2.5
Signal contact for the locked state (terminals 1-2)		1NA (change-over contact)
Signal contact rated current	A	3 (250V AC)

Home automatic resetting unit (for domestic and similar applications)

Function: it recloses the associated residual current device, only after having checked that there are no effective faults in the system protected by the RCCB.

Suitable for 2-pole RCCB series with 30 mA or 100 mA sensitivities, max 63 A

Description	Bbn	Order details		Price	Weight	Pack
	8012542	Type code	Order code	1 piece	1 piece	unit
	EAN				kg	pc.
Home automatic resetting unit (30 mA)	732433	F2C-ARH	2CSF200992R0005		0.200	1
Home automatic resetting unit (100 mA)	658535	F2C-ARH100	2CSF200990R0005		0.200	1

Home automatic resetting unit with autotest (for domestic and similar applications)

Function: it recloses the associated residual current device, only after having checked that there are no effective faults in the system protected by RCCB.

Suitable for 2-pole RCCB series with 30 mA or 100 mA sensitivities, max 63 A.

F2C-ARH-T allows the RCCB automatic test every six months.

Description	Bbn	Order details		Price	Weight	Pack
	8012542	Type code	Order code	1 piece	1 piece	unit
	EAN				kg	pc.
Home automatic resetting unit (30 mA) with RCCB autotest	733232	F2C-ARH-T	2CSF200991R0005		0.200	1
Home automatic resetting unit (100 mA) with RCCB autotest	593836	F2C-ARH-T100	2CSF200989R0005		0.200	1

Where to find more:

Wiring Diagrams for Motor Operating and Autoreclosing units p.11/13

Busbar systems

Selection table

Short description

ABB busbar systems enable the safe and economic cross connection of MCBs, RCCBs and RCBOs.

For a correct busbar selection the following points need to be considered:

- MCB terminal type (Twin terminal or cage terminal)
- Number of poles (1, 2, 3, 4, 1+N or 3+N)
- Device type (MCB, RCCB or RCBO)
- Combinations (e.g. RCCB + MCB or RCCB 3+N + RCCB 1+N)
- Use of side mounted auxiliary elements on MCB *)
- Busbar diameter (for current carrying capacity calculation)
- Number of modules (choice of standard busbar or busbar for cutting)

4

Coding of PS busbars

	PS	1	2	3	4	5	6	7	7
Phases									
1 phase		1							
2 phases		2							
3 phases		3							
4 phases		4							
Number of pins									
Diameter									
10 mm ²					-	-			
6 mm ²					6	-			
16 mm ²					1	6			
30 mm ²					3	0			
Application									
Cross connection of RCCB and MCB (4th pin removed for RCCB 3+N)							F	I	
Use of neutral conductor (phase sequence e.g. L1-N-L2-N-L3-N-L1...)					N				
Space for 1 side mounted auxiliary contact					H				
Space for 2 side mounted auxiliary contacts							H	2	
Pins for breaking off									A
Cross connection of devices 3P+N + 1P+N (phase sequence L1-L2-L3-N-L1-N-L2-N-L1-N-...)							N	N	
Busbars for IT networks							I	T	
Busbars acc. to UL 489 (Branch Protection)							B	P	
Busbars acc. to UL 1077 (Supplementary Protection)							S	P	
Note: Combinations of above applications are possible									

*) only right side mounted auxiliary elements and bottom fixed auxiliary contacts can be considered for busbar connection

Busbars and accessories for MCBs S 200, RCDs F 200 and DS 200 series

4

		Busbars PS			
Suitable for		MCB: S200, S200M, S200P RCD: F200, DDA-blocks			
Electrical Data	Standards	for IEC applications DIN EN 60947-1 VDE 0660 Part 100 = IEC 60947-1:2004			
	Approvals	—			
	Rated voltage U _e	1P, 2P, 3P, 4P: 690 V AC, 690 V DC			
	Rated frequency	Hz	50 / 60 Hz, DC		
	Current carrying capacity / Phase (35°C ambient temperature)	A	10 mm ²	16 mm ²	30 mm ²
			End feeding ①	63 A	80 A
Non-end feeding ①			100 A	130 A	160 A
Short-circuit withstand capacity	kA	25 kA in series with fuse NH3 355 A gG 500 V			
Mechanical Data	Housing	light grey, RAL 7035			
	Environmental conditions acc. to	DIN EN 60068			
	Overvoltage category	III			
	Pollution degree	2			
Installation	Cross-Section Busbar	10 mm ² , 16 mm ² , 30 mm ²			
	Mounting position	optional			
	Supply	Feed on terminal of the device (supply side optional) or use of feeder terminal range AST; SZ-ESK			
Accessories	Shock-protection caps	BSK, SZ-BSK			
	Feeder terminals	range AST, SZ-ESK			
	End caps	range END, PS-END, PSB-END			
		Feeder Terminals AST , SZ-ESK			
Electrical Data	Max. operating voltage	V	690 V AC, 690 V DC		
	Current carrying capacity / phase	A	see below ①		
	Cross-Section	mm ²	SZ-ESK	6 - 35 mm ²	100 A
				6 - 50 mm ²	125 A
	mm ²	AST	6 - 25 mm ²	80 A	
			6 - 50 mm ²	125 A	
Instruction of installation		When cutting the busbar, ensure that the insulation profile exceeds the copper bar by approx. 10 mm on each side. Shock protection only with mounted end caps ensured. For DC applications the required increased clearance and creepage distances needs to be ensured.			

① In case of feed in from the middle of the busbar it needs to be ensured, that the sum of junction currents per side must not exceed the max busbar current I_b/phase.
Irrespective of the current carrying capacity (I_n) of the busbar, the max. rated current of the devices terminal may not be exceeded.

Busbars PS...SP			Busbars PS...BP		
MCB: S200, S200P			MCB: S200U, S200UP		
UL1077 DIN EN 60947-1 VDE 0660 Part 100 = IEC 60947-1:2004			UL489 DIN EN 60947-1 VDE 0660 Part 100 = IEC 60947-1:2004		
UL 1077			UL 489		
1P, 2P, 3P, 4P: 480 V AC			1P, 2P, 3P: 480 V AC		
50 / 60 Hz			50 / 60 Hz		
	10 mm ²	16 mm ²	16 mm ²		
End feeding ①	63 A	80 A	80 A (115A for cubicle size ≥ 30"x30"x10")		
Non-end feeding ①	100 A	130 A			
10 kA in series with fuse NH3 355 A gG 500 V			10 kA in series with fuse NH3 355 A gG 500 V		
10 mm ² , 16 mm ²			16 mm ²		
Feed on terminal of the device (supply side optional) or use of feeder terminals AST 35/15 SP; SZ-ESK SP			Feed on terminal of the device (supply side optional) or use of feeder terminals AST 35/15 BP; SZ-ESK BP		
BSK SP			BSK BP		
AST 35/15 SP SZ-ESK SP			AST 35/15 BP SZ-ESK BP		
PS-END SP; PS-END1 SP			-		
Feeder Terminals AST 35/15 SP and SZ-ESK SP			Feeder Terminals AST 35/15 BP and SZ-ESK BP		
480 V AC			480 V AC		
115 A ①			115 A ①		
SZ-ESK SP	35 mm ² / 2AWG flexible with ferrules 50 mm ² / 1AWG solid / stranded		SZ-ESK BP	35 mm ² / 2AWG flexible with ferrules 50 mm ² / 1AWG solid / stranded	
AST 35/15 SP	25 mm ² / 3AWG flexible with ferrules 35 mm ² / 2AWG solid / stranded		AST 35/15 BP	25 mm ² / 3AWG flexible with ferrules 35 mm ² / 2AWG solid / stranded	
When cutting the busbar, ensure that the installation profile exceeds the copper bar by approx. 10 mm on each side. Shock protection only with mounted end caps ensured.			Cutting of busbar is not permitted.		

4

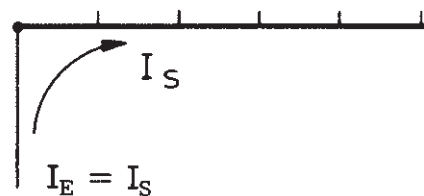

Feed in from the end of the busbar

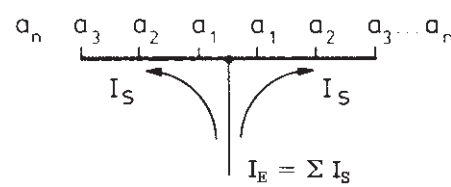

Feed in from the middle of the busbar

Busbars and accessories for MCBs S 200, RCDs F 200 and DS 200 series

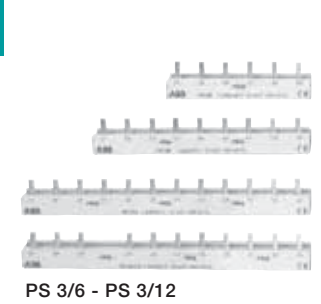
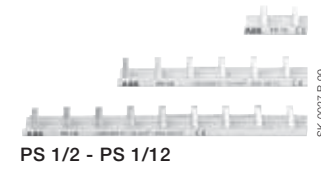

Pre-assembled busbars (not to be cut)

1-phase busbars, pin distance 17.6 mm, end caps PS-END 0

No. of pins	Phases	mm ²	Cu-No. kg	Bbn 4016779 EAN	Order details		Price 1 piece	Weight 1 piece kg	Pack unit pc.
					Type code	Order code			
2	1	10	0.01	463003	PS1/2	2CDL 210 001 R1002		0.01	180
3	1	10	0.03	514651	PS1/3	2CDL 210 001 R1003		0.03	120
4	1	10	0.03	648233	PS1/4	2CDL 210 001 R1004		0.03	100
6	1	10	0.03	463102	PS1/6	2CDL 210 001 R1006		0.03	60
9	1	10	0.04	463201	PS1/9	2CDL 210 001 R1009		0.04	30
12	1	10	0.05	463300	PS1/12	2CDL 210 001 R1012		0.05	30
12	1	10a	0.05	682985	PS1/12A ②	2CDL 210 010 R1012		0.05	30

3-phase busbars, pin distance 17.6 mm

No. of pins	Phases	mm ²	Cu-No. kg	Bbn 4016779 EAN	Order details		Price 1 piece	Weight 1 piece kg	Pack unit pc.
					Type code	Order code			
6	3	10	0.04	463409	PS3/6	2CDL 231 001 R1006		0.04	60
9	3	10	0.07	463508	PS3/9	2CDL 231 001 R1009		0.07	30
12	3	10	0.10	463607	PS3/12	2CDL 231 001 R1012		0.10	30
12	3	10	0.10	463706	PS3/12FI *	2CDL 231 002 R1012		0.09	50

* phase sequence: L1, L2, L3, free, L2, L3, L1, ...

Busbars suitable for cutting

1-phase busbars, pin distance 17.6 mm, end caps PS-END 0

No. of pins	Phases	mm ²	Cu-No. kg	Bbn 4016779 EAN	Order details		Price 1 piece	Weight 1 piece kg	Pack unit pc.
					Type code	Order code			
60	1	10	0.26	514668	PS1/60	2CDL 210 001 R1060		0.26	20
60	1	10	0.26	682992	PS1/60A ②	2CDL 210 010 R1060		0.28	50
60	1	16	0.41	516655	PS1/60/16	2CDL 210 001 R1660		0.41	20
60	1	16	0.41	683005	PS1/60/16A ②	2CDL 210 010 R1660		0.39	50
5	1	30	0.04	653244	PS1/5/30 ①	2CDL 210 001 R3005		0.04	100
10	1	30	0.09	653268	PS1/10/30 ①	2CDL 210 001 R3010		0.09	100
11	1	30	0.09	653275	PS1/11/30 ①	2CDL 210 001 R3011		0.10	100
14	1	30	0.120	653282	PS1/14/30 ①	2CDL 210 001 R3014		0.120	50
15	1	30	0.130	653299	PS1/15/30 ①	2CDL 210 001 R3015		0.130	50
18	1	30	0.150	653305	PS1/18/30 ①	2CDL 210 001 R3018		0.150	50
19	1	30	0.160	653312	PS1/19/30 ①	2CDL 210 001 R3019		0.160	50
60	1	30	0.520	653596	PS1/60/30	2CDL 210 001 R3060		0.520	20

1-phase busbars, connection of 1-pole devices with auxiliary, end caps PS-END 0

No. of pins	Phases	mm ²	Cu-No. kg	Bbn 4016779 EAN	Order details		Price 1 piece	Weight 1 piece kg	Pack unit pc.
					Type code	Order code			
38	1	10	0.27	586139	PS1/38H	2CDL 210 001 R1038		0.27	30
38	1	16	0.45	586146	PS1/38/16H	2CDL 210 001 R1638		0.45	30

① inclusive of end caps

② pre-cutted pins

1-phase busbars, connection of neutral (blue insulation), end caps END 1.1

No. of pins	Phases	mm ²	Cu-No.	Bbn 4016779	Order details		Price 1 piece	Weight 1 piece	Pack unit
			kg	EAN	Type code	Order code			
28	1	10	0.24	629546	PS1/28N	2CDL 210 001 R1028		0.14	50
28	1	16	0.32	629560	PS1/28/16N	2CDL 210 001 R1628		0.20	50
57	1	10	0.24	579728	PS1/57NA ②	2CDL 210 011 R1057		0.14	50
57	1	10	0.24	629539	PS1/57N	2CDL 210 001 R1057		0.14	50
57	1	16	0.32	579735	PS1/57/16NA ②	2CDL 210 011 R1657		0.20	50
57	1	16	0.32	629553	PS1/57/16N	2CDL 210 001 R1657		0.20	50

1-phase busbars, connection of auxiliaries, end caps END 1.1 except PS 1/57/6

No. of pins	Phases	mm ²	Cu-No.	Bbn 4016779	Order details		Price 1 piece	Weight 1 piece	Pack unit
			kg	EAN	Type code	Order code			
23	1	6	0.16	584739	PS1/23/6	2CDL 210 005 R0623		0.09	50
29	1	6	0.14	580823	PS1/29/6	2CDL 210 005 R0629		0.10	50
38	1	6	0.14	580816	PS1/38/6	2CDL 210 005 R0638		0.09	50
57	1	6	0.11	585309	PS1/57/6	2CDL 210 005 R0657		0.08	50

1-phase busbars, connection of hand operated neutral S2C-Nt (blue insulation), end caps END 1.1

No. of pins	Phases	mm ²	Cu-No.	Bbn 4016779	Order details		Price 1 piece	Weight 1 piece	Pack unit
			kg	EAN	Type code	Order code			
38	1	10	0.410	655361	PS1/38 NT	2CDL 210 002 R1038			10

2-phase busbars, pin distance 17.6 mm, end caps PS-END

No. of pins	Phases	mm ²	Cu-No.	Bbn 4016779	Order details		Price 1 piece	Weight 1 piece	Pack unit
			kg	EAN	Type code	Order code			
12	2	10	0.07	556521	PS2/12 ①	2CDL 220 001 R1012		0.08	50
12	2	10	0.07	584616	PS2/12A ①②	2CDL 220 010 R1012		0.08	50
12	2	16	0.11	646918	PS2/12/16	2CDL 220 001 R1612		0.09	50
58	2	10	0.32	556552	PS2/58	2CDL 220 001 R1058		0.36	10
58	2	16	0.55	556569	PS2/58/16	2CDL 220 001 R1658		0.49	10
58	2	16	0.55	584746	PS2/58/16A ②	2CDL 220 010 R1658		0.49	10
58	2	30	1.81	654272	PS2/58/30 ③④	2CDL 220 001 R3058		1.81	10

Note: PS...A is a busbar with removable pin

2-phase busbars, connection of 2-pole devices with auxiliary, end caps PS-END

No. of pins	Phases	mm ²	Cu-No.	Bbn 4016779	Order details		Price 1 piece	Weight 1 piece	Pack unit
			kg	EAN	Type code	Order code			
48	2	10	0.47	556538	PS2/48H	2CDL 220 001 R1048		0.35	10
48	2	16	0.68	556545	PS2/48/16H	2CDL 220 001 R1648		0.48	10
48	2	16	0.68	584630	PS2/48/16HA ②	2CDL 220 012 R1648		0.48	10

① inclusive of end caps
 ② pre-cutted pins
 ③ use end cap PS-END 3
 ④ removal of installed MCB not possible

Busbars and accessories for MCBs S 200, RCDs F 200 and DS 200 series

3-phase busbars, pin distance 17.6 mm, end caps PS-END									
No. of pins	Phases	mm ²	Cu-No.	Bbn 4016779	Order details		Price 1 piece	Weight 1 piece	Pack unit
					Type code	Order code			
			kg	EAN			kg	pc.	
11	3	10	0.10	649926	PS3/11 ①	2CDL 230 001 R1011		0.08	50
12	3	10	0.09	576116	PS3/12 ①	2CDL 230 001 R1012		0.09	50
12	3	10	0.09	584647	PS3/12A ①②	2CDL 230 010 R1012		0.09	50
12	3	16	0.16	562805	PS3/12/16 ①	2CDL 230 001 R1612		0.12	50
60	3	10	0.51	514699	PS3/60	2CDL 230 001 R1060		0.47	10
60	3	10	0.51	563758	PS3/60A ②	2CDL 230 010 R1060		0.47	10
60	3	16	0.76	514705	PS3/60/16	2CDL 230 001 R1660		0.65	10
60	3	16	0.76	563765	PS3/60/16A ②	2CDL 230 010 R1660		0.65	10
60	3	30	2.65	654289	PS3/60/30 ③⑤	2CDL 230 001 R3060		2.65	10

3-phase busbars, connection of 1-pole devices with auxiliary, end caps PS-END									
No. of pins	Phases	mm ²	Cu-No.	Bbn 4016779	Order details		Price 1 piece	Weight 1 piece	Pack unit
					Type code	Order code			
			kg	EAN			kg	pc.	
39	3	10	0.51	556590	PS3/39H	2CDL 230 001 R1039		0.43	10
39	3	16	0.76	556606	PS3/39/16H	2CDL 230 001 R1639		0.60	10

3-phase busbars, connection of 2-pole devices (Phase+N) with auxiliary, end caps PS-END									
No. of pins	Phases	mm ²	Cu-No.	Bbn 4016779	Order details		Price 1 piece	Weight 1 piece	Pack unit
					Type code	Order code			
			kg	EAN			kg	pc.	
24	3	10	0.80	556576	PS3/24H	2CDL 230 001 R1024		0.41	10

3-phase busbars, connection of 2-pole devices (Phase+Phase) with auxiliary, end caps PS-END									
No. of pins	Phases	mm ²	Cu-No.	Bbn 4016779	Order details		Price 1 piece	Weight 1 piece	Pack unit
					Type code	Order code			
			kg	EAN			kg	pc.	
46	3	16	0.98	662109	PS3/46/16H-IT	2CDL 230 001 R1646		0.98	10

3-phase busbars, connection of 3-pole devices with auxiliary, end caps PS-END									
No. of pins	Phases	mm ²	Cu-No.	Bbn 4016779	Order details		Price 1 piece	Weight 1 piece	Pack unit
					Type code	Order code			
			kg	EAN			kg	pc.	
48	3	10	0.51	556613	PS3/48H	2CDL 230 001 R1048		0.43	10
48	3	16	0.76	556644	PS3/48/16H	2CDL 230 001 R1648		0.60	10
48	3	16	0.76	584654	PS3/48/16HA ②	2CDL 230 012 R1648		0.60	10

3-phase busbars, connection of 1+N or RCBOs, end caps PS-END									
No. of pins	Phases	mm ²	Cu-No.	Bbn 4016779	Order details		Price 1 piece	Weight 1 piece	Pack unit
					Type code	Order code			
			kg	EAN			kg	pc.	
30	3	10	0.50	556583	PS3/30	2CDL 230 001 R1030		0.42	10

- ① inclusive of end caps
- ② pre-cutted pins
- ③ use end cap PS-END 3
- ④ use end cap PS-END 3.1
- ⑤ removal of installed MCB not possible

3-phase busbars, N of the RCD omitted, end caps PS-END

No. of pins	Phases	mm ²	Cu-No.	Bbn 4016779	Order details		Price 1 piece	Weight 1 piece	Pack unit
			kg	EAN	Type code	Order code			
9	3	10	0.10	517515	PS3/9FI ①	2CDL 230 002 R1009		0.06	50
10	3	10	0.10	517522	PS3/10FI ①	2CDL 230 002 R1010		0.07	50
12	3	10	0.11	571074	PS3/12FI ①	2CDL 230 002 R1012		0.09	50
57	3	10	0.55	556651	PS3/57FI	2CDL 230 002 R1057		0.46	10

3-phase busbars, N of the RCD omitted, with auxiliary at RCD end caps PS-END

No. of pins	Phases	mm ²	Cu-No.	Bbn 4016779	Order details		Price 1 piece	Weight 1 piece	Pack unit
			kg	EAN	Type code	Order code			
12	3	10	0.11	571081	PS3/12FIH ①	2CDL 230 003 R1012		0.09	50

4-phase busbars, pin distance 17.6 mm, end caps PS-END 1

No. of pins	Phases	mm ²	Cu-No.	Bbn 4016779	Order details		Price 1 piece	Weight 1 piece	Pack unit
			kg	EAN	Type code	Order code			
12	4	10	0.12	656054	PS4/12 ①	2CDL 240 101 R1012		0.11	30
12	4	10	0.12	656061	PS4/12A ①②	2CDL 240 110 R1012		0.11	30
12	4	16	0.24	656078	PS4/12/16 ①	2CDL 240 101 R1612		0.16	30
60	4	10	0.80	656085	PS4/60	2CDL 240 101 R1060		0.64	10
60	4	16	1.21	656092	PS4/60/16	2CDL 240 101 R1660		0.89	10
60	4	16	1.21	656108	PS4/60/16A ②	2CDL 240 110 R1660		0.89	10
60	4	30	3.37	654296	PS4/60/30 ④⑤	2CDL 240 001 R3060		3.37	10

Note: PS...A is a busbar with removable pin

4-phase busbars, connection of 4-pole devices with auxiliary, end caps PS-END 1

No. of pins	Phases	mm ²	Cu-No.	Bbn 4016779	Order details		Price 1 piece	Weight 1 piece	Pack unit
			kg	EAN	Type code	Order code			
52	4	16	1.30	656115	PS4/52/16H	2CDL 240 101 R1652		0.78	10
52	4	16	1.30	656122	PS4/52/16HA ②	2CDL 240 212 R1652		0.78	10

4-phase busbars, connection of 1+N or RCBOs, end caps PS-END 1

No. of pins	Phases	mm ²	Cu-No.	Bbn 4016779	Order details		Price 1 piece	Weight 1 piece	Pack unit
			kg	EAN	Type code	Order code			
12	4	10	0.14	656139	PS4/12NA ①②	2CDL 240 213 R1012		0.10	30
58	4	10	0.80	656146	PS4/58N	2CDL 240 101 R1058		0.59	10
58	4	16	1.21	656153	PS4/58/16N	2CDL 240 101 R1658		0.77	10
58	4	16	1.21	656221	PS4/58/16NA ②	2CDL 240 213 R1658		0.77	10

① inclusive of end caps
 ② pre-cutted pins
 ③ use end cap PS-END 3
 ④ use end cap PS-END 3.1
 ⑤ removal of installed MCB not possible

Busbars and accessories for MCBs S 200, RCDs F 200 and DS 200 series

4-phase busbars, connection of 1+N or RCBOs with auxiliary, end caps PS-END 1									
No. of pins	Phases	mm ²	Cu-No.	Bbn 4016779	Order details		Price 1 piece	Weight 1 piece	Pack unit
					Type code	Order code			
48	4	16	1.48	656160	PS4/48/16NHA ②	2CDL 240 114 R1648		0.76	10

4-phase busbars, connection of 4-pole RCD with 1+N , end caps PS-END 1									
No. of pins	Phases	mm ²	Cu-No.	Bbn 4016779	Order details		Price 1 piece	Weight 1 piece	Pack unit
					Type code	Order code			
58	4	10	0.80	656177	PS4/58NNA ②	2CDL 240 110 R1058		0.58	10
58	4	16	1.21	656184	PS4/58/16NNA ②	2CDL 240 110 R1658		0.80	10

- ① inclusive of end caps
- ② pre-cutted pins
- ③ use end cap PS-END 3
- ④ use end cap PS-END 3.1
- ⑤ removal of installed MCB not possible



PS2/6/16 BP



BSK BP



AST35/15BP



SZ-ESK BP

Pre-assembled busbars (not to be cut) UL 489 only suitable for S200U and S200UP

1-phase busbars, pin distance 17.6 mm, UL 489

No. of pins	Phases	mm ²	Cu-No.	Bbn	Order details		Price 1 piece	Weight 1 piece	Pack unit
			kg	4016779	Type code	Order code			
6	1	16	0.04	644969	PS 1/6/16 BP	2CDL 210 489 R1606		0.05	1
12	1	16	0.07	644976	PS 1/12/16 BP	2CDL 210 489 R1612		0.11	1
18	1	16	0.11	644983	PS 1/18/16 BP	2CDL 210 489 R1618		0.16	1

2-phase busbars, pin distance 17.6 mm, UL489

No. of pins	Phases	mm ²	Cu-No.	Bbn	Order details		Price 1 piece	Weight 1 piece	Pack unit
			kg	4016779	Type code	Order code			
6	2	16	0.07	644990	PS 2/6/16 BP	2CDL 220 489 R1606		0.06	1
12	2	16	0.14	645003	PS 2/12/16 BP	2CDL 220 489 R1612		0.13	1
18	2	16	0.21	645010	PS 2/18/16 BP	2CDL 220 489 R1618		0.20	1

3-phase busbars, pin distance 17.6 mm, UL 489

No. of pins	Phases	mm ²	Cu-No.	Bbn	Order details		Price 1 piece	Weight 1 piece	Pack unit
			kg	4016779	Type code	Order code			
6	3	16	0.11	645027	PS 3/6/16 BP	2CDL 230 489 R1606		0.07	1
12	3	16	0.22	645034	PS 3/12/16 BP	2CDL 230 489 R1612		0.15	1
18	3	16	0.33	645041	PS 3/18/16 BP	2CDL 230 489 R1618		0.24	1

Shock-protection caps for PS...BP (UL 489)

No. of pins	Phases	mm ²	Cu-No.	Bbn	Order details		Price 1 piece	Weight 1 piece	Pack unit
			kg	4016779	Type code	Order code			
	3 parts			656368	BSK BP	2CDL 200 489 R0001		0.001	10

Feeder Terminals for PS...BP (UL 489)

Technical features	
	Feeder terminals SZ-ESK BP, AST 35/15 BP
Max. operating voltage	480 V AC
Max. current	80 A (115 A for cubicle size ≥ 30" x 30" x 10") ①
Protection degree	IP 20
Wire range	SZ-ESK PB: 35 mm ² / 2AWG flexible with ferrule 50 mm ² / 1AWG solid/stranded AST 35/15 BP: 25 mm ² / 3AWG flexible with ferrule 35 mm ² / 2AWG solid/stranded

① regardless of the rated current of the feeder terminal the maximum current rating of the device terminal may not be exceeded

Insulated with pin contact

Conn. capacity	Cu-No.	Bbn	Order details		Price 1 piece	Weight 1 piece	Pack unit
mm ²	kg	4016779	Type code	Order code			
35	0.035	710350	AST 35/15 BP	2CDL 201 489 R3515		0.035	25

Single-pole terminal, can be mounted side by side, feed on the pin of the busba

50		710367	SZ-ESK BP	2CDL 201 489 R5001		0.038	50
----	--	--------	-----------	--------------------	--	-------	----

- ① inclusive of end caps
- ② pre-cutted pins
- ③ use end cap PS-END 3
- ④ use end cap PS-END 3.1
- ⑤ removal of installed MCB not possible

Busbars and accessories for MCBs S 200, SN 201, RCDs F 200 and DS 200 series

Busbars (suitable for cutting) UL 1077 suitable for MCBs S200 and S200P

1-phase busbars, pin distance 17.6 mm, end caps PS-END 0

No. of pins	Phases	mm ²	Cu-No.	Bbn	Order details		Price 1 piece	Weight 1 piece	Pack unit
			kg	4016779	Type code	Order code			
60	1	10	0.26	830409	PS 1/60 SP	2CDL 210 111 R1060		0.26	20
60	1	16	0.41	830423	PS 1/60/16 SP	2CDL 210 111 R1660		0.41	20

1-phase busbars, connection of 1-pole devices with auxiliary, PS-END 0

No. of pins	Phases	mm ²	Cu-No.	Bbn	Order details		Price 1 piece	Weight 1 piece	Pack unit
			kg	4016779	Type code	Order code			
38	1	10	0.27	830430	PS 1/38H SP	2CDL 210 111 R1038		0.27	30
38	1	16	0.45	830447	PS 1/38/16H SP	2CDL 210 111 R1638		0.45	30

2-phase busbars, pin distance 17.6 mm, end caps PS-END SP

No. of pins	Phases	mm ²	Cu-No.	Bbn	Order details		Price 1 piece	Weight 1 piece	Pack unit
			kg	4016779	Type code	Order code			
58	2	10	0.42	646413	PS 2/58 SP	2CDL 220 111 R1058			10
58	2	16	0.69	646420	PS 2/58/16 SP	2CDL 220 111 R1658			10

2-phase busbars, connection of 2-pole devices with auxiliary, end caps PS-END SP

No. of pins	Phases	mm ²	Cu-No.	Bbn	Order details		Price 1 piece	Weight 1 piece	Pack unit
			kg	4016779	Type code	Order code			
48	2	16	0.68	646437	PS 2/48/16 HSP	2CDL 220 112 R1648			10

3-phase busbars, pin distance 17.6 mm, end caps PS-END SP

No. of pins	Phases	mm ²	Cu-No.	Bbn	Order details		Price 1 piece	Weight 1 piece	Pack unit
			kg	4016779	Type code	Order code			
60	3	10	0.68	646444	PS 3/60 SP	2CDL 230 111 R1060			10
60	3	16	1.02	646451	PS 3/60/16 SP	2CDL 230 111 R1660			10

3-phase busbars, connection of 3-pole devices with auxiliary, end caps PS-END SP

No. of pins	Phases	mm ²	Cu-No.	Bbn	Order details		Price 1 piece	Weight 1 piece	Pack unit
			kg	4016779	Type code	Order code			
48	3	16	1.16	646468	PS 3/48/16 HSP	2CDL 230 112 R1648			10

4-phase busbars, pin distance 17.6 mm, PS-END 1 SP

No. of pins	Phases	mm ²	Cu-No.	Bbn	Order details		Price 1 piece	Weight 1 piece	Pack unit
			kg	4016779	Type code	Order code			
60	4	16	1.97	656191	PS 4/60/16 SP	2CDL 240 311 R1660			10



4-phase busbars, connection of 1+N and RCBO, end caps PS-END 1 SP									
No. of pins	Phases	mm ²	Cu-No.	Bbn 4016779	Order details	Price 1 piece	Weight 1 piece	Pack unit	
			kg	EAN	Type code	Order code	kg	pc.	
58	4	16	1.86	656214	PS4/58/16N SP	2CDL 240 313 R1658		10	



Shock-protection caps for PS...SP (UL 1077)									
No. of pins	Phases	mm ²	Cu-No.	Bbn 4016779	Order details	Price 1 piece	Weight 1 piece	Pack unit	
			kg	EAN	Type code	Order code	kg	pc.	
	5 parts		0.001	710398	BSK SP	2CDL 200 111 R0001		100	

4



Feeder Terminals for PS...SP (UL 1077)									
Terminal, insulated with pin contact									
Conn. capacity	Cu-No.	Bbn 4016779	Order details	Price 1 piece	Weight 1 piece	Pack unit			
mm ²	kg	EAN	Type code	Order code	kg	pc.			
35	0.038	710374	AST 35/15 SP	2CDL 200 111 R3515	0.025	25			

Feeder Terminal single-pole terminal, can be mounted side by side, feed on the pin of the busbar									
Conn. capacity	Cu-No.	Bbn 4016779	Order details	Price 1 piece	Weight 1 piece	Pack unit			
mm ²	kg	EAN	Type code	Order code	kg	pc.			
50	0.038	710381	SZ-ESK SP	2CDL 200 111 R5001	0.032	50			

Suitable for MCBs S 200 and S200 P – UL 1077 (Supplementary Protection)

Technical features	
	Feeder terminals SZ-ESK SP, AST 35/15 SP
Max. operating voltage	480 VAC
Max. current	115 A Ⓞ
Protection degree	IP 20
Wire range	SZ-ESK SP: 35 mm ² / 2AWG flexible with ferrule 50 mm ² / 1AWG solid/stranded AST 35/15 SP: 25 mm ² / 3AWG flexible with ferrule 35 mm ² / 2AWG solid/stranded

Ⓞ regardless of the rated current of the feeder terminal the maximum current rating of the device terminal

Busbars and accessories for MCBs S 200, SN 201, RCDs F 200 and DS 200 series

4-phase busbars, pin distance 17.6 mm, PS-END 1 SP									
No. of pins	Phases	mm ²	Cu-No.	Bbn 4016779	Order details		Price 1 piece	Weight 1 piece	Pack unit
			kg	EAN	Type code	Order code		kg	pc.
60	4	16	1.97	656191	PS 4/60/16 SP	2CDL 240 311 R1660			10

4-phase busbars, connection of 4-pole devices with auxiliary, end caps PS-END 1 SP									
No. of pins	Phases	mm ²	Cu-No.	Bbn 4016779	Order details		Price 1 piece	Weight 1 piece	Pack unit
			kg	EAN	Type code	Order code		kg	pc.
52	4	16	1.90	656207	PS 4/52/16H SP	2CDL 240 312 R1652			10

4-phase busbars, connection of 1+N and RCBO, end caps PS-END 1 SP									
No. of pins	Phases	mm ²	Cu-No.	Bbn 4016779	Order details		Price 1 piece	Weight 1 piece	Pack unit
			kg	EAN	Type code	Order code		kg	pc.
58	4	16	1.86	656214	PS4/58/16N SP	2CDL 240 313 R1658			10

Shock-protection caps for PS...SP (UL 1077)

No. of pins	Phases	mm ²	Cu-No.	Bbn 4016779	Order details		Price 1 piece	Weight 1 piece	Pack unit
			kg	EAN	Type code	Order code		kg	pc.
	5 parts		0.001	710398	BSK SP	2CDL 200 111 R0001			100

Feeder Terminals for PS...SP (UL 1077)

Terminal, insulated with pin contact									
Conn. capacity	Cu-No.	Bbn 4016779	Order details		Price 1 piece	Weight 1 piece	Pack unit		
mm ²	kg	EAN	Type code	Order code		kg	pc.		
35	0.038	710374	AST 35/15 SP	2CDL 200 111 R3515		0.025	25		

Feeder Terminal single-pole terminal, can be mounted side by side, feed on the pin of the busbar									
Conn. capacity	Cu-No.	Bbn 4016779	Order details		Price 1 piece	Weight 1 piece	Pack unit		
mm ²	kg	EAN	Type code	Order code		kg	pc.		
50	0.038	710381	SZ-ESK SP	2CDL 200 111 R5001		0.032	50		

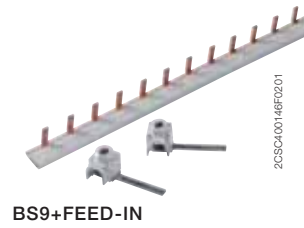

BS9+FEED-IN

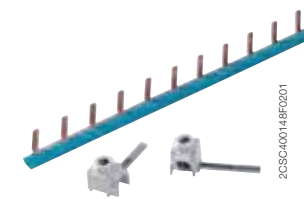

BS9 NA+FEED-IN

Busbars for SN 201 range (Maximum rated current 63 A)

No. pins	Phases	Cross section mm ²	Bbn 8012542		Order details		Price 1 piece	Weight 1 piece kg	Pack unit pc.
			EAN	Type code	Order code				
12	1	10	047650	BS9 1/12	2CSL910001R1012		0.050	10	
12	1	10	047759	BS9 1/12 NA	2CSL910011R1012		0.050	10	
56	1	10	047353	BS9 1/56	2CSL910001R1056		0.140	10	
56	1	10	047452	BS9 1/56 NA	2CSL910011R1056		0.140	10	
12	3	10	047551	BS9 3/12	2CSL930001R1012		0.090	5	
57	3	10	047858	BS9 3/57	2CSL930001R1057		0.470	5	

4

Busbars for F200/S200 and SN 201 range (Maximum rated current 63 A)

No. pins	Phases	Cross section mm ²	Bbn 8012542		Order details		Price 1 piece	Weight 1 piece kg	Pack unit pc.
			EAN	Type code	Order code				
2 + 10 x 1+N	2	10	046950	BF2-S9 UP 1N/12	2CSL920009R1012		0,110	5	
4 + 8 x 1+N	4	10	047056	BF2-S9 UP 3N/12	2CSL940009R1012		0,110	5	
2 + 10 x 1+N	2	10	047155	BF2-S9 DOWN 1N/12	2CSL920002R1012		0,110	5	
4 + 8 x 1+N	4	10	047254	BF2-S9 DOWN 3N/12	2CSL940002R1012		0,110	5	

Terminals, insulated

Conn. capacity mm ²	Type of connection	Terminal lug L mm	Bbn 8012542		Order details		Price 1 piece	Weight 1 piece kg	Pack unit pc.
			EAN	Type code	Order code				
25	pin	15	047957	FEED-IN 25/15 1P	2CSL980001R2515		0.010	5	
25	pin	30	048053	FEED-IN 25/30 3P	2CSL980001R2530		0.010	5	

End caps

	Bbn 4012233		Order details		Price 1 piece	Weight 1 piece kg	Pack unit pc.
	EAN	Type code	Order code				
	064251	BS9-END 3P ①	2CSL980001R0001		0.001	20	

① In combination with BS9 3/57

Busbars and accessories for MCBs S 200, SN 201, RCDs F 200 and DS 200 series

Busbars (suitable for cutting) for DDA 200 and DS 200 – bottom mounting (RCD)

3-phase busbars, connection of DDA 202 and DS 202, end caps PSB-END 3
(phase sequence L1-L2-free-free-L3-L1.....without N)

No. of pins	Phases	mm ²	Cu-No.	Bbn 4016779	Order details		Price 1 piece	Weight 1 piece	Pack unit
					Type code	Order code			
			kg	EAN				kg	pc.
30	3	10	0.97	647472	PS 3/30-DDA 202	2CDL 230 202 R1030		0.41	10
30	3	16	1.46	647502	PS 3/30/16-DDA 202	2CDL 230 202 R1630		0.55	10

3-phase busbars, connection of DDA 202 and DS 202 with auxiliary, end caps PSB-END 3
(phase sequence L1-L2-aux.(free)-free-free-L3-L1-aux.(free).....without N)

No. of pins	Phases	mm ²	Cu-No.	Bbn 4016779	Order details		Price 1 piece	Weight 1 piece	Pack unit
					Type code	Order code			
			kg	EAN				kg	pc.
26	3	16		648912	PS 3/26/16H-DDA 202	2CDL 230 202 R1626			

4-phase busbars, connection of DDA 204 63 A and DS 204 50 A and 63 A, end caps PSB-END 4
(phase sequence L1-L2-L3-N-free-free-free-free-L1.....)

No. of pins	Phases	mm ²	Cu-No.	Bbn 4016779	Order details		Price 1 piece	Weight 1 piece	Pack unit
					Type code	Order code			
			kg	EAN				kg	pc.
32	4	10	1.41	647458	PS 4/32-DDA 204	2CDL 240 204 R1032		0.56	10
32	4	16	2.12	647465	PS 4/32/16-DDA 204	2CDL 240 204 R1632		0.77	10

Busbars (suitable for cutting) for DDA 200 and DS 200 – top side mounting (MCB)

2-phase busbars, connection of DDA 202 and DS 202, end caps PSB-END 3
(phase sequence L1-L2/N-free-free-.....)

No. of pins	Phases	mm ²	Cu-No.	Bbn 4016779	Order details		Price 1 piece	Weight 1 piece	Pack unit
					Type code	Order code			
			kg	EAN				kg	pc.
30	2	16	0.512	697675	PS 2/30/16N-DDA 202T	2CDL 020 202 R1630			10

3-phase busbars, connection of DDA 202 and DS 202, end caps PSB-END 3
(phase sequence L1-L2-free-free-L3-L1.....without N)

No. of pins	Phases	mm ²	Cu-No.	Bbn 4016779	Order details		Price 1 piece	Weight 1 piece	Pack unit
					Type code	Order code			
			kg	EAN				kg	pc.
30	3	16	1.25	652629	PS 3/30/16-DDA 202T	2CDL 033 202 R1630			10

3-phase busbars, connection of DDA 202 and DS 202 with auxiliary, end caps PSB-END 3
(phase sequence L1-L2-aux.(free)-free-free-L3-L1-aux.(free).....without N)

No. of pins	Phases	mm ²	Cu-No.	Bbn 4016779	Order details		Price 1 piece	Weight 1 piece	Pack unit
					Type code	Order code			
			kg	EAN				kg	pc.
28	3	16	1.31	652636	PS 3/28/16H-DDA 202T	2CDL 034 202 R1628			10

4-phase busbars, connection of DDA 202 and DS 202, end caps PSB-END 4
(phase sequence L1-N-free-free-L2-N...)

No. of pins	Phases	mm ²	Cu-No.	Bbn 4016779	Order details		Price 1 piece	Weight 1 piece	Pack unit
					Type code	Order code			
			kg	EAN				kg	pc.
30	4	16	1.67	652852	PS 4/30/16N-DDA 202T	2CDL 040 202 R1630			10

4-phase busbars, connection of DDA 202 and DS 202 with auxiliary, end caps PSB-END 4 (phase sequence L1-N-aux.(free)-free-free-L2-N-aux.(free)...))									
No. of pins	Phases	mm ²	Cu-No.	Bbn 4016779	Order details		Price 1 piece	Weight 1 piece	Pack unit
			kg	EAN	Type code	Order code		kg	pc.
30	4	16	1.72	652599	PS 4/30/16NH-DDA 202T	2CDL 041 202 R1630			10

4-phase busbars, connection of DDA 204 25 A and 40 A and DS 204 up to 40 A, end caps PSB-END 4 (phase sequence L1-L2-L3-N-free-free-L1.....)									
No. of pins	Phases	mm ²	Cu-No.	Bbn 4016779	Order details		Price 1 piece	Weight 1 piece	Pack unit
			kg	EAN	Type code	Order code		kg	pc.
40	4	16	1.79	652605	PS 4/40/16-DDA 204T	2CDL 040 204 R1640			10

4-phase busbars, connection of DDA 204 25 A and 40 A and DS 204 up to 40 A with auxiliary, end caps PSB-END 4 (phase sequence L1-L2-L3-N-aux.(free)-free-free-free-L1)									
No. of pins	Phases	mm ²	Cu-No.	Bbn 4016779	Order details		Price 1 piece	Weight 1 piece	Pack unit
			kg	EAN	Type code	Order code		kg	pc.
36	4	16	1.73	652612	PS 4/36/16H-DDA 204T	2CDL 041 204 R1636			10

End caps

No. of pins	Phases	mm ²	Cu-No.	Bbn 4016779	Order details		Price 1 piece	Weight 1 piece	Pack unit
			kg	EAN	Type code	Order code		kg	pc.
				638913	END 1.1	2CDL 200 011 R0011		0.001	50
				652261	PS-END 0	2CDL 200 001 R0004		0.001	50
				514729	PS-END	2CDL 200 001 R0001		0.001	50
				570114	PS-END 1	2CDL 200 001 R0002		0.001	50
				646505	PS-END SP	2CDL 200 110 R0001		0.001	50
				646512	PS-END 1 SP	2CDL 200 110 R0002		0.001	50
				654302	PS-END 3	2CDL 200 001 R3001		0.001	50
				654319	PS-END 3.1	2CDL 200 001 R3002		0.001	50
				556304 ①	PSB-END 3	GHV0 361 325 R0001		0.001	50
				556403 ①	PSB-END 4	GHV0 361 325 R0002		0.001	50

© bbn-No. 4012233

Accessories for S 200, SN 201, F 200, DS 200 and other series

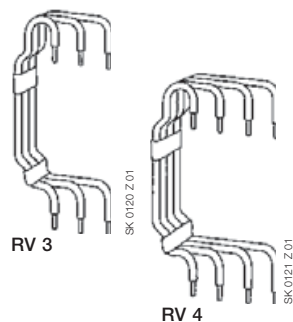

Rail connectors

For wiring of component rails in the consumer unit, rail-to-rail clearance 125 mm. In the case of the 4-pole connector, the color of the N conductor is blue.

No. of pins	Phases	mm ²	Cu-No.	Bbn 4016779	Order details		Price 1 piece	Weight 1 piece	Pack unit
					Type code	Order code			
10	3-pole			512381	RV 3	GH V036 0504 R0023		0.080	25
10	4-pole			512244	RV 4	GH V036 0504 R0024		0.114	25

Auxiliary contact bridge for bottom-fitting auxiliary contacts

Wire jumper for integrated auxiliary contact (MCB S200 H or auxiliary contacts S2C-H01/S2C-H10) for series connections (HKB) or parallel connections (HKB1).

No. of pins	Phases	mm ²	Cu-No.	Bbn 4016779	Order details		Price 1 piece	Weight 1 piece	Pack unit
					Type code	Order code			
	1/2 mod.				523134	GH V036 0504 R0100		0.001	1000
	1 mod.				524209	GH V036 0504 R0101		0.001	1000

Shock-protection caps for PS...

No. of pins	Phases	mm ²	Cu-No.	Bbn 4016779	Order details		Price 1 piece	Weight 1 piece	Pack unit
					Type code	Order code			
	5 parts			420006	SZ-BSK	2CDL 200 001 R0011		0.003	10
	5 parts			649834	BSK*	2CDL 200 001 R0012		0.003	10

* closed version

Shock-protection caps for busbars

PS...BP - see page 4/26

PS...SP - see page 4/27

Labelling system

Package comes with 40 labels, marked or blank. Blank labels can be labeled by hand with an indelible, waterproof pen or using a computerised labelling system (plotter).

Description	Bbn 4016779	Order details		Price 1 piece	Weight 1 piece	Pack unit
		Type code	Order code			
identification labels blank	478106	BS	GH S200 1946 R0001		0.004	30
identification labels with pictograms	478205	BS Pikto	GH S200 1946 R0002		0.004	30
identification labels marked 4 x 1 – 10	478304	BS 1/10	GH S200 1946 R0003		0.004	30
identification labels marked 2 x 1 – 20	478403	BS 1/20	GH S200 1946 R0004		0.004	30
identification labels marked 1 – 40	478502	BS 1/40	GH S200 1946 R0005		0.004	30
identification labels marked 41 – 80	585910	BS 41 – 80	GH S200 1946 R0006		0.004	30
identification labels marked 81 – 120	585927	BS 81 – 120	GH S200 1946 R0007		0.004	30
identification labels marked 121 – 160	585934	BS 121/160	GH S200 1946 R0008		0.004	30



identification label

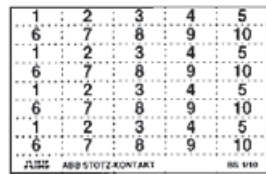

BS 1/10 Sk 0103 299

Identification system ILS

The ILS individual identification system for labels is a DIN A5 polyester film for ink jet and laser printers with high temperature resistance. (If laser printers are used, please check whether self-adhesive film with thickness of 250 µm can be fed.) Adhesive coating 3MTM9471 LE has obtained UL approval (file No. MH 11410). There are two types of sheet: uncut for making individual labels or precut with 23 stripes (6 x 191 mm each) for labelling 11 devices (1-module width) per stripe. Word template can be downloaded from www.abb.de/stotz-kontakt. Can also be used as write-on labels (ink, ballpoint pen, pencil, marker).

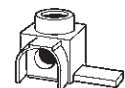

5006024

- Ast 25/15 QS
- Ast 25/15 Q
- Ast 25/30 QS
- Ast 25/30 Q
- Ast 50/15 QS
- Ast 50/15 Q
- Ast 50/18 Q
- Ast 50/32 Q

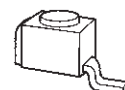

50118201

SZ-Ast 95 gk

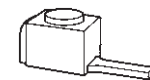

SZ-Ast 95

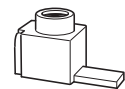

2000062220F0005

- Ast 25/15 S
- Ast 50/15 S
- Ast 50/15
- Ast 50/18

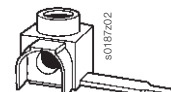

50187602

Ast 50/32 Q

4

Description	Bbn 4016779	Order details		Price 1 piece	Weight 1 piece	Pack unit
	EAN	Type code	Order code			
1 sheet DIN A5 uncut for laser printer	663076	ILS-L	2CDL 200 002 R0003		0.011	1
1 sheet DIN A5 precut in 23 stripes (6 x 191 mm) for laser printer	663083	ILS-LS	2CDL 200 002 R0004		0.011	1
1 sheet DIN A5 uncut for inkjet printer	663090	ILS-I	2CDL 200 002 R0005		0.011	1
1 sheet DIN A5 precut in 23 stripes (6 x 191 mm) for inkjet printer	663106	ILS-IS	2CDL 200 002 R0006		0.011	1

Terminals, insulated with pin contact

Technical features			
Connection capacity	6-25 mm ²	6-50 mm ²	25-95 mm ²
Max. electrical load	63 A	100 A	225 A
Max. operating voltage	600 V AC	600 V AC	690 V AC
Max. tightening torque	2 Nm	3 Nm	19 Nm

Conn. capacity mm ²	Terminal lug LxW mm	Type of connection	Cu-No. kg	Bbn 4016779	Order details		Price 1 piece	Weight 1 piece kg	Pack unit pc.
				EAN	Type code	Order code			
6-25	15/4	90°	0.012	656535	Ast 25/15 QS	2CDL200010R2515			50
6-25	15/4	straight	0.012	656542	Ast 25/15 S	2CDL200011R2515			50
6-25	15/6	90°	0.012	656474	Ast 25/15 Q	2CDL200000R2515			50
6-25	22/4	90°	0.012	669436	Ast 25/22 QS	2CDL200010R2522			50
6-25	30/4	90°	0.012	656481	Ast 25/30 QS	2CDL200010R2530			50
6-25	30/6	90°	0.014	656498	Ast 25/30 Q	2CDL200000R2530			50
6-50	15/4	90°	0.014	656504	Ast 50/15 QS	2CDL200000R5015			50
6-50	15/4	straight	0.014	656566	Ast 50/15 S	2CDL200011R5015			50
6-50	15/7	90°	0.014	656559	Ast 50/15 Q	2CDL200010R5015			50
6-50	15/7	straight	0.014	656511	Ast 50/15	2CDL200001R5015			50
5-50	17.5/7	90°	0.019	656580	Ast 50/18 Q	2CDL200100R5018			50
6-50	17.5/7	straight	0.019	656573	Ast 50/18	2CDL200101R5018			50
6-50	32/6	90°	0.017	656528	Ast 50/32 Q	2CDL200000R5032			50
25-95	21/6.5	straight	0.06	522618	SZ-Ast 95 gk*	GHV0360501R0012		0.067	50
25-95	21/6.5	straight	0.06	522625	SZ-Ast 95*	GHV0360501R0013		0.067	50

Abbreviations: Q terminal 90° * not for pro M compact S narrow connection pin

Accessories for S 200, SN 201, F 200, DS 200 and other series



SZ-ESK 2

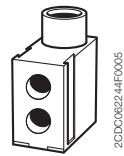

SZ-ESK 3

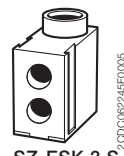

SZ-ESK 3 S



SZ-DB 121



SZ-DB 232 N



SZ-DB 125 N

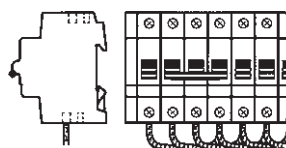

example 1
wiring of devices consisting of
modules with different lengths with
SZ-DB 125 N or 312

Feeder terminals

Single-pole terminals can be mounted side by side with multipole terminals.

Conn. capacity	Terminal lug	Type of connection	Cu-No.	Bbn 4016779	Order details		Price 1 piece	Weight 1 piece	Pack unit
mm ²	LxW mm		kg	EAN	Type code	Order code		kg	pc.
6-35				646765	SZ-ESK 2	2CDL200001R3501		0.024	10
6-50				652575	SZ-ESK 3	2CDL200003R5001		0.025	10
6-50				652889	SZ-ESK 3 S	2CDL200003R5003		0.024	10

Flexible connecting wires

Advantages:

- smaller dimensions for the same cross-section (more space in terminal)
- nearly no transition resistances
- more reliability; conductor sleeves could be loosen under specific conditions

with fork-type cable lug (black)

Conn. capacity	Lenght		Bbn 4012233	Order details		Price 1 piece	Weight 1 piece	Pack unit
mm ²			EAN	Type code	Order code		kg	pc.
6	125	0.006	55650 2	SZ-DB 121	GH V036 1425 R0001		0.025	1000/50
10	135	0.010	55670 0	SZ-DB 122 N	GH V036 1425 R0031		0.02	500/25
6	260	0.014	55680 9	SZ-DB 231 N	GH V036 1425 R0032		0.02	500/25
10		0.022	55690 8	SZ-DB 232 N	GH V036 1425 R0033		0.04	250/25
10	330	0.029	55700 4	SZ-DB 311	GH V036 1425 R0034		0.05	100/25

with fork-type cable lug and ultrasonic compacted cable ends (black)

Conn. capacity	Lenght		Bbn 4012233	Order details		Price 1 piece	Weight 1 piece	Pack unit
mm ²			EAN	Type code	Order code		kg	pc.
6	125	0.007	55660 1	SZ-DB 123	GH V036 1425 R0006		0.01	1000/50
10	135	0.012	55710 3	SZ-DB 124 N	GH V036 1425 R0035		0.02	500/25
6	260	0.014	55720 2	SZ-DB 235	GH V036 1425 R0036		0.02	500/25
10		0.024	55730 1	SZ-DB 236	GH V036 1425 R0037		0.04	250/25

with ultrasonic compacted cable ends (black)

Conn. capacity	Lenght		Bbn 4012233	Order details		Price 1 piece	Weight 1 piece	Pack unit
mm ²			EAN	Type code	Order code		kg	pc.
6	125	0.007	55740 0	SZ-DB 125 N	GH V036 1425 R0038		0.01	1000/50
6	260	0.015	55750 9	SZ-DB 233 N	GH V036 1425 R0039		0.02	500/25
10	135	0.013	55760 8	SZ-DB 126 N	GH V036 1425 R0040		0.02	500/25
10	260	0.025	55770 7	SZ-DB 234 N	GH V036 1425 R0041		0.04	250/25
10	330	0.032	55780 6	SZ-DB 312	GH V036 1425 R0042		0.05	100/25

with ultrasonic compacted cable ends (blue)

Conn. capacity	Lenght		Bbn 4012233	Order details		Price 1 piece	Weight 1 piece	Pack unit
mm ²			EAN	Type code	Order code		kg	pc.
10	135	0.013	66352 6	SZ-DB 10/135 N	2CDL 200 301 R0135		0.02	25
10	260	0.025	66353 3	SZ-DB 10/260 N	2CDL 200 301 R0260		0.04	25
10	330	0.032	66354 0	SZ-DB 10/330 N	2CDL 200 301 R0330		0.05	25

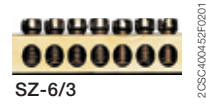

SZ-6/3

2CSC400435F0201



SZ-KLB 8, 12, 16, 24

2CSC400451F0201



SZ-Ktr

2CSC400438F0201



SZ-Ktr with KLB

2CSC400335F0201

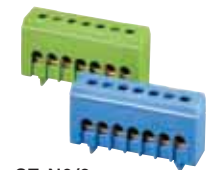

SZ-N6/3

2CSC400444F0201



SZ-N11/3

2CSC400446F0201

Neutral and protective-conductor terminals with insulation holder for quick fastening onto DIN rails EN 50 022

Input	Output	Bbn 4012233	Order details		Price 1 piece	Weight 1 piece	Pack unit
mm ²	mm ²	EAN	Type code	Order code		kg	pc.
1 x 16	6 x to 16	50592 5a	SZ-6/3	GH V036 0876 R0003		0.022	10
1 x 16	2 x to 16 6 x to 10	59660 7	SZ-KLB 8	GJ I232 0131 R0001		0.025	30
1 x 16	2 x to 16 10 x to 10	59530 3	SZ-KLB 12	GJ I232 0071 R0013		0.035	30
1 x 35	4 x to 16 12 x to 10	59540 2	SZ-KLB 16	GJ I232 0072 R0017		0.077	30
1 x 35	4 x to 16 20 x to 10	59550 1	SZ-KLB 24	GJ I232 0073 R0016		0.100	30

4

Holders for SZ-KLB terminals

Screw-fixing

SZ-KLB 8 and 12 each 1 piece required

SZ-KLB 16 and 24 each 2 pieces required

Conn. capacity	Lenght	Bbn 4012233	Order details		Price 1 piece	Weight 1 piece	Pack unit
mm ²		EAN	Type code	Order code		kg	pc.
		59450 4	SZ-Ktr	GJ I202 4027 R0001		0.003	100

Neutral and protective-conductor terminals with insulation holder for quick fastening onto DIN rails EN 50 022

Neutral with blue insulation holder; type C finger safe, conductor opening closed on one side

Input	Output	Bbn 4012233	Order details		Price 1 piece	Weight 1 piece	Pack unit
mm ²	mm ²	EAN	Type code	Order code		kg	pc.
1 x 16	6 x 16	55570 3	SZ-N 6/3	GH V036 0876 R0001		0.027	20
1 x 16	11 x 16	55580 2	SZ-N 11/3	GH V036 0876 R0002		0.043	20
1 x 16	6 x 16	57095 4 ①	SZ-N 6/3 C	GH V036 0876 R0011		0.028	20
1 x 16	6 x 16	57096 1 ①	SZ-N 11/3 C	GH V036 0876 R0012		0.046	20

Protective conductor with green/yellow insulation holder; type C finger safe, conductor opening closed on one side

Conn. capacity	Lenght	Bbn 4012233	Order details		Price 1 piece	Weight 1 piece	Pack unit
mm ²		EAN	Type code	Order code		kg	pc.
1 x 16	6 x 16	55600 7	SZ-PE 6/3	GH V036 0876 R0004		0.027	20
1 x 16	11 x 16	55610 6	SZ-PE 11/3	GH V036 0876 R0005		0.043	20
1 x 16	6 x 16	57097 8 ①	SZ-PE 6/3 C	GH V036 0876 R0014		0.028	20
1 x 16	11 x 16	57098 5 ①	SZ-PE 11/3 C	GH V036 0876 R0015		0.046	20

① bbn-No. 40 16779

Accessories for S 200, SN 201, F 200, DS 200 and other series



SZ-BP 1

2CSC400006R0201



SZ-B



SZ-BP 2

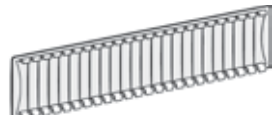

SZ-BP 12 G



SZ-BP R

2CSC400106R0201



SZ-VP 1500

2CSC400041R0201



END

2CSC400446R0201



SZ-FDT 2

2CSC400049R0201

Blanking plates

For device covers with materials of a thickness of 1 to 3 mm, width: 1 module = 17.5 mm; color: grey RAL 7035, white RAL 9001

Input	Output	Bbn 4012233	Order details		Price 1 piece	Weight 1 piece	Pack unit
mm ²	mm ²	EAN	Type code	Order code		kg	pc.
46/grey	213	06050 4	SZ-BP 1	GH L530 1904 R0001		0.028	100
46/white	17,5	12857 4 a	SZ-BP	GH S270 1913 R0001		0.005	
46/grey	17,5	12861 1 a	SZ-BP 2	GH S270 1913 R0002		0.005	
46/grey	220	65227 8 a	SZ-BP 12 G	2CDL 000 001 R1220		0.022	50
46/white	220	66355 7 b	SZ-BP 12 W	2CDL 000 001 R2220		0.020	50

	Bbn 4012233	Order details		Price 1 piece	Weight 1 piece	Pack unit
	EAN	Type code	Order code		kg	pc.
Locking devices for SZ-BP 12 G	652285 a	SZ-BP R	2CDL 000 001 R1001		0.001	30

Sealing plate

Seal-proof locking of stamped-out device covers.

Detachable only from the inside of the device cover.

Can be used for device covers with 1.5 to 3 mm material thickness.

Height of cutout/ color	Width	Bbn 4012233	Order details		Price 1 piece	Weight 1 piece	Pack unit
mm	mm	EAN	Type code	Order code		kg	pc.
46/grey	1500	60290 2	SZ-VP 1500	GJ I995 9038 R0001		0.366	10

End bracket

Prevents lateral shifting of built-in devices mounted on DIN rails according to DIN EN 60 715, 35 x 7.5 mm.

	Bbn 4012233	Order details		Price 1 piece	Weight 1 piece	Pack unit
	EAN	Type code	Order code		kg	pc.
	59090 2	END	GJ I100 1814 R0001		0.02	50

Filling piece

e.g. for heat dissipation of closely mounted devices that generate much heat. Width 8.75 mm, as spacer, two different heights, breakable, for DIN rails according to DIN EN 60 715, 35 x 7.5 mm.

	Bbn 4012233	Order details		Price 1 piece	Weight 1 piece	Pack unit
	EAN	Type code	Order code		kg	pc.
8.75	06070 2	SZ-FST 2	GH L530 1908 R0002		0.01	25

Spring piece

Holder for device covers, various heights available (in connection with FST 2 filling piece)

	Bbn 4012233	Order details		Price 1 piece	Weight 1 piece	Pack unit
	EAN	Type code	Order code		kg	pc.
	06080 1	SZ-FDT 2	GH L530 1908 R0005		0.002	25

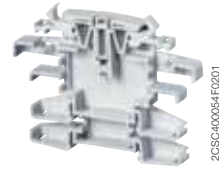

SZ-FST 2 + SZ-FDT 2



SZ-FST



SZ-FB 45.53-1



SZ-FB 45.53-3



FP

Filling piece

Two different heights, breakable, for DIN rails according to DIN EN 60 715, 35 x 7.5 mm for MCBs S 220 (3 different heights)

	Bbn 4012233	Order details		Price 1 piece	Weight 1 piece	Pack unit
	EAN	Type code	Order code		kg	pc.
8.75	59410 8	SZ-FST	GJ I148 0003 R0001		0.01	25

① bbn-Nr. 4016779

Spring catch for mounting devices onto DIN rails (DIN EN 60 715, 35 x 7.5)

	Bbn 4012233	Order details		Price 1 piece	Weight 1 piece	Pack unit
	EAN	Type code	Order code		kg	pc.
for screw type M4	64560 2	SZ-FB 45.53-3	GJ I184 2013 P0003		0.03	50
for screw type M5	64580 0	SZ-FB 45.53-1	GJ I184 2013 P0004		0.03	50

4

False poles

	Bbn 4012233	Order details		Price 1 piece	Weight 1 piece	Pack unit
	EAN	Type code	Order code		kg	pc.
False pole - 1 module	061304	FP1	16021765		0.01	100
False pole - 2 modules	061403	FP2	16021773		0.014	50
False pole - 4 modules	061502	FP4	16021781		0.022	30
False pole - 6 modules	061601	FP6	16021799		0.031	20
Support for false pole	061700	SFP	16021831		0.012	10

Accessories for S 200, SN 201, F 200, DS 200 and other series



DIN rails

DIN rails (DIN EN 60 715 – 35 x 7.5) for individual installation with 2 screws on an even surface (1 module = 17.5 mm)

	Bbn 4012233	Order details		Price 1 piece	Weight 1 piece	Pack unit
	EAN	Type code	Order code		kg	pc.
for 1 module	13580 6	DSW 1	GH S210 1926 R0001		0.060	10
for 2 modules	13590 5	DSW 2	GH S210 1926 R0002		0.012	10
for 3 modules	13600 1	DSW 3	GH S210 1926 R0003		0.018	10
for 4 modules	13610 0	DSW 4	GH S210 1926 R0004		0.024	10
for 6 modules	13620 9	DSW 6	GH S210 1926 R0006		0.036	10

DIN rail DIN EN 60 715, 35 x 7.5, material thickness 1 mm, surface protected, galvanised.

	Bbn 4012233	Order details		Price 1 piece	Weight 1 piece	Pack unit
	EAN	Type code	Order code		kg	pc.
241	04090 2	SKV-GTS 1	GH L110 1915 R0001		0.09	40

DIN rails DIN EN 60 715, 35 x 7.5, material thickness 1 mm, surface galvanised.

	Bbn 4012233	Order details		Price 1 piece	Weight 1 piece	Pack unit
	EAN	Type code	Order code		kg	pc.
1000	59730 7	SZ-SI 45.460	GJ I232 2218 R0001		0.35	10
2000	59760 4	SZ-TS 7.5 L2	GJ I232 2218 R0007		0.70	20

DIN rails DIN EN 60 715, 35 x 15, material thickness 1.5 mm, surface galvanised

	Bbn 4012233	Order details		Price 1 piece	Weight 1 piece	Pack unit
	EAN	Type code	Order code		kg	pc.
2000	59780 2	SZ-SI 45.472	GJ I232 2218 R0010		1.30	10
2000	59770 3	SZ-TS 15 L2	GJ I232 2218 R0009		0.78	10





S2C-DH

Rotary operating mechanism

For the actuation of 2-, 3- or 4pole miniature circuit-breakers in closed distribution boards for driveaxles of 5 or 6 mm² (square)

	Bbn 4012233	Order details		Price 1 piece	Weight 1 piece	Pack unit
	EAN	Type code	Order code		kg	pc.
	57960 5	S2C-DH	GH S200 1901 R0003		0.175	1

Handles

Handle IP 65, 65 x 65 mm, padlockable with max. 3 padlocks (bail diameter 5 - 8 mm), door interlock in ON-position, adjustable*

4



OH

Color	Suitable for switches	Bbn 4012233	Order details		Price 1 piece	Weight 1 piece	Pack unit
		EAN	Type code	Order code		kg	pc.
Black	OT16...40F	40978 8	OHBS2AJ	1SCA105213R1001			1
Yellow-red	OT16...40F	41226 9	OHYS2AJ	1SCA105296R1001			1
Silver	OT16...40F	41199 6	OHSS2AJ	1SCA105278R1001			1
Grey	OT16...40F	41186 6	OHGS2AJ	1SCA105265R1001			1

Handle IP 65, 65 x 65 mm, padlockable with max. 3 padlocks (bail diameter 5 - 8 mm), door interlock in ON-position



OXS6X

Color	Suitable for switches	Bbn 4012233	Order details		Price 1 piece	Weight 1 piece	Pack unit
		EAN	Type code	Order code		kg	pc.
Black	OT16...40F	41140 8	OHBS2AJ1	1SCA105215R1001			1
Yellow-red	OT16...40F	41227 6	OHYS2AJ1	1SCA105297R1001			1
Silver	OT16...40F	41210 8	OHSS2AJ1	1SCA105279R1001			1
Grey	OT16...40F	41187 3	OHGS2AJ1	1SCA105266R1001			1

* OH_2_J enables selection of MCB behavior when opening panel door (remain switched on or switch off). OH_2_J1 will cause MCB to switch off when opening panel door.

Axle extension

Type and order numbers are for one piece. For selector type handles. Shaft diameter 6 mm.

Lenght	Suitable for switches	Bbn 4012233	Order details		Price 1 piece	Weight 1 piece	Pack unit
		EAN	Type code	Order code		kg	pc.
85	OT16...40F	36571 8	OXS6X85	1SCA101647R1001		0.02	10
105	OT16...40F	42411 8	OXS6X105	1SCA108043R1001		0.02	10
120	OT16...40F	36578 7	OXS6X120	1SCA101654R1001		0.03	10
130	OT16...40F	36577 0	OXS6X130	1SCA101655R1001		0.03	10
160	OT16...40F	36580 0	OXS6X160	1SCA101656R1001		0.04	10
180	OT16...40F	36583 1	OXS6X180	1SCA101659R1001		0.04	10
250	OT16...40F	36584 8	OXS6X250	1SCA101660R1001		0.05	10
330	OT16...40F	36585 5	OXS6X330	1SCA101661R1001		0.05	10

Accessories for S 200, SN 201, F 200, DS 200 and other series



SZ-ES 68/83

Elevation piece

Compensates for different size of built-in devices with a mounting height of 68 mm and power MCBs of series S500 (83 mm)

	Bbn 4012233	Order details		Price 1 piece	Weight 1 piece	Pack unit
	EAN	Type code	Order code	kg	pc.	
	53390 9	SZ-ES 68/83	GH V021 1425 R0001		0.003	100

Locking device for MCBs and switches

Prevents unauthorised or dangerous operation of the operating lever. An adaptor makes it possible to block the operating lever whether switched ON or OFF. The lever is blocked with a padlock having a cross bar section of 3 or, as the case may be, 6 mm max. For multipole devices, one lock may be fitted per pole.

The lock adaptor can be used for all MCBs of the S 200, S 280 series, RCBOs DS201-DS202C as well as for switches E 200.

	Bbn 4012233	Order details		Price 1 piece	Weight 1 piece	Pack unit
	EAN	Type code	Order code	kg	pc.	
locking devices	3 mm	58760 5	SA 1	GJ F110 1903 R0001	0.004	10
for padlock bar	6 mm	58790 2	SA 1E	GJ F110 1903 R0004	0.004	10
padlock with 2 keys		58770 4	SA 2	GJ F110 1903 R0002	0.02	10
padlock, identical locking with 2 keys		96940 1	SA 2 i	GJ F110 9999 R0001	0.02	10
lock adaptor incl. padlock with 3 keys in transparent box		58780 3	SA 3	GJ F110 1903 R0003	0.05	10

Terminal cover KA 27

Provides overall touch protection of live parts. Suitable for installations acc. to DIN EN 50274 (DIN VDE 0660 Part 514) and BGV A2.

End parts can be snapped onto mounting rails EN 60 715, 35 mm. Covers are 486 mm = 27 modules (18 mm each) long. Knockouts for each half module for individualised use.

	Bbn 4012233	Order details		Price 1 piece	Weight 1 piece	Pack unit
	EAN	Type code	Order code	kg	pc.	
cover, 1 piece	13630 8	KA 27 H	GH S210 1933 R0001		0.104	10
end part, 1 piece	13640 7	KA 27 S	GH S210 1934 R0001		0.027	10

Terminal covers with base plate, protection IP 40

Material: high-impact and flame-retardant (UL 94 V-0), color: white (RAL 9001), glow-wire test 960 °C according to IEC 695-2-1

The base plate has an integrated top-hat rail for snap-on fixing of MCBs, RCDs, modular built-in devices, etc.

	Bbn 4012233	Order details		Price 1 piece	Weight 1 piece	Pack unit
	EAN	Type code	Order code	kg	pc.	
for 2 modules	12402 6	PCD 2 N	GH S270 1921 R0002		0.09	1
for 4 modules	12404 0	PCD 4 N	GH S270 1921 R0004		0.15	1
for 6 modules	12406 4	PCD 6 N	GH S270 1921 R0006		0.2	1
for 8 modules	12408 8	PCD 8 N	GH S270 1921 R0008		0.7	1



SA 1



SA 2



KA 27 H + KA 27 S



PCD 2 N



PCD 4 N



PCD 8 N



2CSC40041F0201

QES 4/3 N

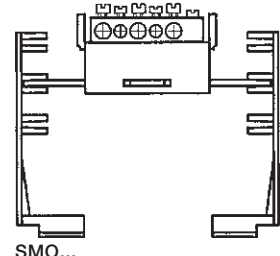

2CSC40038 F0201

SMO...

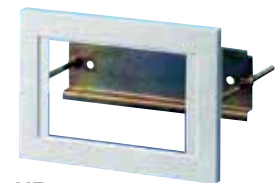

2CSC40053F0201

ME

Common terminals for terminal covers PCD

	Bbn 4012233	Order details		Price 1 piece	Weight 1 piece	Pack unit
	EAN	Type code	Order code		kg	pc.
for PCD 4 N and 6 N	12502 3	KL-PCD 4/6	GH S270 1912 R0004		0.017	
for PCD 8 N	12592 7	KL-PCD 8	GH S270 1912 R0008		0.079	

① bbn-No. 80 00126 ② bbn-No. 40 16779

Insulated housings IP 55

Come with DIN rail according to DIN EN 60 715 and cable entry grommet without N + PE common terminals (see SMO)

Material: high-impact and flame-retardant (UL 94 V-0), color grey (RAL 7035), glow-wire test 960 °C according to IEC 695-2-1

housings for 4 modules

Type with knock-outs	Enclosed cable grommets	Bbn 8000126	Order details		Price 1 piece	Weight 1 piece	Pack unit
		EAN	Type code	Order code		kg	pc.
2 x Ø 27	2	12644 0	QES 4/3 N	GH L111 2304 R0013		0.370	18

housings for 6 modules

Type with knock-outs	Enclosed cable grommets	Bbn 4012233	Order details		Price 1 piece	Weight 1 piece	Pack unit
		EAN	Type code	Order code		kg	pc.
2 x Ø 27	2	12646 4	QES 6/3 N	GH L111 2306 R0013		0.440	12

housings for 10 modules

Type with knock-outs	Enclosed cable grommets	Bbn 4012233	Order details		Price 1 piece	Weight 1 piece	Pack unit
		EAN	Type code	Order code		kg	pc.
6 x Ø 32	3	12650 1	QES 10/3 N	GH L111 2310 R0013		0.690	10

N + PE common terminals for QES (IP 55)

Neutral and protective-conductor terminals with insulation holder for screw-fixing

	Bbn 4012233	Order details		Price 1 piece	Weight 1 piece	Pack unit
	EAN	Type code	Order code		kg	pc.
for QES 4/3 N	12880 2	SMO 4	GH L430 1910 R0004		0.093	10
for QES 6/3 N	12882 6	SMO 6	GH L430 1910 R0006		0.125	10
for QES 10/3 N	12884 0	SMO 10	GH L430 1910 R0010		0.105	10

Flanges

	Bbn 8012542	Order details		Price 1 piece	Weight 1 piece	Pack unit
	EAN	Type code	Order code		kg	pc.
Flange for rear board fixing 1 module - IP40	304401	ME 1	16219300		0.040	1
Flange for rear board fixing 2 modules - IP40	304500	ME 2	16219318		0.045	1
Flange for rear board fixing 3 modules - IP40	304609	ME 3	16219326		0.055	1
Flange for rear board fixing 4 modules - IP40	304708	ME 4	16219334		0.060	1
Flange for rear board fixing 6 modules - IP40	304807	ME 6	16219342		0.070	1
Flange for rear board fixing 8 modules - IP40	304906	ME 8	16219359		0.080	1

Auxiliary elements for MCBs S 280 series

Selection table

Combination between auxiliary elements and S 280

4

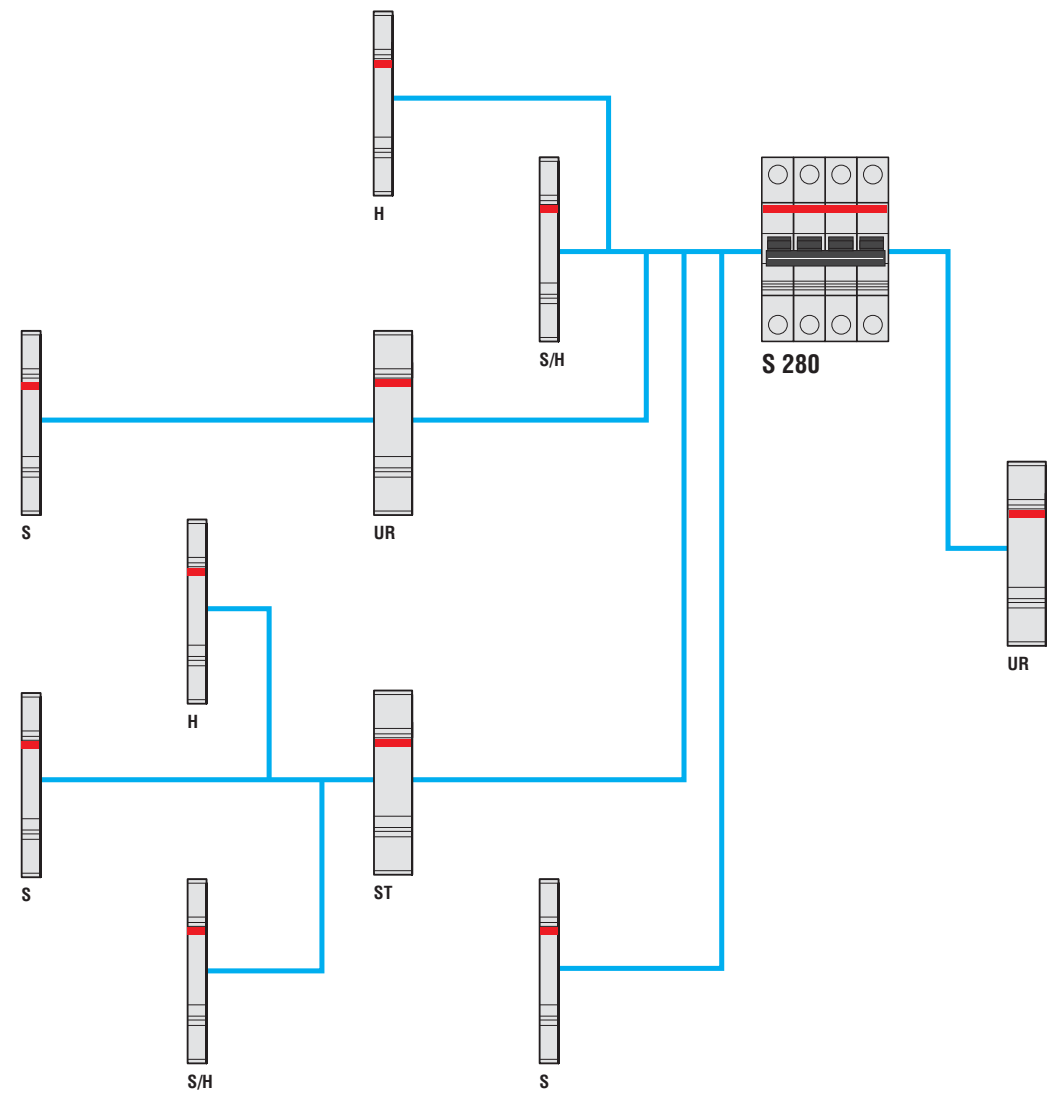

2CSC40002FR002

H	Auxiliary contact
S	Signal contact
UR	Undervoltage release
ST	Shunt trip

Auxiliary elements for MCBs S 280 series

Technical features

Shunt trips			
Type		S2-A1	S2-A2
Rated voltage	[V] a.c.	12 - 60	110 - 415
	[V] d.c.	12 - 60	110 - 250
Max. release duration	[ms]	<10	<10
Min. release voltage	[V] a.c.	7	55
	[V] d.c.	10	80
Consumption on release	[VA]	12 V a.c.	35
	12 V d.c.	30	
	24 V a.c.	140	
	24 V d.c.	100	
	48 V a.c.	600	
	48 V d.c.	330	
	110 V a.c.		40
	110 V d.c.		40
Coil resistance	[Ω]	3.7	225
Terminals	[mm ²]	25	25
Tightening torque	[Nm]	2	2
Dimens.(WxDxH)	[mm]	17.5x68x90	17.5x68x90

4

Undervoltage releases							
Type		S2-UA 12	S2-UA 24	S2-UA 48	S2-UA 110	S2-UA 220	S2-UA 380
Standards		VDE0660 part I - IEC EN 60947.1					
Rated voltage	[V] a.c.	-	24	48	110	220-240	380
	[V] d.c.	12	24	-	110	220-240	380
Frequency	[Hz]	50..60					
Release trip	[V]	0.35 Un ≤ V ≤ 0.7 Un					
Terminals	[mm ²]	2 x 1.5					
Consumption	[mA]	10					
Resistance to corrosion	[°C/RH]	const. climatic cond.: 23/83-40/93-55/20; var. climatic cond.: 25/95-40/93					
Protection degree		IP20					
Tightening torque	[Nm]	0.4					
Dimensions (WxDxH)	[mm]	17.5x68x90					

Auxiliary elements for MCBs S 280 series

Technical features

Auxiliary and signal contacts

Type		S2-H11 I S2-H11 X	S2-H20 I S2-H20 X	S2-H02 I S2-H02 X	S2-H21	S2-H12	S2-H30	S2-H03
Description		1NO+1NC	2NO	2NC	2NO+1NC	1NO+2NC	3NO	3NC
Alternating current	U _e [V] / I _e [A]	240/6 415/2						
Direct current	U _e [V] / I _e [A]	24/4 60/2 110/1.5 250/1						
Min. operating voltage	[V]	12 a.c.-12 d.c.						
Min. operating current	[mA]	12						
Terminals	[mm ²]	up to 2x1.5						
Dielectric strength	[kV]	3						
Resistance to short-circuit at 240 V a.c.	[A]	1000 (protected with S 2 breaker characteristic K - 6 A)						
Impulse voltage withstand capacity	[kV]	4						
Tightening torque	[Nm]	0.7						
Dimensions (WxDxH)	[mm]	8.75x68x90						

Type		S2-S	S2-SH
Description		1 change over	2 change over
Alternating current	U _e [V] / I _e [A]	240/6 415/2	
Direct current	U _e [V] / I _e [A]	250/0.5 110/1 60/1 24/4	
Min. operating voltage	[V]	12 a.c.-12 d.c.	
Min. operating current	[mA]	12	
Terminals	[mm ²]	up to 2x1.5	
Dielectric strength	[kV]	3	
Resistance to short-circuit at 240 V a.c.	[A]	1000 (protected with S 2 breaker characteristic K - 6 A)	
Impulse voltage withstand capacity	[kV]	4	
Tightening torque	[Nm]	0.7	
Dimensions (WxDxH)	[mm]	8.75x68x90	

Auxiliary elements for MCBs S 280 and S 280 UC series



S2-A



S2-H



S2-S



S2-S/H

Shunt trips

Function: remote opening of the device when a voltage is applied

Suitable for MCBs S 280 and S 280 UC series

	Bbn 4012233	Order details		Price 1 piece	Weight 1 piece	Pack unit
	EAN	Type code	Order code		kg	pc.
12-60 VAC/VDC shunt trip	42930 1	S2-A1	GH S280 1909 R0001		0.145	1
110-415 VAC and 110-250 VDC shunt trip	42940 0	S2-A2	GH S280 1909 R0002		0.145	1

Auxiliary contacts

Function: indication of the position of the device's contacts

Suitable for MCBs S 280 and S 280 UC series

Signal contacts

Function: indication of the position of the device's contacts only after the automatic release of the MCBs and RCBOs due to an overload or a short-circuit

Suitable for MCBs S 280 and S 280 UC series

	Bbn 4012233	Order details		Price 1 piece	Weight 1 piece	Pack unit
	EAN	Type code	Order code		kg	pc.
Auxiliary contact 1 NO + 1 NC (1/2 module)	61500 1	S2-H11	GH S270 1916 R0001		0.04	1
Auxiliary contact 2 NO (1/2 module)	61510 0	S2-H20	GH S270 1916 R0002		0.04	1
Auxiliary contact 2 NC (1/2 module)	61520 9	S2-H02	GH S270 1916 R0003		0.04	1
Auxiliary contact 1 NO + 1 NC (1/2 module) with Faston connections	61530 8	S2-H11X	GH S270 1917 R0001		0.04	1
Auxiliary contact 2 NO (1/2 module) with Faston connections	61540 7	S2-H20X	GH S270 1917 R0002		0.04	1
Auxiliary contact 2 NC (1/2 module) with Faston connections	61550 6	S2-H02X	GH S270 1917 R0003		0.04	1
Auxiliary contact 2 NO + 1 NC (1/2 module)	01370 3*	S2-H21	GH S270 1936 R0001		0.05	1
Auxiliary contact 1 NO + 2 NC (1/2 module)	01380 2 *	S2-H12	GH S270 1936 R0002		1	
Auxiliary contact 3 NO (1/2 module)	01390 1*	S2-H30	GH S270 1936 R0003		0.05	1
Auxiliary contact 3 NC (1/2 module)	01400 7*	S2-H03	GH S270 1936 R0004		0.05	1
Signal contact (1/2 module)	12770 7*	S2-S	GH S280 1902 R0008		0.07	1
Signal contact + Auxiliary contact (1/2 module)	42900 4	S2-S/H	GH S280 1901 R0008		0.05	1

* Bbn 4016779

Auxiliary elements for MCBs S 280 and S 280 UC series



S2-UA

4

Undervoltage releases

Function: protection of the load in the event of a voltage drop (between 70% and 35% of its rated value); positive safety (device's tripping when the voltage is disconnected) emergency stop by means of a button.

Suitable for MCBs S 280 and S 280 UC series

	Bbn 4012233	Order details		Price 1 piece	Weight 1 piece	Pack unit
	EAN	Type code	Order code	kg	pc.	
Undervoltage release 12V DC (1 module)	42970 7	S2-UA 12	GH S280 1911 R0001		0.09	1
Undervoltage release 24V AC/DC (1 module)	42980 6	S2-UA 24	GH S280 1911 R0002		0.09	1
Undervoltage release 48V AC/DC (1 module)	79360 0	S2-UA 48	GH S280 1911 R0003		0.09	1
Undervoltage release 110V AC/DC (1 module)	43000 0	S2-UA 110	GH S280 1911 R0004		0.09	1
Undervoltage release 220V AC/DC (1 module)	43010 9	S2-UA 220	GH S280 1911 R0005		0.09	1
Undervoltage release 380V AC (1 module)	79370 9	S2-UA 380	GH S280 1911 R0006		0.09	1

Hand operated neutral

The hand operated neutral has to be mounted to the left side of the MCB and be snapped on the DIN rail. It is used for measuring duties where the neutral conductor must be in the open position. Due to the special design of the handle - when switching ON the MCB – the neutral will make before the MCB is closed.

The S2C - Nt is not to switch with a tool (screw driver).

	Bbn 4012233	Order details		Price 1 piece	Weight 1 piece	Pack unit
	EAN	Type code	Order code	kg	pc.	
Hand operated neutral	36610 1	S2-NT	GH S270 1908 R0001		0.06	1

Auxiliary elements for S 700



S 700 BT 3



S 700 KA 1



S 700 KA 2/3



S 700 KA 4

Auxiliary switch S700 + H2WR	
2 Switch-over contacts	
Conv. thermal current I _{th}	10 A
Min. operating voltage	24 V AC/DC
Min. switching power	5 VA ①
Short-circuit withstand capability	1000 A @ 230 V AC with S 200 K6 back-up
Isolation coordination	
– overvoltage category	III
– pollution degree	2
– surge withstand capability	4 kV (1.2/50 μs)
Wiring	up to 2 x 1.5 mm ²
Contact reliability under	5 g, 20 cycles 5...150...5 Hz @ 24 V AC/DC, 5 mA -> contact

4

① the min. operating current under operating conditions acc. to EN 60204-1 and EN 60439-1 (indoor installation): 24 V AC/DC, 5 mA (AC 12, DC 12)

AC 14	U _e	400 V	230V
	I _e	2 A	6 A
DC 12	U _e	220 V	110 V
	I _e	1 A	1.5 A
DC 13	U _e	60 V	24 V
	I _e	2 A	4 A

Mounting adapters

DIN rail adapter
for mounting S 700 onto 1 or 2 DIN rails 35 mm acc. to EN 50022 (distance of DIN rails 125 mm when using 2 DIN rails)

	Bbn 4012233	Order details		Price 1 piece	Weight 1 piece	Pack unit
	EAN	Type code	Order code		kg	pc.
no. to be used:	28440 0 ②	S 700 BT 3	GHS7 001 902 R0003			10
S701: 1 pc.						
S702, S703, S704: 2 pc						

Busbar adapter
for mounting onto 40 mm busbar systems, 4 or 5 pole, with busbars 5 x 12 mm or 10 x 12 mm

	Bbn 4012233	Order details		Price 1 piece	Weight 1 piece	Pack unit
	EAN	Type code	Order code		kg	pc.
single phase: L1 or L2 or L3 (adjustable)	25430 4 ②	S 700 SA 1	GHS7 001 917 R0001		0.105	1
3-phase	52793 4 ②	S 700 QA	GHS7 001 106 R0001		0.35	1

Auxiliary elements for S 700



S 700 KA 5



S 700 SPA



S 700 SPB 1

S 700 SPB 2



S 700 QA



S 700 SA 1



S 700-SPE

Terminal covers, 2 per pole						
	Bbn 4012233	Order details		Price 1 piece	Weight 1 piece	Pack unit
	EAN	Type code	Order code	kg	pc.	
within the shape of S 700	52050 3	S 700 KA 1	GHS7 001 903 R0001		0.001	6
for cutouts of 160 mm	52090 9	S 700 KA 2	GHS7 001 907 R0001		0.01	6
for cutouts of 175 mm	52100 5	S 700 KA 3	GHS7 001 908 R0001		0.01	6
with cable entry	52140 1	S 700 KA 4	GHS7 001 913 R0001		0.015	6
for IP20 protection (front)	24300 1	S 700 KA 5	GHS7 001 903 R0005		0.003	6

Handle covers, 1 per pole						
	Bbn 4012233	Order details		Price 1 piece	Weight 1 piece	Pack unit
	EAN	Type code	Order code	kg	pc.	
to prevent manual switch-off	52060 2	S 700 SPA	GHS7 001 905 R0001		0.001	10
to prevent manual switch-off/-on, trans- parent	52070 1	S 700 SPB 1	GHS7 001 906 R0001		0.002	10
to prevent manual switch-off/-on, grey	52080 0	S 700 SPB 2	GHS7 001 906 R0002		0.002	10

Locking for 3 mm padlock						
	Bbn 4012233	Order details		Price 1 piece	Weight 1 piece	Pack unit
	EAN	Type code	Order code	kg	pc.	
locking plate 3 pole	52110 4	S 700 SPE	GHS7 001 909 R0001		0.002	10

bbn-No. 4016779

Auxiliary elements for MCBs S800 series

Selection table

Combination between auxiliary elements and S800

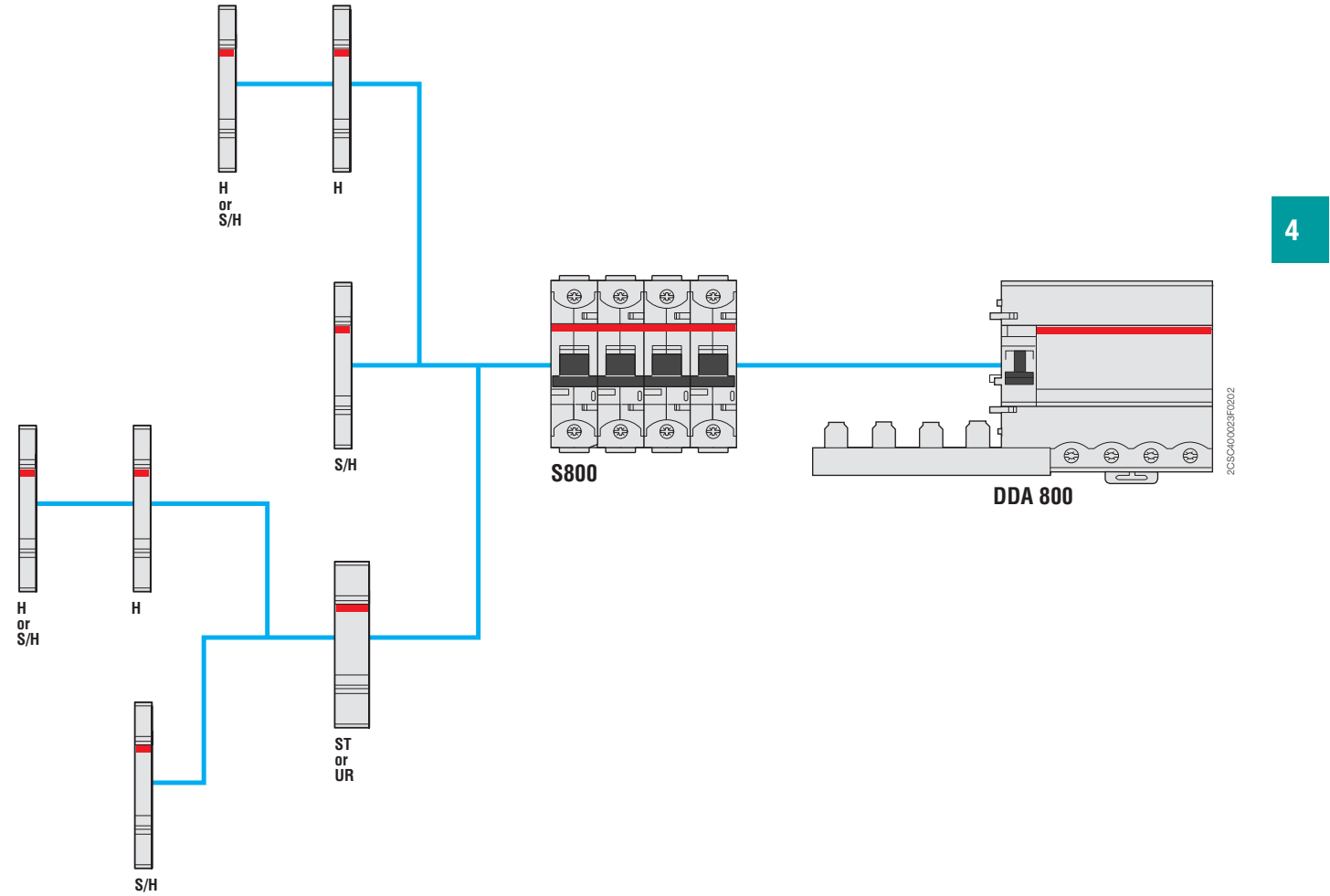

H	Auxiliary contact
S/H	Signal/Auxiliary contact
UR	Undervoltage release
ST	Shunt trip

Auxiliary elements for S800



S800-RSU

4

Remote switch unit S800-RSU-H

Operating voltage	[V]	24 DC
Current consumption I _{rms}	[A]	2.5
Stand-by current	[mA]	< 50
Switching time OFF-ON	[ms]	< 500
Switching time ON-OFF	[ms]	< 250
Ambient operation temperature	[°C]	-25...+70
Switching cycles over lifetime		10000
Standard		IEC 60947-2 Annex N
Protection		IP20
Weight	[g]	300
Connection		10 pole Micro Fit 3.0

Short circuit limiter S803S-SCL

Max. rated continuous current I _n	[A]	32, 63, 125
Poles		3
Rated operating voltage U _e (AC) 50/60Hz	[V]	400/690
Rated insulation voltage U _i	[V]	690
Rated impulse withstand voltage U _{imp}	[kV]	8
Ultimate short-circuit breaking capacity I _{cu} in accordance with IEC 60947-2	400VAC [kA]	100
	440VAC [kA]	100
	690VAC [kA]	50

Valid combination see: <http://www.abb.com/product>

Low Voltage Products and Systems/Modular DIN Rail Products/High

Performance Circuit Breakers HPCBs/Software

Service short-circuit breaking capacity I _{cs} in accordance with IEC 60947-2		100% I _{cu}
Rated frequency	[Hz]	50/60
Mounting position		any
Disconnecter properties according to IEC 60947-2		yes
Standard		IEC 60947-2
Connection Cu	[mm ²]	1...25 strand 1...35 cable
Connection Cu > 32 A	[mm ²]	6...50 strand 6...70 cable
Tightening torque	[Nm]	min. 3/max. 4
Supply		any
Mounting on DIN top hat rail		EN 60715
Permissible ambient temperature for operations	[°C]	-25...+60
Storage temperature	[°C]	-40...+70
Type of protection		IP20 IP40 (only actuation side)
Classification in accordance with NF-16-101, NF16-102		I3F2
Resistance to vibration		IEC 60068-2-27; IEC 60068-2; EN 61373 Cat.1/class B

Rated current I _n	Internal resistance R _i	Power loss P _v
[A]	[mΩ]	[W]
32	1.7	1.7
63	1.0	4.0
125	0.6	9.4

Auxiliary contact S800-AUX

Utilisation category		AC15 400/2A AC15 240/6A DC13 250/0.55A DC13 125V/1.1A DC13 60V/2A DC13 24V/4A
Continuous thermal current I _n	[A]	6
Rated insulation voltage U _i	[V]	690
Number of contacts		2
Rated impulse withstand voltage U _{imp}	[kV]	6
Pollution degree		3
Function of contact		Changeover contacts
Connection Cu	[mm ²]	1 x 2.5 2 x 1.5
Tightening torque	[Nm]	1
AC/DC supply		any
Mounting on DIN top hat rail		EN 60715
Type of protection		IP20
Permissible ambient temperature for operations	[°C]	-25...+60
Storage temperature	[°C]	-40...+70
Mech. device service life		6000 switching cycles
Icu with S450E	[A]	1000
Resistance to vibration		IEC 60068-2-6; EN 61373 Cat.1/class B 5g, 20 frequency cycle 5...150...5Hz at 24V AC/DC, 5mA brief interrupt <10ms

4

Auxiliary elements for S800

Combined auxiliary and signal contact S800 AUX/ALT		
Utilisation category		AC15 400/2A AC15 240/6A DC13 250/0.55A DC13 125V/1.1A DC13 60V/2A DC13 24V/4A
Continuous thermal current I_n	[A]	6
Rated insulation voltage U_i	[kV]	690
Number of contacts		2 (1x AUX, 1 x AUX/ALT)
Rated impulse withstand voltage U_{imp}	[kV]	6
Pollution degree		3
Function of contact		Changeover contacts
Connection C_u	[mm ²]	1 x 2.5 2 x 1.5
Tightening torque	[Nm]	1
AC/DC supply		any
Mounting on DIN top hat rail		EN 60715
Type of protection		IP20
Permissible ambient temperature for operations	[°C]	-25...+60
Storage temperature	[°C]	-40...+70
Mech. device service life		6000 switching cycles
Icu with S450E	[A]	1000
Resistance to vibration		IEC 60068-2; EN 61373 Cat.1/class B 5g, 20 frequency cycle 5...150...5Hz at 24V AC/DC, 5mA brief interrupt <10ms

Shunt Operation Release S800-SOR

		S800-SOR24	S800-SOR130	S800-SOR250	S800-SOR400
Rated voltage Ue	[V AC/DC]	24	48...130	110...250	220...400/250 a
Operating range	[%] Ue	70...110			
Rated insulation voltage Ui	[V]	690			
Coil pull in consumption	[W/VA]	16.6/17 a	41.9...307.3	23...119	45...148.1
			42...310 ①	20...105 ①	
Rated frequency	[Hz]	DC; 50/60			
Pollution degree		3			
Connection Cu	[mm²]	1...25 strand			
		1...35 cable			
Tightening torque	[Nm]	min.3/ max.4			
AC/DC supply		any			
DIN top hat rail		EN 60715			
Type of protection		IP20			
		IP40 (only actuation side)			
Permissible ambient temperature of operations	[°C]	-25...+60			
Storage temperature	[°C]	-40...+70			
Resistance to vibration		IEC 60068-2-6; EN61373 Cat.1/class B			

① according to UL 489

Undervoltage Release S800-UVR

		S800-UVR36	S800-UVR60	S800-UVR130	S800-UVR250
Rated voltage Ue	[V AC/DC]	24...36	48...60	110...130	220...250
Operating range	Operating opening	[%] Ue	35...70		
	Operating closing	[%] Ue	85		
Rated insulation voltage Ui	[V]	690			
Coil pull in consumption	[W/VA]	1.11...1.14/1.2	1.14...1.25/1.3 ①	1.3...1.41/1.4 ①	1.71...1.91/1.9 ①
Rated frequency	[Hz]	DC; 50/60			
Pollution degree		3			
Standard		IEC 60947-5-1, UL 489			
Connection Cu	[mm²]	1...25 strand			
		1...35 cable			
Tightening torque	[Nm]	min.3/ max.4			
AC/DC supply		any			
DIN top hat rail		EN 60715			
Type of protection		IP20			
		IP40 (only actuation side)			
Permissible ambient temperature of operations	[°C]	-25...+60			
Storage temperature	[°C]	-40...+70			
Resistance to vibration		IEC 60068-2-6; EN61373 Cat.1/class B			

① according to UL 489

4

Auxiliary elements for S800

Busbar S803-BB250			
Max. rated continuous current I_n	Side supply	[A]	125
	Central supply	[A]	250
Conditional short circuit current I_p		[kA eff]	100 protected by Tmax
Poles			3
Rated operating voltage U_e (AC) 50/60Hz		[V]	400/690
Rated insulation voltage U_i		[V]	690
Rated impulse withstand voltage U_{imp}		[kV]	8
Rated frequency		[Hz]	50
Standards			EN 60439-2:2000
Material of the bars			E-Cu 58 half-hard rolled F25
Material of the insulation profile			Cycoloy C 3600; UL94 V-0 at 1.5mm
Material of the end caps			Polyamide PA66+PA6; UL94 V-0 at 0.4mm Free of halogen and phosphorus
Busbar cross-sections		[mm ²]	60
Overvoltage category			III
Polution degree			2

Busbar Power Connector S803-BBPC120			
Max. rated continuous current I_n		[A]	250
Poles			3
Rated operating voltage U_e		[V]	400/690
Rated frequency		[Hz]	50
Standards			EN 60439-2:2000
Material of the terminals			CuZn39Pb2; material no.: 2.0380
Casing material			Polyamide PA66+PA6; UL94 V-0 at 0.4mm Free of halogen and phosphorus
Tightening torque			
At supply end		[Nm]	19
At busbar end		[Nm]	3
Connection cross-section		[mm ²]	1.6...120
Polution degree			2



S800-RSU



S800-RSU-CP



S800S-SCL



S800S-SCL-R



S800S-SCL-SR



S800W-SCL-SR

Remote switching unit						
Description	Bbn	Order details		Price	Weight	Pack
	7612271	Type code	Order code	1 piece	1 piece	unit
	EAN				kg	pc.
Remote switching unit	411244	S800-RSU-H	2CCS800900R0501		0.300	1

Description	Bbn	Order details		Price	Weight	Pack
	7612271	Type code	Order code	1 piece	1 piece	unit
	EAN				kg	pc.
S800-RSU cable with plug	412869	S800-RSU-CP	2CCS800900R0541		0,35	1
10-pole Micro Fit 3.0 plug	412845	S800-RSU-P	2CCS800900R0551		0	1

Short-circuit current limiters with cage terminal						
Description	Bbn	Order details		Price	Weight	Pack
	7612271	Type code	Order code	1 piece	1 piece	unit
A	EAN				kg	pc.
32	208912	S803S-SCL32	2CCS800900R0291		0.735	1
63	208929	S803S-SCL63	2CCS800900R0301		0.735	1
125	208905	S803S-SCL125	2CCS800900R0281		0.735	1

Short-circuit current limiters with ring terminal cable connection						
Description	Bbn	Order details		Price	Weight	Pack
	7612271	Type code	Order code	1 piece	1 piece	unit
	EAN				kg	pc.
32	408916	S803S-SCL32-R	2CCS800900R0332		0.735	1
63	208950	S803S-SCL63-R	2CCS800900R0331		0.735	1
125	208936	S803S-SCL125-R	2CCS800900R0311		0.735	1

Self-resetting short-circuit limiter IEC version						
Description	Bbn	Order details		Price	Weight	Pack
	7612271	Type code	Order code	1 piece	1 piece	unit
A	EAN				kg	pc.
32	412012	S801S-SCL32-SR	2CCS801901R0539		0,25	1
63	412036	S801S-SCL63-SR	2CCS801901R0599		0,25	1
100	411992	S801S-SCL100-SR	2CCS801901R0639		0,25	1
32	412074	S802S-SCL32-SR	2CCS801901R0539		0,5	1
63	412098	S802S-SCL63-SR	2CCS801901R0599		0,5	1
100	412050	S802S-SCL100-SR	2CCS801901R0639		0,5	1
32	411930	S803S-SCL32-SR	2CCS803901R0539		0,75	1
63	411947	S803S-SCL63-SR	2CCS803901R0599		0,75	1
100	411954	S803S-SCL100-SR	2CCS803901R0639		0,75	1

Self-resetting short-circuit limiter World version						
Description	Bbn	Order details		Price	Weight	Pack
	7612271	Type code	Order code	1 piece	1 piece	unit
A	EAN				kg	pc.
32	412319	S803W-SCL32-SR	2CCS803917R0539		0,75	1
63	412326	S803W-SCL63-SR	2CCS803917R0599		0,75	1
100	412302	S803W-SCL100-SR	2CCS803917R0639		0,75	1

Accessories for S800



S800-AUX



S800-AUX-ALT



S800-NT



S800-SOR



S800-UVR

Auxiliary contact						
Description	Bbn	Order details		Price	Weight	Pack
	7612271	Type code	Order code	1 piece	1 piece	unit
	EAN				kg	pc.
Auxiliary contact	206802	S800-AUX	2CCS800900R0011		0.049	1

Combined auxiliary and signal contact						
Description	Bbn	Order details		Price	Weight	Pack
	7612271	Type code	Order code	1 piece	1 piece	unit
	EAN				kg	pc.
Auxiliary/signal contact	206819	S800-AUX/ALT	2CCS800900R0021		0.050	1

Separating neutral						
Description	Bbn	Order details		Price	Weight	Pack
	7612271	Type code	Order code	1 piece	1 piece	unit
	EAN				kg	pc.
Separating neutral 63A	208196	S800-NT	2CCS800900R0061		0.115	1

Shunt operation releases						
Description	Bbn	Order details		Price	Weight	Pack
	7612271	Type code	Order code	1 piece	1 piece	unit
	EAN				kg	pc.
2VAC/DC	212070	S800-SOR12	2CCS800900R0191		0.15	1
24VAC/DC	208318	S800-SOR24	2CCS800900R0191		0.15	1
48...130VAC/DC	208349	S800-SOR130	2CCS800900R0221		0.15	1
110...250VAC/DC	208332	S800-SOR250	2CCS800900R0211		0.15	1
220...400VAC/DC	208356	S800-SOR400	2CCS800900R0231		0.15	1

Under voltage releases						
Description	Bbn	Order details		Price	Weight	Pack
	7612271	Type code	Order code	1 piece	1 piece	unit
	EAN				kg	pc.
24...36VAC/DC	208363	S800-UVR36	2CCS800900R0241		0.15	1
48...60VAC/DC	208370	S800-UVR60	2CCS800900R0251		0.15	1
110...130VAC/DC	208387	S800-UVR130	2CCS800900R0261		0.15	1
220...250VAC/DC	208394	S800-UVR250	2CCS800900R0271		0.15	1



S800-RD



S800-RHE-H



S800-RHE-M



S800-RHE-S

Rotary drive adapter for 3-4-pole High Performance MCB						
Description	Bbn 7612271	Order details		Price 1 piece	Weight 1 piece	Pack unit
	EAN	Type code	Order code		kg	pc.
Rotary Drive	208172	S800-RD	2CCS800900R0041		0.080	1

Anthracite/Standard rotary handle for door assembly						
Description	Bbn 8015644	Order details		Price 1 piece	Weight 1 piece	Pack unit
	EAN	Type code	Order code		kg	pc.
Anthracite rotary handle	625771	S800-RHE-H	1SDA060150R1		0.21	1

Red/Emergency rotary handle for door assembly						
Description	Bbn 8015644	Order details		Price 1 piece	Weight 1 piece	Pack unit
	EAN	Type code	Order code		kg	pc.
Red rotary handle	625764	S800-RHE-EM	1SDA060151R1		0.21	1

Axial extension of rotary drive – rotary handle 500mm						
Description	Bbn 8015644	Order details		Price 1 piece	Weight 1 piece	Pack unit
	EAN	Type code	Order code		kg	pc.
Axial extension 500mm for RHE	626242	S800-RHE-S	1SDA060179R1		0.19	1

IP54 protection for rotary handle						
Description	Bbn 8015644	Order details		Price 1 piece	Weight 1 piece	Pack unit
	EAN	Type code	Order code		kg	pc.
IP54 kit	626259	S800-RHE-IP54	1SDA060180R1		0.075	1

Accessories for MCBs S800 and RCD-blocks DDA 800 series



S800-IP9



S800-PLL



S800U-PLL



S800N-CT



S800-RT

Intermediate piece						
Description	Bbn	Order details		Price	Weight	Pack
	7612271	Type code	Order code	1 piece	1 piece	unit
	EAN				kg	pc.
Intermediate Piece 9mm	208202	S800-IP9	2CCS800900R0031		0.011	1

Padlock device						
Description	Bbn	Order details		Price	Weight	Pack
	7612271	Type code	Order code	1 piece	1 piece	unit
	EAN				kg	pc.
Padlock Lever Lock with 4mm hasp	208189	S800-PLL	2CCS800900R0051		0.0015	1

UL locking device						
Description	Bbn	Order details		Price	Weight	Pack
	7612271	Type code	Order code	1 piece	1 piece	unit
	EAN				kg	pc.
UL locking device	215057	S800U-PLL	2CCS800017R0001		0.03	2

Interchangeable adapter kit						
Description	Bbn	Order details		Price	Weight	Pack
	7612271	Type code	Order code	1 piece	1 piece	unit
	EAN				kg	pc.
Cage Terminal	212049	S800N-CT2125	2CCS800900R0181		0.03	2
Cage Terminal	212032	S800N-CT4125	2CCS800900R0151		0.06	4

Interchangeable adapter kit						
Description	Bbn	Order details		Price	Weight	Pack
	7612271	Type code	Order code	1 piece	1 piece	unit
	EAN				kg	pc.
Ring Terminal cable connection	208240	S800-RT2125	2CCS800900R0161		0.03	2
Ring Terminal cable connection	208219	S800-RT4125	2CCS800900R0131		0.06	4



S803-BB

2CCS413057F001



S803-BBPC

2CCS413059F001



S800-BBIC

2CCS413059F001



S802-LINK50

2CCS211254F001



S802-LINK120

2CCS413059F001

Busbar						
Description	Bbn 7612271	Order details		Price 1 piece	Weight 1 piece	Pack unit
	EAN	Type code	Order code		kg	pc.
Busbar 250 A	208288	S803-BB250	2CCS800900R0071		1.5	1

Supply block						
Description	Bbn 7612271	Order details		Price 1 piece	Weight 1 piece	Pack unit
	EAN	Type code	Order code		kg	pc.
Busbar Power Connector 120 mm ²	208301	S803-BBPC120	2CCS800900R0101		0.46	1

Contact protection cap						
Description	Bbn 7612271	Order details		Price 1 piece	Weight 1 piece	Pack unit
	EAN	Type code	Order code		kg	pc.
Busbar Isolation Cap	208967	S800-BBIC	2CCS800900R0081		0.02	12

End cap						
Description	Bbn 7612271	Order details		Price 1 piece	Weight 1 piece	Pack unit
	EAN	Type code	Order code		kg	pc.
End cap	208295	S800-END	2CCS800900R0091		0.04	10

S 800-ILS						
Description	Bbn 7612271	Order details		Price 1 piece	Weight 1 piece	Pack unit
	EAN	Type code	Order code		kg	pc.
Identification Labeling System 1 68x6x11.5 mm	208271	S800-ILS	2CCS800900R0121		0.011	1

Pole connectors						
Description	Bbn 7612271	Order details		Price 1 piece	Weight 1 piece	Pack unit
	EAN	Type code	Order code		kg	pc.
Pole connector 50A	211295	S802-LINK50	2CCS800900R0411		0,03	10
Pole connector 125A	419103	S802-LINK125	2CCS800900R0562		0,015	2

Auxiliary elements for MCBs S500 and RCD-blocks DDA 800 series



Auxiliary elements and accessories for S500

Auxiliary contact

Description	Bbn 7612271	Order details		Price 1 piece	Weight 1 piece kg	Pack unit pc.
	EAN	Type code	Order code			
1 NO and 1 NC contact	0305506	S500-H11	2CCF008681R0001		0.06	1
2 NO contacts	0305513	S500-H20	2CCF008682R0001		0.06	1

Signal contact

Description	Bbn 7612271	Order details		Price 1 piece	Weight 1 piece kg	Pack unit pc.
	EAN	Type code	Order code			
1 NO and 1 NC contact	0305537	S500-S11	2CCF008684R0001		0.06	1
2 NO contacts	0305544	S500-S20	2CCF008685R0001		0.06	1

Remote switch unit

Description	Bbn 7612271	Order details		Price 1 piece	Weight 1 piece kg	Pack unit pc.
	EAN	Type code	Order code			
Remote switch unit	1407780	S500-RSU-H	2CCF017987R0001		0.3	1

Auxiliary elements and accessories for DDA 800 RCD-blocks

Description	Bbn 7612271	Order details		Price 1 piece	Weight 1 piece kg	Pack unit pc.
	EAN	Type code	Order code			
Ring tongue terminal kit	987406	DDA 800-RT	2CSB100913R0001		0.01	1/12



Plug-in systems

UNIFIX rapid wiring system

UNIFIX – Rapid Wiring System

UNIFIX makes bench pre-cabling possible, with installation in the switchboard only carried out at a later time, without any limit to the types or combination of apparatus you may need to install...and this becomes even easier, thanks to the rigid coupled connectors, standardized for the different types of apparatus.

Unifix H allows modular and moulded-case circuit-breakers up to 250A to be mounted on an apparatus frame, which can be connected directly to the rear busbar system. This means many fewer conductors circulating inside the switchboard with considerable advantages in terms of space taken up, connections needed to be checked, and cabling times, with consequent cost savings.

Unifix L means traditional wire cabling on the supply side of the circuit-breakers can be replaced. It is thanks to the characteristics of its connections that cabling can be done rapidly and without any possibility of error, obtaining a more essential switchboard without conductors and cabling ducts around. Flexibility is its strong point: several independent circuits can be realized on the same DIN rail, and circuit-breakers of different types, with different polarity and characteristics can be mounted.

4

Customer Benefits with UNIFIX

Wiring Time

The use of Unifix reduces considerably wiring time.

Use of Standard Devices

Unifix can be applied to all standard versions of ABB Sace modular devices, Tmax T1 - T2 - T3 - XT1 - XT3 moulded-case circuit breakers

Flexible

Unifix has variable modular capacity, it is possible to place both circuit-breakers with different polarities side by side on the same line and auxiliary elements.

Reduce Space

Space taken up by Unifix is extremely low

For order codes and technical details please check the Distribution Switchgear Catalogue 1STC008001D0203, pages 3/19-20, 4/18-19-20, 5/50-51-52



Plug-in systems UNIFIX rapid wiring system

Unifix H

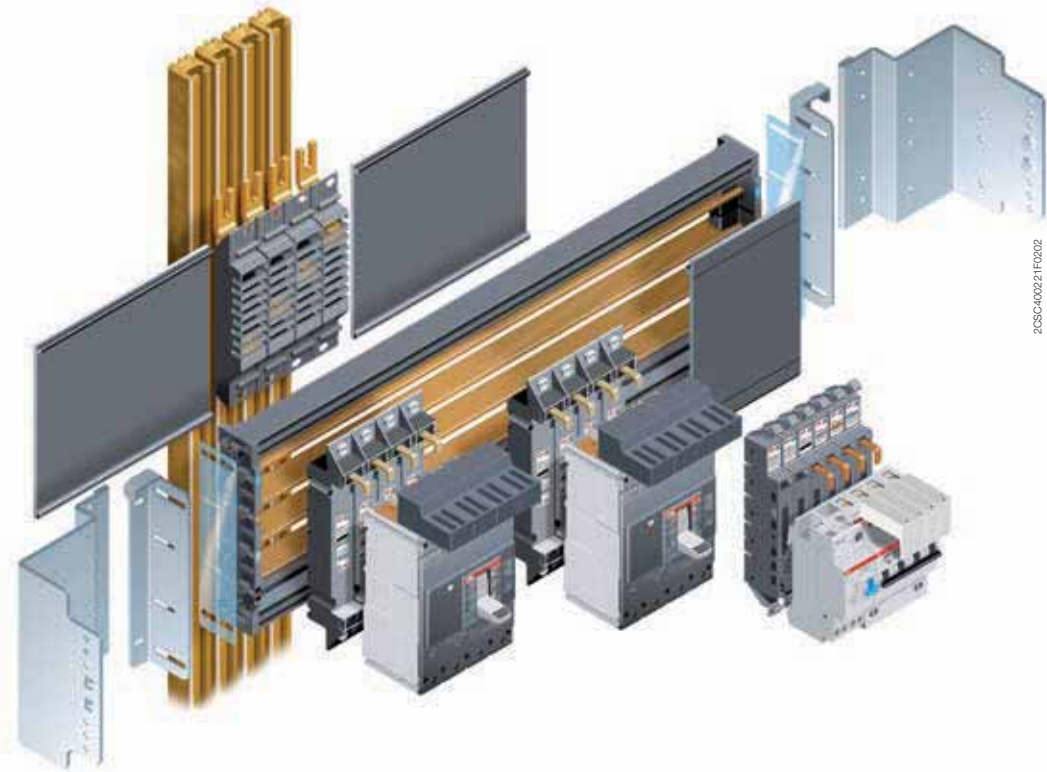

2CSC40021F0202

Unifix L

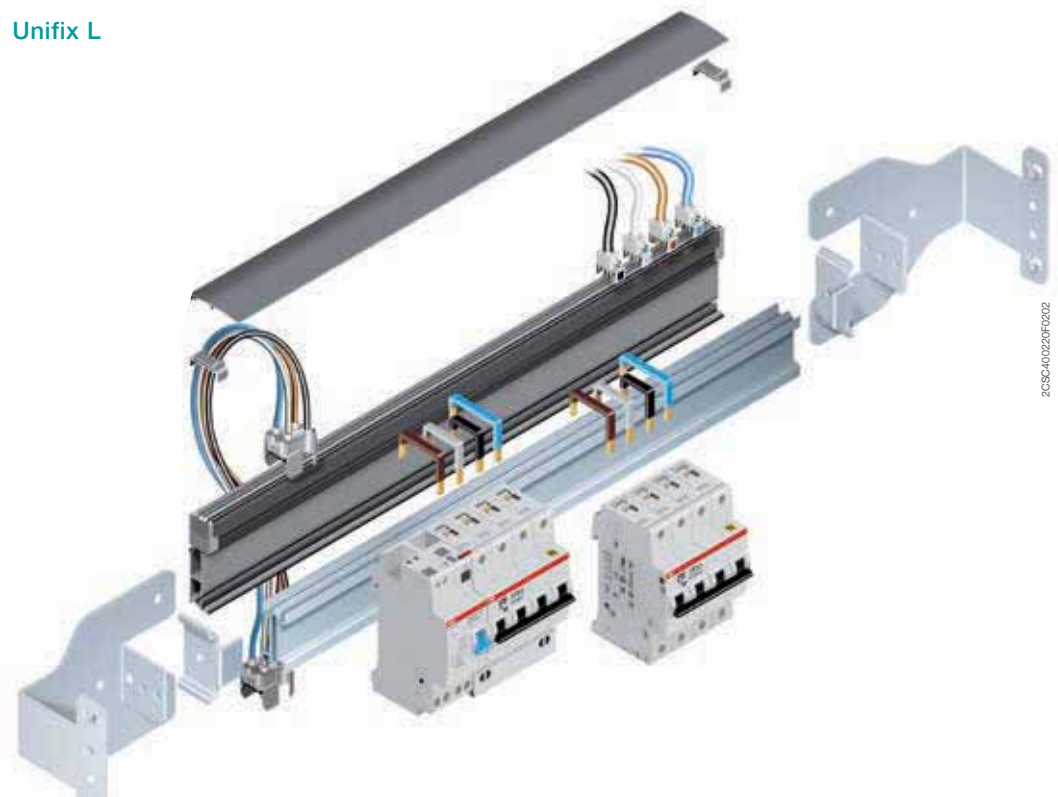

2CSC40020F0202

System pro *M* compact®

Protection and safety

Index			
OVR Plus and T2 range introduction	5/2	E 90 fuse switch disconnectors	5/50
OVR surge protective devices selection tables	5/4	E 90h fuseholders	5/52
OVR Type 1 surge protective devices, single pole	5/8	E 90 PV fuse disconnectors	5/53
OVR Type 1 surge protective devices TNC 230 V networks	5/10	E 90 class CC fuseholders	5/54
OVR Type 1 surge protective devices TNS/TT 230 V 1Ph+N networks	5/12	E 930 fuse disconnectors	5/55
OVR Type 1 surge protective devices TNS/TT 230 V 3Ph+N networks	5/14	Cylindrical fuses E 9F gG	5/57
OVR Type 1 surge protective devices Single pole neutral	5/16	Cylindrical fuses E 9F aM	5/61
OVR Type 1+2 surge protective devices Single pole	5/18	Cylindrical Fuses E 9F gPV	5/65
OVR Type 1+2 surge protective devices TNC 230 V networks	5/20	Fuse-switch-disconnectors	5/66
OVR Type 1+2 surge protective devices TNS/TT 230 V 1Ph+N and 3Ph+N networks	5/22	DO Fuse carrier	5/67
OVR Type 2 surge protective devices Single pole 57 V networks	5/24	Busbars and accessories for ILTS-E and ISS	5/68
OVR Type 2 surge protective devices Single pole 120 V and 230 V networks	5/26	Electronic Protection Devices for use behind 24 V DC Switch Mode Power Supplies	5/70
OVR Type 2 surge protective devices Single pole 230 V networks	5/28	SQZ3 phase and sequence relay	5/73
OVR Type 2 surge protective devices Single pole 400 V networks	5/30	RH/RL maximum and minimum current/voltage relays	5/74
OVR Type 2 surge protective devices TNC 230 V networks	5/32	E 236 undervoltage monitoring relays	5/75
OVR Type 2 surge protective devices TNS 230 V networks	5/34	H+ Line introduction	5/78
OVR Type 2 surge protective devices TNS/TT 230 V 1Ph+N networks	5/36	ISOLTESTER-DIG insulation monitoring devices	5/82
OVR Type 2 surge protective devices TNS/TT 230 V 3Ph+N networks	5/38	SELVTESTER insulation monitoring devices for insulated networks at 24 V a.c/d.c.	5/84
OVR Type 3 surge protective devices TNS/TT 230 V networks	5/40	QSD remote signalling panel	5/85
OVR Plus - Autoprotected surge protective devices TNS/TT 230 V networks	5/42	TI switchboards and devices for medical locations	5/86
OVR PV surge protective devices Photovoltaic networks	5/44	QSO selection table	5/87
OVR TC surge protective devices Data networks	5/46	QSO switchboards and components for medical locations	5/88
E 90 introduction	5/48	ISOLTESTER MRM operating theatre monitoring	5/91
		QIT Switchboards for data center protection and supply	5/92
		ISL industrial insulation monitoring devices	5/93

OVR Plus and T2 range. The details make the difference A complete range for your surge protection

Standard pro M terminals design for a better coordination with the complete ABB System pro M compact® modular range.

Possibility to add an auxiliary contact on the OVR Plus range with the standard ABB option S2C-H6R

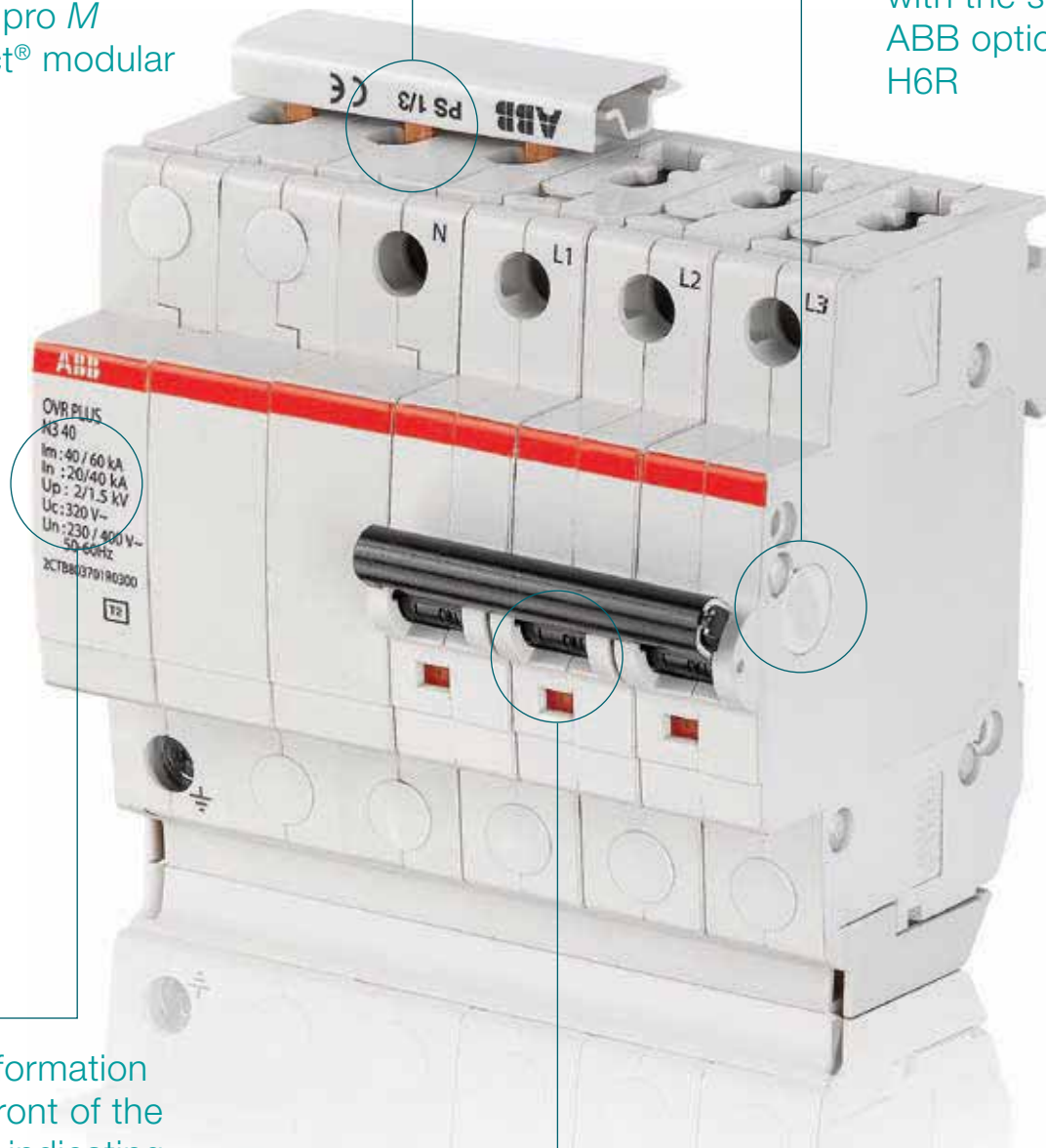

Clear information on the front of the product indicating the technical characteristics of the OVR PLUS.

The MCB toggle indicates the status of the OVR PLUS range.

Toggle on: OVR PLUS is active
Toggle off: You can switch on again.
The OVR PLUS has protected your installation and is still active
Toggle off: You cannot switch on again.
You have to change the OVR PLUS.



The bidirectional cylindrical terminal block of the OVR T2 and Plus range allows a complete coordination with the ABB range with considerable time savings in wiring operations. All the devices allow connection through bus-bars, both from above and from below.



The pluggable feature of ABB surge protective devices (SPDs) facilitates maintenance. Should one or more worn cartridges need to be replaced, the electrical circuit does not have to be isolated nor do the wires have to be removed.

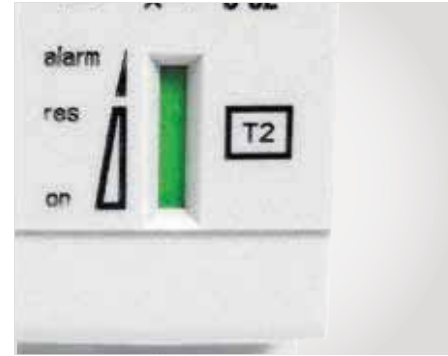

The end-of-service-life indicator of the SPD signals the status of the device. A mechanical indicator turns from green to red when the SPD reaches the end of its service life.

5



The toggle of the miniature circuit breaker indicates the status of the OVR Plus range.
 If the toggle is on, the surge protection is active.
 If the toggle is off and can be switched on again, the device has protected your equipment.
 If the toggle is off and cannot be switched on. The device must be changed.



The configuration allows to use the OVR Plus range on TT and TNS network in Phase + Neutral and 3 Phases + Neutral with a high surge capacity up to 40kA I_{max}.

Protection and safety

OVR surge protective devices selection tables

Protected lines	Impulse current	Max. discharge current	Nominal current	Follow current interrupting rating	Voltage protection level	Nominal voltage	Max. cont. operating voltage	Type	Order code
	I_{imp} 10/350	I_{max} 8/20	I_n	I_{fi}	U_p	U_n	U_c		
	kA	kA	kA	kA	kV	V	V		

Type 1 OVR

limp 25 kA									
1	25	-	25	50	2.5	400/690	440	OVR T1 25-440-50	2CTB815101R9300
1	25	-	25	50	2.5	230/400	255	OVR T1 25-255	2CTB815101R0100
2	25	-	25	50	2.5	230/400	255	OVR T1 2L 25-255	2CTB815101R1200
2	25	-	25	50	2.5	230/400	255	OVR T1 2L 25-255 TS	2CTB815101R1100
3	25	-	25	50	2.5	230/400	255	OVR T1 3L 25-255	2CTB815101R1300
3	25	-	25	50	2.5	230/400	255	OVR T1 3L 25-255 TS	2CTB815101R0600
4	25	-	25	50	2.5	230/400	255	OVR T1 4L 25-255	2CTB815101R1400
4	25	-	25	50	2.5	230/400	255	OVR T1 4L 25-255 TS	2CTB815101R0800
1+1	25	-	25	50	2.5	230/400	255	OVR T1 1N 25-255	2CTB815101R1500
1+1	25	-	25	50	2.5	230/400	255	OVR T1 1N 25-255 TS	2CTB815101R1000
3+1	25	-	25	50	2.5	230/400	255	OVR T1 3N 25-255	2CTB815101R1600
3+1	25	-	25	50	2.5	230/400	255	OVR T1 3N 25-255 TS	2CTB815101R0700
1	25	-	25	7	2.5	230/400	255	OVR T1 25-255-7	2CTB815101R8700
3+1	25	-	25	7	2.5	230/400	255	OVR T1 3N 25-255-7	2CTB815101R8800

Neutral									
1	25	-	25	-	4	400/690	690	OVR T1 25 N	2CTB815101R9700
1	50	-	50	-	1.5	230/400	255	OVR T1 50 N	2CTB815101R0400
1	100	-	25	-	2	230/400	255	OVR T1 100 N	2CTB815101R0500

Type 1+2 OVR

limp 25 and 15 kA									
1	25	60	25	15	1.5	230/400	255	OVR T1+2 25-255 TS	2CTB815101R0300
1	15	60	15	7	1.7	230/400	255	OVR T1+2 15-255-7	2CTB815101R8900
3+1	15	60	15	7	1.7	230/400	255	OVR T1+2 3N 15-255-7	2CTB815101R9000
1	15	100	5	-	1.4	230/400	440	OVR HL 15-440s P TS	2CTB815201R0800
2	15	100	5	-	1.4	230/400	440	OVR HL 2L 15-440s P TS	2CTB815303R0400
3	15	100	5	-	1.4	230/400	440	OVR HL 3L 15-440s P TS	2CTB815401R0400
4	15	100	5	-	1.4	230/400	440	OVR HL 4L 15-440s P TS	2CTB815503R0400
1	15	-	-	-	-	230/400	440	OVR HL 15-440s C	2CTB815250R0300

limp 7 kA									
1	7	70	7	-	1.4	230/400	275	OVR T1+2 7-275s P	2CTB815101R3900
3	7	70	7	-	1.4	230/400	275	OVR T1+2 3L 7-275s P	2CTB815101R4000
4	7	70	7	-	1.4	230/400	275	OVR T1+2 4L 7-275s P	2CTB815101R4100
1+1	7	70	7	-	1.4	230/400	275	OVR T1+2 1N 7-275s P	2CTB815302R1000
3+1	7	70	7	-	1.4	230/400	275	OVR T1+2 3N 7-275s P	2CTB815502R1000
1	7	-	-	-	-	230/400	275	OVR T1+2 7-275s C	2CTB815101R3800
1	7	-	-	-	-	230/400	255	OVR T1+2 70 NC	2CTB815101R5100

Type 2 OVR monobloc

1	-	20	5	-	1.0	120/240	150	OVR T2 20-150	2CTB804200R0700
1	-	40	20	-	1.4	120/240	150	OVR T2 40-150	2CTB804201R0700
1	-	20	5	-	1.0	230/400	275	OVR T2 20-275	2CTB804200R0100
1	-	40	20	-	1.4	230/400	275	OVR T2 40-275	2CTB804201R0100
3	-	20	5	-	1.0	230/400	275	OVR T2 3L 20-275	2CTB804600R0400
3	-	40	20	-	1.4	230/400	275	OVR T2 3L 40-275	2CTB804601R0400
4	-	20	5	-	1.0	230/400	275	OVR T2 4L 20-275	2CTB804600R0500
4	-	40	20	-	1.4	230/400	275	OVR T2 4L 40-275	2CTB804601R0500
1	-	20	5	-	1.3	230/400	440	OVR T2 20-440	2CTB804200R0200
1	-	40	20	-	1.9	230/400	440	OVR T2 40-440	2CTB804201R0200
1	-	20	5	-	1.0	120/240	150	OVR T2 20-150 (x20)	2CTB804200R1700
1	-	40	20	-	1.4	120/240	150	OVR T2 40-150 (x20)	2CTB804201R1700
1	-	20	5	-	1.0	230/400	275	OVR T2 20-275 (x20)	2CTB804200R1100
1	-	40	20	-	1.4	230/400	275	OVR T2 40-275 (x20)	2CTB804201R1100
3	-	20	5	-	1.0	230/400	275	OVR T2 3L 20-275 (x6)	2CTB804600R1400
3	-	40	20	-	1.4	230/400	275	OVR T2 3L 40-275 (x6)	2CTB804601R1400
4	-	20	5	-	1.0	230/400	275	OVR T2 4L 20-275 (x5)	2CTB804600R1500
4	-	40	20	-	1.4	230/400	275	OVR T2 4L 40-275 (x5)	2CTB804601R1500
1	-	20	5	-	1.3	230/400	440	OVR T2 20-440 (x20)	2CTB804200R1200
1	-	40	20	-	1.9	230/400	440	OVR T2 40-440 (x20)	2CTB804201R1200

Protected lines	Impulse current	Max. discharge current	Nominal current	Follow current interrupting rating	Voltage protection level	Nominal voltage	Max. cont. operating voltage	Type	Order code
	I _{imp} 10/350 kA	I _{max} 8/20 kA	I _n kA	I _{fi} kA	U _p kV	U _n V	U _c V		

Type 2 OVR pluggable

Uc 75 V

1	-	20	5	-	0.3	57	75	OVR T2 20-75 P	2CTB803851R2800
1	-	20	5	-	0.3	57	75	OVR T2 20-75 P TS	2CTB803851R2700
2	-	20	5	-	0.3	57	75	OVR T2 2L 20-75 P	2CTB803852R1700
2	-	20	5	-	0.3	57	75	OVR T2 2L 20-75 P TS	2CTB803852R1600

Uc 275 V

1	-	15	5	-	1.0	230/400	275	OVR T2 15-275 P	2CTB803851R2400
1	-	40	20	-	1.4	230/400	275	OVR T2 40-275 P	2CTB803851R2300
1	-	40	20	-	1.4	230/400	275	OVR T2 40-275 P TS	2CTB803851R1700
1	-	40	20	-	1.4	230/400	275	OVR T2 40-275s P	2CTB803851R2000
1	-	40	20	-	1.4	230/400	275	OVR T2 40-275s P TS	2CTB803851R1400
1	-	70	30	-	1.5	230/400	275	OVR T2 70-275s P	2CTB803851R1900
1	-	70	30	-	1.5	230/400	275	OVR T2 70-275s P TS	2CTB803851R1300
3	-	15	5	-	1.0	230/400	275	OVR T2 3L 15-275 P	2CTB803853R3400
3	-	40	20	-	1.4	230/400	275	OVR T2 3L 40-275 P	2CTB803853R2400
3	-	40	20	-	1.4	230/400	275	OVR T2 3L 40-275 P TS	2CTB803853R2500
3	-	40	20	-	1.4	230/400	275	OVR T2 3L 40-275s P	2CTB803853R2200
3	-	40	20	-	1.4	230/400	275	OVR T2 3L 40-275s P TS	2CTB803853R2300
3	-	70	30	-	1.5	230/400	275	OVR T2 3L 70-275s P	2CTB803853R4100
3	-	70	30	-	1.5	230/400	275	OVR T2 3L 70-275s P TS	2CTB803853R4400
4	-	15	5	-	1.0	230/400	275	OVR T2 4L 15-275 P	2CTB803853R6000
4	-	40	20	-	1.4	230/400	275	OVR T2 4L 40-275 P	2CTB803853R5600
4	-	40	20	-	1.4	230/400	275	OVR T2 4L 40-275 P TS	2CTB803853R5200
4	-	40	20	-	1.4	230/400	275	OVR T2 4L 40-275s P	2CTB803853R5400
4	-	40	20	-	1.4	230/400	275	OVR T2 4L 40-275s P TS	2CTB803853R5000
4	-	70	30	-	1.5	230/400	275	OVR T2 4L 70-275s P	2CTB803919R0200
4	-	70	30	-	1.5	230/400	275	OVR T2 4L 70-275s P TS	2CTB803919R0400
1+1	-	15	5	-	1.0	230/400	275	OVR T2 1N 15-275 P	2CTB803952R1200
1+1	-	40	20	-	1.4	230/400	275	OVR T2 1N 40-275 P	2CTB803952R1100
1+1	-	40	20	-	1.4	230/400	275	OVR T2 1N 40-275 P TS	2CTB803952R0500
1+1	-	40	20	-	1.4	230/400	275	OVR T2 1N 40-275s P	2CTB803952R0800
1+1	-	40	20	-	1.4	230/400	275	OVR T2 1N 40-275s P TS	2CTB803952R0200
1+1	-	70	30	-	1.5	230/400	275	OVR T2 1N 70-275s P	2CTB803952R0100
1+1	-	70	30	-	1.5	230/400	275	OVR T2 1N 70-275s P TS	2CTB803952R0700
3+1	-	15	5	-	1.0	230/400	275	OVR T2 3N 15-275 P	2CTB803953R1200
3+1	-	40	20	-	1.4	230/400	275	OVR T2 3N 40-275 P	2CTB803953R1100
3+1	-	40	20	-	1.4	230/400	275	OVR T2 3N 40-275 P TS	2CTB803953R0500
3+1	-	40	20	-	1.4	230/400	275	OVR T2 3N 40-275s P	2CTB803953R0800
3+1	-	40	20	-	1.4	230/400	275	OVR T2 3N 40-275s P TS	2CTB803953R0200
3+1	-	70	30	-	1.5	230/400	275	OVR T2 3N 70-275s P	2CTB803953R0700
3+1	-	70	30	-	1.5	230/400	275	OVR T2 3N 70-275s P TS	2CTB803953R0100

5

Protection and safety

OVR surge protective devices selection tables

Protected lines	Impulse current Iimp 10/350 kA	Max. discharge current Imax 8/20 kA	Nominal current In kA	Follow current interrupting rating I _{fi} kA	Voltage protection level Up kV	Nominal voltage Un V	Max. cont. operating voltage Uc V	Type	Order code
Uc 440 V									
1	-	15	5	-	1.3	230/400	440	OVR T2 15-440 P	2CTB803851R1100
1	-	40	20	-	1.9	230/400	440	OVR T2 40-440 P	2CTB803851R1200
1	-	40	20	-	1.9	230/400	440	OVR T2 40-440 P TS	2CTB803851R0500
1	-	40	20	-	1.9	230/400	440	OVR T2 40-440s P	2CTB803851R0800
1	-	40	20	-	1.9	230/400	440	OVR T2 40-440s P TS	2CTB803851R0200
1	-	70	30	-	2.0	230/400	440	OVR T2 70-440s P	2CTB803851R0700
1	-	70	30	-	2.0	230/400	440	OVR T2 70-440s P TS	2CTB803851R0100
1	-	120	60	-	2.5	230/400	440	OVR T2 120-440s P TS	2CTB803951R1300
3	-	40	20	-	1.9	230/400	440	OVR T2 3L 40-440 P	2CTB803853R2600
3	-	40	20	-	1.9	230/400	440	OVR T2 3L 40-440 P TS	2CTB803853R2700
3	-	70	30	-	2.0	230/400	440	OVR T2 3L 70-440s P	2CTB803853R4200
3	-	70	30	-	2.0	230/400	440	OVR T2 3L 70-440s P TS	2CTB803853R4300
4	-	40	20	-	1.9	230/400	440	OVR T2 4L 40-440 P	2CTB803853R5100
4	-	40	20	-	1.9	230/400	440	OVR T2 4L 40-440 P TS	2CTB803853R5300
4	-	70	30	-	2.0	230/400	440	OVR T2 4L 70-440s P	2CTB803853R7000
4	-	70	30	-	2.0	230/400	440	OVR T2 4L 70-440s P TS	2CTB803853R7100
3+1	-	15	5	-	1.3	230/400	440	OVR T2 3N 15-440 P	2CTB803953R1300
3+1	-	40	20	-	1.9	230/400	440	OVR T2 3N 40-440 P	2CTB803953R1400
3+1	-	40	20	-	1.9	230/400	440	OVR T2 3N 40-440 P TS	2CTB803953R1500
3+1	-	40	20	-	1.9	230/400	440	OVR T2 3N 40-440s P TS	2CTB803953R1600
3+1	-	70	30	-	2.0	230/400	440	OVR T2 3N 70-440s P	2CTB803953R1700
3+1	-	70	30	-	2.0	230/400	440	OVR T2 3N 70-440s P TS	2CTB803953R1800
3	-	40	20	-	3.0	400/690	760	OVR T2 3L 40-440/690 P	2CTB803853R4500
3	-	40	20	-	3.0	400/690	760	OVR T2 3L 40-440/690 P TS	2CTB803853R4600
Neutral									
1	-	70	30	-	1.4	230/400	255	OVR T2 70 N P	2CTB803953R1900
Cartridges									
1	-	15	-	-	-	57	75	OVR T2 15-75 C	2CTB803854R1400
1	-	15	-	-	-	230/400	275	OVR T2 15-275 C	2CTB803854R1200
1	-	40	-	-	-	230/400	275	OVR T2 40-275 C	2CTB803854R1000
1	-	40	-	-	-	230/400	275	OVR T2 40-275s C	2CTB803854R0900
1	-	70	-	-	-	230/400	275	OVR T2 70-275s C	2CTB803854R0700
1	-	15	-	-	-	230/400	440	OVR T2 15-440 C	2CTB803854R0600
1	-	40	-	-	-	230/400	440	OVR T2 40-440 C	2CTB803854R0400
1	-	40	-	-	-	230/400	440	OVR T2 40-440s C	2CTB803854R0300
1	-	70	-	-	-	230/400	440	OVR T2 70-440s C	2CTB803854R0100
1	-	70	-	-	-	230/400	255	OVR T2 70 N C	2CTB803854R0000

5

Protected lines	Impulse current	Max. discharge current	Nominal current	Follow current interrupting rating	Voltage protection level	Nominal voltage	Max. cont. operating voltage	Type	Order code
	I _{imp} 10/350 kA	I _{max} 8/20 kA	I _n kA	I _{fi} kA	U _p kV	U _n V	U _c V		

Type 2 autoprotected

1+1	-	20	5	-	1.3	230/400	275	OVR PLUS N1 20	2CTB803701R0700
1+1	-	40	20	-	1.8	230/400	320	OVR PLUS N1 40	2CTB803701R0100
3+1	-	20	5	-	1.3	230/400	320	OVR PLUS N3 20	2CTB803701R0400
3+1	-	40	20	-	2.0	230/400	320	OVR PLUS N3 40	2CTB803701R0300

Type 3 OVR

Combination wave Uoc 6 kV

1+1	-	10	3	-	0.9	230/400	275	OVR 1N 10 275	2CTB813912R1000
3+1	-	10	3	-	0.9	230/400	275	OVR 3N 10 275	2CTB813913R1000

5

Protection and safety

OVR Type 1 surge protective devices, single pole



OVR T1

2CSC40002D0211

Technical features					
Types		OVR T1 25-255-7	OVR T1 25-440-50	OVR T1 25-255	OVR T1 2L 25-255
	with auxiliary contact (TS)	-	-	-	OVR T1 2L 25-255 TS
Technology		Spark-gap	Spark-gap	Spark-gap	Spark-gap
Electrical features					
Standard		IEC 61643-1 / EN 61643-11			
Type / test class		T1 / I	T1 / I	T1 / I	T1 / I
Protected lines		1	1	1	2
Types of networks		TNC / TNS / TT	IT / TNC / TNS / TT	TNC / TNS / TT	TNS
Type of current		AC	AC	AC	AC
Nominal voltage Un	[V]	230 / 400	400 / 690	230 / 400	230 / 400
Maximum continuous operating voltage Uc	[V]	255	440	255	255
Maximum impulse current Iimp (10/350)	[kA]	25	25	25	25
Maximum impulse current Tot. Iimp (10/350)	[kA]	25	25	25	50
Nominal discharge current In (8/20)	[kA]	25	25	25	25
Follow current interrupting rating Ifi	[kA]	7	50	50	50
Voltage protection level Up at In	[kV]	≤ 2.5	≤ 2.5	≤ 2.5	≤ 2.5
Voltage protection level Up at 3 kA	[kV]	≤ 0.9	≤ 1.3	≤ 0.9	≤ 0.9
TOV (Temporary overvoltage) withstand Ut					
	(L-N: 5 s / N-PE: 200 ms)	[V]	650 / -	690 / -	450 / -
Response time	[ns]	≤ 100	≤ 100	≤ 100	≤ 100
Residual current IPE	[μA]	1000	10	10	10
Short-circuit withstand capability Isccr	[kA]	50	50	50	50
Backup protection	Fuse (gG - gL)	[A]	≤ 125	≤ 125	≤ 125
	Circuit breaker (B or C curve)	[A]	≤ 125	≤ 125	≤ 125
Pluggable cartridge		No	No	No	No
Integrated thermal disconnect		-	-	-	-
State indicator		Yes	No	No	No
Safety reserve		No	No	No	No
Auxiliary contact		No	No	No	No
Installation					
Wire range (L, N, PE)	Solid wire	[mm ²]	2.5...50	2.5...50	2.5...50
	Stranded wire	[mm ²]	2.5...35	2.5...35	2.5...35
Stripping length (L, N, PE)		[mm]	15	15	15
Tightening torque (L, N, PE)		[Nm]	3.5	3.5	3.5
Auxiliary contact (TS)					
Contact complement		-	-	-	1 NO - 1 NC
Minimum load		-	-	-	12 V DC - 10 mA
Maximum load		-	-	-	250 V AC - 1 A
Connection cross-section	[mm ²]	-	-	-	1.5
Miscellaneous characteristics					
Stocking and operating temperature	[°C]	-40 to +80	-40 to +80	-40 to +80	-40 to +80
Degree of protection		IP20	IP20	IP20	IP20
Fire resistance according to UL 94		V0	V0	V0	V0
Dimensions	height x width x depth	[mm]	85 x 17.8 x 70.8	90 x 35 x 64.8	90 x 70.4 x 64.8
		[inches]	3.34 x 0.70 x 2.78	3.54 x 1.38 x 2.55	3.54 x 2.77 x 2.55
Dimensions	height x width x depth	[mm]	-	-	90 x 88 x 64.8
with auxiliary contact (TS)		[inches]	-	-	3.54 x 3.46 x 2.55

Type 1 and Type 1+2 surge protective devices are designed to discharge high current surges without any destruction of the installation. These surge protective devices are characterized by their capacity to withstand impulse current with 10/350 µs wave form which simulate natural lightning current.

Type 1+2 ABB surge protective devices have a high impulse current withstand capacity with ensuring a low protection level (Up).

Type 1 and Type 1+2 SPDs can be installed at the entrance in the main switch board for a global protection of the electrical installation.

Follow current interrupting rating 7 kA										
Poles	Impulse current limp 10/350 kA	Follow current interrupting rating I _{fi} kA	Voltage protection level Up kV	Nominal voltage Un V	Max. cont. operating voltage Uc V	Bbn 3660308 EAN	Order details		Price 1 piece	Weight 1 piece kg
							Type code	Order code		
1	25	7	2.5	230/400	255	514110	OVR T1 25-255-7	2CTB815101R8700		0.16

5

Follow current interrupting rating 50 kA										
Poles	Impulse current limp 10/350 kA	Follow current interrupting rating I _{fi} kA	Voltage protection level Up kV	Nominal voltage Un V	Max. cont. operating voltage Uc V	Bbn 3660308 EAN	Order details		Price 1 piece	Weight 1 piece kg
							Type code	Order code		
1	25	50	2.5	400/690	440	514929	OVR T1 25-440-50	2CTB815101R9300		0.31
1	25	50	2.5	230/400	255	510877	OVR T1 25-255	2CTB815101R0100		0.31
2	25	50	2.5	230/400	255	510891	OVR T1 2L 25-255	2CTB815101R1200		0.63
2	25	50	2.5	230/400	255	510945	OVR T1 2L 25-255 TS	2CTB815101R1100		0.64

Where to find more:

Coordination and Wiring Principals of OVR p.10/164
Worldwide Marks and Approvals of MDRCs p.11/96
Technical catalogue of OVR (code 1TXH000083C0202)

Maybe you are also interested in:

For back-up protection:
S200 MCBs p.2/16
Fuses and Fuseholders p.5/50

Protection and safety

OVR Type 1 surge protective devices TNC 230 V networks



2CSC400021F0013

OVR T1 3L 25-255

Technical features			
Types		OVR T1 3L 25-255	–
	with auxiliary contact (TS)	–	OVR T1 3L 25-255 TS
Technology		Spark-gap	Spark-gap
Electrical features			
Standard		IEC 61643-1 / EN 61643-11	
Type / test class		T1 / I	T1 / I
Protected lines		3	3
Types of networks		TNC	TNC
Type of current		AC	AC
Nominal voltage Un	[V]	230 / 400	230 / 400
Maximum continuous operating voltage Uc	[V]	255	255
Maximum impulse current Iimp (10/350)	[kA]	25	25
Maximum impulse current Tot. Iimp (10/350)	[kA]	75	75
Nominal discharge current In (8/20)	[kA]	25	25
Follow current interrupting rating I _{fi}	[kA]	50	50
Voltage protection level Up at In	[kV]	≤ 2.5	≤ 2.5
Voltage protection level Up at 3 kA	[kV]	≤ 0.9	≤ 0.9
TOV (Temporary overvoltage) withstand Ut	(L-N: 5 s / N-PE: 200 ms) [V]	450 / –	450 / –
Response time	[ns]	≤ 100	≤ 100
Residual current IPE	[μA]	10	10
Short-circuit withstand capability I _{sc} cr	[kA]	50	50
Backup protection	Fuse (gG - gL)	[A]	≤ 125
	Circuit breaker (B or C curve)	[A]	≤ 125
Pluggable cartridge		No	No
Integrated thermal disconnecter		–	–
State indicator		No	Yes
Safety reserve		No	No
Auxiliary contact		No	Yes
Installation			
Wire range (L, N, PE)	Solid wire	[mm ²]	2.5...50
	Stranded wire	[mm ²]	2.5...35
Stripping length (L, N, PE)	[mm]	15	15
Tightening torque (L, N, PE)	[Nm]	3.5	3.5
Auxiliary contact (TS)			
Contact complement		–	1 NO - 1 NC
Minimum load		–	12 V DC - 10 mA
Maximum load		–	250 V AC - 1 A
Connection cross-section	[mm ²]	–	1.5
Miscellaneous characteristics			
Stocking and operating temperature	[°C]	-40 to +80	-40 to +80
Degree of protection		IP20	IP20
Fire resistance according to UL 94		V0	V0
Dimensions	height x width x depth	[mm]	90 x 105 x 64.8
		[inches]	3.54 x 4.13 x 2.55
with auxiliary contact (TS)	height x width x depth	[mm]	–
		[inches]	–
			90 x 122.5 x 64.8
			3.54 x 4.82 x 2.55

Where to find more:

Coordination and Wiring Principals of OVR p.10/164
 Worldwide Marks and Approvals of MDRCs p.11/96
 Technical catalogue of OVR (code 1TXH000083C0202)

Maybe you are also interested in:

For back-up protection:
 S200 MCBs p.2/16
 Fuses and Fuseholders p.5/50

Type 1 and Type 1+2 surge protective devices are designed to discharge high current surges without any destruction of the installation. These surge protective devices are characterized by their capacity to withstand impulse current with 10/350 μ s wave form which simulate natural lightning current.

Type 1+2 ABB surge protective devices have a high impulse current withstand capacity with ensuring a low protection level (Up).

Type 1 and Type 1+2 SPDs can be installed at the entrance in the main switch board for a global protection of the electrical installation.

Follow current interrupting rating 50 kA										
Poles	Impulse current limp 10/350 kA	Follow current interrupting rating I _{fi} kA	Voltage protection level Up kV	Nominal voltage Un V	Max. cont. operating voltage Uc V	Bbn 3660308 EAN	Order details		Price 1 piece	Weight 1 piece kg
							Type code	Order code		
3	25	50	2.5	230/400	255	510907	OVR T1 3L 25-255	2CTB815101R1300		0.94
3	25	50	2.5	230/400	255	510952	OVR T1 3L 25-255 TS	2CTB815101R0600		1.00

5

Protection and safety

OVR Type 1 surge protective devices TNS/TT 230 V 1Ph+N networks



OVR T1 1N 25-255

Technical features			
Types		OVR T1 1N 25-255	–
	with auxiliary contact (TS)	–	OVR T1 1N 25-255 TS
Technology		Spark-gap	Spark-gap
Electrical features			
Standard		IEC 61643-1 / EN 61643-11	
Type / test class		T1 / I	T1 / I
Protected lines		1+1	1+1
Types of networks		TNS / TT	TNS / TT
Type of current		AC	AC
Nominal voltage Un	[V]	230 / 400	230 / 400
Maximum continuous operating voltage Uc	[V]	255	255
Maximum impulse current Iimp (10/350)	[kA]	25	25
Maximum impulse current Tot. Iimp (10/350)	[kA]	50	50
Nominal discharge current In (8/20)	[kA]	25	25
Follow current interrupting rating I _{fi}	[kA]	50	50
Voltage protection level Up at In (L-N/N-PE/L-PE)	[kV]	2.5 / – / 2.5	2.5 / – / 2.5
Voltage protection level Up at 3 kA (L-N/N-PE/L-PE)	[kV]	0.9 / – / 0.9	0.9 / – / 0.9
TOV (Temporary overvoltage) withstand Ut	(L-N: 5 s / N-PE: 200 ms) [V]	450 / 1200	450 / 1200
Response time	[ms]	≤ 100	≤ 100
Residual current IPE	[μA]	10	10
Short-circuit withstand capability I _{scr}	[kA]	50	50
Backup protection	Fuse (gG - gL)	[A]	≤ 125
	Circuit breaker (B or C curve)	[A]	≤ 125
Pluggable cartridge		No	No
Integrated thermal disconnecter		–	–
State indicator		No	Yes
Safety reserve		No	No
Auxiliary contact		No	Yes
Installation			
Wire range (L, N, PE)	Solid wire	[mm ²]	2.5...50
	Stranded wire	[mm ²]	2.5...35
Stripping length (L, N, PE)	[mm]	15	15
Tightening torque (L, N, PE)	[Nm]	3.5	3.5
Auxiliary contact (TS)			
Contact complement		–	1 NO - 1 NC
Minimum load		–	12 V DC - 10 mA
Maximum load		–	250 V AC - 1 A
Connection cross-section	[mm ²]	–	1.5
Miscellaneous characteristics			
Stocking and operating temperature	[°C]	-40 to +80	-40 to +80
Degree of protection		IP20	IP20
Fire resistance according to UL 94		V0	V0
Dimensions	height x width x depth	[mm]	90 x 70.4 x 64.8
		[inches]	3.54 x 2.77 x 2.55
with auxiliary contact (TS)	height x width x depth	[mm]	–
		[inches]	90 x 88 x 64.8
			3.54 x 3.46 x 2.55

Where to find more:

Coordination and Wiring Principals of OVR p.10/164
 Worldwide Marks and Approvals of MDRCs p.11/96
 Technical catalogue of OVR (code 1TXH000083C0202)

Maybe you are also interested in:

For back-up protection:
 S200 MCBs p.2/16
 Fuses and Fuseholders p.5/50

Type 1 and Type 1+2 surge protective devices are designed to discharge high current surges without any destruction of the installation. These surge protective devices are characterized by their capacity to withstand impulse current with 10/350 μ s wave form which simulate natural lightning current.

Type 1+2 ABB surge protective devices have a high impulse current withstand capacity with ensuring a low protection level (Up).

Type 1 and Type 1+2 SPDs can be installed at the entrance in the main switch board for a global protection of the electrical installation.

Follow current interrupting rating 50 kA										
Poles	Impulse current limp 10/350 kA	Follow current interrupting rating I _{fi} kA	Voltage protection level Up kV	Nominal voltage Un V	Max. cont. operating voltage Uc V	Bbn 3660308 EAN	Order details		Price 1 piece	Weight 1 piece kg
							Type code	Order code		
1+1	25	50	2.5	230/400	255	510921	OVR T1 1N 25-255	2CTB815101R1500		0.53
1+1	25	50	2.5	230/400	255	510976	OVR T1 1N 25-255 TS	2CTB815101R1000		0.64

5

Protection and safety

OVR Type 1 surge protective devices TNS/TT 230 V 3Ph+N networks



OVR T1 3N 25-255-7

Technical features				
Types		OVR T1 4L 25-255	OVR T1 3N 25-255	OVR T1 3N 25-255-7
	with auxiliary contact (TS)	OVR T1 4L 25-255 TS	OVR T1 3N 25-255 TS	–
Technology		Spark-gap	Spark-gap	Spark-gap
Electrical features				
Standard		IEC 61643-1 / EN 61643-11		
Type / test class		T1 / I	T1 / I	T1 / I
Protected lines		4	3+1	3+1
Types of networks		TNS	TNS / TT	TNS / TT
Type of current		AC	AC	AC
Nominal voltage Un	[V]	230 / 400	230 / 400	230 / 400
Maximum continuous operating voltage Uc	[V]	255	255	255
Maximum impulse current Iimp (10/350)	[kA]	25	25	25
Maximum impulse current Tot. Iimp (10/350)	[kA]	100	100	100
Nominal discharge current In (8/20)	[kA]	25	25	25
Follow current interrupting rating I _{fl}	[kA]	50	50	7
Voltage protection level Up at In (L-N/N-PE/L-PE)	[kV]	≤ 2.5	2.5 / 2.5 / 2.5	2.0 / 2.0 / 2.0
Voltage protection level Up at 3 kA (L-N/N-PE/L-PE)	[kV]	≤ 0.9	0.9 / 0.9 / 0.9	0.9 / 0.9 / 0.9
TOV (Temporary overvoltage) withstand Ut (L-N: 5 s / N-PE: 200 ms)	[V]	450 / –	450 / 1200	650 / 1200
Response time	[ns]	≤ 100	≤ 100	≤ 100
Residual current IPE	[μA]	10	10	1000
Short-circuit withstand capability I _{scr}	[kA]	50	50	50
Backup protection	Fuse (gG - gL)	[A]	≤ 125	≤ 125
	Circuit breaker (B or C curve)	[A]	≤ 125	≤ 125
Pluggable cartridge		No	No	No
Integrated thermal disconnect		–	–	–
State indicator		Yes (TS option)	Yes (TS option)	Yes
Safety reserve		No	No	No
Auxiliary contact		Yes (TS option)	Yes (TS option)	No
Installation				
Wire range (L, N, PE)	Solid wire	[mm ²]	2.5...50	2.5...50
	Stranded wire	[mm ²]	2.5...35	2.5...35
Stripping length (L, N, PE)	[mm]	15	15	15
Tightening torque (L, N, PE)	[Nm]	3.5	3.5	3.5
Auxiliary contact (TS)				
Contact complement		1 NO - 1 NC	1 NO - 1 NC	–
Minimum load		12 V DC - 10 mA	12 V DC - 10 mA	–
Maximum load		250 V AC - 1 A	250 V AC - 1 A	–
Connection cross-section	[mm ²]	1.5	1.5	–
Miscellaneous characteristics				
Stocking and operating temperature	[°C]	-40 to +80	-40 to +80	-40 to +80
Degree of protection		IP20	IP20	IP20
Fire resistance according to UL 94		V0	V0	V0
Dimensions	height x width x depth	[mm]	90 x 140 x 64.8	90 x 140 x 64.8
		[inches]	3.54 x 5.51 x 2.55	3.54 x 5.51 x 2.55
with auxiliary contact (TS)	height x width x depth	[mm]	90 x 157.5 x 64.8	90 x 157.5 x 64.8
		[inches]	3.54 x 6.20 x 2.55	3.54 x 6.20 x 2.55

Where to find more:

Coordination and Wiring Principals of OVR p.10/164
 Worldwide Marks and Approvals of MDRCS p.11/96
 Technical catalogue of OVR (code 1TXH000083C0202)

Maybe you are also interested in:

For back-up protection:
 S200 MCBs p.2/16
 Fuses and Fuseholders p.5/50

Type 1 and Type 1+2 surge protective devices are designed to discharge high current surges without any destruction of the installation. These surge protective devices are characterized by their capacity to withstand impulse current with 10/350 μ s wave form which simulate natural lightning current.

Type 1+2 ABB surge protective devices have a high impulse current withstand capacity with ensuring a low protection level (Up).

Type 1 and Type 1+2 SPDs can be installed at the entrance in the main switch board for a global protection of the electrical installation.

Follow current interrupting rating 50 kA										
Poles	Impulse current limp 10/350 kA	Follow current interrupting rating I _{fi} kA	Voltage protection level Up kV	Nominal voltage Un V	Max. cont. operating voltage Uc V	Bbn 3660308 EAN	Order details		Price 1 piece	Weight 1 piece kg
							Type code	Order code		
4	25	50	2.5	230/400	255	510914	OVR T1 4L 25-255	2CTB815101R1400		1.16
4	25	50	2.5	230/400	255	510969	OVR T1 4L 25-255 TS	2CTB815101R0800		1.26
3+1	25	50	2.5	230/400	255	510938	OVR T1 3N 25-255	2CTB815101R1600		1.16
3+1	25	50	2.5	230/400	255	510983	OVR T1 3N 25-255 TS	2CTB815101R0700		1.26

5

Follow current interrupting rating 7 kA										
Poles	Impulse current limp 10/350 kA	Follow current interrupting rating I _{fi} kA	Voltage protection level Up kV	Nominal voltage Un V	Max. cont. operating voltage Uc V	Bbn 3660308 EAN	Order details		Price 1 piece	Weight 1 piece kg
							Type code	Order code		
3+1	25	7	2.5	230/400	255	514127	OVR T1 3N 25-255-7	2CTB815101R8800		0.84

Protection and safety

OVR Type 1 surge protective devices Single pole neutral



OVR T1 100 N

Technical features			OVR T1 25 N	OVR T1 50 N	OVR T1 100 N
Types					
	with auxiliary contact (TS)		–	–	–
Technology			Gas discharge tube (GDT)	Gas discharge tube (GDT)	Gas discharge tube (GDT)
Electrical features					
Standard			IEC 61643-1 / EN 61643-11		
Type / test class			T1 / I	T1 / I	T1 / I
Protected lines			1	1	1
Types of networks			Neutral	Neutral	Neutral
Type of current			AC	AC	AC
Nominal voltage Un		[V]	400 / 690	230 / 400	230 / 400
Maximum continuous operating voltage Uc		[V]	690	255	255
Maximum impulse current Iimp (10/350)		[kA]	25	50	100
Maximum impulse current Tot. Iimp (10/350)		[kA]	25	50	100
Nominal discharge current In (8/20)		[kA]	25	50	25
Follow current interrupting rating I _{fi}		[kA]	0.1	0.1	0.1
Voltage protection level Up at In		[kV]	≤ 4	≤ 1.5	≤ 2
Voltage protection level Up at 3 kA		[kV]	–	0.9	0.9
TOV (Temporary overvoltage) withstand Ut (L-N: 5 s / N-PE: 200 ms)		[V]	– / 1200	– / 1200	– / 1200
Response time		[ns]	≤ 100	≤ 100	≤ 100
Residual current IPE		[μA]	10	10	10
Short-circuit withstand capability I _{sc}		[kA]	50	50	50
Backup protection	Fuse (gG - gL)	[A]	–	–	–
	Circuit breaker (B or C curve)	[A]	–	–	–
Pluggable cartridge			No	No	No
Integrated thermal disconnect			–	–	–
State indicator			No	No	No
Safety reserve			No	No	No
Auxiliary contact			No	No	No
Installation					
Wire range (L, N, PE)	Solid wire	[mm ²]	2.5...50	2.5...50	2.5...50
	Stranded wire	[mm ²]	2.5...35	2.5...35	2.5...35
Stripping length (L, N, PE)		[mm]	15	15	15
Tightening torque (L, N, PE)		[Nm]	3.5	3.5	3.5
Auxiliary contact (TS)					
Contact complement			–	–	–
Minimum load			–	–	–
Maximum load			–	–	–
Connection cross-section		[mm ²]	–	–	–
Miscellaneous characteristics					
Stocking and operating temperature		[°C]	-40 to +80	-40 to +80	-40 to +80
Degree of protection			IP20	IP20	IP20
Fire resistance according to UL 94			V0	V0	V0
Dimensions	height x width x depth	[mm]	85 x 17.8 x 64.8	85 x 35.6 x 64.8	85 x 35.6 x 64.8
		[inches]	3.35 x 0.70 x 2.55	3.35 x 1.40 x 2.55	3.35 x 1.40 x 2.55
with auxiliary contact (TS)	height x width x depth	[mm]	–	–	–
		[inches]	–	–	–

Where to find more:

Coordination and Wiring Principals of OVR p.10/164

Worldwide Marks and Approvals of MDRCs p.11/96

Technical catalogue of OVR (code 1TXH000083C0202)

Maybe you are also interested in:

For back-up protection:

S200 MCBs p.2/16

Fuses and Fuseholders p.5/50

Type 1 and Type 1+2 surge protective devices are designed to discharge high current surges without any destruction of the installation. These surge protective devices are characterized by their capacity to withstand impulse current with 10/350 μ s wave form which simulate natural lightning current.

Type 1+2 ABB surge protective devices have a high impulse current withstand capacity with ensuring a low protection level (Up).

Type 1 and Type 1+2 SPDs can be installed at the entrance in the main switch board for a global protection of the electrical installation.

Type 1 Neutral										
Poles	Impulse current limp 10/350 kA	Follow current interrupting rating I _{fi} kA	Voltage protection level Up kV	Nominal voltage Un V	Max. cont. operating voltage Uc V	Bbn 3660308 EAN	Order details		Price 1 piece	Weight 1 piece kg
							Type code	Order code		
1	25	-	4	400/690	690	517043	OVR T1 25 N	2CTB815101R9700		0.15
1	50	-	1.5	230/400	255	510853	OVR T1 50 N	2CTB815101R0400		0.29
1	100	-	2	230/400	255	510860	OVR T1 100 N	2CTB815101R0500		0.29

5

Protection and safety

OVR Type 1+2 surge protective devices Single pole



OVR T1+2 15-255-7

5

		Technical features				
Types		OVR T1+2 7-275s P	–	–	OVR T1+2 15-255-7	
	with auxiliary contact (TS)	–	OVR HL 15-440s P TS	OVR T1+2 25-255 TS	–	
Technology		Varistor	Varistor	Spark-gap+varistor	Spark-gap	
Electrical features						
Standard		IEC 61643-1 / EN 61643-11				
Type / test class		T1+T2 / I+II	T1+T2 / I+II	T1+T2 / I+II	T1+T2 / I+II	
Protected lines		1	1	1	1	
Types of networks		TNC / TNS / TT	IT / TNC / TNS / TT	TNC / TNS / TT	TNC / TNS / TT	
Type of current		AC	AC	AC	AC	
Nominal voltage Un	[V]	230 / 400	230 / 400	230 / 400	230 / 400	
Maximum continuous operating voltage Uc	[V]	275	440	255	255	
Maximum impulse current Iimp (10/350)	[kA]	7	15	25	15	
Maximum impulse current Tot. Iimp (10/350)	[kA]	7	15	25	15	
Maximum discharge current Imax (8/20)	[kA]	70	100	60	60	
Nominal discharge current In (8/20)	[kA]	7	5	25	15	
Follow current interrupting rating I _{fi}	[kA]	–	–	15	7	
Voltage protection level Up at In (L-N/N-PE/L-PE)	[kV]	– / – / 1.4	– / – / 1.4	– / – / 1.5	– / – / 1.7	
Voltage protection level Up at 3 kA (L-N/N-PE/L-PE)	[kV]	– / – / 0.8	– / – / 1.2	– / – / 1.0	– / – / 0.9	
TOV (Temporary overvoltage) withstand Ut (L-N: 5 s / N-PE: 200 ms)	[V]	334 / –	440 / –	334 / –	650 / –	
Response time	[ns]	≤ 25	≤ 25	≤ 100	≤ 100	
Residual current IPE	[μA]	50	50	10	1000	
Short-circuit withstand capability I _{sc} r	[kA]	50	50	50	50	
Backup protection	Fuse (gG - gL)	[A]	≤ 50	≤ 50	≤ 125	≤ 125
	Circuit breaker (B or C curve)	[A]	≤ 50	≤ 50	≤ 125	≤ 125
Pluggable cartridge		Yes	Yes	No	No	
Integrated thermal disconnecter		Yes	Yes	Yes	–	
State indicator		Yes	Yes	Yes	Yes	
Safety reserve		Yes	Yes	No	No	
Auxiliary contact		No	Yes	Yes	No	
Installation						
Wire range (L, N, PE)	Solid wire	[mm ²]	2.5...25	2.5...50	2.5...50	2.5...50
	Stranded wire	[mm ²]	2.5...16	2.5...35	2.5...35	2.5...35
Stripping length (L, N, PE)	[mm]	12.5	15	15	15	
Tightening torque (L, N, PE)	[Nm]	2	3.5	3.5	3.5	
Auxiliary contact (TS)						
Contact complement		–	1 NO - 1 NC	1 NO - 1 NC	–	
Minimum load		–	12 V DC - 10 mA	12 V DC - 10 mA	–	
Maximum load		–	250 VAC - 1 A	250 VAC - 1 A	–	
Connection cross-section	[mm ²]	–	1.5	1.5	–	
Miscellaneous characteristics						
Stocking and operating temperature	[°C]	-40 to +80	-40 to +80	-40 to +80	-40 to +80	
Degree of protection		IP20	IP20	IP20	IP20	
Fire resistance according to UL 94		V0	V0	V0	V0	
Dimensions	height x width x depth	[mm]	85 x 17.8 x 64.8	–	–	85 x 17.8 x 70.8
		[inches]	3.35 x 0.70 x 2.55	–	–	3.35 x 0.70 x 2.79
with auxiliary contact (TS)	height x width x depth	[mm]	–	90 x 35.6 x 65	93 x 35 x 58	–
		[inches]	–	3.54 x 1.40 x 2.56	3.66 x 1.38 x 2.28	–

Type 1 and Type 1+2 surge protective devices are designed to discharge high current surges without any destruction of the installation. These surge protective devices are characterized by their capacity to withstand impulse current with 10/350 μ s wave form which simulate natural lightning current.

Type 1+2 ABB surge protective devices have a high impulse current withstand capacity with ensuring a low protection level (Up).

Type 1 and Type 1+2 SPDs can be installed at the entrance in the main switch board for a global protection of the electrical installation.

Poles	Impulse current limp 10/350 kA	Max. discharge current Imax 8/20 kA	Follow current interrupting rating I _{fi} kA	Voltage protection level Up kV	Nominal voltage Un V	Max. cont. operating voltage Uc V	Bbn 3660 308 EAN	Order details		Weight 1 piece kg
								Type code	Order code	
1	7	70	-	1.4	230/400	275	513403	OVR T1+2 7-275s P	2CTB815101R3900	0.15
1	15	140	-	1.4	230/400	440	509802	OVR HL 15-440s P TS	2CTB815201R0800	0.32
1	25	60	15	1.5	230/400	255	510884	OVR T1+2 25-255 TS	2CTB815101R0300	0.27

5

Follow current interrupting rating 7 kA										
Poles	Impulse current limp 10/350 kA	Max. discharge current Imax 8/20 kA	Follow current interrupting rating I _{fi} kA	Voltage protection level Up kV	Nominal voltage Un V	Max. cont. operating voltage Uc V	Bbn 3660 308 EAN	Order details		Weight 1 piece kg
								Type code	Order code	
1	15	60	7	1.7	230/400	255	514134	OVR T1+2 15-255-7	2CTB815101R8900	0.14

Where to find more:

Coordination and Wiring Principals of OVR p.10/164
Worldwide Marks and Approvals of MDRCs p.11/96
Technical catalogue of OVR (code 1TXH000083C0202)

Maybe you are also interested in:

For back-up protection:
S200 MCBs p.2/16
Fuses and Fuseholders p.5/50

Protection and safety

OVR Type 1+2 surge protective devices TNC 230 V networks



OVR HL 3L 15-440s P TS

2CS240002D0211

Technical features			
Types		–	OVR T1+2 3L 7-275s P
	with auxiliary contact (TS)	OVR HL 3L 15-440s P TS	–
Technology		Varistor	Varistor
Electrical features			
Standard		IEC 61643-1 / EN 61643-11	
Type / test class		T1+T2 / I+II	T1+T2 / I+II
Protected lines		3	3
Types of networks		IT / TNC	TNC
Type of current		AC	AC
Nominal voltage Un	[V]	230 / 400	230 / 400
Maximum continuous operating voltage Uc	[V]	440	275
Maximum impulse current Iimp (10/350)	[kA]	15	7
Maximum impulse current Tot. Iimp (10/350)	[kA]	45	20
Maximum discharge current Imax (8/20)	[kA]	100	70
Nominal discharge current In (8/20)	[kA]	5	7
Follow current interrupting rating Ifi	[kA]	–	–
Voltage protection level Up at In (L-N/N-PE/L-PE)	[kV]	– / – / 1.4	– / – / 1.4
Voltage protection level Up at 3 kA (L-N/N-PE/L-PE)	[kV]	– / – / 1.2	– / – / 0.8
TOV (Temporary overvoltage) (L-N: 5 s / N-PE: 200 ms)	[V]	440 / –	334 / –
withstand Ut			
Response time	[ns]	≤ 25	≤ 25
Residual current IPE	[μA]	150	150
Short-circuit withstand capability Isccr	[kA]	50	50
Backup protection	Fuse (gG - gL)	[A]	≤ 50
	Circuit breaker (B or C curve)	[A]	≤ 50
Pluggable cartridge		Yes	Yes
Integrated thermal disconnecter		Yes	Yes
State indicator		Yes	Yes
Safety reserve		Yes	Yes
Auxiliary contact		Yes	No
Installation			
Wire range (L, N, PE)	Solid wire	[mm ²]	2.5...50
	Stranded wire	[mm ²]	2.5...35
Stripping length (L, N, PE)	[mm]	15	12.5
Tightening torque (L, N, PE)	[Nm]	3.5	2
Auxiliary contact (TS)			
Contact complement		1 NO - 1 NC	–
Minimum load		12 V DC - 10 mA	–
Maximum load		250 V AC - 1 A	–
Connection cross-section	[mm ²]	1.5	–
Miscellaneous characteristics			
Stocking and operating temperature	[°C]	-40 to +80	-40 to +80
Degree of protection		IP20	IP20
Fire resistance according to UL 94		V0	V0
Dimensions	height x width x depth	[mm]	–
		[inches]	85 x 53.4 x 64.8
with auxiliary contact (TS)	height x width x depth	[mm]	90 x 106.8 x 65
		[inches]	3.54 x 4.20 x 2.56

Where to find more:

Coordination and Wiring Principals of OVR p.10/164
Worldwide Marks and Approvals of MDRCs p.11/96
Technical catalogue of OVR (code 1TXH000083C0202)

Maybe you are also interested in:

For back-up protection:
S200 MCBs p.2/16
Fuses and Fuseholders p.5/50

Type 1 and Type 1+2 surge protective devices are designed to discharge high current surges without any destruction of the installation. These surge protective devices are characterized by their capacity to withstand impulse current with 10/350 μ s wave form which simulate natural lightning current.

Type 1+2 ABB surge protective devices have a high impulse current withstand capacity with ensuring a low protection level (Up).

Type 1 and Type 1+2 SPDs can be installed at the entrance in the main switch board for a global protection of the electrical installation.

Follow current interrupting rating 50 kA										
Poles	Impulse current limp 10/350 kA	Max discharge current Imax 8/20 kA	Voltage protection level Up kV	Nominal voltage Un V	Max. cont. operating voltage Uc V	Bbn 3660308 EAN	Order details		Price 1 piece	Weight 1 piece kg
							Type code	Order code		
3	15	100	1.4	230/400	440	509833	OVR HL 3L 15-440s P TS	2CTB815401R0400		0.94
3	7	70	1.4	230/400	275	513410	OVR T1+2 3L 7-275s P	2CTB815101R4000		0.48

5

Protection and safety

OVR Type 1+2 surge protective devices TNS/TT 230 V 1Ph+N and 3Ph+N networks

Technical features							
Types			OVR T1+2 1N 7-275s P	OVR T1+2 3N 7-275s P	OVR T1+2 4L 7-275s P	–	OVR T1+2 3N 15- 255-7
	with auxiliary contact (TS)		–	–	–	OVR HL 4L 15- 440s P TS	–
Technology			Varistor	Varistor	Varistor	Varistor	Spark-gap
Electrical features							
Standard			IEC 61643-1 / EN 61643-11				
Type / test class			T1+T2 / I+II	T1+T2 / I+II	T1+T2 / I+II	T1+T2 / I+II	T1+T2 / I+II
Protected lines			1+1	3+1	4	4	3+1
Types of networks			TNS / TT	TNS / TT	TNS	TNS	TNS / TT
Type of current			AC	AC	AC	AC	AC
Nominal voltage Un	[V]		230 / 400	230 / 400	230 / 400	230 / 400	230 / 400
Maximum continuous operating voltage Uc	[V]		275	275	275	440	255
Maximum impulse current Iimp (10/350)	[kA]		7	7	7	15	15
Maximum impulse current Tot. Iimp (10/350)	[kA]		15	30	30	60	50
Maximum discharge current I _{max} (8/20)	[kA]		70	70	70	100	60
Nominal discharge current I _n (8/20)	[kA]		7	7	7	5	15
Follow current interrupting rating I _{fi}	[kA]		–	–	–	–	7
Voltage protection level Up at In (L-N/N-PE/L-PE)	[kV]		0.9 / 1.4 / 1.4	0.9 / 1.4 / 1.4	- / - / 1.4	- / - / 1.4	1.7 / 1.5 / 1.7
Voltage protection level Up at 3 kA (L-N/N-PE/L-PE)	[kV]		0.8 / 0.8 / 0.8	0.8 / 0.8 / 0.8	- / - / 0.8	- / - / 1.2	0.9 / 0.9 / 0.9
TOV (Temporary overvoltage) withstand Ut (L-N: 5 s / N-PE: 200 ms)	[V]		334 / 1200	334 / 1200	334 / -	440 / -	650 / 1200
Response time	[ns]		≤ 25	≤ 25	≤ 25	≤ 25	≤ 100
Residual current IPE	[μA]		10	10	200	200	1000
Short-circuit withstand capability I _{scrc}	[kA]		50	50	50	50	50
Backup protection	Fuse (gG - gL)	[A]	≤ 50	≤ 50	≤ 50	≤ 50	≤ 125
	Circuit breaker (B or C curve)	[A]	≤ 50	≤ 50	≤ 50	≤ 50	≤ 125
Pluggable cartridge			Yes	Yes	Yes	Yes	No
Integrated thermal disconnect			Yes	Yes	Yes	Yes	-
State indicator			Yes	Yes	Yes	Yes	Yes
Safety reserve			Yes	Yes	Yes	Yes	No
Auxiliary contact			No	No	No	Yes	No
Installation							
Wire range (L, N, PE)	Solid wire	[mm ²]	2.5...25	2.5...25	2.5...25	2.5...50	2.5...50
	Stranded wire	[mm ²]	2.5...16	2.5...16	2.5...16	2.5...35	2.5...35
Stripping length (L, N, PE)		[mm]	12.5	12.5	12.5	15	15
Tightening torque (L, N, PE)		[Nm]	2	2	2	3.5	3.5
Auxiliary contact (TS)							
Contact complement			–	–	–	1 NO - 1 NC	–
Minimum load			–	–	–	12 V DC - 10 mA	–
Maximum load			–	–	–	250 V AC - 1 A	–
Connection cross-section		[mm ²]	–	–	–	1.5	–
Miscellaneous characteristics							
Stocking and operating temperature		[°C]	-40 to +80	-40 to +80	-40 to +80	-40 to +80	-40 to +80
Degree of protection			IP20	IP20	IP20	IP20	IP20
Fire resistance according to UL 94			V0	V0	V0	V0	V0
Dimensions	height x width x depth	[mm]	85 x 35 x 64.8	85 x 71.2 x 64.8	85 x 71.2 x 64.8	–	85 x 89 x 70.8
		[inches]	3.35 x 1.38 x 2.55	3.35 x 2.80 x 2.55	3.35 x 2.80 x 2.55	–	3.35 x 3.50 x 2.79
with auxiliary contact (TS)	height x width x depth	[mm]	–	–	–	90 x 142.4 x 65	–
		[inches]	–	–	–	3.54 x 5.60 x 2.56	–



OVR T1+2 1N 7-275s P

Type 1 and Type 1+2 surge protective devices are designed to discharge high current surges without any destruction of the installation. These surge protective devices are characterized by their capacity to withstand impulse current with 10/350 μ s wave form which simulate natural lightning current.

Type 1+2 ABB surge protective devices have a high impulse current withstand capacity with ensuring a low protection level (Up).

Type 1 and Type 1+2 SPDs can be installed at the entrance in the main switch board for a global protection of the electrical installation.

5

Poles	Impulse current limp 10/350 kA	Max. discharge current Imax 8/20 kA	Follow current interrupting rating I _{fi} kA	Voltage protection level Up kV	Nominal voltage Un V	Max. cont. operating voltage Uc V	Bbn 3660 308 EAN	Order details		Weight 1 piece kg
								Type code	Order code	
1+1	7	70	-	1.4	230/400	275	515728	OVR T1+2 1N 7-275s P	2CTB815302R1000	0.32
3+1	7	70	-	1.4	230/400	275	515735	OVR T1+2 3N 7-275s P	2CTB815502R1000	0.63
4	7	70	-	0.9	230/400	275	513427	OVR T1+2 4L 7-275s P	2CTB815101R4100	0.60
4	15	100	-	1.4	230/400	440	509840	OVR HL 4L 15-440s P TS	2CTB815503R0400	1.20

Follow current interrupting rating 7 kA - 2 poles (1Ph+N)

Poles	Impulse current limp 10/350 kA	Max. discharge current Imax 8/20 kA	Follow current interrupting rating I _{fi} kA	Voltage protection level Up kV	Nominal voltage Un V	Max. cont. operating voltage Uc V	Bbn 3660 308 EAN	Order details		Weight 1 piece kg
								Type code	Order code	
3+1	15	60	7	1.7	230/400	255	514141	OVR T1+2 3N 15- 255-7	2CTB815101R9000	0.84

Where to find more:

Coordination and Wiring Principals of OVR p.10/164
Worldwide Marks and Approvals of MDRCs p.11/96
Technical catalogue of OVR (code 1TXH000083C0202)

Maybe you are also interested in:

For back-up protection:
S200 MCBs p.2/16
Fuses and Fuseholders p.5/50

Protection and safety

OVR Type 2 surge protective devices Single pole 57 V networks



OVR T2 15-75 P

Technical features						
Types			OVR T2 20-75 P	–	OVR T2 2L 20-75 P	–
			–	OVR T2 20-75 P TS	–	OVR T2 2L 20-75 P TS
Technology			Varistor	Varistor	Varistor	Varistor
Electrical features						
Standard			IEC 61643-1 / EN 61643-11			
Type / test class			T2 / II	T2 / II	T2 / II	T2 / II
Protected lines			1	1	2	2
Types of networks			TNC / TNS / TT	TNC / TNS / TT	TNC / TNS / TT	TNC / TNS / TT
Type of current			AC - DC	AC - DC	AC - DC	AC - DC
Nominal AC voltage Un		[V]	57	57	57	57
Max. cont. operating AC voltage Uc		[V]	75	75	75	75
Maximum discharge current I _{max} (8/20)		[kA]	20	20	20	20
Nominal discharge current I _n (8/20)		[kA]	5	5	5	5
Voltage protection level U _p at I _n		[kV]	0.30	0.30	0.30	0.30
Voltage protection level U _p at 3 kA		[kV]	0.25	0.25	0.25	0.25
TOV (Temporary overvoltage) withstand U _t		(L-N: 5 s / N-PE: 200 ms) [V]	75 / -	75 / -	75 / -	75 / -
Response time		[ns]	≤ 25	≤ 25	≤ 25	≤ 25
Residual current I _{PE}		[μA]	25	25	50	50
Short-circuit withstand capability I _{sc}		[kA]	50	50	50	50
Backup protection		Fuse (gG - gL)	[A]	≤ 16	≤ 16	≤ 16
		Circuit breaker (B or C curve)	[A]	≤ 16	≤ 16	≤ 16
Pluggable cartridge			No	No	No	No
Integrated thermal disconnecter			Yes	Yes	Yes	Yes
State indicator			Yes	Yes	Yes	Yes
Safety reserve			No	No	No	No
Auxiliary contact			No	Yes	No	Yes
Installation						
Wire range (L, N, PE)		Solid wire	[mm ²]	2.5...25	2.5...25	2.5...25
		Stranded wire	[mm ²]	2.5...16	2.5...16	2.5...16
Stripping length (L, N, PE)		[mm]	12.5	12.5	12.5	12.5
Tightening torque (L, N, PE)		[Nm]	2.5	2.5	2.5	2.5
Auxiliary contact (TS)						
Contact complement			–	1 NO - 1 NC	–	1 NO - 1 NC
Minimum load			–	12 V DC - 10 mA	–	12 V DC - 10 mA
Maximum load			–	250 V AC - 1 A	–	250 V AC - 1 A
Connection cross-section		[mm ²]	–	1.5	–	1.5
Miscellaneous characteristics						
Stocking and operating temperature		[°C]	-40 to +80	-40 to +80	-40 to +80	-40 to +80
Degree of protection			IP20	IP20	IP20	IP20
Fire resistance according to UL 94			V0	V0	V0	V0
Dimensions		height x width x depth	[mm]	88 x 17.8 x 64.8	–	88 x 35.6 x 64.8
			[inches]	3.46 x 0.70 x 2.55	–	3.46 x 1.40 x 2.55
with auxiliary contact (TS)		height x width x depth	[mm]	–	96 x 17.8 x 64.8	–
			[inches]	–	3.78 x 0.70 x 2.55	–

Type 2 surge protective devices are designed to protect electric installations and sensitive equipment against indirect surges with ensuring a low protection level (Up). They are characterized by their capacity to safely discharge current with 8/20 μ s wave form.

Type 2 pluggable - Uc 75 V										
Poles	Max discharge current I _{max} 8/20 kA	Nominal discharge current I _n kA	Voltage protection level Up kV	Nominal voltage Un V	Max. cont. operating voltage Uc V	Bbn 3660308 EAN	Order details		Price 1 piece	Weight 1 piece kg
							Type code	Order code		
1	20	5	0.3	57	75	518446	OVR T2 20-75 P	2CTB803851R2800		0.12
1	20	5	0.3	57	75	518453	OVR T2 20-75 P TS	2CTB803851R2700		0.12
2	20	5	0.3	57	75	518484	OVR T2 2L 20-75 P	2CTB803852R1700		0.23
2	20	5	0.3	57	75	518477	OVR T2 2L 20-75 P TS	2CTB803852R1600		0.23

5

Where to find more:

Coordination and Wiring Principals of OVR p.10/164
 Worldwide Marks and Approvals of MDRCs p.11/96
 Technical catalogue of OVR (code 1TXH000083C0202)

Maybe you are also interested in:

For back-up protection:
 S200 MCBs p.2/16
 Fuses and Fuseholders p.5/50

Protection and safety

OVR Type 2 surge protective devices Single pole 120 V and 230 V networks



OVR T2 20-150

5

Technical features			OVR T2 20-150	OVR T2 40-150	OVR T2 20-275	OVR T2 40-275
Types						
	with auxiliary contact (TS)		-	-	-	-
Technology			Varistor	Varistor	Varistor	Varistor
Electrical features						
Standard			IEC 61643-1 / EN 61643-11			
Type / test class			T2 / II	T2 / II	T2 / II	T2 / II
Protected lines			1	1	1	1
Types of networks			TNC / TNS / TT	TNC / TNS / TT	TNC / TNS / TT	TNC / TNS / TT
Type of current			AC	AC	AC	AC
Nominal AC voltage Un	[V]		120 / 240	120 / 240	230 / 400	230 / 400
Max. cont. operating AC voltage Uc	[V]		150	150	275	275
Maximum discharge current I _{max} (8/20)	[kA]		20	40	20	40
Nominal discharge current I _n (8/20)	[kA]		5	20	5	20
Voltage protection level Up at I _n	[kV]		1.0	1.4	1.2	1.4
Voltage protection level Up at 3 kA	[kV]		0.9	0.9	0.9	0.9
TOV (Temporary overvoltage) withstand Ut	(L-N: 5 s / N-PE: 200 ms)	[V]	334 / -	334 / -	334 / -	334 / -
Response time	[ns]		≤ 25	≤ 25	≤ 25	≤ 25
Residual current IPE	[μA]		25	25	25	25
Short-circuit withstand capability I _{sc}	[kA]		50	50	50	50
Backup protection	Fuse (gG - gL)	[A]	≤ 50	≤ 50	≤ 50	≤ 50
	Circuit breaker (B or C curve)	[A]	≤ 50	≤ 50	≤ 50	≤ 50
Pluggable cartridge			No	No	No	No
Integrated thermal disconnect			Yes	Yes	Yes	Yes
State indicator			Yes	Yes	Yes	Yes
Safety reserve			No	No	No	No
Auxiliary contact			No	No	No	No
Installation						
Wire range (L, N, PE)	Solid wire	[mm ²]	2.5...25	2.5...25	2.5...25	2.5...25
	Stranded wire	[mm ²]	2.5...16	2.5...16	2.5...16	2.5...16
Stripping length (L, N, PE)	[mm]		12.5	12.2	12.2	12.2
Tightening torque (L, N, PE)	[Nm]		2.5	2.5	2.5	2.5
Auxiliary contact (TS)						
Contact complement			-	-	-	-
Minimum load			-	-	-	-
Maximum load			-	-	-	-
Connection cross-section	[mm ²]		-	-	-	-
Miscellaneous characteristics						
Stocking and operating temperature	[°C]		-40 to +80	-40 to +80	-40 to +80	-40 to +80
Degree of protection			IP20	IP20	IP20	IP20
Fire resistance according to UL 94			V0	V0	V0	V0
Dimensions	height x width x depth	[mm]	85 x 17.8 x 64.8	85 x 17.8 x 64.8	85 x 17.8 x 64.8	85 x 17.8 x 64.8
		[inches]	3.35 x 0.70 x 2.55	3.35 x 0.70 x 2.55	3.35 x 0.70 x 2.55	3.35 x 0.70 x 2.55

Type 2 surge protective devices are designed to protect electric installations and sensitive equipment against indirect surges with ensuring a low protection level (Up). They are characterized by their capacity to safely discharge current with 8/20 μ s wave form.

Type 2 unpluggable											
Poles	Max discharge current I _{max} 8/20 kA	Nominal discharge current I _n kA	Voltage protection level Up kV	Nominal voltage		Max. cont. operating voltage Uc V	Bbn 3660308 EAN	Order details		Price 1 piece	Weight 1 piece kg
				Un V				Type code	Order code		
1	20	5	1.0	120/240	150	518057	OVR T2 20-150	2CTB804200R0700		0.12	
1	40	20	1.4	120/240	150	518064	OVR T2 40-150	2CTB804201R0700		0.12	
1	20	5	1.0	230/400	275	514882	OVR T2 20-275	2CTB804200R0100		0.12	
1	40	20	1.4	230/400	275	514103	OVR T2 40-275	2CTB804201R0100		0.12	

5

Where to find more:

Coordination and Wiring Principals of OVR p.10/164
 Worldwide Marks and Approvals of MDRCs p.11/96
 Technical catalogue of OVR (code 1TXH000083C0202)

Maybe you are also interested in:

For back-up protection:
 S200 MCBs p.2/16
 Fuses and Fuseholders p.5/50

Protection and safety

OVR Type 2 surge protective devices Single pole 230 V networks

Technical features							
Types			OVR T2 15-275 P	OVR T2 40-275 P	OVR T2 40-275s P	OVR T2 70-275s P	OVR T2 70 N P
with auxiliary contact (TS)			–	OVR T2 40-275 P TS	OVR T2 40-275s P TS	OVR T2 70-275s P TS	–
Technology			Varistor	Varistor	Varistor	Varistor	Gas discharge tube (GDT)
Electrical features							
Standard			IEC 61643-1 / EN 61643-11				
Type / test class			T2 / II	T2 / II	T2 / II	T2 / II	T2 / II
Protected lines			1	1	1	1	1
Types of networks			TNC / TNS / TT	TNC / TNS / TT	TNC / TNS / TT	TNC / TNS / TT	Neutral
Type of current			AC	AC	AC	AC	AC
Nominal voltage Un (L-N/L-L)	[V]		230 / 400	230 / 400	230 / 400	230 / 400	230 / 400
Max. cont. operating voltage Uc	[V]		275	275	275	275	255
Maximum discharge current Imax (8/20)	[kA]		15	40	40	70	70
Nominal discharge current In (8/20)	[kA]		5	20	20	30	30
Voltage protection level Up at In	[kA]		1.0	1.4	1.4	1.5	1.4
Voltage protection level Up at 3 kA	[kA]		0.9	0.8	0.8	0.8	0.9
TOV (Temporary overvoltage) withstand Ut (L-N: 5 s / N-PE: 200 ms)	[V]		334 / -	334 / -	334 / -	334 / -	- / 1200
Response time	[ns]		≤ 25	≤ 25	≤ 25	≤ 25	≤ 100
Residual current IPE	[μA]		25	25	50	50	10
Short-circuit withstand capability Isccr	[kA]		50	50	50	50	50
Backup protection	Fuse (gG - gL)	[A]	≤ 50	≤ 50	≤ 50	≤ 50	–
	Circuit breaker (B or C curve)	[A]	≤ 50	≤ 50	≤ 50	≤ 50	–
Pluggable cartridge			Yes	Yes	Yes	Yes	Yes
Integrated thermal disconnecter			Yes	Yes	Yes	Yes	–
State indicator			Yes	Yes	Yes	Yes	–
Safety reserve			No	No	Yes	Yes	–
Auxiliary contact			No	Yes (TS option)	Yes (TS option)	Yes (TS option)	No
Installation							
Wire range (L, N, PE)	Solid wire	[mm²]	2.5...25	2.5...25	2.5...25	2.5...25	2.5...25
	Stranded wire	[mm²]	2.5...16	2.5...16	2.5...16	2.5...16	2.5...16
Stripping length (L, N, PE)	[mm]		12.5	12.5	12.5	12.5	12.5
Tightening torque (L, N, PE)	[Nm]		2.5	2.5	2.5	2.5	2.5
Auxiliary contact (TS)							
Contact complement			–	1 NO - 1 NC	1 NO - 1 NC	1 NO - 1 NC	–
Minimum load			–	12 V DC - 10 mA	12 V DC - 10 mA	12 V DC - 10 mA	–
Maximum load			–	250 V AC - 1 A	250 V AC - 1 A	250 V AC - 1 A	–
Connection cross-section	[mm²]		–	1.5	1.5	1.5	–
Miscellaneous characteristics							
Stocking and operating temperature	[°C]		-40 to +80	-40 to +80	-40 to +80	-40 to +80	-40 to +80
Degree of protection			IP20	IP20	IP20	IP20	IP20
Fire resistance according to UL 94			V0	V0	V0	V0	V0
Dimensions	height x width x depth	[mm]	85 x 17.8 x 64.8	85 x 17.8 x 64.8	85 x 17.8 x 64.8	85 x 17.8 x 64.8	85 x 17.8 x 64.8
		[inches]	3.35 x 0.70 x 2.55	3.35 x 0.70 x 2.55	3.35 x 0.70 x 2.55	3.35 x 0.70 x 2.55	3.35 x 0.70 x 2.55
with auxiliary contact (TS)	height x width x depth	[mm]	–	96 x 17.8 x 64.8	96 x 17.8 x 64.8	96 x 17.8 x 64.8	–
		[inches]	–	3.78 x 0.70 x 2.55	3.78 x 0.70 x 2.55	3.78 x 0.70 x 2.55	–



OVR T2 40-275 P

Type 2 surge protective devices are designed to protect electric installations and sensitive equipment against indirect surges with ensuring a low protection level (Up). They are characterized by their capacity to safely discharge current with 8/20 μ s wave form.

Type 2 pluggable - Uc 275 V										
Poles	Max discharge current I _{max} 8/20 kA	Nominal discharge current I _n kA	Voltage protection level Up kV	Nominal voltage Un V	Max. cont. operating voltage Uc V	Bbn 3660308 EAN	Order details		Price 1 piece	Weight 1 piece kg
							Type code	Order code		
1	15	5	1.0	230/400	275	512840	OVR T2 15-275 P	2CTB803851R2400		0.12
1	40	20	1.4	230/400	275	512833	OVR T2 40-275 P	2CTB803851R2300		0.12
1	40	20	1.4	230/400	275	514363	OVR T2 40-275 P TS	2CTB803851R1700		0.12
1	40	20	1.4	230/400	275	512826	OVR T2 40-275s P	2CTB803851R2000		0.12
1	40	20	1.4	230/400	275	512802	OVR T2 40-275s P TS	2CTB803851R1400		0.12
1	70	30	1.5	230/400	275	512819	OVR T2 70-275s P	2CTB803851R1900		0.12
1	70	30	1.5	230/400	275	512796	OVR T2 70-275s P TS	2CTB803851R1300		0.12

5

Type 2 Neutral										
Poles	Max discharge current I _{max} 8/20 kA	Nominal discharge current I _n kA	Voltage protection level Up kV	Nominal voltage Un V	Max. cont. operating voltage Uc V	Bbn 3660308 EAN	Order details		Price 1 piece	Weight 1 piece kg
							Type code	Order code		
1	70	30	1.4	230/400	255	516862	OVR T2 70 N P	2CTB803953R1900		0.12

Where to find more:

Coordination and Wiring Principals of OVR p.10/164
 Worldwide Marks and Approvals of MDRCs p.11/96
 Technical catalogue of OVR (code 1TXH000083C0202)

Maybe you are also interested in:

For back-up protection:
 S200 MCBs p.2/16
 Fuses and Fuseholders p.5/50

Protection and safety

OVR Type 2 surge protective devices Single pole 400 V networks

Technical features			OVR T2 20-440	OVR T2 40-440	OVR T2 15-440 P	OVR T2 40-440(s) P	OVR T2 70-440s P	–
Types								
	with auxiliary contact (TS)		–	–	–	OVR T2 40-440(s) P TS	OVR T2 70-440s P TS	OVR T2 120-440s P TS
Technology			Varistor	Varistor	Varistor	Varistor	Varistor	Varistor
Electrical features								
Standard			IEC 61643-1 / EN 61643-11					
Type / test class			T2 / II	T2 / II	T2 / II	T2 / II	T2 / II	T2 / II
Protected lines			1	1	1	1	1	1
Types of networks			TNC / TNS / TT	TNC / TNS / TT	TNC / TNS / TT	TNC / TNS / TT	TNC / TNS / TT	TNC / TNS / TT
Type of current			AC	AC	AC	AC	AC	AC
Nominal voltage Un (L-N/L-L)	[V]		230 / 400	230 / 400	230 / 400	230 / 400	230 / 400	230 / 400
Max. cont. operating AC voltage Uc	[V]		440	440	440	440	440	440
Maximum discharge current Imax (8/20)	[kA]		20	40	15	40	70	120
Nominal discharge current In (8/20)	[kA]		5	20	5	20	30	60
Voltage protection level Up at In	[kA]		1.3	1.9	1.3	2.0	2.0	2.5
Voltage protection level Up at 3 kA	[kA]		1.2	1.3	1.2	1.2	1.2	1.1
TOV (Temporary overvoltage) withstand Ut	(L-N: 5 s / N-PE: 200 ms)	[V]	440 / -	440 / -	440 / -	440 / -	440 / -	440 / -
Response time		[ns]	≤ 25	≤ 25	≤ 25	≤ 25	≤ 25	≤ 25
Residual current IPE		[µA]	25	25	25	25 (50 for „s“)	50	50
Short-circuit withstand capability Isccr		[kA]	50	50	50	50	50	50
Backup protection	Fuse (gG - gL)	[A]	≤ 50	≤ 50	≤ 50	≤ 50	≤ 50	≤ 50
	Circuit breaker (B or C curve)	[A]	≤ 50	≤ 50	≤ 50	≤ 50	≤ 50	≤ 50
Pluggable cartridge			No	No	Yes	Yes	Yes	Yes
Integrated thermal disconnect			Yes	Yes	Yes	Yes	Yes	Yes
State indicator			Yes	Yes	Yes	Yes	Yes	Yes
Safety reserve			No	No	No	Yes (s option)	Yes	Yes
Auxiliary contact			No	No	No	Yes (TS option)	Yes (TS option)	Yes
Installation								
Wire range (L, N, PE)	Solid wire	[mm²]	2.5...25	2.5...25	2.5...25	2.5...25	2.5...25	2.5...25
	Stranded wire	[mm²]	2.5...16	2.5...16	2.5...16	2.5...16	2.5...16	2.5...16
Stripping length (L, N, PE)		[mm]	12.2	12.2	12.5	12.5	12.5	12.5
Tightening torque (L, N, PE)		[Nm]	2.5	2.5	2.5	2.5	2.5	2.5
Auxiliary contact (TS)								
Contact complement			–	–	–	1 NO - 1 NC	1 NO - 1 NC	1 NO - 1 NC
Minimum load			–	–	–	12 V DC -10 mA	12 V DC -10 mA	12 V DC -10 mA
Maximum load			–	–	–	250 V AC - 1 A	250 V AC - 1 A	250 V AC - 1 A
Connection cross-section		[mm²]	–	–	–	1.5	1.5	1.5
Miscellaneous characteristics								
Stocking and operating temperature		[°C]	-40 to +80	-40 to +80	-40 to +80	-40 to +80	-40 to +80	-40 to +80
Degree of protection			IP20	IP20	IP20	IP20	IP20	IP20
Fire resistance according to UL 94			V0	V0	V0	V0	V0	V0
Dimensions	height x width x depth	[mm]	85 x 17.8 x 64.8	85 x 17.8 x 64.8	85 x 17.8 x 64.8	85 x 17.8 x 64.8	85 x 17.8 x 64.8	–
		[inches]	3.35 x 0.70 x 2.55	3.35 x 0.70 x 2.55	3.35 x 0.70 x 2.55	3.35 x 0.70 x 2.55	3.35 x 0.70 x 2.55	–
with auxiliary contact (TS)	height x width x depth	[mm]	–	–	–	85 x 17.8 x 64.8	85 x 17.8 x 64.8	96 x 35.6 x 64.8
		[inches]	–	–	–	3.35 x 0.70 x 2.55	3.35 x 0.70 x 2.55	3.78 x 1.40 x 2.55



OVR T2 120-440s P TS

Type 2 surge protective devices are designed to protect electric installations and sensitive equipment against indirect surges with ensuring a low protection level (Up). They are characterized by their capacity to safely discharge current with 8/20 μ s wave form.

Type 2 unpluggable - Uc 440 V

Poles	Max discharge current I _{max} 8/20 kA	Nominal discharge current I _n kA	Voltage protection level Up kV	Nominal voltage Un V	Max. cont. operating voltage Uc V	Bbn 3660308	Order details		Price 1 piece	Weight 1 piece kg
							Type code	Order code		
1	20	5	1.3	230/400	440	518071	OVR T2 20-440	2CTB804200R0200		0.12
1	40	20	1.9	230/400	440	518088	OVR T2 40-440	2CTB804201R0200		0.12

5

Type 2 unpluggable - Uc 440 V

Poles	Max discharge current I _{max} 8/20 kA	Nominal discharge current I _n kA	Voltage protection level Up kV	Nominal voltage Un V	Max. cont. operating voltage Uc V	Bbn 3660308	Order details		Price 1 piece	Weight 1 piece kg
							Type code	Order code		
1	15	5	1.3	230/400	440	512772	OVR T2 15-440 P	2CTB803851R1100		0.12
1	40	20	1.9	230/400	440	512789	OVR T2 40-440 P	2CTB803851R1200		0.12
1	40	20	1.9	230/400	440	514370	OVR T2 40-440 P TS	2CTB803851R0500		0.12
1	40	20	1.9	230/400	440	512765	OVR T2 40-440s P	2CTB803851R0800		0.12
1	40	20	1.9	230/400	440	512741	OVR T2 40-440s P TS	2CTB803851R0200		0.12
1	70	30	2.0	230/400	440	512758	OVR T2 70-440s P	2CTB803851R0700		0.12
1	70	30	2.0	230/400	440	512734	OVR T2 70-440s P TS	2CTB803851R0100		0.12
1	120	60	2.5	230/400	440	517067	OVR T2 120-440s P TS	2CTB803951R1300		0.25

Where to find more:

Coordination and Wiring Principals of OVR p.10/164
 Worldwide Marks and Approvals of MDRCs p.11/96
 Technical catalogue of OVR (code 1TXH000083C0202)

Maybe you are also interested in:

For back-up protection:
 S200 MCBs p.2/16
 Fuses and Fuseholders p.5/50

Protection and safety

OVR Type 2 surge protective devices TNC 230 V networks

Technical features			OVR T2 3L 20-275	OVR T2 3L 40-275	OVR T2 3L 15-275 P	OVR T2 3L 40-275(s) P	OVR T2 3L 70-275s P	
Types								
	with auxiliary contact (TS)		–	–	–	OVR T2 3L 40-275(s) P TS	OVR T2 3L 70-275s P TS	
Technology			Varistor	Varistor	Varistor	Varistor	Varistor	
Electrical features								
Standard			IEC 61643-1 / EN 61643-11					
Type / test class			T2 / II	T2 / II	T2 / II	T2 / II	T2 / II	
Protected lines			3	3	3	3	3	
Types of networks			TNC	TNC	TNC	TNC	TNC	
Type of current			AC	AC	AC	AC	AC	
Nominal voltage Un (L-N/L-L)	[V]		230 / 400	230 / 400	230 / 400	230 / 400	230 / 400	
Max. cont. operating AC voltage Uc	[V]		275	275	275	275	275	
Maximum discharge current Imax (8/20)	[kA]		20	40	15	40	70	
Nominal discharge current In (8/20)	[kA]		5	20	5	20	30	
Voltage protection level Up at In	[kA]		1.0	1.4	1.0	1.4	1.5	
Voltage protection level Up at 3 kA	[kA]		0.9	0.9	0.9	0.8	0.8	
TOV (Temporary over-voltage) withstand Ut	(L-N: 5 s / N-PE: 200 ms)	[V]	334 / -	334 / -	334 / -	334 / -	334 / -	
Response time		[ns]	≤ 25	≤ 25	≤ 25	≤ 25	≤ 25	
Residual current IPE		[μA]	75	75	75	75 (150 for s option)	150	
Short-circuit withstand capability Isccr		[kA]	50	50	50	50	50	
Backup protection	Fuse (gG - gL)	[A]	≤ 50	≤ 50	≤ 50	≤ 50	≤ 50	
	Circuit breaker (B or C curve)	[A]	≤ 50	≤ 50	≤ 50	≤ 50	≤ 50	
Pluggable cartridge			No	No	Yes	Yes	Yes	
Integrated thermal disconnecter			Yes	Yes	Yes	Yes	Yes	
State indicator			Yes	Yes	Yes	Yes	Yes	
Safety reserve			No	No	No	Yes (s option)	Yes	
Auxiliary contact			No	No	No	Yes (TS option)	Yes (TS option)	
Installation								
Wire range (L, N, PE)	Solid wire	[mm²]	2.5...25	2.5...25	2.5...25	2.5...25	2.5...25	
	Stranded wire	[mm²]	2.5...16	2.5...16	2.5...16	2.5...16	2.5...16	
Stripping length (L, N, PE)		[mm]	12.5	12.5	12.5	12.5	12.5	
Tightening torque (L, N, PE)		[Nm]	2.5	2.5	2.5	2.5	2.5	
Auxiliary contact (TS)								
Contact complement			–	–	–	1 NO - 1 NC	1 NO - 1 NC	
Minimum load			–	–	–	12 V DC - 10 mA	12 V DC - 10 mA	
Maximum load			–	–	–	250 V AC - 1 A	250 V AC - 1 A	
Connection cross-section		[mm²]	–	–	–	1.5	1.5	
Miscellaneous characteristics								
Stocking and operating temperature		[°C]	-40 to +80	-40 to +80	-40 to +80	-40 to +80	-40 to +80	
Degree of protection			IP20	IP20	IP20	IP20	IP20	
Fire resistance according to UL 94			V0	V0	V0	V0	V0	
Dimensions	height x width x depth	[mm]	85 x 53.4 x 64.8	85 x 53.4 x 64.8	85 x 53.4 x 64.8	85 x 53.4 x 64.8	85 x 53.4 x 64.8	
		[inches]	3.35 x 2.10 x 2.55	3.35 x 2.10 x 2.55	3.35 x 2.10 x 2.55	3.35 x 2.10 x 2.55	3.35 x 2.10 x 2.55	
with auxiliary contact (TS)	height x width x depth	[mm]	–	–	–	96 x 53.4 x 64.8	96 x 53.4 x 64.8	
		[inches]	–	–	–	3.78 x 2.10 x 2.55	3.78 x 2.10 x 2.55	



OVR T2 3L 20-275

2CSC40002D0211

Type 2 surge protective devices are designed to protect electric installations and sensitive equipment against indirect surges with ensuring a low protection level (Up). They are characterized by their capacity to safely discharge current with 8/20 μ s wave form.

Type 2 unpluggable - Uc 275 V

Poles	Max discharge current I _{max} 8/20 kA	Nominal discharge current I _n kA	Voltage protection level Up kV	Nominal voltage Un V	Max. cont. operating voltage Uc V	Bbn 3660308	Order details		Price 1 piece	Weight 1 piece kg
							Type code	Order code		
3	20	5	1.0	230/400	275	515957	OVR T2 3L 20-275	2CTB804600R0400		0.35
3	40	20	1.4	230/400	275	515964	OVR T2 3L 40-275	2CTB804601R0400		0.35

5

Type 2 pluggable - Uc 275 V

Poles	Max discharge current I _{max} 8/20 kA	Nominal discharge current I _n kA	Voltage protection level Up kV	Nominal voltage Un V	Max. cont. operating voltage Uc V	Bbn 3660308	Order details		Price 1 piece	Weight 1 piece kg
							Type code	Order code		
3	15	5	1.0	230/400	275	512987	OVR T2 3L 15-275 P	2CTB803853R3400		0.35
3	40	20	1.4	230/400	275	513366	OVR T2 3L 40-275 P	2CTB803853R2400		0.35
3	40	20	1.4	230/400	275	514400	OVR T2 3L 40-275 P TS	2CTB803853R2500		0.35
3	40	20	1.4	230/400	275	512963	OVR T2 3L 40-275s P	2CTB803853R2200		0.35
3	40	20	1.4	230/400	275	512970	OVR T2 3L 40-275s P TS	2CTB803853R2300		0.35
3	70	30	1.5	230/400	275	512994	OVR T2 3L 70-275s P	2CTB803853R4100		0.35
3	70	30	1.5	230/400	275	513007	OVR T2 3L 70-275s P TS	2CTB803853R4400		0.35

Where to find more:

Coordination and Wiring Principals of OVR p.10/164
 Worldwide Marks and Approvals of MDRCs p.11/96
 Technical catalogue of OVR (code 1TXH000083C0202)

Maybe you are also interested in:

For back-up protection:
 S200 MCBs p.2/16
 Fuses and Fuseholders p.5/50

Protection and safety

OVR Type 2 surge protective devices TNS 230 V networks

Types			OVR T2 4L 20-275	OVR T2 4L 40-275	OVR T2 4L 15-275 P	OVR T2 4L 40-275(s) P	OVR T2 4L 70-275s P	
with auxiliary contact (TS)			-	-	-	OVR T2 4L 40-275(s) P TS	OVR T2 4L 70-275s P TS	
Technology			Varistor	Varistor	Varistor	Varistor	Varistor	
Electrical features								
Standard			IEC 61643-1 / EN 61643-11					
Type / test class			T2 / II	T2 / II	T2 / II	T2 / II	T2 / II	
Protected lines			4	4	4	4	4	
Types of networks			TNS	TNS	TNS	TNS	TNS	
Type of current			AC	AC	AC	AC	AC	
Nominal voltage Un (L-N/L-L)		[V]	230 / 400	230 / 400	230 / 400	230 / 400	230 / 400	
Max. cont. operating AC voltage Uc		[V]	275	275	275	275	275	
Maximum discharge current Imax (8/20)		[kA]	20	40	15	40	70	
Nominal discharge current In (8/20)		[kA]	5	20	5	20	30	
Voltage protection level Up at In		[kA]	1.0	1.4	1.0	1.4	1.5	
Voltage protection level Up at 3 kA		[kA]	0.9	0.9	0.9	0.8	0.8	
TOV (Temporary overvoltage) withstand Ut		(L-N: 5 s / N-PE: 200 ms) [V]	334 / -	334 / -	334 / -	334 / -	334 / -	
Response time		[ns]	≤ 25	≤ 25	≤ 25	≤ 25	≤ 25	
Residual current IPE		[μA]	100	100	100	100 (200 for s option)	200	
Short-circuit withstand capability Iscrc		[kA]	50	50	50	50	50	
Backup protection		Fuse (gG - gL)	[A]	≤ 50	≤ 50	≤ 50	≤ 50	≤ 50
		Circuit breaker (B or C curve)	[A]	≤ 50	≤ 50	≤ 50	≤ 50	≤ 50
Pluggable cartridge			No	No	Yes	Yes	Yes	
Integrated thermal disconnecter			Yes	Yes	Yes	Yes	Yes	
State indicator			Yes	Yes	Yes	Yes	Yes	
Safety reserve			No	No	No	Yes (s option)	Yes	
Auxiliary contact			No	No	No	Yes (TS option)	Yes (TS option)	
Installation								
Wire range (L, N, PE)		Solid wire	[mm²]	2.5...25	2.5...25	2.5...25	2.5...25	2.5...25
		Stranded wire	[mm²]	2.5...16	2.5...16	2.5...16	2.5...16	2.5...16
Stripping length (L, N, PE)		[mm]	12.5	12.5	12.5	12.5	12.5	
Tightening torque (L, N, PE)		[Nm]	2.5	2.5	2.5	2.5	2.5	
Auxiliary contact (TS)								
Contact complement			-	-	-	1 NO - 1 NC	1 NO - 1 NC	
Minimum load			-	-	-	12 V DC - 10 mA	12 V DC - 10 mA	
Maximum load			-	-	-	250 V AC - 1 A	250 V AC - 1 A	
Connection cross-section		[mm²]	-	-	-	1.5	1.5	
Miscellaneous characteristics								
Stocking and operating temperature		[°C]	-40 to +80	-40 to +80	-40 to +80	-40 to +80	-40 to +80	
Degree of protection			IP20	IP20	IP20	IP20	IP20	
Fire resistance according to UL 94			V0	V0	V0	V0	V0	
Dimensions		height x width x depth	[mm]	85 x 71.2 x 64.8	85 x 71.2 x 64.8	85 x 71.2 x 64.8	85 x 71.2 x 64.8	85 x 71.2 x 64.8
			[inches]	3.35 x 2.80 x 2.55	3.35 x 2.80 x 2.55	3.35 x 2.80 x 2.55	3.35 x 2.80 x 2.55	3.35 x 2.80 x 2.55
with auxiliary contact (TS)		height x width x depth	[mm]	-	-	-	96 x 71.2 x 64.8	96 x 71.2 x 64.8
			[inches]	-	-	-	3.78 x 2.80 x 2.55	3.78 x 2.80 x 2.55



OVR T2 4L 20-275

Type 2 surge protective devices are designed to protect electric installations and sensitive equipment against indirect surges with ensuring a low protection level (Up). They are characterized by their capacity to safely discharge current with 8/20 μ s wave form.

Type 2 unpluggable - Uc 275 V

Poles	Max discharge current I _{max} 8/20 kA	Nominal discharge current I _n kA	Voltage protection level Up kV	Nominal voltage Un V	Max. cont. operating voltage Uc V	Bbn 3660308	Order details		Price 1 piece	Weight 1 piece kg
							EAN	Type code		
4	20	5	1.0	230/400	275	515971	OVR T2 4L 20-275	2CTB804600R0500		0.45
4	40	20	1.4	230/400	275	515988	OVR T2 4L 40-275	2CTB804601R0500		0.45

5

Type 2 pluggable - Uc 275 V

Poles	Max discharge current I _{max} 8/20 kA	Nominal discharge current I _n kA	Voltage protection level Up kV	Nominal voltage Un V	Max. cont. operating voltage Uc V	Bbn 3660308	Order details		Price 1 piece	Weight 1 piece kg
							EAN	Type code		
4	15	5	1.0	230/400	275	513038	OVR T2 4L 15-275 P	2CTB803853R6000		0.45
4	40	20	1.4	230/400	275	513274	OVR T2 4L 40-275 P	2CTB803853R5600		0.45
4	40	20	1.4	230/400	275	514417	OVR T2 4L 40-275 P TS	2CTB803853R5200		0.45
4	40	20	1.4	230/400	275	513021	OVR T2 4L 40-275s P	2CTB803853R5400		0.45
4	40	20	1.4	230/400	275	513014	OVR T2 4L 40-275s P TS	2CTB803853R5000		0.45
4	70	30	1.5	230/400	275	513045	OVR T2 4L 70-275s P	2CTB803919R0200		0.45
4	70	30	1.5	230/400	275	513052	OVR T2 4L 70-275s P TS	2CTB803919R0400		0.45

Where to find more:

Coordination and Wiring Principals of OVR p.10/164
 Worldwide Marks and Approvals of MDRCs p.11/96
 Technical catalogue of OVR (code 1TXH000083C0202)

Maybe you are also interested in:

For back-up protection:
 S200 MCBs p.2/16
 Fuses and Fuseholders p.5/50

Protection and safety

OVR Type 2 surge protective devices TNS/TT 230 V 1Ph+N networks



OVR T2 1N 15-275 P

5

		Technical features			
Types		OVR T2 1N 15-275 P	OVR T2 1N 40-275 P	OVR T2 1N 40-275s P	OVR T2 1N 70-275s P
	with auxiliary contact (TS)	–	OVR T2 1N 40-275s P TS	OVR T2 1N 40-275s P TS	OVR T2 1N 70-275s P TS
Technology		Varistor	Varistor	Varistor	Varistor
Electrical features					
Standard		IEC 61643-1 / EN 61643-11			
Type / test class		T2 / II	T2 / II	T2 / II	T2 / II
Protected lines		1+1	1+1	1+1	1+1
Types of networks		TNS / TT	TNS / TT	TNS / TT	TNS / TT
Type of current		AC	AC	AC	AC
Nominal voltage Un (L-N/L-L)		[V] 230 / 400	230 / 400	230 / 400	230 / 400
Max. cont. operating AC voltage Uc		[V] 275	275	275	275
Maximum discharge current I _{max} (8/20)		[kA] 15	40	40	70
Nominal discharge current I _n (8/20)		[kA] 5	20	20	30
Voltage protection level Up at I _n (L-N/N-PE/L-PE)		[kA] 1.0 / 1.0 / 1.0	1.4 / 1.4 / 1.5	1.4 / 1.4 / 1.5	1.5 / 1.5 / 1.7
Voltage protection level Up at 3 kA (L-N/N-PE/L-PE)		[kA] 0.9 / 0.9 / 0.9	0.9 / 0.9 / 0.9	0.9 / 0.9 / 0.9	0.8 / 0.8 / 0.8
TOV (Temporary overvoltage) withstand Ut (L-N: 5 s / N-PE: 200 ms)		[V] 334 / 1200	334 / 1200	334 / 1200	334 / 1200
Response time		[ns] ≤ 25	≤ 25	≤ 25	≤ 25
Residual current IPE		[μA] 10	10	10	10
Short-circuit withstand capability I _{sc}		[kA] 50	50	50	50
Backup protection					
	Fuse (gG - gL)	[A] ≤ 50	≤ 50	≤ 50	≤ 50
	Circuit breaker (B or C curve)	[A] ≤ 50	≤ 50	≤ 50	≤ 50
Pluggable cartridge		Yes	Yes	Yes	Yes
Integrated thermal disconnect		Yes	Yes	Yes	Yes
State indicator		Yes	Yes	Yes	Yes
Safety reserve		No	No	Yes	Yes
Auxiliary contact		No	Yes (TS option)	Yes (TS option)	Yes (TS option)
Installation					
Wire range (L, N, PE)					
	Solid wire	[mm ²] 2.5...25	2.5...25	2.5...25	2.5...25
	Stranded wire	[mm ²] 2.5...16	2.5...16	2.5...16	2.5...16
Stripping length (L, N, PE)		[mm] 12.5	12.5	12.5	12.5
Tightening torque (L, N, PE)		[Nm] 2.5	2.5	2.5	2.5
Auxiliary contact (TS)					
Contact complement		–	1 NO - 1 NC	1 NO - 1 NC	1 NO - 1 NC
Minimum load		–	12 V DC - 10 mA	12 V DC - 10 mA	12 V DC - 10 mA
Maximum load		–	250 V AC - 1 A	250 V AC - 1 A	250 V AC - 1 A
Connection cross-section		[mm ²] –	1.5	1.5	1.5
Miscellaneous characteristics					
Stocking and operating temperature		[°C] -40 to +80	-40 to +80	-40 to +80	-40 to +80
Degree of protection		IP20	IP20	IP20	IP20
Fire resistance according to UL 94		V0	V0	V0	V0
Dimensions					
	height x width x depth	[mm] 85 x 35.6 x 64.8	85 x 35.6 x 64.8	85 x 35.6 x 64.8	85 x 35.6 x 64.8
		[inches] 3.35 x 1.40 x 2.55	3.35 x 1.40 x 2.55	3.35 x 1.40 x 2.55	3.35 x 1.40 x 2.55
with auxiliary contact (TS)					
	height x width x depth	[mm] –	96 x 35.6 x 64.8	96 x 35.6 x 64.8	96 x 35.6 x 64.8
		[inches] –	3.78 x 1.40 x 2.55	3.78 x 1.40 x 2.55	3.78 x 1.40 x 2.55

Type 2 surge protective devices are designed to protect electric installations and sensitive equipment against indirect surges with ensuring a low protection level (Up). They are characterized by their capacity to safely discharge current with 8/20 µs wave form.

Type 2 pluggable - Uc 275 V										
Poles	Max discharge current I _{max} 8/20 kA	Nominal discharge current I _n kA	Voltage protection level Up kV	Nominal voltage Un V	Max. cont. operating voltage Uc V	Bbn 3660308 EAN	Order details		Price 1 piece	Weight 1 piece kg
							Type code	Order code		
1+1	15	5	1.0	230/400	275	513106	OVR T2 1N 15-275 P	2CTB803952R1200		0.25
1+1	40	20	1.4	230/400	275	513250	OVR T2 1N 40-275 P	2CTB803952R1100		0.25
1+1	40	20	1.4	230/400	275	514387	OVR T2 1N 40-275 P TS	2CTB803952R0500		0.25
1+1	40	20	1.4	230/400	275	513090	OVR T2 1N 40-275s P	2CTB803952R0800		0.25
1+1	40	20	1.4	230/400	275	513076	OVR T2 1N 40-275s P TS	2CTB803952R0200		0.25
1+1	70	30	1.5	230/400	275	513083	OVR T2 1N 70-275s P	2CTB803952R0700		0.25
1+1	70	30	1.5	230/400	275	513069	OVR T2 1N 70-275s P TS	2CTB803952R0100		0.25

5

Where to find more:

Coordination and Wiring Principals of OVR p.10/164
 Worldwide Marks and Approvals of MDRCs p.11/96
 Technical catalogue of OVR (code 1TXH000083C0202)

Maybe you are also interested in:

For back-up protection:
 S200 MCBs p.2/16
 Fuses and Fuseholders p.5/50

Protection and safety

OVR Type 2 surge protective devices TNS/TT 230 V 3Ph+N networks



OVR T2 3N 15-275 P

Technical features

Types			OVR T2 3N 15-275 P	OVR T2 3N 40-275 P	OVR T2 3N 40-275s P	OVR T2 3N 70-275s P
	with auxiliary contact (TS)		–	OVR T2 3N 40-275 P TS	OVR T2 3N 40-275s P TS	OVR T2 3N 70-275s P TS
Technology			Varistor	Varistor	Varistor	Varistor
Electrical features						
Standard			IEC 61643-1 / EN 61643-11			
Type / test class			T2 / II	T2 / II	T2 / II	T2 / II
Protected lines			3+1	3+1	3+1	3+1
Types of networks			TNS / TT	TNS / TT	TNS / TT	TNS / TT
Type of current			AC	AC	AC	AC
Nominal voltage Un (L-N/L-L)		[V]	230 / 400	230 / 400	230 / 400	230 / 400
Max. cont. operating AC voltage Uc		[V]	275	275	275	275
Maximum discharge current I _{max} (8/20)		[kA]	15	40	40	70
Nominal discharge current I _n (8/20)		[kA]	5	20	20	30
Voltage protection level Up at I _n (L-N/N-PE/L-PE)		[kA]	1.0 / 1.0 / 1.0	1.4 / 1.4 / 1.5	1.4 / 1.4 / 1.5	1.5 / 1.4 / 1.7
Voltage protection level Up at 3 kA (L-N/N-PE/L-PE)		[kA]	0.9 / 0.9 / 0.9	0.9 / 0.9 / 0.9	0.9 / 0.9 / 0.9	0.8 / 0.9 / 0.8
TOV (Temporary overvoltage) withstand Ut (L-N: 5 s / N-PE: 200 ms)		[V]	334 / 1200	334 / 1200	334 / 1200	334 / 1200
Response time		[ns]	≤ 25	≤ 25	≤ 25	≤ 25
Residual current I _{PE}		[μA]	10	10	10	10
Short-circuit withstand capability I _{sc}		[kA]	50	50	50	50
Backup protection		Fuse (gG - gL)	[A]	≤ 50	≤ 50	≤ 50
		Circuit breaker (B or C curve)	[A]	≤ 50	≤ 50	≤ 50
Pluggable cartridge			Yes	Yes	Yes	Yes
Integrated thermal disconnect			Yes	Yes	Yes	Yes
State indicator			Yes	Yes	Yes	Yes
Safety reserve			No	No	Yes	Yes
Auxiliary contact			No	Yes (TS option)	Yes (TS option)	Yes (TS option)
Installation						
Wire range (L, N, PE)		Solid wire	[mm ²]	2.5...25	2.5...25	2.5...25
		Stranded wire	[mm ²]	2.5...16	2.5...16	2.5...16
Stripping length (L, N, PE)		[mm]	12.5	12.5	12.5	12.5
Tightening torque (L, N, PE)		[Nm]	2.5	2.5	2.5	2.5
Auxiliary contact (TS)						
Contact complement			–	1 NO - 1 NC	1 NO - 1 NC	1 NO - 1 NC
Minimum load			–	12 V DC - 10 mA	12 V DC - 10 mA	12 V DC - 10 mA
Maximum load			–	250 V AC - 1 A	250 V AC - 1 A	250 V AC - 1 A
Connection cross-section		[mm ²]	–	1.5	1.5	1.5
Miscellaneous characteristics						
Stocking and operating temperature		[°C]	-40 to +80	-40 to +80	-40 to +80	-40 to +80
Degree of protection			IP20	IP20	IP20	IP20
Fire resistance according to UL 94			V0	V0	V0	V0
Dimensions		height x width x depth	[mm]	85 x 71.2 x 64.8	85 x 71.2 x 64.8	85 x 71.2 x 64.8
			[inches]	3.35 x 2.80 x 2.55	3.35 x 2.80 x 2.55	3.35 x 2.80 x 2.55
with auxiliary contact (TS)		height x width x depth	[mm]	–	96 x 71.2 x 64.8	96 x 71.2 x 64.8
			[inches]	–	3.35 x 2.80 x 2.55	3.35 x 2.80 x 2.55

Type 2 surge protective devices are designed to protect electric installations and sensitive equipment against indirect surges with ensuring a low protection level (Up). They are characterized by their capacity to safely discharge current with 8/20 μ s wave form.

Type 2 pluggable - Uc 275 V										
Poles	Max discharge current I _{max} 8/20 kA	Nominal discharge current I _n kA	Voltage protection level Up kV	Nominal voltage Un V	Max. cont. operating voltage Uc V	Bbn 3660308 EAN	Order details		Price 1 piece	Weight 1 piece kg
							Type code	Order code		
3+1	15	5	1.0	230/400	275	513151	OVR T2 3N 15-275 P	2CTB803953R1200		0.45
3+1	40	20	1.4	230/400	275	513267	OVR T2 3N 40-275 P	2CTB803953R1100		0.45
3+1	40	20	1.4	230/400	275	514394	OVR T2 3N 40-275 P TS	2CTB803953R0500		0.45
3+1	40	20	1.4	230/400	275	513144	OVR T2 3N 40-275s P	2CTB803953R0800		0.45
3+1	40	20	1.4	230/400	275	513120	OVR T2 3N 40-275s P TS	2CTB803953R0200		0.45
3+1	70	30	1.5	230/400	275	513137	OVR T2 3N 70-275s P	2CTB803953R0700		0.45
3+1	70	30	1.5	230/400	275	513113	OVR T2 3N 70-275s P TS	2CTB803953R0100		0.45

5

Where to find more:

Coordination and Wiring Principals of OVR p.10/164
 Worldwide Marks and Approvals of MDRCs p.11/96
 Technical catalogue of OVR (code 1TXH000083C0202)

Maybe you are also interested in:

For back-up protection:
 S200 MCBs p.2/16
 Fuses and Fuseholders p.5/50

Protection and safety

OVR Type 3 surge protective devices TNS/TT 230 V networks



OVR 3N 10 275

5

Technical features			OVR 1N 10 275	OVR 3N 10 275
Types			-	-
	with auxiliary contact (TS)		-	-
Technology			Varistor	Varistor
Electrical features				
Standard			IEC 61643-1 / EN 61643-11	
Type / test class			T3 / III	T3 / III
Protected lines			1+1	3+1
Types of networks			TNS / TT	TNS / TT
Type of current			AC	AC
Nominal voltage U_n (L-N/L-L)	[V]		230 / 400	230 / 400
Max. cont. operating voltage U_c	[V]		275	275
Maximum discharge current I_{max} (8/20)	[kA]		10	10
Nominal discharge current I_n (8/20)	[kA]		3	3
Combination wave U_{oc}	[kV]		6	6
Voltage protection level U_p at I_n (L-N/N-PE/L-PE)	[kA]		0.9 / 1.4	0.9 / 1.4
Voltage protection level U_p at 3 kA (L-N/N-PE/L-PE)	[kA]		0.9 / 0.9	0.9 / 0.9
TOV (Temporary overvoltage) (L-N: 5 s / N-PE: 200 ms)	[V]		334 / 440	334 / 440
withstand U_t				
Response time	[ns]		≤ 25	≤ 25
Residual current IPE	[μA]		10	10
Short-circuit withstand capability I_{scrr}	[kA]		10	10
Backup protection	Fuse (gG - gL)	[A]	≤ 25	≤ 25
	Circuit breaker (B or C curve)	[A]	≤ 10	≤ 10
Pluggable cartridge			No	No
Integrated thermal disconnecter			Yes	Yes
State indicator			Yes	Yes
Safety reserve			No	No
Auxiliary contact			No	No
Installation				
Wire range (L, N, PE)	Solid wire	[mm ²]	2.5...25	2.5...25
	Stranded wire	[mm ²]	2.5...16	2.5...16
Stripping length (L, N, PE)	[mm]		12.5	12.5
Tightening torque (L, N, PE)	[Nm]		2.5	2.5
Auxiliary contact (TS)			-	-
Contact complement			-	-
Minimum load			-	-
Maximum load			-	-
Connection cross-section	[mm ²]		-	-
Miscellaneous characteristics				
Stocking and operating temperature	[°C]		-40 to +80 / -40 to +70	-40 to +80 / -40 to +70
Degree of protection			IP20	IP20
Fire resistance according to UL 94			V0	V0
Dimensions	height x width x depth	[mm]	85 x 35.6 x 64.8	85 x 71.2 x 64.8
		[inches]	3.35 x 1.40 x 2.55	3.35 x 2.80 x 2.55

Where to find more:

Coordination and Wiring Principals of OVR p.10/164
Worldwide Marks and Approvals of MDRCs p.11/96
Technical catalogue of OVR (code 1TXH000083C0202)

Maybe you are also interested in:

For back-up protection:
S200 MCBs p.2/16
Fuses and Fuseholders p.5/50

Type 3 surge protective devices shall be installed as close as possible from the sensitive equipment to protect. Tested with a 1.2/50 - 8/20 current combination wave generator, they ensure a very low protection level.

Type 3 non-pluggable - Uc 275 V										
Poles	Max discharge current I _{max} 8/20 kA	Nominal discharge current I _n kA	Voltage protection level Up kV	Nominal voltage Un V	Max. cont. operating voltage Uc V	Bbn 3660308 EAN	Order details		Price 1 piece	Weight 1 piece kg
							Type code	Order code		
1+1	10	3	0.9	230/400	275	509208	OVR 1N 10 275	2CTB813912R1000		0.27
3+1	10	3	0.9	230/400	275	509215	OVR 3N 10 275	2CTB813913R1000		0.48

5

Protection and safety

OVR Plus - Autoprotected surge protective devices TNS/TT

230 V networks



OVR PLUS N3 20
OVR PLUS N3 40

Technical features			OVR Plus N1 20	OVR Plus N1 40	OVR Plus N3 20	OVR Plus N3 40
Types	with auxiliary contact (TS)		-	-	-	-
Technology			Varistor	Varistor	Varistor	Varistor
Electrical features						
Standard			IEC 61643-1 / EN 61643-11			
Type / test class			T2 / II	T2 / II	T2 / II	T2 / II
Protected lines			1+1	1+1	3+1	3+1
Types of networks			TNS / TT	TNS / TT	TNS / TT	TNS / TT
Type of current			AC	AC	AC	AC
Nominal voltage Un (L-N/L-L)	[V]		230 / 400	230 / 400	230 / 400	230 / 400
Max. cont. operating voltage Uc	[V]		275	320	320	320
Maximum discharge current I _{max} (β/20)	[kA]		20	40	20	40
Nominal discharge current I _n (β/20)	[kA]		5	20	5	20
Voltage protection level Up at I _n (L-N/N-PE/L-PE)	[kV]		1.3 / - / 1.3	1.6 / - / 1.8	1.3 / 1.3 / 1.3	2.0 / 1.5 / 2.0
Voltage protection level Up at 3 kA (L-N/N-PE/L-PE)	[kV]		1.1 / - / 1.1	1.1 / - / 1.1	1.1 / 1.1 / 1.1	1.1 / 1.1 / 1.1
TOV (Temporary overvoltage) withstand Ut (L-N: 5 s / N-PE: 200 ms)	[V]		334 / 1200	334 / 1200	334 / 1200	334 / 1200
Response time	[ns]		≤ 25	≤ 25	≤ 25	≤ 25
Residual current IPE	[μA]		10	10	10	10
Short-circuit withstand capability I _{sc}	[kA]		10	15	10	15
Backup protection	Fuse (gG - gL)	[A]	integrated	integrated	integrated	integrated
	Circuit breaker (B or C curve)	[A]	integrated	integrated	integrated	integrated
Pluggable cartridge			No	No	No	No
Integrated thermal disconnecter			Yes	Yes	Yes	Yes
State indicator			Yes	Yes	Yes	Yes
Safety reserve			No	No	No	No
Auxiliary contact			Yes (S2C-H6R / 2CDS200912R0001)			
Installation						
Wire range (L, N, PE)	Solid wire	[mm ²]	2.5...25	2.5...25	2.5...25	2.5...25
	Stranded wire	[mm ²]	2.5...16	2.5...16	2.5...16	2.5...16
Stripping length (L, N, PE)	[mm]		11	11	11	11
Tightening torque (L, N, PE)	[Nm]		2.5	2.5	2.5	2.5
Auxiliary contact (TS)			-	-	-	-
Contact complement			-	-	-	-
Minimum load			-	-	-	-
Maximum load			-	-	-	-
Connection cross-section	[mm ²]		-	-	-	-
Miscellaneous characteristics						
Stocking and operating temperature	[°C]		-40 to +70 / -25 to +55	-40 to +70 / -25 to +55	-40 to +70 / -25 to +55	-40 to +70 / -25 to +55
Degree of protection			IP20	IP20	IP20	IP20
Fire resistance according to UL 94			V0	V0	V0	V0
Dimensions	height x width x depth	[mm]	91 x 35.6 x 74.6	91 x 35.6 x 74.6	100.8 x 106.8 x 74.6	100.8 x 106.8 x 74.6
		[inches]	3.58 x 1.40 x 2.94	3.58 x 1.40 x 2.94	3.97 x 4.20 x 2.94	3.97 x 4.20 x 2.94

OVR PLUS N3 20 and OVR PLUS N3 40 for commercial and industrial applications:

- Auto-protected: Backup miniature circuit breaker integrated and fully coordinated with the surge protective device.
- Easy installation: Fully coordinated unit with easy wiring with the complete ABB pro M modular range.
- High discharge capacity: With I_{max} 20 and 40 kA the OVR Plus N3 insure the protection of your low voltage installations and electric equipment.
- High reliability: No welding inside the module and specific thermal disconnection with the „bilame“ sensor.

OVR PLUS N1 40 for residential applications:

- Auto-protected: Backup miniature circuit breaker integrated and fully coordinated with the surge protective device.
- Compact: Only two modules (36 mm width), means more space and easy wiring with the complete ABB DIN rail range.
- High discharge capacity: With I_{max} 20 and 40 kA the OVR PLUS N1 can protect your electric equipment against high surges.
- High reliability: No welding inside the module and specific thermal disconnection.

5

Type 2 autoprotected										
Poles	Max discharge current I _{max} 8/20 kA	Nominal discharge current I _n kA	Voltage protection level Up kV	Nominal voltage Un V	Max. cont. operating voltage Uc V	Bbn 3660308 EAN	Order details		Price 1 piece	Weight 1 piece kg
							Type code	Order code		
1+1	20	5	1.3	230/400	275	521286	OVR PLUS N1 20	2CTB803701R0700		0.28
1+1	40	20	1.8	230/400	320	517005	OVR PLUS N1 40	2CTB803701R0100		0.28
3+1	20	5	1.3	230/400	320	517081	OVR PLUS N3 20	2CTB803701R0400		0.84
3+1	40	20	2.0	230/400	320	517074	OVR PLUS N3 40	2CTB803701R0300		0.84

Where to find more:

Worldwide Marks and Approvals of MDRCs p.11/96
 Technical catalogue of OVR (code TXH000083C0202)

Maybe you are also interested in:

For back-up protection:
 S200 MCBs p.2/16
 Fuses and Fuseholders p.5/50

Protection and safety

OVR PV surge protective devices Photovoltaic networks



OVR PV

5

Technical features						
Types			–	–	OVR PV 40-600 P	OVR PV 40-1000 P
		with auxiliary contact (TS)	OVR PV T1 6.25-600 P TS	OVR PV T1 6.25-1000 P TS	OVR PV 40-600 P TS	OVR PV 40-1000 P TS
Technology			Varistor	Varistor	Varistor	Varistor
Electrical features						
Standard			UTE C 61-740-51 / prEN 50539-11			
Type / test class			T1 / I	T1 / I	T2 / II	T2 / II
Protected lines			2	2	2	2
Types of networks			Photovoltaic	Photovoltaic	Photovoltaic	Photovoltaic
Type of current			DC	DC	DC	DC
Nominal voltage Un (L-N/L-L)		[V]	600	1000	600	1000
Max. cont. operating voltage Ucpv		[V]	670	1000	670	1000
Impulse current Iimp (10/350)			6.25	6.25	–	–
Maximum discharge current I _{max} (8/20)		[kA]	–	–	40	40
Nominal discharge current I _n (8/20)		[kA]	6.25	6.25	20	20
Voltage protection level Up at I _n		[kV]	1.9 / 1.9	2.5 / 2.5	2.8 / 1.4	3.8 / 3.8
Response time		[ns]	≤ 25	≤ 25	≤ 25	≤ 25
Residual current IPE		[μA]	75	75	10	75
Short-circuit DC current I _{scwpv}		[A]	100	100	100	100
Disconnecter		Fuse	10AgPV (E90PV)	10AgPV (E90PV)	10AgPV (E90PV)	10AgPV (E90PV)
		Circuit breaker	–	–	S802PV-S10	S804PV-S10
Pluggable cartridge			Yes	Yes	Yes	Yes
Integrated specific thermal disconnecter			Yes	Yes	Yes	Yes
State indicator			Yes	Yes	Yes	Yes
Safety reserve			No	No	No	No
Auxiliary contact			Yes	Yes	Yes (TS option)	Yes (TS option)
Installation						
Wire range (L, N, PE)		Solid wire	[mm ²] 2.5...25	2.5...25	2.5...25	2.5...25
		Stranded wire	[mm ²] 2.5...16	2.5...16	2.5...16	2.5...16
Stripping length (L, N, PE)			12.2	12.2	12.2	12.2
Tightening torque (L, N, PE)			2.5	2.5	2.5	2.5
Auxiliary contact (TS)						
Contact complement			1 NO - 1 NC	1 NO - 1 NC	1 NO - 1 NC	1 NO - 1 NC
Minimum load			12 V DC - 10 mA	12 V DC - 10 mA	12 V DC - 10 mA	12 V DC - 10 mA
Maximum load			250 V AC - 1 A	250 V AC - 1 A	250 V AC - 1 A	250 V AC - 1 A
Connection cross-section			1.5	1.5	1.5	1.5
Miscellaneous characteristics						
Stocking and operating temperature		[°C]	-40 to +80	-40 to +80	-40 to +80	-40 to +80
Degree of protection			IP20	IP20	IP20	IP20
Fire resistance according to UL 94			V0	V0	V0	V0
Dimensions		height x width x depth	[mm] –	–	88 x 53.4 x 65	88 x 53.4 x 65
			[inches] –	–	3.46 x 2.10 x 2.56	3.46 x 2.10 x 2.56
with auxiliary contact		height x width x depth	[mm] 88 x 160.2 x 65	88 x 160.2 x 65	88 x 53.4 x 65	88 x 53.4 x 65
(TS)			[inches] 3.46 x 6.31 x 2.56	3.46 x 6.31 x 2.56	3.46 x 2.10 x 2.56	3.46 x 2.10 x 2.56



OVR PV T1 6.25-600 P TS



OVR PV 40-600 P

Specifically designed for photovoltaic DC installations, the OVR PV family provide a safe and reliable surge and lightning protection of solar panels and converters.
The OVR PV surge protective devices comply with UTE C 61-740-51 and prEN 50539-11.

Type 1 PV

Pro- tected lines	Im- pulse current	Max. di- schar- ge current	No- minal current	Vol- tage pro- tection level	Max. cont. ope- rating voltage	Bbn 3660308	Order details		Price 1 pie- ce	Weight 1 piece
							Type code	Order code		
	Iimp 10/350 kA	I _{max} 8/20 kA	I _n kA	U _p kV	U _{cpv} V	EAN				kg
2	6.25	-	6.25	1.9	670	518361	OVR PV T1 6.25-600 P TS	2CTB803953R5700		1.10
2	6.25	-	6.25	2.5	1000	518378	OVR PV T1 6.25-1000 P TS	2CTB803953R6700		1.10

5

Type 2 PV

Pro- tected lines	Im- pulse current	Max. di- schar- ge current	No- minal current	Vol- tage pro- tection level	Max. cont. ope- rating voltage	Bbn 3660308	Order details		Price 1 pie- ce	Weight 1 piece
							Type code	Order code		
	Iimp 10/350 kA	I _{max} 8/20 kA	I _n kA	U _p kV	U _{cpv} V	EAN				kg
2	-	40	20	1.4	670	516510	OVR PV 40-600 P	2CTB803953R5300		0.38
2	-	40	20	1.4	670	516527	OVR PV 40-600 P TS	2CTB803953R5400		0.39
2	-	40	20	3.8	1000	516534	OVR PV 40-1000 P	2CTB803953R6400		0.38
2	-	40	20	3.8	1000	516541	OVR PV 40-1000 P TS	2CTB803953R6500		0.39

Where to find more:

Worldwide Marks and Approvals of
MDRCs p.11/96
Technical catalogue of OVR (code
TXH000083C0202)

Maybe you are also interested in:

For back-up protection:
S200 MCBs p.2/16
Fuses and Fuseholders p.5/50

Protection and safety

OVR TC surge protective devices Data networks

Technical features								
Types			OVR TC 06V P	OVR TC 12V P	OVR TC 24V P	OVR TC 48V P	OVR TC 200V P	OVR TC 200FR P
	with auxiliary contact (TS)		-	-	-	-	-	-
Connection configuration			Serial	Serial	Serial	Serial	Parallel	Serial
Electrical features								
Standard			IEC/EN 61643-21					
Type / test class			C2	C2	C2	C2	C2	C2
Protected lines			1 pair	1 pair	1 pair	1 pair	1 pair	1 pair
Types of networks			MIC/T2 - RS422/485	RS232	LS - 4/20mA	RNIS	ADSL	RTC / Analogue
Type of current			DC	DC	DC	DC	DC	DC
Nominal voltage Un		[V]	6	12	24	48	200	200
Max. cont. operating voltage Uc		[V]	7	14	27	53	220	220
Maximum discharge current Imax (8/20)		[kA]	10	10	10	10	10	10
Nominal discharge current In (8/20)		[kA]	5	5	5	5	5	5
Voltage protection level Up at In		[kV]	15	20	35	70	700	400
Response time		[ns]	1	1	1	1	100	1
Rated current IL		[mA]	140	140	140	140	-	140
Series resistance		[Ω]	10	10	10	10	-	10
Cut frequency		[MHz]	10	2	4	6	100	3
Pluggable cartridge			Yes	Yes	Yes	Yes	Yes	Yes
State indicator			-	-	-	-	-	-
Safety reserve			No	No	No	No	No	No
Auxiliary contact			No	No	No	No	No	No
Installation								
Wire range (L, N, PE)	Solid wire	[mm ²]	1.5 / 2.5	1.5 / 2.5	1.5 / 2.5	1.5 / 2.5	1.5 / 2.5	1.5 / 2.5
	Stranded wire	[mm ²]	-	-	-	-	-	-
Stripping length (L, N, PE)		[mm]	6 / 7	6 / 7	6 / 7	6 / 7	6 / 7	6 / 7
Tightening torque (L, N, PE)		[Nm]	0.2 / 0.4	0.2 / 0.4	0.2 / 0.4	0.2 / 0.4	0.2 / 0.4	0.2 / 0.4
Auxiliary contact (TS)								
Contact complement			-	-	-	-	-	-
Minimum load			-	-	-	-	-	-
Maximum load			-	-	-	-	-	-
Connection cross-section			-	-	-	-	-	-
Miscellaneous characteristics								
Stocking and operating temperature		[°C]	-40 to +80	-40 to +80	-40 to +80	-40 to +80	-40 to +80	-40 to +80
Degree of protection			IP20	IP20	IP20	IP20	IP20	IP20
Fire resistance according to UL 94			V0	V0	V0	V0	V0	V0
Dimensions	height x width x depth	[mm]	85 x 12 x 64	85 x 12 x 64	85 x 12 x 64	85 x 12 x 64	85 x 12 x 64	85 x 12 x 64
		[inches]	8.67 x 0.47 x 1.57	8.67 x 0.47 x 1.57	8.67 x 0.47 x 1.57	8.67 x 0.47 x 1.57	8.67 x 0.47 x 1.57	8.67 x 0.47 x 1.57



OVR TC 200FR P



Base OVR TC RJ 11
Base OVR TC RJ 45

The OVR TC family offers a reliable surge protection to dataline networks for datacenters, water treatment installations or wind turbine installations.
With the RJ11 and RJ45 bases they allow a flexible and easy installation.

Dataline protection modules

Protected lines	Max. discharge current I _{max} 8/20 kA	Nominal / rated current I _n /I _Δ kA/mA	Voltage protection level U _p kV	Nominal voltage U _n V	Max. cont. operating voltage U _c V	Bbn 3660308 EAN	Order details		Price 1 piece	Weight 1 piece kg
							Type code	Order code		
1 pair	10	5 / 140	15	6	7	515230	OVR TC 06V P	2CTB804820R0000		0.07
1 pair	10	5 / 140	20	12	14	515247	OVR TC 12V P	2CTB804820R0100		0.07
1 pair	10	5 / 140	35	24	27	515254	OVR TC 24V P	2CTB804820R0200		0.07
1 pair	10	5 / 140	70	48	53	515261	OVR TC 48V P	2CTB804820R0300		0.07
1 pair	10	5 / -	700	200	220	515278	OVR TC 200V P	2CTB804820R0400		0.07
1 pair	10	5 / 140	400	200	220	515285	OVR TC 200FR P	2CTB804820R0500		0.07

5

Bases

Protected lines	Max. discharge current I _{max} 8/20 kA	Nominal / rated current I _n /I _Δ kA/mA	Voltage protection level U _p kV	Nominal voltage U _n V	Max. cont. operating voltage U _c V	Bbn 3660308 EAN	Order details		Price 1 piece	Weight 1 piece kg
							Type code	Order code		
-	-	-	-	-	-	515599	BASE OVR TC RJ11	2CTB804840R1000		0.07
-	-	-	-	-	-	515605	BASE OVR TC RJ45	2CTB804840R1100		0.07

Where to find more:
Worldwide Marks and Approvals of MDRCs p.11/96
Technical catalogue of OVR (code TXH000083C0202)

Maybe you are also interested in:
For back-up protection:
S200 MCBs p.2/16
Fuses and Fuseholders p.5/50

E 90. Uncompromising performance

A safe and smart range designed for quick, flexible and error-proof installation

Compactness

When open, the drawer projection is only 17 mm more than in the normal position.

Reliability

Venting grooves and cooling chambers improve heat dissipation even in multiple-pole configurations.



Completeness

The fuse tripping can be easily displayed, thanks to the special blown fuse indicator light.

Universal use

Screw holes have increased diameter to accommodate insulated screwdrivers and electric screwdrivers.



5

Fuseholder profile has been designed for maximum ease of use: the 90° flip hinge with ergonomic knob, makes the replacement of fuses easier even in small spaces or when wearing protective gloves.

The compact dimensions enable to close the switchboard door even when the fuseholder is open, thus ensuring total safety during maintenance.



With the Prozidriv PZ2 screws tightening can be performed by exerting less torque than conventional screws, and the same electric screwdriver can be used for all terminals. Moreover, the PS connection busbars facilitate the connecting operations, making the wiring both simple and safe and providing complete integration with S 200 and SN 201 System pro M compact® circuit-breakers.

Venting grooves and cooling chambers improve heat dissipation even in multiple-pole configurations. The reduced operating temperature inside fuseholders ensures durability and reliability of the devices over time.

Protection and safety

E 90 fuse switch disconnectors



E 90

Technical features					
Type		E 90/20	E 90/32		
Rated current	A	20	32		
Type of current		a.c.			
Fuse	[mm]	8 x 31	10 x 38		
Max power dissipation accepted	[W]	2.5	3		
Rated frequency	[Hz]	50-60			
Tightening torque	[Nm]	PZ2 2-2.5			
Protection degree		IP20			
Terminals' section	[mm ²]	25			
Cross section rigid copper conductors	[mm ²]	1.5-25			
Cross section stranded copper conductors	[mm ²]	1.5-16			
Operating temperature	[°C]	-5/+40 ①			
Storage temperature	[°C]	-25/+70 ②			
Altitude	[m]	2000			
Voltage range for LED indicator light		24-1000 AC/DC (only s version)			
Padlockable (when open)		■	■		
Sealable (when closed)		■	■		
IEC 60947-3					
Utilization category		AC-22B	AC-20B	AC-22B	AC-20B
Markings	[V]	400	690	400	690

① for lower temperature verify fuse technical characteristics, for higher temperature refer to derating table at page 10/163

② for more than 24h max temperature is +55 °C

Shock and vibration

Vibration withstand on the 3 main axis:

- Sinusoidal vibration testing according to IEC 60068-2-6: 2 to 13 Hz x = 1 mm peak; 13 to 100 Hz y = 0.7 g peak
- Random vibration testing according to IEC 61373: Category 1 Class B

Shock withstand

- Shock testing according to IEC 60068-2-27 : 15 g / 11 ms / 18 shocks
- Shock testing according to IEC 61373: Category 1 Class B

Materials

Plastic parts	Case:	Material PA 6 +30% glass fibre Self extinguishing class: V2 (UL94) Temperature resistance: 130 °C
	Opening handle	Material PA 66 +25% glass fibre Self-extinguishing class V0 (UL94) Temperature resistance: 140 °C
	Metal parts	
	Clips	Silver plated copper
	Clip spring	Stainless steel
	Terminals	Galvanized steel

The E 90 series is environmental friendly and protects the health of people: all used materials are conform to the RoHS and REACH directives and they completely exclude hazardous substances and halogen.

Where to find more:

Utilization Categories of E90 p.10/170
Worldwide Marks and Approvals of MDRCs p.11/96

Frequently asked question - FAQ:

Protection and Safety Technical
Details for E90 p.10/170

Maybe you are also interested in:

E 9F gG cylindrical fuses pag. 5/55
E 9F aM cylindrical fuses pag. 5/59



E 92



E 94

E 90 fuse switch disconnectors

E 90 series fuse switch disconnectors are designed for switching circuits under load, providing protection against short circuits and overloads. The case is made of self-extinguishing thermoplastic material resistant to high temperatures (all materials are UL listed) while the contact clips are in silver plated copper.

E 90 fuse switch disconnectors can be sealed or padlocked to ensure operator safety during maintenance. Versions with blown fuse indicator allow to check whether the fuse is still working correctly or not. For easy and quick installation E 90 range is totally compatible with connecting bars, terminals and caps of S 200 MCBs.

Thanks to cURus approval, they can be installed in UL certified machines.

E 90 fuse switch disconnectors for 10.3 x 38 mm fuses (AC-22B)

Poles	Rated current	Modules	Bbn 8012542	Order details		Price 1 piece	Weight 1 piece kg	Pack unit pc.
	In		EAN	Type code	Order code			
1	32	1	009238	E 91/32	2CSM200923R1801		0.061	6
1	32	1	024835	E 91/32s	2CSM202483R1801		0.062	6
1+N	32	2	008934	E 91N/32	2CSM200893R1801		0.130	3
1+N	32	2	515036	E 91N/32s	2CSM251503R1801		0.132	3
2	32	2	008835	E 92/32	2CSM200883R1801		0.122	3
2	32	2	514930	E 92/32s	2CSM251493R1801		0.132	3
3	32	3	047537	E 93/32	2CSM204753R1801		0.183	2
3	32	3	020639	E 93/32s	2CSM202063R1801		0.184	2
3+N	32	4	047339	E 93N/32	2CSM204733R1801		0.252	1
3+N	32	4	514831	E 93N/32s	2CSM251483R1801		0.255	1
4	32	4	047230	E 94/32	2CSM204723R1801		0.244	1
4	32	4	020530	E 94/32s	2CSM202053R1801		0.248	1

s: version with blown fuse indicator light

E 90 fuse switch disconnectors for 8.5 x 31.5 mm fuses (AC-22B)

Poles	Rated current	Modules	Bbn 8012542	Order details		Price 1 piece	Weight 1 piece kg	Pack unit pc.
	In		EAN	Type code	Order code			
1	20	1	009832	E 91/20	2CSM200983R1801		0.061	6
1	20	1	024231	E 91/20s	2CSM202423R1801		0.062	6
2	20	2	009535	E 92/20	2CSM200953R1801		0.122	3
2	20	2	896234	E 92/20s	2CSM289623R1801		0.062	3
3	20	3	009436	E 93/20	2CSM200943R1801		0.183	2
3	20	3	896135	E 93/20s	2CSM289613R1801		0.184	2

s: version with blown fuse indicator light

Protection and safety

E 90h fuseholders



E 91hN



E 93hN



Fuse indicator LED

Technical features			
Type		E 90hN/20	E 90hN/32
Rated current	[A]	20	32
Type of current		a.c.	
Fuse	[mm]	8 x 31	10 x 38
Max power dissipation accepted	[W]	2.6	3.2
Rated frequency	[Hz]	50-60	
Tightening torque	[Nm]	PZ2 0.8-1.2	
Protection degree		IP20	
Terminals' section	[mm ²]	16	
Cross section rigid copper conductors	[mm ²]	1.5-16	
Cross section stranded copper conductors	[mm ²]	1.5-10	
Operating temperature	[°C]	-5/+40 ①	
Storage temperature	[°C]	-25/+70 ②	
Altitude	[m]	2000	
Voltage range for LED indicator light		24-1000 AC/DC (only s version)	
Padlockable (when open)		■	
Sealable (when closed)		■	
IEC 60269-3			
Rated voltage	[V]	400	

① for lower temperature verify fuse technical characteristics, for higher temperature refer to derating table at page 10/163

② for more than 24h max temperature is +55 °C

E 90h fuseholders

E 90h fuseholders are suitable for protection against overloads and short circuits. Available in a single module 1P+N version and in a three-module 3P+N version, they are designed for use with gG and aM cylindrical fuse links. The body is made from self-extinguishing material resistant to high temperatures, while the contact clips are in silver-plated copper. E 90h fuseholders can be sealed or padlocked to assure operator safety during maintenance. Versions with blown fuse indicator allow to check whether the fuse is still working correctly or not.

E 90h fuseholders for 10.3 x 38 mm fuses

Poles	Rated current	Modules	Bbn 8012542	Order details		Price 1 piece	Weight 1 piece	Pack unit
	In		EAN	Type code	Order code		kg	pc.
1+N	32	1	009139	E 91hN/32	2CSM200913R1801		0.070	6
1+N	32	1	065739	E 91hN/32s	2CSM206573R1801		0.071	6
3+N	32	3	047438	E 93hN/32	2CSM204743R1801		0.192	2
3+N	32	3	743439	E 93hN/32s	2CSM274343R1801		0.200	2

s: version with blown fuse indicator light

E 90h fuseholders for 8.5 x 31.5 mm fuses

Poles	Rated current	Modules	Bbn 8012542	Order details		Price 1 piece	Weight 1 piece	Pack unit
	In		EAN	Type code	Order code		kg	pc.
1+N	20	1	009634	E 91hN/20	2CSM200963R1801		0.070	6
1+N	20	1	007036	E 91hN/20s	2CSM200703R1801		0.071	6
3+N	20	3	009337	E 93hN/20	2CSM200933R1801		0.192	2
3+N	20	3	896036	E 93hN/20s	2CSM289603R1801		0.200	2

s: version with blown fuse indicator light

Where to find more:

Protection and disconnection of 1000V DC lines with E90h p.10/172
Utilization Categories of E90 p.10/170
Worldwide Marks and Approvals of MDRCs p.11/96

Frequently asked question - FAQ:

Protection and Safety Technical Details for E90 p.10/170

Maybe you are also interested in:

E 9F gG cylindrical fuses pag. 5/55
E 9F aM cylindrical fuses pag. 5/59

Protection and safety

E 90 PV fuse disconnectors



E 90 PV

Technical features			
Type		E 90/32 PV	E 90/32 PV according to UL
Rated current	[A]	32	
Rated voltage	[V]		1000
Type of current		d.c.	
Fuse	[mm]	10 x 38	
Max power dissipation accepted	[W]	3	
Rated frequency	[Hz]	-	
Tightening torque	[Nm]	PZ2 2-2.5 Nm	PZ2 18-22 lb-in
Protection degree		IP20	
Terminals' section	[mm ²]	25	
Cross section rigid copper conductors		1.5 - 25 mm ²	n..a.
Cross section stranded copper conductors		1.5 - 16 mm ²	8÷3 AWG
Operating temperature	[°C]	-5/+40 ①	
Storage temperature	[°C]	-25/+70 ②	
Altitude	[m]	2000	
Voltage range for LED indicator light		24-1000 AC/DC (only s version)	
Can be padlocked (open)		■	
Can be sealed (closed)		■	
IEC 60947-3			
Utilization category		DC-20B	
Rated voltage	[V]	1000	

5

① for lower temperature verify fuse technical characteristics, for higher temperature refer to derating table at page 10/163
 ② for more than 24h max temperature is +55 °C

E 90 PV fuse disconnectors

E 90 PV series fuse disconnectors, designed for operating voltages of 1000 V d.c. with utilization category DC-20B, are particularly suited for protection against overcurrents of photovoltaic systems. The single-pole or two-pole E 90 PV disconnectors for 10.3 x 38 mm cylindrical fuse links offer a reliable, compact and affordable solution for photovoltaic installations. Versions with blown fuse indicator allow to check whether the fuse is still working correctly or not.

E 90 PV fuse disconnectors for 10.3 x 38 mm fuses (DC-20B)								
Poles	Rated current	Modules	Bbn 8012542	Order details		Price 1 piece	Weight 1 piece	Pack unit
	In			EAN	Type code			
1	32	1	047131	E 91/32 PV	2CSM204713R1801		0.061	6
1	32	1	046936	E 91/32 PVs	2CSM204693R1801		0.062	6
2	32	2	047032	E 92/32 PV	2CSM204703R1801		0.122	3
2	32	2	569138	E 92/32 PVs	2CSM256913R1801		0.233	3

s: version with blown fuse indicator light

Where to find more:
 Utilization Categories of E90 p.10/170
 Worldwide Marks and Approvals of MDRCs p.11/96

Frequently asked question - FAQ:
 Protection and Safety Technical
 Details for E90 p.10/170

Maybe you are also interested in:
 E 9F gG cylindrical fuses pag. 5/55
 E 9F aM cylindrical fuses pag. 5/59

Protection and safety

E 90 class CC fuseholders



E 91



E 93

Technical features		
Type	E 90/30	
Rated voltage Un	[V]	600 a.c. /d.c.
Rated current In	[A]	30
Rated frequency	[Hz]	=/50-60
Fuse size	[mm]	10.4 x 38.1 (class CC)
Tightening torque	[Nm]	PZ2 2-2.5
	[lb-in]	PZ2 18-22
Rated temperature	[°C]	75
Voltage range for LED indicator light (only s version)	[V]	24 - 1000 a.c./d.c.
Can be sealed closed		■
Can be padlocked open		■

The E 90 fuse carriers for Class CC cylindrical fuse links are specifically designed for the North American market in compliance with the UL standards. In accordance with the reference standards UL 4248-1 and UL 4248-4, they come in voltage and current ratings up to 600V and 30A. They are available in 1P, 1P+N, 2P, 3P, 3P+N and 4P versions. They can be padlocked open and sealed closed.

The E 90 fuse carriers are the ideal solution for process control and industrial systems, automation systems, industrial installations and control circuits. The versions with blown fuse indicator light provide a visual signal of the fuse break condition

E 90 for class CC cartridge fuses								
Poles	Rated current In	Modules	Bbn 8012542 EAN	Order details		Price 1 piece	Weight 1 piece kg	Pack unit pc.
				Type code	Order code			
1	30	1	998723	E 91/30 CC	2CSM299872R1801		0,061	6
1	30	1	998822	E 91/30s CC	2CSM299882R1801		0,062	6
1+N	30	2	998921	E 91N/30 CC	2CSM299892R1801		0,13	3
1+N	30	2	999027	E 91N/30s CC	2CSM299902R1801		0,13	3
2	30	2	999126	E 92/30 CC	2CSM299912R1801		0,122	3
2	30	2	999225	E 92/30s CC	2CSM299922R1801		0,122	3
3	30	3	999324	E 93/30 CC	2CSM299932R1801		0,183	2
3	30	3	999423	E 93/30s CC	2CSM299942R1801		0,183	2
3+N	30	4	999522	E 93N/30 CC	2CSM299952R1801		0,252	1
3+N	30	4	999621	E 93N/30s CC	2CSM299962R1801		0,252	1
4	30	4	999720	E 94/30 CC	2CSM299972R1801		0,244	1
4	30	4	999829	E 94/30s CC	2CSM299982R1801		0,244	1

s: version with blown fuse indicator light

Where to find more:

Utilization Categories of E90 p.10/170
Worldwide Marks and Approvals of MDRCs p.11/96

Frequently asked question - FAQ:

Protection and Safety Technical
Details for E90 p.10/170

Maybe you are also interested in:

E 9F gG cylindrical fuses pag. 5/55
E 9F aM cylindrical fuses pag. 5/59

Protection and safety

E 930 fuse disconnectors



E 931

Technical features			
Type		E 930/50	E 930/125
Rated current	[A]	50	125
Type of current		a.c./d.c.	
Fuse	[mm]	14 x 51	22 x 58
Max power dissipation accepted	[W]	5	9.5
Rated frequency	[Hz]	= /50-60	
Tightening torque	[Nm]	PZ2 3.5	PZ2 4
Protection degree		IP20	
Terminals' section	[mm ²]	35	50
Cross section rigid copper conductors	[mm ²]	2.5 - 35	4 - 50
Cross section stranded copper conductors	[mm ²]	2.5 - 25	4 - 35
Can be sealed closed		■	
Can be padlocked open		■	
IEC 60947-3			
Utilization category		AC-20B / DC-20B	
Rated voltage	[V]	690	

5

* For lower temperature verify fuse technical characteristics, for higher temperature refer to derating table at page 5/28

E 930 fuse disconnectors

The E 930 fuse disconnector range, for current of 50 A and 125 A, is specifically intended for industrial circuit protection. The E 930 can carry any type of cylindrical fuses 14x51 and 22x58 mm, they are padlockable in open position to ensure operator safety during maintenance operations. The E 930 also support MCR microswitches, through which you can get a complete remote monitoring of the device state. The microswitch makes it possible to report: the fuse intervention, the opening of the drawer and the fuse absence with closed drawer. Microswitch functionalities are guarantee only using fuses with striker pin.

E 930 fuse disconnectors for 14 x 51 mm fuses (AC-20B)

Poles	Rated current	Modules	Bbn 8012542	Order details		Price 1 piece	Weight 1 piece	Pack unit
	In			EAN	Type code			
1	50	1.5	446804	E 931/50	2CSM361610R1801		0.200	6
1+N	50	3	446903	E 931N/50	2CSM365610R1801		0.400	3
2	50	3	447009	E 932/50	2CSM362610R1801		0.400	3
3	50	4.5	447108	E 933/50	2CSM363610R1801		0.600	1
3+N	50	6	447207	E 933N/50	2CSM367610R1801		0.800	1

E 930 fuse disconnectors for 22 x 58 mm fuses (AC-20B)

Poles	Rated current	Modules	Bbn 8012542	Order details		Price 1 piece	Weight 1 piece	Pack unit
	In			EAN	Type code			
1	125	2	447504	E 931/125	2CSM371710R1801		0.200	6
1+N	125	4	447603	E 931N/125	2CSM375710R1801		0.400	3
2	125	4	447702	E 932/125	2CSM372710R1801		0.400	3
3	125	6	447801	E 933/125	2CSM373710R1801		0.600	1
3+N	125	8	447900	E 933N/125	2CSM377710R1801		0.800	1

Where to find more:

Protection and Safety Technical Details for E930 p.10/173
Worldwide Marks and Approvals of MDRCs p.11/96

Frequently asked question - FAQ:

Protection and Safety Technical Details for E90 p.10/170

Maybe you are also interested in:

E 9F gG cylindrical fuses pag. 5/55
E 9F aM cylindrical fuses pag. 5/59

Protection and safety

E 930 fuse disconnectors

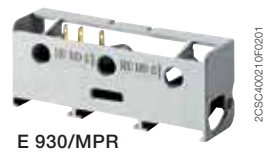

E 930/MPR

2CSC400210F0201

Microswitches for series E 930 fuse disconnectors								
Poles	Rated current	Modules	Bbn 8012542	Order details		Price 1 piece	Weight 1 piece	Pack unit
	In		EAN	Type code	Order code	kg	pc.	
1	50	1	451006	E 930/MCR1P50	2CSM060019R1801		0.030	1
3	50	3	451105	E 930/MCR3P50	2CSM060029R1801		0.030	1
1	125	1	451204	E 930/MCR1P125	2CSM070019R1801		0.030	1
3	125	3	451303	E 930/MCR3P125	2CSM070029R1801		0.030	1

Where to find more:

Protection and Safety Technical
 Details for E930 p.10/173
 Worldwide Marks and Approvals of
 MDRCs p.11/96

Frequently asked question - FAQ:

Protection and Safety Technical
 Details for E90 p.10/170

Maybe you are also interested in:

E 9F gG cylindrical fuses pag. 5/55
 E 9F aM cylindrical fuses pag. 5/59

Protection and safety

Cylindrical fuses E 9F gG



E 9F8

Technical features		
Rated voltage	[V]	400, 500, 690 AC
Rated current	[A]	0,5...125
Breaking capacity	[kA]	20, 80, 120
Overall dimensions	[mm]	8.5x31.5 , 10.3x38 , 14x51 , 22x58
Weight	[g]	4, 7, 18, 48
Standards		IEC 60269-2; ROHS 2002/98/CE
Marks		LLOYD, BV

E 9F gG cylindrical fuses

The E 9F gG cylindrical fuses, coupled with E 90 and E 930 fuse disconnectors, are the ideal solution for protection against overload and short-circuit. They feature a fast tripping curve that is ideal for protecting electronic devices, transformers and electric cables. The E 9F gG series is available for all the main sizes (8.5 x 31.5 mm, 10.3 x 38 mm, 14 x 51 mm e 22 x 58 mm) and with a wide range of rated current values (from 1 A to 125 A and up to 690 V a.c.). All the E 9F series fuses conform to the RoHS directive and are type-approved in accordance with the most important international naval marks.

5



E 9F10

E 9F 8 gG cylindrical fuses 8.5 x 31.5 mm

Rated current	Size	Bbn 8012542	Order details		Price 1 piece	Weight 1 piece	Pack unit
In	mm	EAN	Type code	Order code		kg	pc.
1	8.5x31.5	575733	E 9F8 GG1	2CSM257573R1801		0.004	10
2	8.5x31.5	563938	E 9F8 GG2	2CSM256393R1801		0.004	10
4	8.5x31.5	586630	E 9F8 GG4	2CSM258663R1801		0.004	10
6	8.5x31.5	574835	E 9F8 GG6	2CSM257483R1801		0.004	10
8	8.5x31.5	563037	E 9F8 GG8	2CSM256303R1801		0.004	10
10	8.5x31.5	775737	E 9F8 GG10	2CSM277573R1801		0.004	10
12	8.5x31.5	773535	E 9F8 GG12	2CSM277353R1801		0.004	10
16	8.5x31.5	771333	E 9F8 GG16	2CSM277133R1801		0.004	10
20	8.5x31.5	775034	E 9F8 GG20	2CSM277503R1801		0.004	10

E 9F 10 gG cylindrical fuses 10.3 x 38 mm

Rated current	Size	Bbn 8012542	Order details		Price 1 piece	Weight 1 piece	Pack unit
In	mm	EAN	Type code	Order code		kg	pc.
0.5	10.3x38	773337	E 9F10 GG05	2CSM277333R1801		0.007	10
1	10.3x38	771135	E 9F10 GG1	2CSM277113R1801		0.007	10
2	10.3x38	587231	E 9F10 GG2	2CSM258723R1801		0.007	10
4	10.3x38	575436	E 9F10 GG4	2CSM257543R1801		0.007	10
6	10.3x38	563631	E 9F10 GG6	2CSM256363R1801		0.007	10
8	10.3x38	586333	E 9F10 GG8	2CSM258633R1801		0.007	10
10	10.3x38	574538	E 9F10 GG10	2CSM257453R1801		0.007	10
12	10.3x38	562733	E 9F10 GG12	2CSM256273R1801		0.007	10
16	10.3x38	775430	E 9F10 GG16	2CSM277543R1801		0.007	10
20	10.3x38	773230	E 9F10 GG20	2CSM277323R1801		0.007	10
25	10.3x38	771036	E 9F10 GG25	2CSM277103R1801		0.007	10
32	10.3x38	587132	E 9F10 GG32	2CSM258713R1801		0.007	10

Where to find more:
Worldwide Marks and Approvals of MDRCs p.11/96

Frequently asked question - FAQ:
Protection and Safety Technical Details for E 9F p.10/175

Maybe you are also interested in:
E 90 Fuse Switch Disconnectors p.5/49
E90h Fuseholders p.5/50
E 930 Fuse Disconnectors p.5/53

Protection and safety

Cylindrical fuses E 9F gG



E 9F14



E 9F22

E 9F 14 gG cylindrical fuses 14 x 51 mm							
Rated current	Size	Bbn 8012542	Order details		Price 1 piece	Weight 1 piece	Pack unit
In	mm	EAN	Type code	Order code		kg	pc.
2	14x51	775232	E 9F14 GG2	2CSM277523R1801		0.018	10
4	14x51	773030	E 9F14 GG4	2CSM277303R1801		0.018	10
6	14x51	770831	E 9F14 GG6	2CSM277083R1801		0.018	10
8	14x51	910039	E 9F14 GG8	2CSM291003R1801		0.018	10
10	14x51	909835	E 9F14 GG10	2CSM290983R1801		0.018	10
12	14x51	909637	E 9F14 GG12	2CSM290963R1801		0.018	10
16	14x51	587835	E 9F14 GG16	2CSM258783R1801		0.018	10
20	14x51	576037	E 9F14 GG20	2CSM257603R1801		0.018	10
25	14x51	564232	E 9F14 GG25	2CSM256423R1801		0.018	10
32	14x51	586937	E 9F14 GG32	2CSM258693R1801		0.018	10
40	14x51	575139	E 9F14 GG40	2CSM257513R1801		0.018	10
50	14x51	563334	E 9F14 GG50	2CSM256333R1801		0.018	10

E 9F 22 gG cylindrical fuses 22 x 58 mm							
Rated current	Size	Bbn 8012542	Order details		Price 1 piece	Weight 1 piece	Pack unit
In	mm	EAN	Type code	Order code		kg	pc.
4	22x58	571834	E 9F22 GG4	2CSM257183R1801		0.048	10
6	22x58	592839	E 9F22 GG6	2CSM259283R1801		0.048	10
8	22x58	581031	E 9F22 GG8	2CSM258103R1801		0.048	10
10	22x58	569237	E 9F22 GG10	2CSM256923R1801		0.048	10
12	22x58	594031	E 9F22 GG12	2CSM259403R1801		0.048	10
16	22x58	582236	E 9F22 GG16	2CSM258223R1801		0.048	10
20	22x58	570431	E 9F22 GG20	2CSM257043R1801		0.048	10
25	22x58	595335	E 9F22 GG25	2CSM259533R1801		0.048	10
32	22x58	583530	E 9F22 GG32	2CSM258353R1801		0.048	10
40	22x58	571735	E 9F22 GG40	2CSM257173R1801		0.048	10
50	22x58	593935	E 9F22 GG50	2CSM259393R1801		0.048	10
63	22x58	582137	E 9F22 GG63	2CSM258213R1801		0.048	10
80	22x58	570332	E 9F22 GG80	2CSM257033R1801		0.048	10
100	22x58	595236	E 9F22 GG100	2CSM259523R1801		0.048	10
125	22x58	583431	E 9F22 GG125	2CSM258343R1801		0.048	10

Where to find more:
Worldwide Marks and Approvals of MDRCs p.11/96

Frequently asked question - FAQ:
Protection and Safety Technical Details for E 9F p.10/175

Maybe you are also interested in:
E 90 Fuse Switch Disconnectors p.5/49
E90h Fuseholders p.5/50
E 930 Fuse Disconnectors p.5/53

E 9F 8 gG cylindrical fuses 8.5 x 31.5 mm

Type	Rated current [A]	Rated voltage [V AC]	Breaking capacity [kA]
E 9F8 GG1	1	400	20
E 9F8 GG2	2	400	20
E 9F8 GG4	4	400	20
E 9F8 GG6	6	400	20
E 9F8 GG8	8	400	20
E 9F8 GG10	10	400	20
E 9F8 GG12	12	400	20
E 9F8 GG16	16	400	20
E 9F8 GG20	20	400	20

E 9F 10 gG cylindrical fuses 10.3 x 38 mm

Type	Rated current [A]	Rated voltage [V AC]	Breaking capacity [kA]
E 9F10 GG05	0.5	500	120
E 9F10 GG1	1	500	120
E 9F10 GG2	2	500	120
E 9F10 GG4	4	500	120
E 9F10 GG6	6	500	120
E 9F10 GG8	8	500	120
E 9F10 GG10	10	500	120
E 9F10 GG12	12	500	120
E 9F10 GG16	16	500	120
E 9F10 GG20	20	500	120
E 9F10 GG25	25	500	120
E 9F10 GG32	32	400	120

E 9F 14 gG cylindrical fuses 14 x 51 mm

Type	Rated current [A]	Rated voltage [V AC]	Breaking capacity [kA]
E 9F14 GG2	2	690	80
E 9F14 GG4	4	690	80
E 9F14 GG6	6	690	80
E 9F14 GG8	8	690	80
E 9F14 GG10	10	690	80
E 9F14 GG12	12	690	80
E 9F14 GG16	16	690	80
E 9F14 GG20	20	690	80
E 9F14 GG25	25	690	80
E 9F14 GG32	32	500	120
E 9F14 GG40	40	500	120
E 9F14 GG50	50	400	120

Protection and safety

Cylindrical fuses E 9F gG

E 9F 22 gG cylindrical fuses 22 x 58 mm			
Type	Rated current [A]	Rated voltage [V AC]	Breaking capacity [kA]
E 9F22 GG4	4	690	80
E 9F22 GG6	6	690	80
E 9F22 GG8	8	690	80
E 9F22 GG10	10	690	80
E 9F22 GG12	12	690	80
E 9F22 GG16	16	690	80
E 9F22 GG20	20	690	80
E 9F22 GG25	25	690	80
E 9F22 GG32	32	690	80
E 9F22 GG40	40	690	80
E 9F22 GG50	50	690	80
E 9F22 GG63	63	690	80
E 9F22 GG80	80	690	80
E 9F22 GG100	100	500	120
E 9F22 GG125	125	400	120

Where to find more:
Worldwide Marks and Approvals of
MDRCs p.11/96

Frequently asked question - FAQ:
Protection and Safety Technical
Details for E 9F p.10/175

Maybe you are also interested in:
E 90 Fuse Switch Disconnectors
p.5/49
E90h Fuseholders p.5/50
E 930 Fuse Disconnectors p.5/53

Protection and safety

Cylindrical fuses E 9F aM



E 9F aM

Technical features		
Rated voltage	[V]	400, 500, 690 AC
Rated current	[A]	0,5...125
Breaking capacity	[kA]	20, 80, 120
Overall dimensions	[mm]	8.5x31.5, 10.3x38, 14x51, 22x58
Weight	[g]	4, 7, 18, 48
Standards		IEC 60269-2; ROHS 2002/98/CE
Marks		LLOYD, BV

E 9F8 aM cylindrical fuses 8.5 x 31.5 mm

Type	Rated current [A]	Rated voltage [V AC]	Breaking capacity [kA]
E 9F1 AM1	1	400	20
E 9F8 AM2	2	400	20
E 9F8 AM4	4	400	20
E 9F8 AM6	6	400	20
E 9F8 AM8	8	400	20
E 9F8 AM10	10	400	20

5

E 9F10 aM cylindrical fuses 10.3 x 38 mm

Type	Rated current [A]	Rated voltage [V AC]	Breaking capacity [kA]
E 9F10 AM05	0.5	500	120
E 9F10 AM1	1	500	120
E 9F10 AM2	2	500	120
E 9F10 AM4	4	500	120
E 9F10 AM6	6	500	120
E 9F10 AM8	8	500	120
E 9F10 AM10	10	500	120
E 9F10 AM12	12	500	120
E 9F10 AM16	16	500	120
E 9F10 AM20	20	500	120
E 9F10 AM25	25	400	120
E 9F10 AM32	32	400	120

Protection and safety

Cylindrical fuses E 9F aM

E 9F14 aM cylindrical fuses 14 x 51 mm			
Type	Rated current [A]	Rated voltage [V AC]	Breaking capacity [kA]
E 9F14 AM1	1	690	80
E 9F14 AM2	2	690	80
E 9F14 AM4	4	690	80
E 9F14 AM6	6	690	80
E 9F14 AM8	8	690	80
E 9F14 AM10	10	690	80
E 9F14 AM12	12	690	80
E 9F14 AM16	16	690	80
E 9F14 AM20	20	690	80
E 9F14 AM25	25	690	80
E 9F14 AM32	32	500	120
E 9F14 AM40	40	500	120
E 9F14 AM45	45	500	120
E 9F14 AM50	50	400	120

E 9F22 aM cylindrical fuses 22 x 58 mm			
Type	Rated current [A]	Rated voltage [V AC]	Breaking capacity [kA]
E 9F22 AM6	6	690	80
E 9F22 AM8	8	690	80
E 9F22 AM10	10	690	80
E 9F22 AM12	12	690	80
E 9F22 AM16	16	690	80
E 9F22 AM20	20	690	80
E 9F22 AM25	25	690	80
E 9F22 AM32	32	690	80
E 9F22 AM40	40	690	80
E 9F22 AM50	50	690	80
E 9F22 AM63	63	690	80
E 9F22 AM80	80	690	80
E 9F22 AM100	100	500	120
E 9F22 AM125	125	400	120

Where to find more:
Worldwide Marks and Approvals of
MDRCs p.11/96

Frequently asked question - FAQ:
Protection and Safety Technical
Details for E 9F p.10/175

Maybe you are also interested in:
E 90 Fuse Switch Disconnectors
p.5/49
E90h Fuseholders p.5/50
E 930 Fuse Disconnectors p.5/53



E 9F8 aM



E 9F10 aM

E 9F aM cylindrical fuses

The E 9F aM cylindrical fuses, coupled with E 90 and E 930 fuse disconnectors, are the ideal solution for protection against overload and short-circuit. They feature a delayed tripping curve and are therefore ideal for protecting industrial motors that require high inrush current during the starting phase. The E 9F aM series is available for all the main sizes (8.5 x 31.5 mm, 10.3 x 38 mm, 14 x 51 mm e 22 x 58 mm) and with a wide range of rated current values (from 1 A to 125 A and up to 690 V a.c.). All the E 9F series fuses conform to the RoHS directive and are type-approved in accordance with the most important international naval marks.

E 9F 8 aM cylindrical fuses 8.5 x 31.5 mm

Rated current	Size	Bbn 8012542	Order details		Price 1 piece	Weight 1 piece	Pack unit
In	mm	EAN	Type code	Order code		kg	pc.
1	8.5x31.5	772835	E 9F8 AM1	2CSM277283R1801		0.004	10
2	8.5x31.5	770633	E 9F8 AM2	2CSM277063R1801		0.004	10
4	8.5x31.5	587439	E 9F8 AM4	2CSM258743R1801		0.004	10
6	8.5x31.5	575634	E 9F8 AM6	2CSM257563R1801		0.004	10
8	8.5x31.5	563839	E 9F8 AM8	2CSM256383R1801		0.004	10
10	8.5x31.5	586531	E 9F8 AM10	2CSM258653R1801		0.004	10

5

E 9F 10 aM cylindrical fuses 10.3 x 38 mm

Rated current	Size	Bbn 8012542	Order details		Price 1 piece	Weight 1 piece	Pack unit
In	mm	EAN	Type code	Order code		kg	pc.
0.5	10.3x38	574736	E 9F10 AM05	2CSM257473R1801		0.007	10
1	10.3x38	562931	E 9F10 AM1	2CSM256293R1801		0.007	10
2	10.3x38	775638	E 9F10 AM2	2CSM277563R1801		0.007	10
4	10.3x38	773436	E 9F10 AM4	2CSM277343R1801		0.007	10
6	10.3x38	771234	E 9F10 AM6	2CSM277123R1801		0.007	10
8	10.3x38	587330	E 9F10 AM8	2CSM258733R1801		0.007	10
10	10.3x38	575535	E 9F10 AM10	2CSM257553R1801		0.007	10
12	10.3x38	563730	E 9F10 AM12	2CSM256373R1801		0.007	10
16	10.3x38	586432	E 9F10 AM16	2CSM258643R1801		0.007	10
20	10.3x38	574637	E 9F10 AM20	2CSM257463R1801		0.007	10
25	10.3x38	562832	E 9F10 AM25	2CSM256283R1801		0.007	10
32	10.3x38	775539	E 9F10 AM32	2CSM277553R1801		0.007	10

Protection and safety

Cylindrical fuses E 9F aM



E 9F14 aM



E 9F22 aM

E 9F 14 aM cylindrical fuses 14 x 51 mm							
Rated current	Size	Bbn 8012542	Order details		Price 1 piece	Weight 1 piece	Pack unit
In	mm	EAN	Type code	Order code		kg	pc.
1	14x51	575337	E 9F14 AM1	2CSM257533R1801		0.018	10
2	14x51	563532	E 9F14 AM2	2CSM256353R1801		0.018	10
4	14x51	586234	E 9F14 AM4	2CSM258623R1801		0.018	10
6	14x51	574439	E 9F14 AM6	2CSM257443R1801		0.018	10
8	14x51	562634	E 9F14 AM8	2CSM256263R1801		0.018	10
10	14x51	775331	E 9F14 AM10	2CSM277533R1801		0.018	10
12	14x51	773139	E 9F14 AM12	2CSM277313R1801		0.018	10
16	14x51	770930	E 9F14 AM16	2CSM277093R1801		0.018	10
20	14x51	587033	E 9F14 AM20	2CSM258703R1801		0.018	10
25	14x51	575238	E 9F14 AM25	2CSM257523R1801		0.018	10
32	14x51	563433	E 9F14 AM32	2CSM256343R1801		0.018	10
40	14x51	586135	E 9F14 AM40	2CSM258613R1801		0.018	10
45	14x51	574330	E 9F14 AM45	2CSM257433R1801		0.018	10
50	14x51	562535	E 9F14 AM50	2CSM256253R1801		0.018	10

E 9F 22 aM cylindrical fuses 22 x 58 mm							
Rated current	Size	Bbn 8012542	Order details		Price 1 piece	Weight 1 piece	Pack unit
In	mm	EAN	Type code	Order code		kg	pc.
6	22x58	586036	E 9F22 AM6	2CSM258603R1801		0.048	10
8	22x58	574231	E 9F22 AM8	2CSM257423R1801		0.048	10
10	22x58	562436	E 9F22 AM10	2CSM256243R1801		0.048	10
12	22x58	775133	E 9F22 AM12	2CSM277513R1801		0.048	10
16	22x58	772934	E 9F22 AM16	2CSM277293R1801		0.048	10
20	22x58	770732	E 9F22 AM20	2CSM277073R1801		0.048	10
25	22x58	774938	E 9F22 AM25	2CSM277493R1801		0.048	10
32	22x58	772736	E 9F22 AM32	2CSM277273R1801		0.048	10
40	22x58	770534	E 9F22 AM40	2CSM277053R1801		0.048	10
50	22x58	594130	E 9F22 AM50	2CSM259413R1801		0.048	10
63	22x58	582335	E 9F22 AM63	2CSM258233R1801		0.048	10
80	22x58	570530	E 9F22 AM80	2CSM257053R1801		0.048	10
100	22x58	595434	E 9F22 AM100	2CSM259543R1801		0.048	10
125	22x58	583639	E 9F22 AM125	2CSM258363R1801		0.048	10

Where to find more:
Worldwide Marks and Approvals of MDRCs p.11/96

Frequently asked question - FAQ:
Protection and Safety Technical Details for E 9F p.10/175

Maybe you are also interested in:
E 90 Fuse Switch Disconnectors p.5/49
E90h Fuseholders p.5/50
E 930 Fuse Disconnectors p.5/53

Protection and safety

Cylindrical Fuses E 9F gPV



E 9F PV

Technical features		
Rated voltage	[V]	1000 DC
Rated current	[A]	1...30
Breaking capacity	[kA]	10
Minimum breaking capacity		From 1 A up to 7 A = 1.3 x I _n From 8 A up to 30 A = 2.0 x I _n
Overall dimensions	[mm]	10.3 x 38
Weight	[g]	7
Standards		IEC 60269-6; ROHS 2002/98/CE, UL

E 9F PV cylindrical fuses for photovoltaic applications

The cylindrical fuses E 9F PV series are specifically used in overcurrent protection of photovoltaic applications up to 1000 V in direct current. Thanks to the wide current range from 1 A to 30 A, and to the high nominal voltage of 1000 V DC, the series E 9F PV is ideal to protect strings, inverters and OVR surge protections according to IEC 60269-6 "Supplementary requirements for fuse-links for the protection of solar photovoltaic energy systems".

5

E 9F PV cylindrical fuses 10.3 x 38 mm						
Rated current	Bbn 8012542	Order details		Price 1 piece	Weight 1 piece	Pack unit
I _n	EAN	Type code	Order code		kg	pc.
1 A	134568	E 9F1 PV	2CSM213456R1801		0.007	10
2 A	134667	E 9F2 PV	2CSM213466R1801		0.007	10
3 A	134766	E 9F3 PV	2CSM213476R1801		0.007	10
4 A	134865	E 9F4 PV	2CSM213486R1801		0.007	10
5 A	134964	E 9F5 PV	2CSM213496R1801		0.007	10
6 A	135063	E 9F6 PV	2CSM213506R1801		0.007	10
7 A	135162	E 9F7 PV	2CSM213516R1801		0.007	10
8 A	135261	E 9F8 PV	2CSM213526R1801		0.007	10
10 A	135360	E 9F10 PV	2CSM213536R1801		0.007	10
12 A	135459	E 9F12 PV	2CSM213546R1801		0.007	10
15 A	135558	E 9F15 PV	2CSM213556R1801		0.007	10
20 A	135657	E 9F20 PV	2CSM213566R1801		0.007	10
25 A	135756	E 9F25 PV	2CSM213576R1801		0.007	10
30 A	135855	E 9F30 PV	2CSM213586R1801		0.007	10

Protection and safety

Fuse-switch-disconnectors



ILTS-E1



ILTS-E1



ILTS-E3



ILTS-E/H11



ILTS-E/RE

Technical data	
Standards:	DIN VDE 0638, EN 60947-3, EN 660269-3-1
Approval:	VDE
No. of poles:	1, 2, 3 pole and 3 pole+N
Rated voltage:	400 V AC, per pole 65 V DC (2 pole 130 V DC)
Operating current In:	acc. to fuse link D0 2-63 A
Rated frequency:	50/60 Hz
Rated short circuit capacity:	50 kA for AC (8 kA for DC)
Power loss:	5.5 W/pole
Utilization category:	AC 22 B: 400 V AC 63 A according to IEC / EN 60947-3 (all versions) DC 22 B: 65 V DC 63 A according to IEC / EN 60947-3 (1 pole) DC 22 B: 130 V DC 63 A according to IEC / EN 60947-3 (2 pole)
Leakage current resistance:	CTI 200
Ambient temperature:	- 5 °C up to + 40 °C
Casing material:	thermoplast; halogen-, phosphor-, silicone- and CFC-free
Fire classification:	UL 94 (self-extinguishing)
Shock protection:	according to DIN EN 50 274 (DIN VDE 0660 Part 514) BGV A3
Connection capacity:	1.5 – 35 mm ² finely stranded, directly clamped or with connector sleeve Twin-function terminal for simultaneous connection of two conductors (35 mm ² and 16 mm ²) or conductor and busbar
Pick-up torque:	2,5 – 3 Nm
Auxiliary switch indicating contact position	
Contacts:	1 NO contact + 1 NC contact
Contact rating:	AC 13: 2 A/400 V, 6 A/230 V DC 13: 1 A/220 V, 6 A/24 V

Switch-disconnector ILTS-E for D0 2-63 A fuse links “Drawer technology”

User-friendly fuse-switch-disconnector in “drawer technology”:

- Snap action
- Fuse can be replaced only if the system is de-energized.
- Captive fuse carrier
- For D02 fuse links, D01 fuse link with reducing piece
- Twin box terminal on both sides
- User-friendly installation of cross-wiring in lower terminal
- Auxiliary switch to indicate switching position

Fuse-switch-disconnector						
Poles	Bbn 4016779	Order details		Price 1 piece	Weight 1 piece	Pack unit
	EAN	Type code	Order code		kg	pc.
1	65347 3	ILTS-E1	2CDE 101 001 R1901	13	0.210	3
2	65348 0	ILTS-E2	2CDE 102 001 R1901	13	0.420	2
3	65349 7	ILTS-E3	2CDE 103 001 R1901	13	0.630	1
3+N*	65350 3	ILTS-E3+N	2CDE 103 101 R1901	13	0.790	1
Reducing piece	65407 4	ILTS-E/RE	2CDE 000 011 R1901	13	0.001	20
Auxiliary switch 1NO/1NC	65671 9	LTS-E/H11	2CDE 000 012 R1901	13	0.050	1

* N conductor leading make contact, late closing

Maybe you are also interested in:
Busbars and Accessories for ILTS-E
and ISS p.5/68

Protection and safety

D0 Fuse carrier



ISS 16/1

2CDE 051 109 F0007



ISS 63/1

2CDE 051 110 F0007



ISS 16/3

2CDE 051 111 F0007



ISS 63/3

2CDE 051 112 F0007

Technical features		
Size:	D01	D02
Current type:	AC (50 Hz) / DC	AC (50 Hz) / DC
Rated voltage:	400 V AC / 250 V DC	400 V AC / 250 V DC
Rated current:	16 A	63 A
Rated short-circuit current:	50 kA (AC) 8 kA (DC)	50 kA (AC) 8 kA (DC)
For fuse links with losses per phase up to:	2.5 W	5.5 W

D0 fuse carrier ISS with integrated red cover

D0 fuse base for NEOZED fuse links D01 / D02. Touch-protection according to BGV A3. Twin box terminal on both sides for connection of two different conductor cross-sections or conductors and busbars.

Conductor cross-sections incoming and outgoing 1.5 – 35 mm², stranded. With integrated terminal cover. A separate cover for distribution board installation is not required.

- IEC 60269-3 / VDE 0636-3
- 1/3-pole
- Fuse links, connector sleeves VDE 0636-3
- Snap clip device for rail mounting to EN 60715
- Twin function terminal
- Connection cross-section 1.5 – 35 mm²
- Tightening torque 2.5 – 3 Nm

5

D0 fuse carrier

Poles	Screw cover/ fuse	Bbn 4016779	Order details		Price 1 piece	Weight 1 piece	Pack unit
		EAN	Type code	Order code		kg	pc.
1	E14 D01	65579 8	ISS 16/1	2CDE 101 001 R1902	13	0.08	9
1	E18 D02	65581 1	ISS 63/1	2CDE 161 001 R1902	13	0.08	9
3	E14 D01	65580 4	ISS 16/3	2CDE 113 001 R1902	13	0.24	9
3	E18 D02	65582 8	ISS 63/3	2CDE 163 001 R1902	13	0.24	9

Maybe you are also interested in:
Busbars and Accessories for D0 fuses
p.5/68

Protection and safety

Busbars and accessories for ILTS-E and ISS

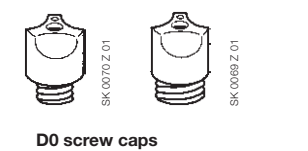
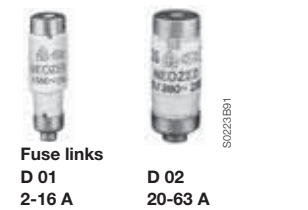
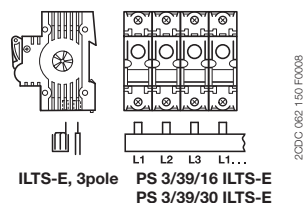
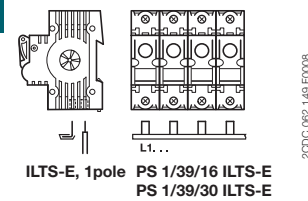
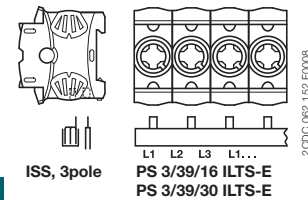
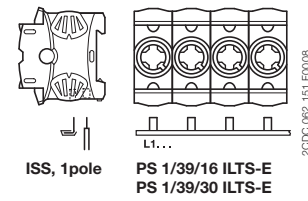

Busbars for fuse-switch-disconnector ILTS-E and fuse carrier ISS: 1 pole or 3pole

End caps:

PS 1/39/16 ILTS-E: END 1.1

PS 1/39/30 ILTS-E: PS-END 3.2

PS 3/39/16 ILTS-E: PS-END

PS 3/39/30 ILTS-E: PS-END 3

Busbars									
Cross-section	Length	No. of poles	Cu factor	Bbn 4012233	Order details		Price 1 piece	Weight 1 piece	Pack unit
mm ²	mm			EAN	Type code	Order code		kg	pc.
16	1040	39 x 1	0.43	66956 6 a	PS 1/39/16 ILTS-E	2CDL 010 101 R1639	15	0.23	10
30	1040	39 x 1	0.74	66957 3 a	PS 1/39/30 ILTS-E*	2CDL 010 101 R3039	15	0.487	5
16	1040	39 x 3	1.3	66958 0 a	PS 3/39/16 ILTS-E	2CDL 030 101 R1639	15	0.59	10
30	1040	39 x 3	1.95	66959 7 a	PS 3/39/30 ILTS-E*	2CDL 030 101 R3039	15	1.222	5

a bbn-Nr. 40 16779 * Not compatible with ISS

End caps									
Cross-section	Length	No. of poles	Cu factor	Bbn 4012233	Order details		Price 1 piece	Weight 1 piece	Pack unit
mm ²	mm			EAN	Type code	Order code		kg	pc.
		1		63891 3	END 1.1	2CDL 200 011 R0011	15	0.001	50
		2/3		51472 9	PS-END	2CDL 200 001 R0001	15	0.001	50
		2/3		65430 2	PS-END 3	2CDL 200 001 R3001	15	0.001	50
		1		66960 3	PS-END 3.2	2CDL 200 001 R3003	15	0.001	50

D0 fuses and accessories

D0 fuse links to DIN VDE 0636-3, IEC/EN 60269-3 suitable for D01/E14									
Rated current	Colour code	Power loss	Bbn 4012233	Order details		Price 1 piece	Weight 1 piece	Pack unit	
A	W		EAN	Type code	Order code		kg	pc.	
2	pink	1.5	60480 7	D01 x 2 gL	GMN 977 120 P0011	13	0.006	10	
4	brown	1.5	60490 6	D01 x 4 gL	GMN 977 120 P0012	13	0.006		
6	green	1.5	60500 2	D01 x 6 gL	GMN 977 120 P0013	13	0.006		
10	red	1.8	60510 1	D01 x 10 gL	GMN 977 120 P0014	13	0.006		
16	grey	2.1	60520 0	D01 x 16 gL	GMN 977 120 P0015	13	0.006		

Suitable for D02/E18									
Rated current	Colour code	Power loss	Bbn 4012233	Order details		Price 1 piece	Weight 1 piece	Pack unit	
A	W		EAN	Type code	Order code		kg	pc.	
20	blue	2.3	60530 9	D02 x 20 gL	GMN 977 120 P0017	13	0.011	10	
25	yellow	2.6	60540 8	D02 x 25 gL	GMN 977 120 P0018	13	0.012		
35	black	2.9	60550 7	D02 x 35 gL	GMN 977 120 P0019	13	0.013		
50	white	3.5	60560 6	D02 x 50 gL	GMN 977 120 P0020	13	0.014		
63	copper	4.2	60570 5	D02 x 63 gL	GMN 977 120 P0021	13	0.015		



Connector sleeves
D 01 D 02
2-10 A 2-50 A



FD 1713

9K019Z 91

D0 screw caps acc. to DIN VDE 0636-3, IEC/EN 60269-3, 400 V AC
Plastic version, RAL 7037

Rated current	Colour code	Power loss	Bbn 4012233	Order details	Price 1 piece	Weight 1 piece	Pack unit
A		W	EAN	Type code	Order code	kg	pc.
16	for D01	–	60790 7	D01 DIN 49 525 K	GMN 977 130 P0011	13	0.015 20
63	for D02	–	60800 3	D02 DIN 49 525 K	GMN 977 130 P0012	13	0.015 20

D0 connector sleeves to DIN VDE 0636-3, IEC/EN 60269-3
Suitable for D01/E14

Rated current	Colour code	Power loss	Bbn 4012233	Order details	Price 1 piece	Weight 1 piece	Pack unit
A		W	EAN	Type code	Order code	kg	pc.
2	pink	–	60600 9	D01 x 2	GMN 977 125 P0001	13	0.001 50
4	brown		60610 8	D01 x 4	GMN 977 125 P0002	13	0.001
6	green		60620 7	D01 x 6	GMN 977 125 P0003	13	0.001
10	red		60630 6	D01 x 10	GMN 977 125 P0004	13	0.001

5

Suitable for D02/E18

Rated current	Colour code	Power loss	Bbn 4012233	Order details	Price 1 piece	Weight 1 piece	Pack unit
A		W	EAN	Type code	Order code	kg	pc.
2	pink	–	60640 5	D02 x 2	GMN 977 125 P0011	13	0.001 50
4	brown		60650 4	D02 x 4	GMN 977 125 P0012	13	0.001
6	green		60660 3	D02 x 6	GMN 977 125 P0013	13	0.001
10	red		60670 2	D02 x 10	GMN 977 125 P0014	13	0.001
16	grey		60680 1	D02 x 16	GMN 977 125 P0015	13	0.001
20	blue		60690 0	D02 x 20	GMN 977 125 P0016	13	0.001
25	yellow		60700 6	D02 x 25	GMN 977 125 P0017	13	0.001
35	black		60710 5	D02 x 35	GMN 977 125 P0018	13	0.001
50	white		60720 4	D02 x 50	GMN 977 125 P0019	13	0.001

Spring clip for use of D01 fuses in D02 screw caps

Rated current	Colour code	Power loss	Bbn 4012233	Order details	Price 1 piece	Weight 1 piece	Pack unit
A		W	EAN	Type code	Order code	kg	pc.
			15120 7	FD 1713	GMN 977 130 P0004	13	0.001 50

Protection and safety

Electronic Protection Devices for use behind 24 V DC Switch Mode Power Supplies



Operating data													
Operating voltage UB:	24 V DC (18...32 V)												
Current rating IN:	fixed current ratings: 0.5, 1, 2, 3, 4, 6, 8, 10, 12 A												
Closed current IO:	ON condition: typically 20...30 mA depending on signal output												
Status indication by means of:	<table border="1"> <tr> <td>multi-colour LED:</td> <td>Green:</td> <td>- unit is ON (S1 = ON) - load circuit / Power-is switched on MOSFET</td> </tr> <tr> <td></td> <td>Orange:</td> <td>- in the event of overload or short circuit until electronic disconnection</td> </tr> <tr> <td></td> <td>Red:</td> <td>- unit electronically disconnected - load circuit/Power-MOSFET OFF - undervoltage (UB < 8 V) - after switch-on till the end of the delay period</td> </tr> <tr> <td></td> <td>OFF:</td> <td>- manually switched off (S1 = OFF) or device is dead</td> </tr> </table>	multi-colour LED:	Green:	- unit is ON (S1 = ON) - load circuit / Power-is switched on MOSFET		Orange:	- in the event of overload or short circuit until electronic disconnection		Red:	- unit electronically disconnected - load circuit/Power-MOSFET OFF - undervoltage (UB < 8 V) - after switch-on till the end of the delay period		OFF:	- manually switched off (S1 = OFF) or device is dead
multi-colour LED:	Green:	- unit is ON (S1 = ON) - load circuit / Power-is switched on MOSFET											
	Orange:	- in the event of overload or short circuit until electronic disconnection											
	Red:	- unit electronically disconnected - load circuit/Power-MOSFET OFF - undervoltage (UB < 8 V) - after switch-on till the end of the delay period											
	OFF:	- manually switched off (S1 = OFF) or device is dead											
	potential-free auxiliary contact F												
	ON/OFF/ condition of switch S1												

Load circuit	
Load output	Power-MOSFET switching output (high side switch)
Overload disconnection	typically 1.1 x IN (1.05...1.35 x IN)
Short-circuit current IK	active current limitation (see table 1)
Trip time	see time/current characteristics
For electronic disconnection	typically 3 s at ILoad > 1.1 x IN typically 100 ms...3 s at ILoad > 1.8 x IN (or 1.5 x IN/1.3 x IN,)
Temperature disconnection	internal temperature monitoring with electronic disconnection
Low voltage monitoring load output	with hysteresis, no reset required: load »OFF« at UB < 8 V
Starting delay tStart	typically 0.5 sec after every switch-on and after applying US
Disconnection of load circuit	electronic disconnection
Free-wheeling circuit	suitable external free-wheeling circuit to be used with inductive load
Several load outputs must not be connected in parallel	

Signal output F	
Electrical data	potential-free auxiliary contact max. 30 V DC/0.5 A, min. 10 V DC/10 mA
ON condition LED green	voltage UB applied, switch S1 is in ON position no overload, no short circuit
OFF condition LED off	device switched off (switch S1 is in OFF position) no voltage UB applied
Fault condition LED orange	overload condition > 1.1 x IN up to electronic disconnection
Aux. contact	single signal, make contact contact open, terminal 13-14
Fault	signal output fault conditions - no operating voltage UB - ON/OFF switch S1 is in OFF position - red LED lighted (electronic disconnection)

General data	
Fail-Safe element	backup fuse for EPD24 not required because of the integral redundant fail-safe element
Housing material	moulded
Mounting	symmetrical rail to EN 50022-35x7.5
Ambient temperature	0...+50 °C (without condensation, see EN 60204-1)
Storage temperature	-20...+70 °C
Humidity	96 hrs/95 % RH/40 °C to IEC 60068-2-78, test Cab. climate class 3K3 to EN 60721
Vibration	3 g, test to IEC 60068-2-6 test Fc
Degree of protection	housing: IP20 DIN 40050 terminals: IP20 DIN 40050
EMC (EMC directive, CE logo)	emission: EN 61000-6-3 susceptibility: EN 61000-6-2
Isolations coordination (IEC 60934)	0.5 kV/pollution degree 2 reinforced insulation in operating area
Dielectric strength	max. 32 V DC (load circuit)
Isolation resistance (OFF condition)	n/a, only electronic disconnection
Approvals/Declarations of conformity	UL 2367 Solid State Overcurrent Protectors UL 1604, (class I, division 2, groups A, B, C, D) UL 508 CSA C22.2 No. 213 (class I, division 2) CSA C22.2 No. 142 CSA C22.2 No. 14 CE logo
Dimensions (B x H x T)	12.5 x 80 x 83 mm
Weight	approx. 65 g

5

Terminals Line+/LOAD+/0V

Screw terminals	M4
Max. cable cross section flexible with wire end ferrule w/wo plastic sleeve	0.5 – 10 mm ²
Multi-lead connection (2 identical cables) rigid/flexible	0.5 – 4 mm ²
Flexible with wire end ferrule without plastic sleeve	0.5 – 2.5 mm ²
Flexible with TWIN wire end ferrule with plastic sleeve	0.5 – 6 mm ²
Wire stripping length	10 mm
Tightening torque (EN 60934)	1.5 – 1.8 Nm

Terminals aux. contacts

Screw terminals	M3
Max. cable cross section flexible with wire end ferrule w/wo plastic sleeve	0.25 - 2.5 mm ²
Wire stripping length	8 mm
Tightening torque (EN 60934)	0.5 Nm

Protection and safety

Electronic Protection Devices for use behind 24 V DC Switch Mode Power Supplies



The protection devices EPD24 extend the ABB product range of modular DIN rail components by electronic overcurrent protection modules for selective protection of 24V DC load circuits. This protection is achieved by a combination of active electronic current limitation in the case of a short circuit and an overload deactivation from 1.1 x I_n upwards. If a fault occurs in a load circuit, the protection device EPD24 will detect this rapidly and reliably, disable the power output transistor and hence interrupt the current flow in the defective circuit. The maximum possible overcurrent is always limited to 1.5...1.8 times the selected rated current. An activation of capacitive loads up to 20,000 µF is possible, deactivation only occurring in the case of overloads or short circuits. Selective deactivation of the defective current circuit means undefined error states and a complete system stop are prevented.

Features

- Selective load protection, one electronic trip characteristics.
- Active current limitation for safe connection of capacitive loads up to 20,000 µF and on overload/short circuit.
- Current ratings 0.5 A...12 A.
- Reliable overload disconnection with 1.1 x I_N
- Manual ON/OFF button
- Clear status and failure indication through LED and auxiliary contact.
- Integral fail-safe element adjusted to current rating.
- Width per unit only 12.5 mm.
- Rail mounting
- Ease of wiring through busbar LINE+ and 0 V as well as signal bars.
- UL- and CSA-approvals allow international use of the devices.

Rated current I _n	Bbn 4016779	Order details		Price 1 piece	Weight 1 piece	Pack unit
A	EAN	Type code	Order code		kg	pc.
0.5	829960	EPD24-TB-101-0.5A	2CDE 601 101 R2905		0.065	4
1	829984	EPD24-TB-101-1A	2CDE 601 101 R2001		0.065	4
2	830003	EPD24-TB-101-2A	2CDE 601 101 R2002		0.065	4
3	830027	EPD24-TB-101-3A	2CDE 601 101 R2003		0.065	4
4	830041	EPD24-TB-101-4A	2CDE 601 101 R2004		0.065	4
6	830065	EPD24-TB-101-6A	2CDE 601 101 R2006		0.065	4
8	830089	EPD24-TB-101-8A	2CDE 601 101 R2008		0.065	4
10	830102	EPD24-TB-101-10A	2CDE 601 101 R2010		0.065	4
12	830126	EPD24-TB-101-12A	2CDE 601 101 R2012		0.065	4

Accessories

	Bbn 4016779	Order details		Price 1 piece	Weight 1 piece	Pack unit
	EAN	Type code	Order code		kg	pc.
Busbars for LINE+ and 0 V, grey insulation, length 500 mm 1)	830140	EPD-BB500	2CDE 605 100 R0500		0.20	10
Signal Bars for aux. contacts, grey insulation, length 21 mm	830164	EPD-SB21	2CDE 605 200 R0021		0.04	10

1) Max. load with one line entry I_{max} = 50 A (recommended: center-feeding)
Max. load with two line entries I_{max} = 63 A

Protection and safety

SQZ3 phase and sequence relay



SQZ3

Technical features		
Supply voltage	[Vn]	400 V a.c.
Frequency	[Hz]	50/60
Contact type	[A]	1 CO, 250 V, 10 A (cosφ=1) safety switching
Minimum voltage adjustment trimmer	[%]	100 to 70% of Vn
Intervention delay adjustment trimmer	[s]	2 to 20 (only for min. voltage)
Protection degree	[IP]	20
Operating temperature	[°C]	-10...+55
Power consumption	[W]	1.5
Modules	[No.]	3

SQZ3 phase and sequence relay

SQZ3 relay performs the following continue monitoring functions on three-phase networks at 400 V a.c.:

- phase sequence
- phase failure
- minimum voltage (adjustable up to 70% of Vn).

If one of the three failures is detected, the output relay (safety switching contact) intervenes with a

delay adjustable from 2 to 20 seconds for minimum voltage only and controls the following:

- acoustic alarms
- motor controlling contactors
- circuit-breakers with coils.

5

Bbn	Order details		Price	Weight	Pack
8012542	Type code	Order code	1 piece	1 piece	unit
EAN			kg	pc.	
372004	SQZ3	2CSM111310R1331		0.300	1

Protection and safety

RH/RL maximum and minimum current/voltage relays



RH/RL

Technical characteristics		
Rated voltage Un	[V]	a.c. 230
Contact type		1 CO, 250 V, 16 A
Rated frequency	[Hz]	50/60
Current relay alarm thresholds	[A]	2, 5, 10
Voltage relay alarm thresholds	[V]	100, 300, 500
Adj. calibration of In and Vn%	[%]	30..100
Adjustable hysteresis value	[%]	1..45
Time delay	[s]	1..30
Power consumption	[W]	2
Modules	[No.]	3
Control relay alarm indication		red LED on = alarm
Power supply lighting indication		green LED on = ON
Alarm indication		blinking green LED = alarm

Maximum and minimum current/voltage relays

These relays are used for monitoring current and voltage on single-phase electrical networks, to ensure perfect protection of the devices installed on the system.

The range includes:

- maximum current (RHI) and maximum voltage (RHV) relays. The control relay remains on as long as the measured quantity stays below the preset threshold value.
- minimum current (RLI) and minimum voltage (RLV) relays. The control relay remains on as long as the measured quantity stays above a preset threshold value.

Both types of relays have trimmers for adjusting the switch-off delay and the hysteresis (from 1 to 45%).

The 100 V and 5 A relay inputs allow indirect connection of external CTs and VTs for monitoring voltage and current values exceeding the maximum device scale

Type	Bbn	Order details		Price	Weight	Pack
	8012542	Type code	Order code	1 piece	1 piece	unit
	EAN				kg	pc.
maximum current relay	334309	RHI	2CSM121310R1321		0.300	1
maximum voltage relay	334101	RHV	2CSM111310R1321		0.300	1
minimum current relay	334200	RLI	2CSM122310R1321		0.300	1
minimum voltage relay	334002	RLV	2CSM112310R1321		0.300	1

Where to find more:

Technical Details for RH/RL p.10/189

Frequently asked question - FAQ:

Can I use RH/RL with current/voltage transformers?

Yes, 5A and 100V inputs are made for that.

Protection and safety

E 236 undervoltage monitoring relays



E 236-US 1



E 236-US 2

Technical features		US 1	US 2
Rated voltage		250 V a.c.	
Frequency		48-63 Hz	
Measuring range:	supply voltage	3N 400/230 V a.c. (terminals N-L1-L2-L3)	
	overload capacity	3N 459/265 V a.c.	
Switching capacity		device in series (distance < 5 mm): 750 VA (3 A/250 V a.c.); device not in series (distance > 5 mm): 1250 VA (5 A/250 V a.c.)	
Rated insulation voltage		250 V a.c. (corresponds with IEC 664-1)	
Rated surge voltage		4 kV	
Tripping delay		ca. 100 ms	
Clearance and creepage distance		> 6 mm (between contact and electronics)	
Mechanical service life		20 x 10 ⁶ operations	
Electrical service life at 10000 VA		2 x 10 ⁵ operations	
Max. switching rate		max. 6/min (1000 VA Ohmic load); max. 60/min (100 VA Ohmic load)	
Ambient temperature		-25 °C/-13 °F to +55 °C/131 °F	
Overvoltage category		III	
Accuracy in non-changing environment:	setting tolerance (US 2)	≤ 5 %	
	repeat accuracy	±1 %	
environment:	temperature effect	≤ 0.1 %/°C	
Terminals		up to 4 mm ²	
Specifications		VDE 0110 and VDE 0435	
EMC tests		EM 50081-1 and EN 50082-2	
Displays		LED green= supply voltage applied; LED yellow= relay status	
Power loss		1.7 W	

5

E 236 undervoltage monitoring relays

Function

The green LED is lit when the supply voltage is applied. If each phase voltage exceeds 195 V (US1) or exceeds the preset threshold value (US2) with respect to the neutral including the hysteresis when switching the device on, the relay switches immediately into the working position. The yellow LED is lit. If at least one phase voltage falls below the threshold value, the relay goes back into its normal position and the yellow LED goes out.

If also phase 2 fails, the green LED goes out, too.

It is indispensable to connect the neutral conductor!

Application - devices with 2CO contacts

For the control of three-phase undervoltage (each phase to neutral) of switchgear, also for installations according to DIN VDE 0100-718 (power installations in hospitals and rooms used for medical purposes outside of hospitals) and DIN VDE 0108-100 (power installations and safety supply in buildings where many people gather).

US 1: 3 phases to neutral with fixed threshold at 195 V; hysteresis fixed 5 %

US 2: 3 phases to neutral with fixed threshold at 160 – 240 V; hysteresis fixed 5 %

Contact	Bbn 4016779	Order details		Price 1 piece	Weight 1 piece	Pack unit
	EAN	Type code	Order code		kg	pc.
2CO	511087	E 236-US 1	2CDE165000R2001		0.095	5
2CO	511094	E 236-US 2	2CDE165010R2001		0.095	5

Where to find more:

Technical Details for E236 p.10/190

Protection and safety

E 236 undervoltage monitoring relays



E 236

5

Technical features		US 1.1	US 2.1	US 1.1D
Supply circuit				
Supply voltage (= measured voltage):		3N- 400/230 V AC (terminals N-C1-C2-C3)		
Overvoltage permanent:		3N- 459/265 V AC		
Frequency:		48 – 63 Hz (AC sinus)		
Rated surge voltage:		4 kV		
Overvoltage category:		III		
Output circuit (isolated two-way-switch)				
Rated voltage:		250 V AC		
Switching capacity:		1250 VA (5 A/250 V AC)		
Continuous current:		1250 VA (5 A/250 V AC)		
Fuse protection:		5 A flink		
Serviceable life, mechanical:		15x10 ⁶ switchover cycles		
Serviceable life, electric:		2x10 ⁵ switchover cycles at 1,000 VA resistive load		
Max. switching rate:		max. 6/min at 1,000 VA resistive load max. 60/min at 100 VA resistive load		
Trip delay:		ca. 200 ms		
Pick-up delay (US 1.1D)		0.1 – 10 min		
Accuracy under constant conditions		≤ 5 % of full scale value		
– setting accuracy (US 2.1/1.1D):		≤ 2 %		
– repeat accuracy:		≤ 1 %		
– temperature effect:		– 25° to + 55 °C		
Ambient temperature:		– 25° to + 55 °C		
Terminals:		1 x 0.5 to 2.5 mm ² with/without connector sleeve 1 x 4 mm ² without connector sleeve 2 x 0.5 to 1.5 mm ² with/without connector sleeve 2 x 2.5 mm ² without connector sleeve		
Pick-up torque:		max. 1 Nm		
Mounting position:		optional		
Vibration resistance:		10 to 55 Hz 0.35 mm (IEC 68-2-6)		
Shock resistance:		15 g 11 ms (IEC 68-2-27)		
Standards:		VDE 0110 und VDE 0435		
EMC tests:		EN 61000-6-2 and EN 61000-6-4		
Back-up fuse		≤ 16 A		
Displays:	green LED U/t ON	all 3 voltages ok		
	green LED U/t flashes	time-out indication		
	yellow LED ON/OFF	position of output relay		

All measured inputs have to be connected to one phase each. If no three-phase measurement should be carried out, measured inputs have to be connected to one phase to apply the required voltage to all measured inputs. If a load causes inverse voltage exceeding the threshold value U_s , phase failures cannot be identified.

A neutral conductor must be connected in any case!

Where to find more:

Technical Details for E236 p.10/190



E 236-US 1.1



E 236-US 2.1



E 236-US 1.1D

Devices for panel installation onto mounting rails (35 mm) according to DIN EN 60715
 mounting depth: 68 mm
 mounting width: 17.5 mm = 1 module
 color: gray, RAL 7035

Application - devices with 1CO contact

For three-phase undervoltage monitoring (each phase connected to a neutral conductor) of switchgear. Devices with fixed threshold value (US 1.x and US 1.1 D) also for installations according to DIN VDE 0100-718 (for medical purposes) and DIN VDE 0108-100 (power installations and safety supply in installations for gathering of people).

US 1.1: 3 phases to neutral conductor with fixed threshold value at 195 V; hysteresis fixed at 5 %

US 2.1: 3 phases to neutral conductor with threshold value range of 160 – 240 V; hysteresis fixed at 5 %

US 1.1D: 3 phases to neutral conductor with fixed threshold value at 195 V; hysteresis fixed at 5 %, but with switch-on delay of 0.1 (6 sec.) to 10 min

5

Undervoltage monitoring device with pick-up delay E 236-US 1.1D

If the measurement of the voltage of all phases connected exceeds the switching threshold U_s , including the hysteresis, the time delay (t) starts to run and the (green LED U/t) flashes. Upon expiry of the time delay (t), the output relay R picks up (yellow LED on, green LED U/t flashes). If the measured voltage of one of the connected phases falls below the switching threshold U_s , the output relay de-energizes (yellow LED is off, green LED U/t is off).

Contact	Bbn	Order details		Price	Weight	Pack
	4016779	Type code	Order code	1 piece	1 piece	unit
	EAN				kg	pc.
1 two-way switch	651776	E 236-US 1.1	2CDE165001R2001		0.05	10
1 two-way switch	651783	E 236-US 2.1	2CDE165011R2001		0.05	10
1 two-way switch	651790	E 236-US 1.1D	2CDE165001R2011		0.05	10

H+ Line. Operational continuity

A wide range which ensure safety and reliability in hospital segment

S200 residual miniature circuit-breakers

S700 E miniature circuit-breakers

OVR surge protection device

Lifting eyebolts

ISOLTESTER-DIG-RZ insulation monitoring device

M1175-FL schuko socket outlet

Cable container

TI-S insulating transformers



5



5

Specifically designed and assembled for medical use according to the IEC EN 61558-2-15, it ensures protection against indirect contacts without the need to interrupt the circuit automatically upon the first grounding fault.

Thanks to its two PT100 temperature probes, on primary and secondary winding, it is possible to monitor the transformer over temperature produced by any eventual overload, and therefore anticipating any breakdown.

The transformer is mounted on the base of the switchboard in order to ease handling and installation operations.

Artu K series floor standing switchboards are equipped with a cable container that makes installation and wiring easier, both for the electrical systems distributed along the false ceiling, as under the floor.

It is possible to reach any terminal block in a comfortable way. Finally, there is a copper equipotential bonding busbar which may lodge up to 20 additional connections, providing grounding connections to all the external masses which are present in the medical premises, and avoiding the creation of further cascade sub-nodes that are not allowed.



This is an insulation monitoring device for group 2 medical locations fully compliant with the IEC 60364-7-710 reference standard. It integrates all the performances established by the reference standard, such as overload and overcurrent monitoring, together with traditional IT system earthing insulation measurement.

Floor standing QSO switchboards are composed of modular ArTu K series enclosures. The switchboards are equipped with venting grooves that guarantee proper natural convection, useful to dissipate the heat produced by the transformer during its normal functioning.

Protection and safety H+Line products

Solutions for the hospital sector

ABB's extensive experience in the hospital field is certified by several installations in leading hospitals, which represent the current leading-edge in safety and technology. Over the years, ABB has developed an increasingly more complete product with higher performance to meet the needs of more demanding customers and guarantee patient and operator safety.

H+Line products are specifically designed for group 2 medical environments in full compliance with Standard IEC 60364-7-710, specifically:

- Intensive therapy wards, operating theatres, cardio surgical rooms, ICU...
- Day hospitals, clinics, rest homes, dental and veterinary clinics, etc.



- H like Hospital
- + like health and first aid
- + like the countless advantages of ABB products

H+Line product range

ISOLTESTER		Insulation monitoring device for IT-M 230 V circuits
SELVTESTER		Insulation monitoring device for SELV 24 V circuits which supply scialitic lamps.
QSD		Remote signalling panel for visual and acoustic fault indication.
TI		Medical insulating transformers for insulated protection systems.
QSO		Wall mounting and floor standing switchboards for medical locations.

5

Valid assistance for consultants

Everyone knows what the regulations say. ABB tells you what they don't say. The "Practical guide to group 2 medical locations" is designed to be a useful daily tool for consultants and installers to help them in each group 2 hospital electrical system designing and installation. The document was developed together with ABB customers with the intent to support key regulatory questions with practical solutions, considerations and recommendations on system design. This way, the "Practical guide to group 2 medical locations" is a valid tool, with plenty of examples, to support consultants in their daily job.

Protection and safety

ISOLTESTER-DIG insulation monitoring devices



ISOLTESTER-DIG

2CSC4002D0211

Technical features	ISOLTESTER-DIG-RZ	ISOLTESTER-DIGPLUS
Aux supply	115 - 230 V 50-60Hz	
Power consumption	5 VA max	6 VA max
Rated voltage	24±230V 50-60Hz	24±250V ac/dc
Measurement current	1 mA max	
Measurement voltage	24 V max	
Control signal	Continuous with digital filter	Composite codified
Internal impedance	200 kΩ	
Insulation measurement	0 ÷ 999 kΩ resolution 1 kΩ accuracy 5% ± 1 digit	
Impedance measurement	0 ÷ 999 kΩ resolution 1 kΩ	
Temperature measurement	PT100 with 2 or 3 wires, PTC 0÷200 °C, resolution 1 °C, accuracy 2 % ± 1 digit	
Current measurement	TA .../5 A external accuracy 5% ± 1 digit, (adjustable transformation rate 1÷40)	
Capacity measurement	no	0 ÷ 9,9 μF resolution 0,1 μF
Thresholds	Resistance: 50 ÷ 500 kΩ Impedance: 50 ÷ 500 kΩ Thermal overload: 30 ±200 °C with PT100 Electrical overload: 1 ÷ 99,9 A	
Signals	incorrect wiring (link fail) open/short circuit for temp sensor PT100 internal error	
Output	QSD supply (max 2 QSD), max 24Vdc Signals to QSD aux relay for low resistance, NO-C-NC 5A 250Vac	QSD supply (max 4 QSD), max 24Vdc programmable aux relay, NO-C-NC 5A 250Vac
		Serial output RS485, ModbusRTU protocol,
Modules	6	
Weight	0,4 kg	0,5 kg
Mechanical features	fire resistant plastic case sealable transparent front cover	
Terminals	screw terminals 2,5 mm ²	
IP degree	IP20, IP50 when the cover is closed	
Operating temperature	-10 ÷ 60 °C	
Storage temperature	-25 ÷ 70 °C, humidity < 95%	
Insulation	2,5 kV 60 sec.	
Directives	CEI-EN 61010-1 CEI-EN 61557-8 IEC 60364-7-710 UNE 20615 CEI-EN 61326-1	

Where to find more:

Functioning of the Frontal Operator of ISOLTESTER p.10/193
H+Line Practical guide (code 2CSC470010B0202)



Frequently asked question - FAQ:

A complete list of answers is available in the „Questions&Answer“ section of the H+Line brochure (code 2CSC004033B0202)



You can find all ABB instruction manuals on www.abb.com/abblibrary/ download center



ISOLTESTER-DIG

2CSC4000R1501

Assuring operational continuity in medical environments, even in presence of first earthing fault, it's mandatory in operating theatre group 2 medical locations.

For this reason an IT distribution system with insulating transformer is used to supply medical equipment.

ISOLTESTER-DIG

ISOLTESTER range of insulation monitoring device allows IT-M network monitoring, assuring safety for patients and medical personnel avoiding supply interruption in case of first earthing fault according to IEC 60364-7-710 Standard.

The ISOLTESTER-DIG range assures safety to patients and medical personnel, signalling when a fault to earth occurs. Thanks to its innovative technology it is used to sense the insulation level of the network by far more efficiently compared to traditional insulation monitoring devices.

5

H+Line

Advanced features	Bbn	Order details		Price	Weight	Pack
	8012542	Type code	Order code	1 piece	1 piece	unit
	EAN				kg	pc.
	884507	ISOLTESTER-DIG-RZ	2CSM244000R1501		0.500	1
RS485, Max-Min values, Programmable relay, Noise immunization (with codified signal)	884606	ISOLTESTER-DIG-PLUS	2CSM341000R1501		0.500	1

Protection and safety

SELVTESTER insulation monitoring devices for insulated networks at 24 V a.c/d.c.



SELVTESTER

Technical features	
Network voltage and auxiliary power supply	24 V 50-60 Hz/d.c. ± 20%
Max power dissipation	3 VA – 3 W
Max measuring current	max. 0,5 mA
Internal impedance	50 kohm
Activation threshold setting	programmable to 10 ÷ 50 kohm (4 levels using microswitches)
Activation delay	about 1 second
Signals	led ON, led ALARM +, led ALARM -
Output	for up to 2 QSD-230/24-C, max. 24 V 1 A remote panels
Operating / storage temperature	-10 ÷ 60 °C / -20 ÷ 70 °C
Relative humidity	≤ 95%
Insulation test	2,5 kV 60 sec. / 4 kV imp. 1,2/50µs
Terminal cross section	4 mm ²
Front degree of protection	IP40 with cover / IP20 container
Modules	3
Weight	200 g
Reference standards for safety	IEC 60364-7-710, EN 61326-1, EN 61010-1

SELVTESTER for insulated networks at 24 V a.c/d.c.

It is used to monitor permanently the insulation of safety extremely low voltage circuits (up to 24 V) especially scialitic lamps.

Function	Bbn 8012542	Order details		Price 1 piece	Weight 1 piece	Pack unit
	EAN	Type code	Order code		kg	pc.
Insulation monitoring	884705	SELVTESTER-24	2CSM211000R1511		0.250	1

Where to find more:

H+Line Practical guide (code 2CSC470010B0202)



Frequently asked question - FAQ:

A complete list of answers is available in the „Questions&Answer“ section of the H+Line brochure (code 2CSC004033B0202)



You can find all ABB instruction manuals on www.abb.com/abblibrary/ download center

Protection and safety

QSD remote signalling panel



QSD

2CSC40093F0001

H+Line

Technical features	
Signals	Green LED network ON Red LED overload ALARM Yellow LED insulation ALARM intermittence 2 Hz dB ALARM, acoustic signaller, emission 2400 Hz
Buttons	TEST and MUTE buttons
Terminal cross section	2,5 mm ²
Degree of protection	IP30
Installation	universal flush-mounted box
Weight	200 g
Operating temperature	-10 ÷ 60 °C, max. humidity 95%
Storage temperature	-25 ÷ +80 °C
Insulation	2500 Vrms 50 Hz 60 s
Cables section	0,35 mm ² for 300 m
Compatibility	ISOLTESTER-C, ISOLTESTER-RZ, ISOLTESTER-DIG-RZ, ISOLTESTER-DIG, PLUS, SELVTESTER-C, SELVTESTER-24
Reference standards	safety EN 61010-1 product EN 61557-8 / IEC 60364-7-710 / UNE 20615 electromagnetic compatibility EN 61326-1

5

QSD remote signalling panel

They are installed in combination with insulation monitoring devices, to remotely report the signalling generated by these devices. They can be installed together with ISOLTESTER-DIG and SELVTESTER-24 and they are compatible also with former versions of insulating monitoring devices. Flush mounting box already included in the packaging.

Version	Bbn	Order details		Price 1 piece	Weight 1 piece	Pack unit
	8012542	Type code	Order code			
	EAN				kg	pc.
Horizontal	730637	QSD-DIG 230/24	2CSM273063R1521		0.800	1
Vertical	570936	QSD-DIG 230/24 V	2CSM257093R1521		0.800	1

Protection and safety

TI switchboards and devices for medical locations



TI

Technical characteristics					
		TI 3 TI 3-S	TI 5 TI 5-S	TI 7.5 TI 7.5-S	TI 10 TI 10-S
Rated output	[KVA]	3	5	7.5	10
Frequency	[Hz]	50-60			
Power dissipation	[W]	120	150	260	320
Electrical protection class		1			
Thermal insulation class	[°C]	B 130	B 130	F 155	F 155
Operating temperature max	[°C]	40			
Primary winding voltage	[V]	230			
Secondary winding voltage	[V]	230			
No load current	[A]	< 0.39	< 0.65	< 0.98	< 1.3
Short circuit voltage drop		<3%			
Inrush current	[A]	< 221	< 369	< 553	< 738
Power loss	[W]	120	150	260	320
Winding separation		double insulation			
Metallic shield		■			
Reference standard		IEC-EN 61558-1, IEC-EN 61558-2-15, IEC-EN 62041			
Dimensions	[mm]	205x340x150	240x380x150	240x380x160	277x380x260

Insulating transformers for medical locations

Permanently connected to an IT power supply system, single-phase medical insulating transformers provide galvanic separation between the distribution network and the user load in accordance with IEC EN 61558-2-15 concerning power supply group 2 medical locations.

Rated output	PT100	Bbn 801254	Order details		Price 1 piece	Weight 1 piece	Pack unit
kVA		EAN	Type code	Order code		kg	pc.
3		2896005	TI 3	2CSM110000R1541		29.5	1
5		2896104	TI 5	2CSM120000R1541		44.0	1
7.5		2896203	TI 7.5	2CSM130000R1541		50.5	1
10		2521204	TI 10	2CSM140000R1541		73.0	1
3	■	2521402	TI 3-S	2CSM210000R1541		29.5	1
5	■	2521501	TI 5-S	2CSM220000R1541		44.0	1
7.5	■	2521600	TI 7.5-S	2CSM230000R1541		50.5	1
10	■	2521709	TI 10-S	2CSM240000R1541		73.0	1

Accessories

	Bbn 8012542	Order details		Price 1 piece	Weight 1 piece	Pack unit
	EAN	Type code	Order code		kg	pc.
Shock absorber	2557920	AMM	2CSM900000R1541		1	4

Where to find more:

Wiring and Serial Number Location of TI p.10/196
H+Line Practical guide (code 2CSC470010B0202)



Frequently asked question - FAQ:

A complete list of answers is available in the „Questions&Answer“ section of the H+Line brochure (code 2CSC004033B0202)



You can find all ABB instruction manuals on www.abb.com/abblibrary/ download center

Protection and safety

QSO selection table

Series	Type	Power [kVA]	Installation	IT-M lines	TN-S line sect.	PT100	OVR	Unifix L	I/O KNX	SELV 24 V line
S 	QSO 3S Classic	3	wall	2x10A+3x16A	-	■				
	QSO 5S Classic	5	wall	2x10A+3x16A	-	■				
	QSO 3S Premium	3	wall	2x10A+5x16A	1x10A 0.03A+2x 16A 0.03A	■				
	QSO 5S Premium	5	wall	2x10A+5x16A	1x10A 0.03A+2x 16A 0.03A	■				
M 	QSO 3M Classic	3	floor	3x10A+7x16A	1x16A 0.03A	■				
	QSO 5M Classic	5	floor	3x10A+7x16A	1x16A 0.03A	■				
	QSO 7,5M Classic	7.5	floor	3x10A+7x16A	1x16A 0.03A	■				
	QSO 3M Premium	3	floor	6x10A+8x16A	1x10A 0.03A+2x 16A 0.03A	■	■			■
	QSO 5M Premium	5	floor	6x10A+8x16A	1x10A 0.03A+2x 16A 0.03A	■	■			■
	QSO 7,5M Premium	7.5	floor	6x10A+8x16A	1x10A 0.03A+2x 16A 0.03A	■	■			■
L 	QSO 10L Classic	10	floor	6x10A+9x16A	1x10A 0.03A+2x 16A 0.03A	■				
	QSO 7,5L Premium	7.5	floor	6x10A+11x 16A+1x32A	1x10A 0.03A+2x 16A 0.03A	■	■			■
	QSO 10L Premium	10	floor	6x10A+11x 16A+1x32A	1x10A 0.03A+2x 16A 0.03A	■	■		■	■
XL 	QSO 7,5XL Premium	7.5+7.5	floor	12x10A+22x 16A+2x32A	2x10A 0.03A+4x 16A 0.03A	■	■	■	■	■
	QSO 10XL Premium	10+10	floor	12x10A+22x 16A+2x32A	2x10A 0.03A+4x 16A 0.03A	■	■	■	■	■

5

Protection and safety

QSO switchboards and components for medical locations



QSO

Technical features	QSO wall type	QSO floor type
Rated operational voltage (U _e)	230 V ~ ± 15%	
Rated power frequency	50 - 60 Hz	
Number of phases	1 + N ~/PE	
Rated voltage of auxiliary service circuits	24 - 230 V ~	
Rated insulation voltage (U _i)	300 V - *2500 V	
Earthing system	TT / TN-S	
Maximum prospective short circuit current to the input terminals (I _{cc})	10 kA RMS Sym ***	
Max. altitude	2000 m s.l.m.	
Pollution degree	1 **	
Degree of protection against impacts (IK code) EN 50102 I	K 09 (5 kg - 200 mm)	
Degree of relative humidity at temperature °C	50% with max. temp. +40 °C	
Ambient air temperature - operation	-5 °C - +55 °C	
Ambient air temperature - transport and storage	-25 °C - +40 °C	
Degree of protection EN 60529	QSO 3S Classic IP 40	QSO 3M Classic IP 54
	QSO 5S Classic IP 40	QSO 5M Classic IP 54
	QSO 3S Premium IP 40	QSO 5M Premium IP 54
	QSO 5S Premium IP 40	QSO 7.5M Premium IP 54
		QSO 10L Classic IP 54
		QSO 7.5L Premium IP 54
		QSO 10L Premium IP 54
		QSO 7.5XL Premium IP 54
		QSO 10XL Premium IP 54

* Dielectric strength test voltage.

** Corresponds to no pollution or only dry and non-conductive pollution.

*** Value conditioned by upstream coordination with NH 00 100A gL-gG fuses

Where to find more:

H+Line Practical guide (code 2CSC470010B0202)



Frequently asked question - FAQ:

A complete list of answers is available in the „Questions&Answer“ section of the H+Line brochure (code 2CSC004033B0202)



You can find all ABB instruction manuals on www.abb.com/abblibrary/ download center



QSO S



QSO M



QSO L



QSO XL

H+Line

Electrical switchboard for medical locations

QSO switchboards for operating theatres represent the ideal solution for distribution within group 2 medical locations, in compliance with the requirements of IEC standard 64-8/7-710. Four sizes are available: S, M, L, and XL. Each one of these can be customized with two layouts. The CLASSIC version contains the instrumentation essential for protection against direct contacts, while the PREMIUM version also has, depending on the type of switchboard, additional devices intended for:

- emergency power cut-off of operating theatre circuits outside of the patient area (lighting, radiology sockets, etc.)
- 24 V SELV line for supplying scalytic lamps
- overvoltage protection
- Unifix L fast-wiring system
- I/O module for managing xon alarms through KNX protocol

5

XL QSOs are equipped with two isolation transformers to ensure dual redundant power supply of the IT-M circuits. ABB provides, for its switchboards for operating theatres, the declaration of conformity required to commission the system, ensuring the installer that the system is built in compliance with technical standards. To ensure the best efficiency of the QSO will be delivered in a new wooden packing.

S series switchboards for medical locations

Applications: surgery clinics, post-op recovery rooms, analysis laboratories, dental offices, veterinary clinics

Power kVA	Installation	TN-S section feeder lines	IT-M section feeder lines	Bbn 801254 EAN	Order details Type code	Order code	Price 1 piece	Weight 1 piece kg	Pack unit pc.
3	wall-mounted		2x10A +5x16A +1x25A	2611226	QSO 3S Classic	2CSM261122R1551		113	1
5	wall-mounted		2x10A +5x16A +1x25A	2736929	QSO 5S Classic	2CSM273692R1551		128	1
3	wall-mounted	1x10A +2x16A	2x10A +1x25A +5x16A	2736028	QSO 3S Premium	2CSM273602R1551		150	1
5	wall-mounted	1x10A +2x16A	2x10A +1x25A +5x16A	2736820	QSO 5S Premium	2CSM273682R1551		130	1

M series switchboards for medical locations

Applications: Day hospital rooms, medium sized operating theatres, ICU rooms

Power kVA	Installation	TN-S section feeder lines	IT-M section feeder lines	Bbn 801254 EAN	Order details Type code	Order code	Price 1 piece	Weight 1 piece kg	Pack unit pc.
3	floor standing	1x10A	3x10A +7x16A	2735922	QSO 3M Classic	2CSM273592R1551		180	1
5	floor standing	1x10A	3x10A +7x16A	2736721	QSO 5M Classic	2CSM273672R1551		195	1
7.5	floor standing	1x10A	3x10A +7x16A	2735823	QSO 7,5M Classic	2CSM273582R1551		202	1
3	floor standing	1x10A +2x16A	6x10A +8x16A +1x25A	2736622	QSO 3M Premium	2CSM273662R1551		181	1
5	floor standing	1x10A +2x16A	6x10A +8x16A +1x25A	2735724	QSO 5M Premium	2CSM273572R1551		196	1
7.5	floor standing	1x10A +2x16A	6x10A +8x16A +1x25A	2736523	QSO 7,5M Premium	2CSM273652R1551		202	1

Protection and safety

QSO switchboards and components for medical locations

L series switchboards for medical locations
Applications: operating theatres, intensive care rooms, cardiac operating rooms

Power	Installation	TN-S section feeder lines	IT-M section feeder lines	Bbn 801254	Order details		Price 1 piece	Weight 1 piece	Pack unit
kVA				EAN	Type code	Order code		kg	pc.
10	floor standing	1X10A +2x16A	6x10A +9x16A	2735625	QSO 10L Classic	2CSM273562R1551		244	1
7.5	floor standing	1X10A +2x16A	1x32A +2x25A +6x10A +11x16A	2736424	QSO 7,5L Premium	2CSM273642R1551		222	1
10	floor standing	1X10A +2x16A	1x32A +2x25A +6x10A +11x16A	2735526	QSO 10L Premium	2CSM273552R1551		248	1

XL series switchboards for medical locations
Applications: resuscitation, intensive care, long term care

Power	Installation	TN-S section feeder lines	IT-M section feeder lines	Bbn 801254	Order details		Price 1 piece	Weight 1 piece	Pack unit
kVA				EAN	Type code	Order code		kg	pc.
7.5+7.5	floor standing	2X10A +4x16A	2x32A +4x25A +12x10A +22x16A	2736325	QSO 7,5XL Premium	2CSM273632R1551		379	1
10+10	floor standing	2X10A +4x16A	2x32A +4x25A +12x10A +22x16A	2735427	QSO 10XL Premium	2CSM273542R1551		429	1

Where to find more:

H+Line Practical guide (code 2CSC470010B0202)



Frequently asked question - FAQ:

A complete list of answers is available in the „Questions&Answer“ section of the H+Line brochure (code 2CSC004033B0202)



You can find all ABB instruction manuals on www.abb.com/abblibrary/download-center

Protection and safety

ISOLTESTER MRM operating theatre monitoring



MRM BOX



MRM CPU

CP415M technical features	
Display size	3.5"
Resolution (Pixels)	240 x 240
Brightness (cd/m2)	90
Contrast adjustment	Through touch panel
Backlight	LED
Backlight life	40.000 hours
Touch screen (number of operations)	> 1 million
Flash PROM	4 MB
RTC	yes
Alarm management	yes
Communication interface	1
Consumption	> 330 mA
Dimensions WxHxD (mm)	96 x 96 x 40.6
Weight (kg)	0.23

5

PM554-T technical features	
Onboard I/O DI/ DO/AI/AO	8 / 6 / - / -
Digital Onboard	Input signal 24 V c.c.
I/O	Output signal Transistor, 24 V d.c., 0.5 A
Power supply	24 V d.c.

H+Line

Operating theatre monitoring

Thanks to ISOLTESTER MRM, real-time monitoring, from one or two stations, of the electrical parameters and the alarm signals from multiple operating theatres is now possible. ISOLTESTER MRM BOX is composed of a CP415 3.5" touch-screen terminal that shows the status of all medical locations; the CPU eCo PM554-T series equipped with TA 562-RS board which, through the Modbus RTU protocol, allows for the acquisition of measurements and alarms coming from each ISOLTESTER-DIG-PLUS, each one responsible for monitoring a group 2 room. Using the ISOLTESTER MRM CPU you can install an additional monitoring station to the system created with ISOLTESTER MRM BOX.

Products from the ISOLTESTER MRM series come with H+Line software which is preloaded in the factory. In this way the user simply has to set the number of rooms to supervise, thus no programming of the devices is required.

Where to find more:

H+Line Practical guide (code 2CSC470010B0202)



Frequently asked question - FAQ:

A complete list of answers is available in the „Questions&Answer“ section of the H+Line brochure (code 2CSC004033B0202)



You can find all ABB instruction manuals on www.abb.com/abblibrary/download-center

	Bbn 801254	Order details		Price 1 piece	Weight 1 piece	Pack unit
	EAN	Type code	Order code		kg	pc.
PLC 8 IN and 6 OUT Touch display 3.5'	2736127	ISOLTESTER MRM BOX	2CSM273612R1521		2.0	1
CP415M H+Line sw						
Touch display 3,5' CP415M H+Line sw	2735229	ISOLTESTER MRM CPU	2CSM273522R1521		1.7	1

Protection and safety

QIT Switchboards for data center protection and supply



2CSC400100100004

QIT

Technical features	
Power	16 kVA
Primary voltage	400 V S+N
Frequency	50/60 Hz
Secondary voltage	400 V S+N
Ambient air temperature- operation	-5 °C - +55 °C
Ambient air temperature- transport and storage	-25 °C - +40 °C
Rated insulation voltage (UI)	300 V - 2500 V
Rated voltage of auxiliary service circuits	24 - 230 V ~
Maximum prospective short-circuit current to the input terminals (Icc)	10 kA RMS Sym*
Degree of protection	IP54
Reference standards	IEC 61439-2

* Value conditioned by upstream coordination with NH 00 100A gL-gG fuses

H+Line

The new QIT switchboard was created by ABB based on the decades of experience gained in critical applications like medical rooms. It is the ideal solution for data center, server farm, and data warehouse protection and power supply. This application requires maximum service continuity, which can only be ensured through an isolated neutral IT system for normal operation, even in the presence of a first earth fault.

Furthermore, QIT also includes the latest and most advanced ABB instrumentation to ensure maximum speed and efficiency when analyzing a fault and, when necessary, maintenance of the components. QIT switchboards are basalt grey RAL 7012, thus completely colour-coordinated with the ABB industrial product range.

16 kVA Isolation transformer

The three-phase plus neutral 16 kVA isolation transformer has been designed and manufactured in accordance with IEC EN 61558-2-2 and IEC EN 61558-2-4. It ensures protection against indirect contacts, and does not require automatic switch off of the circuit at first earth fault.

Thanks to the PT100 temperature sensor on three-windings, it is possible to monitor overtemperature on the transformer generated by possible overloads and therefore prevent unwanted tripping of the main switch.

The transformer is installed on the base of the panel in order to facilitate switchboard handling and installation operations.

Power	Bbn 8012542	Order details		Price 1 piece	Weight 1 piece	Pack unit
kVA	EAN	Type code	Order code		kg	pc.
16	2735328	QIT 16L Premium	2CSM273532R1551		342	1

Where to find more:

H+Line Practical guide (code 2CSC470010B0202)



Frequently asked question - FAQ:

A complete list of answers is available in the „Questions&Answer“ section of the H+Line brochure (code 2CSC004033B0202)



You can find all ABB instruction manuals on www.abb.com/abblibrary/ download center

Protection and safety

ISL industrial insulation monitoring devices



ISL

2CSC400700201

		Technical features ISL-A		
		ISL-A		
		A 24-48	A 115 and A 230	A 600
Power consumption	[VA]	3	4	6
ALARM threshold	[kW]	30 - 300 (5 levels, selectable)		
TRIP threshold	[kW]	10 - 60 (5 levels by switches)	10 - 100 (5 levels selectable)	30 - 300 (adjustable by potentiometer)
LED indications	ON	■	■	■
	TRIP	■	■	■
	ALARM	■	■	■
	+/-	■	■	■
Max trip delay	[s]	0.2	2	2.5
Max measuring signal current	[mA]	0.5	1.8	1.5
Internal impedance	[kW]	50	ISL-A 115: 200 kΩ L+/L- 100 kΩ L/PE ISL-A 230: 400 kΩ L+/L- 200 kΩ L/PE	880 kW L+/L - 450 kW L/PE
TRIP relay output		1 NO-C-NC	2 NO-C-NC	1 NO-C-NC
ALARM relay output		2 NO-C-NC		
Relay contact capacity		max 250 V, 5 A		
Programmed functions	Alarm output	■		
	Fail safe	■		
	Reset	■		
Insulation		2.5 kV60 sec. / 6 kV imp 1.2/50 μs	2.5 kV 60 sec. / 4 kV imp 1.2/50 μs	2.5 kV 60 sec. / 6 kV imp 1.2/50 μs
Operating temperature	[°C]	-10 ÷ 60		
Storage temperature	[°C]	-20 ÷ 70		
Relative humidity		≤ 90%		
Max terminal section	[mm ²]	4	2.5	2.5
Protection degree		IP40 front, IP20 enclosure		
Modules		3	6	6
Weight	[g]	200	400	400
Reference standards		EN 61010-1, EN 61557-8, EN 61326-1		

5

Where to find more:

H-Line Practical guide (code 2CSC470010B0202)



Frequently asked question - FAQ:

A complete list of answers is available in the „Questions&Answer“ section of the H-Line brochure (code 2CSC004033B0202)



You can find all ABB instruction manuals on www.abb.com/abblibrary/download-center

Protection and safety

ISL industrial insulation monitoring devices



ISL-A

Technical features ISL-C and ISL-MOT

		ISL-C			ISL-MOT
		C 230	C 440	C 600	MOT 1000
Auxiliary power supply	[V]	220-240 V a.c.	220-240 V a.c.	100÷130 V a.c./ 220÷240 V a.c.	220- 240 V a.c.
Power consumption	[VA]	3	3	5	3
TRIP threshold	[kΩ]	100	10 -150 (5 levels)	10-100 (5 levels)	0.1-10 MΩ (8 levels)
LED indications	ON	■	■	■	■
	TRIP	■	■	■	■
	ALARM			■	
Max trip delay	[s]	1	4	5	0.2
Max measuring current	[mA]	0.1		0.25	0.0015
Max measuring voltage	[V]	12 V d.c.		48	20
Internal impedance	[kW]	250	250	200	a.c.: 1000 d.c.: 1500
TRIP relay output		1 NO-C-NC	1 NO-C-NC	2 NO-C-NC	1 NO-C-NC
Relay contact capacity		max 250 V, 5 A			
Insulation test		2.5 kV60 sec. / 4 kV imp 1.2/50 μs			
Operating temperature	[°C]	-10 ÷ 60			
Storage temperature	[°C]	-20 ÷ 70			
Relative humidity		≤ 95%			
Max terminal section	[mm²]	4	4	2.5	4
Protection degree		IP40 front, IP20 enclosure			
Modules		3	3	6	3
Weight	[g]	200	200	500	200
Reference standards		EN 61010-1, EN 61557-8, EN 61326-1			

Insulation monitoring devices for voltageless network

Monitored line voltage	Bbn	Order details		Price	Weight	Pack
	8012542	Type code	Order code	1 piece	1 piece	unit
	EAN				kg	pc.
20-700 V a.c./d.c.	943204	ISL-MOT 1000	2CSM808000R1500		0.300	1

Where to find more:

H+Line Practical guide (code 2CSC470010B0202)



Frequently asked question - FAQ:

A complete list of answers is available in the „Questions&Answer“ section of the H+Line brochure (code 2CSC004033B0202)



You can find all ABB instruction manuals on www.abb.com/abblibrary/ download center



ISL-A

2CSC400704F0201



ISL-C

2CSC400704F0201

Insulation monitoring devices

In IT electrical distribution networks with isolated neutral, the high insulation impedance prevents earth faults from generating currents that would dangerously elevate the potential of exposed conductive parts. Therefore, in case of earth leakage in an IT network it is not necessary to interrupt the supply, but it is still essential to continually monitor the insulation level in order to detect faults and restore optimal functioning of the system.

In industrial installations, IT networks are used when operational continuity is an intrinsic requirement of the production process, due to both technical and economic considerations. Such applications include: metalworking and chemical industries, explosion risk locations, railway lines and vehicles, uninterruptible power supplies, cinema sets, emergency lines, fire water pumps and emergency lighting.

5

Insulation monitoring devices for a.c. networks

Max. monitored line voltage	Bbn	Order details		Price 1 piece	Weight 1 piece	Pack unit
	8012542	Type code	Order code			
	EAN				kg	pc.
220-240 V a.c.	942801	ISL-C 230	2CSM444000R1500		0.300	1
380-415 V a.c.	942900	ISL-C 440	2CSM545000R1500		0.300	1
60-760 V a.c.	943006	ISL-C 600	2CSM656000R1500		0.500	1

Insulation monitoring devices for d.c. networks

Max. monitored line voltage	Bbn	Order details		Price 1 piece	Weight 1 piece	Pack unit
	8012542	Type code	Order code			
	EAN				kg	pc.
100-144 V d.c.	942603	ISL-A 115	2CSM222000R1500		0.500	1
220 V d.c.	942702	ISL-A 230	2CSM333000R1500		0.500	1
400-600 V d.c.	498537	ISL-A 600	2CSM249853R1500		0.500	1

Insulation monitoring devices for a.c./d.c. networks

Monitored line voltage	Bbn	Order details		Price 1 piece	Weight 1 piece	Pack unit
	8012542	Type code	Order code			
	EAN				kg	pc.
24-28 V a.c./d.c.	942504	ISL-A 24-48	2CSM111000R1500		0.300	1

System pro M compact®

Command and signalling

Index

SD 200 switch disconnectors	6/7
SHD 200 switch disconnectors	6/10
E 200 switches	6/13
E 463/3, E 480/3 switches	6/16
S800PV-M photovoltaic switch disconnectors	6/17
E 210 switches, pushbuttons and indicator lights	6/22
SL luminous indicators for panel installation	6/29
ESB installation contactors	6/33
EN series contactors	6/36
ESB/EN installation contactors main accessories	6/38
E 250, E 259 selection table	6/39
E 259 installation relays	6/41
E 250 latching relays	6/45
FLR latching relays	6/52
E 260 latching relays	6/54
STD50 dimmers	6/55
Transformers selection table	6/58
Control, isolating and safety transformers selection table	6/60
TM-C, TM-S, TM-I control, isolating and safety transformers	6/62
TS-C safety isolating transformers for general use	6/64
TM bell transformers	6/65
TS bell transformers	6/66
SM, RM, TSM, TSR bells and buzzers	6/67
CP-D primary switch mode power supplies	6/70
Modular sockets selection table	6/71
Modular sockets	6/74
MA1-8001 DIN rail adapter	6/78

The details make the difference

Switch disconnecter SD 200

Easy product coding
– easy identification:
basic technical
information already
integrated into the
name

New, patented twin
terminals with captive
screws: highest
comfort, safety and
flexibility

Fully compatible with all
System pro M devices
and accessories

Laser printing: scratch
and solvent resistant
marking

Real contact position
indication, directly
connected to the
moving contact, for
more comfort and
safety

New, patented housing
design: environmental
friendly and
performance-optimized





Contact position indication

The switch disconnecter SD 200 is suited with a real contact position indication (real CPI). You can easily identify, if the SD 200 is in the ON or the OFF position – easy and safe maintenance work is possible. The position of the toggle and the red/green display leaves no doubt about the present switching position, while the latter offers additional security, as the exact position of the inner contacts is always displayed. Thus, the device always supplies reliable information in the event of an error.



Wide range of accessories

SD 200 is fully compatible to the complete range of System pro *M* compact accessories like

- Auxiliary contacts, to be mounted on the left side, the right side or bottom fitting
- Shunt trips
- Undervoltage release
- Motor operating devices



PATENTED – Housing Design

By using state-of-the-art housing material, ABB is taking care of the environment. With the latest generation of halogen free thermoplastics for SD 200 it's possible to recycle the switch disconnectors completely without environmental pollution. The new material also improves the stability.

6



Laser printing

All labels on the SD 200, as the approvals on the dome, technical details and the product identification, are printed by a laser. The laser printing ensures a friction, scratch and solvent resistant marking on the switch disconnectors for easy identification in case of maintenance or replacements. For control and acceptance procedure it is important to see all markings also in the mounted position.



Highest performance

With a rated voltage of 253/440 V AC, a rated conditional short-circuit current of 25 kA, terminals with protection from misconnection, a "Real CPI" switching position display, as well as full compatibility with all MCB accessories, the SD 200 is unique in its field of application. SD 200 comply with IEC/EN 60947-3.



PATENTED – IP 20 finger safe terminals

The SD 200 are equipped with 35 mm² and 10 mm² cylinder lift twin terminals for challenging industrial use. Cross wiring can easily be realized by inserting the busbars into the rear terminal part and the incoming wires into the front part.

Command and signalling

SD 200 and SHD 200 switch disconnecter ranges



Series		SD 200	SHD 200	E 200
Standards and approvals		IEC/EN 60947-3 VDE	IEC/EN 60947-3 VDE	IEC/EN 60947-3 VDE/CCC/KEMA
Rated currents	16...63 80...125	[A] 16/25/32/40/50/63 –	16/25/32/40/50/63 –	16/25/32/40/45/63 80/100/125
Rated voltage	[V AC]	253/440	240/415	230/400
Short circuit withstand capacity	[kA]	25	10	25
Utilization category		AC-23A	AC-22A	AC-22A
Electrical lifetime	[Ops.]	$I_b < 32$ A: 20,000 (AC) $I_b \geq 32$ A: 10,000 (AC)	$I_b < 32$ A: 20,000 (AC) $I_b \geq 32$ A: 10,000 (AC)	$I_b < 100$ A: 1,500 (AC) $I_b \geq 125$ A: 1,000 (AC)
Terminal cross section	[mm ²]	35	25	50
Terminal		Cylinder lift terminal	Cage terminal	Cage terminal
Two terminal openings for conductor and busbar		Yes	No	No
Safety wire guard		Yes	No	No
Contact position indication		Marking on toggle (I ON/O OFF) Real CPI (red ON/green OFF)	Marking on toggle (I ON/O OFF)	Marking on toggle (I ON/O OFF)
Combination with auxiliary elements				
Auxiliary contacts		Right side Left side Bottom side	No	Right side
Shunt trip		Yes	No	No
Undervoltage release		Yes	No	No
Motor operated remote control		Yes	No	No
Padlock		Yes	Yes	Yes
Removal without disassembling of the busbar		Yes	No	Yes

6

Command and signalling

Switch disconnectors selection table

The SD 200 and SHD 200 extend the proven System pro M compact® series by new ranges of switch disconnectors which provides state-of-the-art safety and comfort. Both are available with 1 to 4 poles with rated currents from 16 to 63 A and provides disconnection properties according to IEC/EN 60947-3.

The SD 200 offers performance on a new level. With a rated voltage of 253/440 V AC, a rated conditional short-circuit current of 25 kA, terminals with protection from misconnection and a "Real CPI" contact position indication the range is unique in its field of application. In addition SD 200 is fully compatible with all MCB accessories.

The SHD 200 has a rated voltage of 240/415 V AC. A rated conditional short-circuit current of 10 kA enables a wide range of applications.

The laser printing and the design of the devices allow a consistent optical appearance in the distribution board.

For technical differences between the ranges please refer to the selection table on the next page.

SD 200 and SHD 200 are the new range of Switch Disconnectors, replacing up to 63 A present range of E 200. Since CCC and KEMA approvals are on going for the new range in the moment in which this catalogue was on printing, in case you need Switch Disconnectors with these approvals please refer to E 200 range.

6

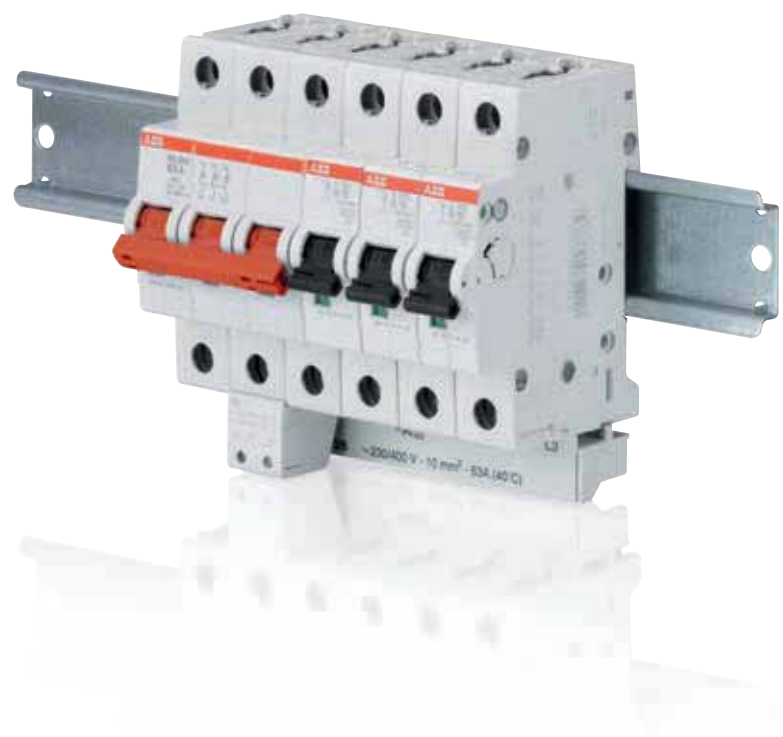

Command and signalling SD 200 switch disconnecter



SD 201

6

Electrical data	
Standards	IEC/EN 60947-3
Poles	1P, 2P, 3P, 4P
Rated current I _n	16 A, 25 A, 32 A, 40 A, 50 A, 63 A
Utilization category	AC-23A, DC-21A
Rated voltage U _e	1P: 253 V AC, 60 V DC 2P: 440 V AC, 125 V DC 3...4P: 440 V AC
Insulation voltage U _i	440 V AC
Max. power frequency recovery voltage U _{max}	1P: 266 V AC, 63 V DC 2P: 462 V AC, 131 V DC 3...4P: 462 V AC
Min. operating voltage U _{min}	12 V AC
Rated frequency f	50/60 Hz, DC
Suitable for isolation	Yes
Rated conditional short-circuit current	25 kA in series with NH 00 ≤ 63 A gG
Overvoltage category	III
Pollution degree	3
Rated impulse withstand voltage U _{imp} (1.2/50 μs)	4 kV (test voltage 6.2 kV at sea level; 5 kV at 2,000 m)
Dielectric test voltage	2 kV (50/60 Hz, 1 min.)
Mechanical data	
Housing	Insulation group I, RAL 7035
Toggle	Insulation group II, red, sealable
Contact position indication	Marking on toggle, I ON / 0 OFF Real CPI (green OFF/red ON)
Protection degree acc. to EN 60529	IP20 / IP40 in enclosure with cover
Electrical endurance	I _n < 32 A: 20,000 ops. (AC), 1,500 ops. (DC) I _n ≥ 32 A: 10,000 ops. (AC), 1,500 ops. (DC)
Mechanical endurance	20,000 ops.
Shock resistance acc. to IEC/EN 60068-2-27	25g, 2 shocks, 13 ms
Vibration resistance acc. to IEC/EN 60068-2-6	5g, 20 cycles at 5...150...5 Hz with load 0.8 I
Environmental conditions (damp heat cyclic) acc. to IEC/EN 60068-2-30	28 cycles with 55 °C/90-96% and 25 °C/95-100% [°C/RH]
Ambient temperature	-25 ... +55 °C
Storage temperature	-40 ... +70 °C
Installation	
Terminal	Cylinder lift terminal
Safety wire guard	Yes
Two terminal openings for conductor and busbar	Yes
Cross-section of conductors	35 mm ²
Cross-section of busbars	10 mm ²
Torque	2.8 Nm
Screwdriver	No. 2 Pozidriv
Mounting	On DIN rail 35 mm acc. to EN 60715 by fast clip
Mounting position	Optional
Removal without disassembling of the busbar	Yes
Supply	Optional
Dimensions and weight	
Mounting dimensions acc. to DIN 43880	Mounting dimension 1
Pole dimensions (H x D x W)	88 x 69 x 17.5 mm
Pole weight	Approx. 85 g
Combination with auxiliary elements	
Auxiliary contact	Yes
Signal/auxiliary contact	Yes
Shunt trip	Yes
Undervoltage release	Yes
Motor operating device	Yes
Padlock	Yes
Approvals	
	CE and RoHS-conform
	Approvals: VDE

Where to find more:

Worldwide Marks and Approvals of MDRs p.11/96

Maybe you are also interested in:

Accessories for SD200 §4/7



SD 201



SD 202



SD 203



SD 204

SD 200

Switch disconnector acc. to IEC/EN 60947-3 for panel installation onto DIN rail (35 mm)

Mounting depth: 68 mm

Mounting width: per pole = 17.5 mm = 1 module

Colour: grey, RAL 7035

Colour of switch lever: red RAL 3000

Special features

- Isolating characteristics acc. to IEC/EN 60947-3
- Clear contact position indication in red/green ("Real CPI")
- Highest performance at an increased voltage level: 25 kA conditional short-circuit current at $U_e = 253/440$ V AC acc. to IEC/EN 60947-3
- Protection degree IP20 = finger safe
- 35 mm² cylinder lift terminal with 2 terminal openings for two wires or one wire and one busbar for cross wiring
- Bottom fixed auxiliary contact as accessory for a space saving installation or upgrade of existing assemblies without additional mounting width
- Consistent design to other System pro *M* DIN rail products
- Cross wiring with MCBs or RCDs using busbars PS
- Durable device identification due to laser labeling
- Captive screws
- Compatibility with all MCB accessories
- Approved acc. to IEC/EN 60947-3 for international use

6

Ordering details

Rated current: 16 A

Poles	Rated voltage	Bbn 4016779	Order details		Price 1 piece	Weight 1 piece	Pack unit
	V AC	EAN	Type code	Order code		kg	pc.
1	253	904063	SD201/16	2CDD281101R0016		0.085	10
2	440	904124	SD202/16	2CDD282101R0016		0.170	5
3	440	904186	SD203/16	2CDD283101R0016		0.255	1
4	440	904247	SD204/16	2CDD284101R0016		0.340	1

Rated current: 25 A

Poles	Rated voltage	Bbn 4016779	Order details		Price 1 piece	Weight 1 piece	Pack unit
	V AC	EAN	Type code	Order code		kg	pc.
1	253	904070	SD201/25	2CDD281101R0025		0.085	10
2	440	904131	SD202/25	2CDD282101R0025		0.170	5
3	440	904193	SD203/25	2CDD283101R0025		0.255	1
4	440	904254	SD204/25	2CDD284101R0025		0.340	1

Rated current: 32 A

Poles	Rated voltage	Bbn 4016779	Order details		Price 1 piece	Weight 1 piece	Pack unit
	V AC	EAN	Type code	Order code		kg	pc.
1	253	904087	SD201/32	2CDD281101R0032		0.085	10
2	440	904148	SD202/32	2CDD282101R0032		0.170	5
3	440	904209	SD203/32	2CDD283101R0032		0.255	1
4	440	904261	SD204/32	2CDD284101R0032		0.340	1



2CDD05100180013

SD 201

Ordering details

Rated current: 40 A

Poles	Rated voltage	Bbn 4016779	Order details		Price 1 piece	Weight 1 piece	Pack unit
	V AC	EAN	Type code	Order code			
1	253	904094	SD201/40	2CDD281101R0040		0.085	10
2	440	904155	SD202/40	2CDD282101R0040		0.170	5
3	440	904216	SD203/40	2CDD283101R0040		0.255	1
4	440	904278	SD204/40	2CDD284101R0040		0.340	1



2CDD05100280013

SD 202

Rated current: 50 A

Poles	Rated voltage	Bbn 4016779	Order details		Price 1 piece	Weight 1 piece	Pack unit
	V AC	EAN	Type code	Order code			
1	253	904100	SD201/50	2CDD281101R0050		0.085	10
2	440	904162	SD202/50	2CDD282101R0050		0.170	5
3	440	904223	SD203/50	2CDD283101R0050		0.255	1
4	440	904285	SD204/50	2CDD284101R0050		0.340	1

Rated current: 63 A

Poles	Rated voltage	Bbn 4016779	Order details		Price 1 piece	Weight 1 piece	Pack unit
	V AC	EAN	Type code	Order code			
1	253	904117	SD201/63	2CDD281101R0063		0.085	10
2	440	904179	SD202/63	2CDD282101R0063		0.170	5
3	440	904230	SD203/63	2CDD283101R0063		0.255	1
4	440	904292	SD204/63	2CDD284101R0063		0.340	1



2CDD05100380013

SD 203



2CDD05100480013

SD 204

Where to find more:

Worldwide Marks and Approvals of MDRCs p.11/96

Maybe you are also interested in:

Accessories for SD200 §4/7

Command and signalling

SHD 200 switch disconnecter



Electrical data	
Standards	IEC/EN 60947-3
Poles	1P, 2P, 3P, 4P
Rated current I_n	16 A, 25 A, 32 A, 40 A, 50 A, 63 A
Utilization category	AC-22A, DC-21A
Rated voltage U_n	1P: 240 V AC, 60 V DC 2P: 415 V AC, 125 V DC 3...4P: 415 V AC
Insulation voltage U_i	440 V AC
Max. power frequency recovery voltage U_{max}	1P: 252 V AC, 63 V DC 2P: 436 V AC, 131 V DC 3...4P: 436 V AC
Min. operating voltage U_{min}	12 V AC
Rated frequency f	50/60 Hz, DC
Suitable for isolation	Yes
Rated conditional short-circuit current	10 kA in series with NH 00 \leq 63 A gG
Overvoltage category	III
Pollution degree	3
Rated impulse withstand voltage U_{imp} (1.2/50 μ s)	4 kV (test voltage 6.2 kV at sea level; 5 kV at 2,000 m)
Dielectric test voltage	2 kV (50/60 Hz, 1 min.)
Mechanical data	
Housing	Insulation group II, RAL 7035
Toggle	Insulation group II, red, sealable
Contact position indication	Marking on toggle, I ON / 0 OFF
Protection degree acc. to EN 60529	IP20 / IP40 in enclosure with cover
Electrical endurance	$I_n < 32$ A: 20,000 ops. (AC), 1,500 ops. (DC) $I_n \geq 32$ A: 10,000 ops. (AC), 1,500 ops. (DC)
Mechanical endurance	20,000 ops.
Shock resistance acc. to IEC/EN 60068-2-27	25g, 2 shocks, 13 ms
Vibration resistance acc. to IEC/EN 60068-2-6	5g, 20 cycles at 5...150...5 Hz with load 0.8 I_n
Environmental conditions (damp heat cyclic) acc. to IEC/EN 60068-2-30	28 cycles with 55 °C/90-96% and 25 °C/95-100% [°C/RH]
Ambient temperature	-25 ... +55 °C
Storage temperature	-40 ... +70 °C
Installation	
Terminal	Cage terminal
Safety wire guard	No
Two terminal openings for conductor and busbar	No
Cross-section of conductors	25 mm ²
Torque	2.0 Nm
Screwdriver	No. 2 Pozidriv
Mounting	On DIN rail 35 mm acc. to EN 60715 by fast clip
Mounting position	Optional
Removal without disassembling of the busbar	No
Supply	Optional
Dimensions and weight	
Mounting dimensions acc. to DIN 43880	Mounting dimension 1
Pole dimensions (H x D x W)	85 x 69 x 17.5 mm
Pole weight	Approx. 75 g
Combination with auxiliary elements	
Auxiliary contact	No
Signal/auxiliary contact	No
Shunt trip	No
Undervoltage release	No
Motor operating device	No
Padlock	Yes
Approvals	
	CE and RoHS conform Approvals: VDE

6

Where to find more:
Worldwide Marks and Approvals of
MDRCs p.11/96

Command and signalling

SHD 200 switch disconnecter



SHD 201



SHD 202



SHD 203



SHD 204

SHD 200

Switch disconnecter acc. to IEC/EN 60947-3 for panel installation onto DIN rail (35 mm)

Mounting depth: 69 mm

Mounting width: per pole = 17.5 mm = 1 module

Colour: grey, RAL 7035

Colour of switch lever: red RAL 3000

Special features

- Isolating characteristics acc. to IEC/EN 60947-3
- Protection degree IP20 = finger safe
- 25 mm² cage terminal
- Consistent design to all other System pro M DIN rail products
- Cross wiring with MCBs or RCDs using busbars PS
- Durable device identification due to laser labeling
- Captive screws
- Locking device as accessory for unauthorized ON/OFF switching
- Approved acc. to IEC/EN 60947-3 for international use

Ordering details

Rated current: 16 A							
Poles	Rated voltage	Bbn 4016779	Order details		Price 1 piece	Weight 1 piece	Pack unit
	V AC		EAN	Type code			
1	240	904308	SHD201/16	2CDD271111R0016		0.075	10
2	415	904360	SHD202/16	2CDD272111R0016		0.150	5
3	415	904421	SHD203/16	2CDD273111R0016		0.225	1
4	415	904483	SHD204/16	2CDD274111R0016		0.300	1

Rated current: 25 A							
Poles	Rated voltage	Bbn 4016779	Order details		Price 1 piece	Weight 1 piece	Pack unit
	V AC		EAN	Type code			
1	240	904315	SHD201/25	2CDD271111R0025		0.075	10
2	415	904377	SHD202/25	2CDD272111R0025		0.150	5
3	415	904438	SHD203/25	2CDD273111R0025		0.225	1
4	415	904490	SHD204/25	2CDD274111R0025		0.300	1

Rated current: 32 A							
Poles	Rated voltage	Bbn 4016779	Order details		Price 1 piece	Weight 1 piece	Pack unit
	V AC		EAN	Type code			
1	240	904322	SHD201/32	2CDD271111R0032		0.075	10
2	415	904384	SHD202/32	2CDD272111R0032		0.150	5
3	415	904445	SHD203/32	2CDD273111R0032		0.225	1
4	415	904506	SHD204/32	2CDD274111R0032		0.300	1

Where to find more:

Worldwide Marks and Approvals of MDRCs p.11/96



SHD 201

2CDD051005S0012

Ordering details

Rated current: 40 A

Poles	Rated voltage	Bbn 4016779	Order details		Price 1 piece	Weight 1 piece kg	Pack unit pc.
	V AC	EAN	Type code	Order code			
1	240	904339	SHD201/40	2CDD271111R0040		0.075	10
2	415	904391	SHD202/40	2CDD272111R0040		0.150	5
3	415	904452	SHD203/40	2CDD273111R0040		0.225	1
4	415	904513	SHD204/40	2CDD274111R0040		0.300	1

Rated current: 50 A

Poles	Rated voltage	Bbn 4016779	Order details		Price 1 piece	Weight 1 piece kg	Pack unit pc.
	V AC	EAN	Type code	Order code			
1	240	904346	SHD201/50	2CDD271111R0050		0.075	10
2	415	904407	SHD202/50	2CDD272111R0050		0.150	5
3	415	904469	SHD203/50	2CDD273111R0050		0.225	1
4	415	904520	SHD204/50	2CDD274111R0050		0.300	1

6



SHD 202

2CDD051005S0012

Rated current: 63 A

Poles	Rated voltage	Bbn 4016779	Order details		Price 1 piece	Weight 1 piece kg	Pack unit pc.
	V AC	EAN	Type code	Order code			
1	240	904353	SHD201/63	2CDD271111R0063		0.075	10
2	415	904414	SHD202/63	2CDD272111R0063		0.150	5
3	415	904476	SHD203/63	2CDD273111R0063		0.225	1
4	415	904537	SHD204/63	2CDD274111R0063		0.300	1



SHD 203

2CDD051005S0012



SHD 204

2CDD051005S0012

Command and signalling

E 200 switches



E 200

Technical data		
Electrical Data		
Standards	DIN EN 60947-3 (VDE0660-107); IEC/EN 60947-3	
Number of poles	1P, 2P, 3P, 4P	
Rated current I_b	16 ... 125 A	
Rated voltage U_b	230/400 V AC; 60 V DC	
Rated frequency f	50/60 Hz; DC	
Utilization category	I_b 16 ... 100 A	AC-22A (1, 4-pole) DC-21B (1/2-pole)
	I_b 125 A	AC-23A (1/2-pole) DC-21B (1/2-pole)
	Acc. to DIN EN 60947-3 (VDE0660-107); IEC/EN 60947-3	
Protection fuse	NH 00 gG \leq Rated current E200	
Positive opening	Acc. to DIN VDE 0113	
Rated conditional short-circuit current	16 ... 100 A (1- to 4-pole): 25 kA, 125 A (1-/2-pole): 6 kA	
Surge withstand capability U_{imp}	4 kV (EN 60947-1)	
Min. voltage U_{min}	12 V AC/DC bei 0.1 VA	
Min. contact loading	24 V AC; 4 mA	
Mechanical Data		
Housing	Grey, RAL 7035	
Toggle	Red (RAL 3000) / grey (RAL 7000), sealable	
Contact position indication	On toggle (I ON / 0 OFF), on dome (I / 0)	
Protection degree acc. to IEC/EN 60529	IP10, IP40 in enclosure with cover	
Electrical endurance	16 ... 100 A: 1,500 ops., 125 A: 1,000 ops.	
Mechanical endurance	20,000 ops.	
Environmental conditions acc. to IEC/EN 60068-2-30	Constant climate 23/83, 40/93, 55/20 [°C/RH]	
	Alternating climate 25/95 - 40/93 [°C/RH]	
Ambient temperature	-25 ... +55 °C	
Storage temperature	-40 ... +70 °C	
Installation		
Terminal size	2.5 to 50 mm ²	
Cross-section busbar	\geq 16 mm ²	
Tightening torque	2.5 Nm	
Screw driver	Nr. 2 Pozidriv	
Mounting	On DIN rail 35 mm acc. to EN 60715 by fast clip	
Mounting position	Any	
Supply	Any	
Dimensions and weight		
Mounting dimensions acc. to DIN 43880	Mounting dimension 1	
Pole dimensions (H x D x W)	85 x 70 x 17.5 mm	
Pole weight	Ca. 95 g	
Accessories		
Auxiliary contact	Max. 3x S2C-H 6R	
Approvals	CE and RoHS conform Approvals: VDE; CCC; KEMA	

Where to find more:

Assembling of S2C-H 6R and E 200
p.10/209
Worldwide Marks and Approvals
p.11/96



E 201

E 200 switches

Isolator for panel installation onto DIN rail acc. to DIN EN 60715

Mounting depth: 70 mm

Mounting width: per pole = 17.5 mm = 1 module

Colour: grey, RAL 7035

Colour of switch lever: red RAL 3000 (r); grey RAL 7000 (g)

Special features

- Fast removal without dismantling of the busbar
- Captive screws with recessed/slotted head, Pozidriv size 2
- Add-on of up to 3 auxiliary contact S2C-H6R possible
- Integrated lay-on edge for labeling system ILS
- Locking device as accessory for unauthorized ON/OFF
- Approval: VDE, CCC, KEMA

Rated current: 16 A

Poles	Rated voltage	Power loss	Bbn 4016779	Order details		Price 1 piece	Weight 1 piece	Pack unit
	V AC	W	EAN	Type code	Order code			
1NO	230	0.15	645614	E201/16g	2CDE281001R1016		0.095	10
1NO	230	0.15	645621	E201/16r	2CDE281001R0016		0.095	10
2NO	400	0.30	645799	E202/16g	2CDE282001R1016		0.190	5
2NO	400	0.30	645805	E202/16r	2CDE282001R0016		0.190	5
3NO	400	0.45	645973	E203/16g	2CDE283001R1016		0.290	3
3NO	400	0.45	645980	E203/16r	2CDE283001R0016		0.290	3
4NO	400	0.60	646154	E204/16g	2CDE284001R1016		0.390	2
4NO	400	0.60	646161	E204/16r	2CDE284001R0016		0.390	2

Rated current: 25 A

Poles	Rated voltage	Power loss	Bbn 4016779	Order details		Price 1 piece	Weight 1 piece	Pack unit
	V AC	W	EAN	Type code	Order code			
1NO	230	0.30	645638	E201/25g	2CDE281001R1025		0.095	10
1NO	230	0.30	645645	E201/25r	2CDE281001R0025		0.095	10
2NO	400	0.60	645812	E202/25g	2CDE282001R1025		0.190	5
2NO	400	0.60	645829	E202/25r	2CDE282001R0025		0.190	5
3NO	400	0.90	645997	E203/25g	2CDE283001R1025		0.290	3
3NO	400	0.90	646000	E203/25r	2CDE283001R0025		0.290	3
4NO	400	1.20	646178	E204/25g	2CDE284001R1025		0.390	2
4NO	400	1.20	646185	E204/25r	2CDE284001R0025		0.390	2

Command and signalling E 200 switches



E 201

Rated current: 32 A

Poles	Rated voltage	Power loss	Bbn 4016779	Order details		Price 1 piece	Weight 1 piece	Pack unit
	V AC	W	EAN	Type code	Order code			
1NO	230	0.50	645652	E201/32g	2CDE281001R1032		0.095	10
1NO	230	0.50	645669	E201/32r	2CDE281001R0032		0.095	10
2NO	400	0.95	645836	E202/32g	2CDE282001R1032		0.190	5
2NO	400	0.95	645843	E202/32r	2CDE282001R0032		0.190	5
3NO	400	1.40	646017	E203/32g	2CDE283001R1032		0.290	3
3NO	400	1.40	646024	E203/32r	2CDE283001R0032		0.290	3
4NO	400	1.90	646192	E204/32g	2CDE284001R1032		0.390	2
4NO	400	1.90	646208	E204/32r	2CDE284001R0032		0.390	2

Rated current: 40 A

Poles	Rated voltage	Power loss	Bbn 4016779	Order details		Price 1 piece	Weight 1 piece	Pack unit
	V AC	W	EAN	Type code	Order code			
1NO	230	0.70	645676	E201/40g	2CDE281001R1040		0.095	10
1NO	230	0.70	645683	E201/40r	2CDE281001R0040		0.095	10
2NO	400	1.40	645850	E202/40g	2CDE282001R1040		0.190	5
2NO	400	1.40	645867	E202/40r	2CDE282001R0040		0.190	5
3NO	400	2.10	646031	E203/40g	2CDE283001R1040		0.290	3
3NO	400	2.10	646048	E203/40r	2CDE283001R0040		0.290	3
4NO	400	2.80	646215	E204/40g	2CDE284001R1040		0.390	2
4NO	400	2.80	646222	E204/40r	2CDE284001R0040		0.390	2

Rated current: 45 A

Poles	Rated voltage	Power loss	Bbn 4016779	Order details		Price 1 piece	Weight 1 piece	Pack unit
	V AC	W	EAN	Type code	Order code			
1NO	230	0.90	645690	E201/45g	2CDE281001R1045		0.095	10
1NO	230	0.90	645706	E201/45r	2CDE281001R0045		0.095	10
2NO	400	1.80	645874	E202/45g	2CDE282001R1045		0.190	5
2NO	400	1.80	645881	E202/45r	2CDE282001R0045		0.190	5
3NO	400	2.65	646055	E203/45g	2CDE283001R1045		0.290	3
3NO	400	2.65	646062	E203/45r	2CDE283001R0045		0.290	3
4NO	400	3.50	646239	E204/45g	2CDE284001R1045		0.390	2
4NO	400	3.50	646246	E204/45r	2CDE284001R0045		0.390	2

Rated current: 63 A

Poles	Rated voltage	Power loss	Bbn 4016779	Order details		Price 1 piece	Weight 1 piece	Pack unit
	V AC	W	EAN	Type code	Order code			
1NO	230	1.65	645713	E201/63g	2CDE281001R1063		0.095	10
1NO	230	1.65	645720	E201/63r	2CDE281001R0063		0.095	10
2NO	400	3.30	645898	E202/63g	2CDE282001R1063		0.190	5
2NO	400	3.30	645904	E202/63r	2CDE282001R0063		0.190	5
3NO	400	4.90	646079	E203/63g	2CDE283001R1063		0.290	3
3NO	400	4.90	646086	E203/63r	2CDE283001R0063		0.290	3
4NO	400	6.55	646253	E204/63g	2CDE284001R1063		0.390	2
4NO	400	6.55	646260	E204/63r	2CDE284001R0063		0.390	2



2CDE051486F0003

E 201

Rated current: 80 A

Poles	Rated voltage	Power loss	Bbn 4016779	Order details		Price 1 piece	Weight 1 piece	Pack unit
	V AC	W	EAN	Type code	Order code			
1NO	230	2.60	645737	E201/80g	2CDE281001R1080		0.095	10
1NO	230	2.60	645744	E201/80r	2CDE281001R0080		0.095	10
2NO	400	5.15	645911	E202/80g	2CDE282001R1080		0.190	5
2NO	400	5.15	645928	E202/80r	2CDE282001R0080		0.190	5
3NO	400	7.75	646093	E203/80g	2CDE283001R1080		0.290	3
3NO	400	7.75	646109	E203/80r	2CDE283001R0080		0.290	3
4NO	400	10.30	646277	E204/80g	2CDE284001R1080		0.390	2
4NO	400	10.30	646284	E204/80r	2CDE284001R0080		0.390	2

Rated current: 100 A

Poles	Rated voltage	Power loss	Bbn 4016779	Order details		Price 1 piece	Weight 1 piece	Pack unit
	V AC	W	EAN	Type code	Order code			
1NO	230	3.95	645751	E201/100g	2CDE281001R1100		0.095	10
1NO	230	3.95	645738	E201/100r	2CDE281001R0100		0.095	10
2NO	400	7.90	645935	E202/100g	2CDE282001R1100		0.190	5
2NO	400	7.90	645942	E202/100r	2CDE282001R0100		0.190	5
3NO	400	11.85	646116	E203/100g	2CDE283001R1100		0.290	3
3NO	400	11.85	646123	E203/100r	2CDE283001R0100		0.290	3
4NO	400	15.80	646291	E204/100g	2CDE284001R1100		0.390	2
4NO	400	15.80	646307	E204/100r	2CDE284001R0100		0.390	2

6

Rated current: 125 A

Poles	Rated voltage	Power loss	Bbn 4016779	Order details		Price 1 piece	Weight 1 piece	Pack unit
	V AC	W	EAN	Type code	Order code			
1NO	230	6.10	645775	E201/125g	2CDE281001R1125		0.095	10
1NO	230	6.10	645782	E201/125r	2CDE281001R0125		0.095	10
2NO	400	12.20	645959	E202/125g	2CDE282001R1125		0.190	5
2NO	400	12.20	645966	E202/125r	2CDE282001R0125		0.190	5
3NO	400	18.30	646130	E203/125g ①	2CDE283001R1125		0.33	3
3NO	400	18.30	646147	E203/125r ①	2CDE283001R0125		0.33	3
4NO	400	24.35	646314	E204/125g ①	2CDE284001R1125		0.44	2
4NO	400	24.35	646321	E204/125r ①	2CDE284001R0125		0.44	2

① without approvals

Command and signalling

E 463/3, E 480/3 switches



E 462

2CSC40048R0201



SA 2

2CSC20043R0201



SA 2

2CSC40045R0201

Technical features	
Switching capacity	1.25 In; 1.1 Un; $\cos\phi = 0.6$ according to DIN VDE 0632
Rated voltage	250/400 V a.c.
Connection cross section	1 mm ² stranded wire/0.5 mm ² wire up to 25 mm ²
Pick-up torque	3 Nm max.
Positive opening	according to DIN VDE 0113
Ambient temperature	-25°C to +55°C
Storage temperature	-40°C to +70°C
Poles	3 NO
Short-circuit withstanding capacity	10 kA, 400 V a.c.

E 463/3-KB, E 480/3-KB, E 463/3-SL switches

Poles	Rated voltage V AC	Bbn 7612270 EAN	Order details		Price 1 piece	Weight 1 piece kg	Pack unit pc.
			Type code	Order code			
63	5.4	932528	E 463/3-KB	2CCE160300R0131		0.190	1
63	5.5	932535	E 463/3-SL	2CCE160301R0131		0.195	1
80	9.9	932542	E 480/3-KB	2CCE180300R0141		0.210	1

Padlock for E 463/3-SL with 2 keys

	Bbn 7612270 EAN	Order details		Price 1 piece	Weight 1 piece kg	Pack unit pc.
		Type code	Order code			
	587704	SA 2	GJF1101903R0002		0.020	1

Command and signalling

S800PV series 1500 switch disconnecter



S800PV-M

		S800PV-M	S802PV-M-H
General	Standards	IEC / EN 60947-3	IEC / EN 60947-3
Data	Poles	2 ... 4	2 (polarized)
	Tripping characteristics		
	Rated current I _n	A 32, 63, 125	32, 63, 100
	Rated frequency f	Hz	
	Rated insulation voltage U _i acc. to IEC/EN 60664-1	V DC 1500	DC 1500
	Rated impulse withstand voltage U _{imp} . (1.2/50μs)	kV 8	
	Overvoltage category	III	
	Pollution degree	2	
	Suitability for isolation	yes	
Data acc. to IEC/EN 60947-3	Rated operational voltage U _e	V DC 800V: 2-pole DC 1200V: 3-pole DC 1200V: 4-pole	DC 1000V: 2-pole
	Min. operating voltage	V -	-
	Rated short-term withstand current I _{sw}	kA 1,5	
	Rated short-circuit making capacity I _{cm}	kA 0,5	
	Utilisation category	DC-21A	
	Electrical and Mechanical Endurance	ops. 10 ... 100A: 1500 electric; 8500 mechanic 125A: 1000 electric, 7000 mechanic acc. to IEC 60947-3	
Mechanical Data	Housing	Material group 1, RAL 7035	
	Toggle	black, lockable	
	Classification acc. To NF F 126-101, NF F 16-102		
	Protection degree acc. to EN 60529	IP20, IP40 (actuating end only)	
	Mechanical endurance	ops. 10'000 cycles	10'000 cycles
	Shock resistance acc. to IEC/EN 60068-2-30	IEC 61373 Cat. 1 Class B, 5g / 30ms acc. To IEC 60068-27 Test Ea	
	Vibration resistance acc. to IEC/EN 60068-2-6	IEC 60068-2-6 Test Fc; 2 - 13.2Hz / 1mm 13.2 - 100Hz / 0.7g with load 100% x I _e	
	Environmental conditions (damp heat) acc. to IEC/EN 60068-2-30	°C/RH 12 + 12 cycle with 55°C / 90-96% and 25% / 95-100%	
	Environmental conditions (dry heat) acc. to IEC/EN 60068-2-2 Test B	°C/RH 16 hours 55°C / 2 hours 70°C with damp heat 55%	
	Ambient temperature	°C -25 ... + 60	
	Storage temperature	°C -25 ... +70	
Installation	Terminal	Failsafe cage or ringlug terminal	Failsafe cage or ringlug terminal
	Stranded Cross-section of conductors (top / bottom)	mm ² 1 ... 50	
	Flexible Cross-section of conductors (top/bottom)	mm ² 1 ... 70	
	Tightening torque	Nm 3,5 in-lbs. 31	
	Screwdriver	P0Z1 2	
	Mounting	any	
	Mounting position	any	
	Supply	any	any (taking into account the polarization)
Dimensions and weight	Pole dimensions (H x L x W)	mm 95 x 26.5 x 82.5	
	Pole weight	g 240	
Combination with aux. elements	Auxiliary contact	yes	
	Combined auxiliary- / signal contact	yes	
	Shunt trip	yes	
	Undervoltage release	yes	
	Shunt open release	yes	
	Motor Operating Device	yes	

6

Command and signalling

S800PV series 1500 switch disconnecter



S802PV-M



S803PV-M



S804PV-M

S800PV-M

Function: DC main switch for photovoltaic applications. Safe disconnection of photovoltaic arrays.

Applications: Photovoltaic systems.

Standard: IEC 60947-3

Icw=1.5 kA

Number of poles	Rated current	Bbn 7612271	Order details		Price 1 piece	Weight 1 piece	Pack unit
	In A	EAN	Type code	Order code		kg	pc.
2	32	211233	S802PV-M32	2CCP812001R1329		0.43	1
	63	215026	S802PV-M63	2CCD842001R1590		0.65	1
	125	211240	S802PV-M125	2CCP812001R1849		0.43	1

Number of poles	Rated current	Bbn 7612271	Order details		Price 1 piece	Weight 1 piece	Pack unit
	In A	EAN	Type code	Order code		kg	pc.
3	32	211257	S803PV-M32	2CCP813001R1329		0.65	1
	63	215033	S803PV-M63	2CCD843001R1590		0.65	1
	125	211264	S803PV-M125	2CCP813001R1849		0.65	1

Number of poles	Rated current	Bbn 7612271	Order details		Price 1 piece	Weight 1 piece	Pack unit
	In A	EAN	Type code	Order code		kg	pc.
4	32	211271	S804PV-M32	2CCP814001R1329		0.86	1
	63	215040	S804PV-M63	2CCD844001R1590		0.86	1
	125	211288	S804PV-M125	2CCP814001R1849		0.86	1

Maybe you are also interested in:
S800PV p. 2/188



S800PV

S800PV-M-H

Function: this polarized disconnecter is designed to meet the requirements for photovoltaic systems.

Only 54 mm wide, voltage up to 1000 V d.c. and a rated current up to 100 A.

Number of poles	Rated current	Bbn 7612271	Order details		Price 1 piece	Weight 1 piece kg	Pack unit pc.
	In A	EAN	Type code	Order code			
2	32	420703	S802PV-M32-H	2CCP247204R0001		0.43	1
	63	420710	S802PV-M63-H	2CCP247205R0001		0.43	1
	100	420796	S802PV-M100-H	2CCP247212R0001		0.43	1

Command and signalling

E 210 switches



On-off switches

General	
Overall depth	68 mm
Width	0.5 or 1 module (9 or 18 mm)
Colour	grey, RAL 7035
Climatic resistance to	IEC 60068-2-2 (dry heat) IEC 60068-2-30 (humid heat) IEC 60068-2-1 (low temperatures)
Ambient temperature	- 25°C to + 55°C
Storage temperature	- 40°C to + 70°C
Connection cross-section (Cu)	from 1 x 1 mm ² to 1 x 6 mm ² or 2 x 2.5 mm ² solid; from 1x 0.75 mm ² to 2 x 1.5 mm ² flexible with end ferrule or pin cable lug
Tightening torque	1,2-1,5 Nm
Contacts	Double interrupting
On-off switches (E211; E211X)	
Short-circuit withstand capacity Inc	3 kA; at 400 V cos j = 0.8 (with fusing <_ 35 A / NH00)
Rated current In	16 A, 25 A, 32 A
Rated voltage Un	
in accordance with EN	250 VAC, 400 VAC
in accordance UL 508	240 VAC
Rated impulse withstand voltage Uimp	6 kV
Lowest operating voltage	24 VAC; 25 mA
Isolating features	to EN60669-2-4; IEC/EN 60947-3
Utilization category	AC-22 A, DC-22 A acc. IEC/EN 60947-3
LED voltage ranges	On-off switches E211X 115-250 VAC (Tolerance +/- 10%)
Frequency	50/60 Hz
Sealable	in the On and Off positions
Standards	DIN EN 60669-1 *VDE 0632-1 DIN EN 60669-2-4 *VDE 0632-2-4 UL 508
Approvals	VDE; UL; GOST; CCC

Utilization category for E211 On-off switches (according to standard IEC 60947-3)

Type	In	Utilization category		
		DC-22 A	AC-22 A	AC-22 A
E211-16-...	16 A	50 VDC / 16 A	200 VDC / 1 A	400 VAC / 16 A
E211-25-...	25 A	50 VDC / 25 A	200 VDC / 2 A	400 VDC / 25 A
E211-32-...-	32 A	50 VDC / 32 A	200 VDC / 3 A	400 VDC / 32 A

Change over, Group and control switches, pushbuttons and indicator lights

Change over, Group and Control switches (E213; E214; E218)	
Rated current In	16 A, 25 A
Rated voltage Un	
in accordance with EN	250 VAC, 400 VAC
in accordance UL 508	240 VAC
Lowest operating voltage	24 VAC; 25 mA
Frequency	50/60 Hz
Switches sealable	in the On and Off positions
Standards	DIN EN 60669-1 *VDE 0632-1 UL 508
Approvals	VDE; UL; GOST; CCC
Pushbuttons without and with LED (E215; E217)	
Rated current In	16 A
Rated voltage Un	
in accordance with EN	250 VAC
in accordance UL 508	240 VAC
Lowest operating voltage	24 VAC; 25 mA
LED voltage ranges	12-48 VAC / DC; 115-250 VAC; 60-220 VDC (Tolerance +/- 10%)
Frequency	50/60 Hz
Standards	DIN EN 60669-1 *VDE 0632-1 UL 508
Approvals	VDE; UL; GOST; CCC
Indicator lights (E219)	
LED voltage ranges	12-48 VAC / DC; 115-250 VAC; 60-220 VDC (Tolerance +/- 10%)
Frequency	50/60 Hz
Insulation voltage	250 V
Rated impulse withstand voltage Uimp	4 kV
Dissipated power	0.47-1 W
Standards	DIN EN 62094-1 UL 508
Approvals	VDE; UL; GOST; *1
Indicator lights with 2 LEDs	
LED voltage ranges	115-250 VAC; 12-48 VAC (tolerance +/- 10%)
Frequency	50/60 Hz
Insulation voltage	250 V
Rated impulse withstand voltage Uimp	4 kV
Dissipated power	0.8 W
Standards	DIN EN 62094-1
Approvals	VDE; GOST; *1
Indicator lights with 3 LEDs	
LED voltage ranges	415/250 VAC (tolerance +/- 10%)
Frequency	50/60 Hz
Insulation voltage	250 V
Rated impulse withstand voltage Uimp	4 kV
Dissipated power	1.2 W
Standards	DIN EN 62094-1
Approvals	VDE; GOST; *1

6

*1 = CCC approval not required

Command and signalling

E 210 switches



E 211-16-10



E211-16-20

These devices are specifically made for commanding loads and signalling electrical conditions in any low-voltage switchboard. They are available in half module or 1 module, depending on the contact-layout. The devices with indicator lights are equipped with a LED, which grants an optimal illumination with very low consumption.

The functions of these devices are particularly switching, pushing and signalling electrical conditions in any installations (low-voltage area)

General new features

- Space-saving through 9 mm modules
- All terminals equipped with Pozidrive 1 screws
- Safe connection due to cage-clamp
- LED with bright colours and available in three different voltage ranges
- Different lens and button colours
- Compliance to international standards

E 211-... ON-OFF switches

For example, such devices are used to switch indicators or other electrical components (like fan's, air-conditions, e.g.). The new On-Off switches distinguish themselves through simple handling, easy mounting and optimal functionality.

Rated current = 16 A									
Contacts	Rated voltage	Power loss	Width	Bbn 7612270	Order details		Price 1 piece	Weight 1 piece	Pack unit
	V AC	W	mm	EAN	Type code	Order code	kg	pc.	
1 NO	250	0.32	9	938575	E211-16-10	2CCA703000R0001		0.035	10
2 NO	250/400	0.82	9	938582	E211-16-20	2CCA703005R0001		0.045	10
3 NO	250/400	1.14	18	938599	E211-16-30	2CCA703010R0001		0.080	10
4 NO	250/400	1.64	18	938605	E211-16-40	2CCA703015R0001		0.090	10

Rated current = 25 A									
Contacts	Rated voltage	Power loss	Width	Bbn 7612270	Order details		Price 1 piece	Weight 1 piece	Pack unit
	V AC	W	mm	EAN	Type code	Order code	kg	pc.	
1 NO	250	0.75	9	938612	E211-25-10	2CCA703001R0001		0.035	10
2 NO	250/400	1.95	9	938629	E211-25-20	2CCA703006R0001		0.045	10
3 NO	250/400	2.70	18	938636	E211-25-30	2CCA703011R0001		0.080	10
4 NO	250/400	3.90	18	938643	E211-25-40	2CCA703016R0001		0.090	10

Rated current = 32 A									
Contacts	Rated voltage	Power loss	Width	Bbn 7612270	Order details		Price 1 piece	Weight 1 piece	Pack unit
	V AC	W	mm	EAN	Type code	Order code	kg	pc.	
1 NO	250	1.12	9	938650	E211-32-10	2CCA703002R0001		0.035	10
2 NO	250/400	2.73	9	938667	E211-32-20	2CCA703007R0001		0.045	10
3 NO	250/400	3.85	18	938674	E211-32-30	2CCA703012R0001		0.080	10
4 NO	250/400	5.46	18	938681	E211-32-40	2CCA703017R0001		0.090	10

Where to find more:

DC Switching Capacity of E210
p.10/211
Worldwide Marks and Approvals
p.11/96



E211X-16-10



E211X-16-20



E213-16-001



E 213-16-002

E 211X-... On-Off switches with yellow LED for contact indication

LED voltage 115-250 V AC

Rated current = 16 A										
Con-tacts	Rated voltage V AC	Power loss W	LED colour	Width mm	Bbn 7612270 EAN	Order details		Price 1 piece	Weight 1 piece kg	Pack unit pc.
						Type code	Order code			
1 NO	250	0.50	yellow	9	938872	E211X-16-10	2CCA703100R0001		0.040	10
2 NO	250/400	1.00	yellow	18	938889	E211X-16-20	2CCA703110R0001		0.050	10
3 NO	250/400	1.50	yellow	18	938896	E211X-16-30	2CCA703115R0001		0.060	10

Rated current = 25 A										
Con-tacts	Rated voltage V AC	Power loss W	LED colour	Width mm	Bbn 7612270 EAN	Order details		Price 1 piece	Weight 1 piece kg	Pack unit pc.
						Type code	Order code			
1 NO	250	1.15	yellow	9	938902	E211X-25-10	2CCA703101R0001		0.040	10
2 NO	250/400	2.30	yellow	18	938919	E211X-25-20	2CCA703111R0001		0.050	10
3 NO	250/400	3.45	yellow	18	938926	E211X-25-30	2CCA703116R0001		0.060	10

6

E 213-... Change over switches

The new change-over switches distinguish themselves through simple handling, easy mounting and optimal functionality. Example applications include opening and closing of electrically operated flaps.

Rated current = 16 A										
Con-tacts	Rated voltage V AC	Power loss W	LED colour	Width mm	Bbn 7612270 EAN	Order details		Price 1 piece	Weight 1 piece kg	Pack unit pc.
						Type code	Order code			
1 CO	250	0.32	-	9	938698	E213-16-001	2CCA703040R0001		0.041	10
2 CO	250	0.82	-	18	938704	E213-16-002	2CCA703045R0001		0.082	10

Rated current = 25 A										
Con-tacts	Rated voltage V AC	Power loss W	LED colour	Width mm	Bbn 7612270 EAN	Order details		Price 1 piece	Weight 1 piece kg	Pack unit pc.
						Type code	Order code			
1 CO	250	0.40	-	9	938711	E213-25-001	2CCA703041R0001		0.041	10
2 CO	250	0.88	-	18	938728	E213-25-002	2CCA703046R0001		0.082	10

Command and signalling

E 210 switches



E214-16-101



E214-16-202



E 218-16-11



E 218-16-22

E 214-... Group switches (I-0-II, manual-OFF-automatic)

The new Group switches can be used to control the main installation of an emergency supply. Such devices distinguish themselves through simple handling, easy mounting and optimal functionality.

Rated current = 16 A									
Contacts	Rated voltage	Power loss	Width	Bbn 7612270	Order details		Price 1 piece	Weight 1 piece	Pack unit
	V AC	W	mm	EAN	Type code	Order code	kg	pc.	
1 CO	250	0.32	9	938735	E214-16-101	2CCA703025R0001		0.041	10
2 CO	250	0.82	18	938742	E214-16-202	2CCA703030R0001		0.082	10

Rated current = 25 A									
Contacts	Rated voltage	Power loss	Width	Bbn 7612270	Order details		Price 1 piece	Weight 1 piece	Pack unit
	V AC	W	mm	EAN	Type code	Order code	kg	pc.	
1 CO	250	0.40	9	938759	E214-25-101	2CCA703026R0001		0.041	10
2 CO	250	0.88	18	938766	E214-25-202	2CCA703031R0001		0.082	10

E 218-... Control switches

These devices can be used in distribution board for any control function. The new control switches distinguish themselves through simple handling, easy mounting and optimal functionality.

Rated current = 16 A									
Contacts	Rated voltage	Power loss	Width	Bbn 7612270	Order details		Price 1 piece	Weight 1 piece	Pack unit
	V AC	W	mm	EAN	Type code	Order code	kg	pc.	
1NO+1NC	250	0.50	9	938773	E218-16-11	2CCA703050R0001		0.041	10
2NO+2NC	250	1.00	18	938780	E218-16-22	2CCA703060R0001		0.082	10
3NO+1NC	250	1.50	18	938797	E218-16-31	2CCA703065R0001		0.082	10

Rated current = 25 A									
Contacts	Rated voltage	Power loss	Width	Bbn 7612270	Order details		Price 1 piece	Weight 1 piece	Pack unit
	V AC	W	mm	EAN	Type code	Order code	kg	pc.	
1NO+1NC	250	0.75	9	938803	E218-25-11	2CCA703051R0001		0.041	10

Where to find more:

DC Switching Capacity of E210
p.10/211
Worldwide Marks and Approvals
p.11/96

Command and signalling

E 210 pushbuttons



E 215



E 217

E 215-... Pushbuttons (6 different button colours)

Pushbuttons without and with LED

The new products are available in 9 mm widths (= 0.5 modules).

The devices can be used in distribution boards and are all distinguished by their simple handling, ease of mounting and optimal functionality. The pushbuttons are used for remote control in all kinds of electrical installation (e.g. public, industrial). The range offers three different voltages.

(Ranges: 12-48 V AC/DC; 115-250 V AC and 60-220 V DC).

Rated current = 16 A										
Contacts	Rated voltage V AC	Power loss W	Button colour	Width mm	Bbn 7612270 EAN	Order details		Price 1 piece	Weight 1 piece kg	Pack unit pc.
						Type code	Order code			
1NO+1NC	250	0.50	grey	9	938810	E215-16-11B	2CCA703150R0001		0.046	10
1NO+1NC	250	0.50	red	9	938827	E215-16-11C	2CCA703151R0001		0.046	10
1NO+1NC	250	0.50	green	9	938834	E215-16-11D	2CCA703152R0001		0.046	10
1NO+1NC	250	0.50	yellow	9	938841	E215-16-11E	2CCA703153R0001		0.046	10
1NO+1NC	250	0.50	black	9	938858	E215-16-11F	2CCA703154R0001		0.046	10
1NO+1NC	250	0.50	blue	9	938865	E215-16-11G	2CCA703155R0001		0.046	10

6

E 217-... Luminous Pushbuttons (5 different LED colours)

LED Voltage range = 115-250 V AC										
Con- tacts	Rated voltage V AC	Power loss W	LED colour	Width mm	Bbn 7612270 EAN	Order details		Price 1 piece	Weight 1 piece kg	Pack unit pc.
						Type code	Order code			
1 NO	250	1.10	white	9	938988	E217-16-10B	2CCA703160R0001		0.050	10
1 NO	250	1.10	red	9	938995	E217-16-10C	2CCA703161R0001		0.050	10
1 NO	250	1.10	green	9	939008	E217-16-10D	2CCA703162R0001		0.050	10
1 NO	250	1.10	yellow	9	939015	E217-16-10E	2CCA703163R0001		0.050	10
1 NO	250	1.10	blue	9	939022	E217-16-10G	2CCA703164R0001		0.050	10
1 NC	250	1.10	white	9	939084	E217-16-01B	2CCA703250R0001		0.050	10
1 NC	250	1.10	red	9	939091	E217-16-01C	2CCA703251R0001		0.050	10
1 NC	250	1.10	green	9	939107	E217-16-01D	2CCA703252R0001		0.050	10
1 NC	250	1.10	yellow	9	939114	E217-16-01E	2CCA703253R0001		0.050	10
1 NC	250	1.10	blue	9	939121	E217-16-01G	2CCA703254R0001		0.050	10

Command and signalling

E 210 pushbuttons



E 217-... Luminous Pushbuttons (5 different LED colours)

LED Voltage range = 12-48 V AC/DC

Con- tacts	Rated voltage V AC	Power loss W	LED colour	Width mm	Bbn 7612270 EAN	Order details		Price 1 piece	Weight 1 piece kg	Pack unit pc.
						Type code	Order code			
1 NO	250	0.72	white	9	938933	E217-16-10B48	2CCA703170R0001		0.050	10
1 NO	250	0.72	red	9	938940	E217-16-10C48	2CCA703171R0001		0.050	10
1 NO	250	0.72	green	9	938957	E217-16-10D48	2CCA703172R0001		0.050	10
1 NO	250	0.72	yellow	9	938964	E217-16-10E48	2CCA703173R0001		0.050	10
1 NO	250	0.72	blue	9	938971	E217-16-10G48	2CCA703174R0001		0.050	10
1 NC	250	0.72	white	9	939039	E217-16-01B48	2CCA703260R0001		0.050	10
1 NC	250	0.72	red	9	939046	E217-16-01C48	2CCA703261R0001		0.050	10
1 NC	250	0.72	green	9	939053	E217-16-01D48	2CCA703262R0001		0.050	10
1 NC	250	0.72	yellow	9	939060	E217-16-01E48	2CCA703263R0001		0.050	10
1 NC	250	0.72	blue	9	939077	E217-16-01G48	2CCA703264R0001		0.050	10

LED Voltage range = 60-220 V DC

Con- tacts	Rated voltage V AC	Power loss W	LED colour	Width mm	Bbn 7612270 EAN	Order details		Price 1 piece	Weight 1 piece kg	Pack unit pc.
						Type code	Order code			
1 NO	250	1.50	white	9	939138	E217-16-10B220	2CCA703165R0001		0.050	10
1 NO	250	1.50	red	9	939145	E217-16-10C220	2CCA703166R0001		0.050	10
1 NO	250	1.50	green	9	939152	E217-16-10D220	2CCA703167R0001		0.050	10
1 NO	250	1.50	yellow	9	939169	E217-16-10E220	2CCA703168R0001		0.050	10
1 NO	250	1.50	blue	9	939176	E217-16-10G220	2CCA703169R0001		0.050	10
1 NC	250	1.50	white	9	939183	E217-16-01B220	2CCA703255R0001		0.050	10
1 NC	250	1.50	red	9	939190	E217-16-01C220	2CCA703256R0001		0.050	10
1 NC	250	1.50	green	9	939206	E217-16-01D220	2CCA703257R0001		0.050	10
1 NC	250	1.50	yellow	9	939213	E217-16-01E220	2CCA703258R0001		0.050	10
1 NC	250	1.50	blue	9	939220	E217-16-01G220	2CCA703259R0001		0.050	10

Where to find more:

DC Switching Capacity of E210
p.10/211
Worldwide Marks and Approvals
p.11/96

Command and signalling

E 210 indicator lights



E 219

E 219-... Indicator Lights with LED (5 different colours)

Indicator Lights with LED

The new products are available in 9 mm width (= 0.5 modules) and can be used for indicating any operational condition such as signalling loss of a phase.

The range offers three different voltages.

(Ranges: 12-48 V AC/DC; 115-250 V AC and 110-220 V DC).

Single indicator light - LED Voltage range = 115-250 V AC

Power loss	LED colour	Width	Bbn 7612270	Order details		Price 1 piece	Weight 1 piece	Pack unit
W		mm	EAN	Type code	Order code		kg	pc.
0.47	white	9	939282	E219-B	2CCA703400R0001		0.04	10
0.47	red	9	939299	E219-C	2CCA703401R0001		0.04	10
0.47	green	9	939305	E219-D	2CCA703402R0001		0.04	10
0.47	yellow	9	939312	E219-E	2CCA703403R0001		0.04	10
0.47	blue	9	939329	E219-G	2CCA703404R0001		0.04	10

6

Single indicator light - LED Voltage range = 12-48 V AC/DC

Power loss	LED colour	Width	Bbn 7612270	Order details		Price 1 piece	Weight 1 piece	Pack unit
W		mm	EAN	Type code	Order code		kg	pc.
0.40	white	9	939237	E219-B48	2CCA703420R0001		0.04	10
0.40	red	9	939244	E219-C48	2CCA703421R0001		0.04	10
0.40	green	9	939251	E219-D48	2CCA703422R0001		0.04	10
0.40	yellow	9	939268	E219-E48	2CCA703423R0001		0.04	10
0.40	blue	9	939275	E219-G48	2CCA703424R0001		0.04	10

Single indicator light - LED Voltage range = 60-220 V DC

Power loss	LED colour	Width	Bbn 7612270	Order details		Price 1 piece	Weight 1 piece	Pack unit
W		mm	EAN	Type code	Order code		kg	pc.
1.00	white	9	939336	E219-B220	2CCA703405R0001		0.04	10
1.00	red	9	939343	E219-C220	2CCA703406R0001		0.04	10
1.00	green	9	939350	E219-D220	2CCA703407R0001		0.04	10
1.00	yellow	9	939367	E219-E220	2CCA703408R0001		0.04	10
1.00	blue	9	939374	E219-G220	2CCA703409R0001		0.04	10

Command and signalling E 210 indicator lights



E 219-2CD



E 219-3CDE

Double indicator light - LED Voltage range = 12-24 V AC								
Power loss	LED colour	Width	Bbn 7612271	Order details		Price 1 piece	Weight 1 piece	Pack unit
W		mm	EAN	Type code	Order code		kg	pc.
0.8	green, red	9	413347	E219-2CD48	2CCA703911R0001		0.042	10

Double indicator light - LED Voltage range = 115-230 V AC								
Power loss	LED colour	Width	Bbn 7612271	Order details		Price 1 piece	Weight 1 piece	Pack unit
W		mm	EAN	Type code	Order code		kg	pc.
0.8	green, red	9	413330	E219-2CD	2CCA703910R0001		0.042	10

Triple indicator light - LED Voltage range = 415-230 V AC								
Power loss	LED colour	Width	Bbn 7612271	Order details		Price 1 piece	Weight 1 piece	Pack unit
W		mm	EAN	Type code	Order code		kg	pc.
1.2	red, red, red	9	413309	E219-3C	2CCA703900R0001		0.044	10
1.2	green, green, green	9	413316	E219-3D	2CCA703901R0001		0.044	10
1.2	red, yellow, green	9	413323	E219-3CDE	2CCA703902R0001		0.044	10

Command and signalling E 210 accessories



E 210-DH



E 210-ASV9

Accessories for E 210 device series

Dummy housing for 9 mm wide units The modular width of 18 mm must be complied with to use the devices in the SMISLINE socket system. The dummy housing is ready-made with two expanding connectors. Always snap on dummy housing on the left.							
	Bbn 7612270	Order details		Price 1 piece	Weight 1 piece	Pack unit	
	EAN	Type code	Order code		kg	pc.	
	404208	E210-DH	2CCA703480R0001		0.18	10	

Padlock							
	Bbn 7612270	Order details		Price 1 piece	Weight 1 piece	Pack unit	
	EAN	Type code	Order code		kg	pc.	
to use for 9 and 18 mm wide units	404215	E210-ASV9	2CCA703648R0001		0.01	10	

Command and signalling

SL luminous indicators for panel installation



SL 4 LEDs



SL 12 LEDs

Technical characteristics		
Electrical characteristics		
Supply	[V]	- a.c./d.c 24, 48 - a.c. 115, 230 - d.c. 115
Frequency	[Hz]	0-1000
Power consumption	[W]	0.5 max per input
TEST input consumption	[W]	4 max
Other characteristics		
Operating temperature	[°C]	-20 +60
Storage temperature	[°C]	-20 +70
Relative humidity		30-95%
Overall dimensions	[mm]	48 x 48 x 56 (SL-3 e SL-4) 96 x 96 x 56 (SL...96) 72 x 144 x 70 (SL...72-144)
Weight	[gr]	100 (SL-3 e SL-4), 300 (SL-12-115V/96) 350 (SL-12-115V/72-144)
Protection degree		IP40
Label dimensions	[mm]	30 x 9

6

Luminous indicator

These luminous indicator devices provide an intuitive and readily visible front panel display of the state of an electrical line or load situated either remotely or inside the panel itself. The range of luminous indicator includes devices with 3, 4 or 12 LEDs with various supply voltage ratings, and fully-customisable plain labels.

The version with 115 V d.c. supply rating, is ideal for installation on medium voltage panels and for non-standard applications, and complete an extensive range of easy-to-install indicator devices.

Indicator lamps 24 V a.c./d.c.

Size	Number of LEDs	Characteristics of the LEDs	Label	Bbn 801254	Order details		Price 1 piece	Weight 1 piece	Pack unit
mm				EAN	Type code	Order code		kg	pc.
48	3	not included	neutral	2659501	SL-3-24V/48	2CSG211010R3001		0.01	1
48	4	not included	neutral	2659600	SL-4-24V/48	2CSG221010R3001		0.01	1
48	3	■	neutral	2659709	SL-3-L1-L2-L3-24V/48	2CSG241020R3001		0.01	1
48	3	■ ■ ■	in English	2659808	SL-3-A-C-S-24V/48	2CSG251030R3001		0.01	1
48	4	■ ■ ■ ■	in English	2659907	SL-4-A-C-S-E-24V/48	2CSG251040R3001		0.01	1
96	12	not included	alarm	2660002	SL-12-24V/96	2CSG274050R3001		0.03	1
144	12	not included	alarm	2660408	SL-12-24V/144	2CSG233050R3001		0.35	1

Indicator lamps 48 V a.c./d.c.

Size	Number of LEDs	Characteristics of the LEDs	Label	Bbn 801254	Order details		Price 1 piece	Weight 1 piece	Pack unit
mm				EAN	Type code	Order code		kg	pc.
48	3	not included	neutral	2660002	SL-3-48V/48	2CSG311010R3001		0.01	1
48	4	not included	neutral	2658603	SL-4-48V/48	2CSG321010R3001		0.01	1
48	3	■	neutral	2658702	SL-3-L1-L2-L3-48V/48	2CSG341020R3001		0.01	1
48	3	■ ■ ■	in English	2658801	SL-3-A-C-S-48V/48	2CSG351030R3001		0.01	1
48	4	■ ■ ■ ■	in English	2658900	SL-4-A-C-S-E-48V/48	2CSG351040R3001		0.01	1
96	12	not included	alarm	2660101	SL-12-48V/96	2CSG374050R3001		0.03	1
144	12	not included	alarm	2660507	SL-12-48V/144	2CSG333050R3001		0.35	1

Command and signalling

SL luminous indicators for panel installation

Indicator lamps 115 V a.c.									
Size	Number of LEDs	Characteristics of the LEDs	Label	Bbn 801254	Order details		Price 1 piece	Weight 1 piece	Pack unit
mm				EAN	Type code	Order code		kg	pc.
48	3	not included	neutral	2659006	SL-3-115V/48	2CSG411010R3001		0.01	1
48	4	not included	neutral	2659105	SL-4-115V/48	2CSG421010R3001		0.01	1
48	3		in English	2659303	SL-3-A-C-S-115V/48	2CSG451030R3001		0.01	1
48	4		in English	2659402	SL-4-A-C-S-E-115V/48	2CSG451040R3001		0.01	1
96	12	not included	alarm	2660200	SL-12-115V/96	2CSG474050R3001		0.03	1
144	12	not included	alarm	2660606	SL-12-115V/144	2CSG433050R3001		0.35	1

Indicator lamps 115 V d.c.									
Size	Number of LEDs	Characteristics of the LEDs	Label	Bbn 801254	Order details		Price 1 piece	Weight 1 piece	Pack unit
mm				EAN	Type code	Order code		kg	pc.
48	3	not included	neutral	2659006	SL-3-115V/48 DC	2CSG273233R3001		0.01	1
48	4	not included	neutral	2659105	SL-4-115V/48 DC	2CSG273313R3001		0.01	1
48	3		in English	2659303	SL-3-A-C-S-115V/48 DC	2CSG273223R3001		0.01	1
48	4		in English	2659402	SL-4-A-C-S-E-115V/48 DC	2CSG273303R3001		0.01	1
96	12	not included	neutral	2732136	SL12-115V/96 DC	2CSG273213R3001		0.01	1
144	12	not included	neutral	2732938	SL12-115V/72-144 DC	2CSG273293R3001		0.01	1

Indicator lamps 230 V a.c.									
Size	Number of LEDs	Characteristics of the LEDs	Label	Bbn 801254	Order details		Price 1 piece	Weight 1 piece	Pack unit
mm				EAN	Type code	Order code		kg	pc.
48	3	not included	neutral	2659501	SL-3-230V/48	2CSG511010R3001		0.01	1
48	4	not included	neutral	2659600	SL-4-230V/48	2CSG521010R3001		0.01	1
48	3		neutral	2659709	SL-3-L1-L2-L3-230V/48	2CSG541020R3001		0.01	1
48	3		in English	2659808	SL-3-A-C-S-230V/48	2CSG551030R3001		0.01	1
48	4		in English	2659907	SL-4-A-C-S-E-230V/48	2CSG551040R3001		0.01	1
96	12	not included	alarm	2660309	SL-12-230V/96	2CSG574050R3001		0.03	1
144	12	not included	alarm	2660705	SL-12-230V/144	2CSG533050R3001		0.35	1

Accessories for luminous indicators									
	Bbn 801254	Order details		Price 1 piece	Weight 1 piece	Pack unit			
	EAN	Type code	Order code		kg	pc.			
	2660804	red LED	2CSG500060R3001		0.05	5 pcs			
	2660903	green LED	2CSG500070R3001		0.05	5 pcs			
	2661009	yellow LED	2CSG500080R3001		0.05	5 pcs			
	2661108	blue LED	2CSG500090R3001		0.05	5 pcs			
	2661207	white LED	2CSG500100R3001		0.05	5 pcs			

Command and signalling

ESB installation contactors



ESB

1SBC10307F0014

Main Pole - Utilization Characteristics according to IEC						
Contactor types:	AC operated		ESB20/ EN20			
	AC/DC operated			ESB24/ EN24	ESB40/ EN40	ESB63
Rated operational voltage Ue max.	V		250	400		
Rated frequency limits	Hz		50/60	DC or 50/60 Hz		
Utilization category AC-1 / AC-7a						
for air temperature close to contactor < 55 °C	(NO) A		20	24	40	63
Max. rated operational current Ie AC-1 / AC-7a	(NC) A		20	24	30	30
Rated operational power AC-1/ AC-7a	230 V - 1 phase	(NO) kW	4	5.5	9.2	14.5
	400 V - 3 phases	(NO) kW	-	16	26	41
	230 V - 1 phase	(NC) kW	4	5.3	8.8	6.9
	400 V - 3 phases	(NC) kW	-	16	26	26
Utilization category AC-3 / AC-7b						
for air temperature close to contactor < 55 °C	230 V - 1 phase	A	9	9	22	30
Max. rated operational current Ie AC-3/AC-7b	400 V - 3 phases	A	-	9	22	30
Rated operational power AC-3/ AC-7b	230 V - 1 phase	kW	1.3	1.3	3.7	5
	400 V - 3 phases	kW	-	4	11	15
Rated making capacity AC-3/AC-7b			10 x Ie / AC-3			
Rated breaking capacity AC-3/AC-7b			8 x Ie / AC-3			
Short-circuit protection for contactors gG type fuse	A		20	35	63	80
Rated short-time withstand current Icw at 40 °C ambient temp., in free air, from a cold state	10 s	A	72		176	240
Heat dissipation per pole	Ie / AC-1/AC-7a	W	1	3	4	6
Max. electrical switching frequency	- for AC-1 / AC-7a	cycles/h	300			
	- for AC-3 / AC-7b	cycles/h	600			
Electrical durability	- for AC-1 / AC-7a	cycles	150000	150000	150000	150000
	- for AC-3 / AC-7b	cycles	150000	500000	170000	240000
Mechanical durability	- millions of operating cycles		1.000.000			

6

Where to find more:

Technical Details for ESB p.10/212



Maybe you are also interested in:

Accessories for Contactors (p.6/35)

Command and signalling

ESB installation contactors

Magnet System Characteristics						
Contactor types:	AC operated		ESB20			
	AC/DC operated			ESB24	ESB40	ESB63
Coil operating limits acc. to IEC 60947-4-1			0.85 ... 1.1 x U _c (at θ m 55 °C)			
Drop-out voltage in % of U _c			approx. 20 ... 75 %	approx. 20 ... 70 %		
Frequency range		Hz	50/60	40 ... 450		
Coil consumption	Average pull-in value	VA/W	8 / 5	4 / 4	5 / 5	65 / 65
	Average holding value	VA/W	3.2 / 1.2	4 / 4	5 / 5	4.2 / 4.2

Connecting Characteristics						
Contactor types:	AC operated		ESB20			
	AC/DC operated				ESB40	
Connecting capacity (min. ... max.)						
Main pole terminals						
Rigid		1 x mm ²	1.5 ... 10	1.5 ... 25		
		2 x mm ²	1.5 ... 4	1.5 ... 10		
Degree of protection						
acc. to IEC 60947-1 / EN 60947-1 and IEC 60529 / EN 60529						
Protection against direct contact in acc. with EN 50274						
All terminals			IP20			

EH04... Auxiliary Contact Block - Utilization Characteristics according to IEC						
Contactor types:	AC operated		ESB20			
	AC/DC operated			ESB24	ESB40	ESB63
Rated operational voltage U _e max.		V	-	500		
Conventional free air thermal current I _{th}						
$\theta < 40$ °C		A	-	6		
Rated frequency limits		Hz	-	50/60		
Rated operational current I _e / AC-15 acc. to IEC 60947-5-1	240 V	50/60 Hz	A	-	4	
	415 V	50/60 Hz	A	-	3	
	500 V	50/60 Hz	A	-	2	
Making capacity	acc. to IEC 60947-5-1		-	11 x I _e		
Breaking capacity	acc. to IEC 60947-5-1		-	11 x I _e		
Short-circuit protection gI type fuse		A	-	10		
Minimum switching capacity with failure rate acc. to IEC 60947-5-4		V/mA	-	17 / 5		
Heat dissipation per pole at 6 A		W	-	0.1		

Where to find more:

Technical Details for ESB p.10/212

Maybe you are also interested in:

Accessories for Contactors p.6/35



ESB 20

Application

The ESB contactors are used mainly in buildings for switching and controlling lighting, heating, ventilation and pumps. They are part of the complete range of Din rail products and can be integrated easily in dedicated panels.

ESB20 are AC coil operated.

The ESB 24, 40, 63 contactors are used for the control of loads up to 24, 40, 63 A.



Due to their DC solenoid actuator, the ESB 24 can be connected to AC or DC voltages.

This provides the following benefits:

Hum-free operating system, no vibration, silent in operation, low power consumption, integrated high overvoltage protection 5 kV. You can choose between a various N.O. and N.C. contacts combination.

Main accessories für ESB 24, 40, 63

Auxiliary contact blocks EH04.

ESB 20									
Main poles	Nb of modules	Control coil voltage		Bbn 3471521	Order details		Price 1 piece	Weight 1 piece	Pack unit
		50 Hz	60 Hz	EAN	Type code	Order code	kg	pc.	
 2 N.O.	1	12 V	14 V	1230141	ESB 20-20	GHE 321 1102 R1004		0.14	10
		24 V	28 V	0263218	ESB 20-20	GHE 321 1102 R0001		0.14	10
		110 V	125...127 V	1230042	ESB 20-20	GHE 321 1102 R0004		0.14	10
		230 V	264 V	0263263	ESB 20-20	GHE 321 1102 R0006		0.14	10
 2 N.C.	1	12 V	14 V	1232145	ESB 20-02	GHE 321 1202 R1004		0.14	10
		24 V	28 V	0263812	ESB 20-02	GHE 321 1202 R0001		0.14	10
		110 V	125...127 V	1232046	ESB 20-02	GHE 321 1202 R0004		0.14	10
 1 N.O. 1 N.C.	1	12 V	14 V	1231148	ESB 20-11	GHE 321 1302 R1004		0.14	10
		24 V	28 V	0263515	ESB 20-11	GHE 321 1302 R0001		0.14	10
		110 V	125...127 V	1231049	ESB 20-11	GHE 321 1302 R0004		0.14	10
		230 V	264 V	0263560	ESB 20-11	GHE 321 1302 R0006		0.14	10

Command and signalling ESB installation contactors



ESB 24

15SC10000P0014

ESB 24									
Main poles	Nb of modules	Control coil voltage		Bbn 4013614 EAN	Order details		Price 1 piece	Weight 1 piece kg	Pack unit pc.
		40...450 Hz	DC		Type code	Order code			
2 N.O.	2	24 V	24 V	215193	ESB 24-20	GHE 329 1402 R0001		0.28	5
		230...240 V	230...240 V	146756	ESB 24-20	GHE 329 1402 R0006		0.28	5
4 N.O.	2	12 V	12 V	084478	ESB 24-40	GHE 329 1102 R1004		0.28	5
		24 V	24 V	084416	ESB 24-40	GHE 329 1102 R0001		0.28	5
		110...120 V	110...120 V	084430	ESB 24-40	GHE 329 1102 R0004		0.28	5
		230...240 V	230...240 V	084454	ESB 24-40	GHE 329 1102 R0006		0.28	5
4 N.C.	2	12 V	12 V	084560	ESB 24-04	GHE 329 1202 R1004		0.28	5
		24 V	24 V	084515	ESB 24-04	GHE 329 1202 R0001		0.28	5
		110...120 V	110...120 V	084539	ESB 24-04	GHE 329 1202 R0004		0.28	5
		230...240 V	230...240 V	084546	ESB 24-04	GHE 329 1202 R0006		0.28	5
2 N.O. 2 N.C.	2	12 V	12 V	084638	ESB 24-22	GHE 329 1302 R1004		0.28	5
		24 V	24 V	084584	ESB 24-22	GHE 329 1302 R0001		0.28	5
		110...120 V	110...120 V	084607	ESB 24-22	GHE 329 1302 R0004		0.28	5
3 N.O. 1 N.C.	2	230...240 V	230...240 V	084614	ESB 24-22	GHE 329 1302 R0006		0.28	5
		12 V	12 V	084720	ESB 24-31	GHE 329 1602 R1004		0.28	5
		24 V	24 V	084676	ESB 24-31	GHE 329 1602 R0001		0.28	5
		110...120 V	110...120 V	084690	ESB 24-31	GHE 329 1602 R0004		0.28	5
1 N.O. 3 N.C.	2	230...240 V	230...240 V	084706	ESB 24-31	GHE 329 1602 R0006		0.28	5
		12 V	12 V	218255	ESB 24-13	GHE 329 1702 R1004		0.28	5
		24 V	24 V	214783	ESB 24-13	GHE 329 1702 R0001		0.28	5
		110...120 V	110...120 V	218224	ESB 24-13	GHE 329 1702 R0004		0.28	5
		230...240 V	230...240 V	218224	ESB 24-13	GHE 329 1702 R0006		0.28	5

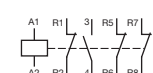
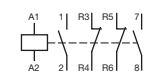
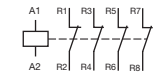
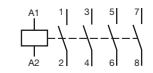

Where to find more:
Technical Details for ESB p.10/212

Maybe you are also interested in:
Accessories for Contactors p.6/35

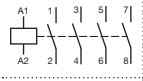
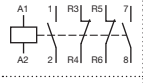
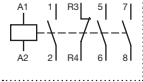
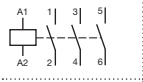
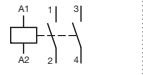
ESB 40									
Main poles	Nb modules	Control coil voltage		Bbn 4013614	Order details		Price 1 piece	Weight 1 piece	Pack unit
		40...450 Hz	DC		EAN	Type code			
 4 N.O.	3	12 V	12 V	149245	ESB 40-40	GHE 349 1102 R1004		0.40	3
		24 V	24 V	084829	ESB 40-40	GHE 349 1102 R0001		0.40	3
		110...120 V	110...120 V	084843	ESB 40-40	GHE 349 1102 R0004		0.40	3
		230...240 V	230...240 V	084867	ESB 40-40	GHE 349 1102 R0006		0.40	3
 2 N.C.	3	24 V	24 V	379611	ESB 40-22	GHE 349 1302 R0001		0.40	3
		230 V	230 V	214332	ESB 40-22	GHE 349 1302 R0006		0.40	3
 1 N.C.	3	24 V	24 V	316890	ESB 40-31	GHE 349 1602 R0001		0.40	3
		230 V	230 V	214349	ESB 40-31	GHE 349 1602 R0006		0.40	3
 3 N.O.	3	24 V	24 V	316890	ESB 40-30	GHE 349 1502 R0001		0.39	3
		230 V	230 V	214349	ESB 40-30	GHE 349 1502 R0006		0.39	3
 2 N.O.	3	24 V	24 V	212345	ESB 40-20	GHE 349 1402 R0001		0.38	3
		230 V	230 V	085314	ESB 40-20	GHE 349 1402 R0006		0.38	3

6

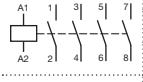
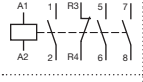
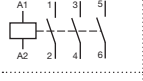
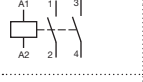
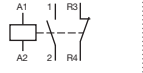
ESB 63									
Main poles	Nb modules	Control coil voltage		Bbn 4013614	Order details		Price 1 piece	Weight 1 piece	Pack unit
		40...450 Hz	DC		EAN	Type code			
 4 N.O.	3	12 V	12 V	218262	ESB 63-40	GHE 369 1102 R1004		0.42	3
		24 V	24 V	084935	ESB 63-40	GHE 369 1102 R0001		0.42	3
		110...120 V	110...120 V	084959	ESB 63-40	GHE 369 1102 R0004		0.42	3
		230...240 V	230...240 V	084973	ESB 63-40	GHE 369 1102 R0006		0.42	3
 1 N.C.	3	110 V	110 V		ESB 63-31	GHE 369 1602 R0004		0.42	3
		230 V	230 V		ESB 63-31	GHE 369 1602 R0006		0.42	3
 3 N.O.	3	230 V	230 V	085376	ESB 63-30	GHE 369 1502 R0006		0.41	3
		400 V	400 V	260964	ESB 63-30	GHE 369 1502 R0007		0.41	3
 2 N.O.	3	24 V	24 V	291999	ESB 63-20	GHE 369 1402 R0001		0.40	3
		230 V	230 V	085369	ESB 63-20	GHE 369 1402 R0006		0.40	3
 1 N.O. 1 N.C.	3	230 V	230 V	214622	ESB 63-11	GHE 369 1802 R0006		0.40	3

Command and signalling

EN series contactors



15EC103001F0014

Application

The EN contactors are used mainly in buildings for switching and controlling lighting, heating, ventilation and pumps. They are part of the complete range of Din rail products and can be integrated easily in dedicated panels.

Description

EN contactors have a built-in toggle switch to select between three function modes:

Off position, automatic run (normal contactor function), manual override with a return to Auto the next time the coil is energized.

This offers many advantages as:

You can make functional test before installation start-up. It can be used for maintenance operation, to change lamps and test it. It provides higher safety and drop out as you can switch the application manually.

The toggle switch is also used for household application like water heating where double tariff of kWh is used.

Main poles	Nb of modules	Control coil voltage		Bbn 4013614 EAN	Order details		Price 1 piece	Weight 1 piece kg	Pack unit pc.
		50 Hz	60 Hz		Type code	Order code			
2 N.O. 	1	24 V	28 V	239038	EN 20-20	GHE 322 1101 R0001		0.14	10
		230 V	264 V	265069	EN 20-20	GHE 322 1101 R0006		0.14	10

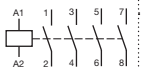
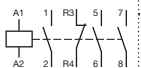
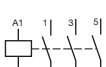
Main poles	Nb of modules	Control coil voltage		Bbn 4013614 EAN	Order details		Price 1 piece	Weight 1 piece kg	Pack unit pc.
		50 Hz	60 Hz		Type code	Order code			
2 N.O. 	3	230...240 V	230...240 V	129582	EN 40-20	GHE 342 1401 R0006		0.40	3
4 N.O. 	2	24 V	24 V	190469	EN 24-40	GHE 326 1101 R0001		0.24	5
		230...240 V	230...240 V	133688	EN 24-40	GHE 326 1101 R0006		0.24	5
3 N.O. 1 N.C. 	2	24 V	24 V	316906	EN 24-31	GHE 326 1601 R0001		0.24	5
		230...240 V	230...240 V	133695	EN 24-31	GHE 326 1601 R0006		0.24	5
3 N.O. 	2	230...240 V	230...240 V	134319	EN 24-30	GHE 326 1501 R0006		0.23	5

Maybe you are also interested in:
Accessories for Contactors p.6/35

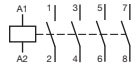
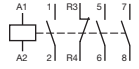
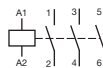
Main poles	Nb of modules	Control coil voltage		Bbn 4013614 EAN	Order details		Price 1 piece	Weight 1 piece kg	Pack unit pc.
		50 Hz	60 Hz		Type code	Order code			
4 N.O. 	3	24 V	24 V	262500	EN 40-40	GHE 342 1101 R0001		0.41	3
		110 V	110 V	261077	EN 40-40	GHE 342 1101 R0004		0.41	3
		230...240 V	230...240 V	133701	EN 40-40	GHE 342 1101 R0006		0.41	3
3 N.O. 1 N.C. 	3	24 V	24 V	337017	EN 40-31	GHE 342 1601 R0001		0.41	3
		230...240 V	230...240 V	337017	EN 40-31	GHE 342 1601 R0006		0.41	3
3 N.O. 	3	230...240 V	230...240 V	212338	EN 40-30	GHE 342 1501 R0006		0.40	3

6

Command and signalling

ESB/EN installation contactors main accessories



EH 04



6



ESB-PLK



ESB-DIS

Contact blocks								
Contactor type	Contact blocks		Bbn	Order details		Price 1 piece	Weight 1 piece	Pack unit
			4013614	Type code	Order code			
			EAN			kg	pc.	
ESB/EN 24, 40, 63	2	—	084768	EH 04-20	GHE 340 1321 R0001		0.004	10
	1	1	084768	EH 04-11	GHE 340 1321 R0002		0.004	10

Sealing cover								
Contactor type			Bbn	Order details		Price 1 piece	Weight 1 piece	Pack unit
			4013614	Type code	Order code			
			EAN			kg	pc.	
ESB/EN 24			084171	ESB-PLK 24	GHE 320 1903 R0001		0.002	10
ESB/EN 40, 63			085222	ESB-PLK 40/63	GHE 340 1903 R0002		0.002	10

Distance piece								
Contactor type			Bbn	Order details		Price 1 piece	Weight 1 piece	Pack unit
			4013614	Type code	Order code			
			EAN			kg	pc.	
ESB/EN 24, 40,63			085215	ESB-DIS	GHE 340 1902 R0001		0.002	10

Command and signalling

E 250, E 259 selection table

	Latching relays E250		Installation relays E259
			
	Contacts switching on each impulse sent to the control coil.		Contacts maintained in switched position only while the control coil is supplied.
General characteristics			
Type of command	Impulse (i.e. via pushbutton)		Continuous (i.e. via switch)
Energy consumption of command circuit	Only on pickup		For entire time contact switching is maintained
Local control lever	Yes		Yes, temporary
Main application	Lighting command by pushbuttons		Lighting command by switches, thermostats, time switches
Rated current	16 A	32 A	16 A
Single phase lamps load characteristics ①			
Incandescent and halogen	3000 W	4000 W	1800 W
Fluorescent power factor corrected in series	3000 VA	4000 VA	1800 VA
Fluorescent power factor corrected in parallel	2500 VA	3200 VA	500 VA
Fluorescent uncorrected power factor	1800 VA	2200 VA	900 VA
Power contacts			
1NA	■	■	■
2NA	■	■	■
Sequential	■		
1NA+1NC	■		■
2NA+2NC	with E250CM11		
3NA, 4NA	with E250CM20	with E250-32 CM20	■
1C/O, 2C/O	■		■
3C/O, 4C/O	with E250CM002		■

6

① See technical details for information on each lamp type

Command and signalling

E 259 installation relays



E 259

Technical features				
			1 - 2 contacts	3 - 4 contacts
Rated voltage Un		[V]	250	400
Rated frequency		[Hz]	50	50
Rated current in AC1/AC-7①		[A]	16	16
Control coil characteristics	a.c. power supply voltage	[V]	8, 12, 24, 48, 115, 230	12, 24, 48, 230
	d.c. power supply voltage	[V]	6, 12, 24, 48, 115	6, 12, 24, 115
	d.c./ a.c. ratio ①		0.5 : 1	0.5 : 1
	Operation limits		±10%	±10%
	Power consumption			
	a.c.			
	pick-up	[VA]	3.4	6.7
	holding	[VA]	1.8	3.4
	d.c.	[W]	2.1	3.9
Load specifications per phase	Maximum load AC-1	[kW]	3	8.5
	Maximum load AC-5 ②	[kW]	1.8	1.8
	Maximum load AC-7 ②	[kW]	0.9	-
	Maximum load AC-3 (400V)	[kW]	-	2.2
	Maximum load DC		③	③
	Minimum load (under 5V)	[W]	2	2
Lifetime in number of operations	Electrical (in AC-1 at full load)	[No.]	3 x 10 ⁵	3 x 10 ⁵
	Mechanical	[No.]	2 x 10 ⁶	2 x 10 ⁶
Max.lamp power b	Incandescent and halogen (40-200W)		[W]	1800
	Fluorescent	Parallel p.f. correction (cosφ=0.9)	[VA]	500
		p.f. uncorrected (cosφ=0.5)	[VA]	900
Width (number of DIN modules)		[No.]	1	2
Cable cross section (Ø min/max)		[mm²]	1.5 / 10	1.5 / 10
Maximum torque on terminals		[Nm]	1	1
Min./Max. ambient T ° at installation point		[°C]	-20 ... +45	-20 ... +45
Standard			IEC EN 60947-4-1, IEC EN 61095	

① Control coil voltage: all the products work both in a.c. and d.c. (with the specified ratio) except the 115 V a.c. version that works at 48 d.c.

② See technical details for lamp types

③ See chart in technical details

Where to find more:

Worldwide Marks and Approvals of MDRCs p.11/96

Maybe you are also interested in:

Accessories for E259 p.10/218



E 259 1NO



E 259 2NO

E 259 installation relays

E 259 Installation relays are 16 A contactors specifically engineered for residential and commercial applications. Their high performance in the control of lamps makes them ideal for lighting circuit applications.

The front control lever indicates the position of the contacts and allows the relay to be commanded, for example for local testing of the circuit.

In installations that require several E 259 relays side by side, it is advisable to use E 259 DIS half-module width spacer elements every second relay for heat dissipation.

E 259, 16 A							
Contacts	Coil voltage	Bbn 8012542 EAN	Order details		Price 1 piece	Weight 1 piece kg	Pack unit pc.
			Type code	Order code			
1NO	8 V a.c.	611233	E259 16-10/8	2CSM261123R0401		0.100	12
	12 V a.c. / 6 V d.c.	736936	E259 16-10/12	2CSM273693R0401		0.100	12
	24 V a.c. / 12 V d.c.	736035	E259 16-10/24	2CSM273603R0401		0.100	12
	48 V a.c. / 24 V d.c.	736837	E259 16-10/48	2CSM273683R0401		0.100	12
	230 V a.c. / 115 V d.c.	735939	E259 16-10/230	2CSM273593R0401		0.100	12
1NO+1NC	8 V a.c.	736738	E259 16-11/8	2CSM273673R0401		0.100	12
	12 V a.c. / 6 V d.c.	735830	E259 16-11/12	2CSM273583R0401		0.100	12
	24 V a.c. / 12 V d.c.	736639	E259 16-11/24	2CSM273663R0401		0.100	12
	48 V a.c. / 24 V d.c.	735731	E259 16-11/48	2CSM273573R0401		0.100	12
	230 V a.c. / 115 V d.c.	736530	E259 16-11/230	2CSM273653R0401		0.100	12
2NO	8 V a.c.	735632	E259 16-20/8	2CSM273563R0401		0.100	12
	12 V a.c. / 6 V d.c.	736431	E259 16-20/12	2CSM273643R0401		0.100	12
	24 V a.c. / 12 V d.c.	735533	E259 16-20/24	2CSM273553R0401		0.100	12
	48 V a.c. / 24 V d.c.	736332	E259 16-20/48	2CSM273633R0401		0.100	12
	115 V a.c. / 48 V d.c.	735434	E259 16-20/115	2CSM273543R0401		0.100	12
1CO	230 V a.c. / 115 V d.c.	736233	E259 16-20/230	2CSM273623R0401		0.100	12
	8 V a.c.	735335	E259 16-19/8	2CSM273533R0401		0.100	12
	12 V a.c. / 6 V d.c.	736134	E259 16-19/12	2CSM273613R0401		0.100	12
	24 V a.c. / 12 V d.c.	735236	E259 16-19/24	2CSM273523R0401		0.100	12
	48 V a.c. / 24 V d.c.	748335	E259 16-19/48	2CSM274833R0401		0.100	12
2CO	230 V a.c. / 115 V d.c.	611134	E259 16-19/230	2CSM261113R0401		0.100	12
	12 V a.c. / 6 V d.c.	735137	E259 16-29/12	2CSM273513R0401		0.100	12
	24 V a.c. / 12 V d.c.	734239	E259 16-29/24	2CSM273423R0401		0.100	12
3NO	230 V a.c. / 115 V d.c.	735038	E259 16-29/230	2CSM273503R0401		0.100	12
	230 V a.c. / 115 V DC	729839	E259 16-30/230	2CSM272983R0401		0.200	6
4NO	12 V a.c. / 6 V d.c.	734130	E259 16-40/12	2CSM273413R0401		0.200	6
	24 V a.c. / 12 V d.c.	734932	E259 16-40/24	2CSM273493R0401		0.200	6
	48 V a.c. / 24 V d.c.	729938	E259 16-40/48	2CSM272993R0401		0.200	6
	230 V a.c. / 115 V d.c.	734031	E259 16-40/230	2CSM273403R0401		0.200	6
3CO	230 V a.c. / 115 V d.c.	747833	E259 16-39/230	2CSM274783R0401		0.200	6
4CO	230 V a.c. / 115 V d.c.	730736	E259 16-49/230	2CSM273073R0401		0.200	6

6

Command and signalling

E 250 latching relays



E 250 H

Auxiliary contacts							
	Rated current	Bbn 8012542	Order details		Price 1 piece	Weight 1 piece	Pack unit
	A	EAN	Type code	Order code		kg	pc.
1NO+1NC	5	534709	E 250 H11	2CSM004400R0201		0.033	16
2NO	5	536901	E 250 H20	2CSM002400R0201		0.033	16
2NC	5	536802	E 250 H02	2CSM008400R0201		0.033	16

Auxiliary contacts						
	Bbn 8012542	Order details		Price 1 piece	Weight 1 piece	Pack unit
	EAN	Type code	Order code		kg	pc.
Spacer element for heat dissipation		E 259-DIS	2CSM000800R0401		0.04	25

Where to find more:
Worldwide Marks and Approvals of
MDRCs p.11/96

Maybe you are also interested in:
Accessories for E250 p.10/218



E 250

2CSC40047P0001

Technical characteristics			E 251 / E 252 / E 256		E 255	
Rated current I _n			[A]	16	32	16
Rated voltage U _n			[V]	250 (1-2 con- tacts) 400 (3-4 contacts)	250 (1-2 con- tacts) 400 (3-4 contacts)	250
Rated frequency			[Hz]	50/60 ①	50/60 ①	50/60 ①
Contacts	main module	NO		1 - 2	1 - 2	1 + 1
		change- over		1 - 2	1 - 2	-
		NO+NC		1 + 1	1 + 1	-
	additional power con- tacts	NO		2	2	-
		change- over		2	-	-
		NO+NC		1+1	-	-
Width (no. of DIN modules)	main module	[mod.]	1	1	1	
	with additional power con- tacts	[mod.]	2	2	-	
Control coil characteristics	supply voltage: d.c / a.c. ratio ②			0,5 : 1	0,5 : 1	0,5 : 1
	tolerance on supply voltage			±10%	±10%	±10%
	power con- sumption a.c.	holding ③	[VA]	11	11,5	11
		pick-up	[VA]	14,5	16,5	14,5
	power consumption d.c.		[W]	7,5	8	7,5
Pulse dura- tions	minimum pulse duration (at U _n)		[s]	0,05	0,05	0,05
	minimum pulse duration (90% U _n)		[s]	0,1	0,1	0,1
	minimum interval between two pulses		[s]	0,15	0,15	0,15
	maximum number of pulses per minute			250	250	250
Lifetime in number of operations ④	electrical (in AC-1 at full load)			4 x 10 ⁵	3 x 10 ⁵	3 x 10 ⁵
	mechanical			2 x 10 ⁶	2 x 10 ⁶	2 x 10 ⁶
Load characte- ristics	maximum load in AC-1 per phase		[A]	20	32	20
	maximum load in DC		[A]	⑥	⑥	⑥
	minimum load per phase (under 5 V)		[W]	2	2	2
	short circuit protection fuse (gL)		[A]	20	32	20

6

Command and signalling

E 250 latching relays

Technical characteristics			E 251 / E 252 / E 256		E 255	
Maximum no. of lamps (103 operations/h)	incandescent and halogen	[W]	3000	4000	3000	
	fluorescent, corrected power factor (cosφ = 0,9)	series	[VA]	4000	4000	3000
		parallel	[VA]	2500	3200	2500
	fluorescent, uncorrected power factor (cosφ = 0,5)	[VA]	1800	2200	1800	
Maximum number of buttons	non illuminated		unlimited	unlimited	unlimited	
	illuminated	3 wires	unlimited	unlimited	unlimited	
		2 wires	⑤	⑤	⑤	
General characteristics	DIN rail mount		yes	yes	yes	
	hooking on bistable DIN rail		yes	yes	yes	
	two position knob		yes	yes	-	
	contact position indication		yes	yes	yes	
	label-holder		yes	yes	yes	
	cage terminals		yes	yes	yes	
	captive screws		yes	yes	yes	
	sealable terminals		yes	yes	yes	
	cable section (o min./max.)	[mm ²]	1,5/10 (2P: 6)	1,5/10 (2P: 6)	1,5/10	
min./max. operating temperature	[°C]	-20...+45	-20...+46	-20...+45		

- ① All latching relays can also be used at 60Hz. In this case and excluding E255, you can use maximum one auxiliary contact E250H but it is not possible to use power contacts E250CM.
- ② Supply voltage: all devices operate in both a.c. and d.c., with the specified voltage ratios, except for the 115 V a.c. version that operates at 48 V d.c..
- ③ The relays can withstand the "button stuck" condition. When the application calls for the relays to be permanently supplied, spacers must be used on either side, making sure that the duty cycle allows the device to cool down to ambient temperature.
- ④ 1 cycle = 2 operations per pole (closing + opening)
- ⑤ See table for use of the E 250 CP compensator modules
- ⑥ See chart in technical details

Where to find more:

Worldwide Marks and Approvals of MDRCs p.11/96

Maybe you are also interested in:

Accessories for E259 p.10/218



E 251-230

2CSC40047P0001

E 250 Latching relays

Allow switching of the contacts in response to each pulse sent to the coil via the normally open pushbuttons. Their high performance in the single or multi-point control of lamps make them an ideal solution for lighting circuits. The manual control lever also gives an indication of the contact position.

The relays come in versions with different coil voltages and contact configurations. The main modules, available in one-and two-contact versions, can be combined with two-pole power contact modules to obtain three-contact and four-contact devices. They can also be provided with auxiliary signal contacts.

E 250, 16 A							
Contacts	Coil voltage	Bbn	Order details		Price 1 piece	Weight 1 piece	Pack unit
		8012542	Type code	Order code			
		EAN				kg	pc.
1NO	8 V a.c.	53050 3	E 251-8	2CSM211000R0201		0.114	12
	12 V a.c. / 6 V d.c.	53020 6	E 251-12	2CSM311000R0201		0.114	12
	24 V a.c. / 12 V d.c.	53040 4	E 251-24	2CSM411000R0201		0.114	12
	48 V a.c. / 24 V d.c.	53060 2	E 251-48	2CSM511000R0201		0.114	12
	230 V a.c. / 115 V d.c.	53030 5	E 251-230	2CSM111000R0201		0.114	12
1NO+1NC	8 V a.c.	53190 6	E 256-8	2CSM214000R0201		0.116	12
	12 V a.c. / 6 V d.c.	53160 9	E 256-12	2CSM314000R0201		0.116	12
	24 V a.c. / 12 V d.c.	53180 7	E 256-24	2CSM414000R0201		0.116	12
	48 V a.c. / 24 V d.c.	53200 2	E 256-48	2CSM514000R0201		0.116	12
	230 V a.c. / 115 V d.c.	53170 8	E 256-230	2CSM114000R0201		0.116	12
2NO	8 V a.c.	53100 5	E 252-8	2CSM212000R0201		0.116	12
	12 V a.c. / 6 V d.c.	53070 1	E 252-12	2CSM312000R0201		0.116	12
	24 V a.c. / 12 V d.c.	53090 9	E 252-24	2CSM412000R0201		0.116	12
	48 V a.c. / 24 V d.c.	53110 4	E 252-48	2CSM512000R0201		0.116	12
	230 V a.c. / 115 V d.c.	53080 0	E 252-230	2CSM112000R0201		0.116	12
1CO	12 V a.c. / 6 V d.c.	53720 5	E 256.1-12	2CSM315000R0201		0.115	12
	24 V a.c. / 12 V d.c.	53740 3	E 256.1-24	2CSM415000R0201		0.115	12
	230 V a.c. / 115 V d.c.	53730 4	E 256.1-230	2CSM115000R0201		0.115	12
2CO	12 V a.c. / 6 V d.c.	53750 2	E 256.2-12	2CSM316000R0201		0.118	12
	24 V a.c. / 12 V d.c.	53770 0	E 256.2-24	2CSM416000R0201		0.118	12
	230 V a.c. / 115 V d.c.	53760 1	E 256.2-230	2CSM116000R0201		0.118	12

6

Command and signalling

E 250 latching relays



E251-32/8

E 250, 32 A							
Contacts	Coil voltage	Bbn 8012542	Order details		Price 1 piece	Weight 1 piece	Pack unit
		EAN	Type code	Order code			
1NO	8 V a.c.	91200 2	E 251-32/8	2CSM231000R0201		0.114	12
	12 V a.c. / 6 V d.c.	91210 1	E 251-32/12	2CSM331000R0201		0.114	12
	24 V a.c. / 12 V d.c.	91220 0	E 251-32/24	2CSM431000R0201		0.114	12
	48 V a.c. / 24 V d.c.	91230 9	E 251-32/48	2CSM531000R0201		0.114	12
	115 V a.c. / 48 V d.c.	91240 8	E 251-32/115	2CSM631000R0201		0.114	12
1NO 1NO	230 V a.c. / 115 V d.c.	91250 7	E 251-32/230	2CSM131000R0201		0.114	12
	8 V a.c.	91260 6	E 252-32/8	2CSM232000R0201		0.116	12
	12 V a.c. / 6 V d.c.	91270 5	E 252-32/12	2CSM332000R0201		0.116	12
	24 V a.c. / 12 V d.c.	91280 4	E 252-32/24	2CSM432000R0201		0.116	12
	48 V a.c. / 24 V d.c.	91290 3	E 252-32/48	2CSM532000R0201		0.116	12
	115 V a.c. / 48 V d.c.	91300 9	E 252-32/115	2CSM632000R0201		0.116	12
	230 V a.c. / 115 V d.c.	91310 8	E 252-32/230	2CSM132000R0201		0.116	12

E 255, 16 A with 2 sequential contacts

This particular version is equipped with two sequential switching contacts. In the initial stable position both contacts are open: one pulse causes the first contact (A) to close; the next pulse causes the second contact to also close (B); a third pulse causes contact A to open and a final pulse completes the cycle by also reopening contact B, thus returning both contacts to their initial state.

The E255 relays cannot be combined with power contacts or auxiliary devices. They are equipped with two LEDs that give an indication of the contact position.

Contacts	Coil voltage	Bbn 8012542	Order details		Price 1 piece	Weight 1 piece	Pack unit
		EAN	Type code	Order code			
2	8 V a.c.	53150 0	E 255-8	2CSM219000R0201		0.121	12
	12 V a.c. / 6 V d.c.	53120 3	E 255-12	2CSM319000R0201		0.121	12
	24 V a.c. / 12 V d.c.	53140 1	E 255-24	2CSM419000R0201		0.121	12
	230 V a.c. / 115 V d.c.	53130 2	E 255-230	2CSM119000R0201		0.121	12



Where to find more:

Worldwide Marks and Approvals of MDRCs p.11/96

Maybe you are also interested in:

Accessories for E259 p.10/218



E 250

Technical characteristics			E 257 C	E 258 C
Rated voltage Un	[V]		250 (1-2 contacts) 400 (3 contacts)	250 (1-2 contacts) 400 (3 contacts)
Rated current In	[A]		16	32
Rated frequency	[Hz]		50/60 ①	50/60 ①
Contacts	NO		1...3	1...3
	change-over		1...3	-
	NO+NC		-	1 + 1
Width (no. of DIN modules)	[mod.]		1 - 2	2
Control coil characteristics	supply voltage: d.c / a.c. ratio ②		0,5 : 1	0,5 : 1
	tolerance on supply voltage		±10%	±10%
	power consumption	holding ③	[VA]	11
	a.c.	pick-up	[VA]	11
ON-OFF command characteristics	power consumption		[W]	7,5
	d.c.			8
ON-OFF command characteristics	supply voltage		see control coil characteristics	
	tolerance on supply voltage			24 V a.c./d.c. 230 V a.c./d.c.
	power consumption	holding ③	[VA]	12
	a.c.	pick-up	[VA]	12
Pulse durations	power consumption d.c.		[W]	12,5
	minimum pulse duration (at Un)	[s]	0,05	0,05
	minimum pulse duration (90% Un)	[s]	0,1	0,1
	minimum interval between two pulses	[s]	0,15	0,15
Lifetime in number of operations ④	maximum number of pulses per minute		250	250
	electrical (in AC-1 at full load)		4 x 10 ⁵	3 x 10 ⁵
Load characteristics	mechanical		2 x 10 ⁶	2 x 10 ⁶
	maximum load in AC-1 per phase	[A]	20	32
	maximum load in DC	[A]	⑥	⑥
Maximum no. of lamps (103 operations/h)	minimum load per phase (under 5 V)		[W]	2
	short circuit protection fuse (gL)		[A]	20
	incandescent and halogen		[W]	3000
Maximum no. of lamps (103 operations/h)	fluorescent, corrected power factor (cosφ = 0,9)	series	[VA]	3000
	fluorescent, uncorrected power factor (cosφ = 0,5)	parallel	[VA]	2500
	fluorescent, uncorrected power factor (cosφ = 0,5)		[VA]	1800

6

Command and signalling

E 250 latching relays

Technical characteristics			E 257 C	E 258 C	E 258 C
Maximum number of buttons	non illuminated		unlimited	unlimited	unlimited
	illuminated	3 wires	unlimited	unlimited	unlimited
		2 wires	⑤	⑤	⑤
General characteristics	DIN rail mount		yes	yes	yes
	hooking on bistable DIN rail		yes	yes	yes
	two position knob		yes	yes	yes
	contact position indication		yes	yes	yes
	label-holder		yes	yes	yes
	cage terminals		yes	yes	yes
	captive screws		yes	yes	yes
	sealable terminals		yes	yes	yes
	cable section (o min./max.)	[mm²]	1,5/10	1,5/10	1,5/10
min./max. operating temperature	[°C]	-20...+45	-20...+45	-20...+45	

① All latching relays can also be used at 60Hz. In this case and excluding E255, you can use maximum one auxiliary contact E250H but it is not possible to use power contacts E250CM.

② Supply voltage: all devices operate in both a.c. and d.c., with the specified voltage ratios, except for the 115 V a.c. version that operates at 48 V d.c..

③ The relays can withstand the "button stuck" condition. When the application calls for the relays to be permanently supplied, spacers must be used on either side, making sure that the duty cycle allows the device to cool down to ambient temperature.

④ 1 cycle = 2 operations per pole (closing + opening)

⑤ See table for use of the E 250 CP compensator modules

⑥ See chart in technical details

captive s

6

Where to find more:

Worldwide Marks and Approvals of MDRCs p.11/96

Maybe you are also interested in:

Accessories for E259 p.10/218



E 250

Latching relays with central command function

The E 257 C and E 258 C versions are latching relays which integrate a central command function (ON and OFF) that allows multiple relays to be controlled from a pair of normally open push-buttons. Using the E 250 GM group module it is also possible to create sub-groups of relays, so as to implement central command of individual subgroups as well as of the entire group of relays. The central command circuit can be permanently supplied, but in that case the circuit of the local coil is excluded.

On E 257 C the central (ON/OFF) command needs to be supplied on the same line as the local push-buttons (see diagram below). This is not required for E 258 C, which can thus also be supplied on the central command at a different voltage than the local pushbuttons circuit.

E 257, 16 A							
Contacts	Coil voltage	Bbn	Order details		Price 1 piece	Weight 1 piece	Pack unit
		8012542	Type code	Order code			
		EAN				kg	pc.
1NO	12 V a.c. / 6 V d.c.	53210 1	E 257 C10-12	2CSM311000R0211		0.126	12
	24 V a.c. / 12 V d.c.	53230 9	E 257 C10-24	2CSM411000R0211		0.126	12
	230 V a.c. / 115 V d.c.	53220 0	E 257 C10-230	2CSM111000R0211		0.126	12
2NO	12 V a.c. / 6 V d.c.	53240 8	E 257 C20-12	2CSM312000R0211		0.174	8
	24 V a.c. / 12 V d.c.	53260 6	E 257 C20-24	2CSM412000R0211		0.174	8
	230 V a.c. / 115 V d.c.	53250 7	E 257 C20-230	2CSM112000R0211		0.174	8
3NO	12 V a.c. / 6 V d.c.	53480 8	E 257 C30-12	2CSM313000R0211		0.240	6
	24 V a.c. / 12 V d.c.	53500 3	E 257 C30-24	2CSM413000R0211		0.240	6
	230 V a.c. / 115 V d.c.	53490 7	E 257 C30-230	2CSM113000R0211		0.240	6
1CO	12 V a.c. / 6 V d.c.	54020 5	E 257 C001-12	2CSM315000R0211		0.126	12
	24 V a.c. / 12 V d.c.	54010 6	E 257 C001-24	2CSM415000R0211		0.126	12
	230 V a.c. / 115 V d.c.	54000 7	E 257 C001-230	2CSM115000R0211		0.126	12
2CO	12 V a.c. / 6 V d.c.	54050 2	E 257 C002-12	2CSM316000R0211		0.174	8
	24 V a.c. / 12 V d.c.	54040 3	E 257 C002-24	2CSM416000R0211		0.174	8
	230 V a.c. / 115 V d.c.	54030 4	E 257 C002-230	2CSM116000R0211		0.174	8
3CO	12 V a.c. / 6 V d.c.	54080 9	E 257 C003-12	2CSM317000R0211		0.240	6
	24 V a.c. / 12 V d.c.	54070 0	E 257 C003-24	2CSM417000R0211		0.240	6
	230 V a.c. / 115 V d.c.	54060 1	E 257 C003-230	2CSM117000R0211		0.240	6

6

E 257, 32 A							
Contacts	Coil voltage	Bbn	Order details		Price 1 piece	Weight 1 piece	Pack unit
		8012542	Type code	Order code			
		EAN				kg	pc.
1NO	12 V a.c. / 6 V d.c.	91320 7	E 257-32C10/12	2CSM331000R0211		0.126	12
	24 V a.c. / 12 V d.c.	91330 6	E 257-32C10/24	2CSM431000R0211		0.126	12
	230 V a.c. / 115 V d.c.	91340 5	E 257-32C10/230	2CSM131000R0211		0.126	12
2NO	12 V a.c. / 6 V d.c.	91350 4	E 257-32C20/12	2CSM332000R0211		0.174	8
	24 V a.c. / 12 V d.c.	91360 3	E 257-32C20/24	2CSM432000R0211		0.174	8
	230 V a.c. / 115 V d.c.	91370 2	E 257-32C20/230	2CSM132000R0211		0.174	8
3NO	12 V a.c. / 6 V d.c.	91380 1	E 257-32C30/12	2CSM333000R0211		0.240	6
	24 V a.c. / 12 V d.c.	91390 0	E 257-32C30/24	2CSM433000R0211		0.240	6
	230 V a.c. / 115 V d.c.	91400 6	E 257-32C30/230	2CSM133000R0211		0.240	6

Command and signalling

E 250 latching relays



E 257 32-C30/12



E 258 C003-230/24

E 258 C, 16 A						
Local coil voltage 230 V a.c. / 115 V d.c., central ON/OFF 24 V a.c./d.c.						
Contacts	Bbn 8012542	Order details		Price 1 piece	Weight 1 piece	Pack unit
	EAN	Type code	Order code	kg	pc.	
1 NO	78910 9	E 258 C10-230/24	2CSM211000R0231		0.226	6
2 NO	78830 0	E 258 C20-230/24	2CSM212000R0231		0.235	6
1 NO + 1 NC	78870 6	E 258 C11-230/24	2CSM213000R0231		0.232	6
1 NO + 1 NC +1 CO	78890 4	E 258 C111-230/24	2CSM215000R0231		0.239	6
2 NO +1 CO	78850 8	E 258 C201-230/24	2CSM214000R0231		0.241	6
2 CO	78960 4	E 258 C002-230/24	2CSM216000R0231		0.25	6
3 CO	78990 1	E 258 C003-230/24	2CSM217000R0231		0.256	6

Local coil voltage 230 V a.c. / 115 V d.c., central ON/OFF 230 V a.c./d.c.						
Contacts	Bbn 8012542	Order details		Price 1 piece	Weight 1 piece	Pack unit
	EAN	Type code	Order code	kg	pc.	
1 NO	78920 8	E 258 C10-230/230	2CSM111000R0231		0.233	6
2 NO	78840 9	E 258 C20-230/230	2CSM112000R0231		0.243	6
1 NO + 1 NC	78880 5	E 258 C11-230/230	2CSM113000R0231		0.24	6
1 NO + 1 NC +1 CO	78900 0	E 258 C111-230/230	2CSM115000R0231		0.244	6
2 NO +1 CO	78860 7	E 258 C201-230/230	2CSM114000R0231		0.247	6
2 CO	78970 3	E 258 C002-230/230	2CSM116000R0231		0.257	6
3 CO	79000 6	E 258 C003-230/230	2CSM117000R0231		0.262	6

Local coil voltage 24 V a.c. / 12 V d.c., central ON/OFF 24 V a.c./d.c.						
Contacts	Bbn 8012542	Order details		Price 1 piece	Weight 1 piece	Pack unit
	EAN	Type code	Order code	kg	pc.	
1 NO	79010 5	E 258 C10-24/24	2CSM411000R0231		0.225	6
2 NO	78930 7	E 258 C20-24/24	2CSM412000R0231		0.234	6
2 NO +1 CO	78940 6	E 258 C201-24/24	2CSM414000R0231		0.241	6
2 CO	78950 5	E 258 C002-24/24	2CSM416000R0231		0.249	6
3 CO	78980 2	E 258 C003-24/24	2CSM417000R0231		0.256	6

Where to find more:

Worldwide Marks and Approvals of MDRCs p.11/96

Maybe you are also interested in:

Accessories for E259 p.10/218



E 250

2CSC4002D0211

Auxiliary components and accessories for E 250

Additional power contacts for all coil voltages

Contacts	Rated current	Bbn 8012542	Order details		Price 1 piece	Weight 1 piece	Pack unit
		EAN	Type code	Order code			
2NO	16A	53460 0	E 250 CM20	2CSM012100R0201		0.058	10
1NO+1NC	16A	53450 1	E 250 CM11	2CSM014100R0201		0.058	10
2CO	16A	53440 2	E 250 CM002	2CSM016100R0201		0.059	10
2NO	32A	91410 5	E 250-32 CM20*	2CSM032100R0201		0.058	10

* To be used only with 32 A latching relays

Auxiliary contacts

Contacts	Rated current	Bbn 8012542	Order details		Price 1 piece	Weight 1 piece	Pack unit
		EAN	Type code	Order code			
1NO+1NC	5A	53470 9	E 250 H11	2CSM004400R0201		0.033	16
2NO	5A	53690 1	E 250 H20	2CSM002400R0201		0.033	16
2NC	5A	53680 2	E 250 H02	2CSM008400R0201		0.033	16

6

Other accessories

	Bbn 8012542	Order details		Price 1 piece	Weight 1 piece	Pack unit
	EAN	Type code	Order code			
central command for E251, E252 and E256	53510 2	E 257 CM	2CSM000200R0211		0.033	16
group module	53700 7	E 250 GM	2CSM000600R0201		0.058	12
compensator module	53710 6	E 250 CP	2CSM000500R0201		0.058	12

Command and signalling

FLR latching relays



FLR

Technical features		FLR1	FLR5
Contact type		1NO	2NO
Number of sequences	[No.]	2	4
Rated voltage	[V]	12 / 230 AC	
Rated load		10 A / 250 V AC	
Max. Peak current	[A]	15	
Max. switching power	[VA]	2500	
Max. switching voltage	[V]	250 AC	
Incandescent lamp load	[W]	805	
Fluorescent lamp load	[W]	345	
Frequency	[Hz]	50-60	
Type of operation		sequential - mechanical	
Protection degree		IP20	
Max. number of electrical operations	[No.]	100000	
Max. number of mechanical operations	[No.]	300000	
Insulation resistance	[MW]	100 (500 V DC)	
Dielectric strength (contacts)	[V]	2000 AC	
Dielectric strength (coil)	[V]	3500 AC	
Power dissipation	[VA]	4.5	
Operating temperature	[°C]	-25...+55	
Max. Cable section at terminals	[mm²]	1...2.5	
Terminals		screw	
Tightening torque	[Nm]	0.5	
Installation type		wall/flush mounting	
Dimensions (LxWxH)	[mm]	45 x 22 x 45	
Standards		EN 60669-1 ; EN 60669-2-1	

Characteristics of the contact

Type	No. of pulses	Sequences			
		1	2	3	4
FLR1-12	2	⌋	⌋		
FLR1-230	2	⌋	⌋		
FLR5-12	2	⌋⌋	⌋⌋	⌋⌋	⌋⌋
FLR5-230	2	⌋⌋	⌋⌋	⌋⌋	⌋⌋

Flush mounting latching relays

Speed and ease of assembly, along with their compact size, make the FLR flush mounting latching relays suitable for installation inside flush mount or junction boxes. They are ideal for implementing multipoint command of lighting systems in residential and commercial installations, so as to simplify and reduce the cost of wiring.

Contacts	Bbn 8012542	Order details		Price 1 piece	Weight 1 piece	Pack unit
	EAN	Type code	Order code		kg	pc.
1	063650	FLR1-12	2CSM206365R0241		0.06	20
1	063759	FLR1-230	2CSM206375R0241		0.06	20
2	063858	FLR5-12	2CSM206385R0241		0.06	20
2	063957	FLR5-230	2CSM206395R0241		0.06	20

Where to find more:

Worldwide Marks and Approvals of MDRCs p.11/96

Command and signalling

E 260 latching relays



E 260

Technical features	
E 260/E 260 C	
Rated load at 250 V AC	8 A
Incandescent lamp load	1000 W
Fluorescent lamp load in twin-lamp circuit	1000 W
Fluorescent lamp load shunt compensated	350 W ①
Fluorescent lamp load inductive or capacitive	500 W
Electronic ballast	100 mA / 10 ms ②
Inductive load, $\cos\phi = 0.6/230\text{ V} \sim$	5 A
Contact rating at DC	100 W
Minimum contact rating	4 V AC/10 mA
Contact gap/contact material	0.5 mm/Ag SnO ₂
Service life mechanical switchover at 103/h	> 10 ⁷
Service life at rated load $\cos\phi = 1$ and 103/h	> 10 ⁸
Service life with filament lamps at 103/h	800 W > 10 ⁵ , 1000 W > 0.8x10 ⁵
Service life at rated load $\cos\phi = 0.6$ and 103/h	> 10 ⁴
Max. switching rate	10 ³ /h
Bounce time	3 ms
Connection capacity	2 x 1.5 mm ² with connector sleeve
Tightening torque	0.5 ... 0.8 Nm
ON duration at rated voltage	100 %
Coil voltage range	0.9 to 1.1 U _n
Minimum command time/interval between commands	50/1000 ms
Ambient temperature	-20 °C / -4 °F to 50 °C / 122 °F
Control current when controlled locally	230 V AC 115 mA, after 10s 8 mA ± 20 %
Control current when controlled centrally	230 V AC 8 mA, after 10s 3 mA ± 20 %
Max. parallel capacity of individual control wire at 230 V ~	0.7 µF (ca. 2000 m)
Max. parallel capacity of central control wire at 230 V ~	0.2 µF (ca. 700 m)
Max. glow lamp current – parallel to 230 V control buttons	10 mA
Max. induced voltage at 230 V control inputs	0.2 U _n

6

Latching relays for lamp installations on request.

① E 260 C can not be used with fluorescent lamp load shunt compensated.

② In the case of electronic control gear, take into account a 40-fold inrush current.

E 260 electronic latching relays

Where to find more:

Worldwide Marks and Approvals of MDRCS p.11/96



E 260

The electronic version of latching relays guarantees maximum reliability, life, and noiseless operation. The E 260 C version also allows centralized reset function (ON/OFF).

Latching relays with control electronics
Coil voltage UC = 24 V AC/DC

Contacts	Power loss W ①	Bbn 4016779 EAN	Order details		Price 1 piece	Weight 1 piece kg	Pack unit pc.
			Type code	Order code			
1 NO	2.4 (3.0)	57592 8	E 261-24	2CDE441000R0301		0.085	1
1 NO+1 NC	2.4 (3.5)	57595 9	E 266-24	2CDE444000R0301		0.096	1
2 NO	2.4 (3.5)	57593 5	E 262-24	2CDE442000R0301		0.096	1

Coil voltage UC = 230 V AC

Contacts	Power loss W ①	Bbn 4016779 EAN	Order details		Price 1 piece	Weight 1 piece kg	Pack unit pc.
			Type code	Order code			
1 NO	1.5 (2.0)	57596 6	E 261-230	2CDE141000R0301		0.085	1
1 NO+1 NC	1.7 (3.6)	57598 0	E 266-230	2CDE144000R0301		0.096	1
2 NO	1.7 (3.6)	57597 3	E 262-230	2CDE142000R0301		0.096	1

Latching relays with control electronics for central ON/OFF switch

The central commands have always priority and reliably switch on/off any given number of devices connected in parallel, irrespective of their previous switching position. Local control inputs are blocked when a central command is received. Same potential at central / local control input.

Coil voltage UC = 24 V AC/DC

Contacts	Power loss W ①	Bbn 4016779 EAN	Order details		Price 1 piece	Weight 1 piece kg	Pack unit pc.
			Type code	Order code			
1 NO	2.4 (3.0)	57599 7	E 261 C-24	2CDE441000R0311		0.085	1
1 NO+1 NC	2.4 (3.5)	57601 7	E 266 C-24	2CDE444000R0311		0.096	1
2 NO	2.4 (3.5)	57600 0	E 262 C-24	2CDE442000R0311		0.096	1

Coil voltage UC = 230 V AC

Contacts	Power loss W ①	Bbn 4016779 EAN	Order details		Price 1 piece	Weight 1 piece kg	Pack unit pc.
			Type code	Order code			
1 NO	1.5 (2.0)	57602 4	E 261 C-230	2CDE141000R0311		0.085	1
1 NO+1 NC	1.7 (3.0)	57604 8	E 266 C-230	2CDE144000R0311		0.096	1
2 NO	1.7 (3.0)	57603 1	E 262 C-230	2CDE142000R0311		0.096	1

Where to find more:

Worldwide Marks and Approvals of MDRCs p.11/96

Command and signalling STD50 dimmers



STD 50



STD-EP

Technical features	
Rated voltage	230 V ~ 50 Hz
Ambient temperature	0 °C to + 35 °C
Interference suppression	CE

STD50 dimmers for the control of lamps and ballast

Dimmer for brightness control of filament lamps , 230 V tungsten halogen lamps, Iv halogen lamps with conventional transformers (phase control)

Description/ application	Power loss	Bbn 4016779	Order details		Price 1 piece	Weight 1 piece	Pack unit
	W	EAN	Type code	Order code		kg	pc.
	5 ①	02790 6	STD 50-3	GH V021 1370 R0074		0.155	1

Dimmer for brightness control of filament lamps , 230 V tungsten halogen lamps, Iv halogen lamps with ABB electronic transformers (reverse phase)

Description/ application	Power loss	Bbn 4016779	Order details		Price 1 piece	Weight 1 piece	Pack unit
	W	EAN	Type code	Order code		kg	pc.
	4 ①	03300 8	STD 50-4	GH V021 1370 R0075		0.105	1

6

① power loss = 1% of connected load (4 or 5 W max)

Electronic potentiometer for electronic control gear with control input 0/1 - 10 V DC, control current 50 mA DC Rated current (terminal 3 and 4) 4 A $\cos\phi = 0.9$; switching capacity 700 VA

Description/ application	Power loss	Bbn 4016779	Order details		Price 1 piece	Weight 1 piece	Pack unit
	W	EAN	Type code	Order code		kg	pc.
	5 ②	27050 2	STD-EP	GH V021 1370 R0076		0.073	1

Memory touch controller for electronic control gear Rated voltage/switching output 4 A (~ 10 electronic control gear units) $\cos\phi = 0.9$; 3 A $\cos\phi = 0.5$, switching capacity 700 VA

Description/ application	Power loss	Bbn 4016779	Order details		Price 1 piece	Weight 1 piece	Pack unit
	W	EAN	Type code	Order code		kg	pc.
for electronic control gear with control input 1 – 10 V DC control current 50 mA max.	1	27070 0	STD-MTS	GH V021 0881 R0004		0.110	1

② power loss = 1% of connected load (7 W max)

Where to find more:

Connected Load/Ambient Temperature Diagrams for STD p.10/224

Command and signalling

STD universal dimmer for phase control and reverse phase control



STD-500 U



STD-420 E



STD OCP, STD-OCD,
STD-OCT

Technical features		
Rated voltage		230 V ~ ± 10%, 50/60 Hz
Rated current	STD U	2.17 A
	STD E	1.83 A
Max. connected load	U	500 W/VA
	E	420 W/VA
Power extension		1 U + max. 6 E/phase => max. 3 kVA
Min. connected load	STD U	60 W/VA
	STD E	200 W/VA
Max. line length		100 m pushbutton cable, 2 m data line
Interference suppression		CE
Ambient temperature		0 ... + 45 °C, higher temperatures reduce the power

Electronic protection against short circuit, overload, excessive temperature, automatic load recognition, soft-OFF function optional, memory function, minimum brightness control, visual overload indication

Universal dimmer for phase control and reverse phase control

Universal dimmer STD-500 U and the connected power extension unit STD-420 E are suitable for the brightness control of:

- glow lamps
- 230 V halogen glow lamps
- lv halogen glow lamps with conventional transformer (phase control)
- electronic transformers for lv halogen glow lamps (reverse phase control) e.g.: ABB ETR-70-230, 105-230, 150-230

The STD-500 U dimmer can be operated by one or more unlit pushbuttons (N- or L-controlled) or via a data line:

- EIB control element SB/S
- Powernet control element PSB

Power unit STD-420 E is used to boost the connected load and is controlled exclusively by the preset command of the STD-500 U dimmer. The parallel connection of the outputs of the universal high-performance dimmer and the pertaining power extensions (up to 6 units; connection with enclosed RJ 12 line cut to length) allow for a dimming power of 3,000 W/VA max at one load line.

Not suitable for dimming fluorescent lamps, transformers with current monitor and high-reactance transformers.

Contacts	Power loss W	Bbn 4016779 EAN	Order details		Price 1 piece	Weight 1 piece kg	Pack unit pc.
			Type code	Order code			
high-performance dimmer	6	06692 8	STD-500 U	GJB0 006 590 A0178			1
extension	6	06693 5	STD-420 E	GJB0 006 590 A0179			1
rotary operation element	–	06698 0	STD-OCB	GJB0 006 590 A0183			1
button operation element	–	06695 9	STD-OCP	GJB0 006 590 A0181			1
timer operation element	–	07056 7	STD-OCT	GJB0 006 590 A0185			1

Note: Load and control cables must not be laid in one cable

Where to find more:

Connected Load/Ambient Temperature Diagrams for STD p.10/224

Plug-in operation elements:

pushbutton operation element (STD-OCP)

rotary operation element (STD-OCD)

timer (STD-OCT)

Application



Remove dimmer cap and snap on operation element to provide for control of dimmer with central pushbutton or rotary operation. Local operation elements are still active.

Apart from the manual local control feature, the timer also allows for time-programmed operations.

Basic timer functions:





- year time switch with 48 time programs
- optional with/without decentralized pushbutton control
- special programs: adjustable background brightness, cycle, display and emergency light, holiday program
- running reserve: 5 hours

Command and signalling Transformers selection table

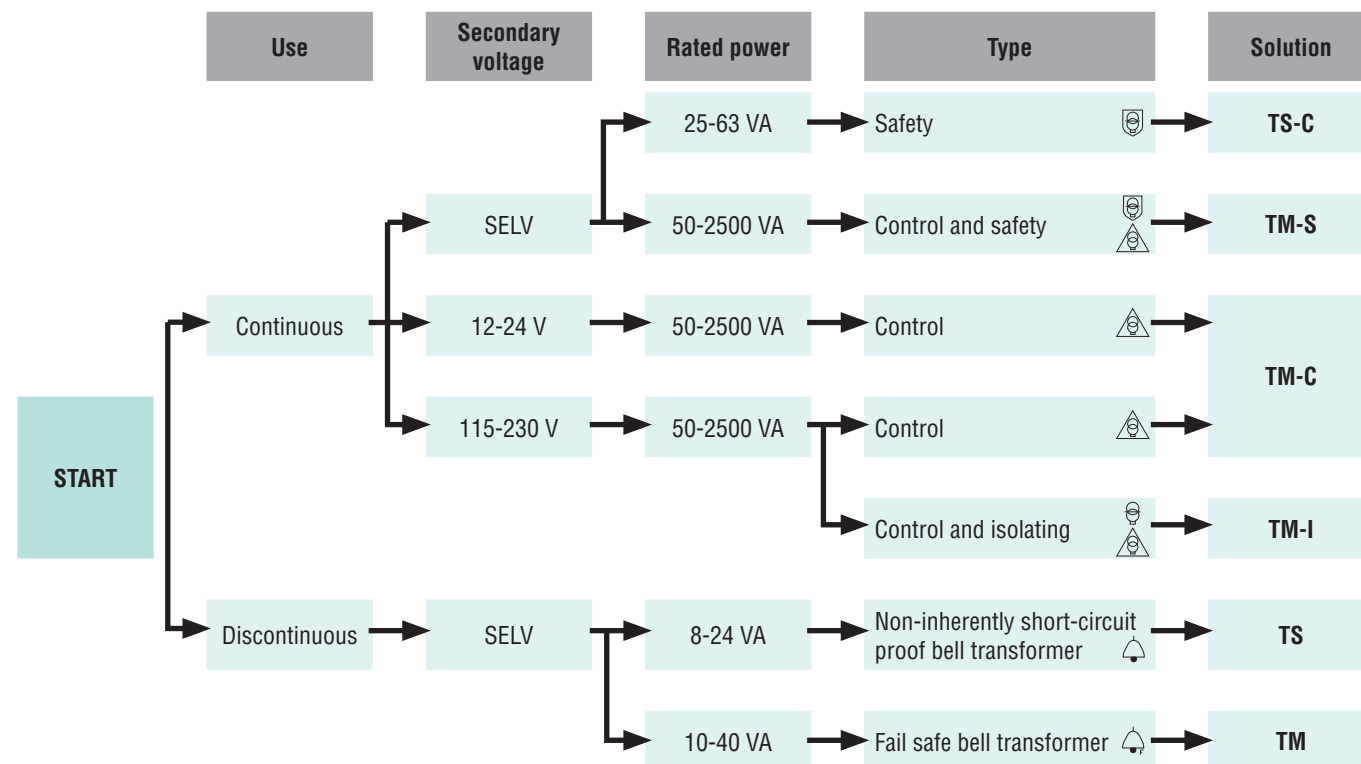



	Bell transformers for discontinuous use	
		
Series	TM	TS
Reference standard	IEC EN 61558-2-8	
Classification	Fail safe	Non-inherently short-circuit proof
Thermal protection integrated in secondary		■
Rated power	10, 15, 30, 40 VA	8, 16, 24 VA
Operation	Discontinuous	
Primary circuit voltage ratings	230 V a.c.	230 V a.c.
Secondary circuit characteristics	Double insulation between primary and secondary windings	■
	Full power on all outputs	■
	SELV secondary (no-load output voltage <50 V a.c.)	■
Dimensions	2 modules [10, 15 VA]	2 modules [8, 16 VA]
	3 modules [30, 40 VA]	3 modules [24 VA]

① See page 9/7 for the choice of the protections.



Safety transformers for general use	Control transformers for general use	Control and Safety transformers for general use	Control and Isolating transformers for general use
			
TS-C IEC EN 61558-2-6	TM-C CEI EN 61558-2-2	TM-S CEI EN 61558-2-2 CEI EN 61558-2-6	TM-I CEI EN 61558-2-2 CEI EN 61558-2-4
Non-inherently short-circuit proof	Non-short-circuit proof control transformer a	Non-short-circuit-proof control and safety transformer a	Non-short-circuit-proof control and isolating transformer a
■			
25, 40, 63 VA	50 to 2500 VA	50 to 2500 VA	50 to 2500 VA
Continuous	Continuous	Continuous	Continuous
230 V a.c.	230/400 V a.c.	230/400V a.c.	230/400 V a.c.
■		■	■
■	■	■	■
■		■	
4 modules [25 VA, 40 VA] 5 modules [63 VA]	See overall dimensions 13/60	See overall dimensions 13/60	See overall dimensions 13/60

6

	Bell transformer Transformers for supplying extra low voltage, suitable for loads that require a discontinuous supply, in particular door-bells and chimes. The primary and secondary circuits are perfectly isolated and separated. Reference standard: IEC EN 61558-2-8	TM, TS
	Control transformer Transformer for supplying control circuits, for example commands, signalling, interlocks, etc. Reference standard: CEI EN 61558-2-2	TM-C, TM-S*, TM-I*
	Safety transformer Isolation transformer for supplying safety extra low voltage circuits (<50 V on no load). Accidental contact with the secondary winding phases can be withstood without any danger. Reference standard: CEI EN 61558-2-6	TS-C, TM-S*
	Isolating transformer Transformer in which the primary and secondary windings are electrically separated by a double or reinforced insulation, to protect the circuit supplied by the secondary against hazards due to accidental simultaneous contact with earth and live parts, or grounded parts that may become live in the event of an insulation fault. Reference standard: CEI EN 61558-2-4	TM-I*

* TM-S and TM-I both comply to two standards.

Command and signalling

Control, isolating and safety transformers selection table

Selection table of products and secondary protections

Primary protection: see page 11/184



Power VA	Secondary voltage	TM-C Control				TM-S Control/Safety				TM-I Control/Isolating	
		12 V	24 V	115 V	230 V	12 V	24 V	24 V	48 V	115 V	230 V
50	Transformer	2CSM207113R0801		2CSM207213R0801		2CSM236893R0801		2CSM204653R0801 ⊗		2CSM204583R0801	
	Fuse gauge ⓘ	4 A	2 A	0.4 A	0.2 A	4 A	2 A	2 A	1 A	0.4 A	0.2 A
100	Transformer	2CSM207103R0801		2CSM236933R0801		2CSM207163R0801		2CSM204643R0801		2CSM201123R0801	
	Fuse gauge ⓘ	8 A	4 A	0.8 A	0.4 A	8 A	4 A	4 A	2 A	0.8 A	0.4 A
	Breaker type	S202 C8	S202 C4	S202 C1	S202 C0,5	S202 C8	S202 C4	S202 C4	S202 C2	S202 C1	S202 C0,5
160	Transformer	2CSM236853R0801		2CSM207203R0801		2CSM202073R0801		2CSM204633R0801		2CSM204533R0801	
	Fuse gauge ⓘ	12 A	6.3 A	1.25 A	0.63 A	12 A	6.3 A	6.3 A	3.15 A	1.25 A	0.63 A
	Breaker type	S202 C13	S202 C8	S202 C1.6	S202 C-	S202 C13	S202 C8	S202 C8	S202 C4	S202 C1.6	-
200	Transformer	2CSM236823R0801		2CSM236883R0801		2CSM260043R0801				2CSM204513R0801	
	Fuse gauge ⓘ	16 A	8 A	1.6 A	0.8 A	16 A	8 A			1.6 A	0.8 A
	Breaker type	S202 C16	S202 C8	S202 C2	S202 C1	S202 C16	S202 C8			S202 C2	S202 C1
250	Transformer	2CSM207093R0801		2CSM236923R0801		2CSM260063R0801		2CSM204673R0801		2CSM204493R0801	
	Fuse gauge ⓘ	20 A	10 A	2 A	1 A	20 A	10 A	10 A	5 A	2 A	1 A
	Breaker type	S202 C20	S202 C10	S202 C2	S202 C1	S202 C20	S202 C10	S202 C10	S202 C6	S202 C2	S202 C1
320	Transformer	2CSM236843R0801		2CSM236923R0801		2CSM260063R0801		2CSM204673R0801		2CSM204493R0801	
	Fuse gauge ⓘ	25 A	12 A	2.5 A	1.25 A	25 A	12 A	12 A	6.3 A	2.5 A	1.25 A
	Breaker type	S202 C25	S202 C13	S202 C3	S202 C1,6	S202 C25	S202 C13	S202 C13	S202 C8	S202 C3	S202 C1,6
400	Transformer	2CSM289703R0801		2CSM207193R0801		2CSM260103R0801		2CSM204613R0801		2CSM201073R0801	
	Fuse gauge ⓘ	32 A	16 A	3.15 A	1.6 A	32 A	16 A	16 A	8 A	3.15 A	1.6 A
	Breaker type	S202 C32	S202 C16	S202 C4	S202 C2	S202 C32	S202 C16	S202 C16	S202 C8	S202 C4	S202 C2
630	Transformer	2CSM236813R0801		2CSM207183R0801		2CSM260053R0801		2CSM204603R0801		2CSM204423R0801	
	Fuse gauge ⓘ	50 A	25 A	5 A	2.5 A	50 A	25 A	25 A	12 A	5 A	2.5 A
	Breaker type	S202 C50	S202 C25	S202 C6	S202 C3	S202 C50	S202 C25	S202 C25	S202 C13	S202 C6	S202 C3
1000	Transformer	2CSM292873R0801		2CSM236913R0801		2CSM260093R0801				2CSM204413R0801	
	Fuse gauge ⓘ	80 A	40 A	8 A	4 A	80 A	40 A			8 A	4 A
	Breaker type	S292 C80	S202 C40	S202 C8	S202 C4	S292 C80	S202 C40			S202 C8	S202 C4
1600	Transformer	2CSM292863R0801		2CSM201813R0801		2CSM260083R0801				2CSM204403R0801	
	Fuse gauge ⓘ	125 A	63 A	16 A	8 A	125 A	63 A			16 A	8 A
	Breaker type	S292 C125	S202 C63	S202 C16	S202 C8	S292 C125	S202 C63			S202 C16	S202 C8
2000	Transformer	2CSM292853R0801		2CSM236903R0801		2CSM260073R0801				2CSM204383R0801	
	Fuse gauge ⓘ	160 A	80 A	16 A	8 A	160 A	80 A			16 A	8 A
	Breaker type	-	S292 C80	S202 C20	S202 C10	-	S292 C80			S202 C20	S202 C10
2500	Transformer	2CSM236943R0801		2CSM207173R0801		2CSM204663R0801				2CSM204363R0801	
	Fuse gauge ⓘ	200 A	100 A	20 A	10 A	200 A	100 A			20 A	10 A
	Breaker type	-	S292 C100	S202 C25	S202 C13	-	S292 C100			S202 C25	S202 C13

ⓘ FUSES

- Gauge ≤ 6.3 A use aM fuses with high breaking capacity and IEC601260-compliant

- Gauge > 6.3 A use gG fuses IEC60269-2 or IEC60269-3-compliant

Ⓣ TM-S 50/24-48 P complies with IEC EN 61558-2-4 on the secondary circuit at 48 V and with IEC EN 61558-2-6 on the secondary circuit at 24 V

Command and signalling

TM-C, TM-S, TM-I control, isolating and safety transformers



TM

Technical characteristics		TM-C	TM-S	TM-I
Rated primary voltage Un	[V]	230/400 a.c.	230/400 a.c.	230/400 a.c.
Primary voltage adjustment outlets ±15 V		No	Yes	Yes
Max ambient temperature ③	[°C]	40	40	40
Rated secondary voltage Un	[V]	12-24, 115-230 a.c.	12-24, 24-48 a.c. b	115-230 a.c.
Rated frequency	[Hz]	50/60	50/60	50/60
Isolation voltage between primary and secondary	[kV]	3.5	4.8	4.8
Rated powers	[VA]	50-2500	50-2500	50-2500
Primary cable section (Ø max)	[mm²]	6	6	6
Operating temperature	[°C]	①	①	①
Approvals		ENEC (Up to 1000 VA), UR, CSA	ENEC (Up to 1000 VA), UR, CSA	ENEC (Up to 1000 VA), UR, CSA
Standards		CEI EN 61558-2-2	CEI EN 61558-2-2 CEI EN 61558-2-6	CEI EN 61558-2-2 CEI EN 61558-2-6

① See technical details

② TM-S 50/24-48 P complies to CEI EN 61558-2-4 on the 48 V secondary and to CEI EN 61558-2-6 on the 24 V secondary

③ Maximum temperature without any power draw. See technical details for power draw according to temperature.

6

Where to find more:

Technical Details for Modular Transformers p.10/249

Worldwide Marks and Approvals of MDRCs p.11/96

Frequently asked question - FAQ:

A complete list of answers is available in the „Questions&Answer“ section of the TM Transformers brochure (code 2CSC446005B0202)



Maybe you are also interested in:

CP-D primary switch mode power supplies p.6/67

Command and signalling

TM-C, TM-S, TM-I control, isolating and safety transformers



TM-I

TM-C control transformer

Transformer for supplying control circuits, for example commands, signalling, interlocks, etc.
Reference standard: CEI EN 61558-2-2.

TM-S safety transformer

Isolation transformer for supplying safety extra low voltage circuits (<50 V on no load). Accidental contact with the secondary winding phases can be withstood without any danger.
Reference standard: CEI EN 61558-2-6

TM-I isolating transformer

Transformer in which the primary and secondary windings are electrically separated by a double or reinforced insulation, to protect the circuit supplied by the secondary against hazards due to accidental simultaneous contact with earth and live parts, or grounded parts that may become live in the event of an insulation fault.

Reference standard: CEI EN 61558-2-4

Since TM-C, TM-S and TM-I transformers are not provided with built-in protection, they must therefore be protected according with these rules:

- Primary: line protection must reach or exceed the recommended value at page 10/293. This device guarantees line protection and service continuity but doesn't protect the transformer.
- Secondary: transformer protection must be chosen according to tables in the previous pages. This device protect the transformer.



TM-S



TM-C



TM-C

TM-C single phase control transformers, primary 230-400 V

Rated power	Secondary voltage	Bbn 8012542	Order details	Price 1 piece	Weight 1 piece	Pack unit
VA	V a.c.	EAN	Type code	Order code	kg	pc.
50	12-24	071136	TM-C 50/12-24	2CSM207113R0801	1.1	1
100	12-24	071037	TM-C 100/12-24	2CSM207103R0801	2	1
160	12-24	368533	TM-C 160/12-24	2CSM236853R0801	3	1
200	12-24	368236	TM-C 200/12-24	2CSM236823R0801	3.2	1
250	12-24	070931	TM-C 250/12-24	2CSM207093R0801	3.6	1
320	12-24	368434	TM-C 320/12-24	2CSM236843R0801	4.4	1
400	12-24	897033	TM-C 400/12-24	2CSM289703R0801	5.5	1
630	12-24	368137	TM-C 630/12-24	2CSM236813R0801	7.8	1
1000	12-24	928737	TM-C 1000/12-24	2CSM292873R0801	13.2	1
1600	12-24	928638	TM-C 1600/12-24	2CSM292863R0801	21.2	1
2000	12-24	928539	TM-C 2000/12-24	2CSM292853R0801	25.5	1
2500	12-24	369431	TM-C 2500/12-24	2CSM236943R0801	26.8	1
50	115-230	072133	TM-C 50/115-230	2CSM207213R0801	1.1	1
100	115-230	369332	TM-C 100/115-230	2CSM236933R0801	2	1
160	115-230	072034	TM-C 160/115-230	2CSM207203R0801	3	1
200	115-230	368830	TM-C 200/115-230	2CSM236883R0801	3.2	1
250	115-230	071532	TM-C 250/115-230	2CSM207153R0801	3.6	1
320	115-230	369233	TM-C 320/115-230	2CSM236923R0801	4.4	1
400	115-230	071938	TM-C 400/115-230	2CSM207193R0801	5.5	1
630	115-230	071839	TM-C 630/115-230	2CSM207183R0801	7.8	1
1000	115-230	369134	TM-C 1000/115-230	2CSM236913R0801	13.2	1
1600	115-230	018131	TM-C 1600/115-230	2CSM201813R0801	21.2	1
2000	115-230	369035	TM-C 2000/115-230	2CSM236903R0801	25.5	1
2500	115-230	071730	TM-C 2500/115-230	2CSM207173R0801	26.8	1

Where to find more:

Technical Details for Modular Transformers p.10/249

Worldwide Marks and Approvals of MDRCs p.11/96

Frequently asked question - FAQ:

A complete list of answers is available in the „Questions&Answer“ section of the TM Transformers brochure (code 2CSC446005B0202)



Maybe you are also interested in:

CP-D primary switch mode power supplies p.6/67

TM-S single phase control and safety transformers, primary 230-400 V ±15

Rated power	Secondary voltage	Bbn 8012542	Order details		Price 1 piece	Weight 1 piece	Pack unit
VA	V a.c.	EAN	Type code	Order code		kg	pc.
50	12-24	368939	TM-S 50/12-24 P	2CSM236893R0801		1.1	1
100	12-24	071631	TM-S 100/12-24 P	2CSM207163R0801		2	1
160	12-24	020738	TM-S 160/12-24 P	2CSM202073R0801		3	1
200	12-24	600435	TM-S 200/12-24 P	2CSM260043R0801		3.2	1
250	12-24	601135	TM-S 250/12-24 P	2CSM260113R0801		3.6	1
320	12-24	600633	TM-S 320/12-24 P	2CSM260063R0801		4.4	1
400	12-24	601036	TM-S 400/12-24 P	2CSM260103R0801		5.5	1
630	12-24	600534	TM-S 630/12-24 P	2CSM260053R0801		7.8	1
1000	12-24	600930	TM-S 1000/12-24 P	2CSM260093R0801		13.2	1
1600	12-24	600831	TM-S 1600/12-24 P	2CSM260083R0801		21.2	1
2000	12-24	600732	TM-S 2000/12-24 P	2CSM260073R0801		25.5	1
2500	12-24	046639	TM-S 2500/12-24 P	2CSM204663R0801		26.8	1
50	24-48	046530	TM-S 50/24-48 P	2CSM204653R0801		1.1	1
100	24-48	046431	TM-S 100/24-48 P	2CSM204643R0801		2	1
160	24-48	046332	TM-S 160/24-48 P	2CSM204633R0801		3	1
250	24-48	046837	TM-S 250/24-48 P	2CSM204683R0801		3.2	1
320	24-48	046738	TM-S 320/24-48 P	2CSM204673R0801		3.6	1
400	24-48	046134	TM-S 400/24-48 P	2CSM204613R0801		4.4	1
630	24-48	046035	TM-S 630/24-48 P	2CSM204603R0801		5.5	1

6

TM-I single phase control and isolating transformers, primary 230-400 V ±15

Rated power	Secondary voltage	Bbn 8012542	Order details		Price 1 piece	Weight 1 piece	Pack unit
VA	V a.c.	EAN	Type code	Order code		kg	pc.
50	115-230	045830	TM-I 50/115-230 P	2CSM204583R0801		1.1	1
100	115-230	011231	TM-I 100/115-230 P	2CSM201123R0801		2	1
160	115-230	045335	TM-I 160/115-230 P	2CSM204533R0801		3	1
200	115-230	045137	TM-I 200/115-230 P	2CSM204513R0801		3.2	1
250	115-230	045038	TM-I 250/115-230 P	2CSM204503R0801		3.6	1
320	115-230	044932	TM-I 320/115-230 P	2CSM204493R0801		4.4	1
400	115-230	010739	TM-I 400/115-230 P	2CSM201073R0801		5.5	1
630	115-230	044239	TM-I 630/115-230 P	2CSM204423R0801		7.8	1
1000	115-230	044130	TM-I 1000/115-230 P	2CSM204413R0801		13.2	1
1600	115-230	044031	TM-I 1600/115-230 P	2CSM204403R0801		21.2	1
2000	115-230	043836	TM-I 2000/115-230 P	2CSM204383R0801		25.5	1
2500	115-230	043638	TM-I 2500/115-230 P	2CSM204363R0801		26.8	1

Accessories

	Bbn 8012542	Order details		Price 1 piece	Weight 1 piece	Pack unit
	EAN	Type code	Order code		kg	pc.
Mounting bracket for DIN rail (up to 160 VA)	010333	TM-C-DIN	2CSM201033R0801		0.10	10

Command and signalling

TS-C safety isolating transformers for general use



TS 25 C



TS 63 C

Technical features		TS 25 C	TS 40 C	TS 63 C
Primary rated voltage Un	[V]	230 a.c.	230 a.c.	230 a.c.
Secondary rated voltage Un	[V]	12 - 24 V a.c.	12 - 24 V a.c.	12 - 24 V a.c.
Rated frequency	[Hz]	50/60	50/60	50/60
Rated power (continuous use)	[VA]	25	40	63
Power loss	[W]	5	10	16,7
Modules	[No.]	4	4	5
Standards		IEC/EN 61558-2-6		
Approvals		IMQ, VDE, GOST		

TS-C safety isolating transformers for general use

These transformers are non-inherently short-circuit proof. In fact they are equipped with a thermal protective device which automatically restores the power when the transformer is sufficiently cooled down. So even during an overload or a short-circuit they maintain their temperature below the specified limits and they continue functioning after the fault's removal.

They are ideal for supplying permanent power to meters, auxiliary electronic devices (e.g. measurement, video-entry phone systems, BUS communication) and circuits with safety extremely-low voltage (SELV) for bathrooms and showers, lighting, fountains, electro-medical devices and suchlike. One important feature of these new devices is that they take up very little space in the 4-module size for the 25 and 40 VA versions and the 5-module size for the 63 VA version.

Rated power (continuous)	Secondary rated voltage	Bbn 8012542	Order details		Price 1 piece	Weight 1 piece	Pack unit
VA	V	EAN	Type code	Order code		kg	pc.
25	12-24	928508	TS 25/12-24 C	2CSM251043R0811		0.920	1
40	12-24	928607	TS 40/12-24 C	2CSM401043R0811		1.100	1
63	12-24	928706	TS 63/12-24 C	2CSM631043R0811		1.150	1

Where to find more:

Technical Details for Modular Transformers p.10/249
Worldwide Marks and Approvals of MDRCs p.11/96

Maybe you are also interested in:

CP-D primary switch mode power supplies p.6/67

Command and signalling TM bell transformers



TM 15/12



TM 40/12

Technical characteristics		
Rated primary voltage Un	[V]	230 a.c.
Rated secondary voltage Un	[V]	4, 8, 12, 24
Rated frequency	[Hz]	50/60
Rated power (discontinuous)	[VA]	10, 15, 30, 40
Power loss	[W]	1...4
Modules	[No.]	2 (TM10, TM15), 3 (TM30, TM40)
Cable section (Ø min/max)	[mm ²]	1.5 / 10
Tightening torque	[Nm]	1
Protection degree		IP 20
Reference standards		IEC/EN 61558-2-8
Approvals		GOST, IMQ (TM10, TM15, TM30)

TM fail safe bell transformers

These transformers, with safety extremely-low voltage secondary (SELV), are suitable for loads that require a discontinuous supply, and in particular doorbells and chimes.

Fail safe operation and excellent safety are assured thanks to the perfect isolation and separation between the primary and secondary circuits.

6

Maximum rated power a (discontinuous) VA	Secondary voltage rating V c.a.	Bbn 8012542 EAN	Order details		Price 1 piece	Weight 1 piece kg	Pack unit pc.
			Type code	Order code			
10	4-8-12	367109	TM10/12	2CSM101021R0801		0.300	6
10	12-24	367208	TM10/24	2CSM101041R0801		0.300	6
15	4-8-12	367307	TM15/12	2CSM151021R0801		0.300	6
15	12-24	367406	TM15/24	2CSM151041R0801		0.300	6
30	4-8-12	367505	TM30/12	2CSM301021R0801		0.450	4
30	12-24	367604	TM30/24	2CSM301041R0801		0.450	4
40	4-8-12	367703	TM40/12	2CSM401021R0801		0.450	4
40	12-24	367802	TM40/24	2CSM401041R0801		0.450	4

① See diagrams below for the RMS power on each secondary output

Where to find more:

Technical Details for Modular Transformers p.10/249

Worldwide Marks and Approvals of MDRCs p.11/96

Maybe you are also interested in:

CP-D primary switch mode power supplies p.6/67

Command and signalling

TS bell transformers



TS 8/8

2CSC40089P0201



TS 8/12 SW

2CSC40089P0201



TS 24/8-12-24

2CSC40089P0201

Technical characteristics		
Rated voltage Un primary	[V]	230 a.c.
Rated voltage Un secondary	[V]	4, 8, 12, 24
Rated frequency	[Hz]	50/60
Rated power (discontinuous)	[VA]	10, 15, 30, 40
Power loss	[W]	1...4
Modules	[No.]	2 (TS8,TS16), 3(TS24)
Cable section (Ø min/max)	[mm ²]	1.5 / 10
Tightening torque	[Nm]	1
Protection degree		IP 20
Reference standards		IEC/EN 61558-2-8
Approvals		VDE, GOST

TS non-inherently short-circuit proof bell transformers

These transformers, with safety extremely-low voltage secondary (SELV), are suitable for driving loads that call for a discontinuous supply, and in particular doorbells and chimes. In addition to perfect isolation and separation between the primary and secondary circuits, the TS transformers have a thermal protection device integrated into the secondary that makes them resistant to short circuit currents (non-inherently short-circuit proof).

In addition, the TS8/SW series is equipped with a switch for controlling loads connected to the secondary.

Maximum rated power a (discont.) VA	Secondary voltage rating V c.a.	Switch 0-1	Bbn 8012542 EAN	Order details		Price 1 piece	Weight 1 piece kg	Pack unit pc.
				Type code	Order code			
8	8		368007	TS8/8	2CSM081301R0811		0.355	6
8	12		368106	TS8/12	2CSM081401R0811		0.355	6
8	24		368205	TS8/24	2CSM081501R0811		0.355	6
8	8	■	368304	TS8/8 SW	2CSM081302R0811		0.277	6
8	12	■	368403	TS8/12 SW	2CSM081402R0811		0.277	6
8	4-6-8	■	368601	TS8/4-6-8 SW	2CSM081012R0811		0.280	6
8	4-8-12	■	368700	TS8/4-8-12 SW	2CSM081022R0811		0.280	6
16	8		368809	TS16/8	2CSM161301R0811		0.355	6
16	12		368908	TS16/12	2CSM161401R0811		0.355	6
16	24		369004	TS16/24	2CSM161501R0811		0.330	6
16	4-6-8		369103	TS16/4-6-8	2CSM161011R0811		0.333	6
16	4-8-12		369202	TS16/4-8-12	2CSM161021R0811		0.333	6
24	4-8-12		369301	TS24/4-8-12	2CSM241021R0811		0.465	4
24	8-12-24		369400	TS24/8-12-24	2CSM241031R0811		0.465	4

① See diagrams below for the RMS power on each secondary output

Where to find more:

Technical Details for Modular Transformers p.10/249
Worldwide Marks and Approvals of MDRCs p.11/96

Maybe you are also interested in:

CP-D primary switch mode power supplies p.6/67

Command and signalling

SM, RM, TSM, TSR bells and buzzers



SM 1-230



TSM

Technical characteristics		SM1-12, RM1-12	SM1-230, RM1-230	SM2-12, RM2-12	SM2-24, RM2-24	SM2-230, RM2-230	TSM, TSR
Rated Voltage Un	[V c.a.]	8-12	230	12	24	230	230
Rated frequency	[Hz]	50	50	50	50	50	50
Power consumption	[VA]	2,5-6,5	4,5	4,5	4,5	4,5	5,5
Sound level at 1 meter	Bell [dB]	82	82	82	82	82	80
	Buzzer [dB]	80	80	80	80	80	70
	Three-tones [dB]						84
Max permanent working time		15 min	15 min	12 h [Ⓢ]	12 h a	12 h a	TSM: 1 min TSR: 5 min
Max cable cross-section	[mm ²]	10	10	10	10	10	10
Mounting position		vertical only					
Protection degree		IP20-IP40, switchboard mounting					
Modules	[No.]	1	1	1	1	1	2

6

[Ⓢ] Continuitive work for more than 12 hours could affect the sound level

Bells and buzzers

The range of bells and buzzers includes modular versions for discontinuous use SM1, RM1, TSM and TSR, suitable for acoustic signalling in residential and commercial sectors, and versions for continuous use SM2 and RM2, which are able to operate continuously for up to 12 hours while maintaining the quality and level of the sound. RM2 and SM2 are dedicated to specific applications such as acoustic signalling in the industry, alarms notification, supervision and intensive use (schools, factories etc...). TSM and TSR versions also include a transformer: the input is 230V a.c. and the bell is supplied in 12 or 24 V.

SM electro-mechanical modular bells

Rated voltage	Use	Bbn 8012542	Order details		Price 1 piece	Weight 1 piece	Pack unit
V AC		EAN	Type code	Order code		kg	pc.
8/12	Discontinuous	886204	SM1-12	2CSM111000R0821		0.076	12
230	Discontinuous	886303	SM1-230	2CSM131000R0821		0.076	12
12	Continuous	886600	SM2-12	2CSM112000R0821		0.076	12
24	Continuous	886709	SM2-24	2CSM122000R0821		0.076	12
230	Continuous	886808	SM2-230	2CSM132000R0821		0.076	12

RM electro-mechanical modular buzzers

Rated voltage	Use	Bbn 8012542	Order details		Price 1 piece	Weight 1 piece	Pack unit
V AC		EAN	Type code	Order code		kg	pc.
8/12	Discontinuous	886419	RM1-12	2CSM211000R0821		0.076	12
230	Discontinuous	886518	RM1-230	2CSM231000R0821		0.076	12
12	Continuous	886907	RM2-12	2CSM212000R0821		0.076	12
24	Continuous	887003	RM2-24	2CSM222000R0821		0.076	12
230	Continuous	887102	RM2-230	2CSM232000R0821		0.076	12

Where to find more:
Worldwide Marks and Approvals of
MDRCs p. 11/96

Command and signalling

SM, RM, TSM, TSR bells and buzzers



TSR

TSM modular electronic bell (two-tones) + transformer included						
Rated voltage	Use	Bbn 8012542	Order details		Price 1 piece	Pack unit
V AC		EAN	Type code	Order code	kg	pc.
230	Discontinuous	007005	TSM	2CSM100000R0841		6

TSR bell + buzzer + transformer included						
Rated voltage	Use	Bbn 8012542	Order details		Price 1 piece	Pack unit
V AC		EAN	Type code	Order code	kg	pc.
230	Discontinuous	369608	TSR	2CSM100000R0831		1

Command and signalling

CP-D primary switch mode power supplies



CP-D

Technical features								
		CP-D 12/0.83	CP-D 12/2.1	CP-D 24/0.42	CP-D 24/1.3	CP-D 24/2.5	CP-D 24/4.2	
Input circuit								
Rated voltage	[V] a.c.	100-240						
Voltage range	[V] a.c.	90-264						
	[V] d.c.	120-370						
Frequency range	[Hz]	47-63						
Backup battery for voltage drop	[ms]	>30	>30	>30	>30	>60	>60	
Built-in fuse rating (250 V AC)	[A]	1	2	1	2	2	3,15	
Power dissipation	at 110 V AC	[mA]	200	502	184	600	1120	1800
	at 230 V AC	[mA]	128.3	277	120.6	344	660	900
Starting current (max 3ms)	[A]	30	50	30	50	60	60	
Output circuit								
Rated voltage	[V] d.c.	12	12	24	24	24	24	
Output voltage tolerance		±1%						
Adjustable output voltage		12-14 V d.c.			24-28 V d.c.	24-28 V d.c.	24-28 V d.c.	
Rated current	[A]	0.83	2.10	0.42	1.30	2.50	4.20	
Rated power	[W]	10	30	10	30	60	100	
Resistance to reverse feed		18 V	18 V	35 V	35 V	35 V	35 V	
		d.c. /	d.c. /	d.c. /	d.c. /	d.c. /	d.c. /	
		1 s	1 s	1 s	1 s	1 s	1 s	
Parallel connection		Not allowed						
Series connection		Allowed, to increase output voltage						
Output circuit: no-load, overload, and short-circuit behaviour								
Output curve		U/I Curve a						
Behaviour in case of short-circuit/ overload		Operation with power limitation						
Power limit in case of short-circuit	[A]	1.4	5.9	0.78	4.2	6.05	11.5	
No-load behaviour		Stable operations						
LED status indicator								
Green LED (DC ON)		Output voltage supplied correctly						
Red LED (DC Low)		Output voltage too low						
Operating temperature	[°C]	-10...+70						
Output current derating for temperature of 60°C < ta < 70°C		2.5% / degree						
Marks		UR, CSA, CCC, GOST						

6

① refer to curves in technical details on page 10/233

Maybe you are also interested in:
EPD24 - Electronic Protection Devices for use behind 24 V DC Switch Mode Power Supplies p.5/72

Command and signalling

CP-D primary switch mode power supplies



CP-D 12/0.83,
CP-D 24/0.42



CP-D 12/2.1
CP-D 24/1.3



CP-D 24/2.5



CP-D 24/4.2

Primary switch mode power supplies

- Output voltages 12 V, 24 V
- Adjustable output voltages (devices > 10 W)
- Output currents 0.42 A / 0.83 A / 1.3 A / 2.1 A / 2.5 A / 4.2 A
- Power range 10 W, 30 W, 60 W, 100 W
- Wide range input 100-240 V AC (90-264 V AC, 120-370 V DC)
- High efficiency of up to 89 %
- Low power dissipation and low heating
- Free convection cooling (no forced cooling with ventilators)
- Ambient temperature range during operation -10...+70 °C
- Open-circuit, overload and short-circuit stable
- Integrated input fuse
- U/I characteristic (fold-forward behaviour at overload – no switch-off)
- LEDs for status indication
- Light-grey enclosure in RAL 7035

Rated input voltage	Rated output voltage/current	Bbn	Order details		Price 1 piece	Weight 1 piece	Pack unit
V	V / A	EAN	Type code	Order code		kg	pc.
100-240 V AC	12 V DC / 2.1 A		CP-D 12/2.1	1SVR 427 043 R1200		1	0.19/0.41
100-240 V AC	24 V DC / 0.42 A		CP-D 24/0.42	1SVR 427 041 R0000		1	0.06/0.13
100-240 V AC	24 V DC / 1.3 A		CP-D 24/1.3	1SVR 427 043 R0100		1	0.19/0.41
100-240 V AC	24 V DC / 2.5 A		CP-D 24/2.5	1SVR 427 044 R0200		1	0.25/0.55
100-240 V AC	24 V DC / 4.2 A		CP-D 24/4.2	1SVR 427 045 R0400		1	0.32/0.71





Maybe you are also interested in:
EPD24 - Electronic Protection De-
vices for use behind 24 V DC Switch
Mode Power Supplies p.5/72

Command and signalling

Modular sockets selection table

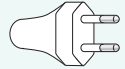
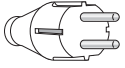
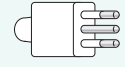
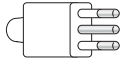
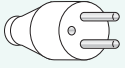
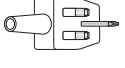
Series selection

For further information about sockets selection by country please see page 11/169

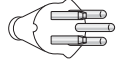
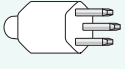
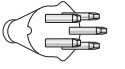
		M1175	M1173	M1170	M1174	M1363	M1176	M2071	M1011
	EU 10A	■	■	■	■				■
	Schuko 10 A / 16 A	■	■	■					
	Italian 10 A		■	■					
	Italian 16 A			■					
	French 10 A / 16 A	Pluggable but not earthed	Pluggable but not earthed	Pluggable but not earthed	■				
	British 13 A					■			
	Australian 10 A / 15 A						■		
	Argentine 10 A							■	
	Swiss								■
									■
									■
									■

6

Command and signalling

Modular sockets selection table

Model selection

		■ RAL 7035	■ RAL 6029	■ RAL 3000	■ RAL 7012
German Schuko Standard					
	M1175				
		2CSM210000R0721	2CSM220000R0721	2CSM230000R0721	2CSM240000R0721
	M1175-L	 Indicator light			
		2CSM212000R0721	2CSM222000R0721	2CSM232000R0721	2CSM242000R0721
	M1175-FL	 Indicator light	 Fuse 6.3 A aM		
		2CSM214000R0721	2CSM224000R0721	2CSM234000R0721	2CSM244000R0721
	M1175-C	 Cover IP30			
		2CSM211000R0721	2CSM221000R0721	2CSM231000R0721	2CSM241000R0721
Italian P30 standard					
	M1173				
		2CSM110000R0701	2CSM120000R0701	2CSM130000R0701	2CSM140000R0701
	M1173-L	 Indicator light			
		2CSM112000R0701	2CSM122000R0701	2CSM132000R0701	2CSM142000R0701
Italian dual standard					
	M1170				
		2CSM210000R0701	2CSM220000R0701	2CSM230000R0701	2CSM240000R0701
French Standard					
	M1174	2CSM110000R0711	2CSM110000R0711		



6

■ RAL 7035 ■ RAL 6029 ■ RAL 3000 ■ RAL 7012

British Standard



	M1363	2CSM259343R0721	2CSM259343R0721			
	M1363-L	 Indicator light	2CSM258163R0721			

Australian Standard





	M1176-L10	10 A	 Indicator light	2CSM256983R0721		
	M1176-L15	15 A	 Indicator light	2CSM259473R0721		

6

Argentine Standard

	M2071-L10	10 A	 Indicator light	2CSM257783R0721		
------------------------------------------------------------------------------------	-----------	------	-------------------------------------------------------------------------------------------------------	-----------------	--	--

Swiss standard SEV 2011

	M1011-T13	Single-phase 10 A Type 13	2CSM220685R0721			
	M1011-T23	Single-phase 16 A Type 23	2CSM220695R0721			
	M1011-T15	Three-phase 10 A Type 15	2CSM220705R0721			
	M1011-T25	Three-phase 16 A Type 25	2CSM220715R0721			

Command and signalling

Modular sockets



Modular sockets

Technical specifications									
Rated voltage Un	[V]	250 a.c.							
Rated current In	[A]	16 (M1170, M1173, M1174, M1175), 13 (M1363), 10 (M1176-L10, M2071-L10), 15 (M1176-L15)							
Rated frequency	[Hz]	50/60							
Power loss	[W]	0,6							
Modules	[No.]	2.5 for M117x 3 for M1011, M1363							
Safety shutters		yes, on entire range							
Cable section (ø min./max.)	[mm ²]	2.5 / 16							
Tightening torque	[Nm]	1.2							
Temperature	storage	[°C]	-40 ... +70						
	operating	[°C]	-25 ... +35						
Protection degree		IP20 / IP30 versions with cover, when cover is closed							
		M1011	M1175	M1173	M1170	M1174	M1363	M1176	M2071
Reference standards		SEV 1011	DIN VDE 0620- 1	CEI 23-50		NF C 61 314	BS1363	AS NZN 3112	IRAM 2071
		SEV	VDE, GOST	IMQ, GOST	GOST	LCIE, CEBEC, GOST	BSI	RCM	IRAM

Indicator light technical specifications

Type		fluorescent torpedo-shaped lamp
Function		Indication of power supply presence (M1363, M1173, M1175) Indication of plug inserted + power supply presence (M1176, M2071)
Light colour		green
Power consumption	[W]	0.25

Fuse technical specifications

Type		5 x 20 mm up to 6.3 A aM
Function		phase protection
Breaking capacity	[A]	1500
Reference standard		IEC EN 60127

Where to find more:

Technical Details for Modular Sockets

p.10/234

Worldwide Marks and Approvals

p.11/96

Frequently asked question - FAQ:

Why do modular sockets not have the CE mark?

ABB modular sockets are not "CE" marking as this is not required by European Directive 2005/95/EC, which indicates (Annex II) that products identified as "Domestic plugs and sockets" are out of the scope of the European directive.

A complete list of answers is available in the „Question and Answer“ section of Modular Sockets brochure (code 2CSC446011B0201)



M1175



M1175-C



M1175-C



M1175-FL



M1173



M1173-G,
M1173-R,
M1173-B

Modular sockets

Modular sockets allow the connection of devices, tools or electrical and electronic non modular equipments in civil and industrial electrical switchboards.

The range is composed by standard versions as well as upgraded versions with additional features as light indicator, protection fuse, cover and coloration.

In addition to the grey-coloured (RAL 7035) version there are three other colours which are useful to indicate specific socket uses:

- green (RAL 6029), for example to indicate a dedicated upstream protection device;
- red (RAL 3000), for example to indicate an UPS group that allows the socket to be used if the main power supply fails;
- black (RAL 7012), to match with industrial and automation devices.

German Shuko standard modular sockets

Color	Bbn 8012542	Order details		Price 1 piece	Weight 1 piece kg	Pack unit pc.
	EAN	Type code	Order code			
grey	027850	M1175	2CSM21000R0721		0,120	4
green	027959	M1175-G	2CSM22000R0721		0,120	4
red	028055	M1175-R	2CSM23000R0721		0,120	4
black	028154	M1175-B	2CSM24000R0721		0,120	4
grey with cover	029052	M1175-C	2CSM21100R0721		0,140	4
green with cover	029151	M1175-C-G	2CSM22100R0721		0,140	4
red with cover	029250	M1175-C-R	2CSM23100R0721		0,140	4
black with cover	029359	M1175-C-B	2CSM24100R0721		0,140	4

German Shuko standard modular sockets with integrated indicator light and fuse

Color	Bbn 8012542	Order details		Price 1 piece	Weight 1 piece kg	Pack unit pc.
	EAN	Type code	Order code			
grey with light	028253	M1175-L	2CSM21200R0721		0,140	4
green with light	028352	M1175-L-G	2CSM22200R0721		0,140	4
red with light	028451	M1175-L-R	2CSM23200R0721		0,140	4
black with light	028550	M1175-L-B	2CSM24200R0721		0,140	4
grey with light and fuse	028659	M1175-FL	2CSM21400R0721		0,160	4
green with light and fuse	028758	M1175-FL-G	2CSM22400R0721		0,160	4
red with light and fuse	028857	M1175-FL-R	2CSM23400R0721		0,160	4
black with light and fuse	028956	M1175-FL-B	2CSM24400R0721		0,160	4

Italian P30 standard modular sockets

Color	Bbn 8012542	Order details		Price 1 piece	Weight 1 piece kg	Pack unit pc.
	EAN	Type code	Order code			
grey	004103	M1173	2CSM11000R0701		0,120	4
green	026754	M1173-G	2CSM12000R0701		0,120	4
red	026853	M1173-R	2CSM13000R0701		0,120	4
black	026952	M1173-B	2CSM14000R0701		0,120	4

Italian P30 standard modular sockets with integrated indicator light

Command and signalling

Modular sockets



M1170



M1174



M1363

Color	Bbn 8012542	Order details		Price 1 piece	Weight 1 piece kg	Pack unit pc.
	EAN	Type code	Order code			
grey with light	027058	M1173-L	2CSM112000R0701		0,140	4
green with light	027157	M1173-L-G	2CSM122000R0701		0,140	4
red with light	027256	M1173-L-R	2CSM132000R0701		0,140	4
black with light	027355	M1173-L-B	2CSM142000R0701		0,140	4

Italian dual standard modular sockets

Color	Bbn 8012542	Order details		Price 1 piece	Weight 1 piece kg	Pack unit pc.
	EAN	Type code	Order code			
grey	027454	M1170	2CSM210000R0701		0,120	4
green	027553	M1170-G	2CSM220000R0701		0,120	4
red	027652	M1170-R	2CSM230000R0701		0,120	4
black	027751	M1170-B	2CSM240000R0701		0,120	4

French standard modular sockets

Color	Bbn 8012542	Order details		Price 1 piece	Weight 1 piece kg	Pack unit pc.
	EAN	Type code	Order code			
grey	006602	M1174	2CSM110000R0711		0,140	4

British standard modular sockets.

Color	Bbn 8012542	Order details		Price 1 piece	Weight 1 piece kg	Pack unit pc.
	EAN	Type code	Order code			
grey	593430	M1363	2CSM259343R0721		0,140	4
grey with light	581635	M1363-L	2CSM258163R0721		0,140	4

Where to find more:

Technical Details for Modular Sockets

p.10/234

Worldwide Marks and Approvals

p.11/96

Frequently asked question - FAQ:

Why do modular sockets not have the CE mark?

ABB modular sockets are not "CE" marking as this is not required by European Directive 2005/95/EC, which indicates (Annex II) that products identified as "Domestic plugs and sockets" are out of the scope of the European directive.

A complete list of answers is available in the „Question and Answer“ section of Modular Sockets brochure (code 2CSC446011B0201)



2CSC40759F001

M1176-L10



2CSC40759F001

M2071-L10



2CSC40040F013

M1011-T13



2CSC40041F013

M1011-T23



2CSC40042F013

M1011-T15



2CSC40043F013

M1011-T25

Australian/New Zealand standard modular sockets.

Color		Bbn 8012542	Order details		Price 1 piece	Weight 1 piece	Pack unit
		EAN	Type code	Order code		kg	pc.
■ grey with light	10A	569831	M1176-L10	2CSM256983R0721		0,110	4
■ grey with light	15A	594734	M1176-L15	2CSM259473R0721		0,110	4

Argentine standard modular sockets.

Color		Bbn 8012542	Order details		Price 1 piece	Weight 1 piece	Pack unit
		EAN	Type code	Order code		kg	pc.
■ grey with light	10A	577836	M2071-L10	2CSM257783R0721		0,110	4

Swiss standard modular sockets

The M1011 series, with SEV certification, allows to plug four types of swiss standard plugs, single- and three-phase e with currents up to 10 A or 16 A. They can be mounted on DIN rail or Smisline rails without supply connection.

Color		Bbn 8012542	Order details		Price 1 piece	Weight 1 piece	Pack unit
		EAN	Type code	Order code		kg	pc.
■ grey	Single-phase 10 A	206873	M1011-T13	2CSM220685R0721		0.140	4
■ grey	Single-phase 16 A	206972	M1011-T23	2CSM220695R0721		0.140	4
■ grey	Three-phase 10 A	207078	M1011-T15	2CSM220705R0721		0.170	4
■ grey	Three-phase 16 A	207177	M1011-T25	2CSM220715R0721		0.170	4

Command and signalling

MA1-8001 DIN rail adapter



MA1-8001



MA1-8121

MA1-8001 DIN rail adapter

Through an appropriate kit, this product born with the Modular Range of Pilot devices is the perfect case for alongside Ø 22 mm pilot devices with “System pro M compact” products. The Ø 22 mm pilot devices can now find a greater use even within distribution or automation switchboards with modular panels maintaining an high aesthetic level.

The MA1-8001 offers a lot of advantages:

- Fast and easy mounting
- Simple wiring
- Simple maintenance
- Less depth of operators
- Perfect harmony alongside the “System pro M compact” products

Using MA1-8001 it's possible to put together “System pro M compact” products with LED pilot light, potentiometer, key selectors , toggle switches, selector switches, push- buttons, mushroom buttons and emergency stop, illuminated or not.

For detailed description of the industrial devices that can be installed using this kit, see technical catalogue 1SFC151003C0201

Color	Bbn	Order details		Price	Weight	Pack
	7320500	Type code	Order code	1 piece	1 piece	unit
	EAN				kg	pc.
DIN rail adapter KIT (2 modules) ① ②	357880	MA1-8001	1SFA611920R8001		0.023	1
DIN rail adapter (2 modules) ①	357702	MA1-8131	1SFA611920R8131		0.020	10

① Can be used only with Modular range pilot devices units; it cannot be used with the old CBK range or Compact range products.

② KIT includes one Din rail adapter, one empty block and 2 pins

Technical notes

- To assemble the new housing with push-buttons, selector switch and indicator lamps, contact blocks and lamp blocks for DIN rails must be used.
- The MCBH-00 holder is not necessary, because the housing hooks directly to contact blocks.
- To line up with “System pro M compact” products, a maximum of 3 blocks must be used.
- In the configuration with 3 contacts, it is advisable to use securing pins to make the blocks more solid.
- In making up actuators or indicator lamps that use a single contact, one or two MDB-2 empty blocks must be used.

Index

D Line digital time switches	7/6
AT electro-mechanical time switches	7/8
AT2 electro-mechanical time switches	7/9
ATP electro-mechanical time switches	7/10
E 232 staircase lighting time-delay switches	7/12
E 234 electronic timers	7/16
T line twilight switches	7/18
TWA twilight switches	7/23
THS modular thermostats	7/25
ATT GSM modules	7/27
CL logic relays, display system	7/29
E 450 priority switches	7/35
RAL overload relays	7/36
LSS1/2 load shedding switch	7/37
E 235 mains disconnection relays	7/38
LEE 230 extractable power failure signalling lamp	7/39
USB Modular DIN rail device	7/40

D Line. Simply precise

An ideal range for automating the functions of the installation

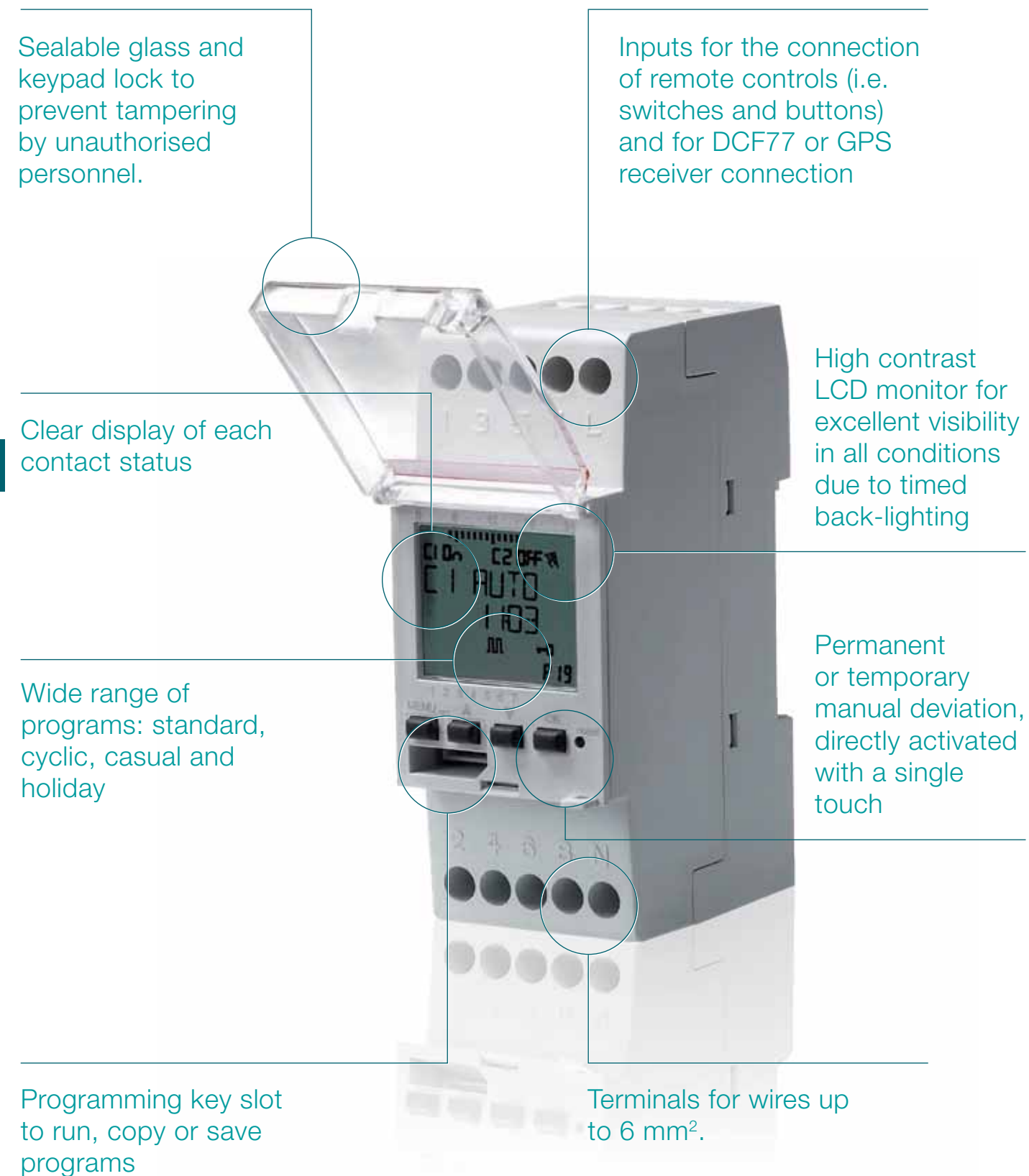



- Wide range of programs: standard, cyclic, casual and holiday
- Permanent or temporary manual deviation, directly activated with a single touch
 - Graphical display of the complete sequence of switchings provided by the program in memory, for each of the channels in the day in question
 - External inputs for the connection of one or more remote commands, for example: switches or buttons
 - 64 memory locations
 - Accuracy of $\pm 0,5$ seconds/day
 - Switching change solar time/daylight saving time
 - Load reserves for 6 years (lithium battery)

Programming key D KEY allows to run a program in EMD external memory automatically, to save the programs in the clock or created by the D SW programming software, on the D KEY external memory and viceversa. Furthermore, the holiday programs can be loaded and unloaded on D KEY.

7



D line time switches' programming can be executed directly on your PC thanks to D SW software that lets you quickly, simply and easily create complex programs from your desktop. Indeed, it is possible to transfer the program to the memory unit and then copy it on multiple devices, avoiding any errors in reprogramming. Once created, the program can be printed or saved to file as pdf.

Time synchronization via DCF77 or GPS antennas. The D DCF77 antenna receives scheduled messages transmitted by the atomic clock installed c/o Mainflingen (Germany), near Frankfurt. Thanks to this signal, the time switches are automatically set to: hour, date and proper daylight saving time. The D GPS antenna receives time from the Global Positioning System, providing an accurate location and time information for an unlimited number of people in all weathers, day or night, anywhere in the world; time is derived from different sources simultaneously that allow the clock to compensate for propagation delays.

Control and automation

D Line digital time switches



D Line

Technical specifications D Line		D1	D1 PLUS	D1 SYNCHRO	D2	D2 PLUS	D2 SYNCHRO
Rated voltage	[V]	230 AC ± 10%					
Rated pulsating voltage	[kV]	4					
Contact type		Contact relay in free exchange from potential					
Programming key		-	■	■	-	■	■
External input		-	■	-	-	■	-
DCF77 antenna		-	-	■	-	-	■
GPS antenna		-	-	■	-	-	■
Programming software		-	■	■	-	■	■
250 V contact capacity							
Ohm loads	[A]	16	16				
Inductive loads	[A]	10	2				
Rated frequency	[Hz]	50-60					
Time base		quartz					
Minimum switching	[sec.]	1					
Max programs per cycle	[n°]	64 (can be coupled in day blocks)					
Load reserve	[year]	6 from the first start-up (lithium battery)					
External input	[n°]	1			2		
Activity suspension		From 1 day to 12 months					
Operating precision	[sec./day]	± 0.5					
Max. dissipated power	[VA]	6.5			7.8		
Max. switch power	[VA]	3500					
Incandescent lamps	[W]	3000					
Non-rephased fluorescent lamps	[W]	1100					
Fluorescent tube lamps rephased in parallel	[W]	900					
Fluorescent tube lamps with electronic reactor	[W]	7 ÷ 23 (max. 23 lamp.)					
Fluorescent tube LP power rephased in series	[W]	1100					
Protection grade	[IP]	20					
Max. terminal section	[mm²]	6					
Terminals		In positive safety with captive screw					
Tightening torque	[Nm]	0.5					
Installation type		DIN rail					
Operating temperature	[°C]	-5 ... +55					
Storage temperature	[°C]	-10 ... +65					
Modules	[n°]	2					
Reference standards		EN 60730-1; EN 60730-2-7					



1CSC400002D0211

D1

Technical features Accessories for D Line

		D DCF77	D GPS
Rated supply voltage	[V]	230 AC ±20%	
Rated frequency	[Hz]	50/60	
Power loss	[W]	0.1	2
Operating temperature	[°C]	-10...+70	-10...+40
Storage temperature	[°C]	-30...+90	-40...+85
Power consumption	[VA]	9.2	2
Time of the signal		1 sending / min.	min 30 sendings/hour; max 50 sendings/hour
Protection degree	[IP]	65	65
Max. number of connected devices	[No.]	10	10
Max. wiring length	[m]	1000	1000
Terminal size for cable	[mm²]	0.5...2.5	0.5...2.5
Mounting		pole/wall	pole/wall

Technical features D 365 Line

		D 365	D 365 CE	D 365 LAN
Rated voltage Un	[V AC]	230	110..230	230
Contact type		2 NO/NC	2 NO/NC	-
Switching capacity	ohmic loads	[A]	16	16
	inductive loads	[A]	10	10
Rated frequency	[Hz]	50/60		
Power dissipation	[VA]	5		
Incandescent lamps	[W]	2600	2600	-
Halogen lamps	[W]	2600	2600	-
Compensated fluorescent lamps	[W]	1000	1000	-
Non-compensated fluorescent lamps	[W]	1000	1000	-
Time base		quartz	quartz	-
Minimum ON/OFF switching time	[sec.]	1	1	-
Max. no. of commands per cycle	[n°]	800	-	-
Pulse duration		1 sec ... 99 min	1 sec ... 99 min	-
Power reserve	[years]	10	-	-
Operating accuracy at 20 °C	[sec./day]	+1	+1	
Operating temperature	[°C]	-5...+55		
Ambient temperature	[°C]	-10...+55		
Degree of protection	[IP]	20		
Terminals		loss-proof screw		
Max. terminal cross-section	[mm²]	4		
Sealable		yes		
Installation type		on DIN rail		
Modules	[n°]	3	2	3
Standards		EN 60730-1		

7

Control and automation

D Line digital time switches



D1



D1 PLUS

Technical features Accessories for D 365 Line			
		D 365 DCF77	D 365 GPS
Rated voltage Un	[V]	230 AC	230 AC / 24 DC
Rated frequency	[Hz]	50/60	50/60
Power dissipation	[mW]	3	3
Ambient temperature	[°C]	-20...+60	-25...+70
Degree of protection	[IP]	54	54
Max. distance from programmer	[m]	3000	3000
Installation		pole/wall	pole/wall

D Line digital time switches

The unique design, with white backlit LCD display, and extreme ease of use with two lines of text menu and only four buttons, make D LINE ideal to automate the installation functions. Thanks to the innovative management of time vacation, the D Line digital time switches allow the exclusion of the normal weekly program in one or more periods of several years or between two different years.

The range includes 1 and 2 channel versions, equipped with large capacity internal battery to maintain operation without power supply and permanent memory EEPROM, to avoid the risk of program loss and to maintain the date and time settings in the event of power failure, irrespective of its duration.

The "Plus" version can transfer different type of program by using a D KEY to be quickly copied in No digital time switches, avoiding the errors due to future modification. The "SYNCHRO" version can be coupled to the D DCF77 antenna, that allows an automatic synchronization of the digital time switch with the Frankfurt DCF77 time signal, or can be coupled to the D GPS antenna to allow synchronization received from the Global Positioning System.

The D Line is particularly useful in environments and situations where user management is required with a time schedule flexible enough to predict or exclude activities according to time and day of week or month.

Channels no.	Bbn 8012542	Order details		Price 1 piece	Weight 1 piece	Pack unit
	EAN	Type code	Order code	kg	pc.	
1	587637	D1	2CSM258763R0621		0.140	1
1	575832	D1 PLUS	2CSM257583R0621		0.140	1
1	574934	D1 SYNCHRO	2CSM257493R0621		0.140	1
2	563136	D2	2CSM256313R0621		0.140	1
2	775836	D2 PLUS	2CSM277583R0621		0.140	1
2	773634	D2 SYNCHRO	2CSM277363R0621		0.140	1

Accessories for D Line digital time switches

Version	Bbn 8012542	Order details		Price 1 piece	Weight 1 piece	Pack unit
	EAN	Type code	Order code	kg	pc.	
Programming key	771432	D KEY	2CSM277143R0621		0.005	1
Programming software	999737	D SW	2CSM299973R0621		0.020	1
DCF77 antenna	999836	D DCF77	2CSM299983R0621		0.150	1
GPS antenna	999935	D GPS	2CSM299993R0621		0.150	1

Where to find more:

Worldwide Marks and Approvals of MDRCs p.11/96

Time, Staircase Lights, Twilight Switches and Thermostats brochure (code 2CSC440020B0201)



Frequently asked question - FAQ:

A complete list of answers is available in the „Question and Answer“ section of Time, Staircase Lights, Twilight Switches and Thermostats brochure (code 2CSC440020B0201)



You can find all ABB instruction manuals on www.abb.com/abblibrary/download-center



D 365



D 365 LAN



D 365 CE



D 365 GPS



D 365 DCF77



D 365 KEY

D Line yearly digital time switches

The D 365 yearly digital time switch, thanks to its extreme flexibility in use characterized by the extensive availability of 800 memory spaces and the possibility to manage up to 8 independent contacts, is especially suitable for managing small automated systems, allowing you to control multiple utilities or utility groups that require time differentiated commands, but with a common clock reference.

The backlit display provides a clear view even in the dark. The lithium battery, with a 6 year life, can be replaced thus extending the lifetime of the device. Like the weekly version, D 365 is equipped with various functions such as the impulse, cyclic, holiday, random, hour counter, countdown function, in addition to being able to maintain the hour and date synchronized with the hourly signal received by the DCF77 or GPS antenna.

Channels no.	Bbn 8012542	Order details		Price 1 piece	Weight 1 piece	Pack unit
	EAN	Type code	Order code		kg	pc.
2	569732	D 365	2CSM256973R0621		0,250	1

Accessories for D Line yearly digital time switches

D 365 yearly digital clocks can be programmed directly on your PC thanks to the programming software which makes it quick and easy to create programs. The program can in fact be either transferred to a D 365 KEY portable memory unit and then copied from there to multiple devices, thus avoiding reprogramming errors, or through the D 365 LAN module which, through the local network or internet, allows a PC to receive the program and then send it to the yearly time switch via the PowerLine communication protocol. Always using the programming software, you can use the digital clock as a conventional astronomical time switch. By defining the latitude and longitude of the geographical place of installation, it is possible to automatically control the circuit lighting based on sunrise and sunset times.

The D 365 CE extension channel unit, in 2 exchange contacts, is instead coupled to the D 365 yearly time switch to expand the number of contacts managed from 2 to a maximum of 8. The D 365 DCF77 antenna, used in conjunction with the device, enables it to be automatically synchronized with the official DCF77 Frankfurt time signal, broadcast via long wave radio, with a maximum range of about 2500 km from Frankfurt. The D 365 GPS antenna is available to ensure good coverage around the world in any weather condition. This antenna uses the synchronization received from the Global Positioning System and provides more precise values than terrestrial transmissions.

	Bbn 8012542	Order details		Price 1 piece	Weight 1 piece	Pack unit
	EAN	Type code	Order code		kg	pc.
Programming key	582830	D 365 KEY	2CSM258283R0621			1
Channel extension	594635	D 365 CE	2CSM259463R0621			1
LAN module	566038	D 365 LAN	2CSM256603R0621			1
DCF77 antenna	571032	D 365 DCF77	2CSM257103R0621			1
GPS antenna	593232	D 365 GPS	2CSM259323R0621			1

7

Control and automation

AT electro-mechanical time switches



AT1

Technical features		AT1	AT1-R	AT3	AT3-R	AT3-7R
Rated supply voltage	[V]	230 AC + 10%				
Contact type		1NO	1NO	1CO	1 CO	1CO
Switching capacity	resistive load	16 [A]				
	inductive load	4 [A]	4	3	3	3
Rated frequency	[Hz]	50-60				
Time base		quartz				
Minimum switching time	[min]	15	15	15	15	120
Max number of commands per cycle		96	96	96	96	84
Running reserve	[h]	-	200	-	200	200
Accuracy		± 1sec / 24h				
Power consumption	[VA]	0.5				
Max. switching power	[W]	4000				
Terminal size for cable	[mm ²]	4				
Terminals		loss-proof screw				
Tightening torque	[Nm]	1.2				
Mounting		on DIN rail				
Operating temperature	[°C]	-10...+55				
Storage temperature	[°C]	-10...+55	-10...+55	-20...+70	-10...+55	-10...+55
Modules		1	1	3	3	3
Reference standards		EN 60730-1 ; EN 60730-2-7				

AT electro-mechanical time switches

They control circuit opening and closing according to the scheduled program. Available both on daily and weekly version and equipped with a 16A contact, they can be set on the scheduled program or on the permanent ON function (ON-OFF only for three modules versions). The AT1-R, AT3-R and AT3-7R versions are equipped with a built-in battery, generally charged by the network voltage, which allows the devices to maintain the set time also in case of long (up to 200h) power supply failures. The products fit applications such as shop lighting systems, public buildings, schools, heating and irrigation systems and so forth.

Contacts	Running reserve	Version	Bbn 8012542 EAN	Order details Type code	Order code	Price 1 piece	Weight 1 piece kg	Pack unit pc.
1NO	-	daily	042051	AT1	2CSM204205R0601		0,095	1
1NO	200h	daily	042150	AT1-R	2CSM204215R0601		0,095	1
1CO	-	daily	042259	AT3	2CSM204225R0601		0,180	1
1CO	200h	daily	042358	AT3-R	2CSM204235R0601		0,180	1
1CO	200h	weekly	042457	AT3-7R	2CSM204245R0601		0,180	1

Where to find more:

Programming Details of Electro-mechanical Time Switches P.10/238
Worldwide Marks and Approvals of MDRCs p.11/96

Time, Staircase Lights, Twilight Switches and Thermostats brochure (code 2CSC440020B0201)



Frequently asked question - FAQ:

You can find all ABB instruction manuals on www.abb.com/abblibrary/ download center

Control and automation

AT2 electro-mechanical time switches



AT2



AT2-7R

Technical features			AT2	AT2-R	AT2-7R
Rated supply voltage	[V]		230 AC		
Contact type			1 CO		
Switching capacity	resistive load	[A]	16		
	inductive load	[A]	4		
Rated frequency	[Hz]		50-60		
Time base			quartz		
Minimum switching time	[min]		30	30	210
Max number of commands per cycle			48		
Running reserve	[h]		-	150	150
Accuracy			± 1sec / 24h		
Power consumption	[VA]		0.5		
Max. switching power	[W]		3500		
Terminal size for cable	[mm ²]		2.5		
Terminals			loss-proof screw		
Tightening torque	[Nm]		0.5		
Mounting			on DIN rail		
Operating temperature	[°C]		-10 ...+50		
Storage temperature	[°C]		-10 ...+50		
Modules			2		
Reference standards			EN 60730-1 ; EN 60730-2-7		

7

AT2 electro-mechanical time switches

The AT2 versions are particularly useful where there is the need to have a complete visibility of the programmable dial in only two modules. They control, as well as the AT1 and AT3 ones, circuit opening and closing according to a scheduled program and are available both on daily and weekly version with a 16A change-over contact. They can be set on the scheduled program or on permanent ON and the versions AT2-R and AT2-7R are equipped with a built-in battery, generally charged by the network voltage, which allows the devices to maintain the set time also in case of long (up to 150h) power supply failures. The products fit applications such as store lighting system, public buildings, schools, heating and irrigation systems and so forth.

Contacts	Running reserve	Version	Bbn 8012542 EAN	Order details Type code	Order code	Price 1 piece	Weight 1 piece kg	Pack unit pc.
1 CO	-	daily	041054	AT2	2CSM204105R0601		0,118	1
1 CO	150h	daily	041153	AT2-R	2CSM204115R0601		0,118	1
1 CO	150h	weekly	041252	AT2-7R	2CSM204125R0601		0,118	1

Where to find more:

Programming Details of Electro-mechanical Time Switches p.10/238
Worldwide Marks and Approvals of MDRCs p.11/96
Time, Staircase Lights, Twilight Switches and Thermostats brochure (code 2CSC440020B0201)



Frequently asked question - FAQ:

You can find all ABB instruction manuals on www.abb.com/abblibrary/ download center

Control and automation

ATP electro-mechanical time switches



ATP

2CSC44002B0211

Technical features		ATP	ATP-R	ATP-7R
Rated voltage	[V]	230 AC + 10%		
Contact type		1NO/NC		
Switching capacity	ohmic loads	[A]	16	
	inductive loads	[A]	3	
Rated frequency	[Hz]	50-60		
Time base		quartz		
Minimum switching time	[min]	10		60
Max. no. of commands per cycle		72		84
Power reserve	[h]	-	200	
Operating accuracy		+ 1 sec / 24 h		
Switching accuracy		1,5		10
Power dissipation	[VA]	0,5		
Max. switching power	[W]	1.000		
Max. cross-section of terminal wires	[mm ²]	1..6		
Terminals		loss-proof screw		
Tightening torque	[Nm]	1.2		
Installation type		wall/panel		
Operating temperature	[°C]	-10 ...+50		
Storage temperature	[°C]	-20 ...+60		
Standards		EN 60730		

ATP electro-mechanical time switches

These switches are used to control circuit opening and closing according to a preset program. Available in daily or weekly versions, with or without power reserve, they are characterized by the settings on the front, which during the holding time of the load, allows for the contact status in ON/OFF to be forced until the next switch time. The ATP range is the perfect solution for lighting systems in shops, public buildings, in heating and irrigation systems, etc.

Contacts	Bbn	Order details		Price	Weight	Pack
	8012542	Type code	Order code	1 piece	1 piece	unit
	EAN				kg	pc.
1NO/1NC	592334	ATP	2CSM259233R0601			1
1NO/1NC	580539	ATP-R	2CSM258053R0601			1
1NO/1NC	568735	ATP-7R	2CSM256873R0601			1

Where to find more:

Programming Details of Electro-mechanical Time Switches p.10/238
 Worldwide Marks and Approvals of MDRCs p.11/96
 Time, Staircase Lights, Twilight Switches and Thermostats brochure (code 2CSC44002B0201)



Frequently asked question - FAQ:

You can find all ABB instruction manuals on www.abb.com/abblibrary/download-center

Control and automation

E 232 staircase lighting time-delay switches

Technical features						
	E 232-230	E 232E-230N	E 232E-8/230N	E 232E-230 Multi 10	E 232E-8/230 Multi 10	E 232E-HLM
Time range (stepless)	1 – 7 min. in 15 sec. increments	0.5 – 20 min. stepless	0.5 – 20 min. stepless	0.5 – 20 min. stepless	0.5 – 20 min. stepless	20 – 60 sec. stepless
Control voltage 230 V AC	■	■	■	■	■	
Universal voltage in addition			8 ... 240 V AC/DC		8 ... 240 V AC/DC	
Glow lamp load	50 mA	150 mA	150 mA	150 mA	150 mA	
3/4 conductor operated	switches	automatically	automatically	automatically	automatically	
Resettable	■	■	■	■	■	
Steady-light switch	■	■	■	■	■	
Advance warning acc. DIN 18015-2				■	■	■
Long-time range of 60 min.				■	■	
Multi-functional (10 functions)				■	■	
Rated voltage	230 V AC 50Hz	240 V AC 50 / 60 Hz	240 V AC 50 / 60 Hz	240 V AC 50 / 60 Hz	240 V AC 50 / 60 Hz	240 V AC 50 / 60 Hz
Control voltage range	0.9 ... 1.1 Un	0.85 ... 1.1 Un	0.85 ... 1.1 Un	0.85 ... 1.1 Un	0.85 ... 1.1 Un	0.9 ... 1.1 Un
Power loss	1 VA	6 VA	6 VA	6 VA	6 VA	6 VA
Rated switching capacity	16 A, 230 V AC	16 A, 230 V AC	16 A, 230 V AC	16 A, 230 V AC	16 A, 230 V AC	10 A, 230 V AC
Filament lamp load	2,300 W	2,300 W	2,300 W	3,600 W	3,600 W	2,300 W
Halogen lamp load	2,300 W	2,300 W	2,300 W	3,600 W	3,600 W	2,300 W
Fluorescent lamps series compensated / uncorrected	2,300 VA	2,300 VA	2,300 VA	3,600 VA *	3,600 VA *	not permitted
Fluorescent lamps inductive or capacitive	2,300 VA	2,300 VA	2,300 VA	3,600 VA *	3,600 VA *	not permitted
Fluorescent lamps shunt compensated	1,300 VA (70 µF)	400 VA (42 µF)	400 VA (42 µF)	1,200 VA (120 µF) *	1,200 VA (120 µF) *	not permitted
Electronic controlgear	9x7 W, 6x11 W 5x15 W, 5x20 W	9x7 W, 7x11 W, 7x20 W, 7x23 W	9x7 W, 7x11 W, 7x20 W, 7x23 W	34x7 W, 27x11 W, 24x15 W, 22x23 W	34x7 W, 27x11 W, 24x15 W, 22x23 W	not permitted
Inductive load (cos j = 0.6/230 V AC)	2,300	2,300	2,300	2,300	2,300	not permitted
Contact material	AgSnO2	AgSnO2	AgSnO2	AgSnO2	AgSnO2	AgSnO2
Contact gap	≥ 3 mm	< 3 mm	< 3 mm	< 3 mm	< 3 mm	< 3 mm
Mech. serviceable life	> 106	> 107	> 107	> 107	> 107	> 107
Serviceable life at rated load, cos φ =1	> 105	> 2x105	> 2x105	> 2x105	> 2x105	> 105
Serviceable life at rated load, cos φ =0.6	> 104	> 4x104	> 4x104	> 4x104	> 4x104	> 104
Terminal capacity	10.7 mm ²	13 mm ²	13 mm ²	13 mm ²	13 mm ²	13.6 mm ²
Max. conductor capacity	6 mm ²	4 mm ²	4 mm ²	4 mm ²	4 mm ²	6 mm ²
ON duration	Resettable after 30 sec.	100 %	100 %	100 %	100 %	100%
Ambient temperature	- 10 °C to + 50 °C	- 25 °C to + 50 °C	- 25 °C to + 50 °C	- 25 °C to + 50 °C	- 25 °C to + 50 °C	- 10 °C to + 50 °C
Housing and insulation material	heat resistant, self-extinguishing thermoplast	heat resistant, self-extinguishing thermoplast	heat resistant, self-extinguishing thermoplast	heat resistant, self-extinguishing thermoplast	heat resistant, self-extinguishing thermoplast	heat resistant, self-extinguishing thermoplast
Control current at 230 V AC	4.5 mA	26 mA	26 mA	26 mA (min. 8 mA at 8 V AC)	26 mA (min. 8 mA at 8 V AC)	
Minimum command duration	10 ms	20 ms	20 ms	20 ms / 50 ms for multi voltage input	20 ms / 50 ms for multi voltage input	

7

* no disconnection advance warning possible for this application.

Control and automation

E 232 staircase lighting time-delay switches



E 232-230



E 232 E-230N



E 232 HLM

E 232 staircase lighting time-delay switches

Staircase lighting time-delay switches are usually operated by pushbuttons, often fitted with a glow lamp. Switches are designed for a glow lamp current of up to 150 mA and thus perfectly suitable for installations in multi-storey buildings.

The E 232-230 staircase lighting time-delay switch includes an electro-mechanical timer with a synchronous motor drive to ensure high operational safety in whatever mounting position. The time range is adjustable in increments of 15 seconds from 1 to seven minutes. Resettable after 30 seconds.

E 232E-230N and E 232E-8/230N devices feature electronic time delays. A high switching capacity,

150 mA glow lamp current parallel to the pushbuttons, steplessly adjustable time range from 0.5 to 20 min, as well as low switching noise make these devices so special.

Devices of the E 232E-230 Multi 10 and E 232E-8/230 Multi 10 series are multi-functional products with 10 functions to choose from that can be adjusted from the front. Through an electronically controlled connection of the load at voltage zero, a very high switching capacity of 3,600 W (load of filament lamp) is reached.

The devices include an integrated warning feature (warning by blinking) according to DIN 18015-2 as well as a 60 minute long-time function.

The E 232E-8/230N and E 232E-8/230 Multi 10 staircase lighting time-delay switches offer an additional metallicly separated control input for 8...240 V AC/DC.

The electronic E 232-HLM half-light module is a supplementary device for staircase lighting time-delay switches for semi-light control according to DIN 18015-2. The module switches filament lamps and 230 V halogen lamps up to 2,300 W in the warning phase to an output voltage that is reduced by 50%. Adjustable time range from 20 – 60 seconds.

Time range	Power loss W	Bbn 4013614	Order details		Price 1 piece	Weight 1 piece kg	Pack unit pc.
		EAN	Type code	Order code			
1 ... 7 min.	1 V A	54824 3	E 232-230	2CDE 110 000 R0501		0.081	10
20 min	6 V A	65416 6	E 232 E-230N	2CDE 110 003 R0511		0.095	10
20 min	6 V A	65417 3	E 232 E-8/230N	2CDE 010 003 R0511		0.1	10
20 min	6 V A	65418 0	E 232 E-230 Multi 10	2CDE 110 013 R0511		0.095	10
20 min	6 V A	65419 7	E 232 E-8/230 Multi 10	2CDE 010 013 R0511		0.1	10
20 ... 60 sec.	6 V A	54828 1	E 232-HLM	2CDE 150 000 R0521		0.075	10

Where to find more:

Worldwide Marks and Approvals of MDRCs p.11/96
Time, Staircase Lights, Twilight Switches and Thermostats brochure (code 2CSC440020B0201)



Control and automation

E 234 electronic timers



E 234

Technical data				
Data at Ta = 25 °C and rated values, if nothing else indicated				
Type		CT-D with 1 c/o contact	CT-D with 2 c/o contacts	
Input circuit - Supply circuit				
Rated control supply voltage US	A1-A2	24-240 V AC / 24-48 V DC		
	A1-A2	-	12-240 V AC/DC (CT-MFD.21)	
Rated control supply voltage US tolerance		-15...+10 %		
Rated frequency	AC/DC versions	DC or 50/60 Hz		
	AC versions	50/60 Hz		
Frequency range	AC/DC versions	DC or 47/63 Hz		
	AC versions	47/63 Hz		
Typical power consumption	24 V DC	0.6 W	on request	
	230 V AC	1.3 VA	on request	
	115 V AC	1.3 VA	on request	
Power failure buffering time		min. 20 ms	min. 30 ms	
Input circuit - Control circuit				
Voltage-related triggering	Control input, Control function	A1-Y1/B1	start timing external	
	Maximum cable length to the control input		50 m - 100 pF/m	
	Minimum control pulse length		30 ms	
	Control voltage potential		see rated control supply voltage	
	Current consumption of the control input		max. 4 mA	on request
	Parallel load / polarized		yes / yes	
Timing circuit				
Time ranges	7 time ranges 0.05 s - 100 h	1.) 0.05-1 s 2.) 0.5-10 s 3.) 5-100 s 4.) 0.5-10 min 5.) 5-100 min 6.) 0.5-10 h 7.) 5-100 h		
	4 time ranges 0.05 s - 10 min (CT-SDD, CT-SAD)	1.) 0.05-1 s 2.) 0.5-10 s 3.) 5-100 s 4.) 0.5-10 min		
Recovery time		< 50 ms		
Repeat accuracy (constant parameters)		$\Delta t < \pm 0.5 \%$		
Accuracy within the rated control supply voltage tolerance		$\Delta t < 0.005 \%$ / V		
Accuracy within the temperature range		$\Delta t < 0.06 \%$ / °C		
Star-delta transition time	CT-SDD	fixed 50 ms		
	CT-SAD	adjustable: 20-100 ms in steps of 10 ms		
Star-delta transition time tolerance	CT-SDD, CT-SAD	± 3 ms		
Indication of operational states				
Control supply voltage / timing	U: green LED	: control supply voltage applied : timing		
Relay status	R: yellow LED	: output relay 1 or 2 energized		
Output circuit				
Kind of output	15-16/18	relay, 1 c/o contact	-	
	15-16/18; 25-26/28	-	relay, 2 c/o contacts	
	17-18; 17-28	relay, 2 n/o contacts (CT-SDD, CT-SAD)		

Control and automation

E 234 electronic timers

Technical data			
Data at Ta = 25 °C and rated values, if nothing else indicated			
Type		CT-D with 1 c/o contact	CT-D with 2 c/o contacts
Contact material		Cd-free, see data sheet	
Rated operational voltage Ue		250 V	
Minimum switching voltage / minimum switching current		12 V / 100 mA	
Maximum switching voltage / maximum switching current		see load limit curves	
Rated operational current Ie (IEC 60947-5-1) for category	AC12 (resistive) at 230 V	6 A	5 A
	AC15 (inductive) at 230 V	3 A	3 A ①
	DC12 (resistive) at 24 V	6 A	5 A
	DC13 (inductive) at 24 V	2 A	3 A ①
Mechanical lifetime		30 x 10 ⁶ switching cycles	
Electrical lifetime	at AC12, 230 V, 4 A	0.1 x 10 ⁶ switching cycles	
Short-circuit proof / maximum fuse rating (IEC/EN 60947-5-1)	n/c contact	6 A fast-acting	
	n/o contact	10 A fast-acting	
General data			
Duty time		100%	
Dimensions (W x H x D)		17.5 mm x 70 mm x 58 mm	17.5 mm x 80 mm x 58 mm
		(0.69 x 2.76 x 2.28 inches)	(0.69 x 3.15 x 2.28 inches)
Weight		see ordering details	
Mounting		DIN rail (EN 60715), snap-mounting without any tool	
Mounting position		any	
Minimum distance to other units horizontal / vertical		no / no	
Degree of protection enclosure / terminals		IP50 / IP20	
Electrical connection			
Wire size	fine-strand	with wire end	2 x 0.5-1.5 mm ² (2 x 20-16 AWG)
		ferrule	1 x 0.5-2.5 mm ² (1 x 20-14 AWG)
	rigid	without wire	2 x 0.5-1.5 mm ² (2 x 20-16 AWG)
		end ferrule	1 x 0.5-2.5 mm ² (1 x 20-14 AWG)
Stripping length		7 mm (0.28 inches)	
Tightening torque		0.5-0.8 Nm	
Environmental data			
Ambient temperature range	operation	-20 ... +60 °C	
	storage	-40 ... +85 °C	
Damp heat (cyclic) (IEC/EN 60068-2-30)		6 x 24 h cycles, 55 °C, 95 % RH	
Vibration (sinusoidal) (IEC/EN 60068-2-6)		40 m/s ² , 20 cycles, 10...150...10 Hz	
Shock (half-sine) (IEC/EN 60068-2-27)		100 m/s ² , 11 ms	

① CT-MFD.2x on request

Technical data

Data at Ta = 25 °C and rated values, if nothing else indicated

Type		CT-D with 1 c/o contact	CT-D with 2 c/o contacts
------	--	-------------------------	--------------------------

Isolation data

Rated impulse withstand voltage Uimp between all isolated circuits (VDE 0110, IEC/EN 60664-1)		4 kV; 1.2/50 µs
Pollution category (IEC/EN 60664-1, VDE 0110, UL 508)		3
Overvoltage category (IEC/EN 60664-1, VDE 0110, UL 508)		III
Rated insulation voltage Ui	input circuit / output circuit	300 V
	output circuit 1 / output circuit 2	300 V
Basic insulation (IEC/EN 61140) input circuit / output circuit		300 V
Protective separation (VDE 0106 part 101 and part 101/A1; IEC/EN 61140)	input circuit / output circuit	250 V
Test voltage between all isolated circuits (type test)		2.5 kV, 50 Hz, 1 s

Standards

Product standard	IEC 61812-1, EN 61812-1 + A11, DIN VDE 0435 part 2021
Low Voltage Directive	2006/95/EC
EMC Directive	2004/108/EC
RoHS Directive	2002/95/EC

Electromagnetic compatibility

Interference immunity		IEC/EN 61000-6-1, IEC/EN 61000-6-2	
electrostatic discharge (ESD)	IEC/EN 61000-4-2	Level 3 (6 kV / 8 kV)	
electromagnetic field (HF radiation resistance)	IEC/EN 61000-4-3	Level 3 (10 V/m)	
fast transients (Burst)	IEC/EN 61000-4-4	Level 3 (2 kV / 5 kHz)	
powerful impulses (Surge)	IEC/EN 61000-4-5	Level 4 (2 kV L-L)	
HF line emission	IEC/EN 61000-4-6	Level 3 (10 V)	
Interference emission		IEC/EN 61000-6-3, IEC/EN 61000-6-4	
electromagnetic field (HF radiation resistance)	IEC/CISPR 22, EN 55022	B	
HF line emission	IEC/CISPR 22, EN 55022	B	

7

Control and automation

E 234 electronic timers



E 234 CT-MFD



E 234 CT-MFD



E 234 CT-ERD



E 234 CT-AHD

E 234 electronic timers

Multifunction timers

E 234 CT-MFD: 7 functions 1), 7 time ranges (0.05 s- 100 h), 2 c/o contacts, 2 LEDs							
Rated control voltage	Control input	Bbn	Order details		Price 1 piece	Weight 1 piece	Pack unit
V		EAN	Type code	Order code		kg	pc.
12-240 AC/DC	yes		E 234 CT-MFD.21	1SVR 500 020 R1100		0.065	1

E 234 CT-MFD: 7 functions 1), 7 time ranges (0.05 s- 100 h), 1 c/o contact, 2 LEDs							
Rated control voltage	Control input	Bbn	Order details		Price 1 piece	Weight 1 piece	Pack unit
V		EAN	Type code	Order code		kg	pc.
24-48 DC, 24-240 AC	yes		E 234 CT-MFD.12	1SVR 500 020 R0000		0.060	1

ON-delay timers

E 234 CT-ERD: 7 time ranges (0.05 s- 100 h), 2 c/o contacts, 2 LEDs							
Rated control voltage	Control input	Bbn	Order details		Price 1 piece	Weight 1 piece	Pack unit
V		EAN	Type code	Order code		kg	pc.
24-48 DC, 24-240 AC			E 234 CT-ERD.22	1SVR 500 100 R0100		0.065	1

E 234 CT-ERD: 7 time ranges (0.05 s- 100 h), 1 c/o contact, 2 LEDs							
Rated control voltage	Control input	Bbn	Order details		Price 1 piece	Weight 1 piece	Pack unit
V		EAN	Type code	Order code		kg	pc.
24-48 DC, 24-240 AC			E 234 CT-ERD.12	1SVR 500 100 R0000		0.060	1

OFF-delay timers

E 234 CT-AHD: 7 time ranges (0.05 s- 100 h), 2 c/o contacts, 2 LEDs							
Rated control voltage	Control input	Bbn	Order details		Price 1 piece	Weight 1 piece	Pack unit
V		EAN	Type code	Order code		kg	pc.
24-48 DC, 24-240 AC	yes		E 234 CT-AHD.22	1SVR 500 110 R0100		0.065	1

E 234 CT-AHD: 7 time ranges (0.05 s- 100 h), 1 c/o contact, 2 LEDs							
Rated control voltage	Control input	Bbn	Order details		Price 1 piece	Weight 1 piece	Pack unit
V		EAN	Type code	Order code		kg	pc.
24-48 DC, 24-240 AC	yes		E 234 CT-AHD.12	1SVR 500 110 R0000		0.060	1

¹⁾ Functions: ON-delay, OFF-delay with auxiliary voltage, Impulse-ON, Impulse-OFF with auxiliary voltage, Flasher starting with ON, Flasher starting with OFF, Pulseformer

Where to find more:
E234 technical details p.10/256



E 234 CT-VWD



E 234 CT-EBD



E 234 CT-TGD



E 234 CT-SDD

Impulse-ON 

E 234 CT-VWD: 7 time ranges (0.05 s- 100 h), 1 c/o contact, 2 LEDs

Rated control voltage	Control input	Bbn	Order details		Price 1 piece	Weight 1 piece	Pack unit
V		EAN	Type code	Order code		kg	pc.
24-48 V DC, 24-240 V AC			E 234 CT-VWD.12	1SVR 500 130 R0000		0.060	1

Flasher, starting with the ON time 

E 234 CT-EBD: 7 time ranges (0.05 s- 100 h), 1 c/o contact, 2 LEDs

Rated control voltage	Control input	Bbn	Order details		Price 1 piece	Weight 1 piece	Pack unit
V		EAN	Type code	Order code		kg	pc.
24-48 V DC, 24-240 V AC			E 234 CT-EBD.12	1SVR 500 150 R0000		0.060	1

Pulse generators 

E 234 CT-TGD: 2x7 time ranges (0.05 s- 100 h) 2), 2 c/o contacts, 2 LEDs

Rated control voltage	Control input	Bbn	Order details		Price 1 piece	Weight 1 piece	Pack unit
V		EAN	Type code	Order code		kg	pc.
24-48 V DC, 24-240 V AC	yes		E 234 CT-TGD.22	1SVR 500 160 R0100		0.065	1

E 234 CT-TGD: 2x7 time ranges (0.05 s- 100 h) 2), 1 c/o contact, 2 LEDs

Rated control voltage	Control input	Bbn	Order details		Price 1 piece	Weight 1 piece	Pack unit
V		EAN	Type code	Order code		kg	pc.
24-48 V DC, 24-240 V AC	yes		E 234 CT-TGD.12	1SVR 500 160 R0000		0.060	1

Star-delta change-over 

E 234 CT-SDD: 4 time ranges (0.05 s- 10 min), transition time 50 ms fixed, 2 n/o contacts, 3 LEDs

Rated control voltage	Control input	Bbn	Order details		Price 1 piece	Weight 1 piece	Pack unit
V		EAN	Type code	Order code		kg	pc.
24-48 V DC, 24-240 V AC			E 234 CT-SDD.22	1SVR 500 211 R0100		0.065	1

E 234 CT-SAD: 4 time ranges (0.05 s- 10 min), transition time adjustable, 2 n/o contacts, 3 LEDs

Rated control voltage	Control input	Bbn	Order details		Price 1 piece	Weight 1 piece	Pack unit
V		EAN	Type code	Order code		kg	pc.
24-48 V DC, 24-240 V AC			E 234 CT-SAD.22	1SVR 500 210 R0000		0.065	1

²⁾ ON and OFF times adjustable independently, 2x7 time ranges 0.05 s - 100 h

Control and automation

T line twilight switches



T1

Technical features		T1	T1 PLUS
Rated supply voltage	[V]	110 ÷ 230 AC	
Contact type		1NO	
Switching capacity			
resistive load cosφ 1	[A]	16	
inductive load cosφ 0.6	[A]	3	
incandescent lamps	cosj 1	max 3600 W	
fluorescent lamps	cosφ0.8	max 3600 W	
fluorescent - duo./electronic lamps	cosφ0.9	max 300 W	
Rated frequency	[Hz]	50-60	
Switching delay			
ON	[s]	30 ±10%	15...120 ±10%
OFF	[s]	40 ±10%	15...120 ±10%
Brightness range (+20% of tolerance)	[lx]	2:200	2:40 20:200 200:2000 2000:15000
Protection degree			
twilight switch		IP20	IP20
sensor		IP65	IP65
Operating temperature			
twilight switch	[°C]	-25...+55	
sensor	[°C]	-40...+70	
Storage temperature			
twilight switch	[°C]	-40...+70	
sensor	[°C]	-50...+80	
Power consumption	[VA]	4.5	
Max. commutable power	[W]	3500	
Terminal size for cable	[mm ²]	2.5	
Terminals			
Tightening torque	terminals	[Nm]	0.5
	sensor screw	[Nm]	0.4
Mounting			
Switching status indication/brightness range		on DIN rail red Led / green Led	
Max wiring length	[m]	100	
Modules		1	
Reference standards		EN 60669-1; EN 60669-2-1; EN 60730-1	

7

Where to find more:

Worldwide Marks and Approvals of MDRCs p.11/96

Time, Staircase Lights, Twilight Switches and Thermostats brochure (code 2CSC440020B0201)



Frequently asked question - FAQ:

A complete list of answers is available in the „Question and Answer“ section of Time, Staircase Lights, Twilight Switches and Thermostats brochure (code 2CSC440020B0201)



You can find all ABB instruction manuals on www.abb.com/abblibrary/download-center



T1



T1 PLUS



LS-D

T line modular twilight switches

These twilight switches allow to switch on and switch of lighting devices according to a scheduled level of the ambient light. They are used in combination with a sensor to detect if the ambient light is higher or lower than the set level . A switching delay prevents them from operating unnecessarily when the light intensity suddenly changes (e.g. lightning, moving vehicles, etc.). The T1 twilight switch in 1 channel is preset a 10 LUX from factory and is equipped with 2 signalling LEDs that indicate the setpoint value and display the status of the contact . The operating instructions are printed on the side of the product. T1 PLUS switches feature a setpoint that can be adjusted for 4 different scale values (2:40, 20:200, 200:2000, 2000:15000). This makes them ideal for daytime applications where the Lux values are very high. With a 10 lux preset factory setting, they are equipped with 2 signalling LEDs that indicate the setpoint value and display the status of the contact.

Brightness range	Bbn 8012542	Order details		Price 1 piece	Weight 1 piece	Pack unit
lx	EAN	Type code	Order code		kg	pc.
2 : 200	955634	T1	2CSM295563R1341		0.076	1
2 : 15000	957935	T1 PLUS	2CSM295793R1341		0.078	1

7

Accessories for T Line modular twilight switches

The photosensor is supplied in the same package of the switch, but it's also available separately as spare part. The upper part of the external case (with screw locking), made up of thermoplastic material, bears up against ultraviolet rays to guarantee an homogeneous diffusion of the daylight internally. The photosensor, wall mounted, is supplied with a cable gland.

	Bbn 8012542	Order details		Price 1 piece	Weight 1 piece	Pack unit
	EAN	Type code	Order code		kg	pc.
	957232	LS-D	2CSM295723R1341		0.069	1

Control and automation

T1 POLE twilight switches



T1 POLE

Technical features		
		T1 POLE
Rated supply voltage	[V]	110 ÷ 230 AC
Contact type		1NO polarized
Switching capacity		
resistive load $\cos\phi$ 1	[A]	16
inductive load $\cos\phi$ 0.6	[A]	3
incandescent lamps	$\cos\phi$ 1	max 3600 W
fluorescent lamps	$\cos\phi$ 0.8	max 3600 W
fluorescent - duo./electronic lamps	$\cos\phi$ 0.9	max 300 W
Rated frequency	[Hz]	50-60
Switching delay		
ON	[s]	30 ± 10%
OFF	[s]	40 ± 10%
Brightness range	[lx]	2:200
Protection degree		IP65
Operating temperature	[°C]	-40...+70
Storage temperature	[°C]	-50...+80
Power consumption	[VA]	4.5
Max. commutable power	[W]	3500
Terminal size for cable	[mm ²]	2.5
Terminals		loss-proof screw
Tightening torque	[Nm]	0.4
Mounting		pole/wall
Switching status indication/ brightness range		- / red Led
Reference standards		EN 60669-1; EN 60669-2-1; EN 60730-1

Where to find more:

Worldwide Marks and Approvals of MDRCs p.11/96

Time, Staircase Lights, Twilight Switches and Thermostats brochure (code 2CSC440020B0201)



Frequently asked question - FAQ:

A complete list of answers is available in the „Question and Answer“ section of Time, Staircase Lights, Twilight Switches and Thermostats brochure (code 2CSC440020B0201)



You can find all ABB instruction manuals on www.abb.com/abblibrary/download-center



T1 POLE

T1 pole mounting twilight switch

The T1 POLE version is designed for installation on the pole / wall, with photocell inputs and integrated cabling including cable gland seals to ensure a high degree of protection. Thanks also to the high quality, T1 POLE provides excellent resistance to atmospheric agents and a long service life. T1 POLE is also equipped internally with a preset sensor of 10 Lux. The sensor is extractable from the base and allows an easy and efficient maintenance without needing further wiring. T1 POLE is the ideal solution to management the external light systems such as the public ones, more precisely, in cases where there is a need of having to control the lighting of public or private roads, gardens, courtyards to the decline of solar radiation during precisely the twilight.

Brightness range	Bbn 8012542	Order details		Price 1 piece	Weight 1 piece	Pack unit
lx	EAN	Type code	Order code		kg	pc.
2 : 200	957539	T1 POLE	2CSM295753R1341		0.140	1

Control and automation

TWA twilight switches



TWA

Technical features

		TWA-1	TWA-2
Rated supply voltage	[V]	230 ±15% AC	
Contact type		1NO/NC	2 NO/NC
Switching capacity			
resistive load	[A]	16	
inductive load cos ϕ 0.6	[A]	10	
Max. number of lamps			
incandescent and halogen lamps	[W]	2300	
compensated (max. 45 μ F)	[W]	400	
non compensated, series compensated	[W]	1000	
compact fluorescent	[W]	500	
Rated frequency	[Hz]	50-60	
Programs ON-OFF		56	
Accuracy		±1.5 sec/24h	
Time base		quartz	
Minimum switch between two steps	[min]	1	
Running reserve	[year]	5	
Astronomical time accuracy	[min]	±10	
Protection degree		IP20	
Operating temperature	[°C]	-10...+55	
Storage temperature	[°C]	-20...+60	
Power consumption	[VA]	6	
Max. commutable power	[W]	4000	
Terminal size for cable			
flexible	[mm ²]	1 to 6	
rigid	[mm ²]	1.5 to 10	
Terminals		loss-proof screw	
Tightening torque	[mm ²]	1.2	
Mounting		on DIN rail	
Modules		2	
Reference standards		EN 60730-1 EN 60730-2-7	

Where to find more:

Worldwide Marks and Approvals of MDRCs p.11/96

Time, Staircase Lights, Twilight Switches and Thermostats brochure (code 2CSC440020B0201)



Frequently asked question - FAQ:

A complete list of answers is available in the „Question and Answer“ section of Time, Staircase Lights, Twilight Switches and Thermostats brochure (code 2CSC440020B0201)



You can find all ABB instruction manuals on www.abb.com/abblibrary/download-center



TWA-1

2CSC400228P0001

TWA twilight astronomical switches

The twilight astronomical switches TWA-1 and TWA-2, respectively, in 1 and 2 channels, they automatically control lighting circuits depending on the time of sunrise and sunset , greatly increasing energy efficiency.

The programming is in fact based on a mathematical algorithm able to calculate the time of the rising and setting of the sun in a certain location for each day of the year. Once powered the device, simply insert date, time, geographical coordinates and time zone because it is ready to work. The installation of these devices is particularly useful when using a twilight switch with external probe is not recommended because it may be subject to malfunctions caused by air pollution, excessive brightness or vandalism. TWA-1 and TWA-2 are also indicated for the control of public lighting, shop windows of shops, neon signs, monuments, facades and illuminated fountains.

Brightness range	Bbn 8012542	Order details		Price 1 piece	Weight 1 piece	Pack unit
lx	EAN	Type code	Order code		kg	pc.
1NO/NC	043652	TWA-1	2CSM204365R1341		0.160	1
2NO/NC	043751	TWA-2	2CSM295723R1341		0.160	1

7

Accessories for TWA twilight astronomical switches

The twilight astronomical switches TWA-1 and TWA-2, can be programmed directly on your PC using the software Handytimer. Once created, the program can be transferred to the programming key and copied into multiple devices, avoiding any errors in reprogramming.

	Bbn 8012542	Order details		Price 1 piece	Weight 1 piece	Pack unit
	EAN	Type code	Order code		kg	pc.
Programming key	043355	DT-VK	2CSM204335R0611		0.005	1
Locking key	046158	DT-LK	2CSM204615R0611		0.005	1
Programming software	043454	DT-SW	2CSM204345R0611		0.200	1

Control and automation

THS modular thermostats



2CSC400719F0001

THS

Technical features		THS-C	THS-W	THS-S
Rated voltage	[V]	230 AC		
Type of contact		1 NO/NC		2NO
Contact capacity				
ohmic load	[A]	16		
inductive load $\cos\phi$ 0.6	[A]	3		
Frequency	[Hz]	50-60		
Number of temperature set-points		1 continuously adjustable		2 continuously adjustable
Adjustment range	[°C]	-20...+40	0...+60	0...+10 / +20...+60
Max switching power	[W]	3500		
Differential	[°C]	fixed Dt = 1		fixed Dt = 2
Thermal gradient		1 °K / 15 minutes		
Type of operation		ON / OFF fixed differential		
Max cable section at terminals	[mm ²]	2.5		
Protection degree		IP20		
Relay ON/OFF indication		LED indicator		
Temperature tolerance	[°C]	±1		
T limits in operation	[°C]	0 ÷ +50		0 ÷ +70
Storage temperature	[°C]	-10...+65		-10...+70
Type of installation		DIN rail		
Case / color		thermoplastic / grey RAL 7035		
Power consumption	[VA]	3		
Terminals		Loss-proof screw		
Terminals size for cable	[mm ²]	2.5		
Tightening torque	[Nm]	0.5		
Application type		services / industrial		
Programming		graduated scale with mechanical pointer		

7

Where to find more:

Controls and Indicator Technical
 Details for THS p.10/269
 Worldwide Marks and Approvals of
 MDRCs p.11/96
 Time, Staircase Lights, Twilight Switches and Thermostats brochure (code 2CSC440020B0201)



Frequently asked question - FAQ:

You can find all ABB instruction manuals on www.abb.com/abblibrary/download-center



THS-C

2CSC400119F0001



THS-S

2CSC400119F0001

THS modular thermostats

The THS series modular thermostats are suited for a wide array of refrigeration and heating applications. The THS-C and THS-W models, both with a potential-free switching contact, are ideal for controlling temperature in heating systems, industrial settings or difficult-to-access locations, as well as for temperature regulation in refrigeration systems, refrigerated counters, greenhouses, dryers, etc....

The THS-S model, with two independent potential-free contacts, allows regulation of cooling between +20 and +60 °C and anti-condensation between 0 and +10 °C. The THS-S thermostat is supplied with remote sensor and is ideal for temperature control of electrical cabinets.

Temperature	Bbn 8012542	Order details		Price 1 piece	Weight 1 piece	Pack unit
°C	EAN	Type code	Order code		kg	pc.
-20...+40	511632	THS-C	2CSM251163R1380		0.20	1
0...+60	070832	THS-W	2CSM207083R1380		0.20	1
*+20...+60 / 0...+10	368038	THS-S	2CSM236803R1380		0.17	1

* cooling / anticondensation

Temperature sensors for THS-C and THS-W thermostats

The remote sensors (supplied separately) are used in conjunction with the THS-C and THS-W series thermostats to detect temperature overshoot or undershoot from the programmed set-point. The THS-1 and THS-4 models work in a temperature range between -30 °C and +130 °C and are respectively 1.5 and 4 metres long.

Lenght	Bbn 8012542	Order details		Price 1 piece	Weight 1 piece	Pack unit
m	EAN	Type code	Order code		kg	pc.
1.5	020332	THS-1	2CSM202033R1380		0.05	1
4	776031	THS-4	2CSM277603R1380		0.12	1

7

Control and automation

ATT GSM modules



ATT GSM

Technical characteristics			
GSM module		Quad band EGSM900 and GSM1800 for data, sms, fax and voice applications and GSM-1900, GSM-850. Full Type Approved conforming to ETSI GSM Phase 2+	
Output power		Class 4 (2 W@900 MHz) Class 1 (1 W@1800 MHz)	
Commands sent by		SMS, call rings, DTMF tones, GPRS connection	
Incoming alarms		SMS, call rings, e-mail, fax	
Inputs	digital	self-powered max. 20 V d.c., 2 mA	
	analog (only ATT-22)	input voltage 0...10 V input impedance < 10 Kohm / 100 nF sampling rate 90 Ksps	
Outputs	relay	NO 4 A 250 V a.c. - max 2500 VA	
	minimum load	100 mA, 12 V	
GSM indicator LED	OFF	device not supplied	
	STEADY ON	device under power not connected to mobile network, SIM pin code missing or incorrect	
	SLOW BLINK	device under power, connected to mobile network	
	FAST BLINK	communication in progress	
Power supply		[V]	12 ±10% a.c. /d.c.
Power consumption	when transmitting	[W]	2.5
	in stand-by	[W]	0.4
Terminal section		2.5 mm ²	
Temperature	ambient	[°C]	-20...55
	storage	[°C]	-30...85
Relative humidity	ambient	5...95% non condensing	
	storage	5...95% only external condensation	
Modules		4	
Protection degree		IP40	

Frequently asked question - FAQ:

You can find all ABB instruction manuals on www.abb.com/abblibrary/ download center



ATT-22

2CSC400731F0001



ATT programming software

1CSCA00108F0002

ATT GSM modules

The ATT modules are GSM telephone actuators for remotely controlling electrical loads over the mobile phone network, which answer the installation requirements of a variety of application settings. In particular, the ATT-22 version consists of a control module with 2 outputs and 2 inputs for residential, services-sector and industrial installations, while the ATT-81 alarm module, with 8 inputs and one output, is suitable for status and alarm monitoring in industrial and services-sector installations. Instructions and alarms can be sent via SMS message, free phone call ring, fax or e-mail according to need. Configuration can be accomplished by SMS messages or using the ATT-Tool software. All the ATT modules are supplied with backup lithium battery, ATT-Tool programming software and PC connecting cable. In addition, the ATT-22E and ATT-81E models are equipped with a pre-wired external antenna – essential if the module is installed in locations that do not assure adequate GSM coverage, such as cellars, enclosed metal structures, etc.

The modules can be supplied with an ABB type TS 25/12-24 C modular transformer and are compatible with the GSM SIM cards of all mobile telephone operators.

Inputs	Outputs	Bbn 4013614	Order details		Price 1 piece	Weight 1 piece kg	Pack unit pc.
		EAN	Type code	Order code			
2 analog or digital	2 NO	944904	ATT-22	2CSM322000R1371		0.200	1
8 digital	1 NO	945000	ATT-81	2CSM381000R1371		0.200	1
2 analog or digital	2 NO	083450	ATT-22E	2CSM208345R1371		0.200	1
8 digital	1 NO	083559	ATT-81E	2CSM208355R1371		0.200	1

Control and automation

CL logic relays, display system



CL

Technical Data overview

Logic relays

8 or 12 digital inputs
 4 or 6 digital relay outputs
 optionally with 4 or 8 transistor outputs
 128 rungs
 3 contacts as n/o or n/c contacts in series plus 1 coil per rung
 optionally with 2 or 4 analog inputs (not 100-240 V AC version)
 power flow display for checking the circuit diagram (devices with display)
 expansions for local or remote level
 enclosure color RAL 7035
 DIN rail mounting

Display system

useable as compact HMI logic relay
 fully graphic, backlit display module
 12 digital inputs
 4 digital relay outputs
 optionally with 4 transistor outputs
 265 rungs
 4 contacts as n/o or n/c contacts in series plus 1 coil per rung
 optionally with 4 analog inputs (not 100-240 V AC version)
 networking-compatible via CL-NET
 front panel mounting
 expansion for local

Remote display

Remote display up to a distance of 5 m
 Illustration of text and status displays
 Remote adjustment via keypad
 Front panel mounting

Software

16 timing relays 0.01-99:59 h
 16 counting relays for up-, down counting
 8 weekly timer, 8 annual timers
 16 analog value comparators
 16 freely editable text display
 32 markers or auxiliary relays

Further Documentation

(download from the internet: www.abb.com/lowvoltage > Control Products > Electronic Relays and Controls)

Technical catalogue

Electronic Products and Relays 2CDC 110 004 C0205

Manuals

Logic relay manual 1SVC 440 795 M0100
 Remote display manual 1SVC 440 795 M2100
 Display system manual 1SVC 440 795 M1100



CL-LSR



CL-LST

CL concept

CL range logic relays are suitable for small and medium-sized control tasks and are able to substitute logic wiring in a quick and simple manner.

They can be used for applications in control as well as for timing functions, e.g.

- in buildings, lighting systems, air-conditioning systems, general control functions,
- in small machines and systems or
- as stand-alone control module for small applications.

Steps to the application of CL range

- CL range can be used easily, rapidly and comfortably without any time-consuming planning and programming.
- The user can discover the advantages and the benefit of these logic relays in no time at all.
- CL range provides for the control statements according to a simple circuit diagram.
- Setup, storage, simulation and documentation are performed using the compact and user-friendly CL-SOFT software (CL-LAS.PS002).

Software characteristics (CL-SOFT)

- display on a PC monitor according to IEC, ANSI
- up to 10 languages to choose from
- easy installation on all Microsoft Windows™ operating systems

Logic relays

Logic relays – 8 inputs, 4 relay outputs									
Rated operational voltage	Dis-play + Key-pad	Timer	Ex-pan-dable	Bbn EAN	Order details		Price 1 piece	Weight 1 piece kg	Pack unit pc.
					Type code	Order code			
24 V AC	■	■			CL-LSR.C12AC1	1SVR 440 712 R0300		0.20/0.44	1
24 V AC		■			CL-LSR.CX12AC1	1SVR 440 712 R0200		0.20/0.44	1
100-240 V AC	■				CL-LSR.12AC2	1SVR 440 713 R0100		0.20/0.44	1
100-240 V AC	■	■			CL-LSR.C12AC2	1SVR 440 713 R0300		0.20/0.44	1
100-240 V AC		■			CL-LSR.CX12AC2	1SVR 440 713 R0200		0.20/0.44	1
12 V DC	■	■			CL-LSR.C12DC1	1SVR 440 710 R0300		0.20/0.44	1
12 V DC		■			CL-LSR.CX12DC1	1SVR 440 710 R0200		0.20/0.44	1
24 V DC	■				CL-LSR.12DC2	1SVR 440 711 R0100		0.20/0.44	1
24 V DC	■	■			CL-LSR.C12DC2	1SVR 440 711 R0300		0.20/0.44	1
24 V DC		■			CL-LSR.CX12DC2	1SVR 440 711 R0200		0.20/0.44	1

Logic relays – 8 inputs, 4 transistor outputs									
Rated operational voltage	Dis-play + Key-pad	Timer	Ex-pan-dable	Bbn EAN	Order details		Price 1 piece	Weight 1 piece kg	Pack unit pc.
					Type code	Order code			
24 V DC	■	■			CL-LST.C12DC2	1SVR 440 711 R1300		0.20/0.44	1
24 V DC		■			CL-LST.CX12DC2	1SVR 440 711 R1200		0.20/0.44	1

Control and automation

CL logic relays, display system



CL-LMR

2C0C31103BF0606



CL-LMT

2C0C31103BF0606



CL-LER

2C0C31103BF0606



CL-LEC

2C0C31103BF0606

Logic relays – 12 inputs, 6 relay outputs									
Rated operational voltage	Dis-play + Key-pad	Timer	Ex-pan-dable	Bbn EAN	Order details		Price 1 piece	Weight 1 piece kg	Pack unit pc.
					Type code	Order code			
24 V AC	■	■	■		CL-LMR.C18AC1	1SVR 440 722 R0300		0.36/0.79	1
24 V AC		■	■		CL-LMR.CX18AC1	1SVR 440 722 R0200		0.36/0.79	1
100-240 V AC	■	■	■		CL-LMR.C18AC2	1SVR 440 723 R0300		0.36/0.79	1
100-240 V AC		■	■		CL-LMR.CX18AC2	1SVR 440 723 R0200		0.36/0.79	1
12 V DC	■	■	■		CL-LMR.C18DC1	1SVR 440 720 R0300		0.36/0.79	1
12 V DC		■	■		CL-LMR.CX18DC1	1SVR 440 720 R0200		0.36/0.79	1
24 V DC	■	■	■		CL-LMR.C18DC2	1SVR 440 721 R0300		0.36/0.79	1
24 V DC		■	■		CL-LMR.CX18DC2	1SVR 440 721 R0200		0.36/0.79	1

Logic relays – 12 inputs, 8 transistor outputs									
Rated operational voltage	Dis-play + Key-pad	Timer	Ex-pan-dable	Bbn EAN	Order details		Price 1 piece	Weight 1 piece kg	Pack unit pc.
					Type code	Order code			
24 V DC	■	■	■		CL-LMT.C20DC2	1SVR 440 721 R1300		0.36/0.79	1
24 V DC		■	■		CL-LMT.CX20DC2	1SVR 440 721 R1200		0.36/0.79	1

Expansion – 2 relays outputs									
Rated operational voltage	Bbn EAN	Order details		Price 1 piece	Weight 1 piece kg	Pack unit pc.			
		Type code	Order code						
-		CL-LER.20	1SVR 440 709 R5000		0.07/0.15	1			

Expansions – 12 inputs, 6 relay outputs									
Rated operational voltage	Bbn EAN	Order details		Price 1 piece	Weight 1 piece kg	Pack unit pc.			
		Type code	Order code						
100-240 V AC		CL-LER.18AC2	1SVR 440 723 R0000		0.26/0.57	1			
24 V DC		CL-LER.18DC2	1SVR 440 721 R0000		0.22/0.49	1			

Expansion - 12 inputs, 8 transistor outputs									
Rated operational voltage	Bbn EAN	Order details		Price 1 piece	Weight 1 piece kg	Pack unit pc.			
		Type code	Order code						
24 V DC		CL-LET.20DC2	1SVR 440 721 R1000		0.21/0.46	1			

Coupler unit for remote expansion with a distance of up to 30 m									
Rated operational voltage	Bbn EAN	Order details		Price 1 piece	Weight 1 piece kg	Pack unit pc.			
		Type code	Order code						
-		CL-LEC.CI000	1SVR 440 709 R0000		0.07/0.15	1			



CL-LAS.PS002

2C0C31101P0007



CL-LAS.MD003

2C0C31101P0007



CL-LAS.TK001

2C0C31101H0007



CL-LAS.TK011

2C0C311031P0007

Accessories for logic relays

Software CL-SOFT for programming and control of CL range devices						
Description	Bbn	Order details		Price 1 piece	Weight 1 piece	Pack unit
	EAN	Type code	Order code		kg	pc.
Installation CD-ROM for Microsoft Windows™		CL-LAS.PS002	1SVR 440 799 R8000		0.10/0.21	
Memory module for logic relays						
Description	Bbn	Order details		Price 1 piece	Weight 1 piece	Pack unit
	EAN	Type code	Order code		kg	pc.
Memory size: 32 kB		CL-LAS.MD003	1SVR 440 799 R7000		0.02/0.04	1
Connecting cable with serial interface to connect PC and logic relay						
Description	Bbn	Order details		Price 1 piece	Weight 1 piece	Pack unit
	EAN	Type code	Order code		kg	pc.
Length: 2 m		CL-LAS.TK001	1SVR 440 799 R6000		0.10/0.22	1
Connecting cable with USB interface to connect PC and logic relay						
Description	Bbn	Order details		Price 1 piece	Weight 1 piece	Pack unit
	EAN	Type code	Order code		kg	pc.
Length:		CL-LAS.TK002	1SVR 440 799 R6100			1
Connecting cable for point-to-point connection of remote-display connection module and logic relay						
Description	Bbn	Order details		Price 1 piece	Weight 1 piece	Pack unit
	EAN	Type code	Order code		kg	pc.
Length: 5 m, adaptable		CL-LAD.TK007	1SVR 440 899 R6600		0.20/0.44	1
Fixing brackets for screw mounting of logic relay, expansion, display base module						
Description	Bbn	Order details		Price 1 piece	Weight 1 piece	Pack unit
	EAN	Type code	Order code		kg	pc.
content: 9 fixing brackets		CL-LAS.FD001	1SVR 440 799 R5000		0.01/0.01	1
Connecting plug CL-LINK for connection of logic relay to expansion						
Description	Bbn	Order details		Price 1 piece	Weight 1 piece	Pack unit
	EAN	Type code	Order code		kg	pc.
CL-LINK		CL-LAS.TK011	1SVR 440 799 R5100		0.10/0.22	1

Control and automation

CL logic relays, display system



CL-LAS.SD..

2CDC311018F0007



CL-LDC.S..

2CDC311017F0007



CL-LDD.K

2CDC311028F0006



CL-LDC.LN..

2CDC311031F0006

Input-/ output simulator with wall power supply, fits to CL-LSR and CL-LST

Rated input voltage	Rated output voltage/current	Bbn	Order details		Price 1 piece	Weight 1 piece	Pack unit
		EAN	Type code	Order code		kg	pc.
100-240 V AC	24 V DC		CL-LAS.TD001	1SVR 440 793 R0000		0.19/0.43	1

Primary switch mode power supplies

Rated input voltage	Rated output voltage/current	Bbn	Order details		Price 1 piece	Weight 1 piece	Pack unit
		EAN	Type code	Order code		kg	pc.
100-240 V AC	24 V DC / 0.35 A		CL-LAS.SD001	1SVR 440 703 R0000		0.10/0.22	1
100-240 V AC	12 V DC / 20 mA						
100-240 V AC	24 V DC / 1.25 A		CL-LAS.SD002	1SVR 440 713 R0000		0.20/0.44	1

Remote display connection modules to displace the display from the logic relay, incl. connecting cable CL-LAD.TK007, 5 m, length adaptable

Rated operational voltage	Bbn	Order details		Price 1 piece	Weight 1 piece	Pack unit
	EAN	Type code	Order code		kg	pc.
24 V DC		CL-LDC.SDC2	1SVR 440 841 R0000		0.16/0.36	1
100-240 V AC		CL-LDC.SAC2	1SVR 440 843 R0000		0.16/0.36	1

Display system

Grafic Display modules 132 x 64 pixel

Description	Bbn	Order details		Price 1 piece	Weight 1 piece	Pack unit
	EAN	Type code	Order code		kg	pc.
without keyboard		CL-LDD.XK	1SVR 440 839 R4500		0.14/0.30	1
with keyboard		CL-LDD.K	1SVR 440 839 R4400		0.13/0.29	1

Display base modules - CPU / power supply

Rated operational voltage	Bbn	Order details		Price 1 piece	Weight 1 piece	Pack unit
	EAN	Type code	Order code		kg	pc.
24 V DC		CL-LDC.LDC2	1SVR 440 821 R0000		0.16/0.36	1
100-240 V AC		CL-LDC.LAC2	1SVR 440 823 R0000		0.16/0.36	1

Display base modules - CPU / power supply, networking-compatible (CL-NET)

Rated operational voltage	Bbn	Order details		Price 1 piece	Weight 1 piece	Pack unit
	EAN	Type code	Order code		kg	pc.
24 V DC		CL-LDC.LNDC2	1SVR 440 821 R1000		0.17/0.38	1
100-240 V AC		CL-LDC.LNAC2	1SVR 440 823 R1000		0.17/0.38	1

Display I/O modules - 8 inputs, 4 relay outputs

Rated operational voltage	Bbn	Order details		Price 1 piece	Weight 1 piece	Pack unit
	EAN	Type code	Order code		kg	pc.
100-240 V AC		CL-LDR.16AC2	1SVR 440 853 R0000		0.17/0.38	1
24 V DC		CL-LDR.16DC2	1SVR 440 851 R0000		0.17/0.38	1



CL-LDR

2DCS11035F006



CL-LAD.MD004

2DCS11018F007



CL-LAD.TK009

2DCS11027F007

Display I/O modules - 8 inputs, 4 relay outputs, 1 analog output						
Rated operational voltage	Bbn	Order details		Price 1 piece	Weight 1 piece	Pack unit
	EAN	Type code	Order code		kg	pc.
24 V DC		CL-LDR.17DC2	1SVR 440 851 R2000		0.17/0.38	1

Display I/O module - 8 inputs, 4 transistor outputs						
Rated operational voltage	Bbn	Order details		Price 1 piece	Weight 1 piece	Pack unit
	EAN	Type code	Order code		kg	pc.
24 V DC		CL-LDT.16DC2	1SVR 440 851 R1000		0.14/0.30	1

Display I/O module - 8 inputs, 4 transistor outputs, 1 analog output						
Rated operational voltage	Bbn	Order details		Price 1 piece	Weight 1 piece	Pack unit
	EAN	Type code	Order code		kg	pc.
24 V DC		CL-LDT.17DC2	1SVR 440 851 R3000		0.14/0.30	1

Accessories for display system

7

Memory module for display base modules						
Description	Bbn	Order details		Price 1 piece	Weight 1 piece	Pack unit
	EAN	Type code	Order code		kg	pc.
Memory size: 256 kB		CL-LAD.MD004	1SVR 440 899 R7000		0.02/0.03	1

Connecting cable with serial interface to connect PC and display base module						
Description	Bbn	Order details		Price 1 piece	Weight 1 piece	Pack unit
	EAN	Type code	Order code		kg	pc.
Length: 2 m		CL-LAD.TK001	1SVR 440 899 R6000		0.11/0.23	1

Connecting cable with USB interface to connect PC and display base module						
Description	Bbn	Order details		Price 1 piece	Weight 1 piece	Pack unit
	EAN	Type code	Order code		kg	pc.
Length:		CL-LAD.TK011	1SVR 440 899 R6700			1

Network cable (CL-NET) to connect 2 display base modules						
Description	Bbn	Order details		Price 1 piece	Weight 1 piece	Pack unit
	EAN	Type code	Order code		kg	pc.
Length: 0.3 m		CL-LAD.TK002	1SVR 440 899 R6100		0.05/0.12	1
Length: 0.8 m		CL-LAD.TK003	1SVR 440 899 R6200		0.07/0.14	1
Length: 1.5 m		CL-LAD.TK004	1SVR 440 899 R6300		0.08/0.18	1

Connecting cable for point-to-point connection of remote display connection modules and display base module						
Description	Bbn	Order details		Price 1 piece	Weight 1 piece	Pack unit
	EAN	Type code	Order code		kg	pc.
Length: 5 m, adaptable		CL-LAD.TK005	1SVR 440 899 R6400		0.20/0.44	1

Control and automation

CL logic relays, display system

Connecting cable for point-to-point connection of 2 display base modules, length adaptable						
Description	Bbn	Order details		Price	Weight	Pack
	EAN	Type code	Order code	1 piece	1 piece	unit
Length: 5 m		CL-LAD.TK006	1SVR 440 899 R6500		0.12/0.26	kg pc.
						1

Termination resistor						
Description	Bbn	Order details		Price	Weight	Pack
	EAN	Type code	Order code	1 piece	1 piece	unit
content: 2 pieces		CL-LAD.TK009	1SVR 440 899 R6900		0.01/0.02	kg pc.
						1

Protective covers, transparent						
Description	Bbn	Order details		Price	Weight	Pack
	EAN	Type code	Order code	1 piece	1 piece	unit
for harsh environmental conditions and application in the food industry		CL-LAD.FD001	1SVR 440 899 R1000		0.03/0.07	kg pc.
sealable		CL-LAD.FD011	1SVR 440 899 R2000		0.03/0.07	kg pc.
						1

Assembly tool for mounting of display modules						
Description	Bbn	Order details		Price	Weight	Pack
	EAN	Type code	Order code	1 piece	1 piece	unit
-		CL-LAD.FD002	1SVR 440 899 R3000			kg pc.
						1

Control and automation

E 450 priority switches



E 450

Technical characteristics		
	E 451-5.7	E 452-5.7
Operating coil		
Range of rated current equivalent to	6.7 ... 39 A	1.5 ... 9 kW at 230 V, 4.6 ... 27 kW at 230/400 V
Threshold current	3.1 ... 5.3 A	
OFF delay (max.)	0 main half waves	2 main half waves
Max. continuous current	43 A	
Therm. continuous capacity at 40 °C/104 °F	5 W	
Contact assembly		
Control contact	1 NC contact	
Rated contact current at 250 V	1 A	
Contact material	solid silver	
Max. switching voltage	400 V	
Max. switching capacity	230 VA	
Max. switched current	1 A	
Max. inrush current peak	5 A	
Electr. service life	> 105 operations	
Mechanical service life	ca. 2 x 10 ⁶ operations	
Max. electrical switching rate	ca. 1800 operations/hour	
ON duration	100 %	
Ambient temperature	- 20 °C/- 4 °F to + 40 °C/104 °F	
Response time	10 ... 20 ms	
Release time	5 ... 20 ms	≥ 20 ms
Test voltage contact/coil	2.5 kV	
Clearance and creepage distance	C/250 V AC cording to IEC 609-1-23	
Degree of protection	IP 40	
Protection against electric shock	according to DIN VDE 0106 Part 100 (BGV A2)	
Terminal contact	series coil up to 16 mm ² , control contact up to 2.5 mm ²	

7

E 450 priority switches

The priority switch is used in wiring systems where existing lead cross sections or the size of the power supply service box do not allow for simultaneous operation of two powerful loads (e.g. storage heating and flow-type heater).

The priority switch disconnects the long-term load (storage heating) for as long as the short-term consumer (flow-type heater) is switched on.

The coil of the priority switch is connected in series to the short-term load. When this load is switched on, the NC contact of the priority switch disconnects e.g. the heating system contactor.

For pneumatically controlled flow-type heaters

Rated current range	Power loss	Bbn 4016779	Order details		Price 1 piece	Weight 1 piece	Pack unit
	W	EAN	Type code	Order code		kg	pc.
6,7 ... 39 A	2.4	41590 3	E 451- 5.7 A	2CDE16000R0901		0.1	10

For electronically controlled flow-type heaters

Rated current range	Power loss	Bbn 4016779	Order details		Price 1 piece	Weight 1 piece	Pack unit
	W	EAN	Type code	Order code		kg	pc.
6.7 ... 39 A	2.4	20950 2	E 452-5.7 A	2CDE160010R0901		0.1	10

Control and automation

RAL overload relays



RAL

Technical characteristics		RAL3	RAL6
Rated voltage Un	[V]	a.c. 230	
Rated current In	[A]	18.3	27.5
Rated contact capacity In	[A]	12 cosφ=1; 4 cosφ=0.8	
Rated frequency	[Hz]	50	
Adjustment ranges	[A]	0 ...18.3	0...27.5
Power consumption	[W]	10	
Modules	[No.]	2	
Intervention delay		instantaneous	

RAL overload relays

Installed downstream of the main circuit-breaker in a single-phase system, they constantly compare the actual power consumption to the preset threshold. An acoustic alarm alerts that some appliances must be switched off to avoid tripping the main circuit-breaker whenever the preset threshold is exceeded. The device calibration is 3 kW.

RAL built in relay output contact allows the following functions to be implemented:

- a) remote signalling (acoustic or lighting)
 - b) opening a divisional circuit-breaker to disable a non essential electrical appliance.
- Function b) allows one or more appliances to be automatically switched off in order to keep the power consumption within the preset limit and avoid unwanted tripping of the current-limiting device installed outside the home (e.g. in the basement). RAL must be reset manually.

Adjustable range	Bbn 8012542	Order details		Price 1 piece	Weight 1 piece	Pack unit
kW	EAN	Type code	Order code		kg	pc.
0/3	400509	RAL 3	2CSM111200R1301		0.200	1
0/6	400608	RAL 6	2CSM121200R1301		0.200	1

Where to find more:

Load Release Technical Details for
RAL p.10/275
Worldwide Marks and Approvals of
MDRCs p.11/96

Control and automation

LSS1/2 load shedding switch



Technical characteristics		
Rated voltage Un	[V]	a.c. 230
Rated capacity In	[A]	90
Rated contact capacity In NPL1 and NPL2	[A]	16 each (terminals 12 and 14)
Rated frequency	[Hz]	50/60
Regulating thresholds	[A]	5...30 10...60 15...90
Load reinsertion delay		5-7 min. (NPL1); 4-5, 50 min. (NPL2)
Load disinsertion delay		about 2 sec.
Indicators		1 green LED = supply voltage available 2 red LEDs = loads switched off
Load OFF remote signalling	[A]	1 (terminals 11 and 13)
Terminals	Primary load	35 mm ²
	Non-priority loads	10 mm ²
Power consumption	[W]	5
Modules	[No.]	5

7

LSS1/2 load shedding switch

Installed downstream of the main circuit-breaker, it compares the actual power consumption of the system to a preset maximum permitted value, and prevents tripping of the main circuit-breaker by sequentially switching off a maximum of two non-priority loads (NPL1 and NPL2) when the preset threshold is exceeded. A green LED indicates the presence of the supply voltage, and two red LEDs indicate the load OFF conditions. At preset time intervals, the device automatically attempts to reconnect the previously disabled loads.

Note: In unbalanced three-phase systems same function of LSS1/2 can be implemented via DMTME multimeters. Digital outputs of the multimeter can be set to trip with an user defined delay to switch off - by means of external contactors - non-priority loads of arbitrary consumption. See for details page 10/142.

	Bbn 8012542	Order details		Price 1 piece	Weight 1 piece	Pack unit
	EAN	Type code	Order code	kg	pc.	
	274407	LSS1/2	2CSM112500R1311		0.400	1

Where to find more:

Worldwide Marks and Approvals of MDRCs p.11/96

Frequently asked question - FAQ:

You can find all ABB instruction manuals on www.abb.com/abblibrary/download-center

Control and automation

E 235 mains disconnection relays



E 235-NFS



E 235-GLE

Technical features	
Short circuit rupturing capacity	16 A/230 V a.c.
Rated frequency	50/60 Hz
Range of control voltage	0.9 to 1.1 Un
Load of filament lamps	2300 W
Fluorescent lamp load:	
twin lamp circuit	100 W
shunt compensated	56 W
electronic ballast	max. 36 W, dependent on manufacturer
Induce load	6 A $\cos\phi = 0.6$
Max. switching capacity ($\cos\phi 0.5$)	3500 VA
Intrinsic consumption ca.	1 W
Control voltage	5 V a.c.
Adjustable making capacity	2 - 15 VA
Breaking capacity	0.66 x making capacity
ON delay	50 ms
OFF delay	ca. 3 sec.
Contact assembly	1 NO contact
Service life at rated load	> 100000 switching cycles
Ambient temperature	- 10 °C/14 °F to +45 °C/113 °F
Connection capacity (clamping terminal)	max 2.5 mm ²

E 235 mains disconnection relays - Bioswitch

Constant exposure of electrical interference fields originating from live conductors - as is the case e.g. in bedrooms - may impair the well-being of people, experts say.

With the extra base load adapter E235-GLA, the mains disconnection relays can be switched on manually.

For the permanent installation of loads that switch on independently of the supply voltage, such as fluorescent lamps, a E235-GLE PTC base load element is available.

Description	Bbn	Order details		Price 1 piece	Weight 1 piece	Pack unit
	4016779	Type code	Order code			
	EAN				kg	pc.
mains disconnection relay	571821	E 235-NFS	2CDE11000R1701		0.065	1
base load element	571814	E 235-GLE	2CDE100500R1711		0.001	1
base load adapter	571869	E 235-GLA	2CDE100510R1711		0.070	1

Where to find more:

Worldwide Marks and Approvals of MDRCs p.11/96

Control and automation

LEE 230 extractable power failure signalling lamp



LEE-230

2CSC400268FC001

Technical characteristics		
2P 10 A plug		distance between pins 19 mm, pin ø 4 mm
Supply	[V]	230 a.c., 50-60 Hz
Recharge time	[h]	24
Endurance	[h]	3
Lighting level	[mcd]	3000
Operating temperature	[°C]	0...+45
Min. life cycle		5 years (battery)

Additional technical features

LEE-230 lamp automatically switches on when the voltage fails; the built-in rechargeable battery guarantees the supply.

It is particularly useful thanks to its construction and functional characteristics:

- it can be extracted from the socket and used as a torch with ON-OFF button on its frontal side
- when necessary it can work with standard sockets
- it can be moved when it is needed
- it has a long operation endurance, up to three hours
- it is ready to use, it does not require installation
- with a screw (ø 3.5 mm, L 16 mm) it is possible to fix it preventing the extraction from the M1173 ABB sockets with central hole
- the projecting part of the Schuko profile is very small (8 mm).

The two LEDs placed on the frontal side of the lamp indicate its operation condition:

- the red LED indicates the recharge activity and that, in the case of a network voltage back-out, the lamp will remain off
- the green LED indicates the recharge activity and that, in the case of a network voltage black-out, the lamp will switch on (it will automatically switch off when the voltage returns).

By pushing the frontal pushbutton it is possible to change the status; if you do not use the lamp for a prolonged time it is suggested to set the first condition in order to preserve the battery life.

7

LEE 230 extractable power failure signalling lamp

The LEE 230 lamp is an automatic electronic lamp that can be installed in any modular socket or wiring accessory socket conforming to the German VDE Schuko standard (e.g. ABB M1173 or M1175), to the Italian standard P11 10A, or to the 10/16 A Italian dual standard.

The device functions both as a power failure signalling lamp and as a lighting device, to be used for example during maintenance activities or when seeking faults in the panel.

Pack	Bbn	Order details		Price	Weight	Pack
	8012542	Type code	Order code	1 piece	1 piece	unit
	EAN				kg	pc.
Blister	507406	LEE-230	2CSM111000R1361		0.100	1

Where to find more:

Worldwide Marks and Approvals of MDRCs p.11/96

Control and automation

USB Modular DIN rail device



MeMo4

USB Modular DIN rail device

Function: Modular DIN rail device to store electronic information, files and applications. All the data required will be available in the switchboard. No supply is required.

ATTENTION!

MeMo4 is available with USB port (USB cable not included).

Description	Storage	Bbn	Order details		Price	Weight	Pack
		8012542	Type code	Order code	1 piece	1 piece	unit
		EAN				kg	pc.
Modular data memory	4 GB	144656	MeMo4	2CSS200960R0002		0.200	1



MeMo4

Index

M2M, ANR and DMTME selection table	8/4
M2M network analyser	8/5
ANR network analyser	8/9
DMTME multimeters	8/12
CUS serial converter	8/14
Energy meters selection table	8/16
A-series EQ meters	8/18
B-series EQ meters	8/28
C-series EQ meters	8/36
G-series EQ meters	8/40
Analogue and digital instruments selection table	8/42
Modular digital instruments	8/43
Front panel digital instruments	8/45
Analogue instruments selection table	8/46
Modular analogue instruments	8/47
Scales for modular analogue ammeters	8/49
Front-panel analogue instruments	8/51
Scales for front-panel analogue instrument	8/57
Voltmetric and current switches	8/64
E 233 hour counters	8/65
HMT hour counters	8/66
TMD temperature control units	8/67
Current transformers selection table	8/88
CT measurement current transformers with through primary	8/72
CTA measurement current transformers with wound primary	8/77
CTO split core measurement current transformers	8/78
TRF M measurement modular current transformers	8/79
SNT current transformer for d.c. applications	8/80
TV voltage transformers	8/81
CMS – Current Measurement System	8/82

M2M. The measure of efficiency

Measurement and advanced analysis of electrical parameters

Easy fixing system with clips which ensure the device is held reliably on the front-panel.

Multi-voltage auxiliary power supply range, from 24 V DC to 230 V AC

Real time display of energy consumption also in Euros and kg CO₂



Multilingual backlit display with two lines of scrolling text to guide and help the user in reading data and programming.

Communication without limits thanks to the availability of different protocols for any types of network

Reduced depth: only 57 mm inside the panel.

Intuitive and easy-to-use front keypad for navigating in the menu and configuring the device.



The fixing system allows the device to be installed safely and reliably on the panel, not only upon installation but also during the working period when the unit is subject to vibrations and temperature fluctuations.



The removable terminals, accessible from three sides, along with wiring parallel to the panel guarantee ease of installation. The screw fastenings of the amperometric measurement circuits offer reliability and precision. The network analyser performs constant verification of correct wiring thanks to its autodiagnostic function, signalling any operating errors.



With the M2M analyser it is possible to keep the electrical consumption of all types of system under control, measuring them in real time both in economic and environmental impact terms, thanks to the immediate conversion into Euros and CO₂ kg.

8



All the information gathered by the M2M analyser can be transmitted quickly to remote locations through specific communication interfaces – RS485, RJ45 - with the support of numerous protocols including Modbus RTU, Modbus TCP/IP and Profibus DP. Interaction with the control and supervision systems is possible via digital inputs and digital, relay or analogue outputs, all programmable.



The reduced depth of only 57 mm inside the panel makes the analyser ideal for installation even in switchboard with reduced space. At only 96 mm x 96 mm x 77 mm it still contains everything necessary to measure power quality parameters in real time.



Advanced functionalities to optimise consumptions like monitoring of absorbed power by measuring maximum demand to avoid paying penalties to the electricity distributor, bidirectional reading to display the amount of produced and consumed energy and verification of energy quality through THD measurement.

Energy efficiency

DMTME, M2M and ANR selection table

	Modular and front panel multimeters			Front panel network analysers	
					
	DMTME	DMTME-72	DMTME-96	M2M	ANR96
Overall dimensions	6 DIN modules	72x72x90	96x96x103	96x96x77	96x96x130
Display	LED			LCD backlit	LCD graphic backlit
Power supply	110 V a.c. 230 V a.c.	230 V a.c. 400 V a.c.	110 V a.c. 230 V a.c.	24-240 V a.c./d.c.	20-60 V a.c./d.c.
TRMS voltage	Electrical parameters measurement				
TRMS current					
Frequency					
Power factor					
Cosφ					
Active power					
Reactive power					
Apparent power					
Active energy					
Reactive energy					
Apparent energy					
Peak value Min/Max/Avg					
Timer and count-down					
Power 4Q					
Energy 4Q					
Current THD					
Voltage THD					
Password set up					
Neutral current				Energy management	
Tariff					
Maximum demand					
Harmonic analysis up to 31°					
Wave form visualisation					
Memory 1 MB	Digital			Digital Electromechanical relays Analogue	Digital
Outputs					
Inputs				Digital	
Serial port					
Protocols	Modbus RTU			Modbus RTU Ethernet TCP/IP Profibus DP	

8

Energy efficiency M2M network analyser



M2M

Technical features		
Auxiliary power supply		
Voltage range	[V]	From 24 to 240 V AC/DC From 48 to 240 V AC/DC M2M I/O From 24 to 240 V DC and from 48 to 240 V AC M2M ETHERNET, M2M PROFIBUS
Frequency range	[Hz]	45 - 65
Protection fuse		T 0.5 A from 24 V to 100 V T 0.25 A from 100 V to 240 V
Power consumption	[VA]	7 max
Measurement type		Sampling TRMS
Measurement accuracy		
Voltage		±0.5% F.S. ±1 digit
Current		±0.5% F.S. ±1 digit
Frequency		40.0 - 99.9 Hz: ± 0,2% ± 0,1 100 - 500 Hz: ± 0.2% ± 1
Power factor		± 1% ± 1 digit (from $\cos\phi=0.3$ Inductive to $\cos\phi = 0.3$ Capacitive)
Active power		± 1% ± 0.1% F.S (from $\cos\phi=0.3$ Inductive to $\cos\phi = 0.3$ Capacitive)
Active energy		Class 1
Measurement range		
Voltage	[V]	From 10 to 500 approx. TRMS VL-N. No decimal places
Current		From 50 mA to 5 A TRMS 2 decimal places displayed
Frequency	[Hz]	From 40 to 500 1 decimal place displayed up to 99,9 and in integers above 100
Power factor		2 decimal places displayed
Installation		
Distribution networks		Low and medium voltage Low voltage M2M LV, M2M LV MODBUS Single-phase connection Three-phase with neutral - Three-phase without neutral
Current inputs	[A]	Always use external CT Primary from 1 to 10,000 A AC approx. Secondary 5 A and 1 A AC approx. N.B.: in case of CT secondary at 1 A the accuracy class is reduced to 2.5% F.S. ±1 digit, in the range 5-100% F.S.
Voltage inputs	[V]	Direct insertion up to 500 AC approx. Indirect insertion with VT: Primary from 60 to 60,000 V AC approx - secondary from 60 to 190 V AC N.B.: In case of VT secondary at less than 100 V the accuracy class is reduced to 2.5% F.S. ±1 digit, in the range 5-100% F.S.
Protection fuse for voltage inputs	[A]	0.1
Data update frequency		2 times/second

8

Where to find more:

Made to Measure guide (code 2CSC445012D0201)



Frequently asked question - FAQ:

A complete list of answers is available in the M2M brochure (code 9AK-K105408A9102)



You can find all ABB instruction manuals on www.abb.com/abblibrary/download-center

Maybe you are also interested in:

Current and Voltage Transformers

p.8/68 and p.8/81

CUS - Serial Converter p.8/14

Energy efficiency

M2M network analyser

Harmonic distortion count	[Hz]	Band measurement up to 500
Energy measurement		
Single-phase maximum value counted		10 GWh / GVarh / GVAh
Three-phase maximum value counted		30 GWh / GVarh / GVAh
Energy balance maximum value counted		10 GWh / GVarh / GVAh with sign
Input pulses maximum energy value counted		40 GWh / GVarh
Terminal characteristics		
Current inputs		Cross section 6 mm ² - Step 6.35 mm
Voltage inputs		Cross section 2.5 mm ² - Step 7.62 mm
Impulsive outputs		Cross section 2.5 mm ² - Step 5.08 mm
RS485 Serial port		Cross section 2.5 mm ² - Step 5.08 mm
Relay outputs		Cross section 2.5 mm ² - Step 5.08 mm
Overall dimensions		96 mm x 96 mm x 77 mm (Depth inside switchboard: 57 mm)
Weight	[Kg]	0.400 max
Standards		
Overall dimensions		IEC 61554
Protection degree		IEC 60529
Accuracy class		IEC 60688, IEC 61326-1, IEC 62053-21 , IEC 62053-23, IEC 62053-31.
Electrical safety		IEC 61010-1
User interface		
Display		Scrolling text in user-selectable language
Display type		LCD with backlighting which can be set by user
Display dimensions	[mm]	72x57
Communication interface		
RS485 (M2M MODBUS, M2M LV MODBUS, M2M ALARM, M2M I/O)		
- Protocol		Modbus RTU
- Electrical standard		RS485 with optical isolation
- Baud rate		4.8, 9.6, 19.2 kbps
- Parity number		Odd, Even, None
- Stop bit		1, 2
- Address		1-247
- Connectors		4-pole terminal (integrated 120 Ohm termination)
Profibus (M2M PROFIBUS)		
- Protocol		Profibus with slave DP-V0 function in compliance with IEC 61158 regulations
- Electrical standard		RS485 with optical isolation
- Baud rate		Automatic detection [9.6 - 12 Mbps]
- LED indicators		Green for communication status and Red for communication error
- Address		0-126
- Connectors		DB 9 female connector (do not use connectors with 90° cable outlet)
Ethernet (M2M ETHERNET)		
- Protocol		Modbus TCP/IP
- Connectors		RJ45

Where to find more:
Made to Measure guide (code 2CSC445012D0201)



Frequently asked question - FAQ:
A complete list of answers is available in the M2M brochure (code 9AK-K105408A9102)



You can find all ABB instruction manuals on www.abb.com/abblibrary/download-center

Maybe you are also interested in:
Current and Voltage Transformers p.8/68 and p.8/81
CUS - Serial Converter p.8/14

Digital output programmed as pulse		
Contact supply external voltage	[V]	48 max (peak AC/DC)
Maximum current	[mA]	100 (peak AC/DC)
Pulse duration	[ms]	50 OFF (min) / 50 ON closed contact
Pulse frequency		10 pulses/s (max)
Digital output programmed as alarm		
Contact supply external voltage	[V]	48 max (peak AC/DC)
Maximum current	[mA]	100 (peak AC/DC)
Alarm activation delay	[s]	1 - 900 s (programmable)
Alarm return hysteresis		0 - 40% (programmable)
Relay output (M2M ALARM)		
Normal current	[A]	16 AC1 - 3 AC15
Max. instantaneous current	[A]	30
Nominal voltage	[V]	250 V AC
Max. instantaneous voltage	[V]	400 V AC
Nominal load	[VA]	4000 AC1 - 750 AC15
Analogue output (M2M I/O)		
Programmable electrical parameters		Span [0 - 20 mA or 4 - 20 mA]
Load		Typical 250 Ohm, max 600 Ohm
Digital inputs (M2M I/O)		
Nominal voltage	[V]	24 V DC (absorption = 13 mA)
Maximum voltage	[V]	32 V DC (absorption = 22 mA)
Max. voltage for OFF status	[V]	8 V DC
Min. voltage for ON status	[V]	18 V DC
Hour counters		
Countdown timer		Countdown of system operating time with the activation of a programmable threshold on total current. Upon expiry of the maintenance period set an icon will appear on the display.
Count-up timer		Operational time of device
Climatic conditions		
Storage	[°C]	from -10 to +60
Operation	[°C]	from -5 to +55
Relative humidity		Max 93% (non-condensing) at 40°C
Protection degree		
Frontal		IP50
At terminals		IP25

Energy efficiency

M2M network analyser



M2M

The new M2M network analyser has advanced analysis functions which allow effective measurement of the main single-phase or three-phase electrical parameters: voltage, current, frequency, power factor, active and reactive power, active and reactive energy. Fitted to low- and medium-voltage electrical panels (except for LV versions, suitable only for low voltage applications), the new analyser allows the measurement and analysis in real time of electrical parameters, also verifying the quality of the energy thanks to THD measurement.

M2M keeps the system's consumption under control, giving figures in CO₂ kg and Euros to ensure more efficient and rational use of energy. Bidirectional metering of energy and power on the 4 quadrants allows both production and consumption of energy to be monitored with a single device.

Aside from optimising the use of loads, real time measurement contributes to containing both environmental and budgetary impact.

All information gathered by the analyser can be transmitted quickly to remote locations through specific communication interfaces (RS485, RJ45), with the support of numerous protocols including Modbus RTU, Modbus TCP/IP and Profibus DP.

For interaction with control and supervision systems are available digital pulse outputs to remotely control active and reactive energy consumption, digital outputs programmable as threshold alarms with activation delay and return hysteresis, relay outputs with nominal current up to 16 A, and analogue outputs with programmable span (0 - 20 mA or 4 - 20 mA) for re-moting status and events. Digital inputs allow pulse acquisition from other energy counters or users.

Communication protocol and interface	2 relay outputs	3 digital inputs, 2 analogue outputs	Bbn	Order details		Price 1 piece	Weight 1 piece	Pack unit
			8012542	Type code	Order code			
			998839	M2M	2CSG299883R4052		0.300	1
Modbus RTU RS485			998938	M2M MODBUS	2CSG299893R4052		0.350	1
Ethernet RJ45			999034	M2M ETHERNET	2CSG299903R4052		0.400	1
Profibus RS485			999133	M2M PROFIBUS	2CSG299913R4052		0.400	1
Modbus RTU RS485	■		999232	M2M ALARM	2CSG299923R4052		0.400	1
Modbus RTU RS485		■	999331	M2M I/O	2CSG299933R4052		0.400	1
			999430	M2M LV	2CSG299943R4052		0.300	1
Modbus RTU RS485			969921	M2M LV MODBUS	2CSG296992R4052		0.350	1

Where to find more:
Made to Measure guide (code 2CSC445012D0201)



Frequently asked question - FAQ:
A complete list of answers is available in the M2M brochure (code 9AK-K105408A9102)



You can find all ABB instruction manuals on www.abb.com/abblibrary/download-center

Maybe you are also interested in:
Current and Voltage Transformers p.8/68 and p.8/81
CUS - Serial Converter p.8/14

Energy efficiency ANR network analyser



ANR

2CSC400/50F001

Technical features			
Dimensions			
Overall dimensions	[mm]	96 x 96 x 130	IEC 61554
Max cable section	[mm ²]	2.5	
Protection degree		IP52 on front - IP20 on terminal	EN 60529
Weight	[g]	430	
Display			
Graphic LCD		Backlit 128 x 128 pixel graphic LCD display	
Display dimensions	[mm]	ANR96: 50 x 50	
Voltage (TRMS)			
Direct measurement	[V]	10 - 600	
Ratio transformer range kVT	[V]	0.01 - 5,000.00	
Max over voltage	[V]	750, beyond this value must use VT	
Consumption	[VA]	0.2	
Input resistor	[MW]	>2	
Current (TRMS). always use external CT .../5A			
3 isolated inputs	[A]	0.01 - 5	
Min current value	[mA]	10	
Consumption	[VA]	0.2	
Max over current	[A]	10 (100 A for 1 second)	
Ratio transformer range kCT		0.01 - 5,000.00	
THD			
Voltage and current		Up to 31st harmonic	
Frequency			
Range	[Hz]	30 - 500	
Accuracy class			
Current	[%]	<0.5	
Voltage	[%]	<0.5	
Power	[%]	<1	
Power factor	[%]	<1	
Active energy	[%]	<1	IEC 62052-11
			IEC 62053-11
Reactive energy	[%]	2	IEC 62053-23
Auxiliary supply			
ANR96-230, ANR96P-230, ANR96LAN-230, ANR96PRF-230, ANR96- 230 02	[V]	85 ±265 a.c./d.c.	
ANR96-24, ANR96P-24, ANR96LAN-230, ANR96PRF-230, ANR96- 230 02	[V]	20 ± 60 a.c./d.c.	
Internal fuse		5x20 mm 315 mA 250 V Fast	
Frequency	[Hz]	50-60	
Operating environment			
Operating temperature	[°C]	-10 ± +50	
Storage temperature	[°C]	-15 ± +70	
Operating humidity	[°C]	90% without condensation	
Insulation			
Voltage insulation		3,700 V a.c. rms for 1 minute	
Remote communication			
RS485, RJ45			
Baud rate	[bps]	1,200 - 19,200	
Protocols		Modbus RTU, ASCII, Modbus TCP/IP, Profibus DP	

Where to find more:

Made to Measure guide (code 2CSC445012D0201)



Frequently asked question - FAQ:

A complete list of answers is available in the Network Analyser brochure (code 2CSC445050B0201)



You can find all ABB instruction manuals on www.abb.com/abblibrary/download-center

Maybe you are also interested in:

Current and Voltage Transformers

p.8/68 and p.8/81

CUS - Serial Converter p.8/14

Energy efficiency

ANR network analyser

Internal memory		
For ANR96	[kbytes]	128 (usable: 80)
For ANR96P	[Mbytes]	1
Memory		Non-volatile data storage using internal battery
Data retention		5 years at 25 °C
Internal clock		
RTC clock		IEC 61038
Class of accuracy	[ppm]	5
Digital output		
Connection area	[mm ²]	0 ÷ 2.5
External pulse voltage	[V]	12 ÷ 230 V a.c./d.c.
Max current	[mA]	150
Digital input		
Voltage	[V]	12 - 24 d.c.

Where to find more:

Made to Measure guide (code 2CSC445012D0201)



Frequently asked question - FAQ:

A complete list of answers is available in the Network Analyser brochure (code 2CSC445050B0201)



You can find all ABB instruction manuals on www.abb.com/abblibrary/download-center

Maybe you are also interested in:

Current and Voltage Transformers

p.8/68 and p.8/81

CUS - Serial Converter p.8/14



ANR96

2CSG400753F001

ANR Network analyser

In highly demanding applications, where the need is to monitor not only the electrical parameters of the network, but also the network quality, ABB has in its range of front-panel devices the ANR network analysers - measuring instruments that permit advanced analysis of single- and three-phase electrical distribution networks.

In particular, the ANR devices are able to measure and also record network parameters and alarms, associating them to a time-stamp for the retrieval of load profiles and exact time and date of occurrence of pre-programmed events; it finally allows routing data towards supervision and monitoring systems.

It also works as panel manager thanks to its digital inputs; the latter allows to have in a central unit the information about more devices like breakers, fuses and energy meters which convey to it the information about their status, alarms and energy pulses (whether equipped with output relays).

Available in 96 x 96 mm front-panel format, ANRs are equipped with a backlit graphic LCD display, allowing clear and immediate readings even in unlighted environments.

The ANR analysers measure TRMS current, TRMS voltage, frequency and temperature of the connected phases; they calculate concatenate voltages and three-phase system voltage and current, power factor and cosφ, apparent, active and reactive power, THD total harmonic distortion up to the 31st harmonic, and measure active energy consumed and produced. All codes have built-in communication features allowing remote communication via Modbus RTU, Modbus TCP/IP and Profibus DP.

8

All the parameters can be stored in the 128 kbyte internal memory, expanded to 1 Mbyte in the ANR96P version. All the measures can be stored in the internal memory; the amount of information that can be stored is further specified in the specific manual.

The devices come with the calibration certificate of the specific S/N and a mini-CD containing:

- Instruction manual
- Technical datasheet
- SW-01 software for managing the recorded data: the software can be used as first-hand tool to retrieve and record the measures, to set alarms and to create load profile.

For more detailed information about its features and use, refer to the software's manual.

All ANR versions have 2 programmable digital outputs and RS485/RS232 serial port. ANR96PRF models have built-in Profibus DP protocol. ANR96LAN models have built-in Modbus TCP/IP protocol and RJ45 port. ANR96 02 models have improved 0,2% accuracy class of measures.

Auxiliary supply	Program. display input	Storage	Bbn 8012542	Order details		Price 1 piece	Weight 1 piece	Pack unit
V a.c./d.c.			EAN	Type code	Order code		kg	pc.
20÷60	2	128 Kb	943402	ANR96-24	2CSG113000R4051		0.430	1
85÷265	2	128 Kb	943501	ANR96-230	2CSG213000R4051		0.430	1
20÷60	4	1 Mb	943600	ANR96P-24	2CSG123000R4051		0.430	1
85÷265	4	1 Mb	943709	ANR96P-230	2CSG223000R4051		0.430	1
20÷60	2	128 kb	583332	ANR96PRF-24	2CSG258333R4051		0.430	1
85÷265	2	128 kb	571537	ANR96PRF-230	2CSG257153R4051		0.430	1
20÷60	2	128 kb	772538	ANR96LAN-24	2CSG277253R4051		0.430	1
85÷265	2	128 kb	770336	ANR96LAN-230	2CSG277033R4051		0.430	1
20÷60	2	128 kb	573838	ANR96-24 02	2CSG257383R4051		0.430	1
85÷265	2	128 kb	562030	ANR96-230 02	2CSG256203R4051		0.430	1

Energy efficiency DMTME multimeters



DMTME

Technical characteristics			
Auxiliary supply	[V rms]	230 +15% - 10% DMTME, DMTME-72 and DMTME-96	
	[V rms]	400 +15% - 10% DMTME-72	
	[V rms]	115 +15% - 10% DMTME , DMTME-96	
Frequency	[Hz]	45...65	
Power consumption	[VA]	<6	
Fuse protection		T0.1A	
Voltage measuring inputs			
Range	[V rms]	10...500 V (L-N)	
Max. non destructive	[V rms]	550	
Impedance (L-N)	[MW]	>8	
Current measuring inputs (only external CTs .../5 A)			
Range	[A rms]	0.05...5	
Overload		1.1 permanent	
Measurement accuracy			
Voltage		±0.5% F.S. ±1 digit in range	
Current		±0.5% F.S. ±1 digit in range	
Active power		±1% ±0.1% F.S. from $\cos\phi = 0.3$ to $\cos\phi = -0.3$	
Frequency		±0.2% ±0.1Hz from 40.0 to 99.9 Hz	
		±0.2% ±1Hz from 100 to 500 Hz	
Energy metering			
Maximum metered value for single phase		4,294.9 MWh (MVarh) with KA = KV = 1	
Maximum metered value for three phase		4,294.9 MWh (MVarh) with KA = KV = 1	
Accuracy		Class 1	
Max. power consumption	[VA]	1.4 for each input (with I _{max} = 5A rms)	
Digital outputs			
Pulse duration		50 ms OFF (min)/ 50 ms ON	
V _{max} on contact		48 V (d.c. or a.c. peak)	
W _{max} dissipation		450 mW	
Max frequency		10 pulses/sec	
I _{max} contact		100 mA (d.c. or a.c. peak value)	
Insulation		750 V _{max}	
Programmable parameters			
kVT transformer ratio V _{prim} /V _{sec}		1...500	
kCT transformer ratio I _{prim} /I _{sec}		1...1,250	
Free hour counter	[h]	0...10,000,000, resettable	
Countdown	[h]	1...32,000	
Operating temperature	[°C]	0...+50	
Storage temperature	[°C]	-10...+60	
Relative humidity		90% max. (non condensing) at 40°C	
Overall dimensions	[mm]	105x90x58	DMTME
	[mm]	96x96x103	DMTME-96
	[mm]	72x72x90	DMTME-72

Where to find more:

Made to Measure guide (code 2CSC445012D0201)



Frequently asked question - FAQ:

A complete list of answers is available in the Network Analyser brochure (code 2CSC445050B0201)



You can find all ABB instruction manuals on www.abb.com/abblibrary/download-center

Maybe you are also interested in:

Current and Voltage Transformers

p.8/68 and p.8/81

CUS - Serial Converter p.8/14



DMTME

2CSG400756F0001



DMTME-96

2CSG400751F0001



DMTME-72

2CSG400752F0001

DMTME multimeters

The instruments DMTME are digital multimeters that allow the measurement, in TRMS mode, of the principal electrical parameters in three-phase and single-phase 110/230/400 Vac networks, including the max/min/average detection of the main electrical parameters and the active and reactive energy count. The multiple measured variables are displayed locally on four red 7-segment LED displays providing easy readability and simultaneous display of the measures of the electrical parameters of the phases individually and of the whole network.

The instruments DMTME combine, in a single instrument, the functions of multiple devices: voltmeter, ammeter, power factor meter, wattmeter, varmeter, frequency meter, active and reactive energy meters; it allows remarkable financial savings thanks to the reduction of space taken up in the panel and also of time required for cabling, along with the advantage of providing clear readings on a single device.

The DMTME-I-485, DMTME-I-485-96 and DMTME-I-485-72 models are additionally equipped with two digital relays, fully programmable as either pulse outputs for remote metering of energy consumption, or as alarm outputs. The output relay can be set as NO or NC.

There is also an RS485 port for communicating the measured parameters and alarms over Modbus network. Used in addition to a converter of the CUS series, it allows direct connection to a central PC for remote supervision and control of the electrical network.

All versions come complete with Mini CD containing the instruction manual, technical documentation, Modbus communication protocol and the DMTME-SW tool, intended to be a first-hand PC-based application for the remote visualization of the measures.

DMTME modular multimeters

TRMS measure of VL-L, VL-N, A, W, Var, VA, kWh, kVar, PF in 230/400 V a.c. lines. Indirect connection through CT .../5 A. Auxiliary supply at 110 V a.c. and 230 V a.c.

Auxiliary supply	RS485 serial port	Program. digital output	Bbn 8012542	Order details		Price 1 piece	Weight 1 piece	Pack unit
V a.c.			EAN	Type code	Order code		kg	pc.
110-230	-	-	975700	DMTME	2CSM170040R1021		0.450	1
110-230	■	2	975809	DMTME-I-485	2CSM180050R1021		0.450	1

DMTME-96 panel multimeters

Auxiliary supply 230 V a.c. and 110 V a.c.

RS485 serial port	Program. digital output	Dimensions	Bbn 8012542	Order details		Price 1 piece	Weight 1 piece	Pack unit
			EAN	Type code	Order code		kg	pc.
-	-	96x96	046752	DMTME-96	2CSG133030R4022		0.450	1
■	2	96x96	046851	DMTME-I-485-96	2CSG163030R4022		0.450	1

DMTME-72 panel multimeters

Auxiliary supply 230 V a.c. and 400 V a.c.

RS485 serial port	Program. digital output	Dimensions	Bbn 8012542	Order details		Price 1 piece	Weight 1 piece	Pack unit
			EAN	Type code	Order code		kg	pc.
-	-	72x72	046554	DMTME-72	2CSG132030R4022		0.450	1
■	2	72x72	046653	DMTME-I-485-72	2CSG162030R4022		0.450	1

Energy efficiency

CUS serial converter



CSC400128P0202

CUS

Technical features CUS RS485/232

Supply voltage	[V]	230 V ac \pm 20%
Frequency	[Hz]	50-60
Power consumption	[VA]	7 max
Power loss	[W]	3.5
Fuse		500 mA internal
Supply terminal dimensions	[mm ²]	2.5 max
RS485-422 terminal dimensions	[mm ²]	2.5 max
RS232 connection		Sub-D 9 female poles (DB9)
Max RS232 line length	[m]	15
Max RS485-422 line length	[m]	1200
Connection of multidrop units		Max 32
Operating temperature	[°C]	-20...+60
Storage temperature	[°C]	-20...+80
Modules	[No.]	6

Technical features CUS 485 TCP/IP

Supply voltage	[V]	220-240 a.c. \pm 15%
Power consumption	[VA]	4 max
Ethernet		100 base -T, RJ45 connector, TCP/IP protocol
RS485 serial port		standard, baudrate from 4800 to 19200 bps
Display, buttons		3 LED (1 green: ON, 1 red: LINK, 1 yellow: DATA) programming button
Mechanical features		protection degree: IP52 front - IP20 case and terminals - weight: 0.40 kg, connections with screw terminal for cable max. 2.5 mm ² , self extinguishing plastic case, DIN rail mounting, 3 modules-17,5 mm each
Environmental features		operating temperature: -10 +60 °C, humidity <90% storage temperature: -25 +70 °C
Standards		IEC EN 50081-2 IEC EN 50082-1 IEC EN 61010-1

8

Where to find more:
Made to Measure guide (code
2CSC445012D0201)





CUS

2CSC400128F0202

RS485 / RS232 serial converter

The CUS multifunction serial converter has applications in all those situations which require converting or managing EIA -232 (RS-232) , EIA-485 (RS-485) or EIA-422 (RS-422) serial lines. The communication links between devices that use these types of buses (for example PLCs, measurement and control instruments, peripherals and computers running specific software applications, etc.) often call for converting between different serial interfaces, amplifying the signal on the line, isolating different parts of the communication network, etc. These diverse application requirements are readily met by the CUS converter, thanks to its configurability and operational flexibility.

The CUS assures galvanically-isolated interface conversion between the RS-232 side, the RS422-485 side and the power supply source.

Its versatility permits following operating modes:

- Full duplex conversion of RS-232 to RS-422
- Half duplex conversion of RS-232 to single-pair RS-485
- Half duplex conversion of RS-232 to two-pair RS-485
- RS-485 repeater (and monitoring function on RS-232)

The principal applications are:

- Multipoint data transmission networks
- Long distance serial links
- Galvanic separation of peripherals
- Extension of RS-485 lines



CUS 485

2CSC400128F0202

CUS 485 TCP/IP converter

The CUS 485 TCP/IP converter allows the conversion of an RS485 serial communication port into a TCP/IP ethernet bus.

The CUS 485 TCP/IP converter acts as a bridge between Modbus/TCP/IP and Modbus/ASCII/RTU.

The serial port is linked to a device using Modbus/ASCII or Modbus/RTU communication or to a network of devices, while the ethernet port is linked to server/PC or PLC systems.

Server commands are sent via ethernet to CUS 485 TCP/IP that convert and send the commands to the slave device.

Version	Bbn 8012542	Order details		Price 1 piece	Weight 1 piece	Pack unit
	EAN	Type code	Order code		kg	pc.
serial converter - signal repeater	333807	CUS	2CSM200000R1031		0.5	1
serial converter - LAN TCP/IP network	585633	CUS 485 TCP/IP	2CSG258563R4051		0.5	1

Energy efficiency

Energy meters selection table



	EQ meters C11	EQ meters C13	EQ meters B21	EQ meters B23	EQ meters B24				
Overall dimensions	1 DIN module	3 DIN modules	2 DIN modules	4 DIN modules	4 DIN modules				
Display	LCD	LCD	Backlit LCD	Backlit LCD	Backlit LCD				
Operating voltage	230 V AC	3x230/400 V AC	220...240 V AC	3x220/380...240/415 V AC					
Frequency	50 / 60 Hz								
Max current	40 A	40 A	65 A	65 A	6 A				
CTVT connected	-	-	-	-	CT				
Active energy	-								
Reactive energy						-	-	optional	
Apparent energy						-	-	-	
Accuracy	Cl. 1	Cl. 1 (B)	Cl. 1 (B)	Cl. 1 (B)	Cl. 1 (B), Cl. 0,5 S (C)				
Tariff	-	-	optional						
Event log	-	-	-						
Maximum demand	-	-	-	-	-				
Previous values	-	-	-	-	-				
Load profiles	-	-	-	-	-				
Harmonic analysis	-	-	-	-	-				
Alarm function	-								
Voltage									
Current									
Power factor									
Frequency	-	-	optional						
Pulse output	-								
Outputs	-	-	optional						
Inputs	-	-	-						
Built-in serial communication	-	-	IR, M-Bus, RS-485						
Protocols	-	-	M-Bus, Modbus RTU, EQ bus						

8

Energy efficiency EQ meters A series



A-series

Technical features	
	A41
Voltage/current inputs	
Nominal voltage	230 V AC
Voltage range	57.7 - 288 V AC (-20% - +15%)
Power dissipation voltage circuits	0.8 VA (0.8 W) total
Power dissipation current circuits	0.007 VA (0.007 W) at 230 VAC and I_b
Base current I_b	5 A
Rated current I_n	-
Reference current I_{ref}	5 A
Transitional current I_{tr}	0.5 A
Maximum current I_{max}	80 A
Minimum current I_{min}	0.25 A
Starting current I_{st}	< 20 mA
Terminal wire area	1 - 25 mm ²
Recommended tightening torque	3 Nm
Communication	
Terminal wire area	0.5 - 1 mm ²
Recommended tightening torque	0.25 Nm
Transformer ratios	
Configurable voltage ratio (VT)	-
Configurable current ratio (CT)	-
Pulse indicator (LED)	
Pulse frequency	1000 imp/kWh
Pulse length	40 ms
General data	
Frequency	50 or 60 Hz ± 5%
Accuracy Class	B (Cl.1) or Reactive Cl. 2
Active energy	1%
Display of energy	Pixel oriented
Environmental	
Operating temperature	-40°C - +70°C
Storage temperature	-40°C - +85°C
Humidity	75% yearly average, 95% on 30 days/year
Resistance to fire and heat	Terminal 960°C, cover 650°C (IEC 60695-2-1)
Resistance to water and dust	IP20 on terminal block without protective enclosure and IP51 in protective enclosure, according to IEC 60529.
Mechanical environment	Class M1 in accordance with the Measuring Instrument Directive (MID), (2004/22/EC).
Electromagnetic environment	Class E2 in accordance with the Measuring Instrument Directive (MID), (2004/22/EC).



A42	A43	A44
	3x230/400 V AC	
	3x57.7/100 ... 288/500 V AC (-20% - +15%)	
0.001 VA (0.001 W) at 230 VAC and I_n	0.007 VA (0.007 W) per phase at 230 VAC and I_b	0.001 VA (0.001 W) per phase at 230 VAC and I_n
-	5 A	-
1 A	-	1 A
-	5 A	-
0.05 A	0.5 A	0.05 A
6 A	80 A	6 A
0.02 A	0.25 A	0.01 A
< 1 mA	< 20 mA	< 1 mA
0.5 - 10 mm ²	1 - 25 mm ²	0.5 - 10 mm ²
1.5 Nm	3 Nm	1.5 Nm
	0.5 - 1 mm ²	
1/999 - 999999/1	-	1/999 - 999999/1
1/9 - 9999/1	-	1/9 - 9999/1
5000 imp/kWh	1000 imp/kWh	5000 imp/kWh
40 ms	40 ms	40 ms
B (Cl.1), C (Cl. 0,5 S) or Reactive Cl. 2	A (Cl.2), B (Cl.1) or Reactive Cl. 2	B (Cl.1), C (Cl. 0,5 S) or Reactive Cl. 2
0.5%, 1%	1%, 2%	0.5%, 1%
	-40°C - +70°C	
	-40°C - +85°C	
	75% yearly average, 95% on 30 days/year	
	Terminal 960°C, cover 650°C (IEC 60695-2-1)	
IP20 on terminal block without protective enclosure and IP51 in protective enclosure, according to IEC 60529.	IP20 on terminal block without protective enclosure and IP51 in protective enclosure, according to IEC 60529.	
Class M1 in accordance with the Measuring Instrument Directive (MID). (2004/22/EC).	Class M1 in accordance with the Measuring Instrument Directive (MID). (2004/22/EC).	
Class E2 in accordance with the Measuring Instrument Directive (MID), (2004/22/EC).	Class E2 in accordance with the Measuring Instrument Directive (MID), (2004/22/EC).	

Energy efficiency EQ meters A series



A-series

Technical features	
	A41
Outputs	
Current	2 - 100 mA
Voltage	5 - 240 V AC/DC. For meters with only 1 output, 5 - 40 V DC.
Pulse output frequency	Programmable: 1 - 999999 imp/kWh
Pulse length	Programmable: 10 - 990 ms
Terminal wire area	0.5 - 1 mm ²
Recommended tightening torque	0.25 Nm
EMC compatibility	
Impulse voltage test	6 kV 1.2/50 μs (IEC 60060-1)
Surge voltage test	4 kV 1.2/50 μs (IEC 61000-4-5)
Fast transient burn test	4 kV (IEC 61000-4-4)
Immunity to electromagnetic HF-fields	80 MHz - 2 GHz at 10 V/m (IEC 61000-4-3)
Immunity to conducted disturbance	150 kHz - 80 MHz, (IEC 61000-4-6)
Immunity to disturbance with harmonics	2kHz - 150kHz
Radio frequency emission	EN 55022, class B (CISPR22)
Electrostatic discharge	15 kV (IEC 61000-4-2)
Standards	IEC 62052-11, IEC 62053-21 class 1 & 2, IEC 62053-22 class 0,5 S, IEC 62053-23 class 2, IEC 62054-21, GB/T 17215.211-2006, GB/T 17215.321-2008 class 1 & 2, GB/T 17215.322-2008 class 0,5 S, GB 4208-2008, EN 50470-1, EN 50470-3 category A, B & C
Mechanical	
Material	Polycarbonate in transparent front glass, bottom case, upper case and terminal cover, Glass reinforced polycarbonate in terminal block.
Dimensions	
Width	70 mm
Height	97 mm
Depth	65 mm
DIN modules	4

A42	A43	A44
	2 - 100 mA	
5 - 240 V AC/DC. For meters with only 1 output, 5 - 40 V DC.	5 - 240 V AC/DC. For meters with only 1 output, 5 - 40 V DC.	
	Programmable: 1 - 999999 imp/kWh	
	Programmable: 10 - 990 ms	
	0.5 - 1 mm ²	
	0.25 Nm	
	6 kV 1.2/50 μs (IEC 60060-1)	
	4 kV 1.2/50 μs (IEC 61000-4-5)	
	4 kV (IEC 61000-4-4)	
	80 MHz - 2 GHz at 10 V/m (IEC 61000-4-3)	
	150 kHz - 80 MHz, (IEC 61000-4-6)	
	2kHz - 150kHz	
	EN 55022, class B (CISPR22)	
	15 kV (IEC 61000-4-2)	
IEC 62052-11, IEC 62053-21 class 1 & 2, IEC 62053-22 class 0,5 S, IEC 62053-23 class 2, IEC 62054-21, GB/T 17215.211-2006, GBT 17215.321-2008 class 1 & 2, GB/T 17215.322-2008 class 0,5 S, GB 4208-2008, EN 50470-1, EN 50470-3 category A, B & C	IEC 62052-11, IEC 62053-21 class 1 & 2, IEC 62053-22 class 0,5 S, IEC 62053-23 class 2, IEC 62054-21, GB/T 17215.211-2006, GBT 17215.321-2008 class 1 & 2, GB/T 17215.322-2008 class 0,5 S, GB 4208-2008, EN 50470-1, EN 50470-3 category A, B & C	
Polycarbonate in transparent front glass, bottom case, upper case and terminal cover, Glass reinforced polycarbonate in terminal block.	Polycarbonate in transparent front glass, bottom case, upper case and terminal cover, Glass reinforced polycarbonate in terminal block.	
	123 mm	
	97 mm	
	65 mm	
	7	

8

Energy efficiency EQ meters A series

The A series meters ranges from single phase to three phase meters and from basic up to advanced functionality without any comparison. The A series meters are mounted on a DIN rail and are suitable for installation in distribution boards and small enclosures such as consumer units. With the main terminals in accordance with DIN 43857 and accessible from the below the meters, the A series is suitable for many applications.

The meters support a wide voltage range as well as a wide temperature range. The display is pixel-oriented and can display up to four quantities at the same time. Navigating the meter is easily done via the push-buttons below the display. To configure the meter settings, the set button must be accessed and this button is protected against unauthorized use when the "glass lid" on the front of the meter is closed and sealed.

Data from the A series meters can be collected via pulse output or serial communication. The pulse output is a solid state relay that generates pulses proportionally to the measured energy. The meters can also be equipped with built-in serial communication interfaces for M-Bus or Modbus RTU (RS-485). Meters with RS-485 interface can also be set to communicate over the new EQ bus with the new gateway G13. All meters in the A series come with an infrared port for communication with an external Serial Communication Adapter (SCA) such as the KNX adapter.

A series supports following instrumentation values dependent on version of meter:

- Active energy
- Current
- Voltage
- Power factor
- Reactive power
- Apparent power
- Frequency
- Harmonics
- Total harmonic distortion

A series meters with a functionality level of Gold or Platinum have an internal clock for advanced functionality:

- Event log
- Previous values
- Load profile
- Maximum demand

The tariffs are controlled via inputs, via communication or via an internal clock

The A series support up to four I/O's. It can be two inputs and two outputs in a fixed configuration or four I/O points that are freely configured to input or output. Inputs can be used for counting pulses from e.g. a water meter, or reading status from external devices. Outputs can be used as pulse outputs or controlling external apparatus like a contactor or an alarm (connected via an external relay). Outputs need an external voltage supply.

The A series meters are type approved according to IEC and they are both type approved and verified according to MID. MID is the Measuring Instruments Directive 2004/22/EC from the European Commission. MID type approval and verification is mandatory for meters in billing applications within EU and EEA. The type approval is according to standards that covers all relevant technical aspects of the meter. These include climate conditions, electromagnetic compatibility (EMC), electrical requirements, mechanical requirements and accuracy.

Where to find more:

Energy Meters technical catalogue
(code 2CMC481003C0201)



Frequently asked question - FAQ:

You can find all ABB instruction manuals on www.abb.com/abblibrary/download-center

Maybe you are also interested in:

Current and Voltage Transformers
p.8/68 and p.8/81

Energy efficiency EQ meters A series



A41

Direct connected electricity meter up to 80 A. Verified and approved according to MID. IEC approval. Instrument values. Alarm function. Communication - Infrared (M-Bus).
Optional - Communication with M-Bus, RS-485 Modbus, RS-485 EQ bus.

EQ meters single phase electricity meter, 4 DIN with IR port, 80 A

Class B (Cl. 1) with functionality level Steel. Active energy

Description	Bbn	Order details		Price	Weight	Pack
	7392696	Type code	Order code	1 piece	1 piece	unit
	EAN				kg	pc.
57.7...288 V AC, Pulse output		A41 111 - 100	2CMA170554R1000		0.230	1
57.7...288 V AC, Pulse output, RS-485		A41 112 - 100	2CMA170500R1000		0.230	1
57.7...288 V AC, Pulse output, M-Bus		A41 113 - 100	2CMA100240R1000		0.230	1

Class B (Cl. 1) (Reactive Cl. 2) with functionality level Bronze. Active and reactive energy, import/export.

Description	Bbn	Order details		Price	Weight	Pack
	7392696	Type code	Order code	1 piece	1 piece	unit
	EAN				kg	pc.
57.7...288 V AC, Pulse output, RS-485		A41 212 - 100	2CMA170501R1000		0.230	1

Class 1 (Reactive Class 2) with functionality level Silver. Active and reactive energy, import/export, tariffs 1-4, tariff control via inputs and communication.

Description	Bbn	Order details		Price	Weight	Pack
	7392696	Type code	Order code	1 piece	1 piece	unit
	EAN				kg	pc.
57.7...288 V AC, 2 output, 2 input		A41 311 - 100	2CMA170502R1000		0.230	1
57.7...288 V AC, 2 output, 2 input, RS-485		A41 312 - 100	2CMA170503R1000		0.230	1
57.7...288 V AC, 2 output, 2 input. M-Bus		A41 313 - 100	2CMA170504R1000		0.230	1

Class B (Cl. 1) (Reactive Cl. 2) with functionality level Gold. Active and reactive energy, import/export, tariffs 1-4, tariff controlled via inputs, communication or clock, previous values, max and min demand.

Description	Bbn	Order details		Price	Weight	Pack
	7392696	Type code	Order code	1 piece	1 piece	unit
	EAN				kg	pc.
57.7...288 V AC, 2 output, 2 input, RS-485		A41 412 - 100	2CMA170505R1000		0.230	1
57.7...288 V AC, 2 output, 2 input, M-Bus		A41 413 - 100	2CMA170506R1000		0.230	1

Class B (Cl. 1) (Reactive Cl. 2) with functionality level Platinum. Active and reactive energy, import/export, tariffs 1-4, tariff controlled via inputs, communication or clock, previous values, max and min demand, advanced load profiles, harmonics and THD.

Description	Bbn	Order details		Price	Weight	Pack
	7392696	Type code	Order code	1 piece	1 piece	unit
	EAN				kg	pc.
57.7...288 V AC, Configurable 4 I/O channels, RS-485		A41 512 - 100	2CMA100237R1000		0.230	1
57.7...288 V AC, Configurable 4 I/O channels, M-Bus		A41 513 - 100	2CMA170508R1000		0.230	1

Energy efficiency

EQ meters A series



A42

Transformer CTVT connected electricity meter up to 6 A. Verified and approved according to MID. IEC approval. Voltage V - 57...288 V AC. Instrument values. Alarm function.

Communication - Infrared (M-Bus). Optional - Communication with M-Bus, RS-485 Modbus, RS-485 EQ bus.

EQ meters single phase electricity meter, 4 DIN with IR port, 6 A

Class B (Cl. 1) with functionality level Steel. Active energy

Description	Bbn	Order details		Price 1 piece	Weight 1 piece kg	Pack unit pc.
	7392696	Type code	Order code			
	EAN					
57.7...288 V AC, Pulse output		A42 111 - 100	2CMA170555R1000		0.200	1
57.7...288 V AC, Pulse output, RS-485		A42 112 - 100	2CMA170510R1000		0.200	1
57.7...288 V AC, Pulse output, M-Bus		A42 113 - 100	2CMA100242R1000		0.200	1

Class B (Cl. 1) (Reactive Cl. 2) with functionality level Bronze. Active and reactive energy, import/export.

Description	Bbn	Order details		Price 1 piece	Weight 1 piece kg	Pack unit pc.
	7392696	Type code	Order code			
	EAN					
57.7...288 V AC, Pulse output, RS-485		A42 212 - 100	2CMA170511R1000		0.200	1

Class B (Cl. 1) (Reactive Cl. 2) with functionality level Silver. Active and reactive energy, import/export, tariffs 1-4, tariff control via inputs and communication.

Description	Bbn	Order details		Price 1 piece	Weight 1 piece kg	Pack unit pc.
	7392696	Type code	Order code			
	EAN					
57.7...288 V AC, 2 output, 2 input, RS-485		A42 312 - 100	2CMA170512R1000		0.200	1

Class B (Cl. 1) (Reactive Cl. 2) with functionality level Gold. Active and reactive energy, import/export, tariffs 1-4, tariff controlled via inputs, communication or clock, previous values, max and min demand.

Description	Bbn	Order details		Price 1 piece	Weight 1 piece kg	Pack unit pc.
	7392696	Type code	Order code			
	EAN					
57.7...288 V AC, 2 output, 2 input, RS-485		A42 412 - 100	2CMA170513R1000		0.200	1
57.7...288 V AC, 2 output, 2 input, M-Bus		A42 413 - 100	2CMA170514R1000		0.200	1

Class C (Cl. 0.5 S) (Reactive Cl. 2) with functionality level Platinum. Active and reactive energy, import/export, tariffs 1-4, tariff controlled via inputs, communication or clock, previous values, max and min demand, advanced load profiles, harmonics and THD.

Description	Bbn	Order details		Price 1 piece	Weight 1 piece kg	Pack unit pc.
	7392696	Type code	Order code			
	EAN					
57.7...288 V AC, Configurable 4 I/O channels, RS-485		A42 552 - 100	2CMA100238R1000		0.200	1
57.7...288 V AC, Configurable 4 I/O channels, M-Bus		A42 553 - 100	2CMA170516R1000		0.200	1

Where to find more:

Energy Meters technical catalogue
(code 2CMC481003C0201)



Frequently asked question - FAQ:

You can find all ABB instruction manuals on www.abb.com/abblibrary/download-center

Maybe you are also interested in:

Current and Voltage Transformers
p.8/68 and p.8/81

Energy efficiency EQ meters A series



A43

Direct connected electricity meter up to 80 A. Verified and approved according to MID. IEC approval. 2- and 3-element metering. Instrument values. Alarm function. Communication - Infrared (M-Bus). Optional - Communication with M-Bus, RS-485 Modbus, RS-485 EQ bus.

EQ meters three phase electricity meter, 7 DIN with IR port, 80 A

Class B (Cl. 1) with functionality level Steel. Active energy

Description	Bbn	Order details		Price	Weight	Pack
	7392696			1 piece	1 piece	unit
	EAN	Type code	Order code		kg	pc.
3 x 57.7/100...288/500 V AC, Pulse output		A43 111 - 100	2CMA170520R1000		0.440	1
3 x 57.7/100...288/500 V AC, Pulse output, RS-485		A43 112 - 100	2CMA100244R1000		0.440	1
3 x 57.7/100...288/500 V AC, Pulse output, M-Bus		A43 113 - 100	2CMA100245R1000		0.440	1

Class A (Cl. 2) with functionality level Steel. Active energy

Description	Bbn	Order details		Price	Weight	Pack
	7392696			1 piece	1 piece	unit
	EAN	Type code	Order code		kg	pc.
3 x 57.7/100...288/500 V AC, Pulse output		A43 121 - 100	2CMA170521R1000		0.440	1

Class B (Cl. 1) (Reactive Cl. 2) with functionality level Bronze. Active and reactive energy, import/export.

Description	Bbn	Order details		Price	Weight	Pack
	7392696			1 piece	1 piece	unit
	EAN	Type code	Order code		kg	pc.
3 x 57.7/100...288/500 V AC, Pulse output		A43 211 - 100	2CMA100012R1000		0.440	1
3 x 57.7/100...288/500 V AC, Pulse output, RS-485		A43 212 - 100	2CMA170522R1000		0.440	1
3 x 57.7/100...288/500 V AC, Pulse output, M-Bus		A43 213 - 100	2CMA170523R1000		0.440	1

Class B (Cl. 1) (Reactive Cl. 2) with functionality level Silver. Active and reactive energy, import/export, tariffs 1-4, tariff control via inputs and communication.

Description	Bbn	Order details		Price	Weight	Pack
	7392696			1 piece	1 piece	unit
	EAN	Type code	Order code		kg	pc.
3 x 57.7/100...288/500 V AC, 2 output, 2 input		A43 311 - 100	2CMA170524R1000		0.440	1
3 x 57.7/100...288/500 V AC, 2 output, 2 input, RS-485		A43 312 - 100	2CMA170525R1000		0.440	1
3 x 57.7/100...288/500 V AC, 2 output, 2 input, M-Bus		A43 313 - 100	2CMA170526R1000		0.440	1

Class B (Cl. 1) (Reactive Cl. 2) with functionality level Gold. Active and reactive energy, import/export, tariffs 1-4, tariff controlled via inputs, communication or clock, previous values, max and min demand.

Description	Bbn	Order details		Price	Weight	Pack
	7392696			1 piece	1 piece	unit
	EAN	Type code	Order code		kg	pc.
3 x 57.7/100...288/500 V AC, 2 output, 2 input, RS-485		A43 412 - 100	2CMA170528R1000		0.440	1
3 x 57.7/100...288/500 V AC, 2 output, 2 input, M-Bus		A43 413 - 100	2CMA170529R1000		0.440	1

Class B (Cl. 1) (Reactive Cl. 2) with functionality level Platinum. Active and reactive energy, import/export, tariffs 1-4, tariff controlled via inputs, communication or clock, previous values, max and min demand, advanced load profiles, harmonics and THD.

Description	Bbn	Order details		Price	Weight	Pack
	7392696			1 piece	1 piece	unit
	EAN	Type code	Order code		kg	pc.
3 x 57.7/100...288/500 V AC, Configurable 4 I/O channels		A43 511 - 100	2CMA100143R1000		0.440	1
3 x 57.7/100...288/500 V AC, Configurable 4 I/O channels, RS-485		A43 512 - 100	2CMA170531R1000		0.440	1
3 x 57.7/100...288/500 V AC, Configurable 4 I/O channels, M-Bus		A43 513 - 100	2CMA170532R1000		0.440	1

Energy efficiency

EQ meters A series



A44

Transformer CTVT connected electricity meter up to 6 A. Verified and approved according to MID. IEC approval. 2- and 3-element metering. Instrument values. Alarm function. Communication - Infrared (M-Bus). Optional - Communication with M-Bus, RS-485 Modbus, RS-485 EQ bus.

EQ meters three phase electricity meter, 7 DIN with IR port, 6 A

Class B (Cl. 1) with functionality level Steel. Active energy

Description	Bbn	Order details		Price	Weight	Pack
	7392696	Type code	Order code	1 piece	1 piece	unit
	EAN				kg	pc.
3 x 57.7/100...288/500 V AC, Pulse output		A44 111 - 100	2CMA170533R1000		0.350	1
3 x 57.7/100...288/500 V AC, Pulse output, RS-485		A44 112 - 100	2CMA100248R1000		0.350	1
3 x 57.7/100...288/500 V AC, Pulse output, M-Bus		A44 113 - 100	2CMA100249R1000		0.350	1

Class B (Cl. 1) (Reactive Cl. 2) with functionality level Bronze. Active and reactive energy, import/export.

Description	Bbn	Order details		Price	Weight	Pack
	7392696	Type code	Order code	1 piece	1 piece	unit
	EAN				kg	pc.
3 x 57.7/100...288/500 V AC, Pulse output		A44 211 - 100	2CMA100013R1000		0.350	1
3 x 57.7/100...288/500 V AC, Pulse output, RS-485		A44 212 - 100	2CMA170534R1000		0.350	1
3 x 57.7/100...288/500 V AC, Pulse output, M-Bus		A44 213 - 100	2CMA170535R1000		0.350	1

Class B (Cl. 1) (Reactive Cl. 2) with functionality level Silver. Active and reactive energy, import/export, tariffs 1-4, tariff control via inputs and communication.

Description	Bbn	Order details		Price	Weight	Pack
	7392696	Type code	Order code	1 piece	1 piece	unit
	EAN				kg	pc.
3 x 57.7/100...288/500 V AC, 2 output, 2 input		A44 311 - 100	2CMA170536R1000		0.350	1

Class C (Cl. 0.5 S) (Reactive Cl. 2) with functionality level Silver. Active and reactive energy, import/export, tariffs 1-4, tariff control via inputs and communication.

Description	Bbn	Order details		Price	Weight	Pack
	7392696	Type code	Order code	1 piece	1 piece	unit
	EAN				kg	pc.
3 x 57.7/100...288/500 V AC, 2 output, 2 input, RS-485		A44 352 - 100	2CMA170537R1000		0.350	1
3 x 57.7/100...288/500 V AC, 2 output, 2 input, M-Bus		A44 353 - 100	2CMA170538R1000		0.350	1

Class C (Cl. 0.5 S) (Reactive Cl. 2) with functionality level Gold. Active and reactive energy, import/export, tariffs 1-4, tariff controlled via inputs, communication or clock, previous values, max and min demand.

Description	Bbn	Order details		Price	Weight	Pack
	7392696	Type code	Order code	1 piece	1 piece	unit
	EAN				kg	pc.
3 x 57.7/100...288/500 V AC, 2 output, 2 input, RS-485		A44 452 - 100	2CMA170540R1000		0.350	1
3 x 57.7/100...288/500 V AC, 2 output, 2 input, M-Bus		A44 453 - 100	2CMA170541R1000		0.350	1

Class C (Cl. 0.5 S) (Reactive Cl. 2) with functionality level Platinum. Active and reactive energy, import/export, tariffs 1-4, tariff controlled via inputs, communication or clock, previous values, max and min demand, advanced load profiles, harmonics and THD.

Description	Bbn	Order details		Price	Weight	Pack
	7392696	Type code	Order code	1 piece	1 piece	unit
	EAN				kg	pc.
3 x 57.7/100...288/500 V AC, Configurable 4 I/O channels, RS-485		A44 552 - 100	2CMA170545R1000		0.350	1
3 x 57.7/100...288/500 V AC, Configurable 4 I/O channels, M-Bus		A44 553 - 100	2CMA170546R1000		0.350	1

Where to find more:

Energy Meters technical catalogue (code 2CMC481003C0201)



Frequently asked question - FAQ:
You can find all ABB instruction manuals on www.abb.com/abblibrary/download-center

Maybe you are also interested in:
Current and Voltage Transformers
p.8/68 and p.8/81

Energy efficiency

Selection guide

How do I select the best meter for my application?

There are many versions of EQ meters in order to meet your requests. The EQ program comprises meters with different functionalities such as tariffs, communication interfaces or advanced clock functions. Spend a little time to evaluate the functions and imagine how they could add extra value to your metering. For example, the input counter (from silver level) on an EQ meter can be used to count products produced by a machine and be read out together with the energy consumption of the same machine. In one easy go you can allocate energy to any produced product from one source. Another useful function is previous values (from gold level). If you charge users in intervals the meter can secure the data even in the event of a broken communication link. You can collect the correct interval data later and also make it visible for your counterpart immediately on the meters display in case of any discussions.

Make the meter to an asset.

Take the step from passive meter reading to an active user of the data you can retrieve. The meter can be an important asset for you in order to avoid costs like penalties or extra charge for reactive energy (from bronze level). Keep track of your maximum demand and reduce them to avoid charges. EQ meters can tell you the value of the maximum demand and also when it occurred. Harmonics is the source of many problems for all sorts of equipment connected to the low voltage network. Use an EQ meter (platinum level) to measure the THD and isolate the source before you have to take the cost and consequences of poor power quality.

Function	Single phase				Three phase				
	C11	B21	A41	A42	C13	B23	B24	A43	A44
Direct connected	1	1 2 3	1 2 3 4 5		1	1 2 3		1 3 5	
Transformer connected				1 2 3 4 5			1 2 3		1 2 3 4 5
2 element metering						1 2 3		2 3 4 5	1 2 3 4 5
3 element metering					1	1 2 3	1 2 3	1 2 3 4 5	1 2 3 4 5
Accuracy 1%, Class 1, Class B	1	1 2 3	1 2 3 4 5	1 2 3 4	1	2	1 2	1 2 3 4 5	1 2 3
Accuracy 0,5%, Class 0.5s, Class C				5			3		3 4 5
Active energy	1	1 2 3	1 2 3 4 5	1 2 3 4 5	1	1 2 3	1 2 3	1 2 3 4 5	1 2 3 4 5
Reactive energy		2 3	2 3 4 5	2 3 4 5		2 3	2 3	2 3 4 5	2 3 4 5
Apparent energy		2 3	2 3 4 5	2 3 4 5		2 3	2 3	2 3 4 5	2 3 4 5
Import/Export energy		2 3	2 3 4 5	2 3 4 5		2 3	2 3	2 3 4 5	2 3 4 5
Tariff registers, 1-4		3	3 4 5	3 4 5		3	3	3 4 5	3 4 5
Instrument values	1	1 2 3	1 2 3 4 5	1 2 3 4 5	1	1 2 3	1 2 3	1 2 3 4 5	1 2 3 4 5
Alarm function	1	1 2 3	1 2 3 4 5	1 2 3 4 5	1	1 2 3	1 2 3	1 2 3 4 5	1 2 3 4 5
Harmonics, THD and no 2-16				5					5
Previous values - day, week, month				4 5				4 5	4 5
Max and min demand				4 5				4 5	4 5
Load profiles - 8 channels				5				5	5
Pulse output	1	1 2	1 2	1 2	1	1 2	1 2	1 2	1 2
I/O board - 2 in, 2 out		3	3 4	3 4		3	3	3 4	3 4
Configurable I/O - 4 I/O channels				5				5	5
Tariffs controlled by input		3	3 4 5	3 4 5		3	3	3 4 5	3 4 5
Tariffs controlled by communication		3	3 4 5	3 4 5		3	3	3 4 5	3 4 5
Tariffs controlled by clock			4 5	4 5				4 5	4 5
MID approved, verified	optional	1 2 3	1 2 3 4 5	1 2 3 4 5	optional	1 2 3	1 2 3	1 2 3 4 5	1 2 3 4 5
IEC approved	1	1 2 3	1 2 3 4 5	1 2 3 4 5	1	1 2 3	1 2 3	1 2 3 4 5	1 2 3 4 5
Communication - Infrared (M-Bus)		1 2 3	1 2 3 4 5	1 2 3 4 5		1 2	1 2 3	1 2 3 4 5	1 2 3 4 5
Communication - M-Bus		optional	optional	optional		optional	optional	optional	optional
Communication - RS-485 Modbus		optional	optional	optional		optional	optional	optional	optional
Communication - RS-485 EQ bus		optional	optional	optional		optional	optional	optional	optional

- 1 = Steel
- 2 = Bronze
- 3 = Silver
- 4 = Gold
- 5 = Platinum
- = Not available
- Optional = Available on some order codes

Energy efficiency EQ meters B series



B-series

2CSC40002D0211

Technical features	
B21	
Voltage/current inputs	
Nominal voltage	230 V AC
Voltage range	220...240 VAC (-20% - +15%)
Power dissipation voltage circuits	0.9 VA (0,4 W) total
Power dissipation current circuits	0.014 VA (0.014 W) at 230 V AC and I_b
Base current I_b	5 A
Rated current I_n	-
Reference current I_{ref}	5 A
Transitional current I_{tr}	0.5 A
Maximum current I_{max}	65 A
Minimum current I_{min}	0.25 A
Starting current I_{st}	< 20 mA
Terminal wire area	1 - 25 mm ²
Recommended tightening torque	3 Nm
Communication	
Terminal wire area	0.5 - 1 mm ²
Recommended tightening torque	0.25 Nm
Transformer ratios	
Configurable current ratio (CT)	-
Pulse indicator (LED)	
Pulse frequency	1000 imp/kWh
Pulse length	40 ms
General data	
Frequency	50 or 60 Hz ± 5%
Accuracy Class	B (Cl. 1) and Reactive Cl. 2
Active energy	1%
Display of energy	6 digit LCD
Environmental	
Operating temperature	-40°C - +70°C
Storage temperature	-40°C - +85°C
Humidity	75% yearly average, 95% on 30 days/year
Resistance to fire and heat	Terminal 960 °C, cover 650°C (IEC 60695-2-1)
Resistance to water and dust	IP20 on terminal block without protective enclosure and IP51 in protective enclosure, according to IEC 60529.
Mechanical environment	Class M1 in accordance with the Measuring Instrument Directive (MID), (2004/22/EC).
Electromagnetic environment	Class E2 in accordance with the Measuring Instrument Directive (MID), (2004/22/EC).
Outputs	
Current	2 - 100 mA
Voltage	5 - 240 V AC/DC. For meters with only 1 output 5 - 40 VDC.



Energy efficiency EQ meters B series



B-series

▲ Technical features	
	B21
Pulse output frequency	Programmable 1 - 999999 imp/kWh
Pulse length	Programmable 10 - 990 ms
Terminal wire area	0.5 - 1 mm ²
Recommended tightening torque	0.25 Nm
Inputs	
Voltage	0 - 240 V AC/DC
OFF	0 - 12 V AC/DC
ON	57 - 240 V AC/24 - 240 V DC
Min. pulse length	30 ms
Terminal wire area	0.5 - 1 mm ²
Recommended tightening torque	0.25 Nm
EMC compatibility	
Impulse voltage test	6 kV 1.2/50µs (IEC 60060-1)
Surge voltage test	4 kV 1.2/50µs (IEC 61000-4-5)
Fast transient burn test	4kV (IEC 61000-4-4)
Immunity to electromagnetic HF-fields	80 MHz - 2 GHz (IEC 61000-4-6)
Immunity to conducted disturbance	150kHz - 80MHz (IEC 61000-4-6)
Immunity to disturbance with harmonics	2kHz - 150kHz
Radio frequency emission	EN 55022, class B (CISPR22)
Electrostatic discharge	15 kV (IEC 61000-4-2)
Standards	IEC 62052-11, IEC 62053-21 class 1 & 2, IEC 62053-22 class 0,5 S, IEC 62053-23 class 2, IEC 62054-21, GB/T 17215.211-2006, GB/T 17215.312-2008 class 1 & 2, GB/T 17215.322-2008 class 0,5 S, GB 4208-2008, EN 50470-1, EN 50470-3 category A, B & C
Mechanical	
Material	Polycarbonate in transparent front glass. Glass reinforced polycarbonate in bottom case and upper case. Polycarbonate in terminal cover.
Dimensions	
Width	35 mm
Height	97 mm
Depth	65 mm
DIN modules	2

B23

B24

8

IEC 62052-11, IEC 62053-21 class 1 & 2, IEC 62053-22 class 0,5 S, IEC 62053-23 class 2, IEC 62054-21, GB/T 17215.211-2006, GB/T 17215.312-2008 class 1 & 2, GB/T 17215.322-2008 class 0,5 S, GB 4208-2008, EN 50470-1, EN 50470-3 category A, B & C

Polycarbonate in transparent front glass. Glass reinforced polycarbonate in bottom case and upper case. Polycarbonate in terminal cover.

70 mm

97 mm

65 mm

4

Energy efficiency

EQ meters B series

The EQ meters, B series is a range of meters for single phase and three phase metering. The B series meters are mounted on a DIN rail and are suitable for installation in distribution boards and small enclosures such as consumer units. The B series are suitable in applications where there is a need for reliable energy measurements and where space is limited.

The B series meters are high runner meters for many applications and installations. Navigating the meter is easily done via the push-buttons below the display. To configure the meter settings, the set button must be accessed and this button is protected against unauthorized use when the "glass lid" on the front of the meter is closed and sealed. The power consumption of the meter is very low, less than 0.8 VA.

Data from the B series meters can be collected via pulse output or serial communication. The pulse output is a solid state relay that generates pulses proportionally to the measured energy. The meters can also be equipped with built-in serial communication interfaces for M-Bus or Modbus RTU (RS-485). Meters with RS-485 interface can also be set to communicate over the new EQ bus with the new gateway G13. All meters in the B series come with an infrared port for communication with an external Serial Communication Adapter (SCA) such as the KNX adapter.

The B series meters support reading of instrument values. A large number of electrical properties can be read. Depending on version of the meter the following data is available:

- Active power
- Apparent power
- Reactive power
- Current
- Voltage
- Frequency
- Power factor

The tariffs are controlled via inputs or communication.

The B series support two inputs and two outputs in a fixed configuration. Inputs can be used for counting pulses from e.g. a water meter, or reading status from external devices. Outputs can be used as pulse outputs or controlling external apparatus like a contactor or an alarm (connected via an external relay).

The B series meters are type approved according to IEC and they are both type approved and verified according to MID. MID is the Measuring Instruments Directive 2004/22/EC from the European Commission. MID type approval and verification is mandatory for meters in billing applications within EU and EEA. The type approval is according to standards that covers all relevant technical aspects of the meter. These include climate conditions, electromagnetic compatibility (EMC), electrical requirements, mechanical requirements and accuracy.

Where to find more:

Energy Meters technical catalogue
(code 2CMC481003C0201)



Frequently asked question - FAQ:

You can find all ABB instruction manuals on www.abb.com/abblibrary/download-center

Maybe you are also interested in:

Current and Voltage Transformers
p.8/68 and p.8/81



B21

Direct connected electricity meter up to 65 A. Verified and approved according to MID. IEC approval. Instrument values. Alarm function. - Communication - Infrared (M-Bus).
Optional - Communication with M-Bus, RS-485 Modbus, RS-485 EQ bus.

EQ meters single phase electricity meter, 2 DIN with IR port, 65 A

**For direct connection up to 65 A. Class B (Cl. 1) with functionality level Steel.
Active energy**

Description	Bbn	Order details		Price 1 piece	Weight 1 piece kg	Pack unit pc.
	7392696	Type code	Order code			
	EAN					
1 x 230 V AC, Pulse output		B21 111 - 100	2CMA100149R1000		0.140	1
1 x 230 V AC, Pulse output, RS-485		B21 112 - 100	2CMA100150R1000		0.150	1
1 x 230 V AC, Pulse output, M-Bus		B21 113 - 100	2CMA100151R1000		0.150	1

**For direct connection up to 65 A. Class B (Cl. 1) (Reactive Cl. 2) with functionality level Bronze.
Active and reactive energy, import/export.**

Description	Bbn	Order details		Price 1 piece	Weight 1 piece kg	Pack unit pc.
	7392696	Type code	Order code			
	EAN					
1 x 230 V AC, Pulse output, RS-485		B21 212 - 100	2CMA100152R1000		0.150	1

**For direct connection up to 65 A. Class B (Cl. 1) (Reactive Cl. 2) with functionality level Silver.
Active and reactive energy, import/export, tariffs 1-4, tariff control via inputs and communication.**

Description	Bbn	Order details		Price 1 piece	Weight 1 piece kg	Pack unit pc.
	7392696	Type code	Order code			
	EAN					
1 x 230 V AC, 2 output, 2 input		B21 311 - 100	2CMA100154R1000		0.140	1
1 x 230 V AC, 2 output, 2 input, RS-485		B21 312 - 100	2CMA100155R1000		0.150	1
1 x 230 V AC, 2 output, 2 input, M-Bus		B21 313 - 100	2CMA100156R1000		0.150	1

Energy efficiency

EQ meters B series



B23

Direct connected electricity meter up to 65 A. Verified and approved according to MID. IEC approval. 2- and 3-element metering. Instrument values. Alarm function. Communication - Infrared (M-Bus). Optional - Communication with M-Bus, RS-485 Modbus, RS-485 EQ bus.

EQ meters three phase electricity meter, 4 DIN with IR port, 65 A

Class B (Cl. 1) with functionality level Steel. Active energy

Description	Bbn	Order details		Price 1 piece	Weight 1 piece kg	Pack unit pc.
	7392696	Type code	Order code			
	EAN					
3 x 230/400 V AC, Pulse output		B23 111 - 100	2CMA100163R1000		0.310	1
3 x 230/400 V AC, Pulse output, RS-485		B23 112 - 100	2CMA100164R1000		0.320	1
3 x 230/400 V AC, Pulse output, M-Bus		B23 113 - 100	2CMA100165R1000		0.330	1

Class B (Cl. 1) (Reactive Cl. 2) with functionality level Bronze. Active and reactive energy, import/export.

Description	Bbn	Order details		Price 1 piece	Weight 1 piece kg	Pack unit pc.
	7392696	Type code	Order code			
	EAN					
3 x 230/400 V AC, Pulse output, RS-485		B23 212 - 100	2CMA100166R1000		0.320	1

Class B (Cl. 1) (Reactive Cl. 2) with functionality level Silver. Active and reactive energy, import/export, tariffs 1-4, tariff controll via inputs and communication.

Description	Bbn	Order details		Price 1 piece	Weight 1 piece kg	Pack unit pc.
	7392696	Type code	Order code			
	EAN					
3 x 230/400 V AC, 2 output, 2 input		B23 311 - 100	2CMA100168R1000		0.330	1
3 x 230/400 V AC, 2 output, 2 input, RS-485		B23 312 - 100	2CMA100169R1000		0.340	1
3 x 230/400 V AC, 2 output, 2 input, M-Bus		B23 313 - 100	2CMA100170R1000		0.350	1

Where to find more:

Energy Meters technical catalogue
(code 2CMC481003C0201)



Frequently asked question - FAQ:

You can find all ABB instruction manuals on www.abb.com/abblibrary/download-center

Maybe you are also interested in:

Current and Voltage Transformers
p.8/68 and p.8/81

Energy efficiency

EQ meters B series



B24

Transformer CT connected electricity meter up to 6 A. Verified and approved according to MID. IEC approval. 2- and 3-element metering. Instrument values. Alarm function. Communication - Infrared (M-Bus). Optional - Communication with M-Bus, RS-485 Modbus, RS-485 EQ bus.

EQ meters three phase electricity meter, 4 DIN with IR port, 6 A

Class B (Cl. 1) with functionality level Steel. Active energy

Description	Bbn	Order details		Price 1 piece	Weight 1 piece	Pack unit
	7392696	Type code	Order code			
	EAN				kg	pc.
3 x 230/400 V AC, Pulse output		B24 111 - 100	2CMA100177R1000		0.250	1
3 x 230/400 V AC, Pulse output, RS-485		B24 112 - 100	2CMA100178R1000		0.250	1
3 x 230/400 V AC, Pulse output, M-Bus		B24 113 - 100	2CMA100179R1000		0.270	1

Class B (Cl. 1) (Reactive Cl. 2) with functionality level Bronze. Active and reactive energy, import/export.

Description	Bbn	Order details		Price 1 piece	Weight 1 piece	Pack unit
	7392696	Type code	Order code			
	EAN				kg	pc.
3 x 230/400 V AC, Pulse output, RS-485		B24 212 - 100	2CMA100180R1000		0.250	1

Class C (Cl. 0.5 S) (Reactive Cl. 2) with functionality level Silver. Active and reactive energy, import/export, tariffs 1-4, tariff control via inputs and communication.

Description	Bbn	Order details		Price 1 piece	Weight 1 piece	Pack unit
	7392696	Type code	Order code			
	EAN				kg	pc.
3 x 230/400 V AC, 2 output, 2 input		B24 351 - 100	2CMA100182R1000		0.270	1
3 x 230/400 V AC, 2 output, 2 input, RS-485		B24 352 - 100	2CMA100183R1000		0.270	1
3 x 230/400 V AC, 2 output, 2 input, M-Bus		B24 353 - 100	2CMA100184R1000		0.290	1

8

Energy efficiency EQ meters C series



C-series

Technical features		
	C11	C13
Voltage/current inputs		
Nominal voltage	230 V AC	3x230/400 V AC
Voltage range	230 V AC (-20% - +15%)	3x230/400 V AC (-20% - +15%)
Power dissipation voltage circuits	< 0.8 VA (0.2 W) total	1.5 VA (0.6 W) total
Power dissipation current circuits	0.02 W at 230 V AC and I_b	0.04 VA (0.04 W) per phase at 230 V AC and I_b
Base current I_b	5 A	
Rated current I_n	-	
Reference current I_{ref}	5 A	
Transitional current I_{tr}	0.5 A	
Maximum current I_{max}	40 A	
Minimum current I_{min}	0.25 A	
Starting current I_{st}	< 20 mA	
Terminal wire area	1 - 10 mm ²	0.5 - 10 mm ²
Recommended tightening torque	0.8 Nm	
General data		
Frequency	50 or 60 Hz ± 5%	
Accuracy Class	B (Cl.1)	
Active energy	1%	
Display of energy	6 digits LCD	
Communication		
Terminal wire area	-	
Recommended tightening torque	-	
Pulse indicator (LED)		
Pulse frequency	1000 imp/kWh	
Pulse length	40 ms	
Environmental		
Operating temperature	- 25°C - +70°C	
Storage temperature	- 25°C - +85°C	
Humidity	75% yearly average, 95% on 30 days/year	
Resistance to fire and heat	Terminal 960°C, cover 650°C (IEC 60695-2-1)	
Resistance to water and dust	IP20 on terminal block without protective enclosure and IP51 in protective enclosure, according to IEC 60529.	
Mechanical environment	Class M1 in accordance with the Measuring Instrument Directive (MID). (2004/22/EC).	
Electromagnetic environment	Class E2 in accordance with the Measuring Instrument Directive (MID), (2004/22/EC).	

Technical features		
	C11	C13
Outputs		
Current	2 - 100 mA	
Voltage	5 - 40 V DC	
Pulse output frequency	100 (imp/kWh)	
Pulse length	200 ms	
Terminal wire area	0.5 - 6 mm ²	
Recommended tightening torque	0.8 Nm	
EMC compatibility		
Impulse voltage test	6 kV 1.2/50 μs (IEC 60060-1)	
Surge voltage test	4 kV 1.2/50 μs (IEC 61000-4-5)	
Fast transient burn test	4 kV (IEC 61000-4-4)	
Immunity to electromagnet HF-fields	80 MHz - 2 GHz at 10 V/m (IEC 61000-4-3)	
Immunity to conducted disturbance	150 kHz - 80 MHz, (IEC 61000-4-6)	
Immunity to disturbance with har- monics	2kHz - 150kHz	
Radio frequency emission	EN 55022, class B (CISPR22)	
Electrostatic discharge	15 kV (IEC 61000-4-2)	
Standards	IEC 62052-11, IEC 62053-21 class 1, GB/T 17215.211-2006, GBT 17215.321-2008 class 1, GB 4208-2008, EN 50470-1, EN 50470-3 category B	
Mechanical		
Material	Glass reinforced polycarbonate	
Dimensions		
Width	17,5 mm	54 mm
Height	111 mm	122 mm
Depth	65 mm	65 mm
DIN modules	1	3

Energy efficiency EQ meters C series

The EQ meters, C series are truly compact meters for single phase and three phase metering. The C series is mounted on a DIN rail and is suitable for installation in distribution boards and small consumer units.

Only one module wide, the C series is a very compact meter for single phase and three phase applications. The meters have an LCD with large digits showing energy register and instrumentation values. The meters have a wide temperature range which makes it possible to install the meters in many locations. Navigating the meters are easily done via the push-button below the display.

The C series meters support reading of instrument values. A number of electrical properties can be read:

- Power factor
- Active power
- Current
- Voltage

The C series meters have an output that can be used as pulse output or alarm output. The alarm quantity and levels is easily configured on the meter with the push button. The output can be used for controlling external apparatus like a contactor or an alarm indicator (connected via an external relay).

The C series meters are type approved according to IEC and MID. MID is the Measuring Instruments Directive 2004/22/EC from the European Commission. The type approval is according to standards that covers all relevant technical aspects of the meter. These include climate conditions, electromagnetic compatibility (EMC), electrical requirements, mechanical requirements and accuracy.

MID versions have initial verification according to annex F of the Measuring Instruments Directive.

Where to find more:

Energy Meters technical catalogue
(code 2CMC481003C0201)



Frequently asked question - FAQ:

You can find all ABB instruction manuals on www.abb.com/abblibrary/download-center

Maybe you are also interested in:

Current and Voltage Transformers
p.8/68 and p.8/81



C11

Direct connected electricity meter up to 40 A. IEC approval. Instrument values. Alarm function. Optional - Verified and approved according to MID, 1 DIN.

EQ meters single phase electricity meter, 1 DIN, 40 A

Class B (Cl.1) with functionality level Steel. Active energy

Description	Bbn	Order details		Price	Weight	Pack
	7392696	Type code	Order code	1 piece	1 piece	unit
	EAN				kg	pc.
1 x 230 V AC, Pulse output		C11 111 - 100*)	2CMA100014R1000		0.070	1

Class 1 with functionality level Steel. Active energy

1 x 230 V AC, Pulse output		C11 110 - 300	2CMA170550R1000		0.070	1
----------------------------	--	---------------	-----------------	--	-------	---



C13

Direct connected electricity meter. IEC approval. 3 element metering. Instrument values. Alarm function. Optional - Verified and approved according to MID, 3DIN.

EQ meters three phase electricity meter, 1 DIN, 40 A

For direct connection up to 40 A. Class B (Cl.1) with functionality level Steel. Active energy

Description	Bbn	Order details		Price	Weight	Pack
	7392696	Type code	Order code	1 piece	1 piece	unit
	EAN				kg	pc.
3 x 230/400 V AC, Pulse output		C13 110 - 100*)	2CMA100191R1000		0.170	1

For direct connection up to 40 A. Class 1 with functionality level Steel. Active energy

3 x 230/400 V AC, Pulse output		C13 110 - 300	2CMA100192R1000		0.170	1
--------------------------------	--	---------------	-----------------	--	-------	---

*) MID approval

Energy efficiency EQ meters G series

G13 is the new Ethernet gateway that will make data collection from a meter network very convenient. Communication is performed using JSON (JavaScript Object Notation) on the Ethernet side. The gateway is also equipped with a webserver that provides a detailed overview of all meters installed in a network as well as the possibility to perform advanced configurations of the meters and read-out data. High data security is obtained by encryption using SSL (Secure Sockets Layer).

The gateway communicates with EQ meters over EQ bus, a communication protocol based on the IEC standards (DLMS/cosem), using RS-485, and can also work as an M-Bus master for M-Bus enabled ABB meters.

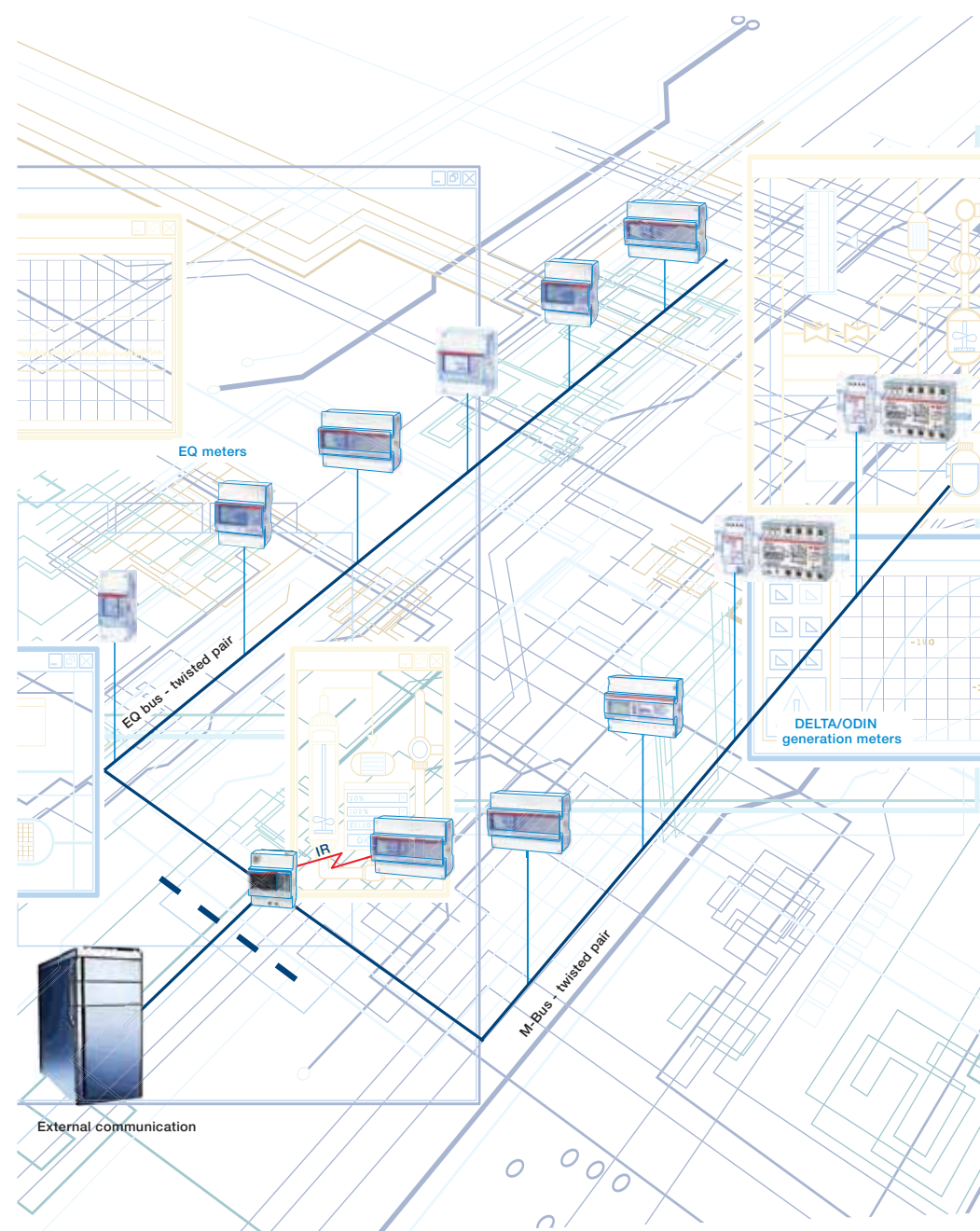

Where to find more:
Energy Meters technical catalogue
(code 2CMC481003C0201)



Frequently asked question - FAQ:
You can find all ABB instruction manuals on www.abb.com/abblibrary/download-center

Maybe you are also interested in:
Current and Voltage Transformers
p.8/68 and p.8/81



G13

2CMA170552R1000

Gateway for routing and protocol conversion between system and meter network with up to 32 meters.

Communication protocols on the meter side: EQ bus over RS-485, M-Bus and ABB IR port.
Communication protocols on the system side: Ethernet with JSON. Built-in webserver for meter reading and meter management.

Ethernet gateway

Description	Bbn	Order details		Price	Weight	Pack
	7392696	Type code	Order code	1 piece	1 piece	unit
	EAN				kg	pc.
100 - 240 V AC		G13 100-000	2CMA170552R1000		0.170	1

Energy efficiency

Analogue and digital instruments selection table

Measure	Technology	Mounting	Insertion	Characteristics	Accessories	Type	
Voltage	Analogue	3 modules	Direct	a.c. and d.c.	MCV voltage switches	VLM pag.8/18	
		48x48, 72x72, 96x96	Direct		MCV voltage switches	VLM-1 VLM-2 pag.8/22	
		48x48, 72x72, 96x96	Indirect		TV voltage transformers MCV voltage switches	VLM1-TV VLM2-TV pag.8/22	
	Digital	3 modules	Direct	a.c. and d.c. Auxiliary supply 230 V a.c.	MCV voltage switches	VLMD pag.8/13	
		36x72	Direct		MCV voltage switches	VLMD P pag.8/14	
Current	Analogue	3 modules	Direct	a.c. and d.c.	MCA current switches	AMT pag.8/18	
			Indirect		CT a.c. current transformer SNT shunt for d.c. SCL interchangeable scale MCA current switches	AMT1/A AMT2 pag.8/18	
		48x48, 72x72, 96x96	Direct		MCA current switches	AMT1-A1 AMT2-A2 pag.8/24	
		Indirect	CT a.c. current transformer SNT shunt for d.c. SCL interchangeable scale MCA current switches		AMT1-A1 AMT1-A5 AMT2-A2 pag.8/24		
	Digital	3 modules	Indirect	a.c. and d.c. Auxiliary supply 230 V a.c.	CT a.c. current transformer SNT shunt for d.c. MCA current switches	AMTD pag.8/13	
			36x72	Indirect		CT a.c. current transformer SNT shunt for d.c. MCA current switches	AMTD P pag.8/14
Frequency	Analogue	3 modules	Direct	a.c.		FRZ1 pag.8/18	
		48x48, 72x72, 96x96	Direct			FRZ pag.8/25	
	Digital	3 modules	Direct	Auxiliary supply 230 V a.c.		FRZ-DIG pag.8/13	

8

Energy efficiency

Modular digital instruments



Digital instruments

Technical features		
Power supply	[V]	230 V a.c.
Rated frequency	[Hz]	50÷60
Ammeter full scale value	[A]	5, 20, 25, 40, 60, 100, 150, 200, 250, 400, 600
Voltmeter full scale value	[V]	300, 500
Frequency meter range	[Hz]	35...400
Tripping delay	[s]	1, 5, 10, 20, 30
Hysteresis	[%]	5, 10, 20, 30 set threshold
Output pins		3-4
Output relay		NO
Rated voltage relay	[V]	230 V a.c.
Rated current relay	[A]	AC1 16, AC15 3
Relay configuration		NO relay closes in alarm status NC relay opens in alarm status, positive safety
Overload	[In/Vn]	1, 2
Accuracy class	[%]	±0,5 full scale ±1digit at 25 °C
Max. signal input value for ammeters		5 A a.c./60 mV d.c.
Display		3 digit LED display
Operating temperature	[°C]	-10...+55
Storage temperature	[°C]	-40...+70
Protection degree		IP20
Power consumption	[VA]	4
Modules		3
Overall dimensions front panel devices	[mm]	36x72x61.5 (51.5 depth inside the switchboard)
Standard		IEC EN 61010

Energy efficiency

Modular digital instruments



VLMD



AMTD



FRZ

Modular digital instruments

The wide range of modular digital instruments starts with single-phase mono-function measurement devices for measuring voltage, current and frequency.

The range is composed by a voltmeter for a.c./d.c. voltage monitoring, two ammeters for a.c. and d.c. current, and a frequency meter. Ammeters measure in indirect insertion thanks to measuring accessories, like current transformer for a.c. and shunt for d.c.

The full-scale value is programmable by the user, according to the current flow on the primary windings.

Version	Bbn 8012542	Order details		Price 1 piece	Weight 1 piece kg	Pack unit pc.
	EAN	Type code	Order code			
a.c./d.c. digital voltmeter	620402	VLMD-1-2	2CSM110000R1011		0,300	1
a.c. digital ammeter	620501	AMTD-1	2CSM320000R1011		0,300	1
d.c. digital ammeter	620600	AMTD-2	2CSM420000R1011		0,300	1
Digital frequency meter	620709	FRZ-DIG	2CSM710000R1011		0,300	1

Modular digital instruments with alarm relay

The range is widened by three additional devices with extended features: one voltmeter and two ammeters, trip the internal relay to signal an alarm condition if the measured parameter exceeds or falls below a programmable threshold. The measured maximum and minimum peak values are stored in the non-volatile instrument's memory.

The contact type is NO, so that the contact is open when the instrument is powered off, but it is possible to obtain positive safety operation setting, directly on the instrument, the NC relay contact type.

The instrument with relay can be used to signal the exceeding or the fall below a certain threshold, but not for both functions simultaneously.

Version	Bbn 8012542	Order details		Price 1 piece	Weight 1 piece kg	Pack unit pc.
	EAN	Type code	Order code			
a.c./d.c. digital voltmeter with alarm relay	746935	VLMD-1-2-R	2CSM274693R1011		0,300	1
a.c. digital ammeter with alarm relay	747734	AMTD-1-R	2CSM274773R1011		0,300	1
d.c. digital ammeter with alarm relay	610731	AMTD-2-R	2CSM261073R1011		0,300	1

Where to find more:
Digital Instruments brochure (code
2CSC445018B0202)



Maybe you are also interested in:
Current and Voltage Transformers
p.8/68 and p.8/81
Voltmetric and Current Switches
p.8/64

Energy efficiency

Front panel digital instruments



VLMD P



AMTD- P

Front-panel digital instruments

The wide range of front-panel digital instruments starts with single-phase mono-function measurement devices for measuring voltage and current.

The range is composed by a voltmeter for a.c./d.c. voltage monitoring, and two ammeters for a.c. and d.c. current. Ammeters measure in indirect insertion thanks to measuring accessories, like current transformer for a.c. and shunt for d.c.

The full-scale value is programmable by the user, according to the current flow on the primary windings.

Version	Bbn 8012542	Order details		Price 1 piece	Weight 1 piece	Pack unit
	EAN	Type code	Order code			
a.c./d.c. digital voltmeter	136057	VLMD P	2CSG213605R4011		0,300	1
a.c. digital ammeter	136156	AMTD-1 P	2CSG213615R4011		0,300	1
d.c. digital ammeter	136255	AMTD-2 P	2CSG213625R4011		0,300	1

Front-panel digital instruments with alarm relay

The range is widened by three additional devices with extended features: one voltmeter and two ammeters that trip the internal relay to signal an alarm condition if the measured parameter exceeds or falls below a programmable threshold. The measured maximum and minimum peak values are stored in the non-volatile instrument's memory.

The contact type is NO, so that the contact is open when the instrument is powered off, but it is possible to obtain positive safety operation setting, directly on the instrument, the NC relay contact type.

The instrument with relay can be used to signal the exceeding or the fall below a certain threshold, but not for both functions simultaneously.

Version	Bbn 8012542	Order details		Price 1 piece	Weight 1 piece	Pack unit
	EAN	Type code	Order code			
a.c./d.c. digital voltmeter with alarm relay	136354	VLMD-R P	2CSG213635R4011		0,300	1
a.c. digital ammeter with alarm relay	136453	AMTD-1-R P	2CSG213645R4011		0,300	1
d.c. digital ammeter with alarm relay	136552	AMTD-2-R P	2CSG213655R4011		0,300	1

8

Where to find more:
Digital Instruments brochure (code
2CSC445018B0202)



Maybe you are also interested in:
Current and Voltage Transformers
p.8/68 and p.8/81
Voltmetric and Current Switches
p.8/64

Energy efficiency

Analogue instruments selection table

Instrument mounting	a.c / d.c.	Size	Full-scale value Visualization	Instrument type	Scale type
Modular	a.c.	-	90°	AMT1/A1 	SCL 1 
		-	78°	AMT1/A5 	SCL 1/A5 
	d.c.	-	90°	AMT2 	SCL 2 
Front-panel	a.c.	48x48 mm	90°	AMT1-A1/48 	SCL-A1 ... /48 
			78°	AMT1-A5/48 	SCL-A5 ... /48 
		72x72 mm	90°	AMT1-A1/72 	SCL-A1 ... /72 
			78°	AMT1-A5/72 	SCL-A5 ... /72 
		96x96 mm	90°	AMT1-A1/96 	SCL-A1 ... /96 
			78°	AMT1-A5/96 	SCL-A5 ... /96 
	d.c.	48x48 mm	90°	AMT2-A2/48 	SCL-A2 ... /48 
			72x72 mm	90°	AMT2-A2/72 
		96x96 mm	90°	AMT2-A2/96 	SCL-A2 ... /96 

Analogue instruments with scales

The range of mono-function analogue instruments, employable in single-phase networks, is composed of measurement devices performing the measure and visualization of one electrical parameter: voltage, current and frequency.

The range of voltmeters, both in modular and front-panel versions, is composed by devices fully equipped with the proper scale, even when the use of a voltage transformer is required. The connection, whether it's direct or indirect using VT, allows the immediate visualization of the measures on the display.

The range of ammeters is composed of devices for direct and indirect connection to the network. The devices directly connected to the network are fully equipped with proper scale, while the devices that require a current transformer or a shunt, need to be combined with a separate scale to be mounted on the front of the instrument.

The wide range of scales for ammeters allows the employability of the latter even in application with high nominal current, up to 10000 A a.c.

Energy efficiency

Modular analogue instruments



VLM1



AMT1

Technical features			
Rated voltage Un	[V]	a.c. 300, 500; d.c. 100, 300	
Rated currents in a.c.	Direct reading	[A]	full scale values 5...30
	Indirect reading		full scale values 5...2500
Rated currents in d.c.	Direct reading	[A]	full scale values 0.1...30
	Indirect reading		full scale values 5...500
Frequency	[Hz]	50/60	
Overload capacity	[%]	20 compared to the voltage or to the rated current	
Accuracy class	[%]	1.5 (0.5 for frequency meters)	
Ammeters power consumption	[VA]	5 A: 0.3 VA; 10 A: 0.6 VA; 25 A:1 VA; 30 A: 1.2 VA	
Voltmeters power consumption	[VA]	300 V: 1.5 VA; 500 V: 4 VA	
Frequency meters power consumption	[VA]	<1.5 VA	
Modules	[No.]	3	
Protection degree		IP20	
Standards		EN 60051	

The range of modular analogue instruments is composed by mono-function measurement devices employable in single-phase networks. It includes voltmeters, ammeters and frequency meters.

In particular, the range of ammeters is composed of devices fully equipped with the appropriate scale in the range between 5 A and 30 A. In case of greater current values, the range features devices to be used together with the proper scale and CT according to the application.

8

Modular analogue instruments for alternating current

Suitable for direct or indirect measurement through the appropriate accessories.

Voltmeters: direct connection						
Scale	Bbn	Order details		Price 1 piece	Weight 1 piece	Pack unit
	8012542	Type code	Order code			
	EAN				kg	pc.
300 V	007906	VLM1/300	2CSM110190R1001		0.200	1
500 V	000006	VLM1/500	2CSM110220R1001		0.200	1

Ammeters: direct connection						
Scale	Bbn	Order details		Price 1 piece	Weight 1 piece	Pack unit
	8012542	Type code	Order code			
	EAN				kg	pc.
5 A	000709	AMT1/5	2CSM310030R1001		0.200	1
10 A	000105	AMT1/10	2CSM310040R1001		0.200	1
15 A	000204	AMT1/15	2CSM310050R1001		0.200	1
20 A	000303	AMT1/20	2CSM310060R1001		0.200	1
25 A	000402	AMT1/25	2CSM310070R1001		0.200	1
30 A	000501	AMT1/30	2CSM310080R1001		0.200	1

Maybe you are also interested in:

Current and Voltage Transformers
p.8/68 and p.8/81
Voltmetric and Current Switches
p.8/64

Energy efficiency

Modular analogue instruments



VLM2



AMT2

Ammeters without scale: connection using CT.../5						
Scale	Bbn 8012542	Order details		Price 1 piece	Weight 1 piece	Pack unit
	EAN	Type code	Order code			
A1	000600	AMT1/A1	2CSM320250R1001		0.200	1
A5	000808	AMT1/A5	2CSM320260R1001		0.200	1

Frequency meters: 45-65 Hz, 100/280 V						
Scale	Bbn 8012542	Order details		Price 1 piece	Weight 1 piece	Pack unit
	EAN	Type code	Order code			
	008606	FRZ1	2CSM810310R1001		0.200	1

Modular analogue instruments for direct current

Voltmeters: direct connection						
Scale	Bbn 8012542	Order details		Price 1 piece	Weight 1 piece	Pack unit
	EAN	Type code	Order code			
100 V	008002	VLM2/100	2CSM210130R1001		0.200	1
300 V	008101	VLM2/300	2CSM210190R1001		0.200	1

Ammeters: direct connection						
Scale	Bbn 8012542	Order details		Price 1 piece	Weight 1 piece	Pack unit
	EAN	Type code	Order code			
10 mA	028307	AMT2/0.01	2CSM410330R1001		0.200	1
100 mA	028406	AMT2/0.1	2CSM410340R1001		0.200	1
1000 mA	028505	AMT2/1	2CSM410020R1001		0.200	1
5 A	028604	AMT2/5	2CSM410030R1001		0.200	1
10 A	028703	AMT2/10	2CSM410040R1001		0.200	1
15 A	028802	AMT2/15	2CSM410050R1001		0.200	1
20 A	028901	AMT2/20	2CSM410060R1001		0.200	1
25 A	029007	AMT2/25	2CSM410070R1001		0.200	1
30 A	029106	AMT2/30	2CSM410080R1001		0.200	1

Ammeters without scale: connection using						
Scale	Bbn 8012542	Order details		Price 1 piece	Weight 1 piece	Pack unit
	EAN	Type code	Order code			
	029205	AMT2	2CSM420270R1001		0.200	1

Maybe you are also interested in:

Current and Voltage Transformers
p.8/68 and p.8/81
Voltmetric and Current Switches
p.8/64

Energy efficiency

Scales for modular analogue ammeters



2CSC4000211F0201

SCL

Scales for modular analogue ammeters

Scales SCL 1/A1 for AMT1

Scale	Bbn 8012542	Order details		Price 1 piece	Weight 1 piece kg	Pack unit pc.
	EAN	Type code	Order code			
A1-5A	001201	SCL 1/5	2CSM110021R1041		0.010	10
A1-10A	001300	SCL 1/10	2CSM110032R1041		0.010	10
A1-20A	001409	SCL 1/20	2CSM110075R1041		0.010	10
A1-25A	030706	SCL 1/25	2CSM110096R1041		0.010	10
A1-30A	001508	SCL 1/30	2CSM110107R1041		0.010	10
A1-40A	030805	SCL 1/40	2CSM110128R1041		0.010	10
A1-50A	001607	SCL 1/50	2CSM110149R1041		0.010	10
A1-60A	030904	SCL 1/60	2CSM110159R1041		0.010	10
A1-75A	031000	SCL 1/75	2CSM110169R1041		0.010	10
A1-80A	001706	SCL 1/80	2CSM110179R1041		0.010	10
A1-100A	001805	SCL 1/100	2CSM110189R1041		0.010	10
A1-150A	001904	SCL 1/150	2CSM110209R1041		0.010	10
A1-200A	002000	SCL 1/200	2CSM110229R1041		0.010	10
A1-250A	031109	SCL 1/250	2CSM110249R1041		0.010	10
A1-300A	002109	SCL 1/300	2CSM110259R1041		0.010	10
A1-400A	002208	SCL 1/400	2CSM110279R1041		0.010	10
A1-500A	002307	SCL 1/500	2CSM110299R1041		0.010	10
A1-600A	031208	SCL 1/600	2CSM110309R1041		0.010	10
A1-800A	002406	SCL 1/800	2CSM110329R1041		0.010	10
A1-1000A	002505	SCL 1/1000	2CSM110339R1041		0.010	10
A1-1500A	274704	SCL 1/1500	2CSM110359R1041		0.010	10
A1-2000A	274803	SCL 1/2000	2CSM110379R1041		0.010	10
A1-2500A	274902	SCL 1/2500	2CSM110389R1041		0.010	10

8

Scale SCL 1/A5 for AMT1

Scale	Bbn 8012542	Order details		Price 1 piece	Weight 1 piece kg	Pack unit pc.
	EAN	Type code	Order code			
A5-5A	031307	SCL 1/A5/5	2CSM120021R1041		0.010	10
A5-10A	031406	SCL 1/A5/10	2CSM120032R1041		0.010	10
A5-20A	031505	SCL 1/A5/20	2CSM120075R1041		0.010	10
A5-30A	031604	SCL 1/A5/30	2CSM120107R1041		0.010	10
A5-50A	031703	SCL 1/A5/50	2CSM120149R1041		0.010	10
A5-80A	031802	SCL 1/A5/80	2CSM120179R1041		0.010	10
A5-100A	031901	SCL 1/A5/100	2CSM120189R1041		0.010	10
A5-150A	032007	SCL 1/A5/150	2CSM120209R1041		0.010	10

Energy efficiency

Scales for modular analogue ammeters

Scales SCL 2/A1 for AMT2						
Scale	Bbn 8012542	Order details		Price 1 piece	Weight 1 piece kg	Pack unit pc.
	EAN	Type code	Order code			
A1-5A	032106	SCL 2/5	2CSM230025R1041		0.010	10
A1-6A	032205	SCL 2/6	2CSM230345R1041		0.010	10
A1-10A	032304	SCL 2/10	2CSM230035R1041		0.010	10
A1-20A	032403	SCL 2/20	2CSM230075R1041		0.010	10
A1-30A	032502	SCL 2/30	2CSM230105R1041		0.010	10
A1-50A	032601	SCL 2/50	2CSM230145R1041		0.010	10
A1-80A	032700	SCL 2/80	2CSM230179R1041		0.010	10
A1-100A	032809	SCL 2/100	2CSM230189R1041		0.010	10
A1-150A	032908	SCL 2/150	2CSM230209R1041		0.010	10
A1-200A	033004	SCL 2/200	2CSM230229R1041		0.010	10
A1-250A	033103	SCL 2/250	2CSM230249R1041		0.010	10
A1-300A	033202	SCL 2/300	2CSM230259R1041		0.010	10
A1-400A	033301	SCL 2/400	2CSM230279R1041		0.010	10
A1-500A	033400	SCL 2/500	2CSM230299R1041		0.010	10

8

SCL1/A1/100
Full scale at 90°

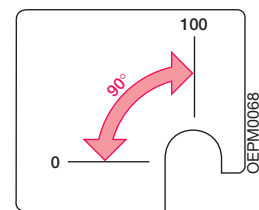

SCL1/A5/100
Full scale at 78°
(with extra scale)

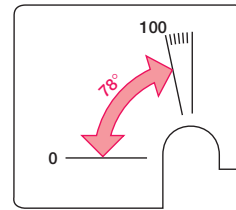

Energy efficiency

Front-panel analogue instruments



Front panel analogue instruments

Technical features		
Rated max. reference voltage for insulation	[V]	650
Test voltage	[V]	2000 eff. (50 Hz/1 min)
Precision class		1.5 (0.5 for frequency meters)
Overload capacity ①		
- ammetric windings		up to $I_n \times 10 / < \text{sec.}$ up to $I_n \times 2 / \text{permanent}$
- voltmetric windings		up to $U_n \times 2 / < 5 \text{ sec.}$ up to $U_n \times 1.2 / \text{permanent}$
Operating temperature	[°C]	-20...+40
Storage temperature	[°C]	-40...+70
Average and max. relative humidity (DIN 40040) ②		65% (yearly average) 85% (+35 °C/60 days a year)
Vibration resistance (IEC 50-1)	[g (9.81 m/s)]	0.08-1.8 (0.35 mm/10-55 Hz; 3 axis/6 h)
Degree of protection		
		IP52 indoors
		IP00 on the terminals (IEC 144. DIN 40050)
		IP40 with suitable terminal covers
Materials		
- cases and front edge		self-extinguishing thermosetting material in accordance with UL94 V-0, fungus and termite resistant
- pointers (DIN 43802) ③		molded aluminium
- terminals		brass
Assembly		vertical/horizontal with special screw-on brackets d
Dimensions W x H x D (DIN 43700/43718)	[mm]	48 x 48 X 53 72 x 72 x 53 96 x 96 X 53
Applicable standards		IEC EN 61010-1

① The overload can be greater for instruments enabled by a CT because the transformer generally keeps secondary current peaks to within 10 In.

② Tropicalization enables the instruments to withstand up to 95% max. relative humidity (+35 °C/60 days). In accordance with DIN standard 40040, they must be protected against any penetration of humidity inside the device. Terminals, screws, washers, bolts and magnets are galvanically protected against rust, while the electrical circuits are painted with the special Multicolor PC52 varnish.

③ The pointer damping time is 1 second. The recorded values are cleared by pressing the control provided.

d With 0.5 mm - 19 mm thick panels, the screws must be attached in the fixing position nearest to the front edge of the measuring device, whereas the 20 mm - 39 mm thick panels require the screws to be fixed in the position furthest away from the front edge.

Energy efficiency

Front-panel analogue instruments



VLM-1 48

Available in both alternating current and direct current versions, the front-panel mono-function measurement devices come in three standard sizes, 48 mm x 48 mm, 72 mm x 72 mm and 96 mm x 96 mm (special versions available on request), employable in single-phase networks. The range is composed of voltmeters and ammeters for a.c. and d.c. applications, and frequency meters for a.c. applications. Ammeters without scale for indirect connection must be completed with the appropriate scale, chosen according to the full-scale value.

Front-panel analogue voltmeters for alternating current

Size	Insertion	Scale	VT type	Bbn 8012542	Order details		Price 1 piece	Weight 1 piece	Pack unit
mm		V a.c.		EAN	Type code	Order code		kg	pc.
48	D	50		541707	VLM-1-50/48	2CSG111100R4001			1
48	D	60		541806	VLM-1-60/48	2CSG111110R4001			1
48	D	80		541905	VLM-1-80/48	2CSG111120R4001			1
48	D	100		542001	VLM-1-100/48	2CSG111130R4001			1
48	D	150		542100	VLM-1-150/48	2CSG111150R4001			1
48	D	200		542209	VLM-1-200/48	2CSG111160R4001			1
48	D	250		542308	VLM-1-250/48	2CSG111180R4001			1
48	D	300		542407	VLM-1-300/48	2CSG111190R4001			1
48	D	400		542506	VLM-1-400/48	2CSG111210R4001			1
48	D	500		542605	VLM-1-500/48	2CSG111220R4001			1
48	D	600		542704	VLM-1-600/48	2CSG111230R4001			1
48	I	200	110/100	743705	VLM1-TV-110-100/200/48	2CSG121140R4001			1
48	I	300	230/100	542803	VLM1-TV-230-100/300/48	2CSG121170R4001			1
48	I	500	380/100	542902	VLM1-TV-380-100/500/48	2CSG121200R4001			1
48	I	500	400/100	743804	VLM1-TV-400-100/500/48	2CSG121210R4001			1
48	I	600	500/100	543008	VLM1-TV-500-100/600/48	2CSG121220R4001			1
48	I	800	600/100	743903	VLM1-TV-600-100/800/48	2CSG121230R4001			1
48	I	1100	1000/100	744009	VLM1-TV-1000-100/1100/48	2CSG121240R4001			1

Size	Insertion	Scale	VT type	Bbn 8012542	Order details		Price 1 piece	Weight 1 piece	Pack unit
mm		V a.c.		EAN	Type code	Order code		kg	pc.
72	D	50		544104	VLM-1-50/72	2CSG112100R4001			1
72	D	60		544203	VLM-1-60/72	2CSG112110R4001			1
72	D	80		544302	VLM-1-80/72	2CSG112120R4001			1
72	D	100		544401	VLM-1-100/72	2CSG112130R4001			1
72	D	150		544500	VLM-1-150/72	2CSG112150R4001			1
72	D	200		544609	VLM-1-200/72	2CSG112160R4001			1
72	D	250		544708	VLM-1-250/72	2CSG112180R4001			1
72	D	300		544807	VLM-1-300/72	2CSG112190R4001			1
72	D	400		544906	VLM-1-400/72	2CSG112210R4001			1
72	D	500		545002	VLM-1-500/72	2CSG112220R4001			1
72	D	600		545101	VLM-1-600/72	2CSG112230R4001			1
72	I	200	110/100	744108	VLM1-TV-110-100/200/72	2CSG122140R4001			1
72	I	300	230/100	545200	VLM1-TV-230-100/300/72	2CSG122170R4001			1
72	I	500	380/100	545309	VLM1-TV-380-100/500/72	2CSG122200R4001			1
72	I	500	400/100	744207	VLM1-TV-400-100/500/72	2CSG122210R4001			1
72	I	600	500/100	545408	VLM1-TV-500-100/600/72	2CSG122220R4001			1
72	I	800	600/100	744306	VLM1-TV-600-100/800/72	2CSG122230R4001			1
72	I	1100	1000/100	744405	VLM1-TV-1000-100/1100/72	2CSG122240R4001			1

Maybe you are also interested in:
 Current and Voltage Transformers
 p.8/68 and p.8/81
 Voltmetric and Current Switches
 p.8/64

D: direct connection
 I: indirect connection with VT, CT and shunt, according to the type



VLM-1 96



VLM-2 48

Size	Insertion	Scale	VT type	Bbn 8012542	Order details		Price 1 piece	Weight 1 piece	Pack unit
mm		V a.c.		EAN	Type code	Order code		kg	pc.
96	D	50		546702	VLM-1-50/96	2CSG113100R4001			1
96	D	60		546801	VLM-1-60/96	2CSG113110R4001			1
96	D	80		546900	VLM-1-80/96	2CSG113120R4001			1
96	D	100		547006	VLM-1-100/96	2CSG113130R4001			1
96	D	150		547105	VLM-1-150/96	2CSG113150R4001			1
96	D	200		547204	VLM-1-200/96	2CSG113160R4001			1
96	D	250		547303	VLM-1-250/96	2CSG113180R4001			1
96	D	300		547402	VLM-1-300/96	2CSG113190R4001			1
96	D	400		547501	VLM-1-400/96	2CSG113210R4001			1
96	D	500		547600	VLM-1-500/96	2CSG113220R4001			1
96	D	600		547709	VLM-1-600/96	2CSG113230R4001			1
96	I	200	110/100	744504	VLM1-TV-110-100/200/96	2CSG123140R4001			1
96	I	300	230/100	547808	VLM1-TV-230-100/300/96	2CSG123170R4001			1
96	I	500	380/100	547907	VLM1-TV-380-100/500/96	2CSG123200R4001			1
96	I	500	400/100	744603	VLM1-TV-400-100/500/96	2CSG123210R4001			1
96	I	600	500/100	548003	VLM1-TV-500-100/600/96	2CSG123220R4001			1
96	I	800	600/100	744702	VLM1-TV-600-100/800/96	2CSG123230R4001			1
96	I	1100	1000/100	744801	VLM1-TV-1000-100/1100/96	2CSG123240R4001			1

Front-panel analogue voltmeters for direct current

Size	Insertion	Scale	Bbn 8012542	Order details		Price 1 piece	Weight 1 piece	Pack unit
mm		V a.c.	EAN	Type code	Order code		kg	pc.
48	D	10	549307	VLM-2-10/48	2CSG211040R4001			1
48	D	15	549406	VLM-2-15/48	2CSG211050R4001			1
48	D	25	549505	VLM-2-25/48	2CSG211070R4001			1
48	D	40	549604	VLM-2-40/48	2CSG211090R4001			1
48	D	60	549703	VLM-2-60/48	2CSG211110R4001			1
48	D	80	549802	VLM-2-80/48	2CSG211120R4001			1
48	D	100	549901	VLM-2-100/48	2CSG211130R4001			1
48	D	150	550006	VLM-2-150/48	2CSG211150R4001			1
48	D	200	550105	VLM-2-200/48	2CSG211160R4001			1
48	D	250	550204	VLM-2-250/48	2CSG211180R4001			1
48	D	400	550303	VLM-2-400/48	2CSG211210R4001			1
48	D	600	550402	VLM-2-600/48	2CSG211230R4001			1

D: direct connection

I: indirect connection with VT, CT and shunt, according to the type

Energy efficiency

Front-panel analogue instruments



VLM-2 96

Size	Insertion	Scale	Bbn 8012542	Order details		Price 1 piece	Weight 1 piece	Pack unit
mm		V a.c.	EAN	Type code	Order code		kg	pc.
72	D	10	551003	VLM-2-10/72	2CSG212040R4001			1
72	D	15	551102	VLM-2-15/72	2CSG212050R4001			1
72	D	25	551201	VLM-2-25/72	2CSG212070R4001			1
72	D	40	551300	VLM-2-40/72	2CSG212090R4001			1
72	D	60	551409	VLM-2-60/72	2CSG212110R4001			1
72	D	80	551508	VLM-2-80/72	2CSG212120R4001			1
72	D	100	551607	VLM-2-100/72	2CSG212130R4001			1
72	D	150	551706	VLM-2-150/72	2CSG212150R4001			1
72	D	200	551805	VLM-2-200/72	2CSG212160R4001			1
72	D	250	551904	VLM-2-250/72	2CSG212180R4001			1
72	D	400	552000	VLM-2-400/72	2CSG212210R4001			1
72	D	600	552109	VLM-2-600/72	2CSG212230R4001			1

Size	Insertion	Scale	Bbn 8012542	Order details		Price 1 piece	Weight 1 piece	Pack unit
mm		V a.c.	EAN	Type code	Order code		kg	pc.
96	D	10	552703	VLM-2-10/96	2CSG213040R4001			1
96	D	15	552802	VLM-2-15/96	2CSG213050R4001			1
96	D	25	552901	VLM-2-25/96	2CSG213070R4001			1
96	D	40	553007	VLM-2-40/96	2CSG213090R4001			1
96	D	60	553106	VLM-2-60/96	2CSG213110R4001			1
96	D	80	553205	VLM-2-80/96	2CSG213120R4001			1
96	D	100	553304	VLM-2-100/96	2CSG213130R4001			1
96	D	150	553403	VLM-2-150/96	2CSG213150R4001			1
96	D	200	553502	VLM-2-200/96	2CSG213160R4001			1
96	D	250	553601	VLM-2-250/96	2CSG213180R4001			1
96	D	400	553700	VLM-2-400/96	2CSG213210R4001			1
96	D	600	553809	VLM-2-600/96	2CSG213230R4001			1

D: direct connection

I: indirect connection with VT, CT and shunt, according to the type

Front-panel analogue ammeters for alternating current

Size	Insertion	Scale	Bbn 8012542	Order details		Price 1 piece	Weight 1 piece	Pack unit
mm		V a.c.	EAN	Type code	Order code		kg	pc.
48	D	1	543107	AMT1-A1-1/48	2CSG311020R4001			1
48	D	5	543206	AMT1-A1-5/48	2CSG311030R4001			1
48	D	10	543305	AMT1-A1-10/48	2CSG311040R4001			1
48	D	15	543404	AMT1-A1-15/48	2CSG311050R4001			1
48	D	20	543503	AMT1-A1-20/48	2CSG311060R4001			1
48	D	25	543602	AMT1-A1-25/48	2CSG311070R4001			1
48	D	30	543701	AMT1-A1-30/48	2CSG311080R4001			1
48	D	40	543800	AMT1-A1-40/48	2CSG311090R4001			1
48	I	SCL-A1	543909	AMT1-A1/48	2CSG321250R4001			1
48	I	SCL-A5	544005	AMT1-A5/48	2CSG321260R4001			1



AMT1-A1 48

Maybe you are also interested in:

Current and Voltage Transformers

p.8/68 and p.8/81

Voltmetric and Current Switches

p.8/64



AMT1-A1 72



AMT1-A1 96



AMT2-A2 48

Size	Insertion	Scale	Bbn 8012542	Order details		Price 1 piece	Weight 1 piece	Pack unit
mm		V a.c.	EAN	Type code	Order code		kg	pc.
72	D	1	545507	AMT1-A1-1/72	2CSG312020R4001			1
72	D	5	545606	AMT1-A1-5/72	2CSG312030R4001			1
72	D	10	545705	AMT1-A1-10/72	2CSG312040R4001			1
72	D	15	545804	AMT1-A1-15/72	2CSG312050R4001			1
72	D	20	545903	AMT1-A1-20/72	2CSG312060R4001			1
72	D	25	546009	AMT1-A1-25/72	2CSG312070R4001			1
72	D	30	546108	AMT1-A1-30/72	2CSG312080R4001			1
72	D	40	546207	AMT1-A1-40/72	2CSG312090R4001			1
72	D	50	546306	AMT1-A1-50/72	2CSG312100R4001			1
72	D	60	546405	AMT1-A1-60/72	2CSG312110R4001			1
72	I	SCL-A1	546504	AMT1-A1/72	2CSG322250R4001			1
72	I	SCL-A5	546603	AMT1-A5/72	2CSG322260R4001			1

Size	Insertion	Scale	Bbn 8012542	Order details		Price 1 piece	Weight 1 piece	Pack unit
mm		V a.c.	EAN	Type code	Order code		kg	pc.
96	D	1	548102	AMT1-A1-1/96	2CSG313020R4001			1
96	D	5	548201	AMT1-A1-5/96	2CSG313030R4001			1
96	D	10	548300	AMT1-A1-10/96	2CSG313040R4001			1
96	D	15	548409	AMT1-A1-15/96	2CSG313050R4001			1
96	D	20	548508	AMT1-A1-20/96	2CSG313060R4001			1
96	D	25	548607	AMT1-A1-25/96	2CSG313070R4001			1
96	D	30	548706	AMT1-A1-30/96	2CSG313080R4001			1
96	D	40	548805	AMT1-A1-40/96	2CSG313090R4001			1
96	D	50	548904	AMT1-A1-50/96	2CSG313100R4001			1
96	D	60	549000	AMT1-A1-60/96	2CSG313110R4001			1
96	I	SCL-A1	549109	AMT1-A1/96	2CSG323250R4001			1
96	I	SCL-A5	549208	AMT1-A5/96	2CSG323260R4001			1

D: direct connection
I: indirect connection with VT, CT and shunt, according to the type

Front-panel analogue ammeters for direct current

Size	Insertion	Scale	Bbn 8012542	Order details		Price 1 piece	Weight 1 piece	Pack unit
mm		V a.c.	EAN	Type code	Order code		kg	pc.
48	D	0,5	550501	AMT2-A2-0,5/48	2CSG411010R4001			1
48	D	1	550600	AMT2-A2-1/48	2CSG411020R4001			1
48	D	5	550709	AMT2-A2-5/48	2CSG411030R4001			1
48	D	10	550808	AMT2-A2-10/48	2CSG411040R4001			1
48	I	SCL-A2	550907	AMT2-A2/48	2CSG421270R4001			1

Energy efficiency

Front-panel analogue instruments



AMT2-A2 72



AMT2-A2 96

Size	Insertion	Scale	Bbn 8012542	Order details		Price 1 piece	Weight 1 piece	Pack unit
mm		V a.c.	EAN	Type code	Order code		kg	pc.
72	D	0,5	552208	AMT2-A2-0,5/72	2CSG412010R4001			1
72	D	1	552307	AMT2-A2-1/72	2CSG412020R4001			1
72	D	5	552406	AMT2-A2-5/72	2CSG412030R4001			1
72	D	10	552505	AMT2-A2-10/72	2CSG412040R4001			1
72	I	SCL-A2	552604	AMT2-A2/72	2CSG422270R4001			1

Size	Insertion	Scale	Bbn 8012542	Order details		Price 1 piece	Weight 1 piece	Pack unit
mm		V a.c.	EAN	Type code	Order code		kg	pc.
96	D	0,5	553908	AMT2-A2-0,5/96	2CSG413010R4001			1
96	D	1	554004	AMT2-A2-1/96	2CSG413020R4001			1
96	D	5	554103	AMT2-A2-5/96	2CSG413030R4001			1
96	D	10	554202	AMT2-A2-10/96	2CSG413040R4001			1
96	I	SCL-A2	554301	AMT2-A2/96	2CSG423270R4001			1

D: direct connection
I: indirect connection with VT, CT and shunt, according to the type

Front-panel analogue frequency meters

Size	Insertion	Scale	Bbn 8012542	Order details		Price 1 piece	Weight 1 piece	Pack unit
mm		V a.c.	EAN	Type code	Order code		kg	pc.
48	D	90°	555605	FRZ-90/48	2CSG811310R4001			1

Size	Insertion	Scale	Bbn 8012542	Order details		Price 1 piece	Weight 1 piece	Pack unit
mm		V a.c.	EAN	Type code	Order code		kg	pc.
72	D	90°	555704	FRZ-90/72	2CSG812310R4001			1
72	D	240°	555902	FRZ-240/72	2CSG812320R4001			1

Size	Insertion	Scale	Bbn 8012542	Order details		Price 1 piece	Weight 1 piece	Pack unit
mm		V a.c.	EAN	Type code	Order code		kg	pc.
96	D	90°	555803	FRZ-90/96	2CSG813310R4001			1
96	D	240°	556008	FRZ-240/96	2CSG813320R4001			1

D: direct connection
I: indirect connection with VT, CT and shunt, according to the type

8



FRZ 48



FRZ 72



FRZ 96

Maybe you are also interested in:

Current and Voltage Transformers
p.8/68 and p.8/81
Voltmetric and Current Switches
p.8/64

Energy efficiency

Scales for front-panel analogue instrument



SCL

Scales for front-panel analogue ammeters

Scales 48 x 48 mm: SCL-A1 for AMT1-A1/48 a.c. ammeters

Scale	Bbn 8012542	Order details		Price 1 piece	Weight 1 piece	Pack unit
	EAN	Type code	Order code		kg	pc.
1	769408	SCL-A1-1/48	2CSG111010R5011		0.010	10
5	769507	SCL-A1-5/48	2CSG111021R5011		0.010	10
10	769606	SCL-A1-10/48	2CSG111032R5011		0.010	10
15	769705	SCL-A1-15/48	2CSG111054R5011		0.010	10
20	769804	SCL-A1-20/48	2CSG111075R5011		0.010	10
25	769903	SCL-A1-25/48	2CSG111096R5011		0.010	10
30	770008	SCL-A1-30/48	2CSG111107R5011		0.010	10
40	770107	SCL-A1-40/48	2CSG111128R5011		0.010	10
50	770206	SCL-A1-50/48	2CSG111149R5011		0.010	10
60	770305	SCL-A1-60/48	2CSG111159R5011		0.010	10
80	770404	SCL-A1-80/48	2CSG111179R5011		0.010	10
100	560500	SCL-A1-100/48	2CSG111189R5011		0.010	10
150	560609	SCL-A1-150/48	2CSG111209R5011		0.010	10
200	560708	SCL-A1-200/48	2CSG111229R5011		0.010	10
250	560807	SCL-A1-250/48	2CSG111249R5011		0.010	10
300	560906	SCL-A1-300/48	2CSG111259R5011		0.010	10
400	561002	SCL-A1-400/48	2CSG111279R5011		0.010	10
500	561101	SCL-A1-500/48	2CSG111299R5011		0.010	10
600	561200	SCL-A1-600/48	2CSG111309R5011		0.010	10
800	561309	SCL-A1-800/48	2CSG111329R5011		0.010	10
1000	561408	SCL-A1-1000/48	2CSG111339R5011		0.010	10
1500	561507	SCL-A1-1500/48	2CSG111359R5011		0.010	10
2000	561606	SCL-A1-2000/48	2CSG111379R5011		0.010	10
2500	561705	SCL-A1-2500/48	2CSG111389R5011		0.010	10
3000	561804	SCL-A1-3000/48	2CSG111399R5011		0.010	10
4000	561903	SCL-A1-4000/48	2CSG111409R5011		0.010	10
5000	562009	SCL-A1-5000/48	2CSG111419R5011		0.010	10
6000	562108	SCL-A1-6000/48	2CSG111429R5011		0.010	10
8000	562207	SCL-A1-8000/48	2CSG111439R5011		0.010	10
10000	562306	SCL-A1-10000/48	2CSG111449R5011		0.010	10

Energy efficiency

Scales for front-panel analogue instrument



SCL

Scales 48 x 48 mm: SCL-A5 for AMT1-A5/48 a.c. ammeters

Scale	Bbn 8012542	Order details		Price 1 piece	Weight 1 piece kg	Pack unit pc.
	EAN	Type code	Order code			
1	770503	SCL-A5-1/48	2CSG121010R5011		0.010	10
5	770602	SCL-A5-5/48	2CSG121021R5011		0.010	10
10	770701	SCL-A5-10/48	2CSG121032R5011		0.010	10
15	770800	SCL-A5-15/48	2CSG121054R5011		0.010	10
20	770909	SCL-A5-20/48	2CSG121075R5011		0.010	10
25	771005	SCL-A5-25/48	2CSG121096R5011		0.010	10
30	771104	SCL-A5-30/48	2CSG121107R5011		0.010	10
40	771203	SCL-A5-40/48	2CSG121128R5011		0.010	10
50	771302	SCL-A5-50/48	2CSG121149R5011		0.010	10
60	771401	SCL-A5-60/48	2CSG121159R5011		0.010	10
80	771500	SCL-A5-80/48	2CSG121179R5011		0.010	10
100	562405	SCL-A5-100/48	2CSG121189R5011		0.010	10
150	562504	SCL-A5-150/48	2CSG121209R5011		0.010	10
200	562603	SCL-A5-200/48	2CSG121229R5011		0.010	10
250	562702	SCL-A5-250/48	2CSG121249R5011		0.010	10
300	562801	SCL-A5-300/48	2CSG121259R5011		0.010	10
400	562900	SCL-A5-400/48	2CSG121279R5011		0.010	10
500	563006	SCL-A5-500/48	2CSG121299R5011		0.010	10
600	563105	SCL-A5-600/48	2CSG121309R5011		0.010	10
800	563204	SCL-A5-800/48	2CSG121329R5011		0.010	10
1000	563303	SCL-A5-1000/48	2CSG121339R5011		0.010	10
1500	563402	SCL-A5-1500/48	2CSG121359R5011		0.010	10
2000	563501	SCL-A5-2000/48	2CSG121379R5011		0.010	10
2500	563600	SCL-A5-2500/48	2CSG121389R5011		0.010	10
3000	563709	SCL-A5-3000/48	2CSG121399R5011		0.010	10
4000	563808	SCL-A5-4000/48	2CSG121409R5011		0.010	10
5000	563907	SCL-A5-5000/48	2CSG121419R5011		0.010	10
6000	564003	SCL-A5-6000/48	2CSG121429R5011		0.010	10
8000	564102	SCL-A5-8000/48	2CSG121439R5011		0.010	10
10000	564201	SCL-A5-10000/48	2CSG121449R5011		0.010	10



SCL

Scales 72 x 72 mm: SCL-A1 for AMT1-A1/72 a.c. ammeters						
Scale	Bbn 8012542	Order details		Price 1 piece	Weight 1 piece kg	Pack unit pc.
	EAN	Type code	Order code			
1	771609	SCL-A1-1/72	2CSG112010R5011		0.010	10
5	771708	SCL-A1-5/72	2CSG112021R5011		0.010	10
10	771807	SCL-A1-10/72	2CSG112032R5011		0.010	10
15	771906	SCL-A1-15/72	2CSG112054R5011		0.010	10
20	772002	SCL-A1-20/72	2CSG112075R5011		0.010	10
25	772101	SCL-A1-25/72	2CSG112096R5011		0.010	10
30	772200	SCL-A1-30/72	2CSG112107R5011		0.010	10
40	772309	SCL-A1-40/72	2CSG112128R5011		0.010	10
50	772408	SCL-A1-50/72	2CSG112149R5011		0.010	10
60	772507	SCL-A1-60/72	2CSG112159R5011		0.010	10
80	772606	SCL-A1-80/72	2CSG112179R5011		0.010	10
100	572305	SCL-A1-100/72	2CSG112189R5011		0.010	10
150	572404	SCL-A1-150/72	2CSG112209R5011		0.010	10
200	572503	SCL-A1-200/72	2CSG112229R5011		0.010	10
250	572602	SCL-A1-250/72	2CSG112249R5011		0.010	10
300	572701	SCL-A1-300/72	2CSG112259R5011		0.010	10
400	572800	SCL-A1-400/72	2CSG112279R5011		0.010	10
500	572909	SCL-A1-500/72	2CSG112299R5011		0.010	10
600	573005	SCL-A1-600/72	2CSG112309R5011		0.010	10
800	573104	SCL-A1-800/72	2CSG112329R5011		0.010	10
1000	573203	SCL-A1-1000/72	2CSG112339R5011		0.010	10
1500	573302	SCL-A1-1500/72	2CSG112359R5011		0.010	10
2000	573401	SCL-A1-2000/72	2CSG112379R5011		0.010	10
2500	573500	SCL-A1-2500/72	2CSG112389R5011		0.010	10
3000	573609	SCL-A1-3000/72	2CSG112399R5011		0.010	10
4000	573708	SCL-A1-4000/72	2CSG112409R5011		0.010	10
5000	573807	SCL-A1-5000/72	2CSG112419R5011		0.010	10
6000	573906	SCL-A1-6000/72	2CSG112429R5011		0.010	10
8000	574002	SCL-A1-8000/72	2CSG112439R5011		0.010	10
10000	574101	SCL-A1-10000/72	2CSG112449R5011		0.010	10

Energy efficiency

Scales for front-panel analogue instrument



SCL

Scales 72 x 72 mm: SCL-A5 for AMT1-A5/72 a.c. ammeters						
Scale	Bbn 8012542	Order details		Price 1 piece	Weight 1 piece	Pack unit
	EAN	Type code	Order code		kg	pc.
1	772705	SCL-A5-1/72	2CSG122010R5011		0.010	10
5	772804	SCL-A5-5/72	2CSG122021R5011		0.010	10
10	772903	SCL-A5-10/72	2CSG122032R5011		0.010	10
15	773009	SCL-A5-15/72	2CSG122054R5011		0.010	10
20	773108	SCL-A5-20/72	2CSG122075R5011		0.010	10
25	773207	SCL-A5-25/72	2CSG122096R5011		0.010	10
30	773306	SCL-A5-30/72	2CSG122107R5011		0.010	10
40	773405	SCL-A5-40/72	2CSG122128R5011		0.010	10
50	773504	SCL-A5-50/72	2CSG122149R5011		0.010	10
60	773603	SCL-A5-60/72	2CSG122159R5011		0.010	10
80	773702	SCL-A5-80/72	2CSG122179R5011		0.010	10
100	574200	SCL-A5-100/72	2CSG122189R5011		0.010	10
150	574309	SCL-A5-150/72	2CSG122209R5011		0.010	10
200	574408	SCL-A5-200/72	2CSG122229R5011		0.010	10
250	574507	SCL-A5-250/72	2CSG122249R5011		0.010	10
300	574606	SCL-A5-300/72	2CSG122259R5011		0.010	10
400	574705	SCL-A5-400/72	2CSG122279R5011		0.010	10
500	574804	SCL-A5-500/72	2CSG122299R5011		0.010	10
600	574903	SCL-A5-600/72	2CSG122309R5011		0.010	10
800	575009	SCL-A5-800/72	2CSG122329R5011		0.010	10
1000	575108	SCL-A5-1000/72	2CSG122339R5011		0.010	10
1500	575207	SCL-A5-1500/72	2CSG122359R5011		0.010	10
2000	575306	SCL-A5-2000/72	2CSG122379R5011		0.010	10
2500	575405	SCL-A5-2500/72	2CSG122389R5011		0.010	10
3000	575504	SCL-A5-3000/72	2CSG122399R5011		0.010	10
4000	575603	SCL-A5-4000/72	2CSG122409R5011		0.010	10
5000	575702	SCL-A5-5000/72	2CSG122419R5011		0.010	10
6000	575801	SCL-A5-6000/72	2CSG122429R5011		0.010	10
8000	575900	SCL-A5-8000/72	2CSG122439R5011		0.010	10
10000	576006	SCL-A5-10000/72	2CSG122449R5011		0.010	10



SCL

Scales 96 x 96 mm: SCL-A1 for AMT1-A1/96 a.c. ammeters						
Scale	Bbn 8012542	Order details		Price 1 piece	Weight 1 piece kg	Pack unit pc.
	EAN	Type code	Order code			
1	773801	SCL-A1-1/96	2CSG113010R5011		0.010	10
5	773900	SCL-A1-5/96	2CSG113021R5011		0.010	10
10	774006	SCL-A1-10/96	2CSG113032R5011		0.010	10
15	774105	SCL-A1-15/96	2CSG113054R5011		0.010	10
20	774204	SCL-A1-20/96	2CSG113075R5011		0.010	10
25	774303	SCL-A1-25/96	2CSG113096R5011		0.010	10
30	774402	SCL-A1-30/96	2CSG113107R5011		0.010	10
40	774501	SCL-A1-40/96	2CSG113128R5011		0.010	10
50	774600	SCL-A1-50/96	2CSG113149R5011		0.010	10
60	774709	SCL-A1-60/96	2CSG113159R5011		0.010	10
80	774808	SCL-A1-80/96	2CSG113179R5011		0.010	10
100	584100	SCL-A1-100/96	2CSG113189R5011		0.010	10
150	584209	SCL-A1-150/96	2CSG113209R5011		0.010	10
200	584308	SCL-A1-200/96	2CSG113229R5011		0.010	10
250	584407	SCL-A1-250/96	2CSG113249R5011		0.010	10
300	584506	SCL-A1-300/96	2CSG113259R5011		0.010	10
400	584605	SCL-A1-400/96	2CSG113279R5011		0.010	10
500	584704	SCL-A1-500/96	2CSG113299R5011		0.010	10
600	584803	SCL-A1-600/96	2CSG113309R5011		0.010	10
800	584902	SCL-A1-800/96	2CSG113329R5011		0.010	10
1000	585008	SCL-A1-1000/96	2CSG113339R5011		0.010	10
1500	585107	SCL-A1-1500/96	2CSG113359R5011		0.010	10
2000	585206	SCL-A1-2000/96	2CSG113379R5011		0.010	10
2500	585305	SCL-A1-2500/96	2CSG113389R5011		0.010	10
3000	585404	SCL-A1-3000/96	2CSG113399R5011		0.010	10
4000	585503	SCL-A1-4000/96	2CSG113409R5011		0.010	10
5000	585602	SCL-A1-5000/96	2CSG113419R5011		0.010	10
6000	585701	SCL-A1-6000/96	2CSG113429R5011		0.010	10
8000	585800	SCL-A1-8000/96	2CSG113439R5011		0.010	10
10000	585909	SCL-A1-10000/96	2CSG113449R5011		0.010	10

Energy efficiency

Scales for front-panel analogue instrument



SCL

Scales 96 x 96 mm: SCL-A5 for AMT1-A5/96 a.c. ammeters						
Scale	Bbn 8012542	Order details		Price 1 piece	Weight 1 piece kg	Pack unit pc.
	EAN	Type code	Order code			
1	774907	SCL-A5-1/96	2CSG123010R5011		0.010	10
5	775003	SCL-A5-5/96	2CSG123021R5011		0.010	10
10	775102	SCL-A5-10/96	2CSG123032R5011		0.010	10
15	775201	SCL-A5-15/96	2CSG123054R5011		0.010	10
20	775300	SCL-A5-20/96	2CSG123075R5011		0.010	10
25	775409	SCL-A5-25/96	2CSG123096R5011		0.010	10
30	775508	SCL-A5-30/96	2CSG123107R5011		0.010	10
40	775607	SCL-A5-40/96	2CSG123128R5011		0.010	10
50	775706	SCL-A5-50/96	2CSG123149R5011		0.010	10
60	775805	SCL-A5-60/96	2CSG123159R5011		0.010	10
80	775904	SCL-A5-80/96	2CSG123179R5011		0.010	10
100	586005	SCL-A5-100/96	2CSG123189R5011		0.010	10
150	586104	SCL-A5-150/96	2CSG123209R5011		0.010	10
200	586203	SCL-A5-200/96	2CSG123229R5011		0.010	10
250	586302	SCL-A5-250/96	2CSG123249R5011		0.010	10
300	586401	SCL-A5-300/96	2CSG123259R5011		0.010	10
400	586500	SCL-A5-400/96	2CSG123279R5011		0.010	10
500	586609	SCL-A5-500/96	2CSG123299R5011		0.010	10
600	586708	SCL-A5-600/96	2CSG123309R5011		0.010	10
800	586807	SCL-A5-800/96	2CSG123329R5011		0.010	10
1000	586906	SCL-A5-1000/96	2CSG123339R5011		0.010	10
1500	587002	SCL-A5-1500/96	2CSG123359R5011		0.010	10
2000	587101	SCL-A5-2000/96	2CSG123379R5011		0.010	10
2500	587200	SCL-A5-2500/96	2CSG123389R5011		0.010	10
3000	587309	SCL-A5-3000/96	2CSG123399R5011		0.010	10
4000	587408	SCL-A5-4000/96	2CSG123409R5011		0.010	10
5000	587507	SCL-A5-5000/96	2CSG123419R5011		0.010	10
6000	587606	SCL-A5-6000/96	2CSG123429R5011		0.010	10
8000	587705	SCL-A5-8000/96	2CSG123439R5011		0.010	10
10000	587804	SCL-A5-10000/96	2CSG123449R5011		0.010	10



SCL

Scales 48 x 48 mm: SCL-A2 for AMT2-A2/48 d.c. ammeters

Scale	Bbn 8012542	Order details		Price 1 piece	Weight 1 piece kg	Pack unit pc.
	EAN	Type code	Order code			
20	595908	SCL-A2-20/48	2CSG231075R5011		0.010	10
100	596004	SCL-A2-100/48	2CSG231189R5011		0.010	10
150	596103	SCL-A2-150/48	2CSG231209R5011		0.010	10
200	596202	SCL-A2-200/48	2CSG231229R5011		0.010	10
250	596301	SCL-A2-250/48	2CSG231249R5011		0.010	10
300	596400	SCL-A2-300/48	2CSG231259R5011		0.010	10
400	596509	SCL-A2-400/48	2CSG231279R5011		0.010	10
500	596608	SCL-A2-500/48	2CSG231299R5011		0.010	10
600	596707	SCL-A2-600/48	2CSG231309R5011		0.010	10
800	596806	SCL-A2-800/48	2CSG231329R5011		0.010	10
1000	596905	SCL-A2-1000/48	2CSG231339R5011		0.010	10

Scales 72 x 72 mm: SCL-A2 for AMT2-A2/72 d.c. ammeters

Scale	Bbn 8012542	Order details		Price 1 piece	Weight 1 piece kg	Pack unit pc.
	EAN	Type code	Order code			
20	597001	SCL-A2-20/72	2CSG232075R5011		0.010	10
100	597100	SCL-A2-100/72	2CSG232189R5011		0.010	10
150	597209	SCL-A2-150/72	2CSG232209R5011		0.010	10
200	597308	SCL-A2-200/72	2CSG232229R5011		0.010	10
250	597407	SCL-A2-250/72	2CSG232249R5011		0.010	10
300	597506	SCL-A2-300/72	2CSG232259R5011		0.010	10
400	597605	SCL-A2-400/72	2CSG232279R5011		0.010	10
500	597704	SCL-A2-500/72	2CSG232299R5011		0.010	10
600	597803	SCL-A2-600/72	2CSG232309R5011		0.010	10
800	597902	SCL-A2-800/72	2CSG232329R5011		0.010	10
1000	598008	SCL-A2-1000/72	2CSG232339R5011		0.010	10

Scales 96 x 96 mm: SCL-A2 for AMT2-A2/96 d.c. ammeters

Scale	Bbn 8012542	Order details		Price 1 piece	Weight 1 piece kg	Pack unit pc.
	EAN	Type code	Order code			
20	598107	SCL-A2-20/96	2CSG233075R5011		0.010	10
100	598206	SCL-A2-100/96	2CSG233189R5011		0.010	10
150	598305	SCL-A2-150/96	2CSG233209R5011		0.010	10
200	598404	SCL-A2-200/96	2CSG233229R5011		0.010	10
250	598503	SCL-A2-250/96	2CSG233249R5011		0.010	10
300	598602	SCL-A2-300/96	2CSG233259R5011		0.010	10
400	598701	SCL-A2-400/96	2CSG233279R5011		0.010	10
500	598800	SCL-A2-500/96	2CSG233299R5011		0.010	10
600	598909	SCL-A2-600/96	2CSG233309R5011		0.010	10
800	599005	SCL-A2-800/96	2CSG233329R5011		0.010	10
1000	599104	SCL-A2-1000/96	2CSG233339R5011		0.010	10

Energy efficiency

Voltmetric and current switches



MCV

Technical features

Insulation voltage	[V]	600
Rated thermal current	[A]	12
Mechanic operations	[No.]	1000000
Power consumption	[VA]	0.23
Modules	[No.]	3

MCV - MCA voltmetric and current switches

Cam rotary switches are suitable for mounting on EN 50022 rail. In three-phase systems they enable the use of a single measurement instrument (single-phase) for viewing the current or voltage value set through the switch itself.



MCA

Voltmeter switches

Range	Power loss W	Bbn 7392696 EAN	Order details		Price 1 piece	Weight 1 piece kg	Pack unit pc.
			Type code	Order code			
L1, L2, L3	0.5	52246 9	MCV 4	1SCA 022 404 R4740		0.095	1
L1, L2, L3, N	0.5	52243 8	MCV 7	1SCA 022 647 R7840		0.110	1

Current switches

Range	Power loss W	Bbn 7392696 EAN	Order details		Price 1 piece	Weight 1 piece kg	Pack unit pc.
			Type code	Order code			
0-1-2-3	0.5	52245 2	MCA 4	1SCA 022 404 R4821		0.110	1

Front panel QCV - QCA voltage and current switches

For use in three-phase systems, to allow a single device to measure the voltage and current settings adjusted by the switches.

Measure	Position	Bbn 7392696 EAN	Order details		Price 1 piece	Weight 1 piece kg	Pack unit pc.
			Type code	Order code			
Voltage	4	527990	QCV-4/48	1SCA022780R0770		0.150	1
Current	4	528003	QCA-4/48	1SCA022780R0690		0.150	1
Voltage	7	527983	QCV-7/48	1SCA022780R0850		0.150	1

8



QCA 48



QCV 48

Energy efficiency

E 233 hour counters



E 233

Technical features		
	AC equipment	DC equipment
Rated voltage	50 Hz: 24 V, 230 V 60 Hz: 24 V, 120 V, 240 V ^①	DC 12 V ... 48 V
Voltage tolerance	±15 %	±10 %
Power consumption	1.5 VA	ca. 20 mW (at 12 V DC)
Ambient temperature	-15 °C/5 °F... +50 °C/122 °F	-10 °C/14 °F ... +50 °C/122 °F
Counting capacity	99.999 h	99.999 h
Precision class	0.01 h	0.1 h
Operation display	fast running	LED blinking
Protection against electric shock	according to DIN VDE 0106 Part 100 (BGV A2)	according to DIN VDE 0106 Part 100 (BGV A2)
Terminal size	up to 10 mm ²	up to 10 mm ²

^① UL approval

E 233 electro-mechanical hour counters

Hour counters are used to record operating times as well as to determine idle times and off times of industrial machinery and plant, for commercial purposes or in domestic installations. No reset functionality.

Rated voltage	Bbn 4012233	Order details		Price 1 piece	Weight 1 piece kg	Pack unit pc.
	EAN	Type code	Order code			
AC 230 V/50 Hz	63000 4	E 233-230	2CDE100000R1601		0.05	10
AC 24 V/50 Hz	63010 3	E 233-24	2CDE400000R1601		0.05	10
DC 12 V ... 48 V	63020 2	E 233-12/48	2CDE300010R1601		0.05	10
AC 240 V/60 Hz	36590 1 ^①	E 233-240/60 Hz	2CDE100021R1601		0.05	10
AC 120 V/60 Hz	36600 7 ^①	E 233-120/60 Hz	2CDE600021R1601		0.05	10
AC 24 V/60 Hz	36610 6 ^①	E 233- 24/60 Hz	2CDE400021R1601		0.05	10

Other rated voltages upon request.

^① Bbn No. 4016779

Energy efficiency HMT hour counters



HMT

Technical features		
Rated voltage Un	[V]	a.c. 24 a.c. 110 a.c. 230 d.c. 12...48
Displayed digits (in hours)	[n°]	99,999.9 (for HMT1 and HMT11)
Accuracy class	[%]	0.5
Frequency	[Hz]	50
Power consumption	[W]	1.1...2.2
Modules	[No.]	2

HMT electro-mechanical hour counters

Equipped with 7-digit indicator (99.999,99) and available in two modules. They cannot be reset.

Rated voltage	Bbn 8012542	Order details		Price 1 piece	Weight 1 piece	Pack unit
V AC	EAN	Type code	Order code		kg	pc.
24	030300	HMT 1/24	2CSM111000R1601		0.200	6
110	030409	HMT 1/110	2CSM121000R1601		0.200	6
220	030508	HMT 1/220	2CSM131000R1601		0.200	6
230	030607	HMT 11	2CSM133000R1601		0.200	1

Energy efficiency

TMD temperature control units



TMD

Technical features			
Auxiliary supply	Alternating current	[V]	20÷250 ±15%
	Direct current	[Hz]	115-230-400 50-60
Power consumption		[VA]	4 max
Input	Sensor		PT100 RTD (not included)
	Type		3 wires (2 and 4 wires types are also supported)
	Error		1 degree every 0,39 W
	Measure range	[°C]	0...220 ± 2
	Compensation	[W]	20 max
	Trip delay/hysteresis	[s/°C]	5/2
Output	Number		4
	Type		NO-CO-NC
	Vmax	[V]	12 d.c.
	Imax	[A]	8 (resistive load)
	Functions		Alarm, trip, cooling, auto-test
	Programmable functions		Alarm, tip, hold, fan, temp. max
Display			7 segments LED
Connections	Terminals		removable screw
	Max section	[mm ²]	2.5
Insulation voltage		[V]	2500/50 Hz - 1 min
Protection degree	Front		IP52
	Rear		IP20
Operation temperature		[°C]	-10...+55, relative humidity max 90%
Storage temperature		[°C]	-25...+80
Reference			IEC EN 50081-2, IEC EN 50082-2, IEC EN 60255

8

Temperature control units

TMD are used measure and control the temperature levels and efficiency of electric machines, power transformers, motors, etc.

The temperature is measured by four PT100 type sensors. Each measuring channel has two programmable alarm thresholds which trip two output relays to remotely signal that a critical temperature has been reached.



The measured values and any alarm conditions are shown on the dual 3-digit display on the front of the device, which also has five programming keys for configuring its operation.

The control unit is also able to store in memory maximum values and a log of all trip-events.

Temperature measured	Bbn	Order details		Price	Weight	Pack
	8012542	Type code	Order code	1 piece	1 piece	unit
	EAN				kg	pc.
4	560203	TMD-4/96	2CSG524000R2021		0.8	1

Energy efficiency

Current transformers selection table





Breaker choice							
Modular	S200, S280, S290, S700, S800						
Tmax	XT1, XT2, XT3, XT4, T4320						T5
Emax							
Installation choice							
Fixing system	DIN rail	DIN rail	DIN rail, cable or bus bar		Bus bar	DIN rail, cable or bus bar, base mounted with feet	
							
Rated current (A)	CTA	TRF M	CT PRO XT Standard SELV version		CT30	CT MAX Standard SELV version	
5	2CSG111020R1141 CTA/5						
10	2CSG111030R1141 CTA/10						
15	2CSG111040R1141 CTA/15						
20	2CSG111050R1141 CTA/20						
25	2CSG111060R1141 CTA/25						
40	2CSG111080R1141 CTA/40 (cl. 0.5)	2CSM100050R1111 TRFM/40	2CSG225745R1101 CT PRO XT 40	2CSG225845R1101 CT PRO XT 40 SELV			
50	2CSG111090R1141 CTA/50 (cl. 0.5)		2CSG225755R1101 CT PRO XT 50	2CSG225855R1101 CT PRO XT 50 SELV			
60	2CSG111100R1141 CTA/60 (cl. 0.5)	2CSM100070R1111 TRFM/60 (cl. 1)	2CSG225765R1101 CT PRO XT 60	2CSG225865R1101 CT PRO XT 60 SELV			
80	2CSG111110R1141 CTA/80 (cl. 0.5)		2CSG225775R1101 CT PRO XT 80	2CSG225875R1101 CT PRO XT 80 SELV			
100	2CSG111120R1141 CTA/100 (cl. 0.5)	2CSM100090R1111 TRFM/100	2CSG225785R1101 CT PRO XT 100	2CSG225885R1101 CT PRO XT 100 SELV	2CSG101100R1101 CT30/100 (cl. 3)		
150		2CSM100100R1111 TRFM/150	2CSG225795R1101 CT PRO XT 150	2CSG225895R1101 CT PRO XT 150 SELV	2CSG101110R1101 CT30/150 (cl. 3)		
200			2CSG225805R1101 CT PRO XT 200	2CSG225905R1101 CT PRO XT 200 SELV			
250		2CSM100120R1111 TRFM/250	2CSG225815R1101 CT PRO XT 250	2CSG225915R1101 CT PRO XT 250 SELV	2CSG101130R1101 CT30/250		
300			2CSG225825R1101 CT PRO XT 300	2CSG225925R1101 CT PRO XT 300 SELV		2CSG225945R1101 CT MAX 300	2CSG226005R1101 CT MAX 300 SELV
400		2CSM100140R1111 TRFM/400	2CSG225835R1101 CT PRO XT 400	2CSG225935R1101 CT PRO XT 400 SELV	2CSG101150R1101 CT30/400	2CSG225955R1101 CT MAX 400	2CSG226015R1101 CT MAX 400 SELV
500						2CSG225965R1101 CT MAX 500	2CSG226025R1101 CT MAX 500 SELV
600		2CSM100160R1111 TRFM/600				2CSG225975R1101 CT MAX 600	2CSG226035R1101 CT MAX 600 SELV
800						2CSG225985R1101 CT MAX 800	2CSG226045R1101 CT MAX 800 SELV

8

	T6,T7		T6,T7					
	E1.2, E2.2, E4.2			E2, E3, E4, E6	E2.2, E4.2, E6.2	E2.2, E4.2	E1.2	
				Bus bar	DIN rail, cable or bus bar, base mounted with feet		Bus bar	
								
	CT6	CT8	CT8V	CT80	CT12	CT12V	CT120	Class
								0,5
								0,5
								0,5
								0,5
								0,5
								3
								3
								3
								3
								3
								1
								0,5
								0,5
	2CSG421130R1101 CT6/250			2CSG201130R1101 CT80/250				0,5
	2CSG421140R1101 CT6/300	2CSG521140R1101 CT8/300						0,5
	2CSG421150R1101 CT6/400	2CSG521150R1101 CT8/400	2CSG631150R1101 CT8-V/400	2CSG201150R1101 CT80/400			2CSG401150R1101 CT120/400	0,5
	2CSG421160R1101 CT6/500	2CSG521160R1101 CT8/500	2CSG631160R1101 CT8-V/500	2CSG201160R1101 CT80/500	2CSG721160R1101 CT12/500		2CSG401160R1101 CT120/500	0,5
	2CSG421170R1101 CT6/600	2CSG521170R1101 CT8/600	2CSG631170R1101 CT8-V/600	2CSG201170R1101 CT80/600	2CSG721170R1101 CT12/600		2CSG401170R1101 CT120/600	0,5
	2CSG421180R1101 CT6/800	2CSG521180R1101 CT8/800	2CSG631180R1101 CT8-V/800	2CSG201180R1101 CT80/800	2CSG721180R1101 CT12/800	2CSG831180R1101 CT12-V/800	2CSG401180R1101 CT120/800	0,5







Energy efficiency

Current transformers selection table

Breaker choice							
Modular	S200, S280, S290, S700, S800						
Tmax	XT1, XT2, XT3, XT4, T4320						T5
Emax							
Installation choice							
Fixing system	DIN rail	DIN rail	DIN rail, cable or bus bar		Bus bar	DIN rail, cable or bus bar, base mounted with feet	
							
Rated current (A)	CTA	TRF M	CT PRO XT		CT30	CT MAX	
			Standard	SELV version		Standard	SELV version
1000						2CSG225995R1101 CT MAX 1000	2CSG226055R1101 CT MAX 1000 SELV
1200							
1250							
1500							
2000							
2500							
3000							
4000							
5000							
6000							
Primary choice							
	CTA	TRF M	CT PRO XT		CT30	CT MAX	
	Wound primary	Through primary			Split core trough primary	Through primary	
Through	8	29	18	18	–	30	30
primary max	–	–	20x10	20x10	–	30x15; 40x10	30x15; 40x10
section [mm]	–	–	–	–	3x80x10	–	–

8

T6,T7	T6,T7					
E1.2, E2.2, E4.2	E2, E3, E4, E6	E2.2, E4.2, E6.2	E2.2, E4.2	E1.2		

				Bus bar	DIN rail, cable or bus bar, base mounted with feet	Bus bar		
								
CT6	CT8	CT8V	CT80	CT12	CT12V	CT120		Class
2CSG421190R1101 CT6/1000	2CSG521190R1101 CT8/1000	2CSG631190R1101 CT8-V/1000	2CSG201190R1101 CT80/1000	2CSG721190R1101 CT12/1000	2CSG831190R1101 CT12-V/1000	2CSG401190R1101 CT120/1000		0,5
2CSG421200R1101 CT6/1200	2CSG521200R1101 CT8/1200	2CSG631200R1101 CT8-V/1200		2CSG721200R1101 CT12/1200	2CSG831200R1101 CT12-V/1200	2CSG401200R1101 CT120/1200		0,5
					2CSG831210R1101 CT12-V/1250			0,5
2CSG421220R1101 CT6/1500	2CSG521220R1101 CT8/1500	2CSG631220R1101 CT8-V/1500		2CSG721220R1101 CT12/1500	2CSG831220R1101 CT12-V/1500	2CSG401220R1101 CT120/1500		0,5
2CSG421230R1101 CT6/2000	2CSG521230R1101 CT8/2000	2CSG631230R1101 CT8-V/2000	2CSG301230R1101 CT80/2000	2CSG721230R1101 CT12/2000	2CSG831230R1101 CT12-V/2000			0,5
2CSG421240R1101 CT6/2500	2CSG521240R1101 CT8/2500	2CSG631240R1101 CT8-V/2500	2CSG301240R1101 CT80/2500	2CSG721240R1101 CT12/2500	2CSG831240R1101 CT12-V/2500			0,5
	2CSG521250R1101 CT8/3000			2CSG721250R1101 CT12/3000	2CSG831250R1101 CT12-V/3000			0,5
				2CSG721260R1101 CT12/4000	2CSG831260R1101 CT12-V/4000			0,5
				2CSG721270R1101 CT12/5000				0,5
				2CSG721280R1101 CT12/6000				0,5

8

CT6	CT8	CT8V	CT80	CT12	CT12V	CT120
Through primary			Split core trough primary	Through primary		Split core trough primary
50	2x30	2x35	-	2x50	3x35	-
60x20	80x30	-	-	80x50; 100x50; 125x50	-	-
-	-	80x30; 3x80x5	2x30x10	-	125x30, 3x100x10, 4x100x5, 4x125x5	4x120x10

Energy efficiency

CT measurement current transformers with through primary



CT

Technical features		CT...	CTO	TRFM
Standard secondary current	[A]	5 A		
Max. voltage for operation	[kV]	1,2		
Test voltage	[kV]	3 a 50 Hz/1min		
Residual current voltage at secondary terminals when security circuit intervenes (only SELV versions)		< 25 V rms		
Short circuit rated thermal current	[IpN]	40 per 1 sec.	60 per 1 sec.	40 per 1 sec.
Short circuit rated dynamic current	[Ith]	2,5 per 1 sec.		
Permanent overload	[IpN]	1,2		
Safety factor	[Fs]	< 5		
Frequency	[Hz]	50-60		
Air insulation E class		Calss E	B	E
Terminals		primary P1 - P2 (K - L); secondary s1 - s2 (k - l) P1 (K) primary winding input s1 (k) secondary winding input P2 (L) primary winding output s2 (l) secondary winding output		
Housing		Latamid 66 H2 G25 V0	Materiale termoplastico autoestinguente V0	
Protection degree		IP30	IP20	IP20
Operating temperature	[°C]	-5...+50	-5...+50	-25...+50
Max. temperature on bars	[°C]	70°C		
Storage temperature	[°C]	-20...+80	-20...+80	-40...+80
Relative humidity		80%		
Reference standard		IEC EN 60044-1, IEC EN 61010-1		
Secondary protection circuit reference standards (only SELV versions)		IEC60364; IEC473.1.4; IEC556.3; CEI64-8-4; CEI411.1.4.3; CEI411.5.2; CEI411.2; CEI473.1.4; CEI473.2.3		

CT and CTA current transformers

Used to transform primary currents (max. 6000 A) into .../5 A low secondary currents indirectly supplying power to analogue and digital measurement devices. They are available both with wound and through primary. In the first case they are provided along with the bar or the primary terminal; in the second case they have a hole to insert in the bar or the cable which forms the primary.

The rated current to the secondary windings is 5 A, in line with the offer of measuring devices. CT .../1 are not employable with ABB mono-function and multifunction measuring devices. The use of CT .../1 is needed in case of long wirings from CT secondary windings to the measuring device; nowadays, the wide use of communication protocols doesn't require the instrument to be installed far from the line to measure.

The new SELV versions of the CT PRO XT and CT MAX guarantee maximum safety against overvoltage and switchboard internal overheating thanks to the innovative electronic protection circuit which automatically short-circuit the CT secondary winding in case of accidental disconnection of its secondary terminals.

Maybe you are also interested in:

Network Analysers and DMTME
Multimeter p.8/4
Energy Meters p.8/16
Analogue and Digital Instrument
p.8/42



CT PRO XT

Standard type current transformers .../5 A with through primary

CT PRO XT .../5 A series, through primary								
Primary rated current I _{prim} A	Accuracy class	Rated power VA	Bbn 8012542 EAN	Order details		Price 1 piece	Weight 1 piece kg	Pack unit pc.
				Type code	Order code			
40	3	2	257455	CT PRO XT 40	2CSG225745R1101		0.32	1
50	3	2	257554	CT PRO XT 50	2CSG225755R1101		0.32	1
60	3	2	257653	CT PRO XT 60	2CSG225765R1101		0.32	1
80	3	2	257752	CT PRO XT 80	2CSG225775R1101		0.32	1
100	1	3	257851	CT PRO XT 100	2CSG225785R1101		0.32	1
150	1	5	257950	CT PRO XT 150	2CSG225795R1101		0.32	1
200	1	5	258056	CT PRO XT 200	2CSG225805R1101		0.32	1
250	0.5	5	258155	CT PRO XT 250	2CSG225815R1101		0.32	1
300	0.5	5	258155	CT PRO XT 300	2CSG225825R1101		0.32	1
400	0.5	5	258353	CT PRO XT 400	2CSG225835R1101		0.32	1

CT PRO XT SELV .../5 series, through primary								
Primary rated current I _{prim} A	Accuracy class	Rated power VA	Bbn 8012542 EAN	Order details		Price 1 piece	Weight 1 piece kg	Pack unit pc.
				Type code	Order code			
40	3	2	258452	CT PRO XT 40 SELV	2CSG225845R1101		0.37	1
50	3	2	258551	CT PRO XT 50 SELV	2CSG225855R1101		0.37	1
60	3	2	258650	CT PRO XT 60 SELV	2CSG225865R1101		0.37	1
80	3	2	258650	CT PRO XT 80 SELV	2CSG225875R1101		0.37	1
100	1	3	258858	CT PRO XT 100 SELV	2CSG225885R1101		0.37	1
150	1	5	258957	CT PRO XT 150 SELV	2CSG225895R1101		0.37	1
200	1	5	259053	CT PRO XT 200 SELV	2CSG225905R1101		0.37	1
250	0.5	5	259152	CT PRO XT 250 SELV	2CSG225915R1101		0.37	1
300	0.5	5	259251	CT PRO XT 300 SELV	2CSG225925R1101		0.37	1
400	0.5	5	259350	CT PRO XT 400 SELV	2CSG225935R1101		0.37	1

8

CT PRO XT series

Through primary		max section [mm]
cable	○	18
horizontal bar	▬	20x10
vertical bar	▮	-

Energy efficiency

CT measurement current transformers with through primary



CT MAX

CT MAX .../5 A series, through primary								
Primary rated current I_{prim} A	Accuracy class	Rated power VA	Bbn 8012542 EAN	Order details		Price 1 piece	Weight 1 piece kg	Pack unit pc.
				Type code	Order code			
300	0,5	4	259459	CT MAX 300	2CSG225945R1101		0,32	1
400	0,5	5	259558	CT MAX 400	2CSG225955R1101		0,32	1
500	0,5	6	259558	CT MAX 500	2CSG225965R1101		0,32	1
600	0,5	10	259657	CT MAX 600	2CSG225975R1101		0,32	1
800	0,5	10	259657	CT MAX 800	2CSG225985R1101		0,32	1
1000	0,5	10	259954	CT MAX 1000	2CSG225995R1101		0,32	1

CT MAX SELV .../5 A series, through primary								
Primary rated current I_{prim} A	Accuracy class	Rated power VA	Bbn 8012542 EAN	Order details		Price 1 piece	Weight 1 piece kg	Pack unit pc.
				Type code	Order code			
300	0,5	4	260059	CT MAX 300 SELV	2CSG226005R1101		0,37	1
400	0,5	5	260158	CT MAX 400 SELV	2CSG226015R1101		0,37	1
500	0,5	6	260257	CT MAX 500 SELV	2CSG226025R1101		0,37	1
600	0,5	10	260356	CT MAX 600 SELV	2CSG226035R1101		0,37	1
800	0,5	10	260455	CT MAX 800 SELV	2CSG226045R1101		0,37	1
1000	0,5	10	260554	CT MAX 1000 SELV	2CSG226055R1101		0,37	1

CT MAX series		
Through primary		max section [mm]
cable	○	30
horizontal bar	▬	30x15, 40x10
vertical bar	▮	-

Maybe you are also interested in:
 Network Analysers and DMTME
 Multimeter p.8/4
 Energy Meters p.8/16
 Analogue and Digital Instrument
 p.8/42



CT6

2CSG40124R0201



CT8

2CSG40115R0201



CT8/V

2CSG40115R0201

CT6 .../5 A series, through primary

Primary rated current I _{prim} A	Accuracy class	Rated power VA	Bbn 8012542 EAN	Order details		Price 1 piece	Weight 1 piece kg	Pack unit pc.
				Type code	Order code			
250	0.5	5	605508	CT6/250	2CSG421130R1101		1.000	1
300	0.5	5	605607	CT6/300	2CSG421140R1101		1.000	1
400	0.5	6	605706	CT6/400	2CSG421150R1101		1.000	1
500	0.5	6	605805	CT6/500	2CSG421160R1101		1.000	1
600	0.5	10	605904	CT6/600	2CSG421170R1101		1.000	1
800	0.5	10	606000	CT6/800	2CSG421180R1101		1.000	1
1000	0.5	20	606109	CT6/1000	2CSG421190R1101		1.000	1
1200	0.5	20	606208	CT6/1200	2CSG421200R1101		1.000	1
1500	0.5	30	606307	CT6/1500	2CSG421220R1101		1.000	1
2000	0.5	30	606406	CT6/2000	2CSG421230R1101		1.000	1
2500	0.5	30	606505	CT6/2500	2CSG421240R1101		1.000	1

CT8 .../5 A series, through primary

Primary rated current I _{prim} A	Accuracy class	Rated power VA	Bbn 8012542 EAN	Order details		Price 1 piece	Weight 1 piece kg	Pack unit pc.
				Type code	Order code			
300	0.5	5	606604	CT8/300	2CSG521140R1101		1.000	1
400	0.5	6	606703	CT8/400	2CSG521150R1101		1.000	1
500	0.5	10	606802	CT8/500	2CSG521160R1101		1.000	1
600	0.5	10	606901	CT8/600	2CSG521170R1101		1.000	1
800	0.5	10	607007	CT8/800	2CSG521180R1101		1.000	1
1000	0.5	10	607106	CT8/1000	2CSG521190R1101		1.000	1
1200	0.5	15	607205	CT8/1200	2CSG521200R1101		1.000	1
1500	0.5	20	607304	CT8/1500	2CSG521220R1101		1.000	1
2000	0.5	20	607403	CT8/2000	2CSG521230R1101		1.000	1
2500	0.5	20	607502	CT8/2500	2CSG521240R1101		1.000	1
3000	0.5	20	607601	CT8/3000	2CSG521250R1101		1.000	1

CT8-V .../5 A series, through primary

Primary rated current I _{prim} A	Accuracy class	Rated power VA	Bbn 8012542 EAN	Order details		Price 1 piece	Weight 1 piece kg	Pack unit pc.
				Type code	Order code			
400	0.5	6	608707	CT8-V/400	2CSG631150R1101		0.800	1
500	0.5	10	608806	CT8-V/500	2CSG631160R1101		0.800	1
600	0.5	10	608905	CT8-V/600	2CSG631170R1101		0.800	1
800	0.5	10	609001	CT8-V/800	2CSG631180R1101		0.800	1
1000	0.5	10	609100	CT8-V/1000	2CSG631190R1101		0.800	1
1200	0.5	10	609209	CT8-V/1200	2CSG631200R1101		0.800	1
1500	0.5	10	609308	CT8-V/1500	2CSG631220R1101		0.800	1
2000	0.5	20	609407	CT8-V/2000	2CSG631230R1101		0.800	1
2500	0.5	20	609506	CT8-V/2500	2CSG631240R1101		0.800	1

CT6 series		max section [mm]
Through primary		
cable	○	50
horizontal bar	▬	60x20
vertical bar	▮	-

CT8 series		max section [mm]
Through primary		
cable	○	2x30
horizontal bar	▬	80x30
vertical bar	▮	-

CT8-V series		max section [mm]
Through primary		
cable	○	2x35
horizontal bar	▬	-
vertical bar	▮	80x30 3x80x5

Energy efficiency

CT measurement current transformers with through primary





CT12





CT12/V

CT12 .../5 A series, through primary								
Primary rated current I_{prim} A	Accuracy class	Rated power VA	Bbn 8012542 EAN	Order details		Price 1 piece	Weight 1 piece kg	Pack unit pc.
				Type code	Order code			
500	0.5	10	607700	CT12/500	2CSG721160R1101		1.600	1
600	0.5	10	607809	CT12/600	2CSG721170R1101		1.600	1
800	0.5	15	607908	CT12/800	2CSG721180R1101		1.600	1
1000	0.5	20	608004	CT12/1000	2CSG721190R1101		1.600	1
1200	0.5	20	608103	CT12/1200	2CSG721200R1101		1.600	1
1500	0.5	20	608202	CT12/1500	2CSG721220R1101		1.600	1
2000	0.5	30	608301	CT12/2000	2CSG721230R1101		1.600	1
2500	0.5	40	608400	CT12/2500	2CSG721240R1101		1.600	1
3000	0.5	40	608509	CT12/3000	2CSG721250R1101		1.600	1
4000	0.5	50	608608	CT12/4000	2CSG721260R1101		2.000	1
5000	0.5	50	745600	CT12/5000	2CSG721270R1101		3.000	1
6000	0.5	50	745709	CT12/6000	2CSG721280R1101		3.000	1

CT12-V .../5 A series, through primary								
Primary rated current I_{prim} A	Accuracy class	Rated power VA	Bbn 8012542 EAN	Order details		Price 1 piece	Weight 1 piece kg	Pack unit pc.
				Type code	Order code			
800	0.5	10	609605	CT12-V/800	2CSG831180R1101		0.700	1
1000	0.5	10	609704	CT12-V/1000	2CSG831190R1101		0.700	1
1200	0.5	10	609803	CT12-V/1200	2CSG831200R1101		0.700	1
1250	0.5	10	609902	CT12-V/1250	2CSG831210R1101		0.700	1
1500	0.5	12	610007	CT12-V/1500	2CSG831220R1101		0.700	1
2000	0.5	15	610106	CT12-V/2000	2CSG831230R1101		1.000	1
2500	0.5	20	610205	CT12-V/2500	2CSG831240R1101		1.000	1
3000	0.5	20	610304	CT12-V/3000	2CSG831250R1101		1.000	1
4000	0.5	20	745808	CT12-V/4000	2CSG831260R1101		1.000	1

CT12 series		
Through primary	max section [mm] up to 4000A	max section [mm] 5000 and 6000 A
cable 	2x50	-
horizontal bar 	125x50	120x10, 2x120x10, 3x120x10
vertical bar 	-	200x10, 2x200x10, 3x200x10

CT12-V series		
Through primary	max section [mm]	
cable 	3x35	
horizontal bar 	-	
vertical bar 	125x30, 3x100x10, 4x125x5	

Maybe you are also interested in:
 Network Analysers and DMTME
 Multimeter p.8/4
 Energy Meters p.8/16
 Analogue and Digital Instrument
 p.8/42



Energy efficiency

CTA measurement current transformers with wound primary



Standard type current transformers .../5 A with wound primary

CTA .../5 A series, wound primary with insertion on Ø8 MA bolt								
Primary rated current I _{prim} A	Accuracy class	Rated power VA	Bbn 8012542 EAN	Order details		Price 1 piece	Weight 1 piece kg	Pack unit pc.
				Type code	Order code			
5	0.5	5	661306	CTA/5	2CSG111020R1141		0.290	1
10	0.5	5	661405	CTA/10	2CSG111030R1141		0.290	1
15	0.5	5	661504	CTA/15	2CSG111040R1141		0.290	1
20	0.5	5	661603	CTA/20	2CSG111050R1141		0.290	1
25	0.5	5	661702	CTA/25	2CSG111060R1141		0.290	1
40	0.5	5	661801	CTA/40	2CSG111080R1141		0.290	1
50	0.5	5	661900	CTA/50	2CSG111090R1141		0.290	1
60	0.5	5	662006	CTA/60	2CSG111100R1141		0.290	1
80	0.5	5	662105	CTA/80	2CSG111110R1141		0.290	1
100	0.5	5	662204	CTA/100	2CSG111120R1141		0.290	1

CTA series		
Wound primary		max section [mm]
cable		8
horizontal bar		-
vertical bar		-

Energy efficiency

CTO split core measurement current transformers



CT30



CT80



CT120

Split core measurement current transformers with through primary

Split core measurement current transformers are used in distribution panels or power centers for maintenance or system expansion. They can be installed easily and they allows to save a lot of time, avoiding bar disconnection. All transformers are complete with terminal caps and fastening accessories, both on bar and on wall.

CT30/...5 A Split core current transformers

Primary rated current I_{prim} A	Accuracy class	Rated power VA	Bbn 8012542 EAN	Order details		Price 1 piece	Weight 1 piece kg	Pack unit pc.
				Type code	Order code			
100	3	1.5	887805	CT30/100	2CSG101100R1101		0.85	1
150	3	2	887904	CT30/150	2CSG101110R1101		0.85	1
250	0.5	1.5	888109	CT30/250	2CSG101130R1101		0.85	1
400	0.5	2.5	888000	CT30/400	2CSG101150R1101		0.85	1

CT80/...5 A Split core current transformers

Primary rated current I_{prim} A	Accuracy class	Rated power VA	Bbn 8012542 EAN	Order details		Price 1 piece	Weight 1 piece kg	Pack unit pc.
				Type code	Order code			
250	0.5	1	888208	CT80/250	2CSG201130R1101		1.1	1
400	0.5	1.5	888307	CT80/400	2CSG201150R1101		1.1	1
500	0.5	2.5	888406	CT80/500	2CSG201160R1101		1.1	1
600	0.5	2.5	888505	CT80/600	2CSG201170R1101		1.1	1
800	0.5	3	888604	CT80/800	2CSG201180R1101		1.1	1
1000	0.5	5	888703	CT80/1000	2CSG201190R1101		1.1	1
2000	0.5	35	888802	CT80/2000	2CSG301230R1101		1.1	1
2500	0.5	40	888901	CT80/2500	2CSG301240R1101		1.1	1

CT120/...5 A Split core current transformers

Primary rated current I_{prim} A	Accuracy class	Rated power VA	Bbn 8012542 EAN	Order details		Price 1 piece	Weight 1 piece kg	Pack unit pc.
				Type code	Order code			
400	0.5	1.5	889007	CT120/400	2CSG401150R1101		1.3	1
500	0.5	2.5	889106	CT120/500	2CSG401160R1101		1.3	1
600	0.5	2.5	889205	CT120/600	2CSG401170R1101		1.3	1
800	0.5	3	889304	CT120/800	2CSG401180R1101		1.3	1
1000	0.5	5	889403	CT120/1000	2CSG401190R1101		1.3	1
1200	0.5	6	889502	CT120/1200	2CSG401200R1101		1.3	1
1500	0.5	8	889601	CT120/1500	2CSG401220R1101		1.3	1

CT30 series
Through primary max section [mm]

cable	○	
horizontal bar	▬	
vertical bar	▮	2x30x10

CT80 series
Through primary max section [mm]

cable	○	
horizontal bar	▬	
vertical bar	▮	3x80x10

CT120 series
Through primary max section [mm]

cable	○	
horizontal bar	▬	
vertical bar	▮	4x120x10

Maybe you are also interested in:
 Network Analysers and DMTME
 Multimeter p.8/4
 Energy Meters p.8/16
 Analogue and Digital Instrument
 p.8/42

Energy efficiency

TRF M measurement modular current transformers



TRF M

2CSC40002D0211

Modular current transformers with Ø 29 mm through primary, secondary .../5A

TRF M are modular current transformers with through primary for measuring instruments. Their compact size and quick DIN rail plug allow easy installation along with great measurement precision.

Primary rated current I_{prim} A	Accuracy class	Rated power VA	Bbn 8012542 EAN	Order details		Price 1 piece	Weight 1 piece kg	Pack unit pc.
				Type code	Order code			
40	3	1	046912	TRFM/40	2CSM100050R1111		0.721	4
60	1	2	047018	TRFM/60	2CSM100070R1111		0.744	4
100	0.5	2	047117	TRFM/100	2CSM100090R1111		0.744	4
150	0.5	3	047216	TRFM/150	2CSM100100R1111		0.712	4
250	0.5	4	047315	TRFM/250	2CSM100120R1111		0.746	4
400	0.5	6	047407	TRFM/400	2CSM100140R1111		0.780	4
600	0.5	7	047506	TRFM/600	2CSM100160R1111		0.859	4

Energy efficiency

SNT current transformer for d.c. applications



SNT

2CSC-400-002-D0211

Technical features		
Voltage	[mV]	60
Current rating	[A]	from 5 to 1000
Accuracy class		0.5 (from 10 to 30 °C)
Max. load	[Ω]	0.25
Overload for 5 sec.		from 10 to 500 A : 1xIn from 600 to 2000 A: 5xIn at 2500A: 2xIn

Shunts

Shunts have 60 mV voltage and must be used with a maximum load of 0.25 Ω in combination with measurement instruments in d.c.

For an appropriate operation:

- both horizontal and vertical mounting are possible (the horizontal position enables a greater heat consumption)
- the faying surface must be completely used and clean; cover with specific grease after the connection
- screws and bolts must be perfectly tight
- shunts must be sufficiently ventilated; as they are not insulated, it is a good rule to protect them against accidental contacts.

60 mV shunts

Rated current	Bbn 8012542	Order details		Price 1 piece	Weight 1 piece	Pack unit
A	EAN	Type code	Order code		kg	pc.
5	047605	SNT 1/5	2CSM100010R1121		1.300	1
6	047704	SNT 1/6	2CSM100020R1121		1.800	1
10	047803	SNT 1/10	2CSM100030R1121		1.800	1
15	047902	SNT 1/15	2CSM100040R1121		1.800	1
20	048008	SNT 1/20	2CSM100050R1121		1.800	1
25	048107	SNT 1/25	2CSM100060R1121		1.800	1
30	048206	SNT 1/30	2CSM100070R1121		1.300	1
40	048305	SNT 1/40	2CSM100080R1121		1.300	1
50	048404	SNT 1/50	2CSM100090R1121		2.200	1
60	048503	SNT 1/60	2CSM100100R1121		2.200	1
80	048602	SNT 1/80	2CSM100110R1121		1.300	1
100	048701	SNT 1/100	2CSM100120R1121		1.300	1
150	048800	SNT 1/150	2CSM100130R1121		1.300	1
200	048909	SNT 1/200	2CSM100140R1121		1.300	1
250	049005	SNT 1/250	2CSM100150R1121		1.900	1
400	049104	SNT 1/400	2CSM100160R1121		1.900	1
500	049203	SNT 1/500	2CSM100170R1121		1.900	1
600	049302	SNT 1/600	2CSM100180R1121		1.900	1
800	049401	SNT 1/800	2CSM100190R1121		2.200	1
1000	049500	SNT 1/1000	2CSM100200R1121		2.000	1

Maybe you are also interested in:

Network Analysers and DMTME
Multimeter p.8/4
Energy Meters p.8/16
Analogue and Digital Instrument
p.8/42

Energy efficiency

TV voltage transformers



TV2

2CSC400127F0201

Voltage transformers

They are used for transforming primary voltages up to 500 V into secondary voltages of.../100 V max. for indirect supply of analogue as well as digital measurement instruments.
R3 voltage transformers are used in three-phase distribution systems with neutral.

Voltage transformers with metallic housing, precision class 0.5

Primary/secondary voltage	Power	Bbn 8012542	Order details		Price 1 piece	Weight 1 piece	Pack unit
V/V	VA	EAN	Type code	Order code		kg	pc.
230/100	10	730101	TV2-230/100	2CSG324070R5021		2.100	1
380/100	10	730200	TV2-380/100	2CSG324090R5021		2.100	1
400/100	10	730309	TV2-400/100	2CSG324110R5021		2.100	1
440/100	10	730408	TV2-440/100	2CSG324130R5021		2.100	1
500/100	10	730507	TV2-500/100	2CSG324150R5021		2.100	1
600/100	10	730606	TV2-600/100	2CSG324170R5021		2.100	1
230/100- $\sqrt{3}$	5	731009	TV2-230R3/100	2CSG323080R5021		2.100	1
380/100- $\sqrt{3}$	5	731108	TV2-380R3/100	2CSG323100R5021		2.100	1
400/100- $\sqrt{3}$	5	731207	TV2-400R3/100	2CSG323120R5021		2.100	1
440/100- $\sqrt{3}$	5	731306	TV2-440R3/100	2CSG323140R5021		2.100	1
500/100- $\sqrt{3}$	5	731405	TV2-500R3/100	2CSG323160R5021		2.100	1
600/100- $\sqrt{3}$	5	731504	TV2-600R3/100	2CSG323180R5021		2.100	1

Maybe you are also interested in:
 Network Analysers and DMTME
 Multimeter p.8/4
 Energy Meters p.8/16
 Analogue and Digital Instrument
 p.8/42

Energy efficiency CMS – Current Measurement System

Up to 64 sensors
can be connected to
each Control Unit

8



Backlighted
touchscreen

Easy connectors
assembling on flat
cables



The CMS is a multichannel current measurement system for branch monitoring of alternating (AC) and direct (DC) currents up to 160 A. Various sensor types allow the mounting in every installation environment. Measuring currents within power distribution units (PDUs), very close to the electrical loads, increases the efficiency and availability of every installation.

Many companies are very dependent on the trouble-free operation of their electrical systems. Monitoring every branch circuit of an installation with the CMS enables to detect deviations quickly before serious damage is caused.

8



Branch monitoring gives the maximum transparency on where and how the electricity is used. It allows an effective energy management in order to save costs and to assign them fairly.

Up to 64 sensors can be connected to each Control Unit. The sensors measure True RMS, AC and DC currents (actual, min/max, hold values) and transmit their measurement data via the flat cable to the Control Unit. The measured values are displayed locally on the Control Unit's touch display and can be queried remotely by an RS485 Modbus connection.

Energy efficiency Current Measurement System



CMS-600

Control Unit		
Supply voltage	[VDC]	24 (±10%)
Power consumption	[W]	max. 24 W (with 64 sensors)
Interface		RS485 2-wire
Protocol		Modbus RTU
Data rate	[Baud]	2400 ... 115 200
Data refresh time		≤ 1 sec for 64 sensors' results
Insulation Voltage	[V]	400 VAC
Screw-type terminals		0.5 ... 2.5 mm ² , max 0.6 Nm
Mounting		DIN-rail 35 mm acc. DIN50022 or SMISLINE TP busbar system
Dimension	[mm]	71.8 x 87.0 x 64.9 (4 DIN modules)

General Data – Sensors & Control Unit		
Operating temperature	[°C]	-25 ... +70
Operating temperature	[°C]	-40 ... +85
Standards		DIN EN 61010-1

Description	Bbn	Order details		Price 1 piece	Weight 1 piece kg	Pack unit pc.
	7612271	Type code	Order code			
Control Unit (24VDC)						
Modbus RTU	418700	CMS-600	2CCA88000R0001		0.153	1

Where to find more:
Current Measurement System brochure (code 2CCC481002B0201)





CMS-10xPS

2CCA81038F0001



CMS-10xS8

2CCA81038F0001



CMS-10xDR

2CCA81038F0001



CMS-10xDR

2CCA81049F0001

Sensors 18 mm				
Sensor type		CMS-100xx	CMS-101xx	CMS-102xx
Measurement range	[A]	80	40	20
Measurement values		TRMS, AC 50/60 Hz, DC		
Crest factor of distorted wave forms		≤ 1.5	≤ 3	≤ 6
AC Accuracy (TA = +25 °C)*		≤ 0.5 %		
AC Temperature coefficient*		≤ 0.036 %		
DC Accuracy (TA = +25 °C)*		≤ 0.7 %	≤ 1.0 %	≤ 1.7 %
DC Temperature coefficient*		≤ 0.047 %	≤ 0.059 %	≤ 0.084 %
Resolution	[A]	0.01		
Sampling rate internal	[Hz]	5000		
Settling time (±1 %)	[sec]	typ. 0.25		
Cable feed through	[mm]	10		
Insulation Voltage	[V]	690 VAC/1500 VDC		
Overall dimensions				
CMS-100PS series	[mm]	17.4 x 41.0 x 26.5		
CMS-100S8 series	[mm]	26.5 x 45.5 x 31.8		
CMS-100DR series	[mm]	17.4 x 51.5 x 43.2		
CMS-100CA series	[mm]	17.4 x 41.0 x 29.0		

8

Description	Bbn	Order details		Price 1 piece	Weight 1 piece kg	Pack unit pc.
	7612271	Type code	Order code			
Sensors 18 mm for pro M compact & SMISLINE installation devices with twin terminals						
80 A	419202	CMS-100PS	2CCA880100R0001		0.012	1
40 A	419219	CMS-101PS	2CCA880101R0001		0.012	1
20 A	419226	CMS-102PS	2CCA880102R0001		0.012	1
Sensors 18 mm for S800 installation devices with cage terminals						
80 A	426552	CMS-100S8	2CCA880124R0001		0.014	1
40 A	426569	CMS-101S8	2CCA880125R0001		0.014	1
20 A	426576	CMS-102S8	2CCA880126R0001		0.014	1
Sensors 18 mm for DIN-Rail mounting (universal use)						
80 A	426583	CMS-100DR	2CCA880128R0001		0.015	1
40 A	426590	CMS-101DR	2CCA880129R0001		0.015	1
20 A	426606	CMS-102DR	2CCA880130R0001		0.015	1
Sensors 18 mm for cable mounting (universal use)						
80 A	426613	CMS-100CA	2CCA880107R0001		0.011	1
40 A	426620	CMS-101CA	2CCA880108R0001		0.011	1
20 A	426637	CMS-102CA	2CCA880109R0001		0.011	1

Energy efficiency Current Measurement System



CMS-20xS8



CMS-20xDR



CMS-20xCA

Sensors 25 mm				
Sensor type		CMS-200xx	CMS-201xx	CMS-202xx
Measurement range	[A]	160	80	40
Measurement values		TRMS, AC 50/60 Hz, DC		
Crest factor of distorted wave forms		≤ 1.5	≤ 3	≤ 6
AC Accuracy (TA = +25 °C)*		≤ 0.5 %		
AC Temperature coefficient*		≤ 0.036 %		
DC Accuracy (TA = +25 °C)*		≤ 0.7 %	≤ 1.0 %	≤ 1.7 %
DC Temperature coefficient*		≤ 0.047 %	≤ 0.059 %	≤ 0.084 %
Resolution	[A]	0.01		
Sampling rate internal	[Hz]	5000		
Settling time (±1 %)	[sec]	typ. 0.25		
Cable feed through	[mm]	15		
Insulation Voltage	[V]	690 VAC/1500 VDC		
Overall dimensions				
CMS-200S8 series	[mm]	26.5 x 43.0 x 38.5		
CMS-200DR series	[mm]	25.4 x 43.0 x 43.2		
CMS-200CA series	[mm]	25.4 x 43.0 x 35.7		

* of full range

Description	Bbn 7612271	Order details		Price 1 piece	Weight 1 piece kg	Pack unit pc.
	EAN	Type code	Order code			
Sensors 25 mm for S800 installation devices with cage terminals						
160 A	426644	CMS-200S8	2CCA880136R0001		0.028	1
80 A	426651	CMS-201S8	2CCA880137R0001		0.028	1
40 A	426668	CMS-202S8	2CCA880138R0001		0.028	1
Sensors 25 mm for DIN-Rail mounting (universal use)						
160 A	426675	CMS-200DR	2CCA880132R0001		0.030	1
80 A	426682	CMS-201DR	2CCA880133R0001		0.030	1
40 A	426699	CMS-202DR	2CCA880134R0001		0.030	1
Sensors 25 mm for cable mounting (universal use)						
160 A	426705	CMS-200CA	2CCA880117R0001		0.026	1
80 A	426712	CMS-201CA	2CCA880118R0001		0.026	1
40 A	426729	CMS-202CA	2CCA880119R0001		0.026	1

Accessories

Description	Bbn 7612271	Order details		Price 1 piece	Weight 1 piece kg	Pack unit pc.
	EAN	Type code	Order code			
Flat cable 2 m	419233	CMS-800	2CCA880148R0001		0.017	1
Flat cable 3 m	424428	CMS-801	2CCA880149R0001		0.025	1
Connector set	419240	CMS-820	2CCA880145R0001		0.024	35

Where to find more:

Current Measurement System brochure (code 2CCC481002B0201)



System pro *M* compact® SMISLINE TP plug-in system

Index

MCBs S 400 E	9/4
MCBs S 400 M	9/7
MCBs S 400 M-UC	9/15
RCCBs F400	9/17
RCCBs F400 K and S	9/19
RCBOs FS401	9/21
RCBOs FS401 K	9/23
RCBOs FS403	9/24
Surge arrester	9/26
Switch disconnecter	9/28
Auxiliary elements and accessories	9/30
Busbar system	9/36

SMISLINE TP plug-in system Changes are never been easier

SMISLINE TP ensures that load-free devices and components can be snapped on and off under voltage without the need for additional personal protective equipment to guard against electrical hazards.

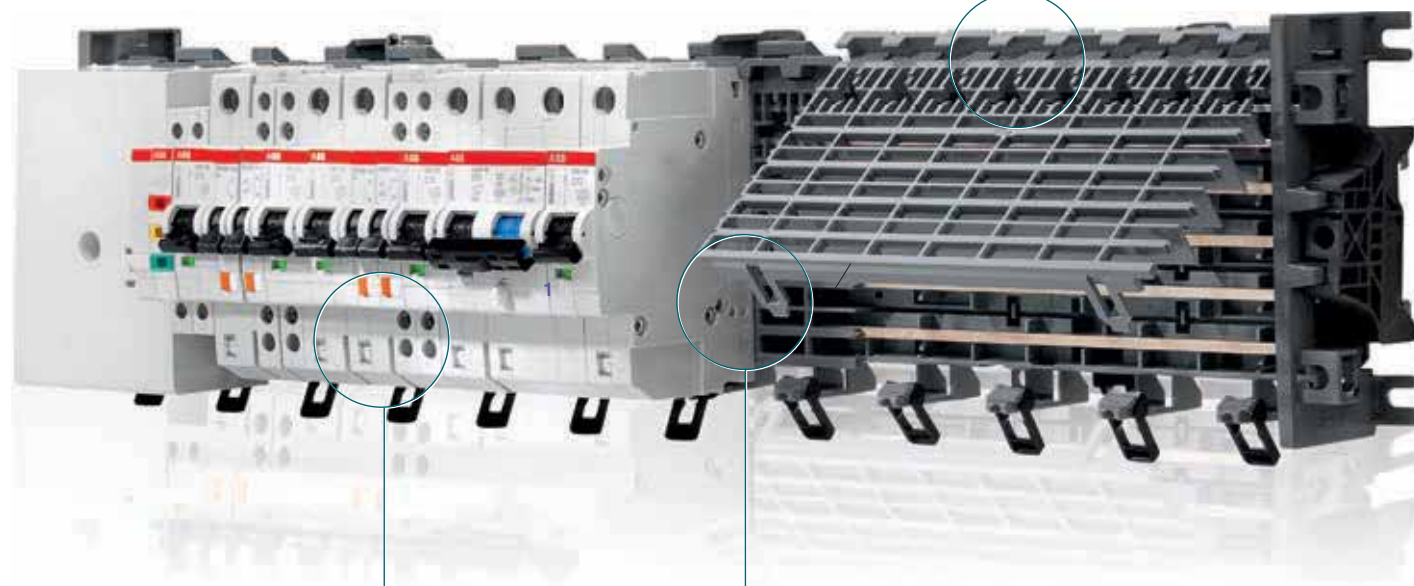

9

It opens up to a completely new prospects for you when it comes to installation, operation and flexibility.

The world's first pluggable socket system.



Even safer: Protection against electrical hazards

We have upgraded our unique SMISLINE socket system even further through the addition of a pioneering innovation. With the new SMISLINE TP system, components can now be plugged in or unplugged load-free without any risk from electrical current running through the body.

The SMISLINE TP pluggable socket system is completely finger-safe (IP2XB) – when devices are plugged in and unplugged, the system is always touch-proof. This means that SMISLINE TP prevents any danger to personnel from switching arcs or accidental arcing.

Even more flexible: make additions and changes during ongoing operation

Pluggable devices can be added and changed quickly, safely and simply during ongoing operation. And this can be done without any need for personal protective equipment.

This means that you benefit from more flexibility, savings on installation and maintenance – and improved safety. SMISLINE TP provides greater availability and operating safety than conventional systems.

9

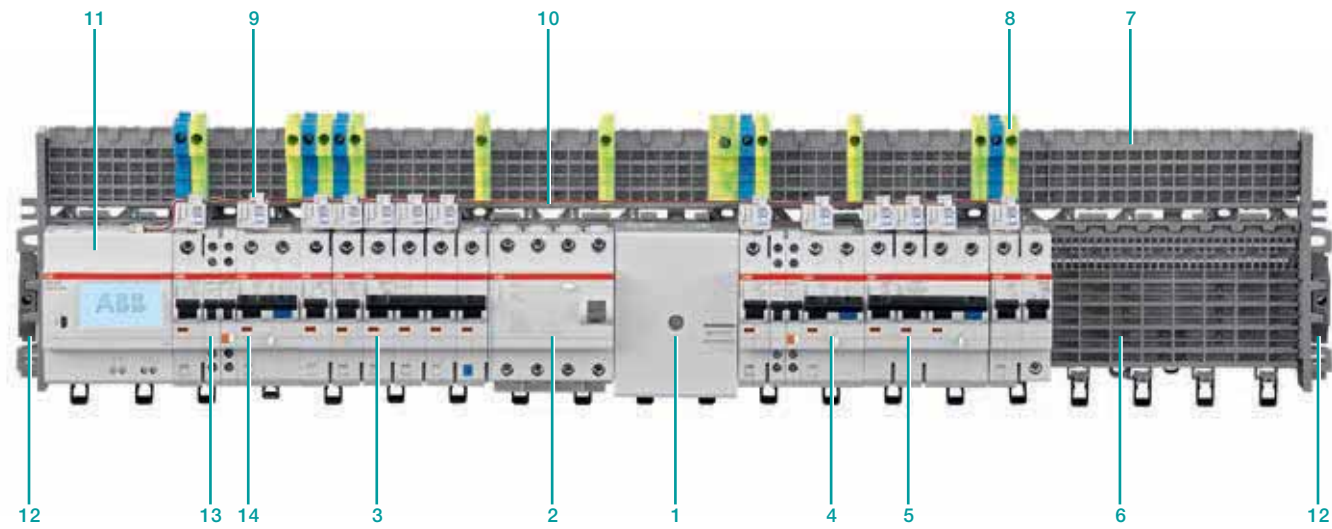

- | | | |
|------------------------------------|-----------------------------------------|----------------------|
| 1 Supply terminal | 6 Socket IP20 | 11 Control unit CMS |
| 2 Surge arrester OVR404 | 7 Additional socket IP20 | 12 Socket end piece |
| 3 Miniature circuit breaker S403NP | 8 Terminals | 13 Auxillary contact |
| 4 RCBO FS401 | 9 Sensor for current measurement system | 14 Signal contact |
| 5 RCBO FS403 | 10 Cabel Bus system CMS | |

SMISLINE TP plug-in system

MCBs S 400 series

		S400M and S400 UC
General Data		IEC/EN 60898-1 S400 B,C,D,K IEC/EN 60947-2 S400 C,K,UCC, UCK
	Poles	1P, 1P+NP, 2P, 3P, 3P+NP
	Tripping characteristics	B,C,D,K, UCC, UCZ
	Rated current I _n	A 0.5 ... 63
	Rated frequency f	Hz 50/60 Hz (16 ² /3 on request)
	Rated insulation voltage U _i acc. to DIN EN 60664-1	V 400 VAC
	Rated impulse withstand voltage U _{imp} (1.2/50 μs)	kV 4 kV
	Overvoltage category	III
	Pollution degree	2
	Data acc. to IEC/EN 60898-1	Rated operational voltage U _e
Max. power frequency recovery voltage (U _{max})		V 1P: 253V AC; 1P+N: 253V AC; 2P: 440V AC; 3...4P: 440V AC; 3P+N: 440V AC; 1P: 72V DC; 2P: 125V DC
Rated short-circuit capacity I _{cn}		kA 6 kA S400E 10 kA S400M
Energy limiting class		3
Reference temperature for tripping characteristics		°C B, C, D: 30 °C K: 40 °C
Data acc. to IEC/EN 60947-2	Electrical and Mechanical Endurance	ops. I _n < 32 A: 20 000 ops (AC), I _n ≥ 32 A: 10 000 ops. (AC)
	Max. power frequency recovery voltage (U _{max})	V 254/440V AC 1P: 60V DC 2P: 125V DC for S400M 1P: 125V DC 2P: 250V DC for S400 UCC and UCZ
	Rated ultimate short-circuit capacity I _{cu}	kA 50 kA ≤ 2 A 25 kA > 2 A ... ≤ 20 A 10 kA ≥ 25 A
	Rated service short-circuit capacity I _{cs}	kA 50 kA ≤ 2 A 15 kA > 2 A...< 20 A 7.5 kA ≥ 25 A
	Dielectric test voltage	kV
	Reference temperature for tripping characteristics	°C C: 30 °C K: 40 °C
	Electrical and Mechanical Endurance	ops. I _n < 32 A: 20 000 operating cycles I _n ≥ 32 A: 10 000 operating cycles
Mechanical Data	Housing	Insulation group I, RAL 7035
	Toggle	Insulation group II, black, sealable
	Classification acc. To NF F 126-101, NF F 16-102	
	Protection degree acc. to EN 60529	IP20*, IP40 in enclosure with cover
	Mechanical endurance	ops. 20 000 ops.
	Shock resistance acc. to IEC/EN 60068-2-30	
	Vibration resistance acc. to IEC/EN 60068-2-6	5 g – 20 cycles at 5 ... 150 ... 5 Hz with load 0.8 I _n
	Environmental conditions (damp heat) acc. to IEC/EN 60068-2-30	°C/RH 28 cycles with 55 °C/90–96 % and 25 °C/95–100 %
	Ambient temperature	°C –25 ... +55 °C
	Storage temperature	°C –40 ... +70 °C
Installation	Standed Cross-section of conductors (top/bottom)	mm ² top 0.75–25 mm ² /bottom no terminal pluggable MCB
	Flexible Cross-section of conductors (top/bottom)	mm ²
	Tightening torque	Nm 2.8 Nm in-lbs.
	Screwdriver	No. 2 Pozidrive
	Mounting	plug in on bus bar system SMISLINE
	Mounting position	any
Dimensions and weight	Supply	any
	Mounting dimensions acc. to DIN 43880	
	Pole dimensions (H x D x W)	mm 91x18x82
Pole weight	g 141	

SMISLINE TP plug-in system

MCBs S 400 E series 6000 B characteristic



S 401 E



S 452 E



S 453 E

S400E Characteristic B

Function: protection and control of the circuits against overloads and short-circuits; protection for people and big length cables in TN and IT systems.

Applications: residential, commercial and industrial.

Applications: residential, commercial and industrial.

Standard: IEC/EN 60898

Icn = 6 kA

Number of poles	Rated current	Bbn 761227	Order details		Price 1 piece	Weight 1 piece kg	Pack unit pc.
	In A	EAN	Type code	Order code			
1	6	0101009	S401 E-B 6	2CCS551001R0065		0.141	10
	8	0108442	S401 E-B 8	2CCS551001R0085		0.141	10
	10	0101016	S401 E-B 10	2CCS551001R0105		0.141	10
	13	0101023	S401 E-B 13	2CCS551001R0135		0.141	10
	16	0101030	S401 E-B 16	2CCS551001R0165		0.141	10
	20	0101047	S401 E-B 20	2CCS551001R0205		0.141	10
	25	0101054	S401 E-B 25	2CCS551001R0255		0.141	10
	32	0101061	S401 E-B 32	2CCS551001R0325		0.141	10
	40	0101078	S401 E-B 40	2CCS551001R0405		0.141	10
	50	0101085	S401 E-B 50	2CCS551001R0505		0.141	10
63	0101092	S401 E-B 63	2CCS551001R0635		0.141	10	
2	6	0101771	S402 E-B 6	2CCS552001R0065		0.282	5
	8	0108459	S402 E-B 8	2CCS552001R0085		0.282	5
	10	0101788	S402 E-B 10	2CCS552001R0105		0.282	5
	13	0101795	S402 E-B 13	2CCS552001R0135		0.282	5
	16	0101801	S402 E-B 16	2CCS552001R0165		0.282	5
	20	0101818	S402 E-B 20	2CCS552001R0205		0.282	5
	25	0101825	S402 E-B 25	2CCS552001R0255		0.282	5
	32	0101832	S402 E-B 32	2CCS552001R0325		0.282	5
	40	0101849	S402 E-B 40	2CCS552001R0405		0.282	5
	50	0101856	S402 E-B 50	2CCS552001R0505		0.282	5
63	0101863	S402 E-B 63	2CCS552001R0635		0.282	5	
3	6	0102549	S403 E-B 6	2CCS553001R0065		0.423	3
	8	0108466	S403 E-B 8	2CCS553001R0085		0.423	3
	10	0102556	S403 E-B 10	2CCS553001R0105		0.423	3
	13	0102563	S403 E-B 13	2CCS553001R0135		0.423	3
	16	0102570	S403 E-B 16	2CCS553001R0165		0.423	3
	20	0102587	S403 E-B 20	2CCS553001R0205		0.423	3
	25	0102594	S403 E-B 25	2CCS553001R0255		0.423	3
	32	0102600	S403 E-B 32	2CCS553001R0325		0.423	3
	40	0102617	S403 E-B 40	2CCS553001R0405		0.423	3
	50	0102624	S403 E-B 50	2CCS553001R0505		0.423	3
63	0102631	S403 E-B 63	2CCS553001R0635		0.423	3	

Where to find more:
 SMISLINE technical guide (code 2CC451059C0202)
 Back-up and Selectivity of SMISLINE technical document (code 2CC451039L0207)



Maybe you are also interested in:
 SMISLINE Auxiliary Elements and Accessories p.9/30
 SMISLINE Busbar Systems p.9/36

SMISLINE TP plug-in system

MCBs S 400 E series 6000 C characteristic



S400E Characteristic C

Function: protection and control of the circuits against overloads and short-circuits; protection for resistive and inductive loads with low inrush current.

Applications: residential, commercial and industrial.

Applications: residential, commercial and industrial.

Standard: IEC/EN 60898

Icn = 6 kA



Number of poles	Rated current In A	Bbn 761227 EAN	Order details		Price 1 piece	Weight 1 piece kg	Pack unit pc.	
			Type code	Order code				
1	6	0101108	S401 E-C 6	2CCS551001R0064		0.141	10	
	8	0101115	S401 E-C 8	2CCS551001R0084		0.141	10	
	10	0101122	S401 E-C 10	2CCS551001R0104		0.141	10	
	13	0101139	S401 E-C 13	2CCS551001R0134		0.141	10	
	16	0101146	S401 E-C 16	2CCS551001R0164		0.141	10	
	20	0101153	S401 E-C 20	2CCS551001R0204		0.141	10	
	25	0101160	S401 E-C 25	2CCS551001R0254		0.141	10	
	32	0101177	S401 E-C 32	2CCS551001R0324		0.141	10	
	40	0101184	S401 E-C 40	2CCS551001R0404		0.141	10	
	50	0101191	S401 E-C 50	2CCS551001R0504		0.141	10	
	63	0101207	S401 E-C 63	2CCS551001R0634		0.141	10	
	2	6	0101870	S402 E-C 6	2CCS552001R0064		0.282	5
		8	0101887	S402 E-C 8	2CCS552001R0084		0.282	5
10		0101894	S402 E-C 10	2CCS552001R0104		0.282	5	
13		0101900	S402 E-C 13	2CCS552001R0134		0.282	5	
16		0101917	S402 E-C 16	2CCS552001R0164		0.282	5	
20		0101924	S402 E-C 20	2CCS552001R0204		0.282	5	
25		0101931	S402 E-C 25	2CCS552001R0254		0.282	5	
32		0101948	S402 E-C 32	2CCS552001R0324		0.282	5	
40		0101955	S402 E-C 40	2CCS552001R0404		0.282	5	
50		0101962	S402 E-C 50	2CCS552001R0504		0.282	5	
63		0101979	S402 E-C 63	2CCS552001R0634		0.282	5	
3		6	0102648	S403 E-C 6	2CCS553001R0064		0.423	3
		8	0102655	S403 E-C 8	2CCS553001R0084		0.423	3
	10	0102662	S403 E-C 10	2CCS553001R0104		0.423	3	
	13	0102679	S403 E-C 13	2CCS553001R0134		0.423	3	
	16	0102686	S403 E-C 16	2CCS553001R0164		0.423	3	
	20	0102693	S403 E-C 20	2CCS553001R0204		0.423	3	
	25	0102709	S403 E-C 25	2CCS553001R0254		0.423	3	
	32	0102716	S403 E-C 32	2CCS553001R0324		0.423	3	
	40	0102723	S403 E-C 40	2CCS553001R0404		0.423	3	
	50	0102730	S403 E-C 50	2CCS553001R0504		0.423	3	
	63	0102747	S403 E-C 63	2CCS553001R0634		0.423	3	

Where to find more:
 SMISLINE technical guide (code 2CC0451059C0202)
 Back-up and Selectivity of SMISLINE technical document (code 2CC0451039L0207)



Maybe you are also interested in:
 SMISLINE Auxiliary Elements and Accessories p.9/30
 SMISLINE Busbar Systems p.9/36

SMISLINE TP plug-in system

MCBs S 400 M series 10000 B characteristic



S 401



S 452 E



S 403 M

S400M Characteristic B

Function: protection and control of the circuits against overloads and short-circuits; protection for people and big length cables in TN and IT systems.

Applications: residential, commercial and industrial.

Standard: IEC/EN 60898

Icn=10 kA

Number of poles	Rated current	Bbn 761227	Order details		Price 1 piece	Weight 1 piece kg	Pack unit pc.
	In A	EAN	Type code	Order code			
1	4	0101214	S401 M-B 4	2CCS571001R0045		0.141	10
	6	0101221	S401 M-B 6	2CCS571001R0065		0.141	10
	8	0108411	S401 M-B 8	2CCS571001R0085		0.141	10
	10	0101238	S401 M-B 10	2CCS571001R0105		0.141	10
	13	0101245	S401 M-B 13	2CCS571001R0135		0.141	10
	16	0101252	S401 M-B 16	2CCS571001R0165		0.141	10
	20	0101269	S401 M-B 20	2CCS571001R0205		0.141	10
	25	0101276	S401 M-B 25	2CCS571001R0255		0.141	10
	32	0101283	S401 M-B 32	2CCS571001R0325		0.141	10
	40	0101290	S401 M-B 40	2CCS571001R0405		0.141	10
	50	0101306	S401 M-B 50	2CCS571001R0505		0.141	10
	63	0101313	S401 M-B 63	2CCS571001R0635		0.141	10
	2	4	0101986	S402 M-B 4	2CCS572001R0045		0.282
6		0101993	S402 M-B 6	2CCS572001R0065		0.282	5
8		0108428	S402 M-B 8	2CCS572001R0085		0.282	5
10		0102006	S402 M-B 10	2CCS572001R0105		0.282	5
13		0102013	S402 M-B 13	2CCS572001R0135		0.282	5
16		0102020	S402 M-B 16	2CCS572001R0165		0.282	5
20		0102037	S402 M-B 20	2CCS572001R0205		0.282	5
25		0102044	S402 M-B 25	2CCS572001R0255		0.282	5
32		0102051	S402 M-B 32	2CCS572001R0325		0.282	5
40		0102068	S402 M-B 40	2CCS572001R0405		0.282	5
50		0102075	S402 M-B 50	2CCS572001R0505		0.282	5
63		0102082	S402 M-B 63	2CCS572001R0635		0.282	5
3		4	0102754	S403 M-B 4	2CCS573001R0045		0.423
	6	0102761	S403 M-B 6	2CCS573001R0065		0.423	3
	8	0108435	S403 M-B 8	2CCS573001R0085		0.423	3
	10	0102778	S403 M-B 10	2CCS573001R0105		0.423	3
	13	0102785	S403 M-B 13	2CCS573001R0135		0.423	3
	16	0102792	S403 M-B 16	2CCS573001R0165		0.423	3
	20	0102808	S403 M-B 20	2CCS573001R0205		0.423	3
	25	0102815	S403 M-B 25	2CCS573001R0255		0.423	3
	32	0102822	S403 M-B 32	2CCS573001R0325		0.423	3
	40	0102839	S403 M-B 40	2CCS573001R0405		0.423	3
	50	0102846	S403 M-B 50	2CCS573001R0505		0.423	3
	63	0102853	S403 M-B 63	2CCS573001R0635		0.423	3

SMISLINE TP plug-in system

MCBs S 400 M series 10000 C characteristic



S 401



S 402 M



S 403 M

S400M Characteristic C

Function: protection and control of the circuits against overloads and short-circuits; protection for resistive and inductive loads with low inrush current.

Applications: residential, commercial and industrial.

Standard: IEC/EN 60898, IEC/EN 60947-2

Icn=10 kA

Number of poles	Rated current In A	Bbn 761227 EAN	Order details		Price 1 piece	Weight 1 piece kg	Pack unit pc.
			Type code	Order code			
1	0.5	0101320	S401 M-C 0.5	2CCS571001R0984		0.141	10
	1	0101337	S401 M-C 1	2CCS571001R0014		0.141	10
	1.6	0101344	S401 M-C 1.6	2CCS571001R0974		0.141	10
	2	0101351	S401 M-C 2	2CCS571001R0024		0.141	10
	3	0101368	S401 M-C 3	2CCS571001R0034		0.141	10
	4	0101375	S401 M-C 4	2CCS571001R0044		0.141	10
	6	0101382	S401 M-C 6	2CCS571001R0064		0.141	10
	8	0101399	S401 M-C 8	2CCS571001R0084		0.141	10
	10	0101405	S401 M-C 10	2CCS571001R0104		0.141	10
	13	0101412	S401 M-C 13	2CCS571001R0134		0.141	10
	16	0101429	S401 M-C 16	2CCS571001R0164		0.141	10
	20	0101436	S401 M-C 20	2CCS571001R0204		0.141	10
	25	0101443	S401 M-C 25	2CCS571001R0254		0.141	10
	32	0101450	S401 M-C 32	2CCS571001R0324		0.141	10
	40	0101467	S401 M-C 40	2CCS571001R0404		0.141	10
	50	0101474	S401 M-C 50	2CCS571001R0504		0.141	10
63	0101481	S401 M-C 63	2CCS571001R0634		0.141	10	
2	0.5	0102099	S402 M-C 0.5	2CCS572001R0984		0.282	5
	1	0102105	S402 M-C 1	2CCS572001R0014		0.282	5
	1.6	0102112	S402 M-C 1.6	2CCS572001R0974		0.282	5
	2	0102129	S402 M-C 2	2CCS572001R0024		0.282	5
	3	0102136	S402 M-C 3	2CCS572001R0034		0.282	5
	4	0102143	S402 M-C 4	2CCS572001R0044		0.282	5
	6	0102150	S402 M-C 6	2CCS572001R0064		0.282	5
	8	0102167	S402 M-C 8	2CCS572001R0084		0.282	5
	10	0102174	S402 M-C 10	2CCS572001R0104		0.282	5
	13	0102181	S402 M-C 13	2CCS572001R0134		0.282	5
	16	0102198	S402 M-C 16	2CCS572001R0164		0.282	5
	20	0102204	S402 M-C 20	2CCS572001R0204		0.282	5
	25	0102211	S402 M-C 25	2CCS572001R0254		0.282	5
	32	0102228	S402 M-C 32	2CCS572001R0324		0.282	5
	40	0102235	S402 M-C 40	2CCS572001R0404		0.282	5
	50	0102242	S402 M-C 50	2CCS572001R0504		0.282	5
63	0102259	S402 M-C 63	2CCS572001R0634		0.282	5	
3	0.5	0102860	S403 M-C 0.5	2CCS573001R0984		0.423	3
	1	0102877	S403 M-C 1	2CCS573001R0014		0.423	3
	1.6	0102884	S403 M-C 1.6	2CCS573001R0974		0.423	3
	2	0102891	S403 M-C 2	2CCS573001R0024		0.423	3
	3	0102907	S403 M-C 3	2CCS573001R0034		0.423	3
	4	0102914	S403 M-C 4	2CCS573001R0044		0.423	3
	6	0102921	S403 M-C 6	2CCS573001R0064		0.423	3
	8	0102938	S403 M-C 8	2CCS573001R0084		0.423	3
	10	0102945	S403 M-C 10	2CCS573001R0104		0.423	3
	13	0102952	S403 M-C 13	2CCS573001R0134		0.423	3
	16	0102969	S403 M-C 16	2CCS573001R0164		0.423	3
	20	0102976	S403 M-C 20	2CCS573001R0204		0.423	3
	25	0102983	S403 M-C 25	2CCS573001R0254		0.423	3
	32	0102990	S403 M-C 32	2CCS573001R0324		0.423	3
	40	0103003	S403 M-C 40	2CCS573001R0404		0.423	3
	50	0103010	S403 M-C 50	2CCS573001R0504		0.423	3
63	0103027	S403 M-C 63	2CCS573001R0634		0.423	3	

Where to find more:
SMISLINE technical guide (code 2CC451059C0202)
Back-up and Selectivity of SMISLINE technical document (code 2CC451039L0207)



Maybe you are also interested in:
SMISLINE Auxiliary Elements and Accessories p.9/30
SMISLINE Busbar Systems p.9/36

SMISLINE TP plug-in system

MCBs S 400 M series 10000 D characteristic



S 401

S400M Characteristic D

Function: protection and control of the circuits against overloads and short-circuits;
protection for circuits which supply loads with high inrush current at the circuit closing
(LV/LV transformers, breakdown lamps).

Applications: residential, commercial and industrial.

Standard: IEC/EN 60898

Icn =10 kA



S 402 M



S 403 M

Number of poles	Rated current	Bbn 761227	Order details		Price 1 piece	Weight 1 piece kg	Pack unit pc.
	In A	EAN	Type code	Order code			
1	6	0101498	S401 M-D 6	2CCS571001R0061		0.141	10
	8	0101504	S401 M-D 8	2CCS571001R0081		0.141	10
	10	0101511	S401 M-D 10	2CCS571001R0101		0.141	10
	13	0101528	S401 M-D 13	2CCS571001R0131		0.141	10
	16	0101535	S401 M-D 16	2CCS571001R0161		0.141	10
	20	0101542	S401 M-D 20	2CCS571001R0201		0.141	10
	25	0101559	S401 M-D 25	2CCS571001R0251		0.141	10
	32	0101566	S401 M-D 32	2CCS571001R0321		0.141	10
	40	0101573	S401 M-D 40	2CCS571001R0401		0.141	10
	50	0101580	S401 M-D 50	2CCS571001R0501		0.141	10
	63	0101597	S401 M-D 63	2CCS571001R0631		0.141	10
2	6	0102266	S402 M-D 6	2CCS572001R0061		0.282	5
	8	0102273	S402 M-D 8	2CCS572001R0081		0.282	5
	10	0102280	S402 M-D 10	2CCS572001R0101		0.282	5
	13	0102297	S402 M-D 13	2CCS572001R0131		0.282	5
	16	0102303	S402 M-D 16	2CCS572001R0161		0.282	5
	20	0102310	S402 M-D 20	2CCS572001R0201		0.282	5
	25	0102327	S402 M-D 25	2CCS572001R0251		0.282	5
	32	0102334	S402 M-D 32	2CCS572001R0321		0.282	5
	40	0102341	S402 M-D 40	2CCS572001R0401		0.282	5
	50	0102358	S402 M-D 50	2CCS572001R0501		0.282	5
	63	0102365	S402 M-D 63	2CCS572001R0631		0.282	5
3	6	0103034	S403 M-D 6	2CCS573001R0061		0.423	3
	8	0103041	S403 M-D 8	2CCS573001R0081		0.423	3
	10	0103058	S403 M-D 10	2CCS573001R0101		0.423	3
	13	0103065	S403 M-D 13	2CCS573001R0131		0.423	3
	16	0103072	S403 M-D 16	2CCS573001R0161		0.423	3
	20	0103089	S403 M-D 20	2CCS573001R0201		0.423	3
	25	0103096	S403 M-D 25	2CCS573001R0251		0.423	3
	32	0103102	S403 M-D 32	2CCS573001R0321		0.423	3
	40	0103119	S403 M-D 40	2CCS573001R0401		0.423	3
	50	0103126	S403 M-D 50	2CCS573001R0501		0.423	3
	63	0103133	S403 M-D 63	2CCS573001R0631		0.423	3

SMISLINE TP plug-in system

MCBs S 400 M series 15000-10000 K characteristic



S 401



S 402 M



S 403 M

S400M Characteristic K

Function: protection and control of the circuits like motors, transformer and auxiliary circuits, against overloads and short-circuits. Advantages: no nuisance tripping in the case of functional peak currents up to 10xIn, depending on the series; through its highly sensitive thermostatic bimetal trip, the K-type characteristic offers protection to damageable elements in the over-current range; it also provides the best protection to cables and lines.

Applications: commercial and industrial.

Standard: IEC/EN 60947-2

Icu=15kA for 0.5 A ≤ In ≤ 40 A, Icu=10 kA for 50 A ≤ In ≤ 63 A

Number of poles	Rated current In A	Bbn 761227 EAN	Order details		Price 1 piece	Weight 1 piece kg	Pack unit pc.
			Type code	Order code			
1	0.5	0101603	S401 M-K 0.5	2CCS571001R0157		0.141	10
	1	0101610	S401 M-K 1	2CCS571001R0217		0.141	10
	1.6	0101627	S401 M-K 1.6	2CCS571001R0257		0.141	10
	2	0101634	S401 M-K 2	2CCS571001R0277		0.141	10
	3	0101641	S401 M-K 3	2CCS571001R0317		0.141	10
	4	0101658	S401 M-K 4	2CCS571001R0337		0.141	10
	6	0101665	S401 M-K 6	2CCS571001R0377		0.141	10
	8	0101672	S401 M-K 8	2CCS571001R0407		0.141	10
	10	0101689	S401 M-K 10	2CCS571001R0427		0.141	10
	13	0101696	S401 M-K 13	2CCS571001R0447		0.141	10
	16	0101702	S401 M-K 16	2CCS571001R0467		0.141	10
	20	0101719	S401 M-K 20	2CCS571001R0487		0.141	10
	25	0101726	S401 M-K 25	2CCS571001R0517		0.141	10
	32	0101733	S401 M-K 32	2CCS571001R0537		0.141	10
	40	0101740	S401 M-K 40	2CCS571001R0557		0.141	10
2	0.5	0102372	S402 M-K 0.5	2CCS572001R0157		0.282	5
	1	0102389	S402 M-K 1	2CCS572001R0217		0.282	5
	1.6	0102396	S402 M-K 1.6	2CCS572001R0257		0.282	5
	2	0102402	S402 M-K 2	2CCS572001R0277		0.282	5
	3	0102419	S402 M-K 3	2CCS572001R0317		0.282	5
	4	0102426	S402 M-K 4	2CCS572001R0337		0.282	5
	6	0102433	S402 M-K 6	2CCS572001R0377		0.282	5
	8	0102440	S402 M-K 8	2CCS572001R0407		0.282	5
	10	0102457	S402 M-K 10	2CCS572001R0427		0.282	5
	13	0102464	S402 M-K 13	2CCS572001R0447		0.282	5
	16	0102471	S402 M-K 16	2CCS572001R0467		0.282	5
	20	0102488	S402 M-K 20	2CCS572001R0487		0.282	5
	25	0102495	S402 M-K 25	2CCS572001R0517		0.282	5
	32	0102501	S402 M-K 32	2CCS572001R0537		0.282	5
	40	0102518	S402 M-K 40	2CCS572001R0557		0.282	5
3	0.5	0103140	S403 M-K 0.5	2CCS573001R0157		0.423	3
	1	0103157	S403 M-K 1	2CCS573001R0217		0.423	3
	1.6	0103164	S403 M-K 1.6	2CCS573001R0257		0.423	3
	2	0103171	S403 M-K 2	2CCS573001R0277		0.423	3
	3	0103188	S403 M-K 3	2CCS573001R0317		0.423	3
	4	0103195	S403 M-K 4	2CCS573001R0337		0.423	3
	6	0103201	S403 M-K 6	2CCS573001R0377		0.423	3
	8	0103218	S403 M-K 8	2CCS573001R0407		0.423	3
	10	0103225	S403 M-K 10	2CCS573001R0427		0.423	3
	13	0103232	S403 M-K 13	2CCS573001R0447		0.423	3
	16	0103249	S403 M-K 16	2CCS573001R0467		0.423	3
	20	0103256	S403 M-K 20	2CCS573001R0487		0.423	3
	25	0103263	S403 M-K 25	2CCS573001R0517		0.423	3
	32	0103270	S403 M-K 32	2CCS573001R0537		0.423	3
	40	0103287	S403 M-K 40	2CCS573001R0557		0.423	3
50	0103294	S403 M-K 50	2CCS573001R0577		0.423	3	
63	0103300	S403 M-K 63	2CCS573001R0597		0.423	3	

Where to find more:
SMISLINE technical guide (code 2CC451059C0202)
Back-up and Selectivity of SMISLINE technical document (code 2CC451039L0207)



Maybe you are also interested in:
SMISLINE Auxiliary Elements and Accessories p.9/30
SMISLINE Busbar Systems p.9/36

SMISLINE TP plug-in system

MCBs S 400 M series 10000 B characteristic



S 402 M



S 403 M

S400M Characteristic B-NP

Function: protection and control of the circuits against overloads and short-circuits; protection for people and big length cables in TN and IT systems. The neutral is full protected.

Applications: residential, commercial and industrial.

Standard: IEC/EN 60898

Icn=10 kA

Number of poles	Rated current	Bbn 761227	Order details		Price 1 piece	Weight 1 piece kg	Pack unit pc.	
	In A	EAN	Type code	Order code				
2	6	0103317	S401 M-B 6NP	2CCS571103R8065		0.282	5	
	8	0108473	S401 M-B 8NP	2CCS571103R8085		0.282	5	
	10	0103324	S401 M-B 10NP	2CCS571103R8105		0.282	5	
	13	0103331	S401 M-B 13NP	2CCS571103R8135		0.282	5	
	16	0103348	S401 M-B 16NP	2CCS571103R8165		0.282	5	
	20	0103355	S401 M-B 20NP	2CCS571103R8205		0.282	5	
	25	0103362	S401 M-B 25NP	2CCS571103R8255		0.282	5	
	32	0103379	S401 M-B 32NP	2CCS571103R8325		0.282	5	
	40	0103386	S401 M-B 40NP	2CCS571103R8405		0.282	5	
	50	0103393	S401 M-B 50NP	2CCS571103R8505		0.282	5	
	63	0103409	S401 M-B 63NP	2CCS571103R8635		0.282	5	
	4	6	0103782	S403 M-B 6NP	2CCS573103R8065		0.564	2
		8	0108510	S403 M-B 8NP	2CCS573103R8085		0.564	2
10		0103799	S403 M-B 10NP	2CCS573103R8105		0.564	2	
13		0103805	S403 M-B 13NP	2CCS573103R8135		0.564	2	
16		0103812	S403 M-B 16NP	2CCS573103R8165		0.564	2	
20		0103829	S403 M-B 20NP	2CCS573103R8205		0.564	2	
25		0103836	S403 M-B 25NP	2CCS573103R8255		0.564	2	
32		0103843	S403 M-B 32NP	2CCS573103R8325		0.564	2	
40		0103850	S403 M-B 40NP	2CCS573103R8405		0.564	2	
50		0103867	S403 M-B 50NP	2CCS573103R8505		0.564	2	
63		0103874	S403 M-B 63NP	2CCS573103R8635		0.564	2	

SMISLINE TP plug-in system

MCBs S 400 M series 10000 C characteristic



S 402 M



S 403 M

S400M Characteristic C-NP

Function: protection and control of the circuits against overloads and short-circuits; protection for resistive and inductive loads with low inrush current. The neutral is full protected.

Applications: residential, commercial and industrial.

Standard: IEC/EN 60898, IEC/EN 60947-2

Icn =10 kA

Number of poles	Rated current	Bbn 761227	Order details		Price 1 piece	Weight 1 piece kg	Pack unit pc.
	In A	EAN	Type code	Order code			
2	2	0108480	S401 M-C 2NP	2CCS571103R8024		0.282	5
	3	0108497	S401 M-C 3NP	2CCS571103R8034		0.282	5
	4	0108503	S401 M-C 4NP	2CCS571103R8044		0.282	5
	6	0103416	S401 M-C 6NP	2CCS571103R8064		0.282	5
	8	0103423	S401 M-C 8NP	2CCS571103R8084		0.282	5
	10	0103430	S401 M-C 10NP	2CCS571103R8104		0.282	5
	13	0103447	S401 M-C 13NP	2CCS571103R8134		0.282	5
	16	0103454	S401 M-C 16NP	2CCS571103R8164		0.282	5
	20	0103461	S401 M-C 20NP	2CCS571103R8204		0.282	5
	25	0103478	S401 M-C 25NP	2CCS571103R8254		0.282	5
	32	0103485	S401 M-C 32NP	2CCS571103R8324		0.282	5
	40	0103492	S401 M-C 40NP	2CCS571103R8404		0.282	5
	50	0103508	S401 M-C 50NP	2CCS571103R8504		0.282	5
	63	0103515	S401 M-C 63NP	2CCS571103R8634		0.282	5
4	2	0108527	S403 M-C 2NP	2CCS573103R8024		0.564	2
	3	0108534	S403 M-C 3NP	2CCS573103R8034		0.564	2
	4	0108541	S403 M-C 4NP	2CCS573103R8044		0.564	2
	6	0103881	S403 M-C 6NP	2CCS573103R8064		0.564	2
	8	0103898	S403 M-C 8NP	2CCS573103R8084		0.564	2
	10	0103904	S403 M-C 10NP	2CCS573103R8104		0.564	2
	13	0103911	S403 M-C 13NP	2CCS573103R8134		0.564	2
	16	0103928	S403 M-C 16NP	2CCS573103R8164		0.564	2
	20	0103935	S403 M-C 20NP	2CCS573103R8204		0.564	2
	25	0103942	S403 M-C 25NP	2CCS573103R8254		0.564	2
	32	0103959	S403 M-C 32NP	2CCS573103R8324		0.564	2
	40	0103966	S403 M-C 40NP	2CCS573103R8404		0.564	2
	50	0103973	S403 M-C 50NP	2CCS573103R8504		0.564	2
	63	0103980	S403 M-C 63NP	2CCS573103R8634		0.564	2

Where to find more:
 SMISLINE technical guide (code 2CCC451059C0202)
 Back-up and Selectivity of SMISLINE technical document (code 2CCC451039L0207)



Maybe you are also interested in:
 SMISLINE Auxiliary Elements and Accessories p.9/30
 SMISLINE Busbar Systems p.9/36

SMISLINE TP plug-in system

MCBs S 400 M series 10000 D characteristic



S 402 M



S 403 M

S400M Characteristic D-NP

Function: protection and control of the circuits against overloads and short-circuits; protection for circuits which supply loads with high inrush current at the circuit closing (LV/LV transformers, breakdown lamps). The neutral is full protected.

Applications: residential, commercial and industrial.

Standard: IEC/EN 60898

Icn =10 kA

Number of poles	Rated current	Bbn 761227	Order details		Price 1 piece	Weight 1 piece kg	Pack unit pc.
	In A	EAN	Type code	Order code			
2	10	0103522	S401 M-D 10NP	2CCS571103R8101		0.282	5
	13	0103539	S401 M-D 13NP	2CCS571103R8131		0.282	5
	16	0103546	S401 M-D 16NP	2CCS571103R8161		0.282	5
	20	0103553	S401 M-D 20NP	2CCS571103R8201		0.282	5
	25	0103560	S401 M-D 25NP	2CCS571103R8251		0.282	5
	32	0103577	S401 M-D 32NP	2CCS571103R8321		0.282	5
	40	0103584	S401 M-D 40NP	2CCS571103R8401		0.282	5
	50	0103591	S401 M-D 50NP	2CCS571103R8501		0.282	5
	63	0103607	S401 M-D 63NP	2CCS571103R8631		0.282	5
4	10	0103997	S403 M-D 10NP	2CCS573103R8101		0.564	2
	13	0104000	S403 M-D 13NP	2CCS573103R8131		0.564	2
	16	0104017	S403 M-D 16NP	2CCS573103R8161		0.564	2
	20	0104024	S403 M-D 20NP	2CCS573103R8201		0.564	2
	25	0104031	S403 M-D 25NP	2CCS573103R8251		0.564	2
	32	0104048	S403 M-D 32NP	2CCS573103R8321		0.564	2
	40	0104055	S403 M-D 40NP	2CCS573103R8401		0.564	2
	50	0104062	S403 M-D 50NP	2CCS573103R8501		0.564	2
	63	0104079	S403 M-D 63NP	2CCS573103R8631		0.564	2

SMISLINE TP plug-in system

MCBs S 400 M series 15000-10000 K characteristic



S 402 M



S 403 M

S400M Characteristic K-NP

Function: protection and control of the circuits like motors, transformer and auxiliary circuits, against overloads and short-circuits.

Advantages: no nuisance tripping in the case of functional peak currents up to 10xI_n, depending on the series; through its highly sensitive thermostatic bimetal trip, the K-type characteristic offers protection to damageable elements in the overcurrent range; it also provides the best protection to cables and lines. The neutral is full protected

Applications: commercial and industrial.

Standard: IEC/EN 60947-2

I_{cu}=15 kA for 0.5 A ≤ I_n ≤ 40 A, I_{cu}=10 kA for 50 A ≤ I_n ≤ 63 A

Number of poles	Rated current	Bbn 761227	Order details		Price 1 piece	Weight 1 piece kg	Pack unit pc.
	In A	EAN	Type code	Order code			
2	0.5	0103614	S401 M-K 0.5NP	2CCS571103R8157		0.282	5
	1	0103621	S401 M-K 1NP	2CCS571103R8217		0.282	5
	1.6	0103638	S401 M-K 1.6NP	2CCS571103R8257		0.282	5
	2	0103645	S401 M-K 2NP	2CCS571103R8277		0.282	5
	3	0103652	S401 M-K 3NP	2CCS571103R8317		0.282	5
	4	0103669	S401 M-K 4NP	2CCS571103R8337		0.282	5
	6	0103676	S401 M-K 6NP	2CCS571103R8377		0.282	5
	8	0103683	S401 M-K 8NP	2CCS571103R8407		0.282	5
	10	0103690	S401 M-K 10NP	2CCS571103R8427		0.282	5
	13	0103706	S401 M-K 13NP	2CCS571103R8447		0.282	5
	16	0103713	S401 M-K 16NP	2CCS571103R8467		0.282	5
	20	0103720	S401 M-K 20NP	2CCS571103R8487		0.282	5
	25	0103737	S401 M-K 25NP	2CCS571103R8517		0.282	5
	32	0103744	S401 M-K 32NP	2CCS571103R8537		0.282	5
	40	0103751	S401 M-K 40NP	2CCS571103R8557		0.282	5
	50	0103768	S401 M-K 50NP	2CCS571103R8577		0.282	5
	63	0103775	S401 M-K 63NP	2CCS571103R8597		0.282	5
4	0.5	0104086	S403 M-K 0.5NP	2CCS573103R8157		0.564	2
	1	0104093	S403 M-K 1NP	2CCS573103R8217		0.564	2
	1.6	0104109	S403 M-K 1.6NP	2CCS573103R8257		0.564	2
	2	0104116	S403 M-K 2NP	2CCS573103R8277		0.564	2
	3	0104123	S403 M-K 3NP	2CCS573103R8317		0.564	2
	4	0104130	S403 M-K 4NP	2CCS573103R8337		0.564	2
	6	0104147	S403 M-K 6NP	2CCS573103R8377		0.564	2
	8	0104154	S403 M-K 8NP	2CCS573103R8407		0.564	2
	10	0104161	S403 M-K 10NP	2CCS573103R8427		0.564	2
	13	0104178	S403 M-K 13NP	2CCS573103R8447		0.564	2
	16	0104185	S403 M-K 16NP	2CCS573103R8467		0.564	2
	20	0104192	S403 M-K 20NP	2CCS573103R8487		0.564	2
	25	0104208	S403 M-K 25NP	2CCS573103R8517		0.564	2
	32	0104215	S403 M-K 32NP	2CCS573103R8537		0.564	2
	40	0104222	S403 M-K 40NP	2CCS573103R8557		0.564	2
50	0104239	S403 M-K 50NP	2CCS573103R8577		0.564	2	
63	0104246	S403 M-K 63NP	2CCS573103R8597		0.564	2	

Where to find more:
SMISLINE technical guide (code 2CC451059C0202)
Back-up and Selectivity of SMISLINE technical document (code 2CC451039L0207)



Maybe you are also interested in:
SMISLINE Auxiliary Elements and Accessories p.9/30
SMISLINE Busbar Systems p.9/36

SMISLINE TP plug-in system

MCBs S 400 M-UC series 10000 C characteristic, DC application



1 P 125 V=



2 P 250 V=

S400UC Characteristic C

Function: protection and control of the circuits against overloads and short-circuits; protection for resistive and inductive loads with low inrush current.

Applications: residential, commercial and industrial.

Standard: IEC/EN 60947-2

Number of poles	Rated current In A	Bbn 761227 EAN	Order details		Price 1 piece	Weight 1 piece kg	Pack unit pc.
			Type code	Order code			
1	0.5	0109746	S401M-UCC0.5	2CCS561001R1984		0.145	10
	1	0109753	S401M-UCC1	2CCS561001R1014		0.145	10
	1.6	0109760	S401M-UCC1.6	2CCS561001R1974		0.145	10
	2	0109777	S401M-UCC2	2CCS561001R1024		0.145	10
	3	0109784	S401M-UCC3	2CCS571001R1034		0.145	10
	4	0109791	S401M-UCC4	2CCS571001R1044		0.145	10
	6	0109807	S401M-UCC6	2CCS571001R1064		0.145	10
	8	0109814	S401M-UCC8	2CCS571001R1084		0.145	10
	10	0109821	S401M-UCC10	2CCS571001R1104		0.145	10
	13	0109838	S401M-UCC13	2CCS571001R1134		0.145	10
	16	0109845	S401M-UCC16	2CCS571001R1164		0.145	10
	20	0109852	S401M-UCC20	2CCS571001R1204		0.145	10
	25	0109869	S401M-UCC25	2CCS571001R1254		0.145	10
	32	0109876	S401M-UCC32	2CCS571001R1324		0.145	10
	40	0109883	S401M-UCC40	2CCS571001R1404		0.145	10
	50	0109890	S401M-UCC50	2CCS571001R1504		0.145	10
63	0109906	S401M-UCC63	2CCS571001R1634		0.145	10	
2	0.5	0109913	S402M-UCC0.5	2CCS562001R1984		0.290	5
	1	0109920	S402M-UCC1	2CCS562001R1014		0.290	5
	1.6	0109937	S402M-UCC1.6	2CCS562001R1974		0.290	5
	2	0109944	S402M-UCC2	2CCS562001R1024		0.290	5
	3	0109951	S402M-UCC3	2CCS572001R1034		0.290	5
	4	0109968	S402M-UCC4	2CCS572001R1044		0.290	5
	6	0109975	S402M-UCC6	2CCS572001R1064		0.290	5
	8	0109982	S402M-UCC8	2CCS572001R1084		0.290	5
	10	0109999	S402M-UCC10	2CCS572001R1104		0.290	5
	13	0110001	S402M-UCC13	2CCS572001R1134		0.290	5
	16	0110018	S402M-UCC16	2CCS572001R1164		0.290	5
	20	0110025	S402M-UCC20	2CCS572001R1204		0.290	5
	25	0110032	S402M-UCC25	2CCS572001R1254		0.290	5
	32	0110049	S402M-UCC32	2CCS572001R1324		0.290	5
	40	0110056	S402M-UCC40	2CCS572001R1404		0.290	5
	50	0110063	S402M-UCC50	2CCS572001R1504		0.290	5
63	0110070	S402M-UCC63	2CCS572001R1634		0.290	5	

Connection diagram, single-pole (max. 125 V=) S401M-UCC

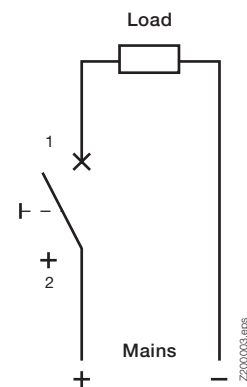

Connection diagram, two-pole (max. 250 V=) S402M-UCC

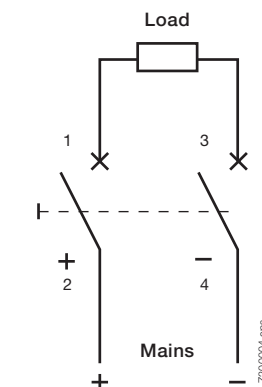

SMISLINE TP plug-in system

MCBs S 400 M-UC series 10000 Z characteristic, DC application



1 P 125 V=



9 2 P 250 V=

S400UC Characteristic Z

Function: protection and control of the electronic circuits against weak and long duration overloads and short-circuits.

Applications: commercial and industrial.

Standard: IEC/EN 60947-2

Number of poles	Rated current	Bbn 761227	Order details		Price 1 piece	Weight 1 piece kg	Pack unit pc.
	In A	EAN	Type code	Order code			
1	0.5	0110087	S401M-UCZ0.5	2CCS561001R1988		0.145	10
	1	0110094	S401M-UCZ1	2CCS561001R1018		0.145	10
	1.6	0110100	S401M-UCZ1.6	2CCS561001R1978		0.145	10
	2	0110117	S401M-UCZ2	2CCS561001R1028		0.145	10
	3	0110124	S401M-UCZ3	2CCS571001R1038		0.145	10
	4	0110131	S401M-UCZ4	2CCS571001R1048		0.145	10
	6	0110148	S401M-UCZ6	2CCS571001R1068		0.145	10
	8	0110155	S401M-UCZ8	2CCS571001R1088		0.145	10
	10	0110162	S401M-UCZ10	2CCS571001R1108		0.145	10
	13	0110179	S401M-UCZ13	2CCS571001R1138		0.145	10
	16	0110186	S401M-UCZ16	2CCS571001R1168		0.145	10
	20	0110193	S401M-UCZ20	2CCS571001R1208		0.145	10
	25	0110209	S401M-UCZ25	2CCS571001R1258		0.145	10
	32	0110216	S401M-UCZ32	2CCS571001R1328		0.145	10
	40	0110223	S401M-UCZ40	2CCS571001R1408		0.145	10
	50	0110230	S401M-UCZ50	2CCS571001R1508		0.145	10
63	0110247	S401M-UCZ63	2CCS571001R1638		0.145	10	
2	0.5	0110254	S402M-UCZ0.5	2CCS562001R1988		0.290	10
	1	0110261	S402M-UCZ1	2CCS562001R1018		0.290	10
	1.6	0110278	S402M-UCZ1.6	2CCS562001R1978		0.290	10
	2	0110285	S402M-UCZ2	2CCS562001R1028		0.290	10
	3	0110292	S402M-UCZ3	2CCS572001R1038		0.290	10
	4	0110308	S402M-UCZ4	2CCS572001R1048		0.290	10
	6	0110315	S402M-UCZ6	2CCS572001R1068		0.290	10
	8	0110322	S402M-UCZ8	2CCS572001R1088		0.290	10
	10	0110339	S402M-UCZ10	2CCS572001R1108		0.290	10
	13	0110346	S402M-UCZ13	2CCS572001R1138		0.290	10
	16	0110353	S402M-UCZ16	2CCS572001R1168		0.290	10
	20	0110360	S402M-UCZ20	2CCS572001R1208		0.290	10
	25	0110377	S402M-UCZ25	2CCS572001R1258		0.290	10
	32	0110384	S402M-UCZ32	2CCS572001R1328		0.290	10
	40	0110391	S402M-UCZ40	2CCS572001R1408		0.290	10
	50	0110407	S402M-UCZ50	2CCS572001R1508		0.290	10
63	0110414	S402M-UCZ63	2CCS572001R1638		0.290	10	

Connection diagram, single-pole (max. 125 V=) S401M-UCZ

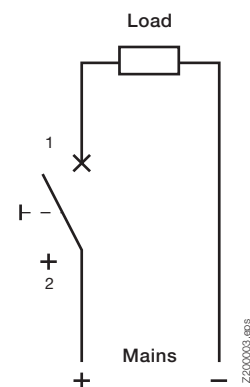

Connection diagram, two-pole (max. 250 V=) S402M-UCZ

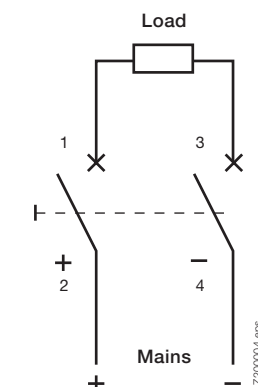

Where to find more:
 SMISLINE technical guide (code 2CC451059C0202)
 Back-up and Selectivity of SMISLINE technical document (code 2CC451039L0207)



Maybe you are also interested in:
 SMISLINE Auxiliary Elements and Accessories p.9/30
 SMISLINE Busbar Systems p.9/36

SMISLINE TP plug-in system

RCCBs F400 series, A type



FS 402

	F402	F404
Rated voltage Un:	230 V	230/400 V
Number of poles:	2	4
Rated frequency fn:	50/60 Hz	50/60 Hz (for Type LF 16 ² / ₃ Hz)
Rated breaking capacity Im:		1000 A
Total trip time (average value)		
– at IΔn	# 300 ms	# 300 ms
– at 5 IΔn	# 40 ms	# 40 ms
Delay time at 5 IΔn:	–	–
Resistance to short circuits (kA):	10 kA in conjunction with an upstream fuse gL / gG 100 A or a high performance MCB S800, 100 A	10 kA in conjunction with an upstream fuse gL / gG 100 A or a high performance MCB S800, 100 A
Connection load side terminal	Double lift terminal touch finger-proof, suitable for connecting single-, multi- and fine-wire conductors of up to 25 mm ²	
Degree of protection:	IP20 inside panel IP40	IP20 inside panel IP40
Endurance:	> 5000 operating cycles	> 5000 operating cycles
Resistance to climate acc. to:	EN 61008	EN 61008
Mounting position:	any	any
Ambient temperature:	–25 °C ... +40 °C	–25 °C ... +55 °C acc. to EN 61009
Vibration resistance:	5 g 5 ... 150 ... 5 Hz	5 g 5 ... 150 ... 5 Hz
Plastic parts:	halogen-free	halogen-free
Contacts:	cadmium-free	cadmium-free

SMISLINE TP plug-in system

RCCBs F400 series, A



FS 402



FS 404

F402 A type

Function: protection against the effects of sinusoidal alternating and direct pulsating earth fault currents; protection against indirect contacts and additional protection against direct (with $I_{\Delta n} = 30 \text{ mA}$) contacts.

Application: residential, commercial, industrial.

Standard: IEC/EN 61008

Marking: according to EN 61008

Number of poles	Rated residual current $I_{\Delta n}$ mA	Rated current In A	Bbn 761227 EAN	Order details		Price 1 piece	Weight 1 piece kg	Pack unit pc.
				Type code	Order code			
2	10	25	0104420	F402 A 25/0.01	2CCF552100E0250		0.250	2
	30	25	0104437	F402 A 25/0.03	2CCF552110E0250		0.250	2
	30	40	0104444	F402 A 40/0.03	2CCF552110E0400		0.250	2
	100	40	0109241	F402 A 40/0.1	2CCF552020E0400		0.250	2

F404 A type

Function: protection against the effects of sinusoidal alternating and direct pulsating earth fault currents; protection against indirect contacts and additional protection against direct (with $I_{\Delta n} = 30 \text{ mA}$) contacts. Product helpful where for installation habits, for wiring with busbars or cables, for special needs neutral on the left is needed.

Application: residential, commercial, industrial.

Standard: IEC/EN 61008

Marking: according to EN 61008

Number of poles	Rated residual current $I_{\Delta n}$ mA	Rated current In A	Bbn 761227 EAN	Order details		Price 1 piece	Weight 1 piece kg	Pack unit pc.
				Type code	Order code			
2	30	25	0104253	F404 A 25/0.03	2CCF544110E0250		0.430	1
	30	40	0104260	F404 A 40/0.03	2CCF544110E0400		0.430	1
	100	40	0104277	F404 A 40/0.1	2CCF544120E0400		0.430	1
	300	40	0104284	F404 A 40/0.3	2CCF544130E0400		0.430	1
	30	63	0104291	F404 A 63/0.03	2CCF544110E0630		0.430	1
	100	63	0104307	F404 A 63/0.1	2CCF544120E0630		0.430	1
	300	63	0104314	F404 A 63/0.3	2CCF544130E0630		0.430	1
	500	63	1401566	F404 A 63/0.5	2CCF600517E0630		0.430	1

F404 A type 16 $\frac{2}{3}$ Hz

Function: protection against the effects of sinusoidal alternating and direct pulsating earth fault currents; protection against indirect contacts and additional protection against direct (with $I_{\Delta n} = 30 \text{ mA}$) contacts.

The RCCB F200 16 $\frac{2}{3}$ Hz can work at rated frequency of 16 $\frac{2}{3}$ Hz which is common in railways applications

Application: railways

Standard: IEC/ EN 61008

Marking: according to EN 61008

Number of poles	Rated residual current $I_{\Delta n}$ mA	Rated current In A	Bbn 761227 EAN	Order details		Price 1 piece	Weight 1 piece kg	Pack unit pc.
				Type code	Order code			
4	30	63	0104376	F404 A-LF 63/0.03	2CCF544110E0631		0.430	1
	300	63	0104383	F404 A-LF 63/0.3	2CCF544130E0631		0.430	1

Where to find more:
SMISLINE technical guide (code 2CC451059C0202)
Back-up and Selectivity of SMISLINE technical document (code 2CC451039L0207)



Maybe you are also interested in:
SMISLINE Auxiliary Elements and Accessories p.9/30
SMISLINE Busbar Systems p.9/36

SMISLINE TP plug-in system

RCCBs F400 series, A K type



FS 402 K and S

	F402...K	F404...K	F404...S
Rated voltage Un:	230 V	230/400 V	230/400 V
Number of poles:	2	4	4
Rated frequency fn:	45 ... 60 Hz	45 ... 60 Hz	45 ... 60 Hz
Resistance to surge current:	3 kA 8/20 μs	3 kA 8/20 μs	5 kA 8/20 μs
Total trip time (average value)			
– at IΔn	240 ms	120 ... 300 ms	150 ... 500 ms
– at 5 IΔn	# 40 ms		40 ... 150 ms
Delay time at 5 IΔn:	10 ms	10 ms	90 ms
Resistance to short circuits (kA):	10 kA in conjunction with an upstream fuse gL / gG 100 A or a high performance MCB S800 100 A	10 kA	10 kA
Connection load side terminal	Double lift terminal touch finger-proof, suitable for connecting single-, multi- and fine-wire conductors of up to 25 mm ²		
Degree of protection:	IP20 in panel IP40	IP20 in panel IP40	IP20 in panel IP40
Endurance:	> 5000 operating cycles	> 5000 operating cycles	> 5000 operating cycles
Resistance to climate acc. to:	EN 61008	EN 61008	EN 61008
Mounting position:	any	any	any
Ambient temperature:	-25 °C ... +40 °C	-25 °C ... +55 °C	-25 °C ... +40 °C
Vibration resistance:	5 g 5 ... 150 ... 5 Hz	5 g 5 ... 150 ... 5 Hz	5 g 5 ... 150 ... 5 Hz
Plastic parts:	halogen-free	halogen-free	halogen-free
Contacts:	cadmium-free	cadmium-free	cadmium-free

SMISLINE TP plug-in system

RCCBs F400 series, A K type



FS 402 K and S



FS 404 K and S

F402 A K type, short-time delayed

Function: protection against the effects of sinusoidal alternating and direct pulsating earth fault currents, providing the best compromise between safety and continuity in the service thanks to the resistance to unwanted trippings; protection against indirect contacts and additional protection against direct ($I_{\Delta n} = 30 \text{ mA}$) contacts.

Application: residential, commercial, industrial.

Standard: IEC/EN 61008

Surge current resistance (wave 8/20) = 3000 A

Marking: according to EN 61008

Number of poles	Rated residual current $I_{\Delta n}$ mA	Rated current In A	Bbn 761227 EAN	Order details		Price 1 piece	Weight 1 piece kg	Pack unit pc.
				Type code	Order code			
2	30	40	0104482	F402 A-K 40/0.03	2CCF552310E0400		0.250	2

F404 A K type, short-time delayed

Function: protection against the effects of sinusoidal alternating and direct pulsating earth fault currents, providing the best compromise between safety and continuity in the service thanks to the resistance to unwanted trippings; protection against indirect contacts and additional protection against direct ($I_{\Delta n} = 30 \text{ mA}$) contacts.

Application: residential, commercial, industrial.

Standard: IEC/EN 61008

Surge current resistance (wave 8/20) = 3000 A

Marking: according to EN 61008

Number of poles	Rated residual current $I_{\Delta n}$ mA	Rated current In A	Bbn 761227 EAN	Order details		Price 1 piece	Weight 1 piece kg	Pack unit pc.
				Type code	Order code			
4	30	40	0104321	F404 A-K 40/0.03	2CCF544310E0400		0.430	1
	100	40	0104338	F404 A-K 40/0.1	2CCF544320E0400		0.430	1
	30	63	0104345	F404 A-K 63/0.03	2CCF544310E0630		0.430	1

F404 A selective type

Function: protection against the effects of sinusoidal alternating and direct pulsating earth fault currents with an intentional tripping delay, which permits to realize the selectivity with downstream instantaneous devices (for more information about selectivity see the technical guide); protection against indirect contacts.

Application: commercial, industrial.

Standard: IEC/EN 61008

Surge current resistance (wave 8/20)=5000 A

Marking: according to EN 61008

Number of poles	Rated residual current $I_{\Delta n}$ mA	Rated current In A	Bbn 761227 EAN	Order details		Price 1 piece	Weight 1 piece kg	Pack unit pc.
				Type code	Order code			
4	100	63	0104352	F404 A-S 63/0.1	2CCF544220E0630		0.430	1
	300	63	0104369	F404 A-S 63/0.3	2CCF544230E0630		0.430	1

Where to find more:

SMISLINE technical guide (code 2CCC451059C0202)
Back-up and Selectivity of SMISLINE technical document (code 2CCC451039L0207)



Maybe you are also interested in:

SMISLINE Auxiliary Elements and Accessories p.9/30
SMISLINE Busbar Systems p.9/36

SMISLINE TP plug-in system

RCBOs FS401 series 10000-6000 A type



FS 401 M

	FS401	FS401K
Rated voltage Un:	230 V ~	
Upstream fuses and	For backup and selectivity, the details for the miniature circuit breakers S400 E and S400 M Page 2/19 to 2/36	
Selectivity limits:		
Number of poles:	2-pole (1PN)	
Rated frequency fn:	50/60 Hz	
Rated breaking capacity Icn:	10 kA – 230 V ~ (10–16 A nominal current)	6 kA – 230 V ~ (20–32 A nominal current)
Current limitation class:	3	
Total cut-off time (average value) acc. to	EN 61009-1	EN 61009-1
– at In	40 ms	240 ms
– at 5 IΔn	25 ms	35 ms
Delay time at 5 IΔn:	–	10 ms
Connection cross-sections	Opposing action stroke clamp on cylinder, touch finger-proof. Suitable for connecting single, multi- and fine-wire conductors of up to 25 mm ²	
Terminal at load end		
Degree of protection:	IP20 inside panel IP40	
Endurance:	> 5000 operating cycles	
Resistance to climate, acc. to:	EN 61009	
Mounting position:	any	
Ambient temperature:	–25 °C ... +40 °C	
Vibration resistance:	5 g	
	5 ... 150 ... 5 Hz	
Plastic parts:	halogen-free	
Contacts:	cadmium-free	

Please notice:

For the influence of the ambient temperature and the thermal influences of row mounted RCBO's it is necessary to calculate with the same correction factors like with MCB's.

9

Residual current operated circuit breakers with overcurrent protection (RCBO)

The SMISLINE residual current operated circuit breakers with overcurrent protection (RCBO) are ideal for protecting people and property in all new and existing distribution systems. The combination of standby current and cable protection in one single device greatly simplifies planning and offers cost benefits. Using a RCBO can e.g. satisfy the minimum level of protection required by regulations in an apartment or in a particular distribution system. Should a residual current arise, only the circuit directly affected is switched off while all other circuits remain in operation.

The short time-delayed residual current operated circuit breaker with overcurrent protection FS401 K is a version particularly suited to unfavourable distribution and load situations. Without limiting the personal protection function in any way, the electronic short time delay prevents nuisance tripping which may arise as a result of capacitive discharge currents.

SMISLINE TP plug-in system

RCBOs FS401 series 10000-6000 A type



FS 401 M

FS401E A type, B and C characteristic

Function: protection of end user single-phase circuits against overload and short-circuit currents; protection against the effects of sinusoidal alternating and direct pulsating earth fault currents; protection against indirect contact and additional protection against direct contact ($I_{\Delta n}=30$ mA).

Application: residential, commercial, industrial.

Standard: IEC/EN 61009

Icn = 6 kA, Icn = 10 kA

Number of poles	Rated current	Bbn 761227	Order details		Price 1 piece	Weight 1 piece kg	Pack unit pc.
	In A	EAN	Type code	Order code			
2	13	0108558	FS401 E-B 13/0.03	2CCL562111E0135		0.250	2
	16	0108565	FS401 E-B 16/0.03	2CCL562111E0165		0.250	2
	20	0109692	FS401 E-B 20/0.03	2CCL562111E0205		0.250	2
	25	0109708	FS401 E-B 25/0.03	2CCL562111E0255		0.250	2
	32	0109715	FS401 E-B 32/0.03	2CCL562111E0325		0.250	2
	13	0108572	FS401 E-C 13/0.03	2CCL562111E0134		0.250	2
	16	0108589	FS401 E-C 16/0.03	2CCL562111E0164		0.250	2
	20	0104574	FS401 E-C 20/0.03	2CCL562110E0204		0.250	2
	25	0104581	FS401 E-C 25/0.03	2CCL562110E0254		0.250	2
	32	0104598	FS401 E-C 32/0.03	2CCL562110E0324		0.250	2
	6	1424534	FS401 M-C6/0.1	2CCL562120E0064		0.240	2
	10	1413217	FS401 M-C10/0.1	2CCL562120E0104		0.240	2
16	1421618	FS401 M-C16/0.1	2CCL562120E0164		0.240	2	
20	1421083	FS401 E-C20/0.1	2CCL562120E0204		0.240	2	
25	1414825	FS401 E-C25/0.1	2CCL562120E0254		0.240	2	
32	1400446	FS401 E-C32/0.1	2CCL562120E0324		0.240	2	

FS401 M A type, B and C characteristic

Function: protection of end user single-phase circuits against overload and short-circuit currents; protection against the effects of sinusoidal alternating and direct pulsating earth fault currents; protection against indirect contact and additional protection against direct contact ($I_{\Delta n}=30$ mA).

Application: residential, commercial, industrial.

Standard: IEC/EN 61009

Icn = 10 kA

Number of poles	Rated current	Bbn 761227	Order details		Price 1 piece	Weight 1 piece kg	Pack unit pc.
	In A	EAN	Type code	Order code			
2	10	0109685	FS401 M-B 10/0.03	2CCL562110E0105		0.250	2
	13	0104505	FS401 M-B 13/0.03	2CCL562110E0135		0.250	2
	16	0104512	FS401 M-B 16/0.03	2CCL562110E0165		0.250	2
	6	1406493	FS401 M-C 6/0.01	2CCL562000E0064		0.250	2
	6	1406905	FS401 M-C 6/0.03	2CCL562010E0064		0.250	2
	10	0104543	FS401 M-C 10/0.03	2CCL562110E0104		0.250	2
	13	0104529	FS401 M-C 13/0.01	2CCL562100E0134		0.250	2
	13	0104550	FS401 M-C 13/0.03	2CCL562110E0134		0.250	2
	16	0104536	FS401 M-C 16/0.01	2CCL562100E0164		0.250	2
	16	0104567	FS401 M-C 16/0.03	2CCL562110E0164		0.250	2

Where to find more:
SMISLINE technical guide (code 2CCC451059C0202)
Back-up and Selectivity of SMISLINE technical document (code 2CCC451039L0207)



Maybe you are also interested in:
SMISLINE Auxiliary Elements and Accessories p.9/30
SMISLINE Busbar Systems p.9/36

SMISLINE TP plug-in system

RCBOs FS401 series 10000 A K type

F401 M A K type, short-time delayed

Function: protection against the effects of sinusoidal alternating and direct pulsating earth fault currents, providing an optimal compromise between safety and continuity of service, thanks to the resistance to unwanted tripping; protection against indirect contact and additional protection against direct ($I_{\Delta n} = 30 \text{ mA}$) contact; protection and isolation of resistive and inductive loads.

Application: residential, commercial, industrial.

Standard: IEC/EN 61009

$I_{cn} = 10 \text{ kA}$

Number of poles	Rated current	Bbn 761227	Order details		Price 1 piece	Weight 1 piece kg	Pack unit pc.
	In A	EAN	Type code	Order code			
2	10	1404031	FS401 M K-C 10/0.03	2CCL562310E0104		0.250	2
	13	0104604	FS401 M K-C 13/0.03	2CCL562310E0134		0.250	2
	16	0104611	FS401 M K-C 16/0.03	2CCL562310E0164		0.250	2
	20	0104628	FS401 E K-C 20/0.03	2CCL562310E0204		0.250	2
	25	0104635	FS401 E K-C 25/0.03	2CCL562310E0254		0.250	2
	32	0104642	FS401 E K-C 32/0.03	2CCL562310E0324		0.250	2

SMISLINE TP plug-in system

RCBOs FS403 series 10000-6000 A type



FS 403 M

	FS403
Rated voltage Un	230/400 V
Number of poles	4
Rated frequency fn	50/60 Hz
Rated breaking capacity Icn	10 kA (10 A to 16 A) 6 kA (20 A to 32 A)
Current limitation class	3
Total cut-off time acc. to EN 61009	
at In	40 ms
at 5x In	25 ms
Connection cross-section	max. 25 mm ² flexible wire with wire end sleeve
Terminal at load side	Possible to connect 2 wires in one chamber. Both chambers could be used with two different cross-sections.
Tightening torque	2.8 Nm
Degree of protection	IP20
Endurance	>5000
Resistance to climate	EN 61009
Ambient temperature	-25° C ... +40° C
Mounting position	any
Vibration resistance	EN 61009
Plastic parts	halogen-free
Contacts	cadmium-free
Standard	EN61009-1, S+ (in preparation)

Accessory:

Auxiliary- and signal contacts are to attach on to the left of the device through the customer.

Please notice:

For the influence of the ambient temperature and the thermal influences of row mounted RCBO's it is necessary to calculate with the same correction factors like with MCBs.

Please see page 2/34.

4-pole RCBO from the ABB SMISLINE protective devices range

The combination of circuit protection and a residual current protection in one device as 4-pole RCBO simplifies both – planning and installation. It enables you to provide perfect protection in one device. This protection consists of:

- Short circuit protection
- Overload protection
- Residual current protection
- Preventive fire protection

High rated short-circuit breaking capacity of 10 kA, conforming to EN 61009-1

The I_{cn} 10 kA short-circuit breaking capacity of the RCBO complies with standard EN 61009-1.

This standard specifies testing and usage of RCBO's for household and similar uses.

The devices can also be used by non-professionals.

Features and benefits of the new devices:

- Overall width of 72 mm (4 modules)
- Rated sensitivity 30 mA
- Current rating 10 A to 32 A
- B and C tripping characteristics
- Easy Drive double deck terminals on the output side for connecting two conductors in one chamber. The two chambers can accommodate conductors with different cross sections.

Where to find more:

SMISLINE technical guide (code 2CCC451059C0202)

Back-up and Selectivity of SMISLINE technical document (code 2CCC451039L0207)



Maybe you are also interested in:

SMISLINE Auxiliary Elements and

Accessories p.9/30

SMISLINE Busbar Systems p.9/36



FS 403 M

FS403 M A type, B and C characteristic

Function: protection of end user single-phase circuits against overload and short-circuit currents; protection against the effects of sinusoidal alternating and direct pulsating earth fault currents; protection against indirect contact and additional protection against direct contact ($I_{\Delta n} = 30 \text{ mA}$).

Application: residential, commercial, industrial.

Standard: IEC/EN 61009

Icn = 6 kA, Icn = 10 kA

Number of poles	Rated current	Bbn 761227	Order details		Price 1 piece	Weight 1 piece kg	Pack unit pc.
	In A	EAN	Type code	Order code			
4	10	1407612	FS403M-B10/0.03	2CCL564110E0105		0.545	1
	13	1407629	FS403M-B13/0.03	2CCL564110E0135		0.545	1
	16	1407636	FS403M-B16/0.03	2CCL564110E0165		0.545	1
	20	1409357	FS403E-B20/0.03	2CCL564111E0205		0.545	1
	25	1408763	FS403E-B25/0.03	2CCL564111E0255		0.545	1
	32	1408756	FS403E-B32/0.03	2CCL564111E0325		0.545	1
	10	1407674	FS403M-C10/0.03	2CCL564110E0104		0.545	1
	13	1407681	FS403M-C13/0.03	2CCL564110E0134		0.545	1
	16	1407698	FS403M-C16/0.03	2CCL564110E0164		0.545	1
	20	1409609	FS403E-C20/0.03	2CCL564111E0203		0.545	1
	25	1408770	FS403E-C25/0.03	2CCL564111E0254		0.545	1
	32	1408787	FS403E-C32/0.03	2CCL564111E0324		0.545	1
	6	1424527	FS403M-C6/0.1	2CCL564121E0064		0.545	1
	10	1424510	FS403M-C10/0.1	2CCL564121E0104		0.545	1
16	1420109	FS403M-C16/0.1	2CCL564120E0164		0.545	1	
20	1424503	FS403E-C20/0.1	2CCL564121E0204		0.545	1	
25	1420178	FS403E-C25/0.1	2CCL564121E0254		0.545	1	
32	1420130	FS403E-C32/0.1	2CCL623169E0254		0.545	1	

SMISLINE TP plug-in system

Surge arrester



OVR454-TNS

Rated voltage Un	230/400 V AC
Max. Continuous voltage Uc	275 V AC
Number of poles	4 (TN-S system)
Power consumption at Un	1.2 W per device
Requirement class according to IEC 61643-1	Type 2
Rated leakage surge current In (8/20 μs)	15 kA
Max. leakage surge current Ismax (8/20 μs)	30 kA
Protection level Up at Isn	≤ 1.5 kV
Up at Is = 5 kV	≤ 1 kV
Max. leakage surge current Isg (8/20 μs)	100 kA 4-pole
Response time ta	≤ 25 ms
Connection cross-sections PE / L1/L2/L3/N	Opposing action stroke clamp on cylinder, touch finger-proof. Suitable for connecting up single-, multi- and fine-wire conductors up to 25 mm ²
Max. Back-up fuse	160 A gL/gG / 25 kA
Short-circuit withstandability with max. Back-up fuse	25 kA
Signal contact max. operating voltage	250 V AC
max. load current	2 A
1 changeover contact	11/12 normally closed contact, 11/14 normally open contact
Temperature range	-25 ... +60 °C
Degree of protection	IP 20
Plastic parts	halogen-free
Contacts	cadmium-free

Description of product

The 'OVR' surge protector is a 4-pole type II surge arrester meeting the requirements of IEC 61643-11.

The OVR is used to protect low voltage distribution systems and devices from overvoltages (DIN VDE 100) caused by remote lightning strikes or switching operations.

Typical sites of use are main and sub-distribution for low voltage systems where the arrester is plugged in directly on to the SMISLINE busbar system.

Display and maintenance

The protective elements (high-performance varistors) are monitored thermally. In the event of a defect, this monitor automatically disconnects the overloaded high-performance varistors from the power supply and the operating indication changes from green to red. This status is also indicated by the signalling contact. In such cases, the arrester should be replaced immediately because the downstream devices are no longer protected against overvoltages.

If the operating indication is neither green nor red, you should check whether the connections are correct. You must also check whether there is any supply voltage.

If the device is connected correctly, the operating display (LED) lights up green.

The surge arrester requires no maintenance. A regular visual check is recommended.

Warning: When taking insulation resistance measurements on the electrical system, the arrester should be disconnected from the power supply since otherwise the measurement may be affected by the arrester characteristics. The enclosed sticker with the corresponding note should be placed in a clear position on the distribution board.

Where to find more:

SMISLINE technical guide (code 2CCC451059C0202)

Back-up and Selectivity of SMISLINE technical document (code 2CCC451039L0207)





OVR454-TNS

2CCF544160E0001

Assembly

Site of installation and electrical connection

The 'OVR' surge arrester installed at the input supply of the system to be protected.
The OVR404 is plugged in directly on to the SMISLINE busbar system.

Earth conductor rating

The OVR should be linked to ground potential using the shortest route possible.
The earth conductor supplied with the device can be used for this purpose. The connection must be as short as possible. The minimum cross-section is 6 mm².

Running cables

Protected and unprotected cables (also including the earth conductor) must not be routed directly parallel to one another. They should be separated such that surge interference from unprotected to protected cables cannot occur. Cables should cross one another at right angles.

Surge arrester OVR404

Rated current	Bbn 761227	Order details		Price 1 piece	Weight 1 piece	Pack unit
Isn (8/20 μs) kA	EAN	Type code	Order code		kg	pc.
15	0104406	OVR404 TNS	2CCF544160E0001		0.430	1

SMISLINE TP plug-in system

Switch disconnecter



IS454 63

Technical data for switch disconnecter IS404

Rated voltage Un	230/400 V ~
Rated current In	63 A
Rated frequency fn	50 Hz
Number of poles	4
Rated impulse withstand voltage	6 kV
Connection cross-sections Cu	At top, touch finger-proof. Suitable for connecting up single-, multi- and fine-wire conductors of up to 25 mm ²
Degree of protection	IP40
Endurance, mechanical/electrical	5000 operating cycles
Mounting position	any
Ambient temperature	-25 °C ... +40 °C
Specifications	EN/IEC 60947-3
Approvals	SEV
Weight (approx.)	250 g
Switching duty	AC-22A
Plastic parts	halogen-free
Contacts	cadmium-free

General switch disconnecter

When used in a smissline socket system, the switch disconnecter can be used instead of the incoming terminal block for up to 63 A.

With the smissline IS404 switch disconnecter, individual loads, groups of loads or entire system parts can be separated or connected to the input supply.

The key features of the switch disconnecter

- Input supply switch
- On-Off function
- Clear indication of switching position
- Snap-on auxiliary switch available
- Uniform smissline design

Where to find more:

SMISLINE technical guide (code 2CCC451059C0202)
 Back-up and Selectivity of SMISLINE technical document (code 2CCC451039L0207)





IS454 63

2CCF544160E0630

Switch disconnecter IS404

Rated current	Bbn 761227	Order details		Price 1 piece	Weight 1 piece	Pack unit
In kA	EAN	Type code	Order code		kg	pc.
63	0104390	IS404 63	2CCF544160E0630		0.380	1

Cover switch disconnecter IS404/F404

The Cover ist for the Incoming terminals

Bbn 761227	Order details		Price 1 piece	Weight 1 piece	Pack unit
EAN	Type code	Order code		kg	pc.
1420451	ZF1301	2CCA601560R0001		0.001	1

SMISLINE TP plug-in system

Auxiliary elements and accessories

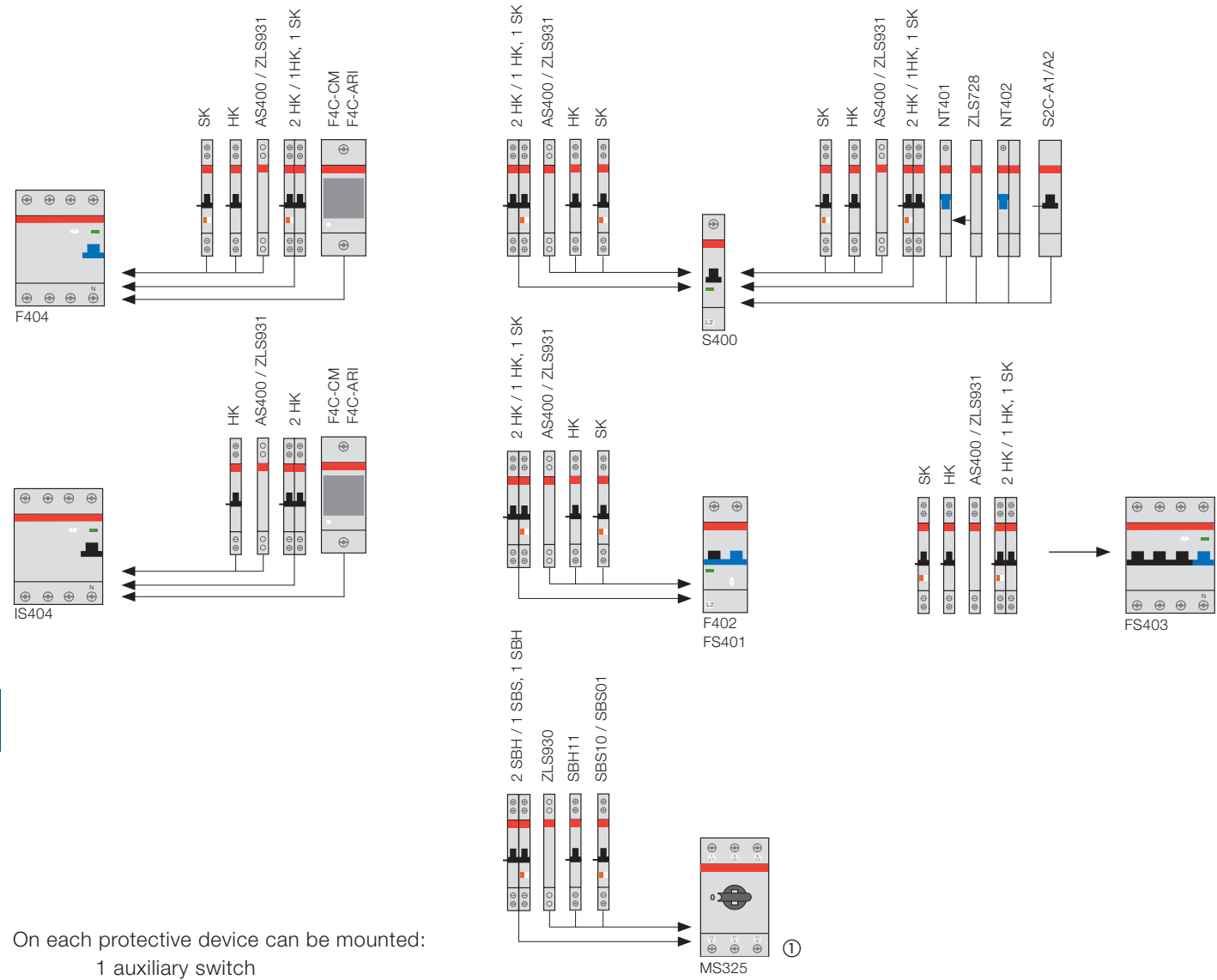

On each protective device can be mounted:

- 1 auxiliary switch
- or 1 signal contact
- or 2 auxiliary contact switches
- or 1 auxiliary switch and 1 signal contact

Contact description signal contact

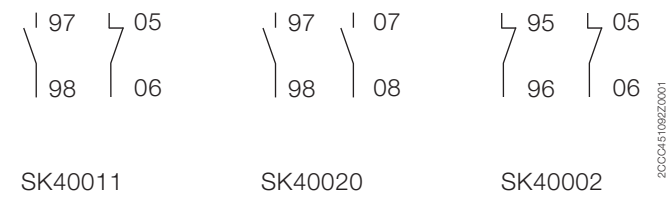

Contact description auxiliary switch

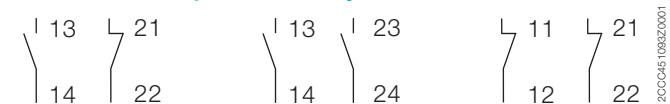

① If you use an auxiliary switch and a signal contact you must connect first the signal contact on the MS325

SMISLINE TP plug-in system

Adapter for motor starter MS116, MS132, MS325

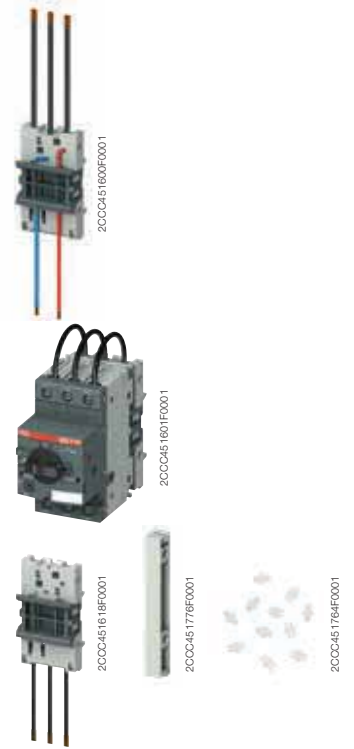

Adapter for MS116, MS132

Designation	Bbn 761227	Order details		Price 1 piece	Weight 1 piece kg	Pack unit pc.
	EAN	Type code	Order code			
Adapter MS116/132 L123 wire bottom feed	1414597	ZMS930	2CCA182520R0001		0.030	1
Adapter MS116/132 L123LALB wire bottom feed	1414580	ZMS931	2CCA182522R0001		0.062	1
Adapter MS116/132 L123 wire top feed	1414573	ZMS932	2CCA182524R0001		0.030	1
Adapter MS116/132 L123LALB wire top feed	1414566	ZMS933	2CCA182526R0001		0.062	1
Adapter MS116/132 empty	1414559	ZMS934	2CCA182512R0001		0.034	1
Intermediate piece 9 mm	1414412	ZMS935	2CCA182616R0001		0.007	1
Adapter MS116/132 L123LA wire top feed	1424626	ZMS937	2CCA182525R0001		0.058	1
Adapter MS116/132 L123LA wire bottom feed	1424619	ZMS936	2CCA182521R0001		0.058	1



Adapter plate for MS325 contact to busbars with plug contacts

	Bbn 761227	Order details		Price 1 piece	Weight 1 piece kg	Pack unit pc.
	EAN	Type code	Order code			
3L	0021215	ZMS915	2CCF002817R0001		0.030	1
L1, N(20 A)	0021222	ZMS916	2CCF002818R0001		0.030	1
L2, N(20 A)	0021239	ZMS917	2CCF002819R0001		0.030	1
L3, N(20 A)	0021246	ZMS918	2CCF002820R0001		0.030	1
2L (reversible)	0021253	ZMS919	2CCF010620R0001		0.030	1

9

Auxiliary switch and signal contacts, connection support

Contact pin, short

	Bbn 761227	Order details		Price 1 piece	Weight 1 piece kg	Pack unit pc.
	EAN	Type code	Order code			
for power supply via auxiliary busbars	0019526		2CCF002794R0001		0.002	1

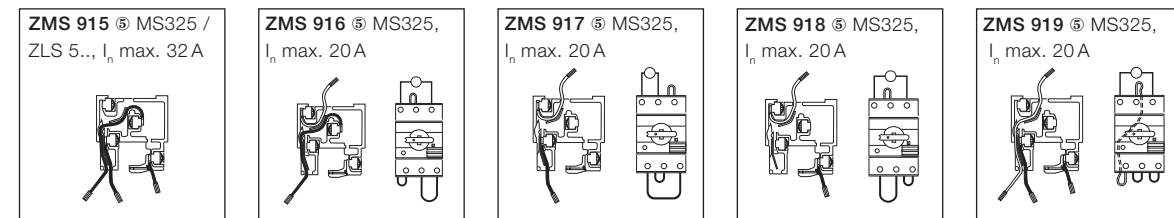

SMISLINE TP plug-in system
 Auxiliary switch and signal contacts
 MCB S400, RCCB F404, RCCB F402, RCBO FS401

Technical data for auxiliary switch and signal contact

	Signal contact SK400	Auxiliary switch HK400
Rated voltage U_n	400 V	400 V
Rated impulse withstand voltage	4 kV	4 kV
Rated current		
– I_{th}	6 A	6 A
– AC15	2 A/230 V / 1 A/400 V	2 A/230 V / 1 A/400 V
– DC13	0.55 A/125 V=	0.55 A/125 V=
– DC13	0.27 A/250 V=	0.27 A/250 V=
Minimum current/voltage (to ensure reliable electrical operation)	10 mA 12 V=	10 mA 12 V=
Connection cross-sections	2 x 1.5 mm ² strand with sleeve	2 x 1.5 mm ² strand with sleeve
Plastic parts	Free of halogen und cadmium	Free of halogen und cadmium
Internal resistance R_i	0.0065 Ω	0.0065 Ω
Power loss at rated current P_v	0.24 W	0.24 W
Ambient temperature	$T_{max.} +55^\circ\text{C}$ $T_{min} -25^\circ\text{C}$	$T_{max.} +55^\circ\text{C}$ $T_{min} -25^\circ\text{C}$
Tightening torque	1 Nm	1 Nm



HK400..L



HK400..R



SK400..L



SK400..R

Auxiliary switch

The auxiliary switch and signal contacts are supplied with one contacting piece. The signal contact collective alarm are supplied with two contacting pieces.

for left side mounting on MCB S400, RCCB F402, RCBO FS401, FS403

	Bbn 761227	Order details		Price 1 piece	Weight 1 piece	Pack unit
	EAN	Type code	Order code		kg	pc.
1NO and 1NC	0100910	HK40011-L	2CCS500900R0081		0.045	10
2NO	0111183	HK40020-L	2CCF201112R0001		0.040	10
2NC	0111190	HK40002-L	2CCF201114R0001		0.040	10

for right side mounting on RCCB F404, MCB S400 and IS404

1NO and 1NC	0108619	HK40011-R	2CCS500900R0214		0.045	10
2NO	0111206	HK40020-R	2CCF201113R0001		0.040	10
2NC	0111213	HK40002-R	2CCF201115R0001		0.040	10

Signal contacts

for left side mounting on MCB S400, RCCB F402, RCBO FS401, FS403

	Bbn 761227	Order details		Price 1 piece	Weight 1 piece	Pack unit
	EAN	Type code	Order code		kg	pc.
1NO and 1NC	0100934	SK40011-L	2CCS500900R0101		0.045	10
2NO	0111107	SK40020-L	2CCF2011162R0001		0.040	10
2NC	0111114	SK40002-L	2CCF2011164R0001		0.040	10

for right side mounting on RCCB F404 and MCB S400

1NO and 1NC	0108626	SK40011-R	2CCS500900R0215		0.045	10
2NO	0111121	SK40020-R	2CCF2011163R0001		0.040	10
2NC	0111138	SK40002-R	2CCF2011165R0001		0.040	10

Signal contact collective alarm and auxiliary contact

for left side mounting

	Bbn 761227	Order details		Price 1 piece	Weight 1 piece	Pack unit
	EAN	Type code	Order code		kg	pc.
1NO	0107964	SK40010-L SA	2CCS500900R0141		0.045	10
1NO	1407902	HK40010-L SA	2CCF201212R0001		0.045	10

for right side mounting

1NO	0108633	SK40010-R SA	2CCS500900R0216		0.045	10
1NO	1407919	HK40010-R SA	2CCF201213R0001		0.045	10

Collective alarm, signal contact contacts the auxiliary busbars LA, LB

A cost-effective collective alarm solution can be implemented without additional wiring by using this arrangement.

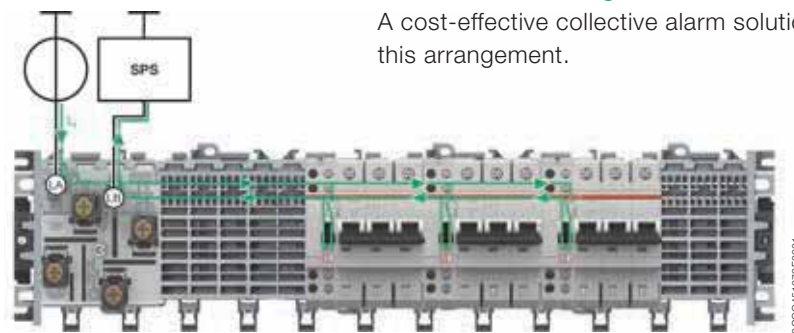

SMISLINE TP plug-in system

Dummy, housing, Neutral disconnecter, shunt trip



Connection support dummy housing for left or right side mounting on MCB S400, RCCB F402, RCCB F404, RCBO FS401

Connection support	Bbn	Order details		Price 1 piece	Weight 1 piece	Pack unit
	761227	Type code	Order code			
	EAN				kg	pc.
	0100958	AS400	2CCS500900R0151		0.045	10

Dummy housing

Compensation to 18 mm	0100965	ZLS931	2CCS500900R0161		0.035	10
-----------------------	---------	--------	-----------------	--	-------	----

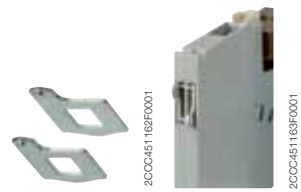

Contacting pieces for auxiliary switch and signal contacts

Connection support	Bbn	Order details		Price 1 piece	Weight 1 piece	Pack unit
	761227	Type code	Order code			
	EAN				kg	pc.
Contacting piece for HK/SK LA, LB Pack contains 100 items	0100972	ZLS632	2CCS500900R0171		0.200	Pack contains 100 items
Contacting piece for HK/SK LA, LB Pack contains 10 items	0109265	ZLS635	2CC5201307R0171		0.020	Pack contains 10 items
Contact Pin	0108640	ZLS633	2CCS500900R0201			Pack contains 10 items

Neutral disconnecter

On the load side terminal two separate conductors can be clamped

Connection support	Bbn	Order details		Price 1 piece	Weight 1 piece	Pack unit
	761227	Type code	Order code			
	EAN				kg	pc.
Neutral disconnecter 9 mm	0100859	NT401 63	2CCS500900R0021		0.045	10
Neutral disconnecter 18 mm	0100842	NT402 63	2CCS500900R0011		0.058	10
Compensation to 18 mm for NT401 63	0104710	ZLS728	2CCS400900R0101		0.015	1 Bag contains 5 items

Shunt trip

Function: remote opening of the device when a voltage is applied.

Suitable for MCBs S400 series.

Rated voltage	Bbn	Order details		Price 1 piece	Weight 1 piece	Pack unit
	801254	Type code	Order code			
	EAN				kg	pc.
12–60 VAC/DC	2570992	S 2C-A1	2CDS200909R0001		0.150	1
110–415 VAC/DC, 110–250 VDC	2571005	S 2C-A2	2CDS200908R0002		0.150	1

Orders for this two types can be done over DESTO



S2C-A

SMISLINE TP plug-in system

F4C-CM motor operating and F4C-ARI auto-reclosing devices



F4C-CM

Motor operating devices for residual current circuit breakers F404 25 ... 63 A

Supply voltage 12 ... 30VAC; 12 ... 48VDC

1 integrated auxiliary contact

	Bbn	Order details		Price	Weight	Pack
	801254	Type code	Order code	1 piece	1 piece	unit
	EAN	Type code	Order code		kg	pc.
	2998730	F4C-CM	2CSF204986R0013		0.166	1

For Supply voltage 230V it is needed to use a safety transformer TS16/12 (2CSM161401R401R0811).

Motor operating auto-reclosing unit for residual current circuit breakers F404 25 ... 63 A

Supply voltage 12 ... 30VAC; 12 ... 48VDC

1 integrated auxiliary contact

	Bbn	Order details		Price	Weight	Pack
	801254	Type code	Order code	1 piece	1 piece	unit
	EAN	Type code	Order code		kg	pc.
	2998631	F4C-ARI	2CSF204987R0013		0.166	1

For Supply voltage 230V it is needed to use a safety transformer TS16/12 (2CSM161401R401R0811).

Safety transformer

	Bbn	Order details		Price	Weight	Pack
	801254	Type code	Order code	1 piece	1 piece	unit
	EAN	Type code	Order code		kg	pc.
	2368908	TS16/12	2CSM161401R0811		0.355	1

SMISLINE TP plug-in system

Busbar system

Busbar system touch proof:

Use only for wall mounted application (horizontal or vertical)

Number of poles:	max. 6 to 110 3p+N / 2 additional bars PE+N
Rated operational voltage (Ue):	690 VAC, 1000 VDC (400 VAC, 250 VDC when use for load-free snapped devices under power)
Rated insulation voltage (Ui):	690 VAC, 1000 VDC
Rated impulse withstand voltage (Uimp):	8 kV
Rated current:	Main circuit: 100 A, mid feeding 160 or 200 A Auxiliary circuit: 40 A
Rated short-time withstand current (Icw):	10 kA/300 ms 10 kA/50 ms for auxiliary circuit
Rated peak withstand current (Ipk):	17 kA
Rated fused short-circuit current (Icf):	50 kA, 690 VAC
Rated peak fused short-circuit current (Ipk):	105 kA, 690 VAC
SCPD:	S800 High performance MCB 160 A gG DIN 00 with 50 mm ² feeder unit 200 A gG DIN 1 with 95 mm ² feeder unit 40 A gG DIN 00 with 10 mm ² feeder unit 40 A gG DIN 00 for auxiliary circuit (La+Lb)
Rated conditional short-circuit current (Icc):	Main circuit and N+PE additional bars: 32.5kA, 400 VAC
Rated peak short-circuit current (Ipk):	68.25 kApk, 400 VAC
Back-up: circuit breaker SACE Tmax 250 A	high performance circuit breaker S800, circuit breaker SACE Tmax 250 A
Protection degree:	IP20B
Rated frequency:	50/60 Hz
Ambient air temperature:	max. 55 °C
Size of CU bars 3P+N+PE:	3 x 10 mm (30 mm ²)
Size of CU auxiliary bars La Lb:	2 x 5 mm (10 mm ²)

	Maximum rated voltage	Maximum rated current	Borne principale
Incoming terminal block ZLS224/225/228/229	690 VAC 1000 VDC	160 A LLLN, 40 A LA, LB	6 mm ² –50 mm ² , 2 x 25 mm ² LLLN, 10 mm ² LA, LB
Incoming terminal block ZLS250–253	690 VAC 1000 VDC	200 A	10 mm ² –95 mm ² max. 1 wire
Incoming terminal block ZLS260–262	690 VAC 1000 VDC	63 A LLLN, 6 A LA, LB	2 mm ² –25 mm ² LLLN, LA, LB max. 1 wire
Busbar ZLS200	690 VAC 1000 VDC	100 A	
Busbar ZLS202	690 VAC 600 VDC	40 A	
Universal adapters 32 A	690 VAC 600 VDC	32 A LLN	
Universal adapters 63 A	690 VAC 600 VDC	63 A LLN	
Combi module	690 VAC 600 VDC	32 A LLN 6A LA, LB	

The SMISLINE system and components are tested for vibration according to IEC 60068-2-6 (2–13.2 Hz/1 mm displacement, 13.2–100 Hz/0.7 g) and for Miniature circuit breakers (5 g, 20 frequency cycles 5 ... 150 ... 5 Hz at 0.8 rated current)
Governing standard: IEC 60068-2-6
Environmental testing – Part 2-6: Test Fc. Vibration (sinusoidal)

Technical data according c us

	Busbar	Incoming terminal block ZLS224, 224R, 225, 225R	Incoming terminal component ZLS250, 251, 252, 253	Universal adapter 30 A	Universal adapter 60 A	Combi module
Maximum rated voltage:		600 VAC	600 VAC	600 VAC	600 VAC	
Maximum rated current:	100 A	150 A	200 A	30 A	60 A	30 A
Rated current for supply, left or right:	100 A	100 A	100 A	–	–	–
Rated current for supply, center:	100 A	150 A	200 A	–	–	–
Resistance to Short circuits:			50 kA	with 200 A back-up fuse		
Supply cable size:		14 to 0, 1/0 AWG	8 to 3/0 AWG	–	–	–

SMISLINE TP plug-in system

Starter pack Touch proof 3L



2CCA18316R0001

Starter Pack 3L: L1, L2, L3 inclusive socket end piece

Solutions available	Busbars length incl. Socket end piece mm	Busbars length mm	Bbn 761227 EAN	Order details		Price 1 piece	Weight 1 piece kg	Pack unit pc.
				Type code	Order code			
18 PLE 3L	364	320	1426514	ZLS905E18-3L	2CCA183232R0001		0.530	1
20 PLE 3L	401	357	1413231	ZLS905E20-3L	2CCA183100R0001		0.637	1
22 PLE 3L	437	393	1413255	ZLS905E22-3L	2CCA183102R0001		0.693	1
24 PLE 3L	473	429	1413279	ZLS905E24-3L	2CCA183104R0001		0.749	1
26 PLE 3L	509	465	1413293	ZLS905E26-3L	2CCA183106R0001		0.813	1
28 PLE 3L	545	501	1413415	ZLS905E28-3L	2CCA183108R0001		0.848	1
30 PLE 3L	581	537	1413439	ZLS905E30-3L	2CCA183110R0001		0.933	1
32 PLE 3L	617	573	1413453	ZLS905E32-3L	2CCA183112R0001		0.981	1
34 PLE 3L	653	609	1413477	ZLS905E34-3L	2CCA183114R0001		1.044	1
36 PLE 3L	689	645	1413491	ZLS905E36-3L	2CCA183116R0001		1.100	1
38 PLE 3L	725	681	1413514	ZLS905E38-3L	2CCA183118R0001		1.156	1
40 PLE 3L	761	717	1413538	ZLS905E40-3L	2CCA183120R0001		1.212	1
42 PLE 3L	797	753	1413552	ZLS905E42-3L	2CCA183122R0001		1.276	1
44 PLE 3L	833	789	1413576	ZLS905E44-3L	2CCA183124R0001		1.332	1
46 PLE 3L	869	825	1413590	ZLS905E46-3L	2CCA183126R0001		1.388	1
48 PLE 3L	905	861	1413613	ZLS905E48-3L	2CCA183128R0001		1.444	1
50 PLE 3L	941	897	1413637	ZLS905E50-3L	2CCA183130R0001		1.508	1
52 PLE 3L	977	933	1413651	ZLS905E52-3L	2CCA183132R0001		1.564	1
54 PLE 3L	1013	969	1413675	ZLS905E54-3L	2CCA183134R0001		1.620	1
56 PLE 3L	1049	1005	1413699	ZLS905E56-3L	2CCA183136R0001		1.675	1
58 PLE 3L	1058	1041	1413712	ZLS905E58-3L	2CCA183138R0001		1.739	1
60 PLE 3L	1122	1078	1413736	ZLS905E60-3L	2CCA183140R0001		1.795	1
62 PLE 3L	1158	1114	1413750	ZLS905E62-3L	2CCA183142R0001		1.851	1
64 PLE 3L	1194	1150	1413774	ZLS905E64-3L	2CCA183144R0001		1.907	1
66 PLE 3L	1230	1186	1413798	ZLS905E66-3L	2CCA183146R0001		1.971	1
68 PLE 3L	1266	1222	1413811	ZLS905E68-3L	2CCA183148R0001		2.027	1
70 PLE 3L	1302	1258	1413835	ZLS905E70-3L	2CCA183150R0001		2.083	1
72 PLE 3L	1338	1294	1413859	ZLS905E72-3L	2CCA183152R0001		2.139	1
74 PLE 3L	1374	1330	1413873	ZLS905E74-3L	2CCA183154R0001		2.203	1
76 PLE 3L	1410	1366	1413897	ZLS905E76-3L	2CCA183156R0001		2.269	1
78 PLE 3L	1446	1402	1413910	ZLS905E78-3L	2CCA183158R0001		2.314	1
80 PLE 3L	1482	1438	1413934	ZLS905E80-3L	2CCA183160R0001		2.370	1

SMISLINE TP plug-in system

Starter pack Touch proof 3LN



Starter Pack 3LN: L1, L2, L3, N inclusive socket end piece

Solutions available	Busbars length incl. Socket end piece mm	Busbars length mm	Bbn 761227 EAN	Order details		Price 1 piece	Weight 1 piece kg	Pack unit pc.
				Type code	Order code			
18 PLE 3LN	364	320	1426521	ZLS905E18-3LN	2CCA183234R0001		0.615	1
20 PLE 3LN	401	357	1413248	ZLS905E20-3LN	2CCA183101R0001		0.724	1
22 PLE 3LN	437	393	1413262	ZLS905E22-3LN	2CCA183103R0001		0.789	1
24 PLE 3LN	473	429	1413286	ZLS905E24-3LN	2CCA183105R0001		0.800	1
26 PLE 3LN	509	465	1413408	ZLS905E26-3LN	2CCA183107R0001		0.926	1
28 PLE 3LN	545	501	1413422	ZLS905E28-3LN	2CCA183109R0001		0.970	1
30 PLE 3LN	581	537	1413446	ZLS905E30-3LN	2CCA183111R0001		1.046	1
32 PLE 3LN	617	573	1413460	ZLS905E32-3LN	2CCA183113R0001		1.120	1
34 PLE 3LN	653	609	1413484	ZLS905E34-3LN	2CCA183115R0001		1.193	1
36 PLE 3LN	689	645	1413507	ZLS905E36-3LN	2CCA183117R0001		1.257	1
38 PLE 3LN	725	681	1413521	ZLS905E38-3LN	2CCA183119R0001		1.322	1
40 PLE 3LN	761	717	1413545	ZLS905E40-3LN	2CCA183121R0001		1.387	1
42 PLE 3LN	797	753	1413569	ZLS905E42-3LN	2CCA183123R0001		1.459	1
44 PLE 3LN	833	789	1413583	ZLS905E44-3LN	2CCA183125R0001		1.524	1
46 PLE 3LN	869	825	1413606	ZLS905E46-3LN	2CCA183127R0001		1.589	1
48 PLE 3LN	905	861	1413620	ZLS905E48-3LN	2CCA183129R0001		1.653	1
50 PLE 3LN	941	897	1413644	ZLS905E50-3LN	2CCA183131R0001		1.726	1
52 PLE 3LN	977	933	1413668	ZLS905E52-3LN	2CCA183133R0001		1.791	1
54 PLE 3LN	1013	969	1413682	ZLS905E54-3LN	2CCA183135R0001		1.855	1
56 PLE 3LN	1049	1005	1413705	ZLS905E56-3LN	2CCA183137R0001		1.920	1
58 PLE 3LN	1085	1041	1413729	ZLS905E58-3LN	2CCA183139R0001		1.992	1
60 PLE 3LN	1122	1078	1413743	ZLS905E60-3LN	2CCA183141R0001		2.057	1
62 PLE 3LN	1158	1114	1413767	ZLS905E62-3LN	2CCA183143R0001		2.122	1
64 PLE 3LN	1194	1150	1413781	ZLS905E64-3LN	2CCA183145R0001		2.186	1
66 PLE 3LN	1230	1186	1413804	ZLS905E66-3LN	2CCA183147R0001		2.259	1
68 PLE 3LN	1266	1222	1413828	ZLS905E68-3LN	2CCA183149R0001		2.324	1
70 PLE 3LN	1302	1258	1413842	ZLS905E70-3LN	2CCA183151R0001		2.388	1
72 PLE 3LN	1338	1294	1413866	ZLS905E72-3LN	2CCA183153R0001		2.453	1
74 PLE 3LN	1374	1330	1413880	ZLS905E74-3LN	2CCA183155R0001		2.526	1
76 PLE 3LN	1410	1366	1413903	ZLS905E76-3LN	2CCA183157R0001		2.590	1
78 PLE 3LN	1446	1402	1413927	ZLS905E78-3LN	2CCA183159R0001		2.655	1
80 PLE 3LN	1482	1438	1413941	ZLS905E80-3LN	2CCA183161R0001		2.719	1

SMISLINE TP plug-in system

Starter pack Touch proof 3L LA LB



20CC46 (09) F0002

Starter Pack 3LLALB: L1, L2, L3, LA, LB inclusive socket end piece

Solutions available	Busbars length incl. Socket end piece mm	Busbars length mm	Bbn 761227 EAN	Order details		Price 1 piece	Weight 1 piece kg	Pack unit pc.
				Type code	Order code			
18 PLE 3L LA LB	364	320	1426538	ZLS905E18-3LLALB	2CCA183233R0001		0.586	1
20 PLE 3L LA LB	401	357	1416904	ZLS905E20-3LLALB	2CCA183162R0001		0.753	1
22 PLE 3L LA LB	437	393	1416911	ZLS905E22-3LLALB	2CCA183164R0001		0.821	1
24 PLE 3L LA LB	473	429	1416928	ZLS905E24-3LLALB	2CCA183166R0001		0.835	1
26 PLE 3L LA LB	509	465	1416935	ZLS905E26-3LLALB	2CCA183168R0001		0.964	1
28 PLE 3L LA LB	545	501	1416942	ZLS905E28-3LLALB	2CCA183170R0001		1.011	1
30 PLE 3L LA LB	581	537	1416959	ZLS905E30-3LLALB	2CCA183172R0001		1.107	1
32 PLE 3L LA LB	617	573	1416966	ZLS905E32-3LLALB	2CCA183174R0001		1.167	1
34 PLE 3L LA LB	653	609	1416973	ZLS905E34-3LLALB	2CCA183176R0001		1.242	1
36 PLE 3L LA LB	689	645	1416980	ZLS905E36-3LLALB	2CCA183178R0001		1.310	1
38 PLE 3L LA LB	725	681	1416997	ZLS905E38-3LLALB	2CCA183180R0001		1.377	1
40 PLE 3L LA LB	761	717	1417000	ZLS905E40-3LLALB	2CCA183182R0001		1.445	1
42 PLE 3L LA LB	797	753	1417017	ZLS905E42-3LLALB	2CCA183184R0001		1.520	1
44 PLE 3L LA LB	833	789	1417024	ZLS905E44-3LLALB	2CCA183186R0001		1.588	1
46 PLE 3L LA LB	869	825	1417031	ZLS905E46-3LLALB	2CCA183188R0001		1.656	1
48 PLE 3L LA LB	905	861	1417048	ZLS905E48-3LLALB	2CCA183190R0001		1.723	1
50 PLE 3L LA LB	941	897	1417055	ZLS905E50-3LLALB	2CCA183192R0001		1.799	1
52 PLE 3L LA LB	977	933	1417062	ZLS905E52-3LLALB	2CCA183194R0001		1.866	1
54 PLE 3L LA LB	1013	969	1417079	ZLS905E54-3LLALB	2CCA183196R0001		1.934	1
56 PLE 3L LA LB	1049	1005	1417086	ZLS905E56-3LLALB	2CCA183198R0001		2.001	1
58 PLE 3L LA LB	1085	1041	1417093	ZLS905E58-3LLALB	2CCA183200R0001		2.077	1
60 PLE 3L LA LB	1122	1078	1417109	ZLS905E60-3LLALB	2CCA183202R0001		2.144	1
62 PLE 3L LA LB	1158	1114	1417116	ZLS905E62-3LLALB	2CCA183204R0001		2.212	1
64 PLE 3L LA LB	1194	1150	1417123	ZLS905E64-3LLALB	2CCA183206R0001		2.279	1
66 PLE 3L LA LB	1230	1186	1417130	ZLS905E66-3LLALB	2CCA183208R0001		2.355	1
68 PLE 3L LA LB	1266	1222	1417147	ZLS905E68-3LLALB	2CCA183210R0001		2.423	1
70 PLE 3L LA LB	1302	1258	1417154	ZLS905E70-3LLALB	2CCA183212R0001		2.490	1
72 PLE 3L LA LB	1338	1294	1417161	ZLS905E72-3LLALB	2CCA183214R0001		2.558	1
74 PLE 3L LA LB	1374	1330	1417178	ZLS905E74-3LLALB	2CCA183216R0001		2.633	1
76 PLE 3L LA LB	1410	1366	1417185	ZLS905E76-3LLALB	2CCA183218R0001		2.701	1
78 PLE 3L LA LB	1446	1402	1417192	ZLS905E78-3LLALB	2CCA183220R0001		2.768	1
80 PLE 3L LA LB	1482	1438	1417208	ZLS905E80-3LLALB	2CCA183222R0001		2.836	1

SMISLINE TP plug-in system

Starter pack Touch proof 3LN LA LB



Starter Pack 3LNLALB: L1, L2, L3, N, LA, LB inclusive socket end piece

Solutions available	Busbars length incl. Socket end piece mm	Busbars length mm	Bbn 761227 EAN	Order details		Price 1 piece	Weight 1 piece kg	Pack unit pc.
				Type code	Order code			
18 PLE 3LN LA LB	364	320	1426545	ZLS905E18-3LNLALB	2CCA183235R0001		0.671	1
20 PLE 3LN LA LB	401	357	1417215	ZLS905E20-3LNLALB	2CCA183163R0001		0.841	1
22 PLE 3LN LA LB	437	393	1417222	ZLS905E22-3LNLALB	2CCA183165R0001		0.917	1
24 PLE 3LN LA LB	473	429	1417239	ZLS905E24-3LNLALB	2CCA183167R0001		0.939	1
26 PLE 3LN LA LB	509	465	1417246	ZLS905E26-3LNLALB	2CCA183169R0001		1.078	1
28 PLE 3LN LA LB	545	501	1417253	ZLS905E28-3LNLALB	2CCA183171R0001		1.133	1
30 PLE 3LN LA LB	581	537	1417260	ZLS905E30-3LNLALB	2CCA183173R0001		1.238	1
32 PLE 3LN LA LB	617	573	1417277	ZLS905E32-3LNLALB	2CCA183175R0001		1.306	1
34 PLE 3LN LA LB	653	609	1417284	ZLS905E34-3LNLALB	2CCA183177R0001		1.391	1
36 PLE 3LN LA LB	689	645	1417291	ZLS905E36-3LNLALB	2CCA183179R0001		1.467	1
38 PLE 3LN LA LB	725	681	1417307	ZLS905E38-3LNLALB	2CCA183181R0001		1.543	1
40 PLE 3LN LA LB	761	717	1417314	ZLS905E40-3LNLALB	2CCA183183R0001		1.619	1
42 PLE 3LN LA LB	797	753	1417321	ZLS905E42-3LNLALB	2CCA183185R0001		1.704	1
44 PLE 3LN LA LB	833	789	1417338	ZLS905E44-3LNLALB	2CCA183187R0001		1.780	1
46 PLE 3LN LA LB	869	825	1417345	ZLS905E46-3LNLALB	2CCA183189R0001		1.856	1
48 PLE 3LN LA LB	905	861	1417352	ZLS905E48-3LNLALB	2CCA183191R0001		1.933	1
50 PLE 3LN LA LB	941	897	1417369	ZLS905E50-3LNLALB	2CCA183193R0001		2.017	1
52 PLE 3LN LA LB	977	933	1417376	ZLS905E52-3LNLALB	2CCA183195R0001		2.093	1
54 PLE 3LN LA LB	1013	969	1417383	ZLS905E54-3LNLALB	2CCA183197R0001		2.169	1
56 PLE 3LN LA LB	1049	1005	1417390	ZLS905E56-3LNLALB	2CCA183199R0001		2.246	1
58 PLE 3LN LA LB	1058	1041	1417406	ZLS905E58-3LNLALB	2CCA183201R0001		2.330	1
60 PLE 3LN LA LB	1122	1078	1417413	ZLS905E60-3LNLALB	2CCA183203R0001		2.406	1
62 PLE 3LN LA LB	1158	1114	1417505	ZLS905E62-3LNLALB	2CCA183205R0001		2.482	1
64 PLE 3LN LA LB	1194	1150	1419172	ZLS905E64-3LNLALB	2CCA183207R0001		2.559	1
66 PLE 3LN LA LB	1230	1186	1417420	ZLS905E66-3LNLALB	2CCA183209R0001		2.643	1
68 PLE 3LN LA LB	1266	1222	1417437	ZLS905E68-3LNLALB	2CCA183211R0001		2.719	1
70 PLE 3LN LA LB	1302	1258	1417444	ZLS905E70-3LNLALB	2CCA183213R0001		2.796	1
72 PLE 3LN LA LB	1338	1294	1417451	ZLS905E72-3LNLALB	2CCA183215R0001		2.872	1
74 PLE 3LN LA LB	1374	1330	1417468	ZLS905E74-3LNLALB	2CCA183217R0001		2.956	1
76 PLE 3LN LA LB	1410	1366	1417475	ZLS905E76-3LNLALB	2CCA183219R0001		3.032	1
78 PLE 3LN LA LB	1446	1402	1417482	ZLS905E78-3LNLALB	2CCA183221R0001		3.109	1
80 PLE 3LN LA LB	1482	1438	1417499	ZLS905E80-3LNLALB	2CCA183223R0001		3.185	1

SMISLINE TP plug-in system

Socket



Socket bases ZLS808, ZLS806

The SMISLINE socket system is a totally new kind of assembly and connection technology for the construction of distributions. Besides the classic method of snapping the devices onto 35-mm mounting rails, the new family of devices can be directly attached to the socket bases with integrated busbars. The time-consuming process of connecting up the supply is thereby no longer needed. In addition, in the event of rearrangement or expansion, the replacement of devices in existing systems is made significantly easier.

The socket sections and the wide range of accessories make it possible to plan with the capability for expansion and to construct distribution systems of any desired size in a short period of time.

6- and 8-module sockets are installed either by screwing them onto any flat surface or by snapping them onto a 35 mm DIN mounting rail. Lateral movement or detachment of the sockets again is possible before final fixing.

In order to determine the required socket length, the space necessary for

- the devices required
- the incoming terminal block and
- any reserve spaces needed must be determined.

Snap mounting

Pull down the slide with a screwdriver until it latches (socket can be moved).

Press on front of slid:

Fixed position

(Sockets fixed)

The key features

- System of any desired length (even number of poles)
- Integrated busbars
- Simple device change
- Long-term planning and problem free extension possible
- Significant time savings during assembly and connection

9

Socket base

Description/ application	Bbn 761227	Order details		Price 1 piece	Weight 1 piece kg	Pack unit pc.
	EAN	Type code	Order code			
8-module socket Length 144 mm (includes base and cover)	1413965	ZLS908	2CCA183030R0001		0.092	10
6-module socket Length 108 mm (includes base and cover)	1413958	ZLS906	2CCA183035R0001		0.071	10

SMISLINE TP plug-in system

Busbars, Socket end piece



ZLS20

2CCC45119R0001

Busbars for the sockets and additional socket ZLS200

The busbars of size 10x3 mm can be loaded with currents up to 100A. They are plated for perfect contact with the devices plug-in contacts. The maximum available busbar length is 1979 mm. The same busbar type is used, regardless whether it is fitted in the socket (L1, L2, L3, N) or in the additional socket (N, PE). The busbars are inserted into the socket from the front.

Auxiliary busbars for the socket ZLS202

The 5x2 mm auxiliary busbars are intended for a common power supply of auxiliary switches and signal contacts. They are also plated and their max. delivery length is 1979 mm. Like the main busbars, the auxiliary busbars are inserted into holders LA and LB from the front. Of course, only one auxiliary busbar can be fitted.

Busbars for the sockets

Description/ application	Bbn 761227	Order details		Price 1 piece	Weight 1 piece kg	Pack unit pc.
	EAN	Type code	Order code			
100 A busbar plated, 10x3 mm, for L1, L2, L3, N and PE – Delivery length 1979 mm	0015702	ZLS200	2CCF002772R0001		0.640	10
40 A auxiliary busbar plated, 5x2 mm, for LA und LB – Delivery length 1979 mm	0015719	ZLS202	2CCF002773R0001		0.240	10

Socket end piece ZLS920

To prevent displacement of sockets and busbars (particularly when installed vertically) end pieces can be fitted at the start and finish of each row of sockets. These simultaneously ensure electrically protected covering of the busbar end faces and mechanical fixing of the sockets on the mounting rail.

Socket end piece

Description/ application	Bbn 761227	Order details		Price 1 piece	Weight 1 piece kg	Pack unit pc.
	EAN	Type code	Order code			
To prevent displacement of sockets and busbars	1415617	ZLS920	2CCA183017R0001			1

9



ZLS920

2CCC451883F0001

2CCC451883F0001

SMISLINE TP plug-in system

Incoming terminal block and components



Incoming terminal blocks ZLS260 to 262

Compact terminal block with the construction width of 18 mm for 2 poles. The maximum rated current is 63 A for L1, L2, L3N and 6 A for LA, LB.

Incoming terminal block 18 mm, 63 A 2,5 mm² to 25 mm² max. 1 wire

1 contact above 1 contact bottom

Version	Bbn 761227	Order details		Price 1 piece	Weight 1 piece	Pack unit
	EAN	Type code	Order code			
L1, L3 63 A	0111572	ZLS260	2CCA205305R0001		0.090	1
L2, N 63 A	0111589	ZLS261	2CCA205306R0001		0.090	1
LA, LB 6 A	0111596	ZLS262	2CCA205307R0001		0.090	1

Incoming terminal component ZLS250-253; 954, 955

The incoming terminal component, with an installation width of 36 mm is available as a single-pole component for the line conductors L1, L2, L3 and as neutral. The terminals act directly on the busbars and thereby fix the incoming terminal component. The incoming terminal component, L1, L2, L3 and N can be combined to meet specific needs. A maximum cable cross-section of 95 mm² can be connected to the incoming terminal component.

Incoming terminal component 10 mm² to 95 mm² max. 1 wire

Version	Bbn 761227	Order details		Price 1 piece	Weight 1 piece	Pack unit
	EAN	Type code	Order code			
Feeder component L1	0505319	ZLS251	2CCV672501R0001		0.120	1
Feeder component L2	0505326	ZLS252	2CCV672502R0001		0.120	1
Feeder component L3	0505333	ZLS253	2CCV672503R0001		0.120	1
Feeder component N	0505340	ZLS250	2CCV672500R0001		0.120	1
Feeder component N additional socket	1424404	ZLS954	2CCV672508R0001		0.100	1
Feeder component PE additional socket	1424411	ZLS955	2CCV672509R0001		0.100	1

SMISLINE TP plug-in system

Incoming terminal block and components



General

The incoming terminal block is used to connect cables directly to the busbars. The terminals act directly on the busbars and therefore fix the incoming terminal block. Removable terminal tops permit the connection of continuous conductors (risers) while horizontal or vertical cable entry is also possible.

Instead of using the incoming terminal block, the power supply can also be realized via a device (e.g. residual current operated circuit breaker, miniature circuit breaker or switch disconnecter).

Power supply left or right, maximum 100 A.



Power supply in centre, maximum 160 A.

A maximum of 100 A is permitted on either side. A total of 160 A must not be exceeded.



Incoming terminal blocks ZLS224, 225

A standard incoming terminal block whose cover provides protection against accidental contact. Construction height 50 mm. The base plate can be fitted with a maximum of 4 main terminals L1, L2, L3 and N for the busbars, and 2 auxiliary terminals LA and LB for the auxiliary busbars.

Incoming terminal blocks 6 mm² to 50 mm² (2 x 25 mm²) + 2 x 10 mm² (LA, LB)

Standard incoming terminal block, complete with main terminals and cover, construction height 50 mm

Version	Bbn 761227	Order details		Price 1 piece	Weight 1 piece kg	Pack unit pc.
	EAN	Type code	Order code			
50 mm ² (2 x 25 mm ²) 3LN left	0019816	ZLS224	2CCF015196R0001		0.180	1
50 mm ² (2 x 25 mm ²) 3LN right	0510726	ZLS224R	2CCA180152R0001		0.180	1
50 mm ² (2 x 25 mm ²) + 2 x 10 mm ² 3LNAB (auxiliary busbars)	0054251	ZLS224LAB	2CCA180154R0001		0.200	1
50 mm ² (2 x 25 mm ²) 3L left	0019823	ZLS225	2CCF015197R0001		0.150	1
50 mm ² (2 x 25 mm ²) 3L right	0510733	ZLS225R	2CCA180153R0001		0.150	1
50 mm ² (2 x 25 mm ²) + 2 x 10 mm ² 3LAB (auxiliary busbars)	0054220	ZLS225LAB	2CCA180155R0001		0.170	1

Cover for standard incoming terminal block

	0021543	ZLS235	2CCA180069R0001		0.037	1
--	---------	--------	-----------------	--	-------	---

Additional parts for standard incoming terminal block

Auxiliary terminal max. 2 items 10 mm ² (for auxiliary bus bars LA, LB)	0019151	ZLS233	2CCF002786R0001		0.010	2
N terminal for incoming terminal block	0019144	ZLS232	2CCF002785R0001		0.030	

9

Incoming terminal blocks, low ZLS228, 229

Incoming terminal block with construction height of 36 mm.

Incoming terminal block, low, complete with main terminals, construction height 36 mm

50 mm ² (2 x 25 mm ²), 3LN	0019854	ZLS228	2CCF015200R0001		0.180	1
50 mm ² (2 x 25 mm ²), 3L	0019861	ZLS229	2CCF015201R0001		0.150	1

SMISLINE TP plug-in system

Terminals for additional socket

Additional socket

The additional socket can easily be fitted onto the socket base to accommodate the external N and/or PE busbars. This enables neutral connections to be made where single-pole miniature circuit breakers are used with unswitched neutral. Neutral terminals are clipped onto the additional socket and can be used as detachable neutral connections. One N busbar and/or one PE busbar can be fitted. Each socket base can be equipped with an additional socket. Because it contains an integrated 35 mm DIN-rail snap-on feature, the external N or PE busbars can be fitted anywhere in the distribution panel, even separately from the system. The additional sockets can be covered to prevent accidental contact with live parts.

Additional socket for external N and PE busbars

Description/ application	Bbn 761227	Order details		Price 1 piece	Weight 1 piece kg	Pack unit pc.
	EAN	Type code	Order code			
- 8-module socket (suitable for 8-module socket)	1420444	ZLS928	2CCA183630R0001		0.034	10
- 6-module socket (suitable for 6-module socket)	1420437	ZLS926	2CCA183635R0001		0.026	10



ZLS92

2CCA183630R0001

2CCA183635R0001

SMISLINE TP plug-in system

Terminals TP, additional socket

N terminals and PE terminals

Corresponding N terminals (blue) or PE terminals (yellow-green) are available for the power supply and the outgoing conductors of the external N and PE busbars for cross sections. The terminals are fitted with label holders which can be used with the marking adapter or the self-adhesive marking label (Phoenix Contact type Clipline UC-TM):

Connection for the terminals

ZLS912, 915 0,75 mm² up to 10 mm² litz wire with ferrule
 1 mm² up to 10 mm² strand
 2 x 1,5 mm² or 2 x 2,5 mm² allowed,
 all other combinations it is only allowed with one wire
 ZLS913, 916 16 mm² up to 35 mm² wire with ferrule, max. 1 wire
 ZLS954, 955 50 mm² up to 95 mm² wire with ferrule, max. 1 wire



N terminal for additional socket light blue, for external busbars

Description/ application	Bbn 761227	Order details		Price 1 piece	Weight 1 piece	Pack unit
	EAN	Type code	Order code		kg	pc.
N 10 mm ²	1421090	ZLS912	2CCA183460R0001		0.012	10
N 35 mm ²	1421304	ZLS913	2CCA183470R0001		0.030	10
N 95 mm ²	1424404	ZLS954	2CCV672508R0001		0.100	1

PE terminal for additional socket yellow-green, for external busbars

Description/ application	Bbn 761227	Order details		Price 1 piece	Weight 1 piece	Pack unit
	EAN	Type code	Order code		kg	pc.
PE 10 mm ²	1421311	ZLS915	2CCA183461R0001		0.012	10
PE 35 mm ²	1421328	ZLS916	2CCA183471R0001		0.030	10
PE 95 mm ²	1424411	ZLS955	2CCV672509R0001		0.100	1

9

Red/orange terminals for additional socket

Description/ application	Bbn 761227	Order details		Price 1 piece	Weight 1 piece	Pack unit
	EAN	Type code	Order code		kg	pc.
10 mm ²	1421335	ZLS912/ Red	2CCA183475R0001		0.012	10
10 mm ²	1421359	ZLS915/ Orange	2CCA183476R0001		0.012	10
35 mm ²	1421342	ZLS913/ Red	2CCA183465R0001		0.030	10
35 mm ²	1421366	ZLS916/ Orange	2CCA183466R0001		0.030	10

Insulator block

The dark grey insulator block isolates the interrupted bus bar ends from one another and simultaneously marks the disconnection point externally.

Description/ application	Bbn 761227	Order details		Price 1 piece	Weight 1 piece	Pack unit
	EAN	Type code	Order code		kg	pc.
	1421373	ZLS917	2CCA183463R0001		0.006	10

SMISLINE TP plug-in system

Socket accessories



2CCA451048F002

Intermediate piece ZLS725

The light grey intermediate piece matches the device profile and fills empty module spaces. The busbars are safely covered, so that they cannot be touched and at the same time the corresponding openings in the cover are closed up.

Intermediate piece

Description/ application	Bbn 761227	Order details		Price 1 piece	Weight 1 piece kg	Pack unit pc.
	EAN	Type code	Order code			
light grey, fills shock-proof empty module spaces 18 mm – bag containing 5 items	0100989	ZLS725	2CCS500900R0181		0.100	1
Compensation piece to 18 mm for NT 9 mm – bag containing 5 items	0104710	ZLS728	2CCS400900R0101		0.070	1



2CCC451688F001

Busbar insulator ZLS938

The dark grey busbar insulator electrically isolates the separated busbar ends from each other (e.g. when using several RCD protected groups) and also identifies the isolation point from outside. It conforms with the device profile and its space requirement is 1 module.

Busbar insulator

dark grey, for isolation and spacing of separate busbar sections, 18 mm	1418205	ZLS938	2CCA205611R0001		0.001	1
-------------------------------------------------------------------------	---------	--------	-----------------	--	-------	---



2CCC451051F001

Busbar cover ZLS100

If component modules or spare modules are not required, the busbar cover ensures electrically protected covering of the main and auxiliary busbars. The cover (4 modules) can be divided anywhere. The openings allow voltage measurements on the busbars without removing the cover.

Busbar cover

electrically protected covering of main and auxiliary busbars. The 4 modules cover can be divided. Suitable to accept extension adapter ZLS 101 4 x 18 mm – bag containing 5 items	0015603	ZLS100	2CCF002762R0001		0.095	1
------------------------------------------------------------------------------------------------------------------------------------------------------------------------------------	---------	--------	-----------------	--	-------	---



2CCC451132F001

Extension adapter ZLS101

The extension adapter, single or several side by side, can be plugged into the busbar cover via the built-in holding device. This enables conventional DIN devices with 45 mm cap size to be snapped onto the SMISLINE socket. By plugging in several extension adapters one on top of the other, heights can be adjusted in multiples of 7 mm

Add-on adapter

18 mm wide, can be plugged on busbar cover ZLS100. To mount conventional DIN devices with 45 mm cap size. – bag containing 10 items	0015610	ZLS101	2CCF002763R0001		0.002	10
-------------------------------------------------------------------------------------------------------------------------------------	---------	--------	-----------------	--	-------	----

SMISLINE TP plug-in system

Combi module 32 A (I_N), 6 A (I_A , I_B)

MS116/132 + AF contactor



Combi module for MS116/MS132 and AF contactor

Description/ application	Bbn 761227	Order details		Price 1 piece	Weight 1 piece kg	Pack unit pc.
	EAN	Type code	Order code			
Combi module L1,L2,L3 top feed	1414641	ZMS132-3L	2CCA182500R0001		0.095	1
Combi module L1,L2,L3 top feed	1414634	ZMS132-3LA	2CCA182502R0001		0.098	1
Combi module L1,L2,L3 top feed	1414627	ZMS132-3LB	2CCA182504R0001		0.098	1
Combi module L1,L2,L3 top feed	1414610	ZMS132-3LAB	2CCA182506R0001		0.102	1
Combi module without plug-in contacts	1414603	ZMS137	2CCA182508R0001		0.075	1
Connection pin to mont 2 combi moduls together	1414801	E210-SPV	2CCC703715R0001			Set à 30
Intermediate piece 9 mm	1414412	ZMS935	2CCA182616R0001		0.006	1



Adapter for manual motor starter MS116 and MS132

Description/ application	Bbn 761227	Order details		Price 1 piece	Weight 1 piece kg	Pack unit pc.
	EAN	Type code	Order code			
Adapter MS116/132 L123 wire bottom feed	1414597	ZMS930	2CCA182520R0001		0.030	1
Adapter MS116/132 L123LALB wire bottom feed	1414580	ZMS931	2CCA182522R0001		0.062	1
Adapter MS116/132 L123 wire top feed	1414573	ZMS932	2CCA182524R0001		0.030	1
Adapter MS116/132 L123LALB wire top feed	1414566	ZMS933	2CCA182526R0001		0.062	1
Adapter MS116/132 empty	1414559	ZMS934	2CCA182512R0001		0.034	1
Intermediate piece 9 mm	1414412	ZMS935	2CCA182616R0001		0.006	1
Adapter MS116/132 L123LA wire bottom feed	1424619	ZMS936	2CCA182521R0001		0.058	1
Adapter MS116/132 L123LA wire top feed	1424626	ZMS937	2CCA182525R0001		0.058	1



Top feed Bottom feed

9

The 9 mm wide additional housing is need to use when an unequal number (1, 3, 5, ...) of combi modules or adapter are plugged on the socket. This is needed to fill the space into a full module (18 mm).
The 9 mm wide additional housing can be also use when on one side of the manual motor starter an auxiliary contact is mounted. The order codes of manual motor starter and the contactors auf in the ABB catalogue DOC 1SBC100155C0202 or in the local ABB catalogue.

SMISLINE TP plug-in system

32 A and 63 A universal adapters



2CCA180660R0001



2CCA180652R0001

32 A and 63 A universal adapters

Single adapter 32 A, bottom feed

Description/ application	Bbn 761227	Order details		Price 1 piece	Weight 1 piece kg	Pack unit pc.
	EAN	Type code	Order code			
L1	0505609	ZLS161	2CCA180660R0001		0.018	1
L2	0505616	ZLS162	2CCA180661R0001		0.018	1
L3	0505623	ZLS163	2CCA180662R0001		0.018	1
N	0505593	ZLS160	2CCA180663R0001		0.018	1
Adapter, dummy element	0505548	ZLS164	2CCA180668R0001		0.012	1

Single adapter 63 A, bottom feed

L1	0505517	ZLS171	2CCA180652R0001		0.020	1
L2	0505524	ZLS172	2CCA180653R0001		0.020	1
L3	0505531	ZLS173	2CCA180654R0001		0.020	1
N	0505500	ZLS170	2CCA180655R0001		0.020	1
Adapter, dummy element	0505548	ZLS164	2CCA180668R0001		0.012	1

Single adapter 32 A, top feed

L1	0505562	ZLS177	2CCA180664R0001		0.018	1
L2	0505579	ZLS178	2CCA180665R0001		0.018	1
L3	0505586	ZLS179	2CCA180666R0001		0.018	1
N	0505555	ZLS176	2CCA180667R0001		0.018	1

Single adapter 63 A, top feed

L1	0505647	ZLS167	2CCA180656R0001		0.020	1
L2	0505654	ZLS168	2CCA180657R0001		0.020	1
L3	0505661	ZLS169	2CCA180658R0001		0.020	1
N	0505630	ZLS166	2CCA180659R0001		0.020	1

Combination 32 A, bottom feed

L1, N	0523399	ZLS180	2CCA180970R0001		0.040	1
L2, N	0523405	ZLS181	2CCA180971R0001		0.040	1
L3, N	0523412	ZLS182	2CCA180972R0001		0.040	1
L1, L2, L3	0523429	ZLS183	2CCA180973R0001		0.060	1
L1, L2, L3, N	0523436	ZLS184	2CCA180974R0001		0.080	1

Combination 63 A, bottom feed

L1, N	0523443	ZLS186	2CCA180975R0001		0.040	1
L2, N	0523450	ZLS187	2CCA180976R0001		0.040	1
L3, N	0523467	ZLS188	2CCA180977R0001		0.040	1
L1, L2, L3	0523474	ZLS189	2CCA180978R0001		0.060	1
L1, L2, L3, N	0523481	ZLS190	2CCA180979R0001		0.080	1

Combination 32 A, top feed

L1, N	0510665	ZLS191	2CCA181629R0001		0.036	1
L2, N	0510672	ZLS192	2CCA181630R0001		0.036	1
L3, N	0510689	ZLS193	2CCA181631R0001		0.036	1
L1, L2, L3	0510696	ZLS194	2CCA181632R0001		0.054	1
L1, L2, L3, N	0510702	ZLS195	2CCA181633R0001		0.072	1



2CCA180944R0001



2CCA180945R0001

32 A and 63 A universal adapters

Single adapter, wire length 300 mm, 32 A top feed

Description/ application	Bbn 761227	Order details		Price 1 piece	Weight 1 piece kg	Pack unit pc.
	EAN	Type code	Order code			
N	0100767	ZLS176L300	2CCA181657R0001		0.035	1
L1	0100774	ZLS177L300	2CCA181656R0001		0.035	1
L2	0100781	ZLS178L300	2CCA181655R0001		0.035	1
L3	0100798	ZLS179L300	2CCA181654R0001		0.035	1

Single adapter, wire length 300 mm, 63 A bottom feed

N	0510788	ZLS170L300	2CCA181612R0001		0.035	1
L1	0510795	ZLS171L300	2CCA181613R0001		0.035	1
L2	0510801	ZLS172L300	2CCA181614R0001		0.035	1
L3	0510818	ZLS173L300	2CCA181615R0001		0.035	1

Single adapter, wire length 300 mm, 32 A bottom feed

N	0100804	ZLS160L300	2CCA181653R0001		0.035	1
L1	0100811	ZLS161L300	2CCA181652R0001		0.035	1
L2	0100828	ZLS162L300	2CCA181651R0001		0.035	1
L3	0100835	ZLS163L300	2CCA181650R0001		0.035	1

Single adapter, wire length 300 mm, 63 A top feed

N	0510740	ZLS166L300	2CCA181608R0001		0.035	1
L1	0510757	ZLS167L300	2CCA181609R0001		0.035	1
L2	0510764	ZLS168L300	2CCA181610R0001		0.035	1
L3	0510771	ZLS169L300	2CCA181611R0001		0.035	1

9

Description/ application	Bbn 762227	Order details		Price 1 piece	Weight 1 piece kg	Pack unit pc.
	EAN	Type code	Order code			
Connection set for Multi-pole adapter (Bag containing 100 items for 50 adapters)	0523382	ZLS174	2CCA180671R0001		-	1

SMISLINE TP plug-in system ILS identification system



Identification system ILS

The individual identification system for ILS inscription panels is a DIN A5 polyester film for inkjet and laser printers with resistance to high temperatures (if laser printers are used, please check whether self-adhesive films with a thickness of 250 microns can be printed). They can also be inscribed by hand using ink, biro, pencil or felt tip.

Description/ application	Bbn 761227	Order details		Price 1 piece	Weight 1 piece kg	Pack unit pc.
	EAN	Type code	Order code			
For Laserprinter	0104826	ZLS418	2CCS400900R0211		–	1 sheet
For Inkjet	0108800	ZLS419	2CCS400900R0291		–	1 sheet

Locking device

Padlock adapter 3 mm – Bag containing 10 items	0104833	SA 1	GJF1101903R0001		0.023	1
Padlock	0104857	SA 2	GJF1101903R0002		0.020	1



SMISLINE TP plug-in system

Busbars 40 A and 100 A

40 A and 100 A busbars / selection table for sockets

Bbn 761227	Order details		Price 1 piece	ZLS908	ZLS906	Module	Length incl. end piece	Busbar length mm	Bbn 761227	Order details		Price 1 piece
EAN	busbar 100 A Type code	Order code							EAN	busbar 40 A Type code	Order code	
006778	ZLS201E6	2CCF800158R0001	–	1	6	148	103	007966	ZLS203E6	2CCF800218R0001		
006983	ZLS201E8	2CCF800159R0001	1	–	8	186	139	008178	ZLS203E8	2CCF800219R0001		
006211	ZLS201E12	2CCF800160R0001	–	2	12	256	211	007409	ZLS203E12	2CCF800220R0001		
006310	ZLS201E14	2CCF800161R0001	1	1	14	292	247	007508	ZLS203E14	2CCF800221R0001		
006334	ZLS201E16	2CCF800162R0001	2	–	16	328	283	007522	ZLS203E16	2CCF800222R0001		
006358	ZLS201E18	2CCF800163R0001	–	3	18	364	319	007546	ZLS203E18	2CCF800223R0001		
006372	ZLS201E20	2CCF800164R0001	1	2	20	401	355	007560	ZLS203E20	2CCF800224R0001		
006396	ZLS201E22	2CCF800165R0001	2	1	22	437	391	007584	ZLS203E22	2CCF800225R0001		
006419	ZLS201E24	2CCF800166R0001	3	–	24	473	427	007607	ZLS203E24	2CCF800226R0001		
006433	ZLS201E26	2CCF800167R0001	1	3	26	509	463	007621	ZLS203E26	2CCF800227R0001		
006457	ZLS201E28	2CCF800168R0001	2	2	28	545	499	007645	ZLS203E28	2CCF800228R0001		
006471	ZLS201E30	2CCF800169R0001	3	1	30	581	535	007669	ZLS203E30	2CCF800229R0001		
006495	ZLS201E32	2CCF800170R0001	4	–	32	617	571	007683	ZLS203E32	2CCF800230R0001		
006518	ZLS201E34	2CCF800171R0001	2	3	34	653	607	007706	ZLS203E34	2CCF800231R0001		
006532	ZLS201E36	2CCF800172R0001	3	2	36	689	643	007720	ZLS203E36	2CCF800232R0001		
006556	ZLS201E38	2CCF800173R0001	4	1	38	725	679	007744	ZLS203E38	2CCF800233R0001		
006570	ZLS201E40	2CCF800174R0001	5	–	40	761	715	007768	ZLS203E40	2CCF800234R0001		
006594	ZLS201E42	2CCF800175R0001	3	3	42	797	751	007782	ZLS203E42	2CCF800235R0001		
006617	ZLS201E44	2CCF800176R0001	4	2	44	833	787	007805	ZLS203E44	2CCF800236R0001		
006631	ZLS201E46	2CCF800177R0001	5	1	46	869	823	007829	ZLS203E46	2CCF800237R0001		
006655	ZLS201E48	2CCF800178R0001	6	–	48	905	859	007843	ZLS203E48	2CCF800238R0001		
006679	ZLS201E50	2CCF800179R0001	4	3	50	941	895	007867	ZLS203E50	2CCF800239R0001		
006693	ZLS201E52	2CCF800180R0001	5	2	52	977	932	007881	ZLS203E52	2CCF800240R0001		
006716	ZLS201E54	2CCF800181R0001	6	1	54	1013	968	007904	ZLS203E54	2CCF800241R0001		
006730	ZLS201E56	2CCF800182R0001	7	–	56	1049	1004	007928	ZLS203E56	2CCF800242R0001		
006754	ZLS201E58	2CCF800183R0001	5	3	58	1085	1040	007942	ZLS203E58	2CCF800243R0001		
006785	ZLS201E60	2CCF800184R0001	6	2	60	1122	1076	007973	ZLS203E60	2CCF800244R0001		
006808	ZLS201E62	2CCF800185R0001	7	1	62	1158	1112	007997	ZLS203E62	2CCF800245R0001		
006822	ZLS201E64	2CCF800186R0001	8	–	64	1194	1148	008017	ZLS203E64	2CCF800246R0001		
006846	ZLS201E66	2CCF800187R0001	6	3	66	1230	1184	008031	ZLS203E66	2CCF800247R0001		
006860	ZLS201E68	2CCF800188R0001	7	2	68	1266	1220	008055	ZLS203E68	2CCF800248R0001		
006884	ZLS201E70	2CCF800189R0001	8	1	70	1302	1256	008079	ZLS203E70	2CCF800249R0001		
006907	ZLS201E72	2CCF800190R0001	9	–	72	1338	1292	008093	ZLS203E72	2CCF800250R0001		
006921	ZLS201E74	2CCF800191R0001	7	3	74	1374	1328	008116	ZLS203E74	2CCF800251R0001		
006945	ZLS201E76	2CCF800192R0001	8	2	76	1410	1364	008130	ZLS203E76	2CCF800252R0001		
006969	ZLS201E78	2CCF800193R0001	9	1	78	1446	1400	008154	ZLS203E78	2CCF800253R0001		
006990	ZLS201E80	2CCF800194R0001	10	–	80	1482	1436	008185	ZLS203E80	2CCF800254R0001		
007010	ZLS201E82	2CCF800195R0001	8	3	82	1518	1472	008208	ZLS203E82	2CCF800255R0001		
007034	ZLS201E84	2CCF800196R0001	9	2	84	1554	1508	008222	ZLS203E84	2CCF800256R0001		
007058	ZLS201E86	2CCF800197R0001	10	1	86	1590	1544	008246	ZLS203E86	2CCF800257R0001		
007072	ZLS201E88	2CCF800198R0001	11	–	88	1626	1580	008260	ZLS203E88	2CCF800258R0001		
007096	ZLS201E90	2CCF800199R0001	9	3	90	1662	1616	008284	ZLS203E90	2CCF800259R0001		
007119	ZLS201E92	2CCF800200R0001	10	2	92	1698	1652	008307	ZLS203E92	2CCF800260R0001		
007133	ZLS201E94	2CCF800201R0001	11	1	94	1734	1688	008321	ZLS203E94	2CCF800261R0001		
007157	ZLS201E96	2CCF800202R0001	12	–	96	1770	1724	008345	ZLS203E96	2CCF800262R0001		
007171	ZLS201E98	2CCF800203R0001	10	3	98	1806	1760	008369	ZLS203E98	2CCF800263R0001		
006006	ZLS201E100	2CCF800204R0001	11	2	100	1843	1796	007195	ZLS203E100	2CCF800264R0001		
006020	ZLS201E102	2CCF800205R0001	12	1	102	1879	1832	007218	ZLS203E102	2CCF800265R0001		
006044	ZLS201E104	2CCF800206R0001	13	–	104	1915	1868	007232	ZLS203E104	2CCF800266R0001		
006068	ZLS201E106	2CCF800207R0001	11	3	106	1951	1904	007256	ZLS203E106	2CCF800267R0001		
006082	ZLS201E108	2CCF800208R0001	12	2	108	1987	1940	007270	ZLS203E108	2CCF800268R0001		

Planning for the incorporation of feeder block and spare places should be taken into account.
 The total lengths given above were calculated taking socket spacings and tolerances into account.
 For this reason, the indicated busbar length is not necessarily a multiple of 18 mm (1 Module).

System pro M compact®

Technical details

MCBs technical details

Definitions according to standards for miniature circuit breakers	10/2
Tripping characteristics	10/4
Limitation of specific let-through energy I _t	10/14
Peak current I _p	10/30
Coordination tables: back-up	10/39
Coordination tables: selectivity	10/62
MCBs internal resistance, power loss and max. permissible earth-fault loop impedance	10/125
Performances at different ambient temperatures, altitudes and frequencies	10/130
Use of MCBs in direct current circuits	10/135
S 200 UDC series DC Applications	10/136
S 200 MUC - S 280 UC series AC/DC Applications	10/138
Use of MCBs in direct current circuits ¹	10/139
Instruction for use of S 200 S	10/140
Particular supply sources and loads	10/142

RCDs technical details

Functions and classification criteria for RCDs	10/147
Coordination tables: F 200 RCCBs	10/150
Coordination tables: residual current protection selectivity	10/153
Power loss, derating and performance in altitude	10/156
Emergency stop using DDA 200 AE series	10/158
Unwanted tripping - AP-R solution (high immunity)	10/159
Unwanted tripping - F2C-ARH solution	10/161
Type B RCDs	10/162
Use of 4P RCCBs in 3-phase system without neutral pole	10/168
Operating voltage of test button	10/169
RD2 residual current relays	10/173
RD3 residual current relays	10/174
ELR front panel residual current relays	10/178
Toroidal transformers	10/179

Accessories for MCBs and RCDs

Busbars	10/181
---------	--------

Protection and safety technical details

OVR Surge Protective Devices	10/186
E 90 fuse-holders	10/194
E 930 fuse-holders	10/197
E 9F fuses	10/199
EPD 24-TB-101	10/208
SQZ3 phase and sequence relays	10/212
RH/RL maximum and minimum current/voltage relays	10/213
E 236 undervoltage monitoring relays	10/214
Insulation monitoring devices	10/215
Monitor for medical locations	10/219
TI insulating transformers for medical locations	10/220
QSO switchboard for medical locations	10/221
Insulation monitoring devices	10/225
QIT switchboards for data center protection and supply	10/232

Command and signalling technical details

E 200 switches	10/233
E 463 switches	10/234
E 210 switches	10/235
ESB installation contactors	10/236
EN installation contactors	10/237
E 259 installation relays	10/238
E 250 latching relays	10/240
E 260 latching relays	10/247
STD dimmers	10/248
Modular transformers	10/249
Control, isolating and safety transformers	10/250
Modular sockets	10/258

Control and automation technical details

AT and ATP electro-mechanical time switches	10/262
D Line digital time switches	10/265
E 232 staircase lighting time-delay switches	10/278
E 234 CT-D electronic timers	10/280
T1, T1 PLUS, T1 POLE, TWA-1 and TWA-2 twilight switches	10/284
THS modular thermostats	10/293
ATT GSM modules	10/296
RAL overload relays	10/299
LSS1/2 load shedding switch	10/302
MeMo USB modular DIN rail device	10/305

Energy efficiency technical details

Multimeters and network analyser	10/307
DMTME multimeters	10/310
ANR Network analyser	10/313
M2M Network analyser	10/314
Digital instruments	10/315
TMD temperature control units	10/317
Measurement current transformers with through primary	10/318

MCBs technical details

Definitions according to standards for miniature circuit breakers

Rated insulation voltage (Ui) according IEC/EN 60664-1:

Root mean square (R.M.S.) withstand voltage value assigned by the manufacturer to the equipment or to a part of it, characterizing the specified (long-term) withstand capability of its insulation.

NOTE:

The rated insulation voltage is not necessarily equal to the rated voltage of the equipment which is primarily related to functional performance.

IEC/EN 60898-1

Miniature Circuit Breakers according IEC/EN 60898-1 are intended for the protection against overcurrents of wiring installations of

buildings and similar applications; they are designed for use by uninstructed people and for not being maintained.

This part of IEC/EN 60898 applies for a.c. air-break circuit-breakers for operation at 50 Hz or 60 Hz, having a rated voltage not

exceeding 440 V (between phases), a rated current not exceeding 125 A and a rated short-circuit capacity not exceeding 25.000 A.

As far as possible, it is in line with the requirements contained in IEC/EN 60947-2.

Rated short-circuit capacity (Icn)

The rated short-circuit capacity of a circuit-breaker is the value of the ultimate short-circuit breaking capacity assigned to that circuit-breaker by the manufacturer.

The sequence of operations shall be: O – t – CO.*

Service short-circuit capacity (Ics)

A circuit-breaker having a given rated short-circuit capacity has a corresponding fixed service short-circuit capacity (Ics). This is therefore generally not indicated.

Rated operational voltage (Un)

The rated voltage of a circuit-breaker is the value of voltage, assigned by the manufacturer, to which its performance (particularly the short-circuit performance) is referred.

The same circuit-breaker may be assigned a number of rated voltages and associated rated short-circuit capacities.

2The voltage which appears across the terminals of a pole of a circuit-breaker after the breaking of the current.

The value of the power frequency recovery voltage shall be equal to 110 % of the rated voltage of the circuit-breaker under test.

IEC/EN 60947-2

This part of the IEC/EN 60947 applies to circuit-breakers, the main contacts of which are intended to be connected to circuits, the rated voltage of which does not exceed 1.000 V a.c. or 1.500 V d.c..

It applies whatever the rated currents, the method of construction or the proposed applications of the circuit-breakers may be.

The circuit-breakers are designed for use by instructed people.

Rated ultimate short-circuit breaking capacity Icu

The rated ultimate short-circuit breaking capacity of a circuit-breaker is the value of ultimate short-circuit breaking capacity assigned to that circuit-breaker by the manufacturer for the corresponding rated operational voltage. It is expressed as the value of the prospective breaking current, in kA (r.m.s. value of the a.c. component in the case of a.c.).

The sequence of operations shall be: O – t – CO.*

Rated service short-circuit breaking capacity Ics

The rated service short-circuit breaking capacity of a circuit-breaker is the value of service short-circuit breaking capacity assigned to that circuit-breaker by the manufacturer for the corresponding rated operational voltage. It is expressed as a value of prospective breaking current, in kA, corresponding to one of the specified percentages of the rated ultimate short-circuit breaking capacity and rounded up to the nearest whole number. It may be expressed as a % of Icu (for example Ics = 25 % Icu).

The sequence of operations shall be: O – t – CO – t – CO.*

* The following symbols are used for defining the sequence of operations:

O represents an opening operation.

CO represents a closing operation followed by an automatic opening.

t represents the time interval between two short-circuit operations.

Rated operational voltage (Ue)

The rated operational voltage of an equipment is a value of voltage which, combined with a rated operational current, determines the application of the equipment and to which the relevant tests and the utilization categories are referred. For single-pole equipment it is generally stated as the voltage across the pole. For multi pole equipment it is generally stated

as the voltage between phases.

An equipment may be assigned a number of combinations of rated operational voltage and associated making and breaking capacities for different duties and utilization categories.

Max. power frequency recovery voltage (U_{max})

Voltage which appears across the terminals of a pole of a switching device after the breaking of the current.

For all breaking capacities and short-circuit breaking capacity tests, the value of the power-frequency recovery voltage shall be 105 % of the value of the rated operational voltage. This value shall be within the specified tolerance (voltage 0 / + 5%).

NOTE:

The value of 1.05 times the rated operational voltage for the power frequency recovery voltage, together with the test voltage tolerance resulting in a maximum voltage of 1.1 times the rated operational voltage, is deemed to cover the effects of variations of the system voltage under normal service conditions.

UL 489

The requirements of this standard cover molded-case circuit breakers, circuit breaker and ground-fault circuit-interrupters, fused circuit breakers, and accessory high-fault protectors.

These circuit breakers are specifically intended to provide service entrance, feeder, and branch circuit protection in accordance with the National Installation Codes in Annex B, Ref. No.1.

This standard also covers instantaneous-trip circuit breakers (circuit interrupters) specifically intended for use as part of a combination motor controller in accordance with the National Installation Codes in Annex B, Ref. No. 1.

UL489B

These requirements cover molded-case circuit breakers, molded-case switches, and circuit-breaker enclosures rated up to 1000 V dc, intended for use with photovoltaic (PV) systems and Article 690 of the National Electrical Code, ANSI/NFPA-70. These requirements are intended to be used in conjunction with the requirements in the Standard for Molded-Case Circuit Breakers, Molded-Case Switches and Circuit-Breaker Enclosures, UL 489.

UL 1077

These requirements apply to supplementary protectors intended for use as overcurrent, or over- or under-voltage protection within an appliance or other electrical equipment where branch circuit overcurrent protection is already provided, or is not required.

Compliance with this standard is acceptable for use as a component of an end product.

MCBs technical details

Tripping characteristics

Tripping characteristics S 200 / S 200 M / S 200 P / S 200 S / S 200 MUC / SN 201 L / SN 201 / SN 201 M

Acc. to	Tripping characteristic and rated current		Thermal release ②			Electromagnetic release ①		
			Current: conventional non-tripping current	conventional tripping current	Tripping time	Currents: hold current surges	trip at least at	Tripping time
IEC/EN 60898-1	B	6 to 63 A	1.13 · I _n		> 1 h	3 · I _n		> 0.1 s
				1.45 · I _n	< 1 h		5 · I _n	< 0.1 s
	C	0.5 to 63 A	1.13 · I _n		> 1 h	5 · I _n		> 0.1 s
				1.45 · I _n	< 1 h		10 · I _n	< 0.1 s
	D	0.5 to 63 A	1.13 · I _n		> 1 h	10 · I _n		> 0.1 s
				1.45 · I _n	< 1 h		20 · I _n	< 0.1 s
IEC/EN 60947-2	K	0.2 to 63 A	1.05 · I _n		> 1 h	10 · I _n		> 0.2 s
				1.2 · I _n	< 1 h ③		14 · I _n	< 0.2 s
				1.5 · I _n	< 2 min. ③			
				6.0 · I _n	> 2 s (T1)			
	Z	0.5 to 63 A	1.05 · I _n		> 1 h	2 · I _n		> 0.2 s
				1.2 · I _n	< 1 h ③		3 · I _n	< 0.2 s

① The indicated electromagnetic tripping values apply to a frequency range of 16 2/3 ... 60 Hz. For different network frequencies or direct current the values change according to the multiplier in the table below (see also page 11/75)

② The thermal releases are calibrated to a nominal reference ambient temperature; for Z and K, the value is 20 °C, for B and C = 30 °C. In the case of higher ambient temperatures, the current values fall by ca. 6 % for each 10 K temperature rise.

③ As from operating temperature (after I₁ > 1 h or, as applicable, 2 h).

	AC			DC
	100 Hz	200 Hz	400 Hz	
Multiplier	1.1	1.2	1.5	1.5

The thermal tripping performance is independent from the network frequency

Tripping behavior S 700

Tripping characteristic	Rated current	Delayed thermal release			Short-time delayed selective tripping device		
		Conventional non-tripping current	Conventional tripping current	Tripping time	Delayed tripping	Short-time delayed tripping	Tripping time
		I_{nt}	I_t	t	I_{tr}	I_{tk}	t
E _{selective}	10 to 100 A	1.05 x In		≥ 2 h	5 x In		0.05 s < t < 5 s (In ≤ 32 A) 0.05 s < t < 10 s (In > 32 A)
			1.2 x In	< 2 h		6.25 x In	0.01 s < t < 0.3 s
K _{selective}	16 to 50 A	1.05 x In		≥ 2 h	10 x In		0.05 s < t < 5 s (In ≤ 32 A) 0.05 s < t < 10 s (In > 32 A)
			1.2 x In	< 2 h		14 x In	0.01 s < t < 0.3 s
	63 to 100 A	1.05 x In		≥ 2 h	8 x In		0.05 s < t < 10 s
			1.2 x In	< 2 h		12 x In	0.01 s < t < 0.3 s

Tripping behavior S 750 DR

Tripping characteristic	Reference ambient temperature $T_{ref}^{1)}$	Delayed overload tripping			Short-time delayed selective tripping device		
		Conventional non-tripping current	Conventional tripping current	Tripping time	Delayed tripping current	Short-time delayed tripping current	Tripping time
		I_{nt}	I_t	t	I_{tr}	I_{tk}	t
E _{selective}	30 °C	1.05 x In		≥ 2 h	5 x In		0.05 s < t < 5 s (In ≤ 32 A) 0.05 s < t < 10 s (In > 32 A)
			1.2 x In	< 2 h		6.25 x In	0.01 s < t < 0.3 s
K _{selective}	20 °C	1.05 x In		≥ 2 h	8 x In		0.05 s < t < 10 s
			1.2 x In	< 2 h		12 x In	0.01 s < t < 0.3 s

¹⁾ Reference ambient temperature 30 °C (in the case of higher ambient temperatures, the current values are reduced by ca. 5 % per each 10 K)

MCBs technical details

Tripping characteristics

Tripping characteristic S800

Acc. to	Tripping characteristic and rated current		Thermal release ②			Electromagnetic release ①			
			Current		Tripping time	Current		Tripping time	
			conventional non-tripping current	conventional tripping current		hold current surges	trip at least at		
IEC/EN 60898-1	B	10 to 80 A	1.13 · In	1.45 · In	> 1 h	3 · In	5 · In	> 0.1 s	
	C	10 to 80 A	1.13 · In	1.45 · In	< 1 h	5 · In	10 · In	> 0.1 s	
	D	10 to 80 A	1.13 · In	1.45 · In	< 1 h	10 · In	20 · In	> 0.1 s	
IEC/EN 60947-2	B	6 to 125 A	1.05 · In	1.3 · In	> 1 h	3.2 · In	4.8 · In	> 0.1 s	
	C	6 to 125 A	1.05 · In	1.3 · In	< 1 h	6.4 · In	9.6 · In	> 0.1 s	
	D	6 to 125 A	1.05 · In	1.3 · In	< 1 h	10.4 · In	15.6 · In	> 0.1 s	
	K	6 to 125 A	1.05 · In	1.2 · In	> 1 h	10.4 · In	15.6 · In	> 0.1 s	
	KM	20 to 80 A				10.4 · In	15.6 · In	> 0.1 s	
	UCB (DC only)	10 to 125 A	1.05 · In	1.3 · In	> 1 h	4.8 · In	7.2 · In	> 0.1 s	
	UCK (DC only)	10 to 125 A	1.05 · In	1.2 · In	> 1 h	8.8 · In	13.2 · In	> 0.1 s	
	PV-S (DC only)	10 to 125 A	1.05 · In	1.3 · In	> 1 h	4.8 · In	6 · In	> 0.1 s	
	UL489	Z	10 to 100 A	1 · In	1.35 · In	> 1 h	3.2 · In	4.8 · In	> 0.1 s
		K	10 to 100 A	1 · In	1.35 · In	< 1 h	6.4 · In	9.6 · In	> 0.1 s
UCZ (DC only)		10 to 80 A	1 · In	1.35 · In	< 1 h	8.8 · In	13.2 · In	> 0.1 s	
UL489B	PV-S (DC only)	5 A	1.13 · In	1.3 · In	> 1 h	4.8 · In	6 · In	> 0.1 s	

① The indicated electromagnetic tripping values apply to a frequency of 50/60 Hz.

② The thermal release are calibrated to a nominal reference ambient temperature; for B, C, D, UCB and PVS it is 30 °C, for K, UCK it is 20 °C for Z, K and UCZ it is 25 °C, for PVS acc. to UL489B it is 50 °C.

Tripping characteristic S500

Acc. to	Tripping characteristic and rated current		Thermal release ②			Electromagnetic release ①			
			Current		Tripping time	Current			
			conventional non-tripping current	conventional tripping current		Rated current of device	hold current surges	trip at least at	Tripping time
IEC/EN 60947-2	K	0.1 to 45 A	1.05 · I _n		> 1 h	< 0.21 A	8 · I _n		> 0.1 s
				1.2 · I _n	< 1 h			10 · I _n	< 0.1 s
						< 0.42 A	10 · I _n		> 0.1 s
								12 · I _n	< 0.1 s
						> 0.38 A	12 · I _n		> 0.1 s
								14 · I _n	< 0.1 s
	UC-K (DC only)	0.1 to 45 A	1.05 · I _n		> 1 h	< 0.21 A	8 · I _n		> 0.1 s
				1.2 · I _n	< 1 h			10 · I _n	< 0.1 s
						< 0.42 A	10 · I _n		> 0.1 s
								12 · I _n	< 0.1 s
						> 0.38 A	12 · I _n		> 0.1 s
								14 · I _n	< 0.1 s
HV-K	1 to 45 A	1.05 · I _n		> 1 h	-	12 · I _n		> 0.1 s	
			1.2 · I _n	< 1 h			14 · I _n	< 0.1 s	

① The indicated electromagnetic tripping values apply to a frequency of 50/60 Hz.

② The thermal release are calibrated to a nominal reference ambient temperature for K, HV-K, UC-K it is 20 °C.

MCBs technical details

Tripping characteristics

Characteristic B
IEC-EN60898

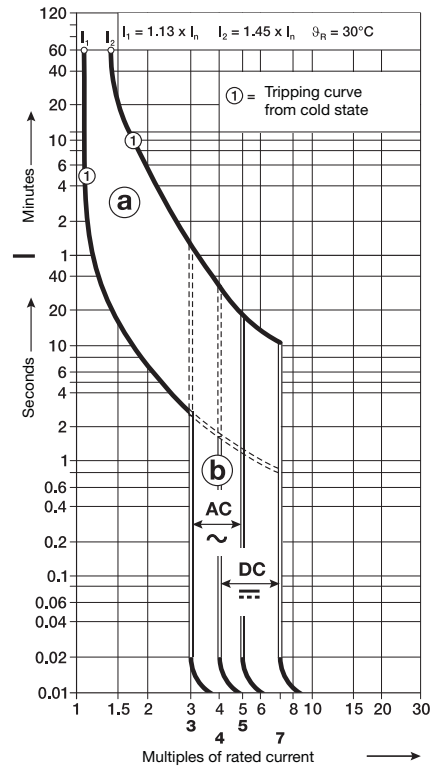

Characteristic C
IEC-EN60898

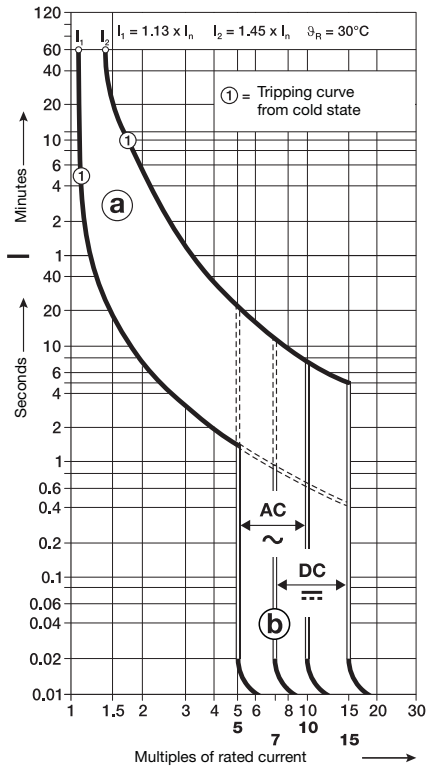

Characteristic D
IEC-EN60898

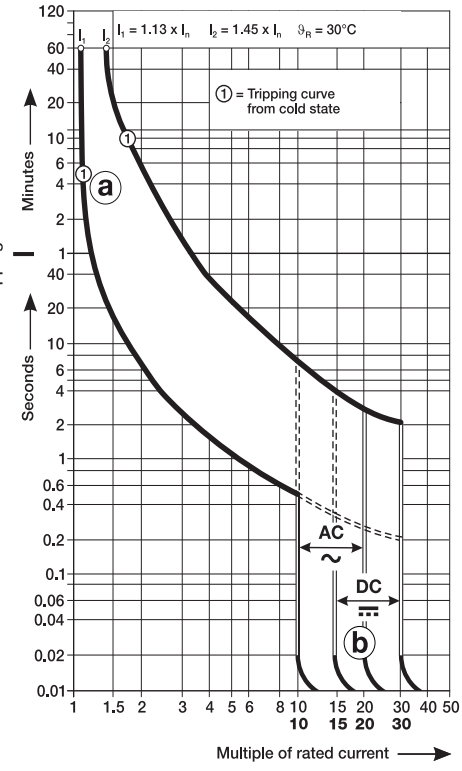

10 Characteristic K
IEC-EN60947-2

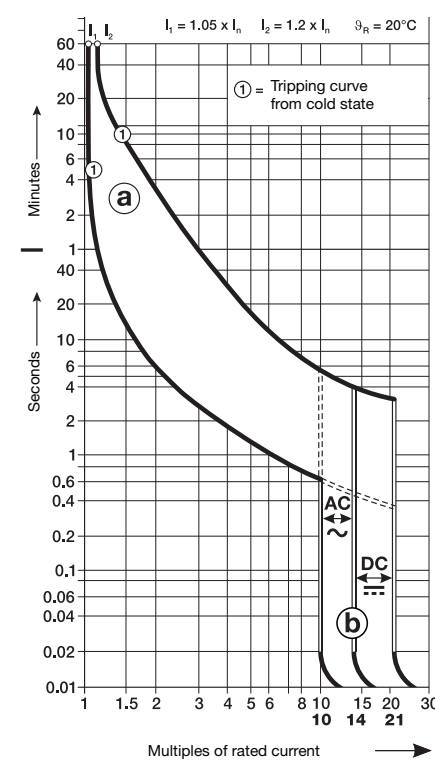

Characteristic Z
IEC-EN60947-2

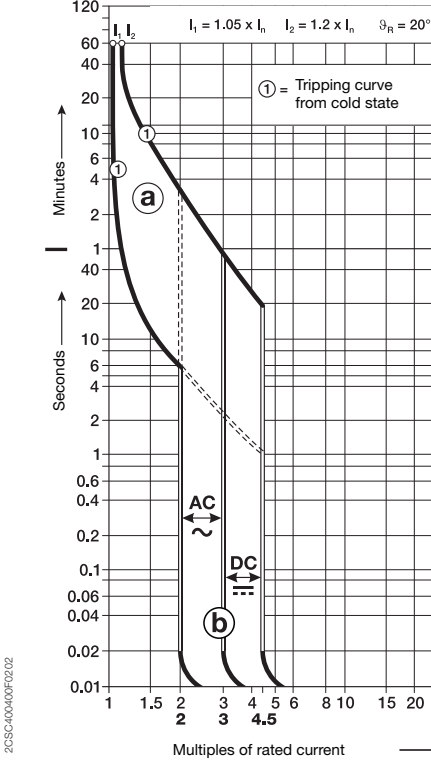

- ① thermal trip
- ② electromagnetic trip

Characteristic B

S 200 S

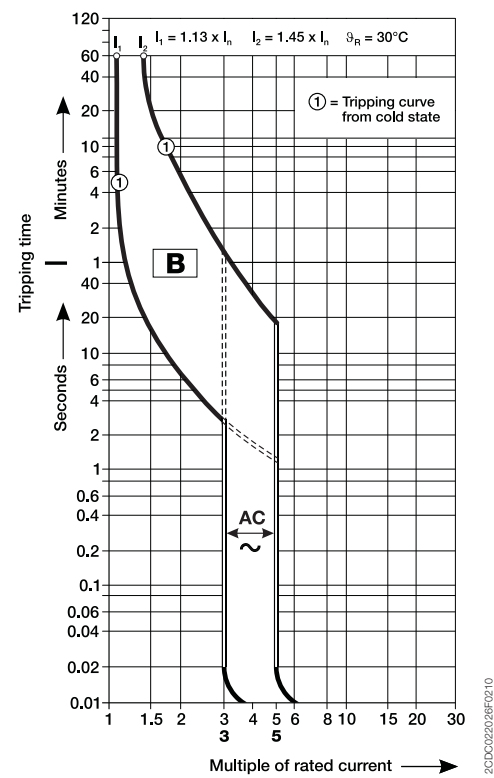

Characteristic C

S 200 S

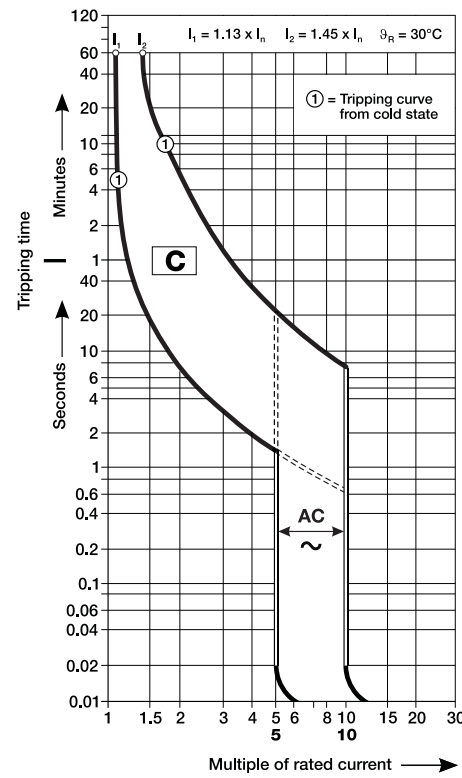

MCBs technical details

Tripping characteristics

Characteristic C
S 200 U/S 200 UP

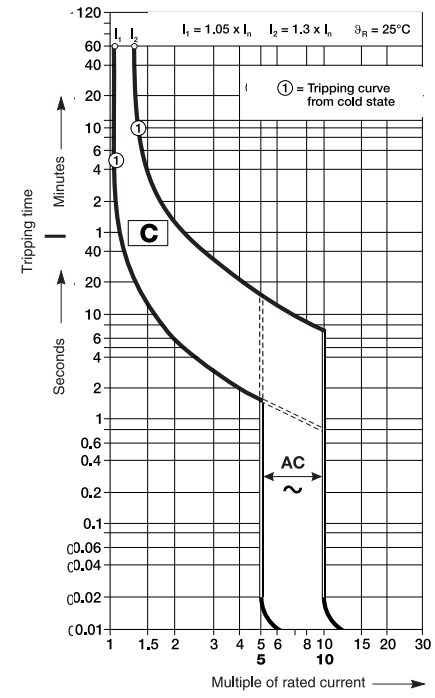

Characteristic K
S 200 U/S 200 UP/SU 200 PR

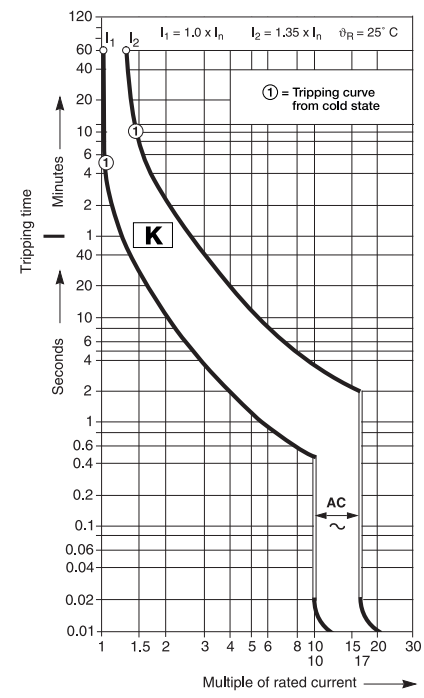

Characteristic Z
S 200 U/S 200 UP

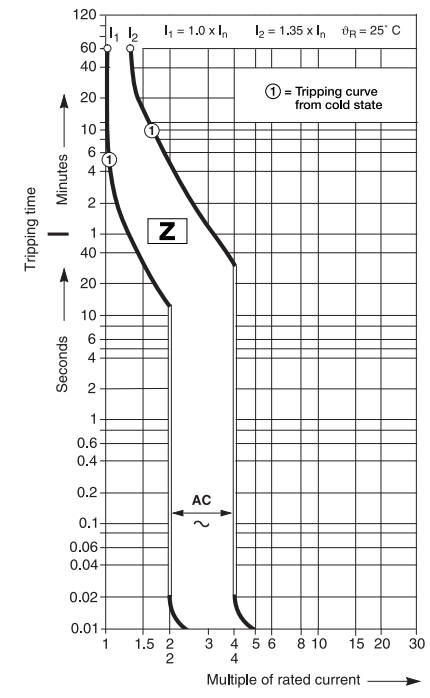

Characteristic K
S 200 UDC

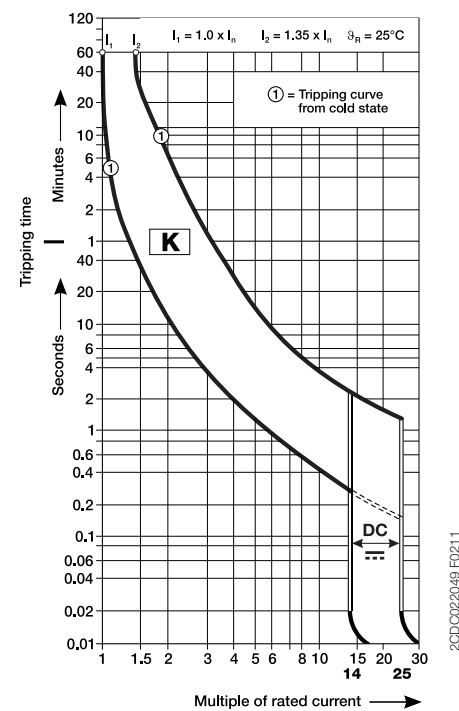

2CDD022049 F0211

Characteristic Z
S 200 UDC

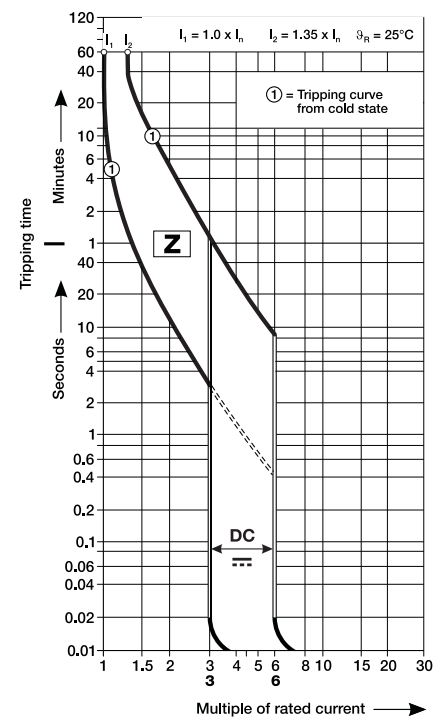

2CDD022051 F0211

① thermal trip
② electromagnetic trip

MCBs technical details

Tripping characteristics

Characteristic E_{selective}
S 700 - 10 ... 100 A

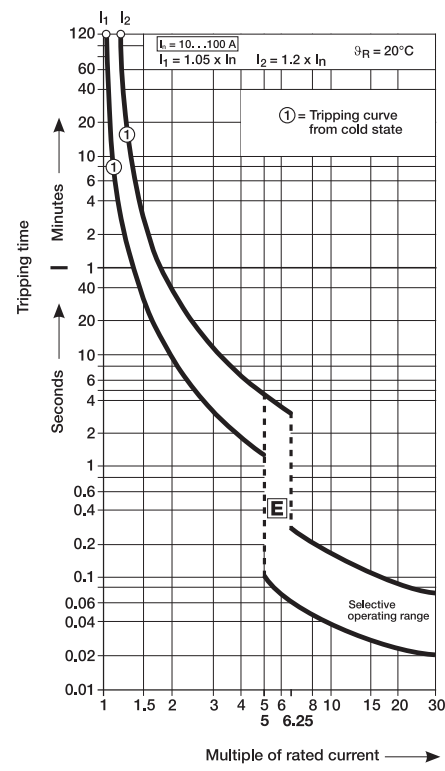

Characteristic K_{selective}
S 700 - 16 ... 50 A

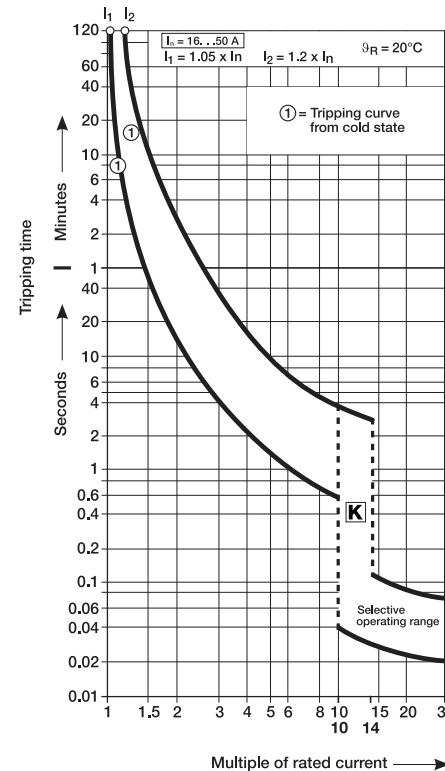

Characteristic K_{selective}
S 700 - 63 ... 100 A

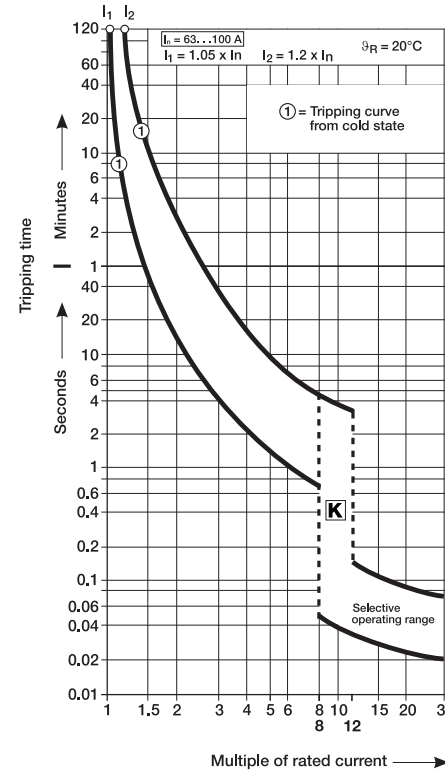

10

Characteristic E_{selective}
S 750 DR - 16 ... 25 A

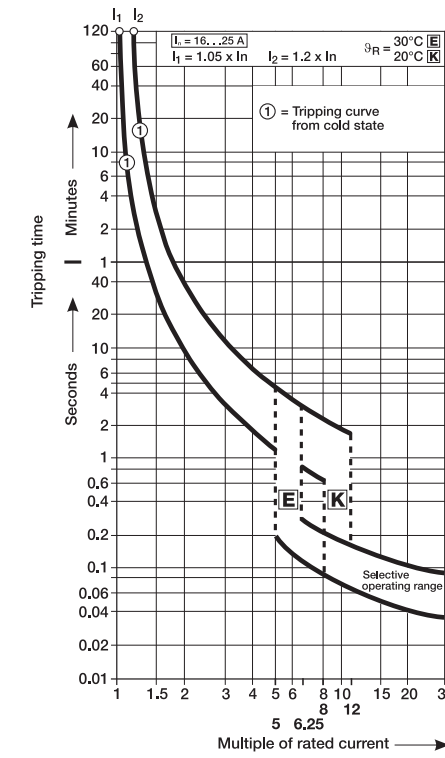

Characteristic K_{selective}
S 750 DR - 35 ... 63 A

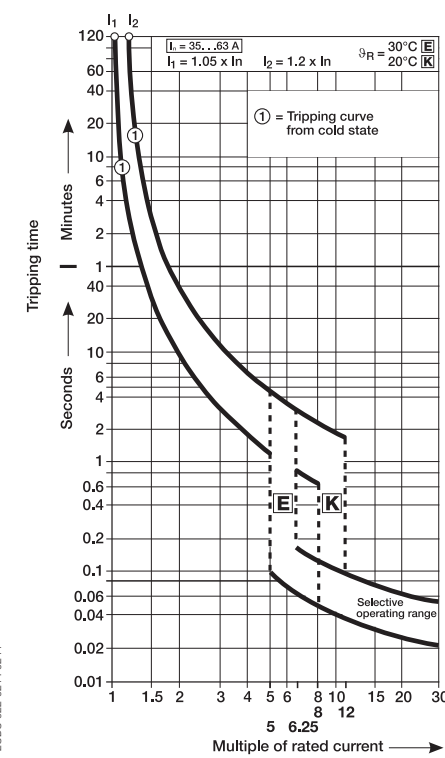

- ① thermal trip
- ② electromagnetic trip

Impulse Tripping - Miniature Circuit Breaker

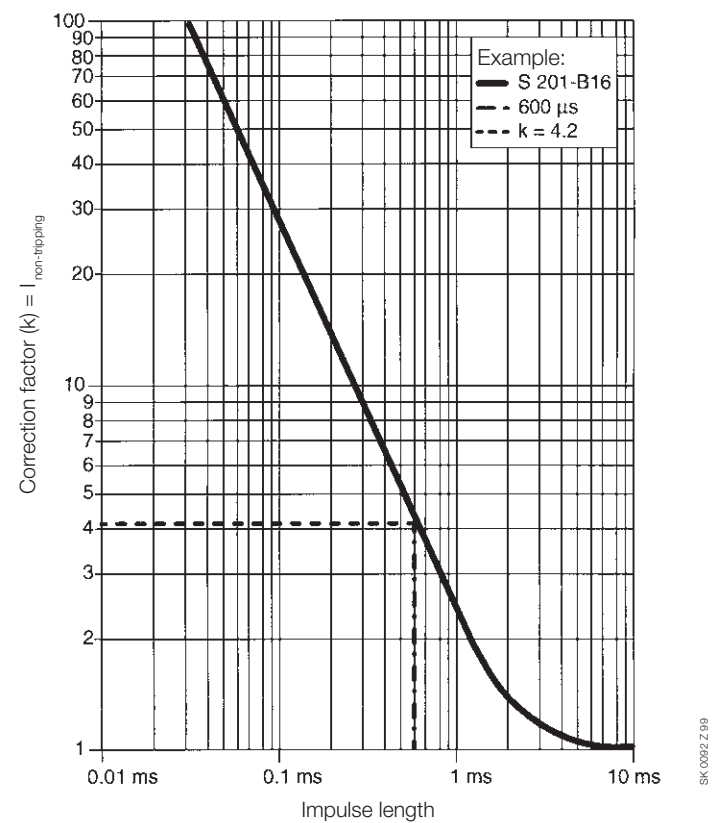

10

Example: Non-tripping current (Electromagnetic release)

S 201-B16

$$I_{\text{non-tripping}} = k \times \text{non-tripping current} \quad \text{B-Characteristic} = 3 \times I_n$$

$$I_{\text{non-tripping}} = 4,2 \times 3 \times 16 \quad \text{C-Characteristic} = 5 \times I_n$$

$$I_{\text{non-tripping}} = 201,6 \text{ A} \quad \text{D-Characteristic} = 10 \times I_n$$

$$\text{K-Characteristic} = 10 \times I_n$$

$$\text{Z-Characteristic} = 2 \times I_n$$

The S 201-B16 does not trip at an impulse of 600 μs at a current up to 201,6 A.

MCBs technical details

Limitation of specific let-through energy I^2t

Limitation of specific let-through energy

Tripping of an installation circuit by circuit-breaker when there is a short-circuit requires a certain amount of time depending on the characteristics of the circuit-breaker and the entity of the short-circuit current. During this period of time, some or all of the short-circuit current flows into the installation; the parameter I^2t defines the "specific let-through energy", ie. the specific energy that the breaker allows through when there is a short-circuit current I_{cc} during the tripping time t . In this way, we can determine the capacity of a circuit-breaker to limit, ie. break high currents up to the rated breaking power of the device, by reducing the peak value of the above-mentioned currents to a value which is considerably lower than the estimated current.

This can be achieved using mechanisms which open very rapidly and have the following advantages:

- they limit the thermal and dynamic effects both on the circuit-breaker and on the protected circuit;
- they reduce the dimensions of the current-limiting circuit-breaker without reducing breaking capacity;
- they considerably reduce ionized gases and sparklers emitted during the short-circuit and therefore they avoid the danger of ignition and fires.

I_{rms} = perspective symmetrical short-circuit current

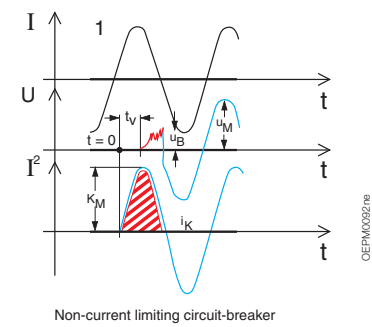

Oscillogram of short-circuit breaks on two circuit-breakers:

- 1 = traditional non-current limiting circuit-breaker
- 2 = current limiting circuit-breaker
- u_B = arc voltage (red)
- u_M = rest voltage (blue)

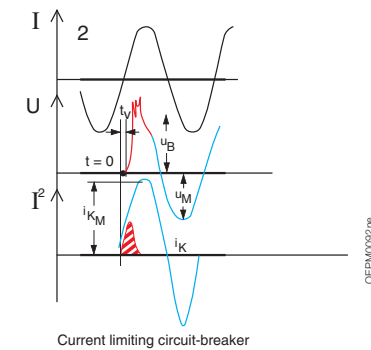

Short-circuit current

- red = effective short-circuit current squared
- blue = estimated short-circuit current squared (shunted circuit-breaker)
- i_{K_M} = maximum values of symmetrical component of short-circuit current squared
- shaded in = specific let-through energy in two cases

Limiting of let-through energy

Main selective circuit breakers (SMCB) like S 700 and S 750 DR support downstream mcbs in clearing short-circuit currents. They additionally reduce let-through energies without tripping. This increases the operational availability of the electrical supply and reduces drawbacks to the feeding grid and the installed equipment.

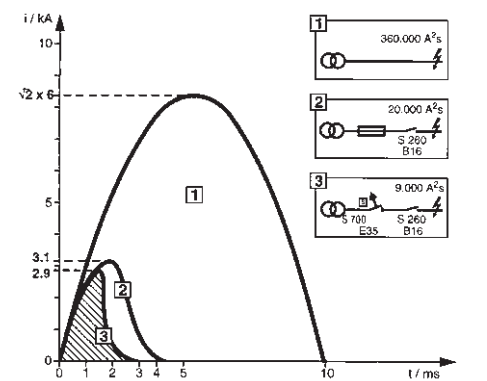

Max. withstanding specific let-through energy of cables

Section mm ²	PVC	EPR	HEPR
50	33,062,500	39,062,500	51,122,500
35	16,200,625	19,140,625	25,050,025
25	8,265,625	9,765,625	12,780,625
16	3,385,600	4,000,000	5,234,944
10	1,322,500	1,562,500	2,044,900
6	476,100	562,500	736,164
4	211,600	250,000	327,184
2.5	82,656	97,656	127,806
1.5	29,756	35,156	46,010

The selection of the cables depends both from the breakers' specific let-through energy and from carrying capacity and voltage drop of the line.

Data of the previous table are referred to the following cables:

PVC	EPR	HEPR
FM9	H07RN-F	N07G9-K
FM90Z1		FTG100M1
N07V-K		RG70R
FROR		FG70M1
		FG70R

Designation

Designation	Designation	Designation
Cable's reference to the standards	harmonized	H
	national cable recognized by CENELC	A
Rated voltage U₀/U	100/100 ≤ U ₀ /U < 300/300	01
	300/300 V	03
	300/500 V	05
	450/750 V	07
	750/1000 V	1
Insulating materials and non-metallic sheath	ethylene-vinylacetate	G
	mineral	M
	polyvinyl chloride	V
Conductor's shape	flexible conductor of a cable for fixed installation	K

Some cables on the market are identified with different names according with the designation UNEL 35011.

MCBs technical details

Limitation of specific let-through energy I^2t

I^2t diagrams - Specific let-through energy value I^2t

The I^2t curves give the values of the specific let-through energy

expressed in A^2s (A=amps; s=seconds) in relation to the perspective short-circuit current (I_{rms}) in kA.

S 200-S 200 M-S 200 P, characteristics B and C

DS 200-DS 200 M, characteristics B and C

230/400 V let-through energy

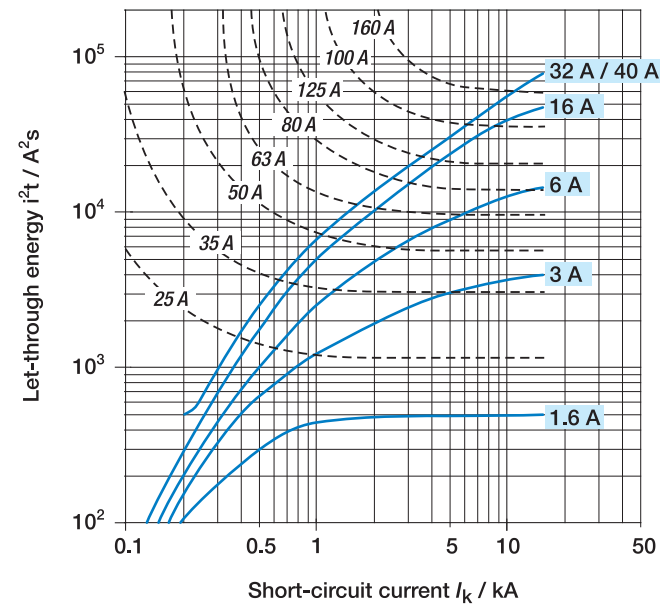
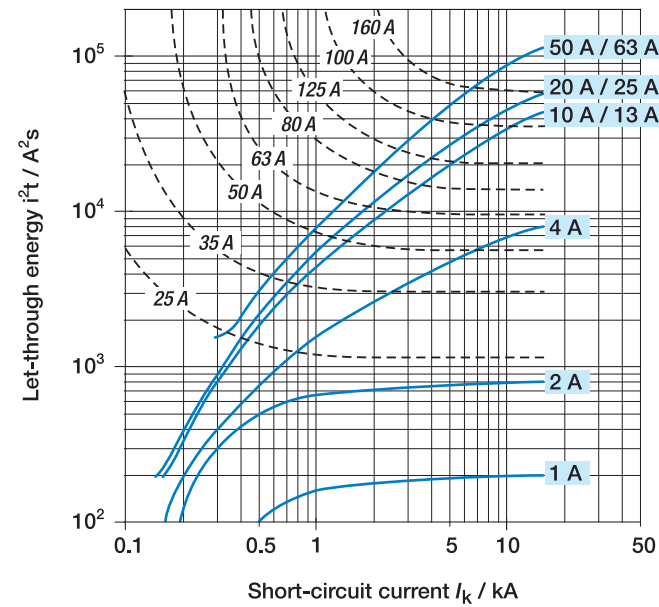

10

S 200-S 200 M-S 200 P, characteristics D-K

230/400 V let-through energy

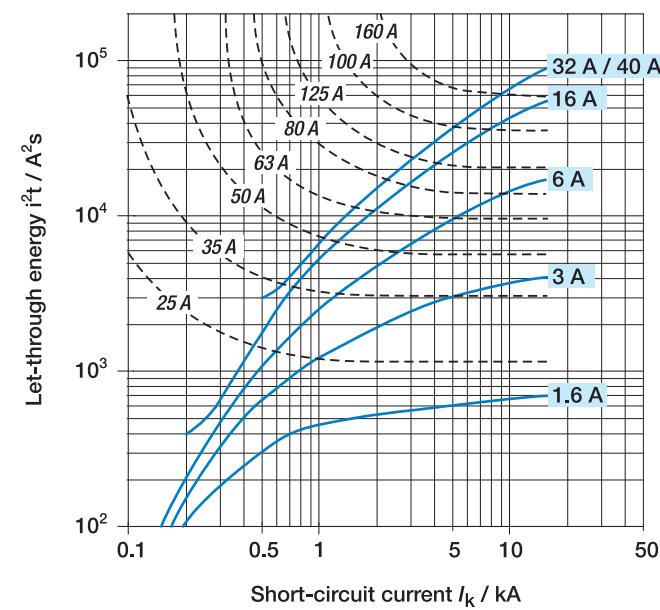
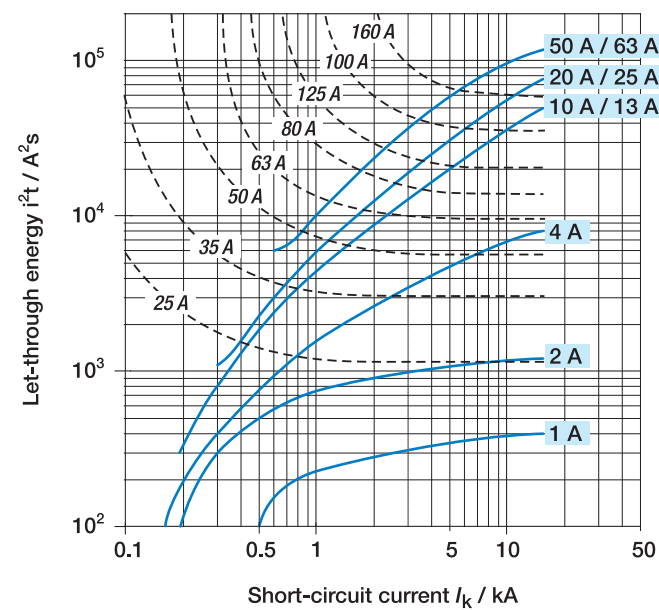

For further information about the selection of the cable, please look at the table in page 10/3

S 200-S 200 M-S 200 P, characteristic Z
230/400 V let-through energy

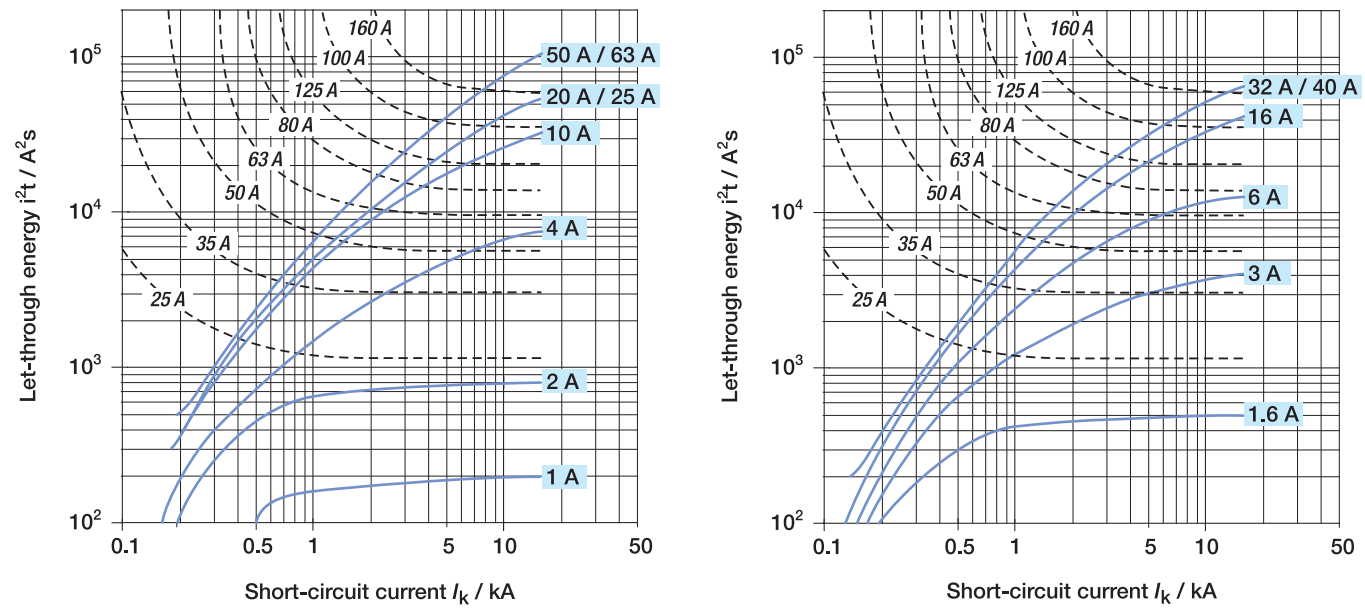

SN201 L-SN201-SN201 M, characteristics B
230 V let-through energy

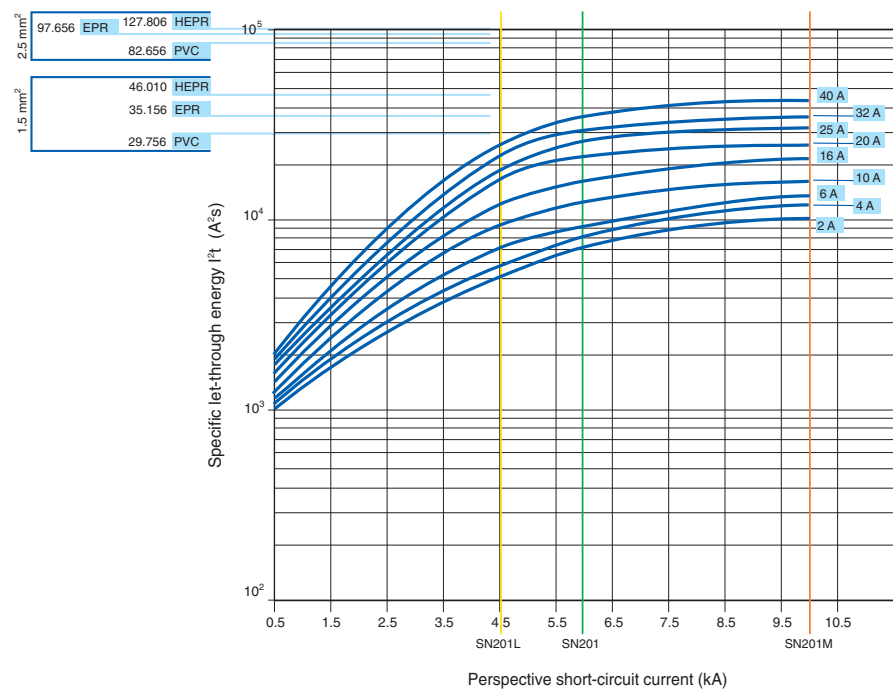

For further information about the selection of the cable, please look at the table in page 10/3

MCBs technical details

Limitation of specific let-through energy I^2t

SN201 L-SN201-SN201 M, characteristics C
230 V let-through energy

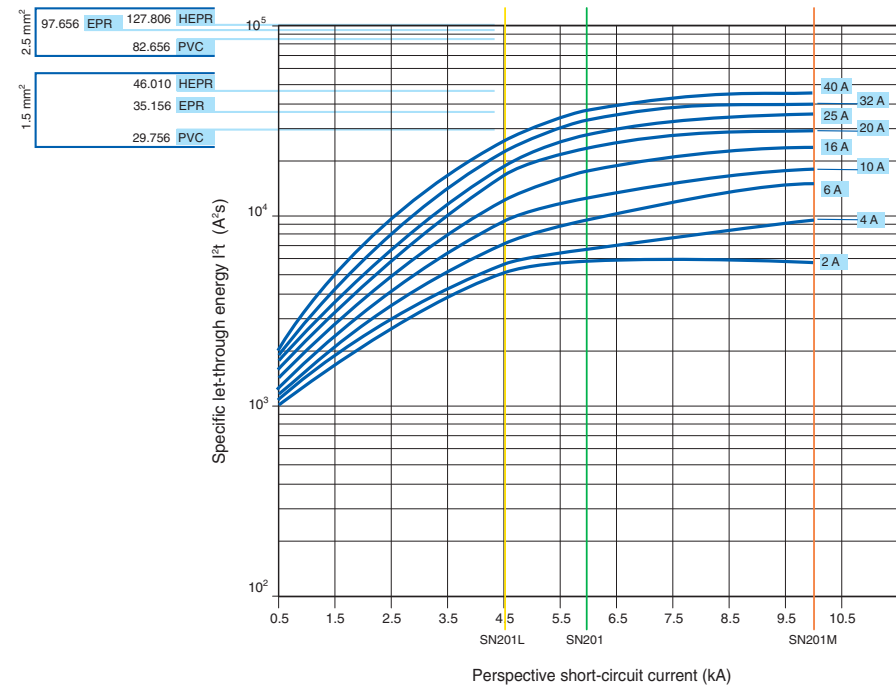

2CSC400407F0202

10 SN201, characteristics D 230 V let-through energy

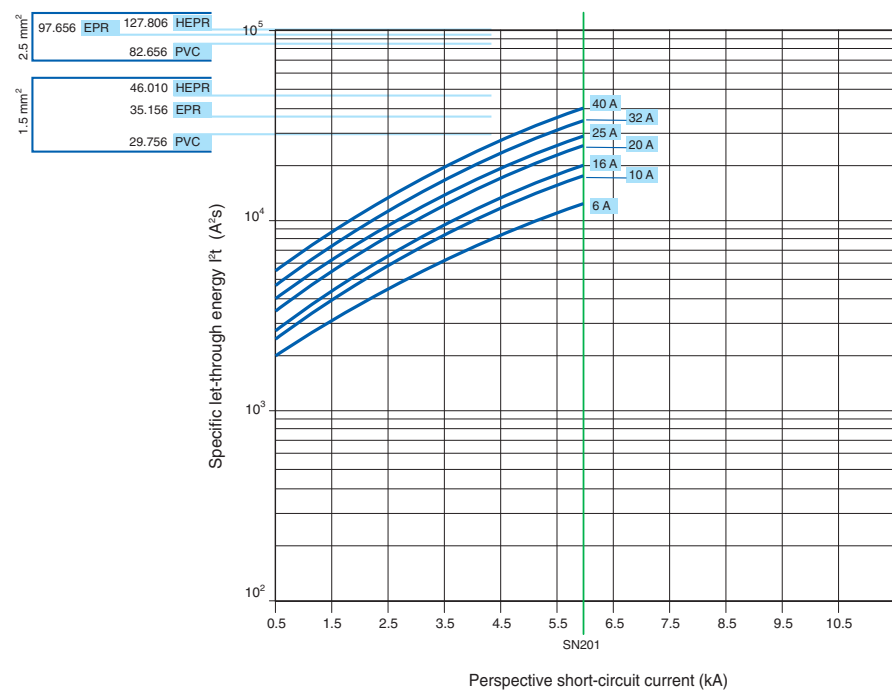

2CSC400407F0202

For further information about the selection of the cable, please look at the table in page 10/3

S 280 80-100 A, characteristic B

230/400 V let-through energy

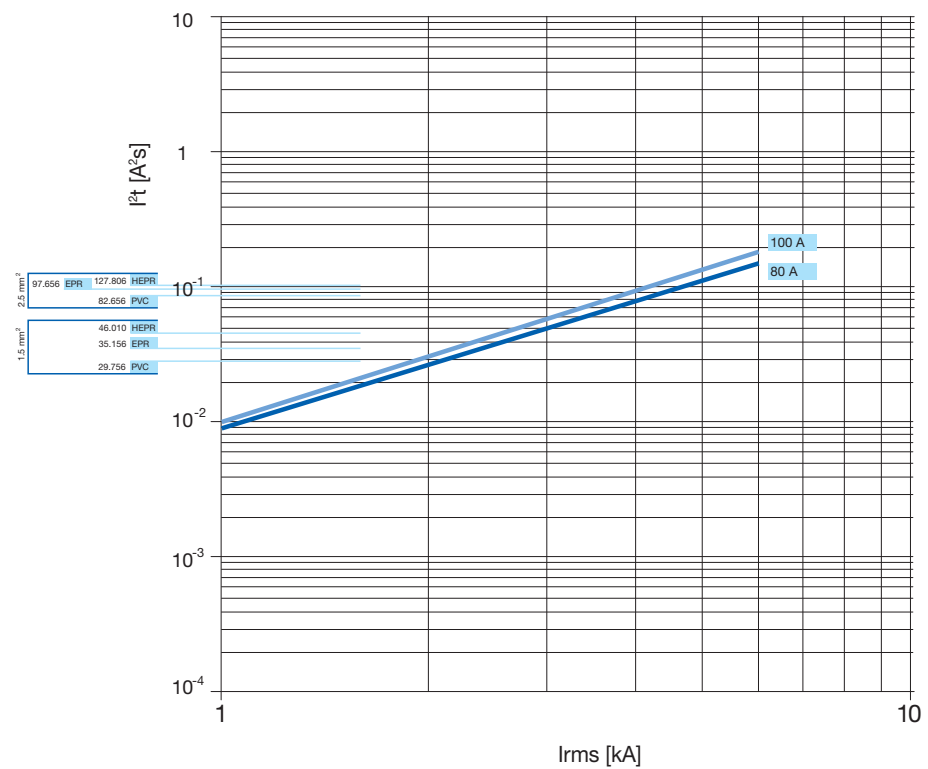

2CSC40002D0211

S 280 80-100 A, characteristic C

230/400 V let-through energy

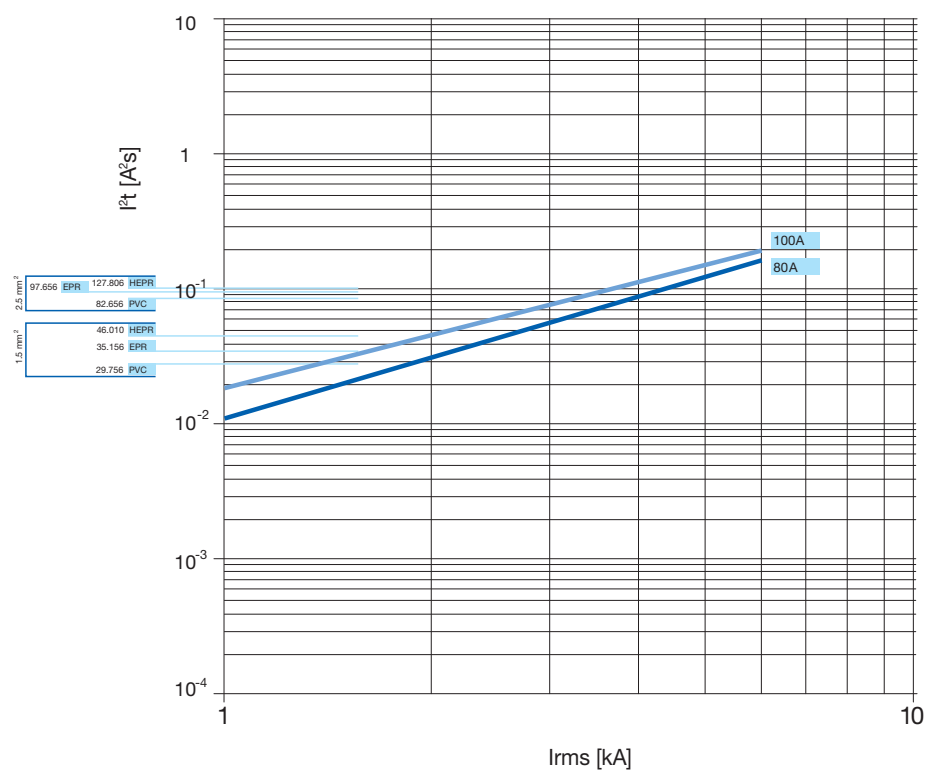

2CSC40002D0211

For further information about the selection of the cable, please look at the table in page 10/3

MCBs technical details

Limitation of specific let-through energy I^2t

S 700 characteristic $E_{selective}$
let-through energy

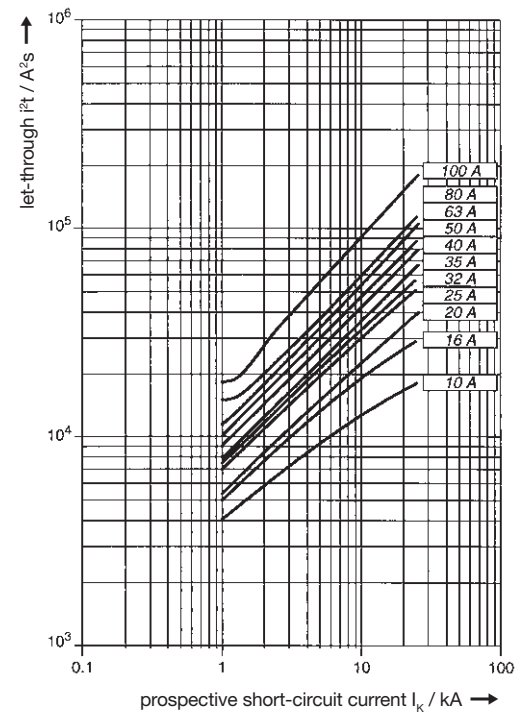

2CDC 022 166 F0103

S 700 characteristic $E_{selective}$
let-through peak current (I_{peak})

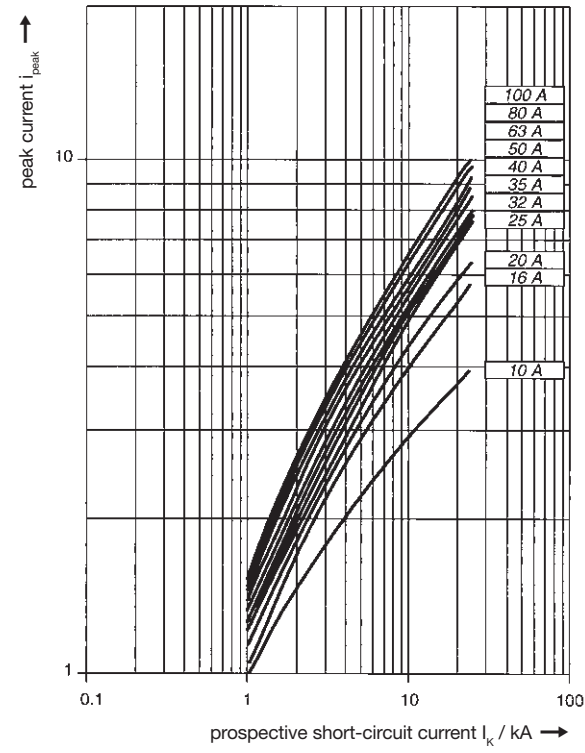

2CDC 022 164 F0103

10 S 700 characteristic $K_{selective}$
let-through energy

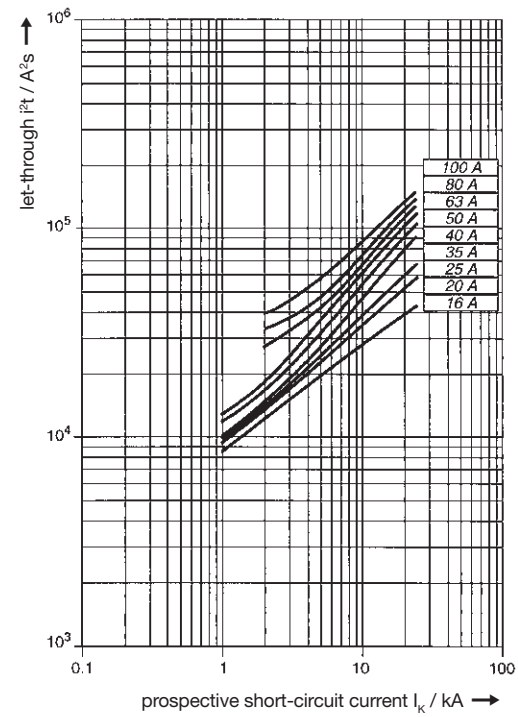

2CDC 022 162 F0103

S 700 characteristic $K_{selective}$
let-through peak current (I_{peak})

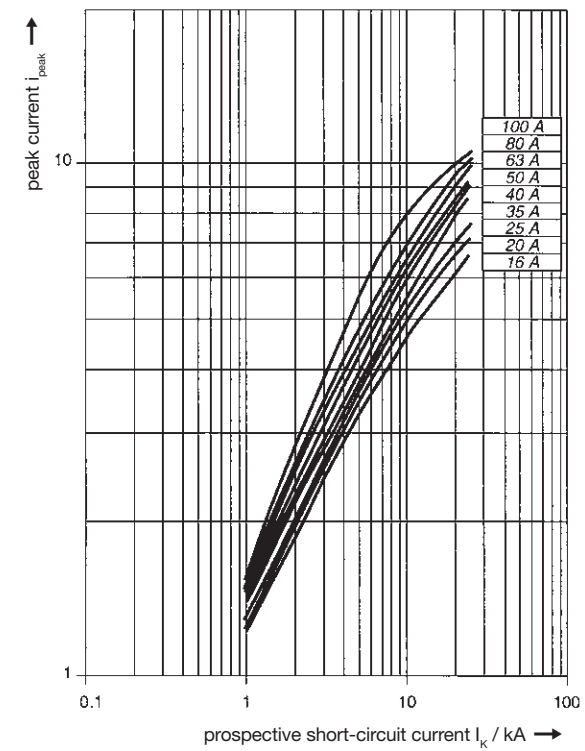

SK 0278 Z 02

S 750 DR characteristic $E_{selective}$
 diagram of let-through values
 I^2t 16... 63 A

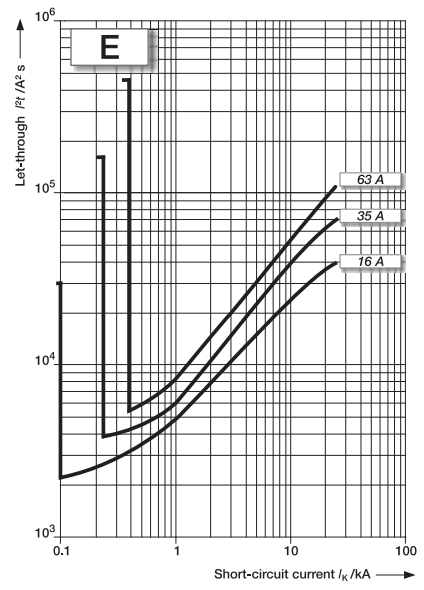

2CDD 022 023 F0212

S 750 DR characteristic $K_{selective}$
 diagram of let-through values
 I^2t 16... 63 A

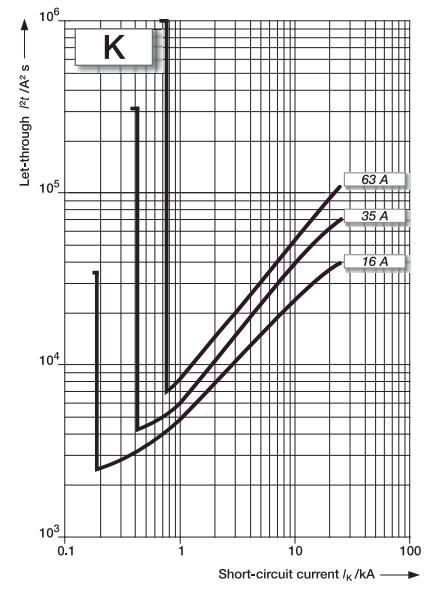

2CDD 022 025 F0212

S 750 DR characteristic $E_{selective} \cdot K_{selective}$
 let-through peak current (I_{peak})

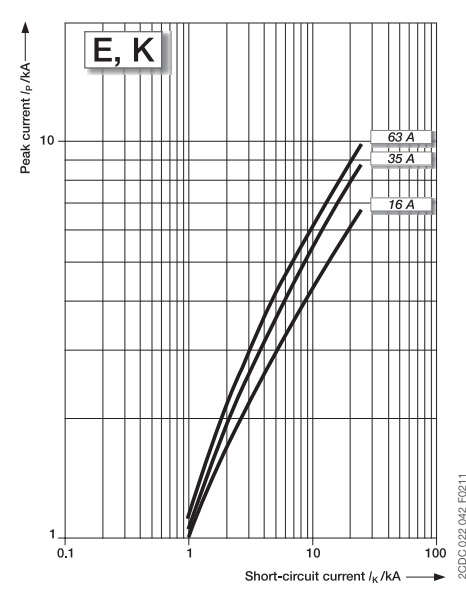

2CDD 022 042 F0211

MCBs technical details

Limitation of specific let-through energy I^2t

S800 S characteristics B, C, D and K
230 V let-through energy

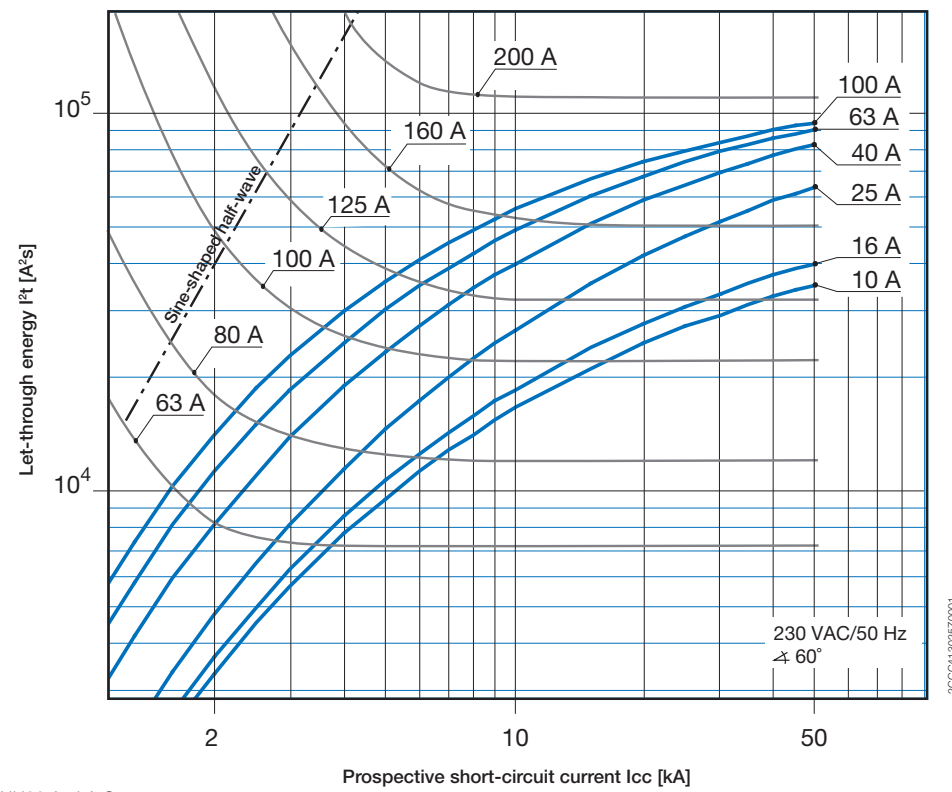
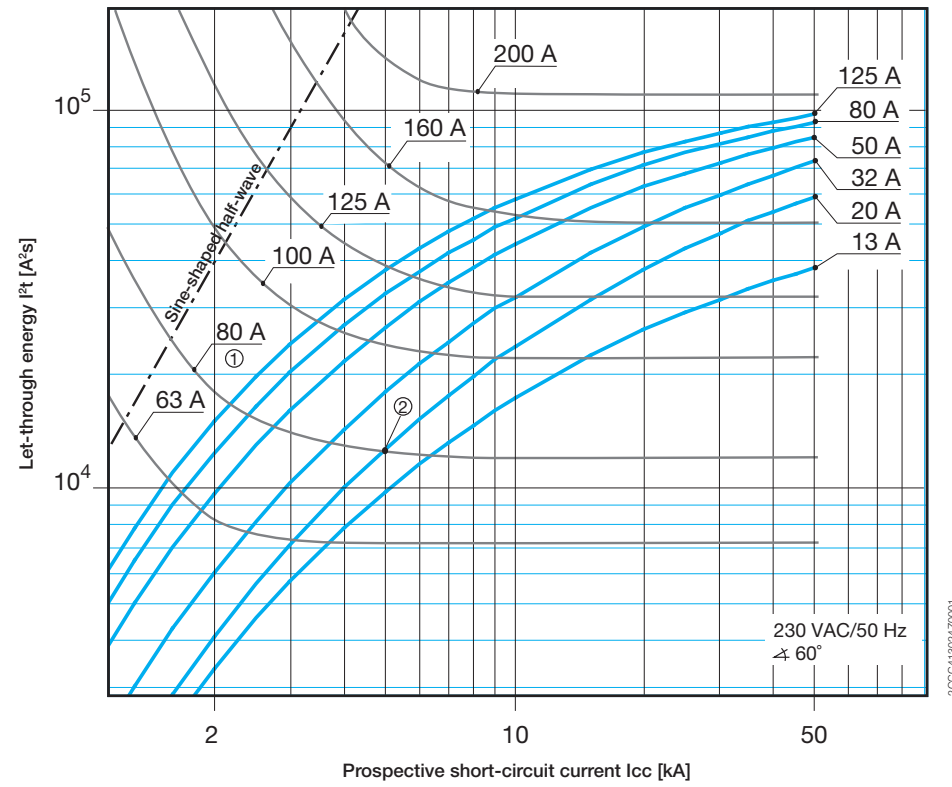

① Min. pre-arcing I^2t , e.g. NH80 A gL/gG
② Max. let-through I^2t , e.g. S801S-C20

S800 S characteristics B, C, D and K

400 V let-through energy

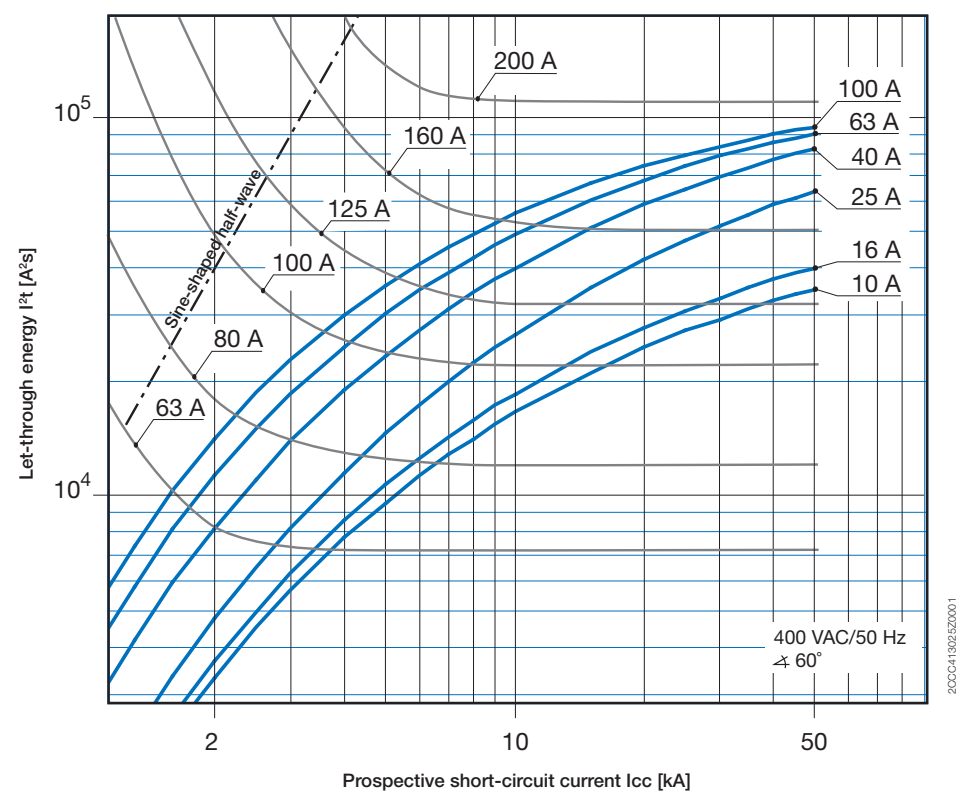
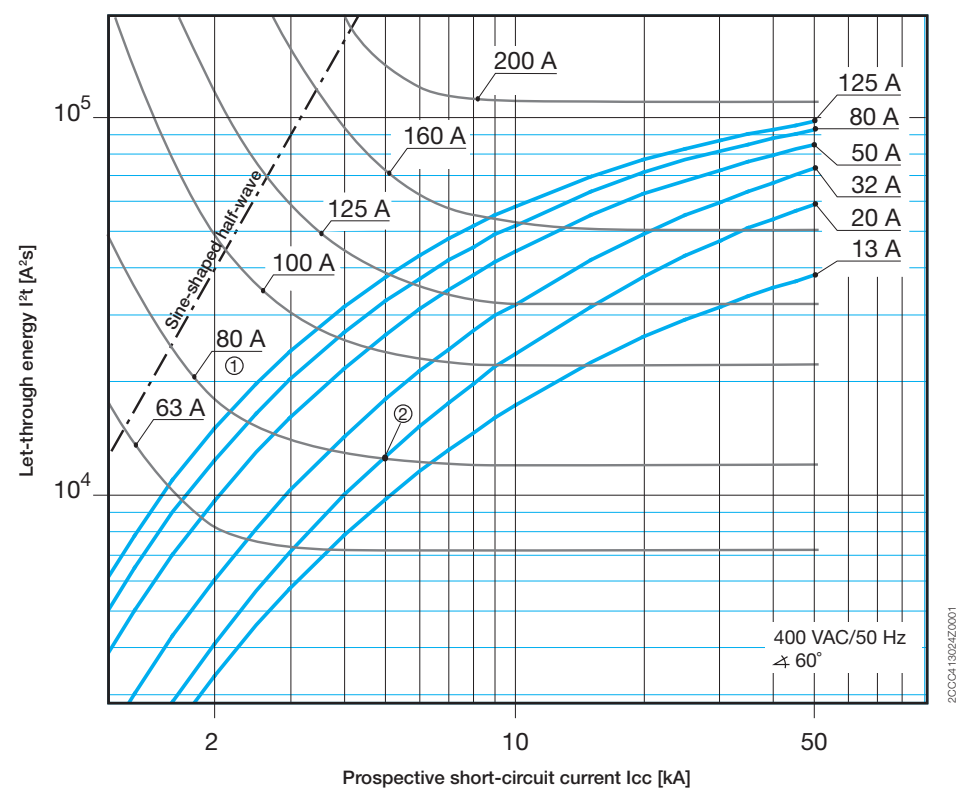

① Min. pre-arcing I^2t , e.g. NH80 A gL/gG
② Max. let-through I^2t , e.g. S801S-C20

MCBs technical details

Limitation of specific let-through energy I^2t

S800 N characteristics B, C and D
230 V let-through energy

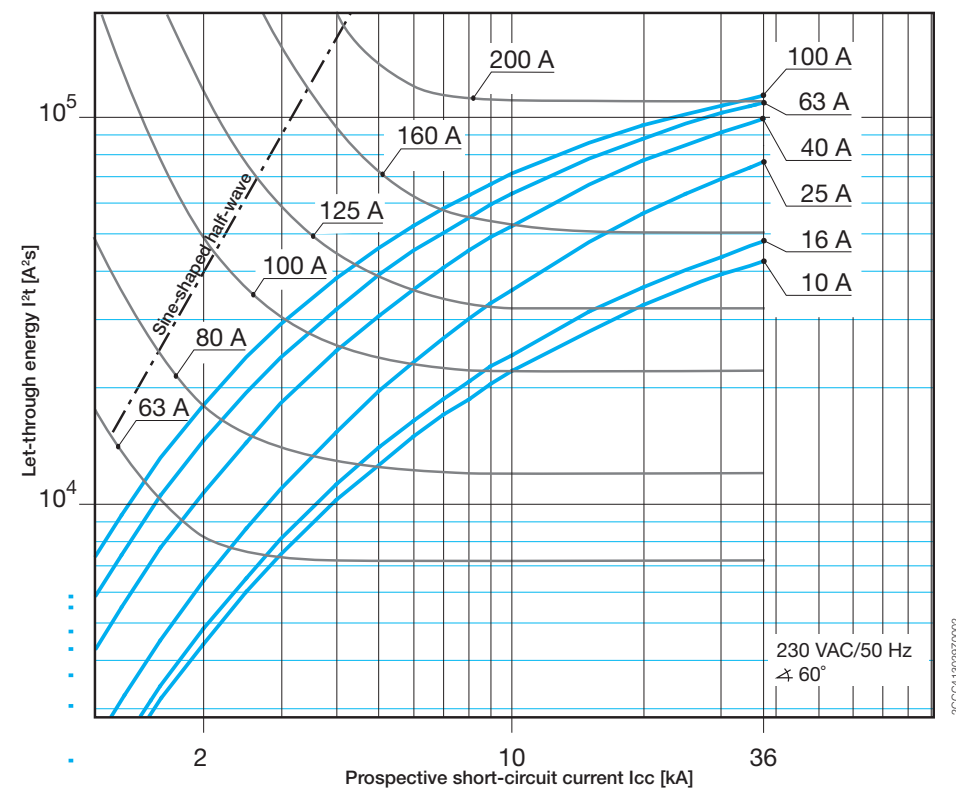
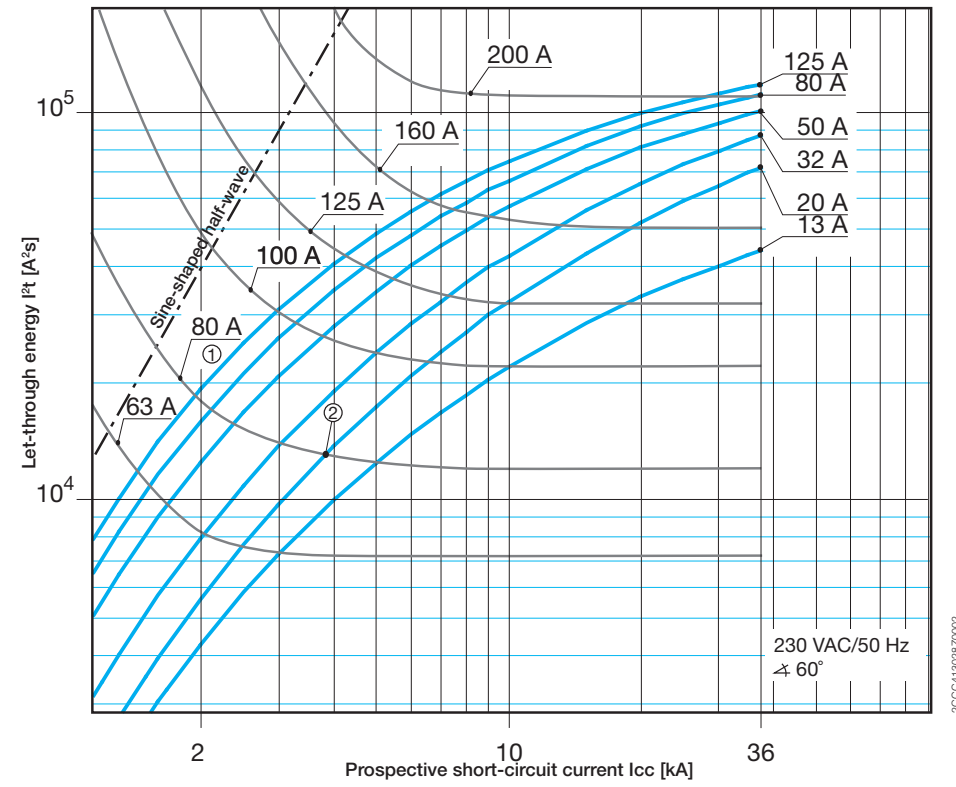

① Min. pre-arcing I^2t , e.g. NH80 A gL/gG
② Max. let-through I^2t , e.g. S801S-C20

S800 N characteristics B, C and D

400 V let-through energy

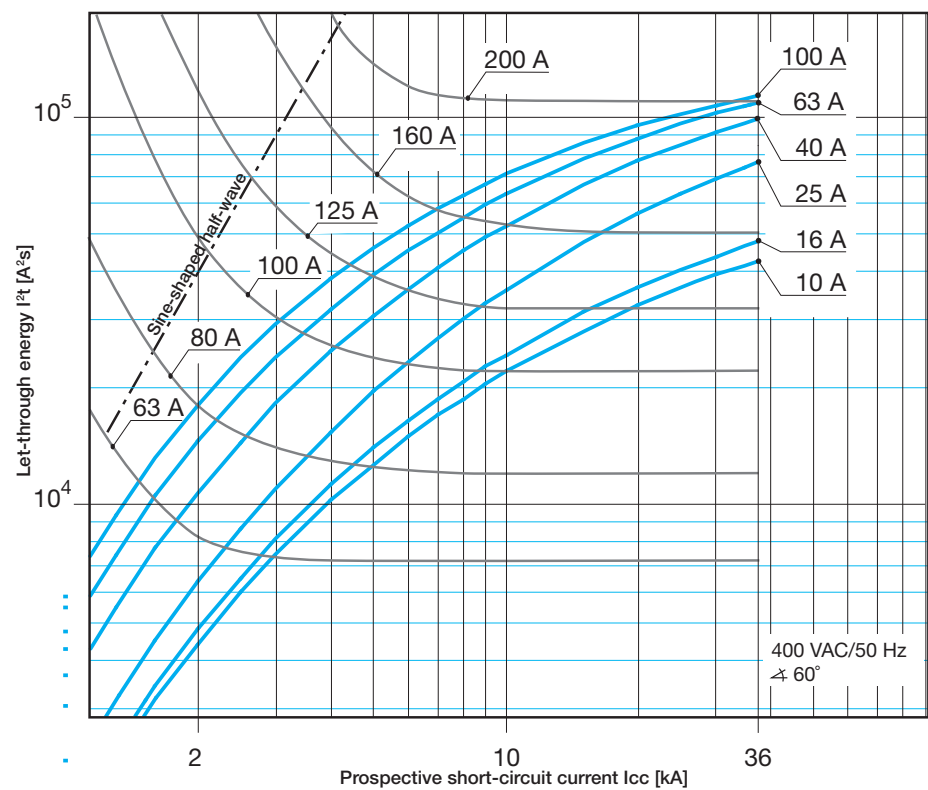
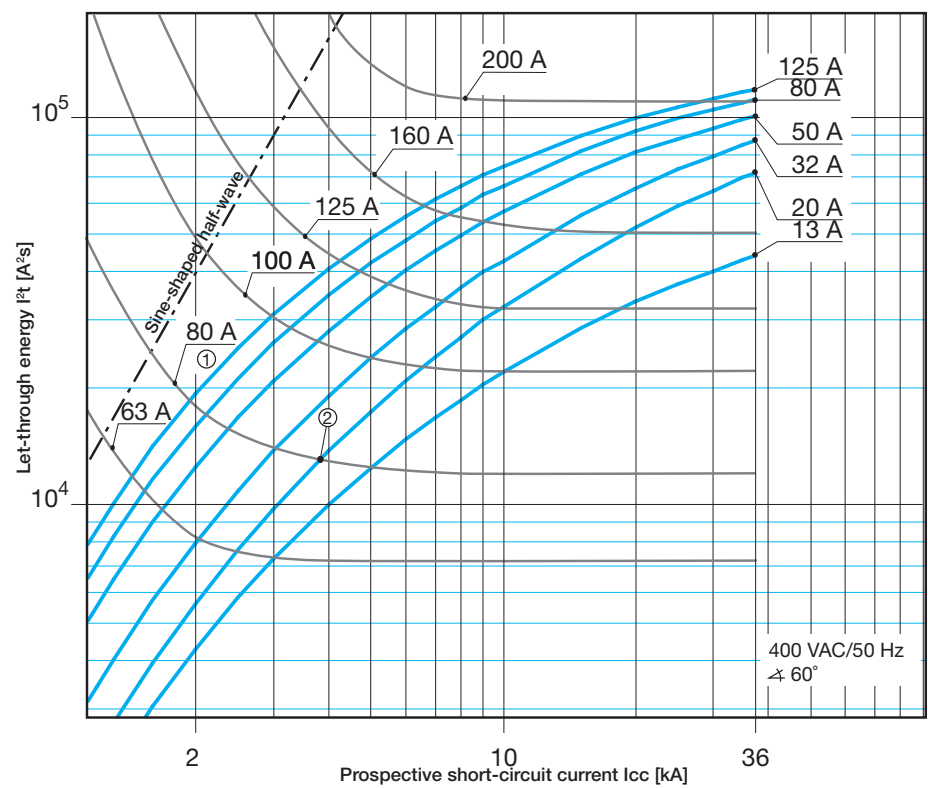

① Min. pre-arcing I²t, e.g. NH80 A gL/gG
 ② Max. let-through I²t, e.g. S801S-C20

MCBs technical details

Limitation of specific let-through energy I^2t

S800 C characteristics B, C, D and K
230 V let-through energy

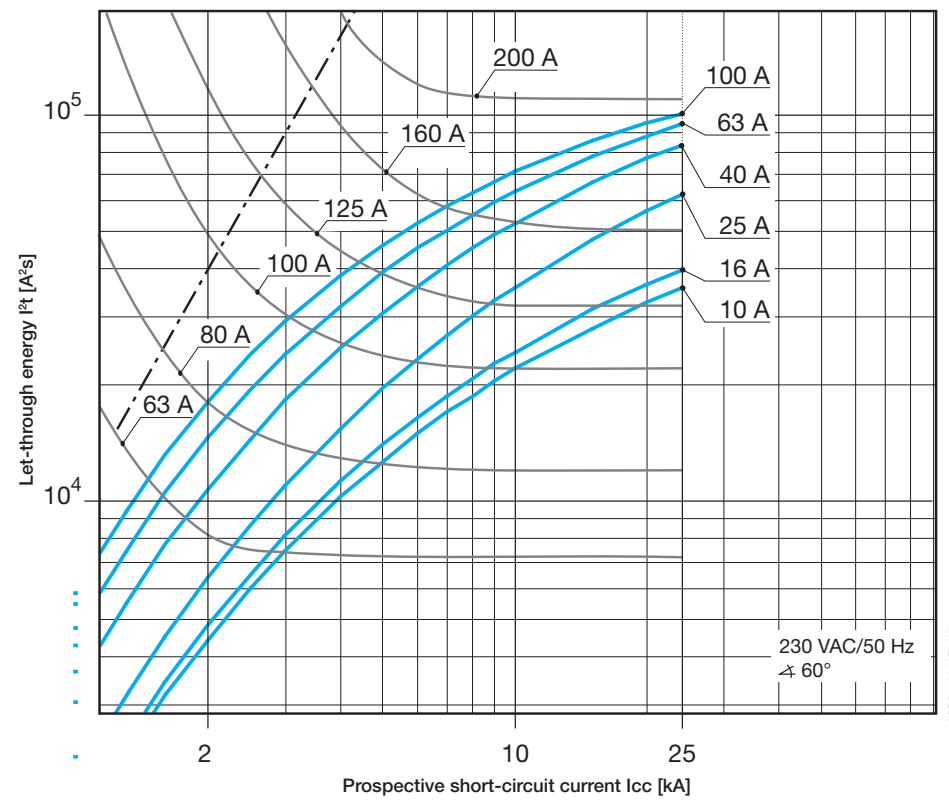
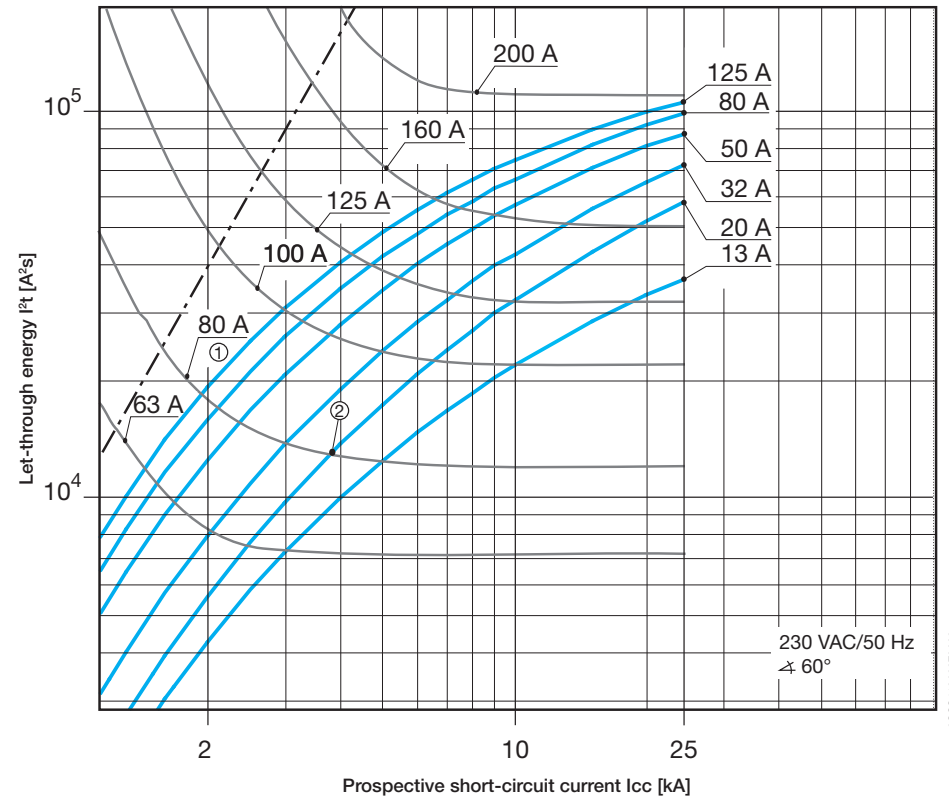

① Min. pre-arcing I^2t , e.g. NH80 A gL/gG
② Max. let-through I^2t , e.g. S801S-C20

S800 C characteristics B, C, D and K

400 V let-through energy

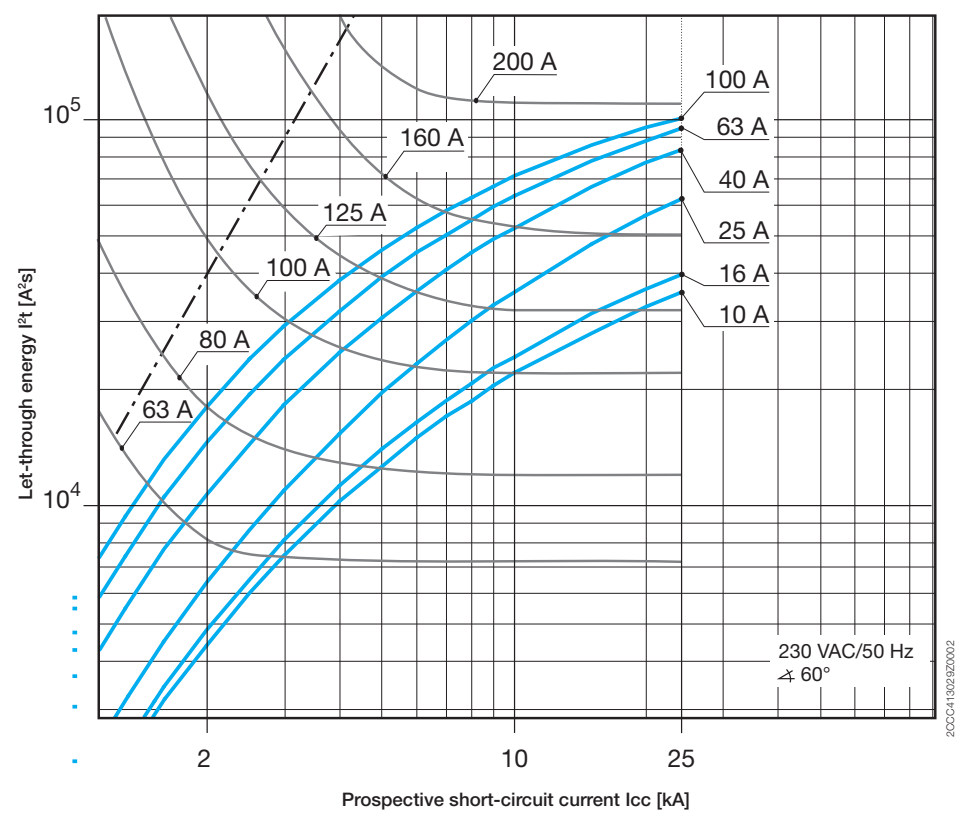
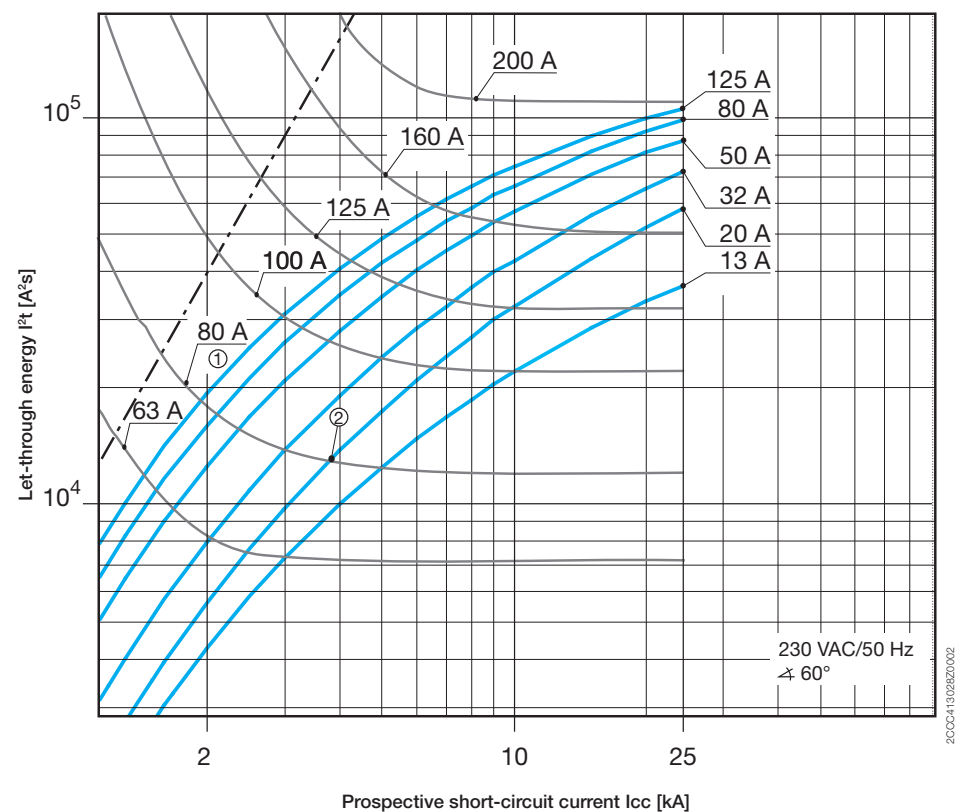

10

① Min. pre-arching I²t, e.g. NH80 A gL/gG
 ② Max. let-through I²t, e.g. S801S-C20

MCBs technical details

Limitation of specific let-through energy I^2t

S800

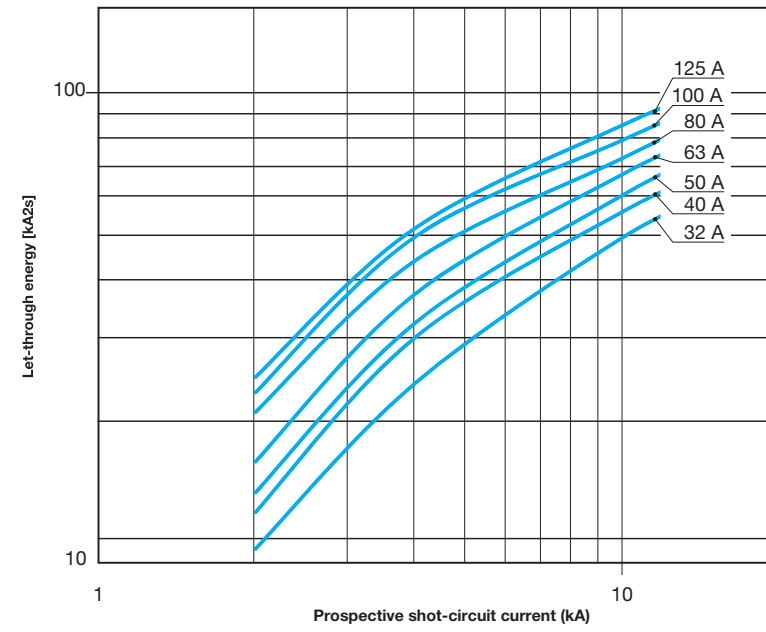

DS201 L - DS201 - DS201 M
 DS202C - DS202C M, characteristics B and C
 230 V let-through energy

10

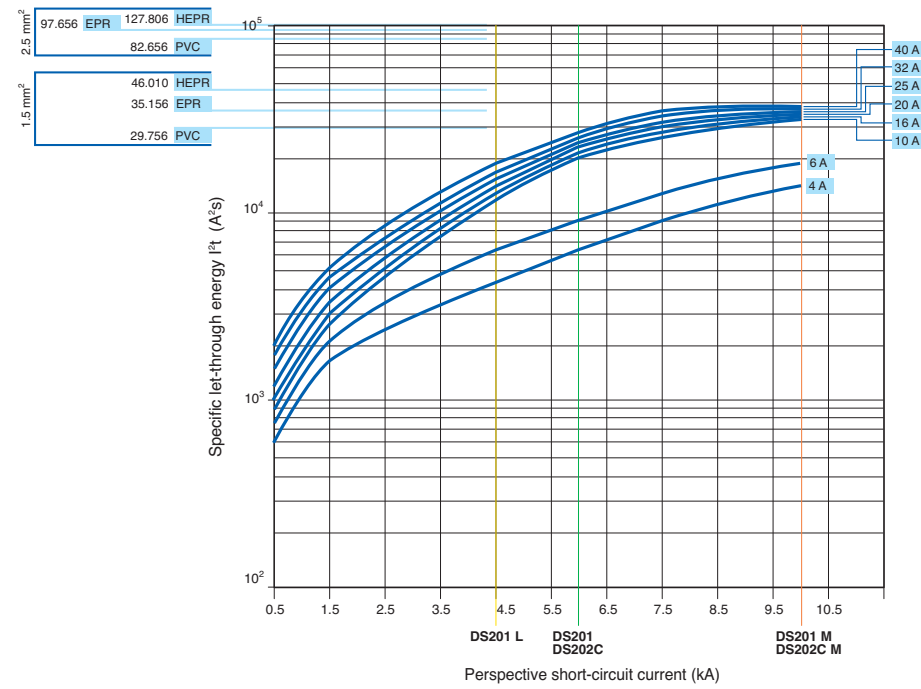

MCBs technical details

Peak current I_p

Limitation curves - Peak current values

The I_p curves give the values of the peak current, expressed in kA, in relation to the perspective symmetrical short-circuit current (kA).

S 200-S 200 M-S 200 P, characteristics B-C; DS 200-DS 200 M, characteristics B-C

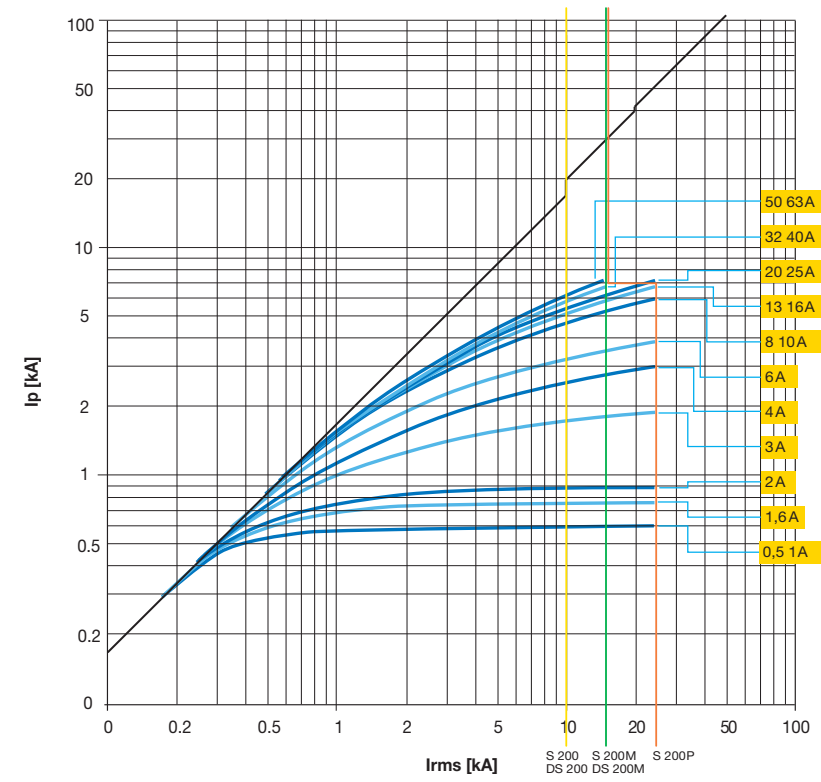

2CSC400119F0202

S 200-S 200 M-S 200 P, characteristics K-D

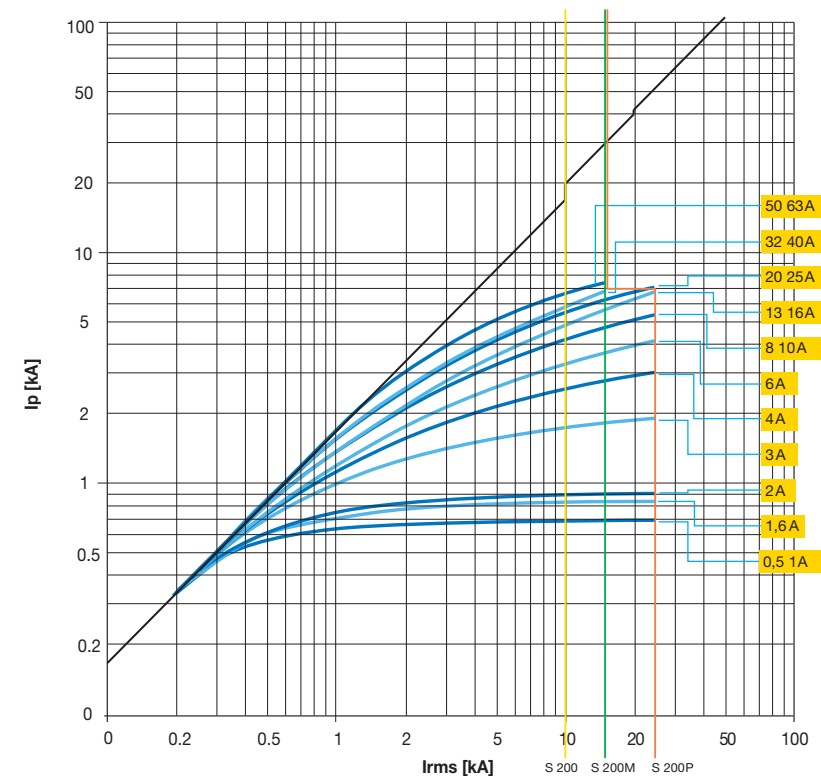

2CSC400114F0202

MCBs technical details

Peak current I_p

S 200-S 200 M-S 200 P, characteristic Z

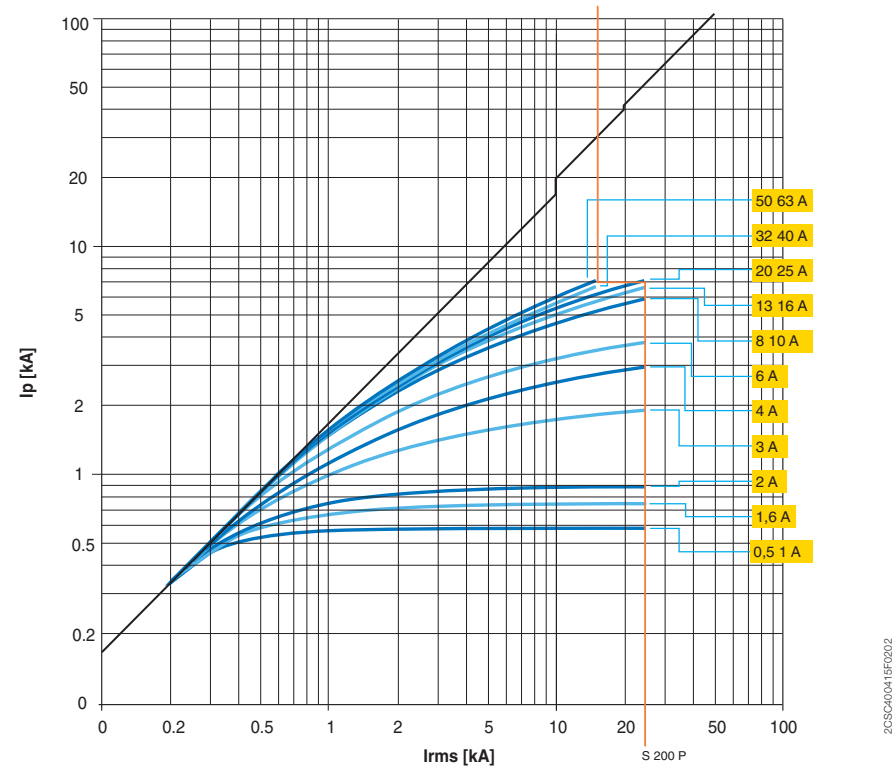

2CSC400118FC022

10 SN 201 L, SN 201, SN 201 M, characteristic B

230 V

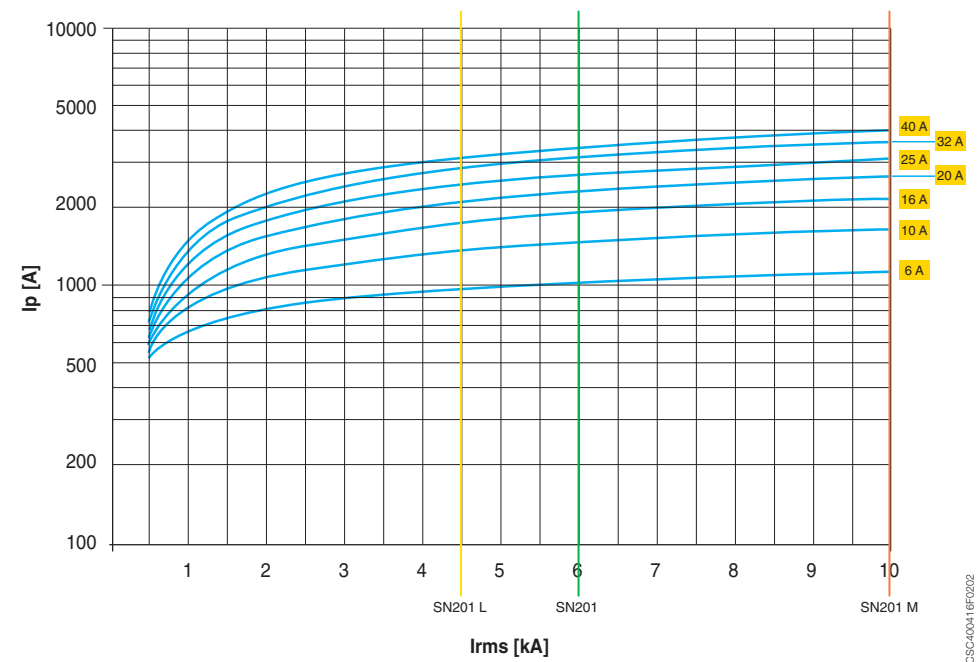

2CSC400118FC022

SN 201 L, SN 201, SN 201 M, characteristic C
230 V

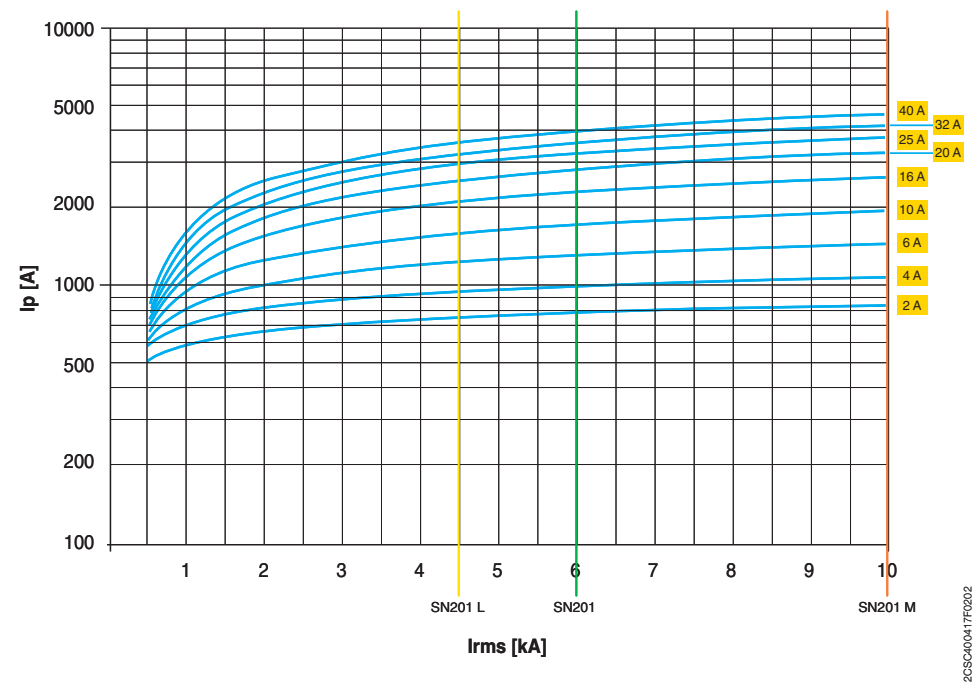

SN 201, characteristic D
230 V

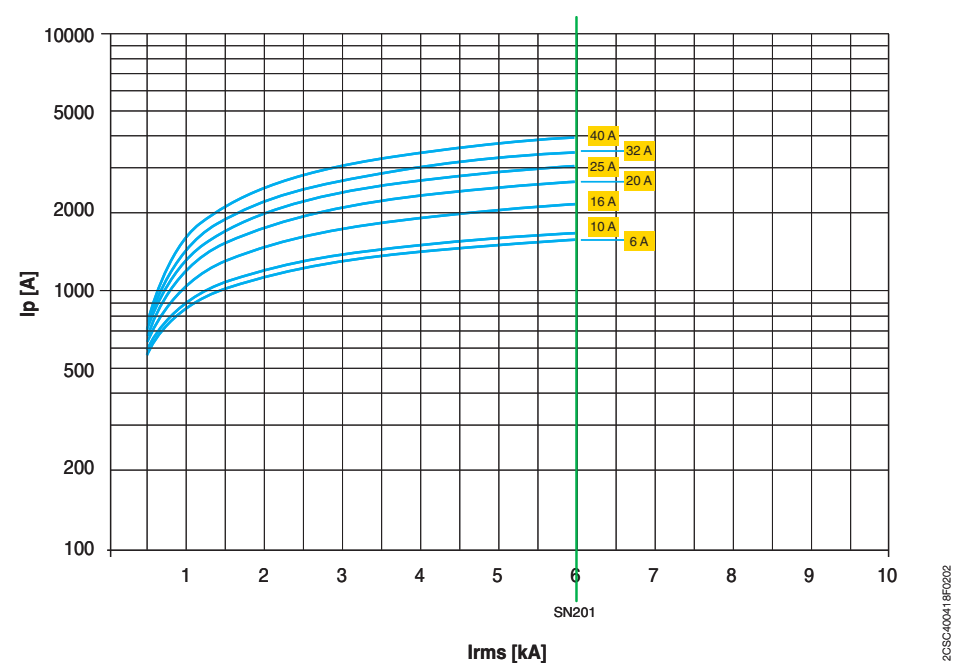

MCBs technical details

Peak current I_p

S 280 80-100 A, characteristic B

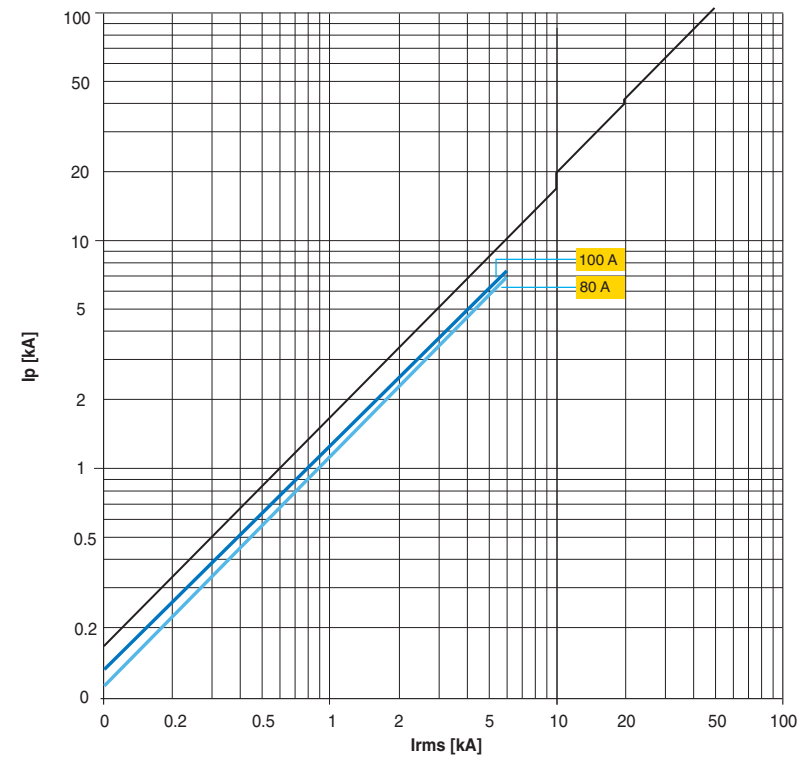

2CSC400419F0202

10

S 280 80-100 A, characteristic C

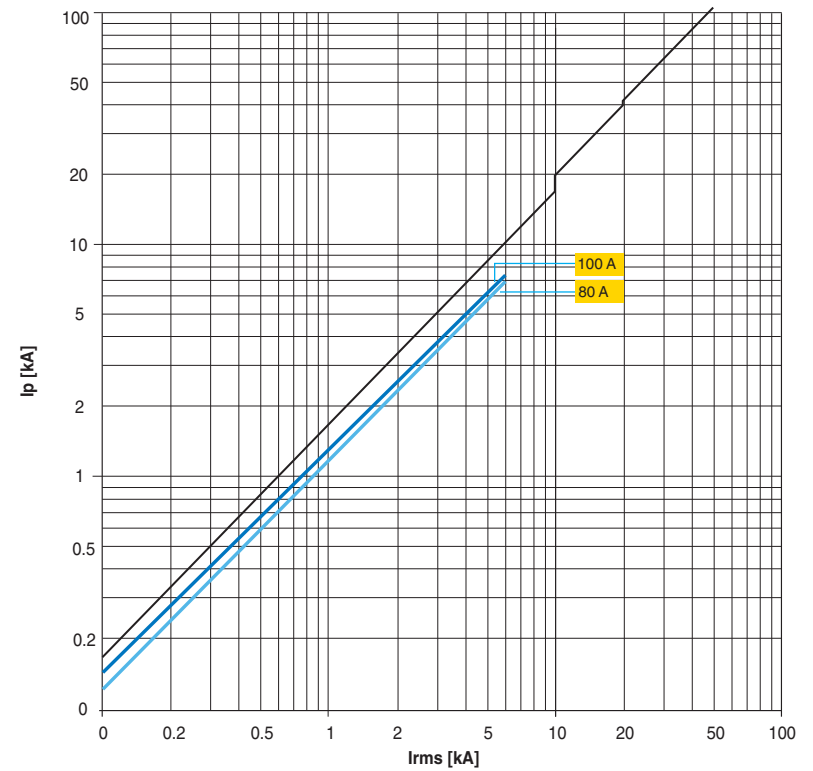

2CSC400420F0202

S 800 S characteristics B, C, D and K

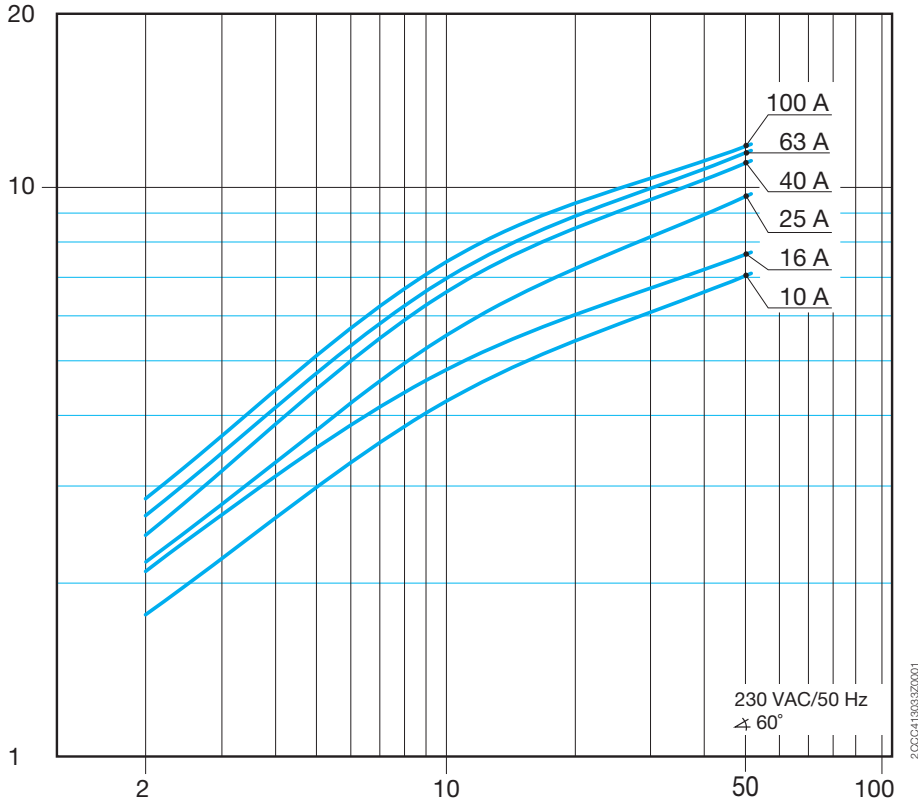
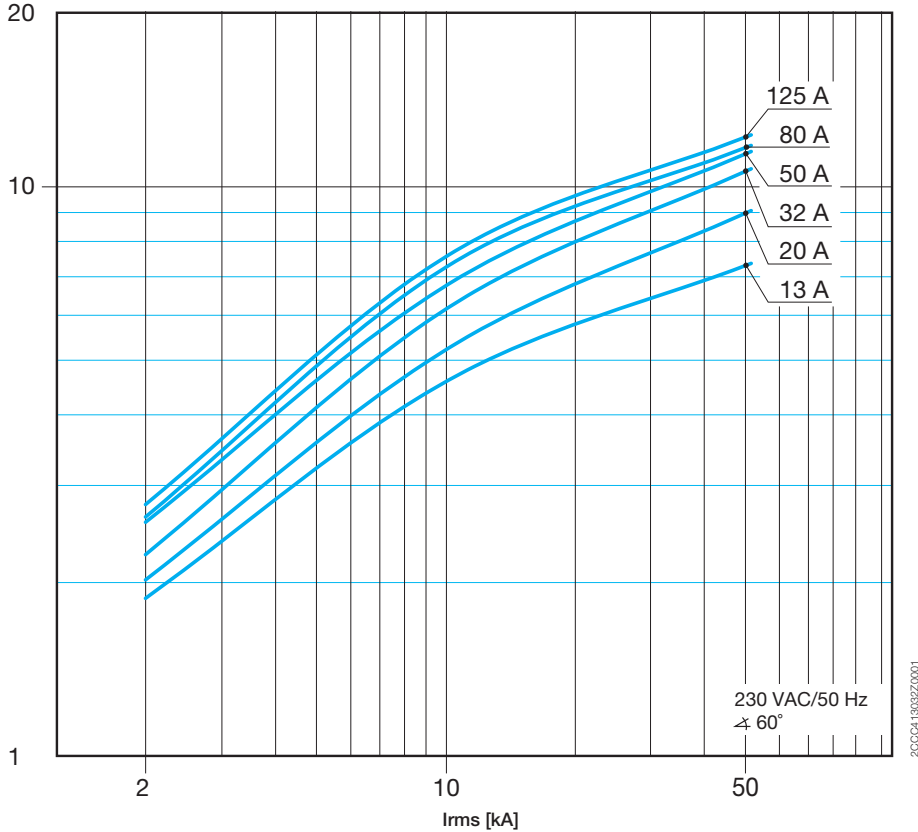

MCBs technical details

Peak current I_p

S 800 N characteristics B, C and D

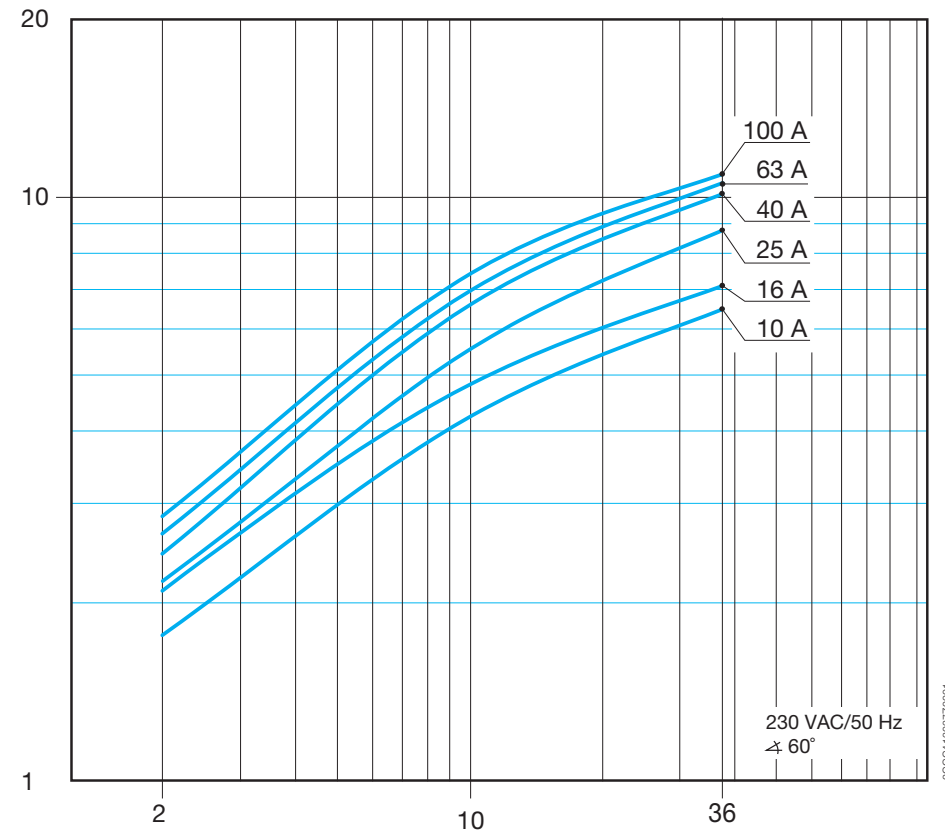
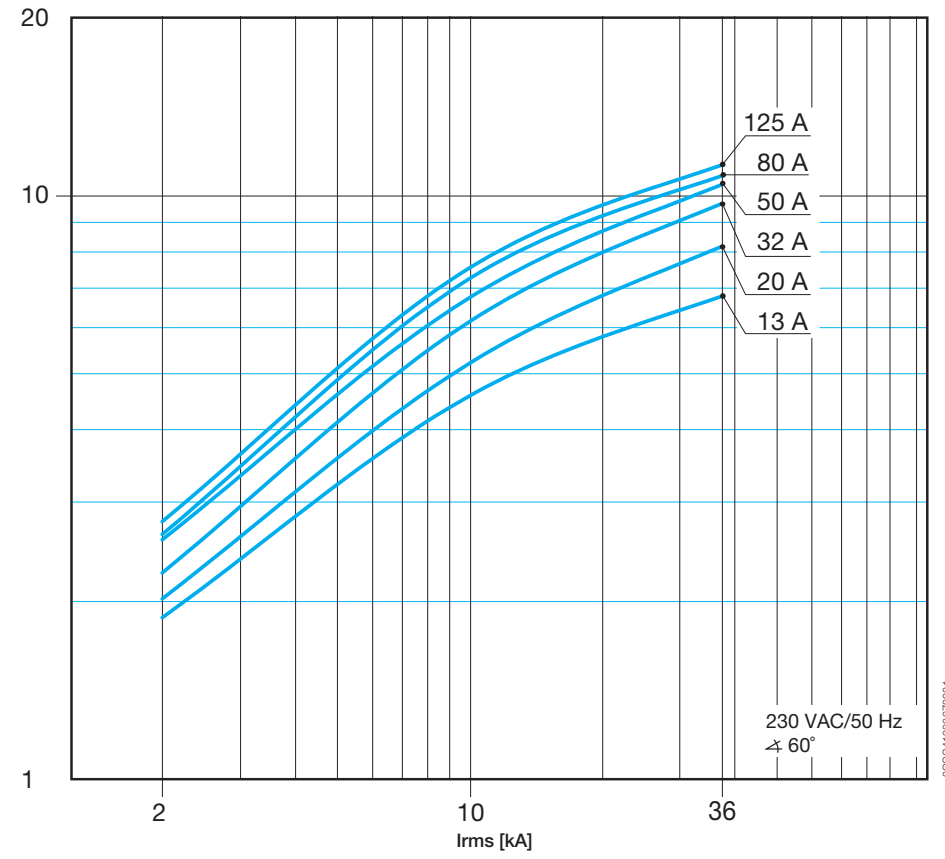

S 800 C characteristics B, C, D and K

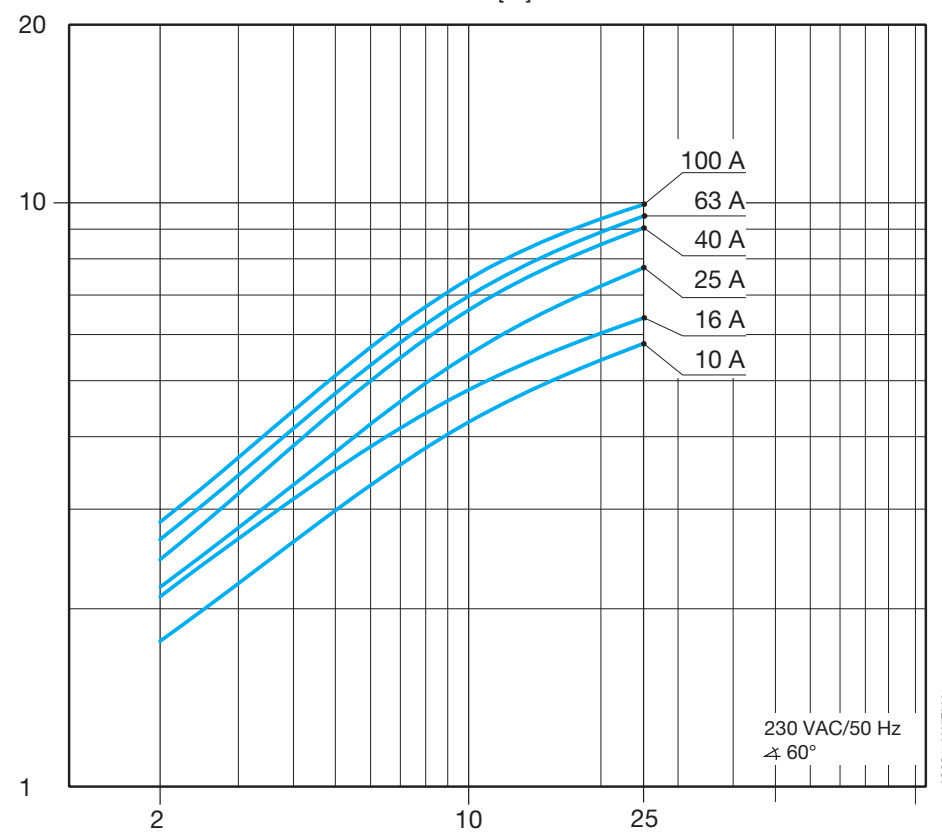
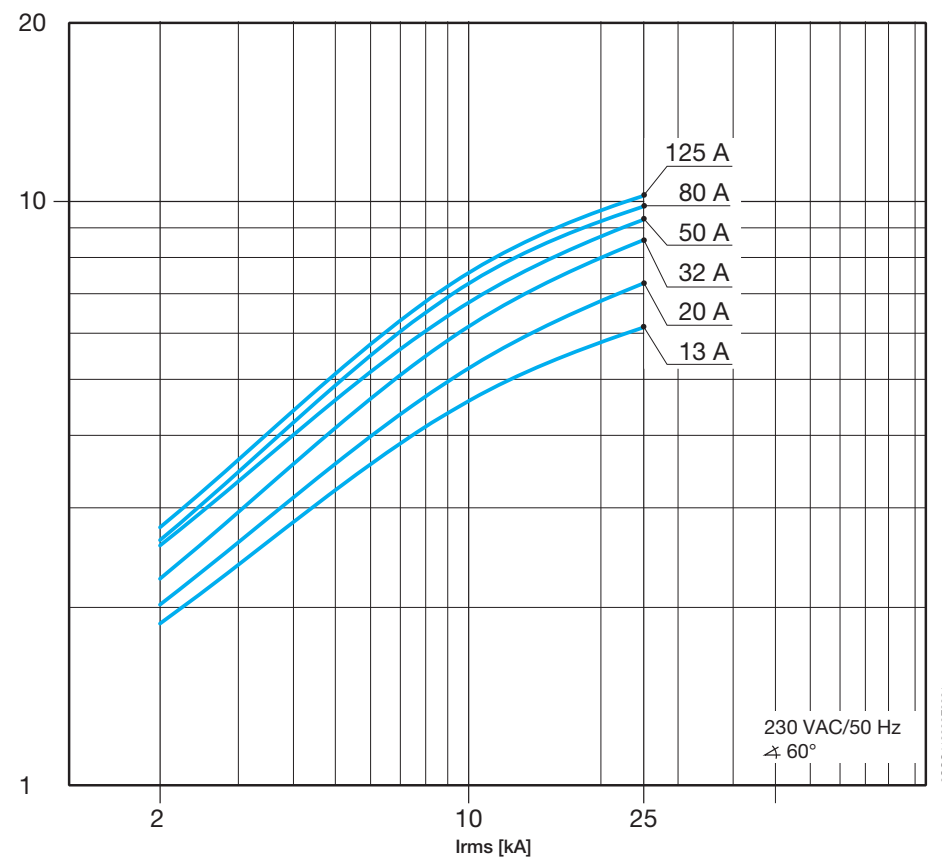

MCBs technical details

Peak current I_p

S 800 B characteristics B, C, D and K

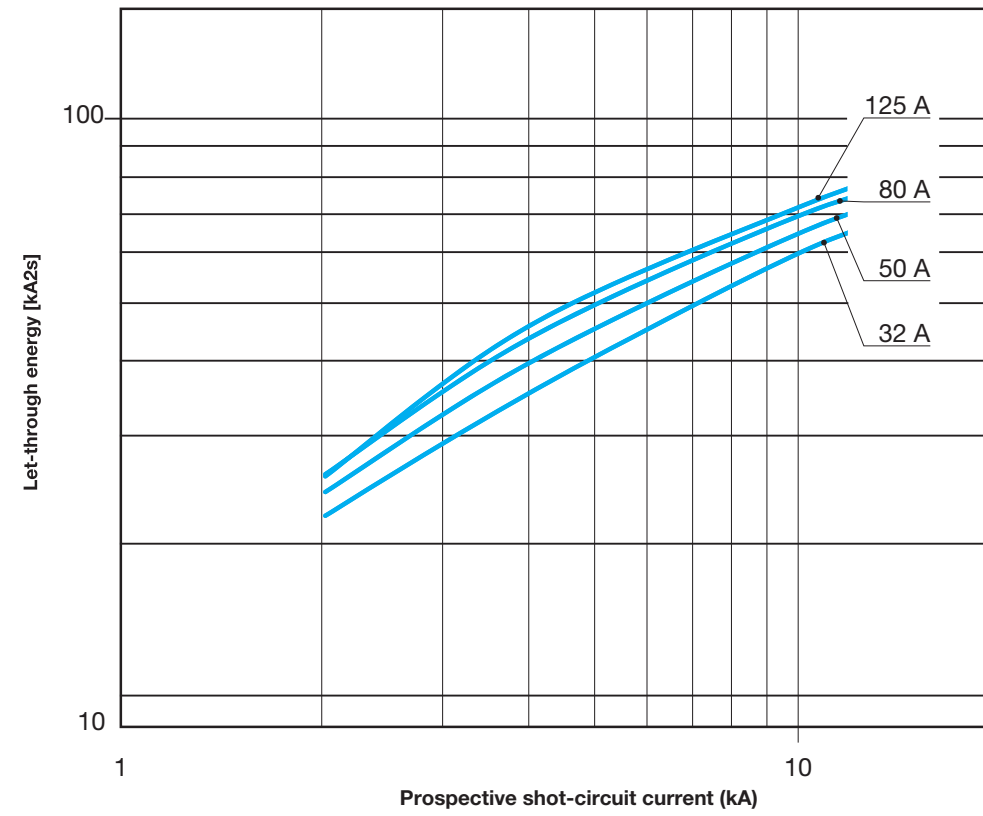

S 800 B characteristics B, C, D and K

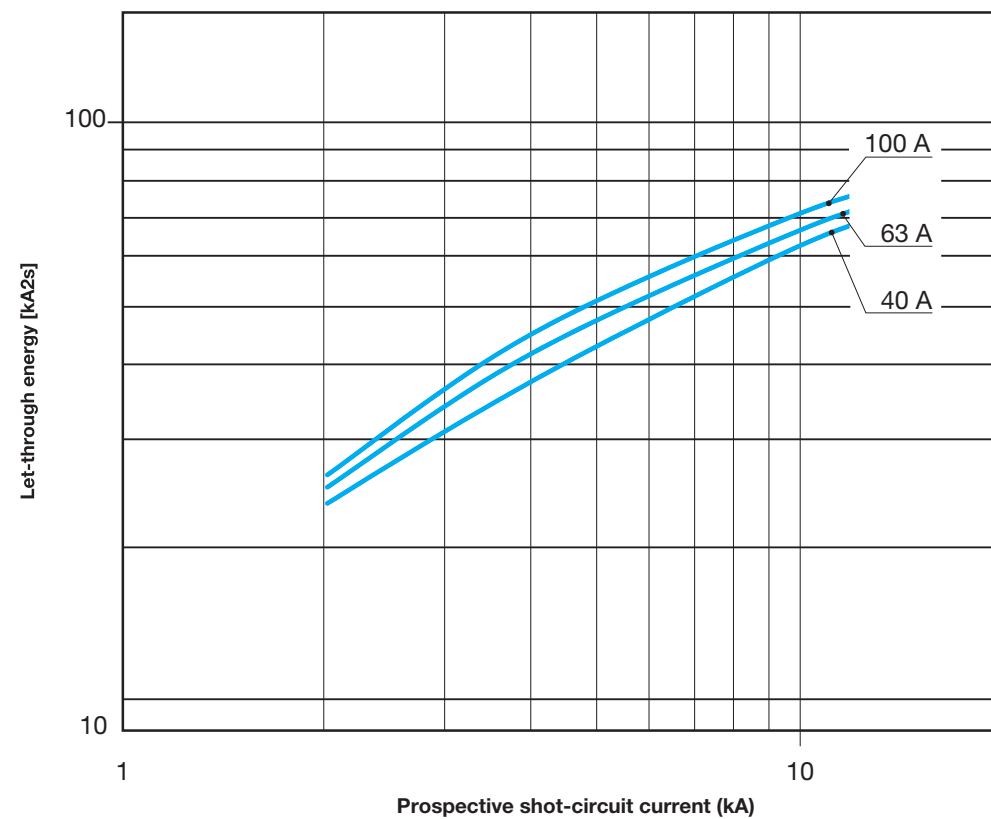

MCBs technical details

Peak current I_p

DS201 L - DS201 - DS201 M
DS202C - DS202C M characteristics B and C
230 V

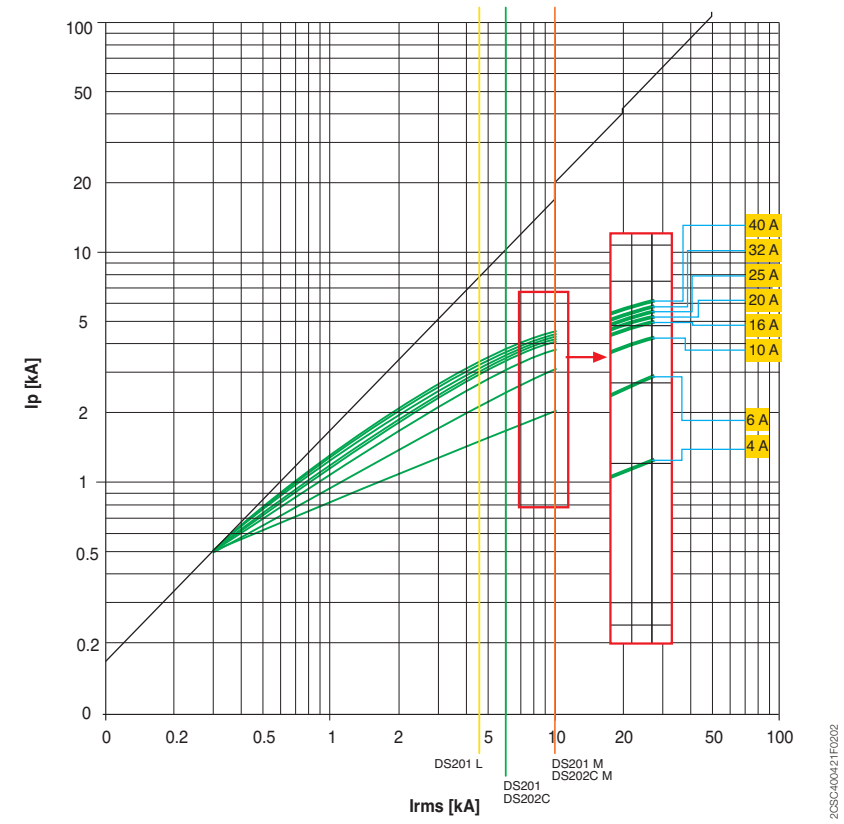

2CSC400421F0202

MCBs technical details

Coordination tables

Back-up protection

The tables given provide the value (in kA, referring to the breaking capacity according to the IEC 60947-2 Standard) for which the back-up protection among the combination of selected circuit-breakers is verified. The tables cover the possible combinations between ABB SACE Tmax series of moulded-case circuit-breakers and those between the above-mentioned circuit-breakers and the ABB series of modular circuit-breakers.

The values indicated in the tables refer to the voltage:

- V_n of 230/240 V AC for coordination with modular SN 201 circuit-breakers
- V_n of 400/415 V AC for all the other coordinations.

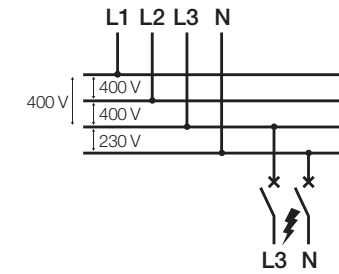

Selective protection

The tables given provide the value (in kA, referring to the breaking capacity according to the IEC 60947-2 Standard) for which the selective protection is verified among the combination of selected circuit-breakers. The tables cover the possible combinations between ABB SACE Tmax series of moulded-case circuit-breakers, and the ABB series of modular circuit-breakers. The values in the table represent the maximum value obtainable of discrimination between supply side circuit-breaker and load side circuit-breaker referring to the voltage:

- V_n of 230/240 V AC for the SN 201 circuit-breakers and V_n of 400/415 V AC for the supply side circuit-breakers in the coordination between MCB with the modular SN 201 circuit-breakers (see picture).
- V_n of 400/415 V AC for all the other coordinations.

MCBs technical details

Coordination tables

Note

The following tables give the breaking capacities at 415 V AC for circuit-breakers SACE Tmax.

Tmax @ 415 V AC	
Version	Icu [kA]
B	16
C	25
N	36
S	50
H	70
L (T2)	85
L (T4, T5)	120
V	200

Caption

MCB = miniature circuit-breakers (SN 201, S 2, S 800)

MCCB = moulded-case circuit-breakers (Tmax)

For moulded-case or air circuit-breakers:

TM = thermomagnetic release

– TMD (Tmax)

– TMA (Tmax)

M = magnetic only release

– MF (Tmax)

– MA (Tmax)

EL = electronic release

– PR221DS - PR222DS (Tmax)

For miniature circuit-breakers:

B = trip characteristic ($I_m=3...5I_n$)

C = trip characteristic ($I_m=5...10I_n$)

D = trip characteristic ($I_m=10...20I_n$)

K = trip characteristic ($I_m=10...14I_n$)

Z = trip characteristic ($I_m=2...3I_n$)

For solutions not shown in these tables, please consult the website:

<http://bol.it.abb.com> or contact ABB SACE

For solutions not shown in these tables referring to SMISLINE or S800 please use:

leaflet 2CCC451039L02xx

MCBs technical details

Coordination tables: back-up

MCB - MCB @240 V

		Supply s.	S200	S200M	S200P	S200P	25gG	40gG	50gG	63gG	80gG	100gG
Load s.	Char.		B-C	B-C	B-C	B-C						
	l _{cu} [kA]	In [A]	0,5...63	0,5...63	0,5...25	32...63						
SN201 L DS201 L	B,C	6	2...40	20	25	40	25	35	25	20	15	10
SN201 DS201 DS202C	B,C,D	10	2...40	20	25	40	25	35	25	20	15	10
SN201 M DS201 M DS202C M	B,C	10	2...40	20	25	40	25	35	25	20	15	10
S200	B,C, K,Z	20	0,5...63		25	40	25					
S200 M	B,C,D	25	0,5...63			40						
S200 P	B,C	40	0,5...25									
	D,K,Z	25	32...63									

MCCB @ 415 V - MCB/RCBO @ 240 V

		Supply S.1	T1	T1	T1	T2	T3	T2	T3	T2	T2	
Load S.	Char.	In [A]	Version	B	C	N	S			H	L	
			l _{cu} [kA]	16	25	36	50	70	85			
SN201 L DS201 L	B, C	2...25 32, 40	6	16	16	16	20	10	20	10	20	20
SN201 DS201 DS202C	B, C, D, K	2...25 32, 40	10	16	16	16	25	16	25	16	25	25
SN201 M DS201 M DS202C M	B, C	2...25 32, 40	10	16	16	16	25	16	25	16	25	25

10

¹ Supply side circuit-breaker 4P (load side circuit branched between one phase and the neutral)

RCBO - MCB @ 240 V

		Supply side	DS201	
Load side	Characteristic	l _{cu} [kA]	B, C	
			In [A]	2...40
SN201 L	B, C	6	2...40	10
SN201	B, C, D	10	2...40	10

MCBs technical details

Coordination tables: back-up

MCB - MCB @ 415 V

		Supply S.		S200	S200M	S200P		S280
Char.				B-C	B-C	B-C		B-C
Load S.	lcu [kA]	In [A]		10	15	25	15	6
				0.5..63	0.5..63	0.5..25	32..63	80, 100
S200	B,C,K,Z	10	0.5..63		15	25	15	
S200M	B,C	15	0.5..63			25		
S200P	B,C	25	0.5..25					
	D,K,Z	15	32..63					

S800S – SN201 @ 230/400 V

		Supply s.		S800S							
Char.				B, C, D, K							
Load s.	lcu [kA]	In [A]		50							
				25	32	40	50	63	80	100	125
SN201	B, D	10	6	50	50	50	50	50	50	50	50
			10	50	50	50	50	50	50	50	50
			16	50	50	50	50	50	50	50	50
			20		50	50	50	50	50	50	50
			25			50	50	50	50	50	50
			32				50	50	50	50	50
			40						50	50	50

S800S – SN201 @ 230/400 V

		Supply s.		S800S							
Char.				B, C, D, K							
Load s.	lcu [kA]	In [A]		50							
				25	32	40	50	63	80	100	125
SN201	C	10	2	50	50	50	50	50	50	50	50
			4	50	50	50	50	50	50	50	
			6	50	50	50	50	50	50	50	
			10	50	50	50	50	50	50	50	
			16	50	50	50	50	50	50	50	
			20		50	50	50	50	50	50	
			25			50	50	50	50	50	
			32				50	50	50	50	
40						50	50	50			

10

S800S – SN201 L @230/400 V

		Supply s.		S800S							
		Char.		B, C, D, K							
Load s.		Icu [kA]	In [A]	50							
				25	32	40	50	63	80	100	125
SN201 L	B, C	6	2	50	40	25	25	18	15	15	15
			4	50	40	25	25	18	15	15	15
			6	50	40	25	25	18	15	15	15
			10	50	40	25	25	18	15	15	15
			16	50	40	25	25	18	15	15	15
			20		40	25	25	18	15	15	15
			25			25	25	18	15	15	15
			32				25	18	15	15	15
			40					18	15	15	15

S800S – SN201 M @ 230/400 V

		Upstream		S800S								
		Char.		B, C, D, K								
Load s.		Icu [kA]	In [A]	50								
				25	32	40	50	63	80	100	125	
SN201 M	B	10	6	50	50	50	50	50	50	50	50	50
			10	50	50	50	50	50	50	50	50	50
			16	50	50	50	50	50	50	50	50	50
			20		50	50	50	50	50	50	50	50
			25			50	50	50	50	50	50	50
			32				50	50	50	50	50	50
			40					50	50	50	50	50

10

S800S - SN201 M @ 230/400 V

		Supply s.		S800S								
		Char.		B, C, D, K								
Load s.		Icu [kA]	In [A]	50								
				25	32	40	50	63	80	100	125	
SN201 M	C	10	2	50	50	50	50	50	50	50	50	50
			4	50	50	50	50	50	50	50	50	50
			6	50	50	50	50	50	50	50	50	50
			10	50	50	50	50	50	50	50	50	50
			16	50	50	50	50	50	50	50	50	50
			20		50	50	50	50	50	50	50	50
			25			50	50	50	50	50	50	50
			32				50	50	50	50	50	50

MCBs technical details

Coordination tables: back-up

S800N – S200 @ 230/400 V

Load s.	Char.	Supply s.		S800N								
		Icu [kA]	In [A]	B, C, D								
				25	32	40	50	63	80	100	125	
S200	B	10	6	36	36	36	36	36	36	36	36	36
			10	36	36	36	36	36	36	36	36	36
			13	36	36	36	36	36	36	36	36	36
			16	36	36	36	36	36	36	36	36	36
			20		36	36	36	36	36	36	36	36
			25			36	36	36	36	36	36	36
			32				36	36	36	36	36	36
			40					36	36	36	36	36
			50						36	36	36	36
			63								36	36

Load s.	Char.	Supply s.		S800N								
		Icu [kA]	In [A]	B, C, D								
				25	32	40	50	63	80	100	125	
S200	C	10	0.5...6	36	36	36	36	36	36	36	36	36
			8	36	36	36	36	36	36	36	36	36
			10	36	36	36	36	36	36	36	36	36
			13	36	36	36	36	36	36	36	36	36
			16	36	36	36	36	36	36	36	36	36
			20		36	36	36	36	36	36	36	36
			25			36	36	36	36	36	36	36
			32				36	36	36	36	36	36
			40					36	36	36	36	36
			50						36	36	36	36
63								36	36			

S800N – S200L @ 230/400 V

Load s.	Char.	Supply s.		S800N								
		Icu [kA]	In [A]	B, C, D								
				25	32	40	50	63	80	100	125	
S200L	C	6	6...8	36	36	36	36	36	36	36	36	36
			10	36	36	36	36	36	36	36	36	36
			13	36	36	36	36	36	36	36	36	36
			16	36	36	36	36	36	36	36	36	36
			20		36	36	36	36	36	36	36	36
			25			36	36	36	36	36	36	36
			32				36	36	36	36	36	36
			40					36	36	36	36	36

10

S800N – S200M @ 230/400 V

Load s.	Char.	Supply s.		S800N								
		Icu [kA]	In [A]	B, C, D								
				36								
S200M	B	15	6...16	36	36	36	36	36	36	36	36	36
			20		36	36	36	36	36	36	36	36
			25			36	36	36	36	36	36	36
			32				36	36	36	36	36	36
			40					36	36	36	36	36
			50						36	36	36	36
			63							36	36	36

Load s.	Char.	Supply s.		S800N								
		Icu [kA]	In [A]	B, C, D								
				36								
S200M	C	15	0.5...16	36	36	36	36	36	36	36	36	36
			20		36	36	36	36	36	36	36	36
			25			36	36	36	36	36	36	36
			32				36	36	36	36	36	36
			40					36	36	36	36	36
			50						36	36	36	36
			63							36	36	36

S800N – S200P @ 230/400 V

Load s.	Char.	Supply s.		S800N								
		Icu [kA]	In [A]	B, C, D								
				36								
S200P	B	25	6...16	36	36	36	36	36	36	36	36	36
			20		36	36	36	36	36	36	36	36
			25			36	36	36	36	36	36	36
		15	32				36	36	36	36	36	36
			40					36	36	36	36	36
			50						36	36	36	36
			63							36	36	36

Load s.	Char.	Supply s.		S800N								
		Icu [kA]	In [A]	B, C, D								
				36								
S200P	C	25	0.5...16	36	36	36	36	36	36	36	36	36
			20		36	36	36	36	36	36	36	36
			25			36	36	36	36	36	36	36
		15	32				36	36	36	36	36	36
			40					36	36	36	36	36
			50						36	36	36	36
			63							36	36	36

MCBs technical details

Coordination tables: back-up

S800N – SN201 @ 230/400 V

Load s.	Char.	Supply s.		S800N								
		Icu [kA]	In [A]	B, C, D								
				25	32	40	50	63	80	100	125	
SN201	B, D	10	6	36	36	36	36	36	36	36	36	36
			10	36	36	36	36	36	36	36	36	36
			16	36	36	36	36	36	36	36	36	36
			20		36	36	36	36	36	36	36	36
			25			36	36	36	36	36	36	36
			32				36	36	36	36	36	36
			40					36	36	36	36	36

S800N – SN201 @ 230/400 V

Load s.	Char.	Supply s.		S800N								
		Icu [kA]	In [A]	B, C, D								
				25	32	40	50	63	80	100	125	
SN201	C	10	2	36	36	36	36	36	36	36	36	36
			4	36	36	36	36	36	36	36	36	36
			6	36	36	36	36	36	36	36	36	36
			10	36	36	36	36	36	36	36	36	36
			16	36	36	36	36	36	36	36	36	36
			20		36	36	36	36	36	36	36	36
			25			36	36	36	36	36	36	36
			32				36	36	36	36	36	36
			40					36	36	36	36	36

S800N – SN201L @ 230/400 V

Load s.	Char.	Supply s.		S800N							
		Icu [kA]	In [A]	B, C, D							
				25	32	40	50	63	80	100	125
SN201 L	B, C	6	2	36	36	25	25	18	15	15	15
			4	36	36	25	25	18	15	15	15
			6	36	36	25	25	18	15	15	15
			10	36	36	25	25	18	15	15	15
			16	36	36	25	25	18	15	15	15
			20		36	25	25	18	15	15	15
			25			25	25	18	15	15	15
			32				25	18	15	15	15
			40					18	15	15	15

10

S800N – SN201M @ 230/400 V

		Supply s.		S800N								
		Char.		B, C, D								
Load.s		Icu [kA]	In [A]	36								
				25	32	40	50	63	80	100	125	
SN201 M	B	10	6	36	36	36	36	36	36	36	36	36
			10	36	36	36	36	36	36	36	36	36
			16	36	36	36	36	36	36	36	36	36
			20		36	36	36	36	36	36	36	36
			25			36	36	36	36	36	36	36
			32				36	36	36	36	36	36
			40					36	36	36	36	36

S800N – SN201M @230/400 V

		Supply s.		S800N								
		Char.		B, C, D								
Load s.		Icu [kA]	In [A]	36								
				25	32	40	50	63	80	100	125	
SN201 M	C	10	2	36	36	36	36	36	36	36	36	36
			4	36	36	36	36	36	36	36	36	36
			6	36	36	36	36	36	36	36	36	36
			10	36	36	36	36	36	36	36	36	36
			16	36	36	36	36	36	36	36	36	36
			20		36	36	36	36	36	36	36	36
			25			36	36	36	36	36	36	36

S800C – S200 @ 230/400 V

		Supply s.		S800C								
		Char.		B, C, D								
Load s.		Icu [kA]	In [A]	25								
				25	32	40	50	63	80	100	125	
S200	B	10	6	25	25	25	25	25	25	25	25	25
			10	25	25	25	25	25	25	25	25	25
			13	25	25	25	25	25	25	25	25	25
			16	25	25	25	25	25	25	25	25	25
			20		25	25	25	25	25	25	25	25
			25			25	25	25	25	25	25	25
			32				25	25	25	25	25	25
			40					25	25	25	25	25
			50						25	25	25	25
			63								25	25

MCBs technical details

Coordination tables: back-up

Load s.	Char.	Supply s.		S800C								
		Icu [kA]	In [A]	B, C, D								
				25	32	40	50	63	80	100	125	
S200	C	10	0.5...6	25	25	25	25	25	25	25	25	25
			8	25	25	25	25	25	25	25	25	
			10	25	25	25	25	25	25	25	25	
			13	25	25	25	25	25	25	25	25	
			16	25	25	25	25	25	25	25	25	
			20		25	25	25	25	25	25	25	
			25			25	25	25	25	25	25	
			32				25	25	25	25	25	
			40					25	25	25	25	
			50						25	25	25	
63								25	25			

S800C – S200M @ 230/400 V

Load s.	Char.	Supply s.		S800C								
		Icu [kA]	In [A]	B, C, D								
				25	32	40	50	63	80	100	125	
S200M	B	15	6...16	25	25	25	25	25	25	25	25	
			20		25	25	25	25	25	25		
			25			25	25	25	25	25		
			32				25	25	25	25		
			40					25	25	25		
			50						25	25		
			63							25		

Load s.	Char.	Supply s.		S800C								
		Icu [kA]	In [A]	B, C, D								
				25	32	40	50	63	80	100	125	
S200M	C	15	0.5...16	25	25	25	25	25	25	25	25	
			20		25	25	25	25	25	25		
			25			25	25	25	25	25		
			32				25	25	25	25		
			40					25	25	25		
			50						25	25		
			63							25		

S800C – S200P @ 230/400 V

Load s.	Char.	Supply s.		S800C								
		Icu [kA]	In [A]	B, C, D								
				25								
S200P	B	25	6...16	25	25	25	25	25	25	25	25	25
			20		25	25	25	25	25	25	25	25
			25			25	25	25	25	25	25	25
		15	32				25	25	25	25	25	25
			40					25	25	25	25	25
			50						25	25	25	25
			63							25	25	25

Load s.	Char.	Supply s.		S800C								
		Icu [kA]	In [A]	B, C, D								
				25								
S200P	C	25	0.5...16	25	25	25	25	25	25	25	25	25
			20		25	25	25	25	25	25	25	25
			25			25	25	25	25	25	25	25
		15	32				25	25	25	25	25	25
			40					25	25	25	25	25
			50						25	25	25	25
			63							25	25	25

10

S800C – SN201 @ 230/400 V

Load s.	Char.	Supply s.		S800C								
		Icu [kA]	In [A]	B, C, D, K								
				25								
SN201	B, D	10	6	25	25	25	25	25	25	25	25	25
			10	25	25	25	25	25	25	25	25	25
			16	25	25	25	25	25	25	25	25	25
			20		25	25	25	25	25	25	25	25
			25			25	25	25	25	25	25	25
			32				25	25	25	25	25	25
			40					25	25	25	25	25

MCBs technical details

Coordination tables: back-up

S800C – SN201 @ 230/400 V

		Supply s.		S800C								
		Char.		B, C, D, K								
Load s.		Icu [kA]	In [A]	25								
				25	32	40	50	63	80	100	125	
SN201	C	10	2	25	25	25	25	25	25	25	25	25
			4	25	25	25	25	25	25	25	25	25
			6	25	25	25	25	25	25	25	25	25
			10	25	25	25	25	25	25	25	25	25
			16	25	25	25	25	25	25	25	25	25
			20		25	25	25	25	25	25	25	25
			25			25	25	25	25	25	25	25
			32				25	25	25	25	25	25
			40					25	25	25	25	25

S800C – SN201L @ 230/400 V

		Supply s.		S800C								
		Char.		B, C, D, K								
Load s.		Icu [kA]	In [A]	25								
				25	32	40	50	63	80	100	125	
SN201L	B, C	6	2	25	25	25	25	18	15	15	15	
			4	25	25	25	25	18	15	15	15	
			6	25	25	25	25	18	15	15	15	
			10	25	25	25	25	18	15	15	15	
			16	25	25	25	25	18	15	15	15	
			20		25	25	25	18	15	15	15	
			25			25	25	18	15	15	15	
			32				25	18	15	15	15	
			40					18	15	15	15	

S800C – SN201M @ 230/400 V

		Supply s.		S800C								
		Char.		B, C, D, K								
Load s.		Icu [kA]	In [A]	25								
				25	32	40	50	63	80	100	125	
SN201M	B	10	6	25	25	25	25	25	25	25	25	
			10	25	25	25	25	25	25	25	25	
			16	25	25	25	25	25	25	25	25	
			20		25	25	25	25	25	25	25	
			25			25	25	25	25	25	25	
			32				25	25	25	25	25	
			40					25	25	25	25	

10

S800C – SN201M @ 230/400 V

		Supply s.	S800C									
		Char.	B, C, D, K									
Load s.		Icu [kA]	In [A]	25								
			25	32	40	50	63	80	100	125		
SN201M	C	10	2	25	25	25	25	25	25	25	25	25
			4	25	25	25	25	25	25	25	25	25
			6	25	25	25	25	25	25	25	25	25
			10	25	25	25	25	25	25	25	25	25
			16	25	25	25	25	25	25	25	25	25
			20		25	25	25	25	25	25	25	25
			25			25	25	25	25	25	25	25
			32				25	25	25	25	25	25

S800B – S200 @ 230/400 V

		Supply s.	S800B								
		Char.	B, C, D, K								
Load s.		Icu [kA]	In [A]	32							125*
			32	40	50	63	80	100	125*		
S200	B	10	6	16	16	16	16	16	16	16	16
			10	16	16	16	16	16	16	16	16
			13	16	16	16	16	16	16	16	16
			16	16	16	16	16	16	16	16	16
			20	16	16	16	16	16	16	16	16
			25		16	16	16	16	16	16	16
			32			16	16	16	16	16	16
			40				16	16	16	16	16
			50					16	16	16	16
			63						16	16	16

10

		Supply s.	S800B								
		Char.	B, C, D, K								
Load s.		Icu [kA]	In [A]	32							125*
			32	40	50	63	80	100	125*		
S200	C, D, K, Z	10	0.5...6	16	16	16	16	16	16	16	16
			8	16	16	16	16	16	16	16	16
			10	16	16	16	16	16	16	16	16
			13	16	16	16	16	16	16	16	16
			16	16	16	16	16	16	16	16	16
			20	16	16	16	16	16	16	16	16
			25		16	16	16	16	16	16	16
			32			16	16	16	16	16	16
			40				16	16	16	16	16
			50					16	16	16	16
63						16	16	16			

* only S800B-B,C
back-up values indicated in kA

MCBs technical details

Coordination tables: back-up

S800B – S200M @ 230/400V

		Supply s.	S800B								
		Char.	B, C, D, K								
Load s.		Icu [kA]	In [A]								
			32	40	50	63	80	100	125*		
S200M	B	15	6	16	16	16	16	16	16	16	16
			10	16	16	16	16	16	16	16	16
			13	16	16	16	16	16	16	16	16
			16	16	16	16	16	16	16	16	16
			20	16	16	16	16	16	16	16	16
			25		16	16	16	16	16	16	16
			32			16	16	16	16	16	16
			40				16	16	16	16	16
			10	50					16	16	16
				63						16	16

		Supply s.	S800B								
		Char.	B, C, D, K								
Load s.		Icu [kA]	In [A]								
			32	40	50	63	80	100	125*		
S200	C, D K, Z	15	0.5...6	16	16	16	16	16	16	16	16
			8	16	16	16	16	16	16	16	16
			10	16	16	16	16	16	16	16	16
			13	16	16	16	16	16	16	16	16
			16	16	16	16	16	16	16	16	16
			20	16	16	16	16	16	16	16	16
			25		16	16	16	16	16	16	16
			32			16	16	16	16	16	16
			40				16	16	16	16	16
			10	50					16	16	16
	63						16	16	16		

* only S800B-B,C

S800B – SN201 @ 230V (Two-pole circuit-breakers)

		Supply s.	S800B							
		Char.	B, C, D, K							
Load s.		Icu [kA]	In [A]							
			32	40	50	63	80	100	125*	
SN201	B, D	10	6	16	16	16	16	16	16	16
			10	16	16	16	16	16	16	16
			16	16	16	16	16	16	16	16
			20	16	16	16	16	16	16	16
			25		16	16	16	16	16	16
			32			16	16	16	16	16
			40				16	16	16	16

Load s.	Char.	Supply s.		S800B							
		Icu [kA]	In [A]	32	40	50	63	80	100	125*	
SN201	C	10	2	16	16	16	16	16	16	16	16
			4	16	16	16	16	16	16	16	16
			6	16	16	16	16	16	16	16	16
			10	16	16	16	16	16	16	16	16
			13	16	16	16	16	16	16	16	16
			16	16	16	16	16	16	16	16	16
			20	16	16	16	16	16	16	16	16
			25		16	16	16	16	16	16	16
			32			16	16	16	16	16	16
			40					16	16	16	16

Load s.	Char.	Supply s.		S800B							
		Icu [kA]	In [A]	32	40	50	63	80	100	125*	
SN201 L	B, C	6	2	16	16	16	16	15	15	15	
			4	16	16	16	16	15	15	15	
			6	16	16	16	16	15	15	15	
			10	16	16	16	16	15	15	15	
			16	16	16	16	16	15	15	15	
			20	16	16	16	16	15	15	15	
			25		16	16	16	15	15	15	
			32			16	16	15	15	15	
			40					16	15	15	15

Load s.	Char.	Supply s.		S800B						
		Icu [kA]	In [A]	32	40	50	63	80	100	125*
SN201 M	B	10	6	16	16	16	16	16	16	16
			10	16	16	16	16	16	16	16
			16	16	16	16	16	16	16	16
			20	16	16	16	16	16	16	16
			25		16	16	16	16	16	16
			32			16	16	16	16	16
			40					16	16	16

MCBs technical details

Coordination tables: back-up

Load s.	Char.	Supply s.		S800B								
		Icu [kA]	In [A]	B, C, D, K								
				32	40	50	63	80	100	125		
SN201 M	C	10	2	16	16	16	16	16	16	16	16	16
			4	16	16	16	16	16	16	16	16	16
			6	16	16	16	16	16	16	16	16	16
			10	16	16	16	16	16	16	16	16	16
			16	16	16	16	16	16	16	16	16	16
			20	16	16	16	16	16	16	16	16	16
			25		16	16	16	16	16	16	16	16
			32			16	16	16	16	16	16	16
			40					16	16	16	16	16

* only S800B-B,C
back-up values indicated in kA

S800U – S200 @ 230/400 V

Load s.	Char.	Supply s.		S800U								
		Icu [kA]	In [A]	K, Z								
				50	25	32	40	50	63	80	100	125
S200	B	10	6	50	50	50	50	50	50	50	50	50
			10	50	50	50	50	50	50	50	50	50
			13	50	50	50	50	50	50	50	50	50
			16	50	50	50	50	50	50	50	50	50
			20		50	50	50	50	50	50	50	50
			25			50	50	50	50	50	50	50
			32				50	50	50	50	50	50
			40					50	50	50	50	50
			50						50	50	50	50
63								50	50			

Load s.	Char.	Supply s.		S800U								
		Icu [kA]	In [A]	K, Z								
				50	25	32	40	50	63	80	100	125
S200	B	10	0.5..6	50	50	50	50	50	50	50	50	50
			8	50	50	50	50	50	50	50	50	50
			10	50	50	50	50	50	50	50	50	50
			13	50	50	50	50	50	50	50	50	50
			16	50	50	50	50	50	50	50	50	50
			20		50	50	50	50	50	50	50	50
			25			50	50	50	50	50	50	50
			32				50	50	50	50	50	50
			40					50	50	50	50	50
50						50	50	50	50			
63								50	50			

S800U – S200M @ 230/400 V

Load s.	Char.	Supply s.		S800U								
		Icu [kA]	In [A]	K, Z								
				25	32	40	50	63	80	100	125	
S200M	B	15	6...16	50	50	50	50	50	50	50	50	50
			20		50	50	50	50	50	50	50	50
			25			50	50	50	50	50	50	50
			32				50	50	50	50	50	50
			40					50	50	50	50	50
			50						50	50	50	50
			63							50	50	50

Load s.	Char.	Supply s.		S800U								
		Icu [kA]	In [A]	K, Z								
				25	32	40	50	63	80	100	125	
S200M	C	15	0.5...16	50	50	50	50	50	50	50	50	50
			20		50	50	50	50	50	50	50	50
			25			50	50	50	50	50	50	50
			32				50	50	50	50	50	50
			40					50	50	50	50	50
			50						50	50	50	50
			63							50	50	50

S800U – S200P @ 230/400 V

Load s.	Char.	Supply s.		S800U								
		Icu [kA]	In [A]	K, Z								
				25	32	40	50	63	80	100	125	
S200P	B	25	6...16	50	50	50	50	50	50	50	50	50
			20		50	50	50	50	50	50	50	50
			25			50	50	50	50	50	50	50
		15	32				50	50	50	50	50	50
			40					50	50	50	50	50
			50						50	50	50	50
			63							50	50	50

Load s.	Char.	Supply s.		S800U								
		Icu [kA]	In [A]	K, Z								
				25	32	40	50	63	80	100	125	
S200P	C	25	0.5...16	50	50	50	50	50	50	50	50	50
			20		50	50	50	50	50	50	50	50
			25			50	50	50	50	50	50	50
		15	32				50	50	50	50	50	50
			40					50	50	50	50	50
			50						50	50	50	50
			63							50	50	50

MCBs technical details

Coordination tables: back-up

MCCB - MCB @ 415 V

			Supply S.	T1	T1	T1	T2	T3	T4	T2	T3	T4	T2	T4	T2	T4	T4			
			Version	B	C	N				S				H			L	L	V	
Load S.	Char.	In [A]	Icu [kA]	16	25	36				50				70			85	120	200	
S200	B,C,K,Z	0.5..10	10	16	25	30	36	36	36	36	40	40	40	40	40	40	40	40	40	
		13..63																		
S200M	B,C	0.5..10	15	16	25	30	36	36	36	50	40	40	70	40	60	40	60	85	120	200
		13..63																		
S200P	B,C, D,K,Z	0.5..10	25			30	36	36	36	50	40	40	70	40	60	40	60	85	120	200
		13..25																		
		32..63																		
S280	B,C	80, 100	6	16	16	16	36	16	30	36	16	30	36	30	36	30	36	30	30	
S800N	B,C,D	10..125	36							50	50	50	70	70	85	120	200			
S800S	B,C,D,K	10..125	50										70	70	85	120	200			
S800C	B,C,D,K	10..125				36	36	36	36	50	50	50	70	70	85	120	200			

* only for D characteristic

Fuse 125 A gG, gL - RCBO @ 230V

			Supply S.	Fuse 125 A gG, gL																
Load S.	Char.	In [A]	Icu [kA]																	
DS 271	B,C	6-40	10	15																

MCCB - MCB @ 415 V

			Supply s.	XT1	XT2	XT3	XT4	XT1	XT2	XT3	XT4	XT1	XT2	XT4	XT2	XT4	XT2	XT4	
			Version	B	C	N				S				H			L	L	V
Load s.	Carat.	In [A]	Icu [kA]	18	25	36				50				70			120	150	
S200	B,C,K,Z	0.5..10	10	18	25	30	36	36	36	30	36	40	40	30	40	40	40	30	40
		13..63																	
S200M	B,C,D,K,Z	0.5..10	15	18	25	30	36	36	36	30	50	40	40	30	70	40	40	40	30
		13..63																	
S200P	B,C,D,K,Z	0.5..10	25			30	36	36	36	30	50	40	40	30	70	40	60	30	60
		13..25																	
		32..63																	
S280	B,C	80, 100	6	18	16	16	36	16	30	16	36	16	30	16	36	30	36	30	36
S800N	B,C,D	6..125	36							50	50	50	50	70	70	70	120	120	150
S800S	B,C,D,K	6..125	50											70	70	70	120	120	150
S800C	B,C,D,K	10..125				36	36	36	36	50	50	50	50	70	70	70	120	120	150

Tmax - S800B @ 230/400 V

			Supply s.	T1	T1	T1	T2	T3	T4	T2	T3	T4	T2	T4	T2	T4	T4		
			Version	B	C	N				S				H			L	L	V
Load s.	Char.	In [A]	Icu [kA]	16	25	36				50				70			85	120	200
S800B	B, C	32...100	16		25	36	36	36	36	50	50	50	70	70	85	120	200		
	D, K	125*																	

XT – S800B @ 230/400 V

Load s.	Char.	In [A]	Icu [kA]	XT1		XT2		XT3		XT4		XT1		XT2		XT4		XT2		XT4	
				B	C	N	S	H	L	V											
S800B	B, C	32...100	16	18	25	36	36	36	36	50	50	50	50	70	70	70	120	120	150	150	
	D, K	125*		18	25	36	36	36	36	50	50	50	50	70	70	70	120	120	150	150	

Breaking capacities

Definition: B and C acc. to IEC EN 60 898, Icn
K and Z acc. to IEC EN 60 947-2, Icu

Type	Tripping characteristic	Nominal current	AC				DC		Back up protection up to ultimate short-circuit capacity of short-circuit protective device.
			1 phase		2/3 phases		1phase		
			133 V~	230 V~	230 V~ 133/230 V~	400 V~ 230/400 V~	60 V	Fuse	
A	kA/cosφ	kA/cosφ	kA/cosφ	kA/cosφ	kA/T ≤ ms	gG	S700		
S 200-B S 200 M-B	6							63 A	100 A
	10 ... 20		6/0,7		6/0,7			100 A	100 A
	25 ... 32	10/0,5	10/0,5	10/0,5	10/0,5	10/4,0		100 A	100 A
	40		(S 200 M-B)		(S 200 M-B)			125 A	100 A
	50 ... 63							160 A	100 A
S 200-C S 200 M-C	0,5 ... 2	50 kA						not required	
	3 ... 4						20 A	-	
	6						40 A	100 A	
	8		6/0,7		6/0,7		63 A	100 A	
	10 ... 20	10/0,5	10/0,5	10/0,5	10/0,5	10/4,0	100 A	100 A	
	25 ... 32		(S 200 M-C)		(S 200 M-C)		100 A	100 A	
S 200-K S 200 M-K	40						125 A	100 A	
	50 ... 63						160 A	100 A	
	0,5 ... 2	50 kA						not required	
	3						20 A	-	
	4						25 A	-	
	6 ... 10		6/0,7		6/0,7		63 A	100 A	
16 ... 20	10/0,5	10/0,5	10/0,5	10/0,5	10/4,0	80 A	100 A		
25 ... 32		(S 200 M-K)		(S 200 M-K)		100 A	100 A		
S 200-Z S 200 M-Z	40						125 A	100 A	
	50 ... 63						160 A	100 A	
	0,5 ... 2	50 kA						not required	
	3 ... 4						20 A	-	
	6						35 A	100 A	
	8		6/0,7		6/0,7		40 A	100 A	
10 ... 16	10/0,5	10/0,5	10/0,5	10/0,5	10/4,0	63 A	100 A		
20 ... 25		(S 200 M-Z)		(S 200 M-Z)		80 A	100 A		
32 ... 40						100 A	100 A		
50 ... 63						125 A	100 A		

10

1. In symmetrically earthed DC networks 2 pole MCBs can be applied at up to 125 V DC (series connection). In this case the breaking capacity is one level higher compared to an equivalent 1 pole installation. Polarity does not have to be considered. Thus any connection mode is permitted.
2. Back up protection is only required when the prospective short circuit current exceeds the rated breaking capacity.

MCBs technical details

Coordination tables: back-up

Breaking capacities

Definition: B and C acc. to IEC EN 60 898, Icn
K and Z acc. to IEC EN 60 947-2, Icu

Type Tripping characteristic Nominal current	AC				DC		Back up protection up to ultimate short-circuit capacity of short-circuit protective device.	
	1 phase		2/3 phases		1phase		Fuse	Selective MCB
	133 V~	230 V~	230 V~ 133/230 V~	400 V~ 230/400 V~	60 V $\overline{\text{---}}$	kA/T ≤ ms		
A	kA/cosj	kA/cosj	kA/cosj	kA/cosj	kA/T ≤ ms	gG	S700	
S 200 P-B	6				10/4,0	63 A	100 A	
	10, 13	25/0,25	25/0,25	25/0,25	25/0,25	80 A	100 A	
	16 ... 25				15/4,0	100 A	100 A	
	32 ... 40	15/0,25	15/0,25	15/0,25	15/0,25	125 A	100 A	
	50 ... 63				10/4,0	160 A	100 A	
S 200 P-C	0,5 ... 2	50 kA					not required	
	3, 4					32 A	100 A	
	6, 8	25/0,25	25/0,25	25/0,25	25/0,25	10/4,0	63 A	100 A
	10 ... 13					80 A	100 A	
	16 ... 25					15/4,0	100 A	100 A
	32 ... 40	15/0,25	15/0,25	15/0,25	15/0,25	125 A	100 A	
	50 ... 63				10/4,0	160 A	100 A	
S 200 P-K, Z	0,5 ... 2	50 kA					not required	
	3					25 A	–	
	4				10/4,0	35 A	–	
	6	25/0,25	25/0,25	25/0,25	25/0,25	63 A	100 A	
	8					80 A	100 A	
	10 ... 20				15/4,0	100 A	100 A	
	25				15/4,0	125 A	100 A	
	32 ... 63	15/0,25	15/0,25	15/0,25	15/0,25	10/4,0	160 A	100 A

1. In symmetrically earthed DC networks 2 pole MCBs can be applied at up to 125 V DC (series connection). Polarity does not have to be considered. Thus any connection mode is permitted.
2. Back up protection is only required when the prospective short circuit current exceeds the rated breaking capacity.

Fuse gG - MCB S 200, S 200 M

240 V		Supply s.	Fuse gG	S 700
Load s.	Characteristic	In [A]	In [A]	In [A]
S200 S200 M	B	6	63	100
		10...20	100	100
		25...32	100	100
		40	125	100
		50...63	160	100
S200 S200 M	C	3..4	20	—
		6	40	100
		8	63	100
		10...20	100	100
		25...32	100	100
		40	125	100
S200	K	3	20	—
		4	25	—
		6...10	63	100
		16...20	80	100
		25...32	100	100
		40	125	100
		50...63	160	100
S200	Z	3..4	20	—
		6	35	100
		8	40	100
		10...16	63	100
		20...25	80	100
		32...40	100	100
		50...63	125	100

10

This table shows coordination between an MCB and the upstream fuse maximum current value. Combination of the two protections allows the breaking capacity to be elevated up to that of the combined fuse.
 I.e. downstream MCB breaker S 201-C16, upstream fuse with In up to 100 A (breaking capacity: 100 kA). MCB breaker protection up to 100 kA.

MCBs technical details

Coordination tables: back-up

Fuse gG - MCB S 200 P

240 V		Supply s.	Fuse gG	S 700
Load s.	Characteristic	In [A]	In [A]	In [A]
S200 P	B	6	63	100
		10, 13	80	100
		16...25	100	100
		32...40	125	100
		50...63	160	100
S200 P	C	3, 4	40	100
		6, 8	63	100
		10, 13	100	100
		16...25	100	100
		32...40	125	100
S200 P	K, Z	3	25	—
		4	35	—
		6	63	100
		8	80	100
		10...20	100	100
		25	125	100
		32...63	160	100

This table shows coordination between an MCB and the upstream fuse maximum current value. Combination of the two protections allows the breaking capacity to be elevated up to that of the combined fuse.
 I.e. downstream MCB breaker S 201-C16, upstream fuse with In up to 100 A (breaking capacity: 100 kA). MCB breaker protection up to 100 kA.

Short circuit breaking capacity, S 280 UC

Operating sequence for B according to IEC/EN 60 898-2 for K according to IEC/EN 60 947-2.

time constant $T = L/R \leq 4$ ms applies, in the case of AC for 10 kA: $\cos \varphi$ 0.6 for 6 kA: $\cos \varphi$ 0.7 – for 4.5 kA and for 3 kA: $\cos \varphi$ 0.8 – for < 3 kA: $\cos \varphi$ 0.9.

For the short circuit capacity indicated, in the case of DC, a

S 280 UC		1-pole			2-pole				max. backup protect. ⑤ for backup protect.; utilization category gG according IEC/EN 60 269-1
		up to 60 V ...	110 V ...	220 V ...	up to 60 V ...	110 V ...	220 V ...	440 V ...	
DC									
B	6 ... 25 A	14 kA	10 kA	6 kA	25 kA	20 kA	10 kA	6 kA	100 A
Z, K	0.2 ... 2 A f	unlimited	unlimited	unlimited	unlimited	unlimited	unlimited	unlimited	not required
Z, K	3 ... 4 A	14 kA	10 kA	6 kA	25 kA	20 kA	10 kA	6 kA	35 A
Z, K	6 ... 8 A	14 kA	10 kA	6 kA	25 kA	20 kA	10 kA	6 kA	63 A
Z, K	10 ... 40 A	14 kA	10 kA	6 kA	25 kA	20 kA	10 kA	6 kA	100 A
Z, K	50 ... 63 A	10 kA	6 kA	4.5 kA	20 kA	14 kA	6 kA	4,5 kA	125 A
AC									
B	6 ... 25 A	10 kA	10 kA	6 kA	10 kA	10 kA	10 kA	6 kA	100 A
Z, K	0.2 ... 2 A f	unlimited	unlimited	unlimited	unlimited	unlimited	unlimited	unlimited	not required
Z, K	3 ... 4 A	10 kA	10 kA	6 kA	10 kA	10 kA	10 kA	6 kA	35 A
Z, K	6 ... 8 A	10 kA	10 kA	6 kA	10 kA	10 kA	10 kA	6 kA	63 A
Z, K	10 ... 40 A	10 kA	10 kA	6 kA	10 kA	10 kA	10 kA	6 kA	100 A
Z, K	50 ... 63 A	6 kA	6 kA	4,5 kA	10 kA	6 kA	6 kA	4,5 kA	125 A

⑤ Back-up protection is necessary only if the solid short-circuit current to be expected at the place of installation may exceed the short circuit rupturing indicated.

⑥ Z as of 0.5 A

MCBs technical details

Coordination tables: selectivity

Selective protection

Selectivity between SN 201 and S 200 upstream and downstream modular circuit-breakers
 In the case, selectivity is amperometric and so the selectivity

limit is given simply by the magnetic threshold of the upstream breaker, which is fixed. The selectivity value is obtained if a minimum ratio of 1.3 ($I_n \text{ upstream} / I_n \text{ downstream} > 1.3$) is observed between the rated currents of the two breakers.

MCB - SN201 @ 230/240 V

Load S.1	Supply S.2		S800 N-S								
	Char.	Icu [kA]	B								
			In [A]	25	32	40	50	63	80	100	125
SN201 L	B, C	6	2		0.433	0.6	1.3	4	T	T	T
			4			0.45	0.8	1.5	2.5	4	T
			6				0.6	1.2	1.6	2.6	3.8
			10				0.5	1.1	1.4	2	3
			16					0.8	1.2	1.7	2.5
			20						1	1.5	2.1
			25							1.3	1.8
			32							1.1	1.7
			40								1.6
			SN201	B, C, D	10	2		0.433	0.6	1.3	4
4						0.45	0.8	1.5	2.5	4	7.3
6							0.6	1.2	1.6	2.6	3.8
10							0.5	1.1	1.4	2	3
16								0.8	1.2	1.7	2.5
20									1	1.5	2.1
25										1.3	1.8
32										1.1	1.7
40											1.6
SN201 M	B, C	10				2		0.433	0.6	1.3	4
			4			0.45	0.8	1.5	2.5	4	7.3
			6				0.6	1.2	1.6	2.6	3.8
			10				0.5	1.1	1.4	2	3
			16					0.8	1.2	1.7	2.5
			20						1	1.5	2.1
			25							1.3	1.8
			32							1.1	1.7
			40								1.6

¹ Load side circuit-breaker 1P+N (230/240 V)

² For networks with 230/240 V AC two-pole circuit-breaker (phase + neutral)

for networks at 400/415 V AC four-pole circuit-breaker (load side circuit branched between one phase and the neutral)

³ Only for curve B

10

Example

Upstream circuit-breaker	S 200 P, curve D 50 A
Downstream circuit-breaker	SN 201 L, curve B 10 A
Selectivity limit	10 I _n =500 A

S800 N-S									S800 N-S							
C									D							
36-50									36-50							
25	32	40	50	63	80	100	125		25	32	40	50	63	80	100	125
0.43	0.55	1.2	3	T	T	T	T		1.3	4.1	T	T	T	T	T	T
	0.43	0.75	1.3	2.1	3.9	T	T		0.8	1.6	3	5.4	T	T	T	T
		0.55	1.1	1.5	2.5	3.6	5.5		0.6	1.3	2	3.2	3.9	T	T	T
		0.45	1	1.3	1.9	2.8	4.2		0.5	1.2	1.65	2.6	3.1	T	T	T
			0.75	1.1	1.6	2.3	3.6			0.9	1.4	1.8	2.6	5	T	T
				0.9	1.4	1.9	3.3				1.3	1.6	2.2	4.2	5.4	T
					1.2	1.6	2.7					1.5	1.9	3.5	4.5	T
					1	1.5	2.5						1.8	2.8	4.2	5.5
						1.4	2.1						1.7	2.7	4	5
0.43	0.55	1.2	3	6.6	T	T	T		1.3	4.1	T	T	T	T	T	T
	0.43	0.75	1.3	2.1	3.9	6.6	T		0.8	1.6	3	5.4	7.6	T	T	T
		0.55	1.1	1.5	2.5	3.6	5.5		0.6	1.3	2	3.2	3.9	8	T	T
		0.45	1	1.3	1.9	2.8	4.2		0.5	1.2	1.65	2.6	3.1	6.2	8.6	T
			0.75	1.1	1.6	2.3	3.6			0.9	1.4	1.8	2.6	5	6.3	8.8
				0.9	1.4	1.9	3.3				1.3	1.6	2.2	4.2	5.4	7.6
					1.2	1.6	2.7					1.5	1.9	3.5	4.5	6.6
					1	1.5	2.5						1.8	2.8	4.2	5.5
						1.4	2.1						1.7	2.7	4	5
0.43	0.55	1.2	3	6.6	T	T	T		1.3	4.1	T	T	T	T	T	T
	0.43	0.75	1.3	2.1	3.9	6.6	T		0.8	1.6	3	5.4	7.6	T	T	T
		0.55	1.1	1.5	2.5	3.6	5.5		0.6	1.3	2	3.2	3.9	8	T	T
		0.45	1	1.3	1.9	2.8	4.2		0.5	1.2	1.65	2.6	3.1	6.2	8.6	T
			0.75	1.1	1.6	2.3	3.6			0.9	1.4	1.8	2.6	5	6.3	8.8
				0.9	1.4	1.9	3.3				1.3	1.6	2.2	4.2	5.4	7.6
					1.2	1.6	2.7					1.5	1.9	3.5	4.5	6.6
					1	1.5	2.5						1.8	2.8	4.2	5.5
						1.4	2.1						1.7	2.7	4	5

MCBs technical details

Coordination tables: selectivity

Fuse - SN201 @ 230/240 V

	Im	Icu [kA]	In [A]	I _n [A]							
				25	32	40	50	63	80	100	125
SN201 L	B-C	6	2	1.5	2.5	T	T	T	T	T	T
		6	4	1	2	4.5	T	T	T	T	T
		6	6	1	1.5	4	4.5	T	T	T	T
		6	10		1.2	3.5	4	T	T	T	T
		6	16		1	3	3.5	5	T	T	T
		6	20		1	3	3.5	5	T	T	T
		6	25		1	2	3	4.5	T	T	T
		6	32		1	2	3	4.5	5	T	T
		6	40			1.5	2.5	4	5	T	T
SN201	B-C-D	10	2	1.5	2.5	5	T	T	T	T	T
		10	4	1	2	4.5	5	T	T	T	T
		10	6	1	1.5	4	4.5	7	T	T	T
		10	10		1.2	3.5	4	6	T	T	T
		10	16		1	3	3.5	5	T	T	T
		10	20		1	3	3.5	5	8	T	T
		10	25		1	2	3	4.5	6.5	T	T
		10	32		1	2	3	4.5	5	8	T
		10	40			1.5	2.5	4	5	6.5	T
SN201 M	B-C	10	2	1.5	2.5	5	7	T	T	T	T
		10	4	1	2	4.5	5	8	T	T	T
		10	6	1	1.5	4	4.5	7	T	T	T
		10	10		1.2	3.5	4	6	T	T	T
		10	16		1	3	3.5	5	9	T	T
		10	20		1	3	3.5	5	8	T	T
		10	25		1	2	3	4.5	6.5	9	T
		10	32		1	2	3	4.5	5	8	T
		10	40			1.5	2.5	4	5	6.5	9

10

MCB S700 - SN201 @ 230/240 V

	Im	Icu [kA]	In [A]	E	E	E	E	E	E	E	E
				25	25	25	25	25	25	25	25
				20	25	35	40	50	63	80	100
SN201 L	B-C	6	2	T	T	T	T	T	T	T	T
		6	4	T	T	T	T	T	T	T	T
		6	6	T	T	T	T	T	T	T	T
		6	10	T	T	T	T	T	T	T	T
		6	16		T	T	T	T	T	T	T
		6	20			T	T	T	T	T	T
		6	25			T	T	T	T	T	T
		6	32					T	T	T	T
		6	40						T	T	T
SN201	B-C-D	10	2	T	T	T	T	T	T	T	T
		10	4	T	T	T	T	T	T	T	T
		10	6	T	T	T	T	T	T	T	T
		10	10	T	T	T	T	T	T	T	T
		10	16		T	T	T	T	T	T	T
		10	20			T	T	T	T	T	T
		10	25			T	T	T	T	T	T
		10	32					T	T	T	T
		10	40						T	T	T
SN201 M	B-C	10	2	T	T	T	T	T	T	T	T
		10	4	T	T	T	T	T	T	T	T
		10	6	T	T	T	T	T	T	T	T
		10	10	T	T	T	T	T	T	T	T
		10	16		T	T	T	T	T	T	T
		10	20			T	T	T	T	T	T
		10	25			T	T	T	T	T	T
		10	32					T	T	T	T
		10	40						T	T	T

MCBs technical details

Coordination tables: selectivity

MCCB @ 415 V 4P - SN201/DS201/DS202C @ 240 V

			Supply S.	T1													T2					
			Version	B, C, N													N, S, H, L					
			Release	TMD													TMD, MA					
			Iu [A]	160													160					
Load S.	Char.	Icu [kA]	In [A]	16	20	25	32	40	50	63	80	100	125	160	160	16	20	25	32	40	50	
SN201 L DS201 L	B, C	6	≤4	T	T	T	T	T	T	T	T	T	T	T	T	T	T	T	T	T	T	T
	B, C		6	T	T	T	T	T	T	T	T	T	T	T	T	T	T	T	T	T	T	T
	B, C		10			3	3	3	4.5	T	T	T	T	T	T		31	3	3	3	3	4.5
	B, C		16					3	4.5	5	T	T	T	T	T					31	3	4.5
	B, C		20						3	5	T	T	T	T	T					31		3
	B, C		25							5	T	T	T	T	T							31
	B, C		32								T	T	T	T	T							31
	B, C		40									T	T	T	T							
SN201 DS201 DS202C	B, C, D, K	10	≤4	T	T	T	T	T	T	T	T	T	T	T	T	T	T	T	T	T	T	T
	B, C, D, K		6	6	6	6	6	6	6	T	T	T	T	T	T	T	T	T	T	T	T	T
	B, C, D, K		8			3	3	3	4.5	7.5	8.5	T	T	T	T	T		31	3	3	3	4.5
	B, C, D, K		10			3	3	3	4.5	7.5	8.5	T	T	T	T	T		31	3	3	3	4.5
	B, C, D, K		13					3	4.5	5	7.5	T	T	T	T	T				31	3	4.5
	B, C, D, K		16					3	4.5	5	7.5	T	T	T	T	T				31	3	4.5
	B, C, D, K		20						3	5	6	T	T	T	T	T				31		3
	B, C, D, K		25							5	6	T	T	T	T	T						31
B, C, D, K	32								6	7.5	T	T	T	T						31		
B, C, D, K	40									7.5	T	T	T	T								
SN201 M DS201 M DS202C M	B, C	10	≤4	T	T	T	T	T	T	T	T	T	T	T	T	T	T	T	T	T	T	T
	B, C		6	6	6	6	6	6	6	12	T	T	T	T	T	T	T	T	T	T	T	T
	B, C		10			3	3	3	4.5	7.5	8.5	T	T	T	T	T		31	3	3	3	4.5
	B, C		13					3	4.5	5	7.5	T	T	T	T	T				31	3	4.5
	B, C		16					3	4.5	5	7.5	T	T	T	T	T				31	3	4.5
	B, C		20						3	5	6	T	T	T	T	T				31		3
	B, C		25							5	6	T	T	T	T	T						31
	B, C		32								6	7.5	T	T	T	T						31
B, C	40									7.5	T	T	T	T								

10

													T3														
													N, S														
													EL		TMD, MA												
															250												
63	80	100	1252	125	1602	160	10	25	63	100	160	63	80	100	1252	125	1602	160	2002	200	2502	250					
T	T	T	T	T	T	T	T	T	T	T	T	T	T	T	T	T	T	T	T	T	T	T					
T	T	T	T	T	T	T	T	T	T	T	T	T	T	T	T	T	T	T	T	T	T	T					
T	T	T	T	T	T	T	T	T	T	T	T	T	T	T	T	T	T	T	T	T	T	T					
5	T	T	T	T	T	T	T	T	T	T	T	5	T	T	T	T	T	T	T	T	T	T					
5	T	T	T	T	T	T	T	T	T	T	T	5	T	T	T	T	T	T	T	T	T	T					
5	T	T	T	T	T	T	T	T	T	T	T	5	T	T	T	T	T	T	T	T	T	T					
	T	T	T	T	T	T	T	T	T	T	T		T	T	T	T	T	T	T	T	T	T					
	T	T	T	T	T	T	T	T	T	T	T		T	T	T	T	T	T	T	T	T	T					
T	T	T	T	T	T	T	T	T	T	T	T	T	T	T	T	T	T	T	T	T	T	T					
T	T	T	T	T	T	T	T	T	T	T	T	T	T	T	T	T	T	T	T	T	T	T					
7.5	8.5	T	T	T	T	T	T	T	T	T	T	7.5	8.5	T	T	T	T	T	T	T	T	T					
7.5	8.5	T	T	T	T	T	T	T	T	T	T	7.5	8.5	T	T	T	T	T	T	T	T	T					
5	7.5	T	7.5	T	T	T	T	T	T	T	T	5	7.5	T	7.5	T	T	T	T	T	T	T					
5	7.5	T	7.5	T	T	T	T	T	T	T	T	5	7.5	T	7.5	T	T	T	T	T	T	T					
5	6	T	6	T	T	T	T	T	T	T	T	5	6	T	6	T	T	T	T	T	T	T					
5	6	T	6	T	T	T	T	T	T	T	T	5	6	T	6	T	T	T	T	T	T	T					
	6	7.5	6	T	T	T	T	T	T	T	T		6	7.5	6	T	T	T	T	T	T	T					
	61	7.5	6	T	T	T	T	T	T	T	T		61	7.5		T	T	T	T	T	T	T					
T	T	T	T	T	T	T	T	T	T	T	T	T	T	T	T	T	T	T	T	T	T	T					
T	T	T	T	T	T	T	T	T	T	T	T	T	T	T	T	T	T	T	T	T	T	T					
7.5	8.5	T	T	T	T	T	T	T	T	T	T	7.5	8.5	T	T	T	T	T	T	T	T	T					
5	7.5	T	7.5	T	T	T	T	T	T	T	T	5	7.5	T	7.5	T	T	T	T	T	T	T					
5	7.5	T	7.5	T	T	T	T	T	T	T	T	5	7.5	T	7.5	T	T	T	T	T	T	T					
5	6	T	6	T	T	T	T	T	T	T	T	5	6	T	6	T	T	T	T	T	T	T					
5	6	T	6	T	T	T	T	T	T	T	T	5	6	T	6	T	T	T	T	T	T	T					
	6	7.5	6	T	T	T	T	T	T	T	T		6	7.5	6	T	T	T	T	T	T	T					
	61	7.5	6	T	T	T	T	T	T	T	T		61	7.5		T	T	T	T	T	T	T					

MCBs technical details

Coordination tables: selectivity

S800S - S200 @ 230/400 V

		E.	S800S								
		Char.	B								
L.		Icu [kA]	50								
		In [A]	25	32	40	50	63	80	100	125	
S200	B	10	6			0.4	0.5	0.7	1	1.5	2.6
			10				0.4	0.6	0.7	1	1.4
			13					0.5	0.7	0.9	1.3
			16						0.7	0.9	1.3
			20							0.9	1.3
			25							0.9	1.3
			32							0.8	1.1
			40							0.8	1.1
			50								1
			63								

		E.	S800S									
		Char.	B									
L.		Icu [kA]	50									
		In [A]	25	32	40	50	63	80	100	125		
S200	C	10	0.5	T	T	T	T	T	T	T	T	
			1	3.3	T	T	T	T	T	T	T	
			1.6	0.6	1.3	T	T	T	T	T	T	
			2	0.4	0.7	1.3	T	T	T	T	T	
			3		0.4	0.6	0.7	1.1	2.6	T	T	
			4		0.4	0.6	0.7	1	1.7	3.1	T	
			6			0.4	0.5	0.7	1	1.5	2.6	
			8				0.4	0.6	0.7	1	1.4	
			10					0.4	0.6	0.7	1	1.4
			13						0.5	0.7	0.9	1.3
			16							0.7	0.9	1.3
			20								0.9	1.3
			25								0.9	1.3
			32								0.8	1.1
			40								0.8	1.1
			50									1
63										0.9		

E. = feed side
 L. = load side
 T = Total selectivity up to breaking capacity of the switch on load side
 Selectivity limit values indicated in kA

		E.	S800S								
		Char.	B								
L.		Icu [kA]	50								
		In [A]	25	32	40	50	63	80	100	125	
S200	D	10	0.5	T	T	T	T	T	T	T	T
			1	0.8	4.5	T	T	T	T	T	T
			1.6	0.5	1	2.3	T	T	T	T	T
			2	0.3	0.5	0.7	2.3	T	T	T	T
			3		0.4	0.5	0.7	1.2	2.5	T	T
			4		0.4	0.4	0.7	1	1.7	3	T
			6				0.6	0.8	1.2	2	3.6
			8					0.7	0.9	1.3	2
			10						0.9	1.3	2
			13							1	1.5
			16								1.5
			20								
			25								
			32								
			40								
50											
63											

		E.	S800S								
		Char.	B								
L.		Icu [kA]	50								
		In [A]	25	32	40	50	63	80	100	125	
S200	K	10	0.5	T	T	T	T	T	T	T	T
			1	0.8	5	T	T	T	T	T	T
			1.6	0.5	1	2.1	T	T	T	T	T
			2	0.3	0.5	0.7	2.1	T	T	T	T
			3		0.4	0.5	0.7	1.2	2.5	T	T
			4		0.4	0.4	0.7	1	1.7	3	T
			6				0.6	0.8	1.2	2	3.6
			8					0.7	0.9	1.3	2
			10						0.9	1.3	2
			13							1	1.5
			16								1.5
			20								
			25								
			32								
			40								
50											
63											

10

E. = feed side
L. = load side
T = Total selectivity up to breaking capacity of the switch on load side
Selectivity limit values indicated in kA

MCBs technical details

Coordination tables: selectivity

		E.	S800S								
		Char.	C								
L.		Icu [kA]	50								
		In [A]	25	32	40	50	63	80	100	125	
S200	B	10	6		0.4	0.5	0.7	0.9	1.4	2.4	4.8
			10		0.3	0.4	0.5	0.7	0.9	1.3	2
			13		0.3	0.4	0.5	0.7	0.9	1.3	1.9
			16		0.3	0.4	0.5	0.7	0.9	1.3	1.9
			20			0.4	0.5	0.7	0.9	1.2	1.8
			25			0.4	0.5	0.7	0.9	1.2	1.8
			32				0.5	0.6	0.8	1	1.4
			40					0.6	0.8	1	1.4
			50						0.7	0.9	1.3
			63							0.9	1.2

		E.	S800S								
		Char.	C								
L.		Icu [kA]	50								
		In [A]	25	32	40	50	63	80	100	125	
S200	C	10	0.5	T	T	T	T	T	T	T	T
			1	T	T	T	T	T	T	T	T
			1.6	0.6	T	T	T	T	T	T	T
			2	0.5	1	T	T	T	T	T	T
			3	0.3	0.5	0.7	1.2	2.1	T	T	T
			4	0.3	0.4	0.7	1	1.5	2.6	T	T
			6		0.4	0.5	0.7	0.9	1.4	2.4	4.8
			8		0.3	0.4	0.5	0.7	0.9	1.3	2
			10		0.3	0.4	0.5	0.7	0.9	1.3	2
			13		0.3	0.4	0.5	0.7	0.9	1.3	1.9
			16		0.3	0.4	0.5	0.7	0.9	1.3	1.9
			20			0.4	0.5	0.7	0.9	1.2	1.8
			25			0.4	0.5	0.7	0.9	1.2	1.8
			32				0.5	0.6	0.8	1	1.4
			40					0.6	0.8	1	1.4
			50						0.7	0.9	1.3
			63							0.9	1.2

E. = feed side
 L. = load side
 T = Total selectivity up to breaking capacity of the switch on load side
 Selectivity limit values indicated in kA

		E.		S800S							
		C									
L.	Char.	Icu [kA]	In [A]	25	32	40	50	63	80	100	125
S200	D	10	0.5	T	T	T	T	T	T	T	T
			1	2.1	T	T	T	T	T	T	T
			1.6	0.8	2.3	T	T	T	T	T	T
			2	0.4	0.7	2.3	T	T	T	T	T
			3	0.3	0.5	0.7	1.2	2.2	T	T	T
			4	0.3	0.4	0.7	1	1.4	2.6	T	T
			6		0.4	0.6	0.8	1.1	1.8	3.2	T
			8			0.5	0.7	0.9	1.2	1.8	2.8
			10				0.7	0.9	1.2	1.8	2.8
			13					0.7	1	1.4	2
			16						1	1.4	2
			20							1	1.4
			25								1.4
			32								
			40								
			50								
63											

		E.		S800S							
		C									
L.	Char.	Icu [kA]	In [A]	25	32	40	50	63	80	100	125
S200	K	10	0.5	T	T	T	T	T	T	T	T
			1	2.1	T	T	T	T	T	T	T
			1.6	0.8	2.3	T	T	T	T	T	T
			2	0.4	0.7	2.3	T	T	T	T	T
			3	0.3	0.5	0.7	1.2	2.2	T	T	T
			4	0.3	0.4	0.7	1	1.4	2.6	T	T
			6		0.4	0.6	0.8	1.1	1.8	3.2	T
			8			0.5	0.7	0.9	1.2	1.8	2.8
			10				0.7	0.9	1.2	1.8	2.8
			13					0.7	1	1.4	2
			16						1	1.4	2
			20							1	1.4
			25								1.4
			32								
			40								
			50								
63											

10

E. = feed side
L. = load side
T = Total selectivity up to breaking capacity of the switch on load side
Selectivity limit values indicated in kA

MCBs technical details

Coordination tables: selectivity

		E.	S800S								
		Char:	D								
L.		Icu [kA]	50								
		In [A]	25	32	40	50	63	80	100	125	
S200	B	10	6	0.5	1	1.2	2	2.8	T	T	T
			10	0.4	0.6	0.8	1.1	1.4	2.8	3.9	T
			13	0.4	0.6	0.8	1.1	1.4	2.5	3.3	T
			16		0.6	0.8	1.1	1.4	2.5	3.3	5.6
			20			0.8	1.1	1.3	2.3	3	4.7
			25			0.8	1.1	1.3	2.3	3	4.7
			32				0.9	1.1	1.9	2.4	3.7
			40					1.1	1.9	2.4	3.7
			50						1.5	1.9	2.3
			63							1.7	2.3

		E.	S800S								
		Char:	D								
L.		Icu [kA]	50								
		In [A]	25	32	40	50	63	80	100	125	
S200	C	10	0.5	T	T	T	T	T	T	T	T
			1	T	T	T	T	T	T	T	T
			1.6	T	T	T	T	T	T	T	T
			2	T	T	T	T	T	T	T	T
			3	0.7	2.2	4.4	T	T	T	T	T
			4	0.7	1.3	2.2	4.4	T	T	T	T
			6	0.5	1	1.2	2	2.8	T	T	T
			8	0.4	0.6	0.8	1.1	1.4	2.8	3.9	T
			10	0.4	0.6	0.8	1.1	1.4	2.8	3.9	T
			13	0.4	0.6	0.8	1.1	1.4	2.5	3.3	5.6
			16		0.6	0.8	1.1	1.4	2.5	3.3	5.6
			20			0.8	1.1	1.3	2.3	3	4.7
			25			0.8	1.1	1.3	2.3	3	4.7
			32				0.9	1.1	1.9	2.4	3.7
			40					1.1	1.9	2.4	3.7
			50						1.5	1.9	2.3
			63							1.7	2.3

E. = feed side
 L. = load side
 T = Total selectivity up to breaking capacity of the switch on load side
 Selectivity limit values indicated in kA

		E.		S800S								
		Char:		D								
L.		Icu [kA]	50									
			In [A]	25	32	40	50	63	80	100	125	
S200	D	10	0.5	T	T	T	T	T	T	T	T	T
			1	T	T	T	T	T	T	T	T	T
			1.6	T	T	T	T	T	T	T	T	T
			2	2.3	T	T	T	T	T	T	T	T
			3	0.7	1.3	4.4	T	T	T	T	T	T
			4	0.7	1	2.2	4.4	T	T	T	T	T
			6	0.6	0.8	1.5	2.5	3.6	T	T	T	T
			8	0.5	0.7	1.1	1.5	2	4	5.5	T	T
			10	0.5	0.7	1.1	1.5	2	4	5.5	T	T
			13		0.6	0.9	1.2	1.5	2.6	3.4	5.2	T
			16			0.9	1.2	1.5	2.6	3.4	5.2	T
			20				0.9	1.1	1.8	2.2	3.2	T
			25					1.1	1.8	2.2	3.2	T
			32						1.7	2	2.9	T
			40							1.9	2.6	T
			50								2.2	T
63									T			

		E.		S800S								
		Char:		D								
L.		Icu [kA]	50									
			In [A]	25	32	40	50	63	80	100	125	
S200	K	10	0.5	T	T	T	T	T	T	T	T	T
			1	T	T	T	T	T	T	T	T	T
			1.6	T	T	T	T	T	T	T	T	T
			2	2.3	T	T	T	T	T	T	T	T
			3	0.7	1.3	4.4	T	T	T	T	T	T
			4	0.7	1	2.2	4.4	T	T	T	T	T
			6	0.6	0.8	1.5	2.5	3.6	T	T	T	T
			8	0.5	0.7	1.1	1.5	2	4	5.5	T	T
			10	0.5	0.7	1.1	1.5	2	4	5.5	T	T
			13		0.6	0.9	1.2	1.5	2.6	3.4	5.2	T
			16			0.9	1.2	1.5	2.6	3.4	5.2	T
			20				0.9	1.1	1.8	2.2	3.2	T
			25					1.1	1.8	2.2	3.2	T
			32						1.7	2	2.9	T
			40							1.9	2.6	T
			50								2.2	T
63									T			

10

E. = feed side
L. = load side
T = Total selectivity up to breaking capacity of the switch on load side
Selectivity limit values indicated in kA

MCBs technical details

Coordination tables: selectivity

S800S - S200 M @ 230/400 V

		E.	S800S								
		Char.	B								
L.		Icu [kA]	50								
		In [A]	25	32	40	50	63	80	100	125	
S200M	B	15	6			0.4	0.5	0.7	1	1.5	2.6
			10				0.4	0.6	0.7	1	1.4
			13					0.5	0.7	0.9	1.3
			16						0.7	0.9	1.3
			20							0.9	1.3
			25							0.9	1.3
			32							0.8	1.1
			40							0.8	1.1
			50								1
			63								

		E.	S800S								
		Char.	B								
L.		Icu [kA]	50								
		In [A]	25	32	40	50	63	80	100	125	
S200M	C	15	0.5	T	T	T	T	T	T	T	T
			1	3.3	T	T	T	T	T	T	T
			1.6	0.6	1.3	T	T	T	T	T	T
			2	0.4	0.7	1.3	T	T	T	T	T
			3		0.4	0.6	0.7	1.1	2.6	8.8	T
			4		0.4	0.6	0.7	1	1.7	3.1	7
			6			0.4	0.5	0.7	1	1.5	2.6
			8				0.4	0.6	0.7	1	1.4
			10				0.4	0.6	0.7	1	1.4
			13					0.5	0.7	0.9	1.3
			16						0.7	0.9	1.3
			20							0.9	1.3
			25							0.9	1.3
			32							0.8	1.1
			40							0.8	1.1
			50								1
63									0.9		

E. = feed side
 L. = load side
 T = Total selectivity up to breaking capacity of the switch on load side
 Selectivity limit values indicated in kA

		E.		S800S								
Char.		B										
L.	Icu [kA]	In [A]	50									
			25	32	40	50	63	80	100	125		
S200M	D	15	0.5	T	T	T	T	T	T	T	T	T
			1	0.8	5	T	T	T	T	T	T	T
			1.6	0.5	1	2.3	T	T	T	T	T	T
			2	0.3	0.5	0.7	2.3	T	T	T	T	T
			3		0.4	0.5	0.7	1.2	2.5	8.6	T	
			4		0.4	0.4	0.7	1	1.7	3	7.7	
			6				0.6	0.8	1.2	2	3.6	
			8					0.7	0.9	1.3	2	
			10						0.9	1.3	2	
			13							1	1.5	
			16								1.5	
			20									
			25									
			32									
			40									
50												
63												

		E.		S800S								
Char.		B										
L.	Icu [kA]	In [A]	50									
			25	32	40	50	63	80	100	125		
S200M	K	15	0.5	T	T	T	T	T	T	T	T	T
			1	0.8	5	T	T	T	T	T	T	T
			1.6	0.5	1	2.3	T	T	T	T	T	T
			2	0.3	0.5	0.7	2.3	T	T	T	T	T
			3		0.4	0.5	0.7	1.2	2.5	8.6	T	
			4		0.4	0.4	0.7	1	1.7	3	7.7	
			6				0.6	0.8	1.2	2	3.6	
			8					0.7	0.9	1.3	2	
			10						0.9	1.3	2	
			13							1	1.5	
			16								1.5	
			20									
			25									
			32									
			40									
50												
63												

10

E. = feed side
L. = load side
T = Total selectivity up to breaking capacity of the switch on load side
Selectivity limit values indicated in kA

MCBs technical details

Coordination tables: selectivity

		E.	S800S								
Char.		C									
L.	Icu [kA]	In [A]	25	32	40	50	63	80	100	125	
S200M	B	15	6		0.4	0.5	0.7	0.9	1.4	2.4	4.8
			10		0.3	0.4	0.5	0.7	0.9	1.3	2
			13		0.3	0.4	0.5	0.7	0.9	1.3	1.9
			16		0.3	0.4	0.5	0.7	0.9	1.3	1.9
			20			0.4	0.5	0.7	0.9	1.2	1.8
			25			0.4	0.5	0.7	0.9	1.2	1.8
			32				0.5	0.6	0.8	1	1.4
			40					0.6	0.8	1	1.4
			50						0.7	0.9	1.3
			63							0.9	1.2

		E.	S800S								
Char.		C									
L.	Icu [kA]	In [A]	25	32	40	50	63	80	100	125	
S200M	C	15	0.5	T	T	T	T	T	T	T	T
			1	T	T	T	T	T	T	T	T
			1.6	0.6	T	T	T	T	T	T	T
			2	0.5	1	T	T	T	T	T	T
			3	0.3	0.5	0.7	1.2	2.1	6.4	T	T
			4	0.3	0.4	0.7	1	1.5	2.6	6.1	T
			6		0.4	0.5	0.7	0.9	1.4	2.4	4.8
			8		0.3	0.4	0.5	0.7	0.9	1.3	2
			10		0.3	0.4	0.5	0.7	0.9	1.3	2
			13		0.3	0.4	0.5	0.7	0.9	1.3	1.9
			16		0.3	0.4	0.5	0.7	0.9	1.3	1.9
			20			0.4	0.5	0.7	0.9	1.2	1.8
			25			0.4	0.5	0.7	0.9	1.2	1.8
			32				0.5	0.6	0.8	1	1.4
			40					0.6	0.8	1	1.4
			50						0.7	0.9	1.3
			63							0.9	1.2

E. = feed side
 L. = load side
 T = Total selectivity up to breaking capacity of the switch on load side
 Selectivity limit values indicated in kA

		E.	S800S								
Char.		C									
L.		Icu [kA]	50								
		I _n [A]	25	32	40	50	63	80	100	125	
S200M	D	15	0.5	T	T	T	T	T	T	T	T
			1	2.1	T	T	T	T	T	T	T
			1.6	0.8	2.3	T	T	T	T	T	T
			2	0.4	0.7	2.3	T	T	T	T	T
			3	0.3	0.5	0.7	1.2	2.2	6.4	T	T
			4	0.3	0.4	0.7	1	1.4	2.6	6.2	T
			6		0.4	0.6	0.8	1.1	1.8	3.2	6.4
			8			0.5	0.7	0.9	1.2	1.8	2.8
			10				0.7	0.9	1.2	1.8	2.8
			13					0.7	1	1.4	2
			16						1	1.4	2
			20							1	1.4
			25								1.4
			32								
			40								
50											
63											

		E.	S800S								
Char.		C									
L.		Icu [kA]	50								
		I _n [A]	25	32	40	50	63	80	100	125	
S200M	K	15	0.5	T	T	T	T	T	T	T	T
			1	2.1	T	T	T	T	T	T	T
			1.6	0.8	2.3	T	T	T	T	T	T
			2	0.4	0.7	2.3	T	T	T	T	T
			3	0.3	0.5	0.7	1.2	2.2	6.4	T	T
			4	0.3	0.4	0.7	1	1.4	2.6	6.2	T
			6		0.4	0.6	0.8	1.1	1.8	3.2	6.4
			8			0.5	0.7	0.9	1.2	1.8	2.8
			10				0.7	0.9	1.2	1.8	2.8
			13					0.7	1	1.4	2
			16						1	1.4	2
			20							1	1.4
			25								1.4
			32								
			40								
50											
63											

10

E. = feed side
L. = load side
T = Total selectivity up to breaking capacity of the switch on load side
Selectivity limit values indicated in kA

MCBs technical details

Coordination tables: selectivity

		E.	S800S								
Char.		D									
L.	Icu [kA]	In [A]	25	32	40	50	63	80	100	125	
S200M	B	15	6	0.5	1	1.2	2	2.8	T	T	T
			10	0.4	0.6	0.8	1.1	1.4	2.8	3.9	7.4
			13	0.4	0.6	0.8	1.1	1.4	2.5	3.3	5.6
			16		0.6	0.8	1.1	1.4	2.5	3.3	5.6
			20			0.8	1.1	1.3	2.3	3	4.7
			25			0.8	1.1	1.3	2.3	3	4.7
			32				0.9	1.1	1.9	2.4	3.7
			40					1.1	1.9	2.4	3.7
			50						1.5	1.9	2.3
			63							1.7	2.3

		E.	S800S								
Char.		D									
L.	Icu [kA]	In [A]	25	32	40	50	63	80	100	125	
S200M	C	15	0.5	T	T	T	T	T	T	T	T
			1	T	T	T	T	T	T	T	T
			1.6	T	T	T	T	T	T	T	T
			2	T	T	T	T	T	T	T	T
			3	0.7	2.2	4.4	T	T	T	T	T
			4	0.7	1.3	2.2	4.4	7.7	T	T	T
			6	0.5	1	1.2	2	2.8	9.9	T	T
			8	0.4	0.6	0.8	1.1	1.4	2.8	3.9	7.4
			10	0.4	0.6	0.8	1.1	1.4	2.8	3.9	7.4
			13	0.4	0.6	0.8	1.1	1.4	2.5	3.3	5.6
			16		0.6	0.8	1.1	1.4	2.5	3.3	5.6
			20			0.8	1.1	1.3	2.3	3	4.7
			25			0.8	1.1	1.3	2.3	3	4.7
			32				0.9	1.1	1.9	2.4	3.7
			40					1.1	1.9	2.4	3.7
			50						1.5	1.9	2.3
63							1.7	2.3			

E. = feed side
 L. = load side
 T = Total selectivity up to breaking capacity of the switch on load side
 Selectivity limit values indicated in kA

		E.		S800S								
		Char.		D								
L.		Icu [kA]	In [A]	50								
				25	32	40	50	63	80	100	125	
S200M	D	15	0.5	T	T	T	T	T	T	T	T	T
			1	T	T	T	T	T	T	T	T	T
			1.6	T	T	T	T	T	T	T	T	T
			2	2.3	T	T	T	T	T	T	T	T
			3	0.7	1.3	4.4	T	T	T	T	T	
			4	0.7	1	2.2	4.4	7.7	T	T	T	
			6	0.6	0.8	1.5	2.5	3.6	T	T	T	
			8	0.5	0.7	1.1	1.5	2	4	5.5	T	
			10	0.5	0.7	1.1	1.5	2	4	5.5	T	
			13		0.6	0.9	1.2	1.5	2.6	3.4	5.2	
			16			0.9	1.2	1.5	2.6	3.4	5.2	
			20				0.9	1.1	1.8	2.2	3.2	
			25					1.1	1.8	2.2	3.2	
			32						1.7	2	2.9	
			40							1.9	2.6	
			50								2.2	
63												

		E.		S800S								
		Char.		D								
L.		Icu [kA]	In [A]	50								
				25	32	40	50	63	80	100	125	
S200M	K	15	0.5	T	T	T	T	T	T	T	T	T
			1	T	T	T	T	T	T	T	T	T
			1.6	T	T	T	T	T	T	T	T	
			2	2.3	T	T	T	T	T	T	T	
			3	0.7	1.3	4.4	T	T	T	T		
			4	0.7	1	2.2	4.4	7.7	T	T	T	
			6	0.6	0.8	1.5	2.5	3.6	T	T	T	
			8	0.5	0.7	1.1	1.5	2	4	5.5	T	
			10	0.5	0.7	1.1	1.5	2	4	5.5	T	
			13		0.6	0.9	1.2	1.5	2.6	3.4	5.2	
			16			0.9	1.2	1.5	2.6	3.4	5.2	
			20				0.9	1.1	1.8	2.2	3.2	
			25					1.1	1.8	2.2	3.2	
			32						1.7	2	2.9	
			40							1.9	2.6	
			50								2.2	
63												

10

E. = feed side
L. = load side
T = Total selectivity up to breaking capacity of the switch on load side
Selectivity limit values indicated in kA

MCBs technical details

Coordination tables: selectivity

S800S - S200 P @ 230/400 V

		E.	S800S								
Char.		B									
L.	Icu [kA]	In [A]	25	32	40	50	63	80	100	125	
S200P	25	B	6			0.4	0.5	0.7	1	1.5	2.6
			10				0.4	0.6	0.7	1	1.4
			13					0.5	0.7	0.9	1.3
			16						0.7	0.9	1.3
			20							0.9	1.3
			25							0.9	1.3
	15	B	32							0.8	1.1
			40							0.8	1.1
			50								1
			63								0.9

		E.	S800S										
Char.		B											
L.	Icu [kA]	In [A]	25	32	40	50	63	80	100	125			
S200P	C	25	0.5	T	T	T	T	T	T	T	T		
			1	3.3	T	T	T	T	T	T	T		
			1.6	0.6	1.3	T	T	T	T	T	T		
			2	0.4	0.7	1.2	T	T	T	T	T		
			3		0.4	0.6	0.7	1.1	2.6	8.8	T		
			4		0.4	0.6	0.7	1	1.7	3.1	7		
			6			0.4	0.5	0.7	1	1.5	2.6		
			8				0.4	0.6	0.7	1	1.4		
			10				0.4	0.6	0.7	1	1.4		
			13					0.5	0.7	0.9	1.3		
			16						0.7	0.9	1.3		
			20							0.9	1.3		
			25							0.9	1.3		
			15	C	32							0.8	1.1
					40							0.8	1.1
					50								1
					63								0.9

E. = feed side
 L. = load side
 T = Total selectivity up to breaking capacity of the switch on load side
 Selectivity limit values indicated in kA

		E.	S800S								
Char.		B									
L.		Icu [kA]	50								
		In [A]	25	32	40	50	63	80	100	125	
S200P	K	25	0.2	T	T	T	T	T	T	T	T
			0.3	T	T	T	T	T	T	T	T
			0.5	T	T	T	T	T	T	T	T
			0.75	T	T	T	T	T	T	T	T
			1	0.8	5	T	T	T	T	T	T
			1.6	0.5	1	2.3	T	T	T	T	T
			2	0.3	0.5	0.7	2.1	T	T	T	T
			3		0.4	0.5	0.7	1.2	2.5	8.6	T
			4		0.4	0.4	0.7	1	1.7	3	7.7
			6				0.6	0.8	1.2	2	3.6
			8					0.7	0.9	1.3	2
			10						0.9	1.3	2
		13							1	1.5	
		16								1.5	
		20									
		25									
		15	32								
			40								
			50								
			63								

		E.	S800S								
Char.		C									
L.		Icu [kA]	50								
		In [A]	25	32	40	50	63	80	100	125	
S200P	B	25	6			0.4	0.5	0.7	1	1.5	2.6
			10				0.4	0.6	0.7	1	1.4
			13					0.5	0.7	0.9	1.3
			16						0.7	0.9	1.3
			20							0.9	1.3
		25							0.9	1.3	
		15	32							0.8	1.1
			40							0.8	1.1
			50								1
			63								0.9

E. = feed side
L. = load side
T = Total selectivity up to breaking capacity of the switch on load side
Selectivity limit values indicated in kA

MCBs technical details

Coordination tables: selectivity

		E.	S800S								
Char.		C									
L.		I _{cu} [kA]	50								
		I _n [A]	25	32	40	50	63	80	100	125	
S200P	C	25	0.5	T	T	T	T	T	T	T	T
			1	3.3	T	T	T	T	T	T	T
			1.6	0.6	1.3	T	T	T	T	T	T
			2	0.4	0.7	1.3	T	T	T	T	T
			3		0.4	0.6	0.7	1.1	2.6	8.8	T
			4		0.4	0.6	0.7	1	1.7	3.1	7
			6			0.4	0.5	0.7	1	1.5	2.6
			8				0.4	0.6	0.7	1	1.4
			10				0.4	0.6	0.7	1	1.4
			13					0.5	0.7	0.9	1.3
	16						0.7	0.9	1.3		
	20							0.9	1.3		
	25							0.9	1.3		
	32							0.8	1.1		
	40							0.8	1.1		
	50								1		
	63									0.9	

		E.	S800S								
Char.		C									
L.		I _{cu} [kA]	50								
		I _n [A]	25	32	40	50	63	80	100	125	
S200P	K	25	0.2	T	T	T	T	T	T	T	T
			0.3	T	T	T	T	T	T	T	T
			0.5	T	T	T	T	T	T	T	T
			0.75	T	T	T	T	T	T	T	T
			1	0.8	5	T	T	T	T	T	T
			1.6	0.5	1	2.3	T	T	T	T	T
			2	0.3	0.5	0.7	2.3	T	T	T	T
			3		0.4	0.5	0.7	1.2	2.5	8.6	T
			4		0.4	0.4	0.7	1	1.7	3	7.7
			6				0.6	0.8	1.2	2	3.6
	8					0.7	0.9	1.3	2		
	10						0.9	1.3	2		
	13							1	1.5		
	16								1.5		
	20										
	25										
	32										
	40										
	50										
	63										

E. = feed side
L. = load side
T = Total selectivity up to breaking capacity of the switch on load side
Selectivity limit values indicated in kA

		E.	S800S								
		Char.	D								
L.		Icu [kA]	50								
		In [A]	25	32	40	50	63	80	100	125	
S200P	B	25	6	0.5	1	1.2	2	2.8	9.9	21.3	T
			10	0.4	0.6	0.8	1.1	1.4	2.8	3.9	7.4
			13	0.4	0.6	0.8	1.1	1.4	2.5	3.3	5.6
			16		0.6	0.8	1.1	1.4	2.5	3.3	5.6
			20			0.8	1.1	1.3	2.3	3	4.7
			25			0.8	1.1	1.3	2.3	3	4.7
	15	32				0.9	1.1	1.9	2.4	3.7	
		40					1.1	1.9	2.4	3.7	
		50						1.5	1.9	2.3	
		63							1.7	2.3	

		E.	S800S								
		Char.	D								
L.		Icu [kA]	50								
		In [A]	25	32	40	50	63	80	100	125	
S200P	C	25	0.5	T	T	T	T	T	T	T	T
			1	T	T	T	T	T	T	T	T
			1.6	T	T	T	T	T	T	T	T
			2	T	T	T	T	T	T	T	T
			3	0.7	2.2	4.4	T	T	T	T	T
			4	0.7	1.3	2.2	4.4	7.7	T	T	T
			6	0.5	1	1.2	2	2.8	9.9	22	T
			8	0.4	0.6	0.8	1.1	1.4	2.8	3.9	7.4
			10	0.4	0.6	0.8	1.1	1.4	2.8	3.9	7.4
			13	0.4	0.6	0.8	1.1	1.4	2.5	3.3	5.6
			16		0.6	0.8	1.1	1.4	2.5	3.3	5.6
			20			0.8	1.1	1.3	2.3	3	4.7
	25			0.8	1.1	1.3	2.3	3	4.7		
	15	32				0.9	1.1	1.9	2.4	3.7	
		40					1.1	1.9	2.4	3.7	
		50						1.5	1.9	2.3	
		63							1.7	2.3	

E. = feed side
L. = load side
T = Total selectivity up to breaking capacity of the switch on load side
Selectivity limit values indicated in kA

MCBs technical details

Coordination tables: selectivity

		E.	S800S								
Char.		D									
L.	l _{cu} [kA]	50									
	In [A]	25	32	40	50	63	80	100	125		
S200P K	25	0.2	T	T	T	T	T	T	T	T	T
		0.3	T	T	T	T	T	T	T	T	T
		0.5	T	T	T	T	T	T	T	T	T
		0.75	T	T	T	T	T	T	T	T	T
		1	T	T	T	T	T	T	T	T	T
		1.6	T	T	T	T	T	T	T	T	T
		2	2.3	T	T	T	T	T	T	T	T
		3	0.7	1.3	4.4	T	T	T	T	T	T
		4	0.7	1	2.2	4.4	7.7	T	T	T	T
		6	0.6	0.8	1.5	2.5	3.6	12	24.2	T	T
	8	0.5	0.7	1.1	1.5	2	4	5.5	9.9	T	
	10	0.5	0.7	1.1	1.5	2	4	5.5	9.9	T	
	13		0.6	0.9	1.2	1.5	2.6	3.4	5.2	T	
	16			0.9	1.2	1.5	2.6	3.4	5.2	T	
	20				0.9	1.1	1.8	2.2	3.2	T	
	25						1.8	2.2	3.2	T	
	32							1.7	2	2.9	
	40								1.9	2.6	
	50									2.2	
	63										
	15										

E. = feed side
 L. = load side
 T = Total selectivity up to breaking capacity of the switch on load side
 Selectivity limit values indicated in kA

S800N - S200 @ 230/400 V

		E.	S800N								
		Char.	B								
L.		Icu [kA]	36								
			In [A]	25	32	40	50	63	80	100	125
S200	B	10	6			0.4	0.5	0.7	1	1.5	2.6
			10				0.4	0.6	0.7	1	1.4
			13					0.5	0.7	0.9	1.3
			16						0.7	0.9	1.3
			20							0.9	1.3
			25							0.9	1.3
			32							0.8	1.1
			40							0.8	1.1
			50								1
			63								0.9

		E.	S800N								
		Char.	B								
L.		Icu [kA]	36								
			In [A]	25	32	40	50	63	80	100	125
S200	C	10	0.5	T	T	T	T	T	T	T	T
			1	3.3	T	T	T	T	T	T	T
			1.6	0.6	1.3	T	T	T	T	T	T
			2	0.4	0.7	1.2	T	T	T	T	T
			3		0.4	0.6	0.7	1.1	2.6	T	T
			4		0.4	0.6	0.7	1	1.7	3.1	T
			6			0.4	0.5	0.7	1	1.5	2.6
			8				0.4	0.6	0.7	1	1.4
			10				0.4	0.6	0.7	1	1.4
			13					0.5	0.7	0.9	1.3
			16						0.7	0.9	1.3
			20							0.9	1.3
			25							0.9	1.3
			32							0.8	1.1
			40							0.8	1.1
			50								1
			63								0.9

10

E. = feed side
 L. = load side
 T = Total selectivity up to breaking capacity of the switch on load side
 Selectivity limit values indicated in kA

MCBs technical details

Coordination tables: selectivity

		E.		S800N							
Char.		B									
L.	lcu [kA]	In [A]	25	32	40	50	63	80	100	125	
S200	D	10	0.5	T	T	T	T	T	T	T	T
			1	0.8	5	T	T	T	T	T	T
			1.6	0.5	1	2.3	T	T	T	T	T
			2	0.3	0.5	0.7	2.3	T	T	T	T
			3		0.4	0.5	0.7	1.2	2.5	T	T
			4		0.4	0.4	0.7	1	1.7	3	T
			6				0.6	0.8	1.2	2	3.6
			8					0.7	0.9	1.3	2
			10						0.9	1.3	2
			13							1	1.5
			16								1.5
			20								
			25								
			32								
			40								
50											
63											

		E.		S800N							
Char.		B									
L.	lcu [kA]	In [A]	25	32	40	50	63	80	100	125	
S200	K	10	0.5	T	T	T	T	T	T	T	T
			1	0.8	5	T	T	T	T	T	T
			1.6	0.5	1	2.3	T	T	T	T	T
			2	0.3	0.5	0.7	2.3	T	T	T	T
			3		0.4	0.5	0.7	1.2	2.5	T	T
			4		0.4	0.4	0.7	1	1.7	3	T
			6				0.6	0.8	1.2	2	3.6
			8					0.7	0.9	1.3	2
			10						0.9	1.3	2
			13							1	1.5
			16								1.5
			20								
			25								
			32								
			40								
50											
63											

E. = feed side
 L. = load side
 T = Total selectivity up to breaking capacity of the switch on load side
 Selectivity limit values indicated in kA

		E.	S800N								
		Char.	C								
L.		Icu [kA]	In [A]	25	32	40	50	63	80	100	125
S200	B	10	6		0.4	0.5	0.7	0.9	1.4	2.4	4.8
			10		0.3	0.4	0.5	0.7	0.9	1.3	2
			13		0.3	0.4	0.5	0.7	0.9	1.3	1.9
			16		0.3	0.4	0.5	0.7	0.9	1.3	1.9
			20			0.4	0.5	0.7	0.9	1.2	1.8
			25			0.4	0.5	0.7	0.9	1.2	1.8
			32				0.5	0.6	0.8	1	1.4
			40					0.6	0.8	1	1.4
			50						0.7	0.9	1.3
			63							0.9	1.2

		E.	S800N									
		Char.	C									
L.		Icu [kA]	In [A]	25	32	40	50	63	80	100	125	
S200	C	10	0.5	T	T	T	T	T	T	T	T	T
			1	T	T	T	T	T	T	T	T	T
			1.6	0.6	T	T	T	T	T	T	T	T
			2	0.5	1	T	T	T	T	T	T	T
			3	0.3	0.5	0.7	1.2	2.1	T	T	T	
			4	0.3	0.4	0.7	1	1.5	2.6	T	T	
			6		0.4	0.5	0.7	0.9	1.4	2.4	4.8	
			8		0.3	0.4	0.5	0.7	0.9	1.3	2	
			10		0.3	0.4	0.5	0.7	0.9	1.3	2	
			13		0.3	0.4	0.5	0.7	0.9	1.3	1.9	
			16		0.3	0.4	0.5	0.7	0.9	1.3	1.9	
			20			0.4	0.5	0.7	0.9	1.2	1.8	
			25			0.4	0.5	0.7	0.9	1.2	1.8	
			32				0.5	0.6	0.8	1	1.4	
			40					0.6	0.8	1	1.4	
			50						0.7	0.9	1.3	
63							0.9	1.2				

10

E. = feed side
L. = load side
T = Total selectivity up to breaking capacity of the switch on load side
Selectivity limit values indicated in kA

MCBs technical details

Coordination tables: selectivity

		E.		S800N								
		C										
L.	Char.	Icu [kA]	In [A]	25	32	40	50	63	80	100	125	
S200	D	10	0.5	T	T	T	T	T	T	T	T	
			1	2.1	T	T	T	T	T	T	T	
			1.6	0.8	2.3	T	T	T	T	T	T	
			2	0.4	0.7	2.3	T	T	T	T	T	
			3	0.3	0.5	0.7	1.2	2.2	T	T	T	
			4	0.3	0.4	0.7	1	1.4	2.6	T	T	
			6		0.4	0.6	0.8	1.1	1.8	3.2	T	
			8			0.5	0.7	0.9	1.2	1.8	2.8	
			10				0.7	0.9	1.2	1.8	2.8	
			13					0.7	1	1.4	2	
			16						1	1.4	2	
			20							1	1.4	
			25								1.4	
			32									
			40									
			50									
			63									

		E.		S800N								
		C										
L.	Char.	Icu [kA]	In [A]	25	32	40	50	63	80	100	125	
S200	K	10	0.5	T	T	T	T	T	T	T	T	
			1	2.1	T	T	T	T	T	T	T	
			1.6	0.8	2.3	T	T	T	T	T	T	
			2	0.4	0.7	2.3	T	T	T	T	T	
			3	0.3	0.5	0.7	1.2	2.2	T	T	T	
			4	0.3	0.4	0.7	1	1.4	2.6	T	T	
			6		0.4	0.6	0.8	1.1	1.8	3.2	T	
			8			0.5	0.7	0.9	1.2	1.8	2.8	
			10				0.7	0.9	1.2	1.8	2.8	
			13					0.7	1	1.4	2	
			16						1	1.4	2	
			20							1	1.4	
			25								1.4	
			32									
			40									
			50									
			63									

E. = feed side
 L. = load side
 T = Total selectivity up to breaking capacity of the switch on load side
 Selectivity limit values indicated in kA

		E.		S800N							
		Char.		D							
L.		Icu [kA]	In [A]	36							
				25	32	40	50	63	80	100	125
S200	B	10	6	0.5	1	1.2	2	2.8	T	T	T
			10	0.4	0.6	0.8	1.1	1.4	2.8	3.9	T
			13	0.4	0.6	0.8	1.1	1.4	2.5	3.3	5.6
			16		0.6	0.8	1.1	1.4	2.5	3.3	5.6
			20			0.8	1.1	1.3	2.3	3	4.7
			25			0.8	1.1	1.3	2.3	3	4.7
			32				0.9	1.1	1.9	2.4	3.7
			40					1.1	1.9	2.4	3.7
			50						1.5	1.9	2.3
			63							1.7	2.3

		E.		S800N								
		Char.		D								
L.		Icu [kA]	In [A]	36								
				25	32	40	50	63	80	100	125	
S200	C	10	0.5	T	T	T	T	T	T	T	T	T
			1	T	T	T	T	T	T	T	T	T
			1.6	T	T	T	T	T	T	T	T	T
			2	T	T	T	T	T	T	T	T	T
			3	0.7	2.2	4.4	T	T	T	T	T	
			4	0.7	1.3	2.2	4.4	T	T	T	T	
			6	0.5	1	1.2	2	2.8	T	T	T	
			8	0.4	0.6	0.8	1.1	1.4	2.8	3.9	T	
			10	0.4	0.6	0.8	1.1	1.4	2.8	3.9	T	
			13	0.4	0.6	0.8	1.1	1.4	2.5	3.3	5.6	
			16		0.6	0.8	1.1	1.4	2.5	3.3	5.6	
			20			0.8	1.1	1.3	2.3	3	4.7	
			25			0.8	1.1	1.3	2.3	3	4.7	
			32				0.9	1.1	1.9	2.4	3.7	
			40					1.1	1.9	2.4	3.7	
			50						1.5	1.9	2.3	
			63							1.7	2.3	

10

E. = feed side
L. = load side
T = Total selectivity up to breaking capacity of the switch on load side
Selectivity limit values indicated in kA

MCBs technical details

Coordination tables: selectivity

		E.		S800N							
Char.		D									
L.	lcu	36									
	[kA]	In [A]	25	32	40	50	63	80	100	125	
S200	D	10	0.5	T	T	T	T	T	T	T	T
			1	T	T	T	T	T	T	T	T
			1.6	T	T	T	T	T	T	T	T
			2	2.3	T	T	T	T	T	T	T
			3	0.7	1.3	4.4	T	T	T	T	T
			4	0.7	1	2.2	4.4	T	T	T	T
			6	0.6	0.8	1.5	2.5	3.6	T	T	T
			8	0.5	0.7	1.1	1.5	2	4	5.5	T
			10	0.5	0.7	1.1	1.5	2	4	5.5	T
			13		0.6	0.9	1.2	1.5	2.6	3.4	5.2
			16			0.9	1.2	1.5	2.6	3.4	5.2
			20				0.9	1.1	1.8	2.2	3.2
			25					1.1	1.8	2.2	3.2
			32						1.7	2	2.9
			40							1.9	2.6
50								2.2			
63											

		E.		S800N							
Char.		D									
L.	lcu	36									
	[kA]	In [A]	25	32	40	50	63	80	100	125	
S200	K	10	0.5	T	T	T	T	T	T	T	T
			1	T	T	T	T	T	T	T	T
			1.6	T	T	T	T	T	T	T	T
			2	2.3	T	T	T	T	T	T	T
			3	0.7	1.3	4.4	T	T	T	T	T
			4	0.7	1	2.2	4.4	T	T	T	T
			6	0.6	0.8	1.5	2.5	3.6	T	T	T
			8	0.5	0.7	1.1	1.5	2	4	5.5	T
			10	0.5	0.7	1.1	1.5	2	4	5.5	T
			13		0.6	0.9	1.2	1.5	2.6	3.4	5.2
			16			0.9	1.2	1.5	2.6	3.4	5.2
			20				0.9	1.1	1.8	2.2	3.2
			25					1.1	1.8	2.2	3.2
			32						1.7	2	2.9
			40							1.9	2.6
50								2.2			
63											

E. = feed side
L. = load side
T = Total selectivity up to breaking capacity of the switch on load side
Selectivity limit values indicated in kA

S800N - S200M @ 230/400 V

		E.	S800N								
		Char.	B								
L.		Icu [kA]	36								
			In [A]	25	32	40	50	63	80	100	125
S200M	B	15	6			0.4	0.5	0.7	1	1.5	2.6
			10				0.4	0.6	0.7	1	1.4
			13					0.5	0.7	0.9	1.3
			16						0.7	0.9	1.3
			20							0.9	1.3
			25							0.9	1.3
			32							0.8	1.1
			40							0.8	1.1
			50								1
			63								

		E.	S800N									
		Char.	B									
L.		Icu [kA]	36									
			In [A]	25	32	40	50	63	80	100	125	
S200M	C	15	0.5	T	T	T	T	T	T	T	T	T
			1	3.3	T	T	T	T	T	T	T	T
			1.6	0.6	1.3	T	T	T	T	T	T	T
			2	0.4	0.7	1.3	T	T	T	T	T	T
			3		0.4	0.6	0.7	1.1	2.6	8.8	T	T
			4		0.4	0.6	0.7	1	1.7	3.1	7	T
			6			0.4	0.5	0.7	1	1.5	2.6	T
			8				0.4	0.6	0.7	1	1.4	T
			10				0.4	0.6	0.7	1	1.4	T
			13					0.5	0.7	0.9	1.3	T
			16						0.7	0.9	1.3	T
			20							0.9	1.3	T
			25							0.9	1.3	T
			32							0.8	1.1	T
			40							0.8	1.1	T
			50								1	T
63									0.9	T		

E. = feed side
 L. = load side
 T = Total selectivity up to breaking capacity of the switch on load side
 Selectivity limit values indicated in kA

MCBs technical details

Coordination tables: selectivity

		E.		S800N							
Char.		B									
L.	Char.	Icu [kA]	In [A]	25	32	40	50	63	80	100	125
S200M	D	15	0.5	T	T	T	T	T	T	T	T
			1	0.8	5	T	T	T	T	T	T
			1.6	0.5	1	2.3	T	T	T	T	T
			2	0.3	0.5	0.7	2.3	T	T	T	T
			3		0.4	0.5	0.7	1.2	2.5	8.6	T
			4		0.4	0.4	0.7	1	1.7	3	7.7
			6				0.6	0.8	1.2	2	3.6
			8					0.7	0.9	1.3	2
			10						0.9	1.3	2
			13							1	1.5
			16								1.5
			20								
			25								
			32								
			40								
50											
63											

		E.		S800N							
Char.		B									
L.	Char.	Icu [kA]	In [A]	25	32	40	50	63	80	100	125
S200M	K	15	0.5	T	T	T	T	T	T	T	T
			1	0.8	5	T	T	T	T	T	T
			1.6	0.5	1	2.3	T	T	T	T	T
			2	0.3	0.5	0.7	2.3	T	T	T	T
			3		0.4	0.5	0.7	1.2	2.5	8.6	T
			4		0.4	0.4	0.7	1	1.7	3	7.7
			6				0.6	0.8	1.2	2	3.6
			8					0.7	0.9	1.3	2
			10						0.9	1.3	2
			13							1	1.5
			16								1.5
			20								
			25								
			32								
			40								
50											
63											

E. = feed side
 L. = load side
 T = Total selectivity up to breaking capacity of the switch on load side
 Selectivity limit values indicated in kA

		E.	S800N								
L.		Char.	C								
		Icu [kA]	In [A]	25	32	40	50	63	80	100	125
S200M	B	15	6		0.4	0.5	0.7	0.9	1.4	2.4	4.8
			10		0.3	0.4	0.5	0.7	0.9	1.3	2
			13		0.3	0.4	0.5	0.7	0.9	1.3	1.9
			16		0.3	0.4	0.5	0.7	0.9	1.3	1.9
			20			0.4	0.5	0.7	0.9	1.2	1.8
			25			0.4	0.5	0.7	0.9	1.2	1.8
			32				0.5	0.6	0.8	1	1.4
			40					0.6	0.8	1	1.4
			50						0.7	0.9	1.3
			63							0.9	1.2

		E.	S800N								
L.		Char.	C								
		Icu [kA]	In [A]	25	32	40	50	63	80	100	125
S200M	C	15	0.5	T	T	T	T	T	T	T	T
			1	T	T	T	T	T	T	T	T
			1.6	0.6	T	T	T	T	T	T	T
			2	0.5	1	T	T	T	T	T	T
			3	0.3	0.5	0.7	1.2	2.1	6.4	T	T
			4	0.3	0.4	0.7	1	1.5	2.6	6.1	T
			6		0.4	0.5	0.7	0.9	1.4	2.4	4.8
			8		0.3	0.4	0.5	0.7	0.9	1.3	2
			10		0.3	0.4	0.5	0.7	0.9	1.3	2
			13		0.3	0.4	0.5	0.7	0.9	1.3	1.9
			16		0.3	0.4	0.5	0.7	0.9	1.3	1.9
			20			0.4	0.5	0.7	0.9	1.2	1.8
			25			0.4	0.5	0.7	0.9	1.2	1.8
			32				0.5	0.6	0.8	1	1.4
			40					0.6	0.8	1	1.4
			50						0.7	0.9	1.3
63							0.9	1.2			

E. = feed side
L. = load side
T = Total selectivity up to breaking capacity of the switch on load side
Selectivity limit values indicated in kA

MCBs technical details

Coordination tables: selectivity

		E.		S800N							
L.		Char.	C								
		Icu	36								
		[kA]	In [A]	25	32	40	50	63	80	100	125
S200M	D	15	0.5	T	T	T	T	T	T	T	T
			1	2.1	T	T	T	T	T	T	T
			1.6	0.8	2.3	T	T	T	T	T	T
			2	0.4	0.7	2.3	T	T	T	T	T
			3	0.3	0.5	0.7	1.2	2.2	6.4	T	T
			4	0.3	0.4	0.7	1	1.4	2.6	6.2	T
			6		0.4	0.6	0.8	1.1	1.8	3.2	6.4
			8			0.5	0.7	0.9	1.2	1.8	2.8
			10				0.7	0.9	1.2	1.8	2.8
			13					0.7	1	1.4	2
			16						1	1.4	2
			20							1	1.4
			25								1.4
			32								
			40								
50											
63											

		E.		S800N							
L.		Char.	C								
		Icu	36								
		[kA]	In [A]	25	32	40	50	63	80	100	125
S200M	K	15	0.5	T	T	T	T	T	T	T	T
			1	2.1	T	T	T	T	T	T	T
			1.6	0.8	2.3	T	T	T	T	T	T
			2	0.4	0.7	2.3	T	T	T	T	T
			3	0.3	0.5	0.7	1.2	2.2	6.4	T	T
			4	0.3	0.4	0.7	1	1.4	2.6	6.2	T
			6		0.4	0.6	0.8	1.1	1.8	3.2	6.4
			8			0.5	0.7	0.9	1.2	1.8	2.8
			10				0.7	0.9	1.2	1.8	2.8
			13					0.7	1	1.4	2
			16						1	1.4	2
			20							1	1.4
			25								1.4
			32								
			40								
50											
63											

E. = feed side
 L. = load side
 T = Total selectivity up to breaking capacity of the switch on load side
 Selectivity limit values indicated in kA

		E.		S800N							
		Char.		D							
L.		Icu [kA]	36								
			In [A]	25	32	40	50	63	80	100	125
S200M	B	15	6	0.5	1	1.2	2	2.8	T	T	T
			10	0.4	0.6	0.8	1.1	1.4	2.8	3.9	7.4
			13	0.4	0.6	0.8	1.1	1.4	2.5	3.3	5.6
			16		0.6	0.8	1.1	1.4	2.5	3.3	5.6
			20			0.8	1.1	1.3	2.3	3	4.7
			25			0.8	1.1	1.3	2.3	3	4.7
			32				0.9	1.1	1.9	2.4	3.7
			40					1.1	1.9	2.4	3.7
			50						1.5	1.9	2.3
			63							1.7	2.3

		E.		S800N								
		Char.		D								
L.		Icu [kA]	36									
			In [A]	25	32	40	50	63	80	100	125	
S200M	C	15	0.5	T	T	T	T	T	T	T	T	T
			1	T	T	T	T	T	T	T	T	T
			1.6	T	T	T	T	T	T	T	T	T
			2	T	T	T	T	T	T	T	T	T
			3	0.7	2.2	4.4	T	T	T	T	T	
			4	0.7	1.3	2.2	4.4	7.7	T	T	T	
			6	0.5	1	1.2	2	2.8	T	T	T	
			8	0.4	0.6	0.8	1.1	1.4	2.8	3.9	7.4	
			10	0.4	0.6	0.8	1.1	1.4	2.8	3.9	7.4	
			13	0.4	0.6	0.8	1.1	1.4	2.5	3.3	5.6	
			16		0.6	0.8	1.1	1.4	2.5	3.3	5.6	
			20			0.8	1.1	1.3	2.3	3	4.7	
			25			0.8	1.1	1.3	2.3	3	4.7	
			32				0.9	1.1	1.9	2.4	3.7	
			40					1.1	1.9	2.4	3.7	
			50						1.5	1.9	2.3	
			63							1.7	2.3	

E. = feed side
L. = load side
T = Total selectivity up to breaking capacity of the switch on load side
Selectivity limit values indicated in kA

MCBs technical details

Coordination tables: selectivity

		E.		S800N							
Char.		D									
L.	l _{cu} [kA]	In [A]	25	32	40	50	63	80	100	125	
S200M	D	15	0.5	T	T	T	T	T	T	T	T
			1	T	T	T	T	T	T	T	T
			1.6	T	T	T	T	T	T	T	T
			2	2.3	T	T	T	T	T	T	T
			3	0.7	1.3	4.4	T	T	T	T	T
			4	0.7	1	2.2	4.4	7.7	T	T	T
			6	0.6	0.8	1.5	2.5	3.6	T	T	T
			8	0.5	0.7	1.1	1.5	2	4	5.5	T
			10	0.5	0.7	1.1	1.5	2	4	5.5	T
			13		0.6	0.9	1.2	1.5	2.6	3.4	5.2
			16			0.9	1.2	1.5	2.6	3.4	5.2
			20				0.9	1.1	1.8	2.2	3.2
			25					1.1	1.8	2.2	3.2
			32						1.7	2	2.9
			40							1.9	2.6
			50								2.2
			63								

		E.		S800N							
Char.		D									
L.	l _{cu} [kA]	In [A]	25	32	40	50	63	80	100	125	
S200M	K	15	0.5	T	T	T	T	T	T	T	T
			1	T	T	T	T	T	T	T	T
			1.6	T	T	T	T	T	T	T	T
			2	2.3	T	T	T	T	T	T	T
			3	0.7	1.3	4.4	T	T	T	T	T
			4	0.7	1	2.2	4.4	7.7	T	T	T
			6	0.6	0.8	1.5	2.5	3.6	T	T	T
			8	0.5	0.7	1.1	1.5	2	4	5.5	T
			10	0.5	0.7	1.1	1.5	2	4	5.5	T
			13		0.6	0.9	1.2	1.5	2.6	3.4	5.2
			16			0.9	1.2	1.5	2.6	3.4	5.2
			20				0.9	1.1	1.8	2.2	3.2
			25					1.1	1.8	2.2	3.2
			32						1.7	2	2.9
			40							1.9	2.6
			50								2.2
			63								

E. = feed side
 L. = load side
 T = Total selectivity up to breaking capacity of the switch on load side
 Selectivity limit values indicated in kA

S800N - S200P @ 230/400 V

		E.	S800N								
L.		Char.	B								
		Icu [kA]	36								
		In [A]	25	32	40	50	63	80	100	125	
S200P	B	25	6		0.4	0.5	0.7	1	1.5	2.6	
			10			0.4	0.6	0.7	1	1.4	
			13				0.5	0.7	0.9	1.3	
		16					0.7	0.9	1.3		
		20						0.9	1.3		
		25						0.9	1.3		
	15	32							0.8	1.1	
		40							0.8	1.1	
		50								1	
		63								0.9	

		E.	S800N									
L.		Char.	B									
		Icu [kA]	36									
		In [A]	25	32	40	50	63	80	100	125		
S200P	C	25	0.5	T	T	T	T	T	T	T	T	
			1	3.3	T	T	T	T	T	T	T	
			1.6	0.6	1.3	T	T	T	T	T	T	
			2	0.4	0.7	1.3	T	T	T	T	T	
			3		0.4	0.6	0.7	1.1	2.6	8.8	T	
			4		0.4	0.6	0.7	1	1.7	3.1	7	
			6			0.4	0.5	0.7	1	1.5	2.6	
			8				0.4	0.6	0.7	1	1.4	
			10				0.4	0.6	0.7	1	1.4	
		15	13					0.5	0.7	0.9	1.3	
			16						0.7	0.9	1.3	
			20							0.9	1.3	
			25							0.9	1.3	
			32								0.8	1.1
			40								0.8	1.1
			50									1
			63									0.9

E. = feed side
 L. = load side
 T = Total selectivity up to breaking capacity of the switch on load side
 Selectivity limit values indicated in kA

MCBs technical details

Coordination tables: selectivity

		E.		S800N								
L.		Char.	B									
		l _{cu}	36									
		[kA]	In [A]	25	32	40	50	63	80	100	125	
S200P	K	25	0.2	T	T	T	T	T	T	T	T	T
			0.3	T	T	T	T	T	T	T	T	T
			0.5	T	T	T	T	T	T	T	T	T
			0.75	T	T	T	T	T	T	T	T	T
			1	0.8	5	T	T	T	T	T	T	T
			1.6	0.5	1	2.3	T	T	T	T	T	T
			2	0.3	0.5	0.7	2.1	T	T	T	T	T
			3		0.4	0.5	0.7	1.2	2.5	8.6	T	
			4		0.4	0.4	0.7	1	1.7	3	7.7	
			6				0.6	0.8	1.2	2	3.6	
			8					0.7	0.9	1.3	2	
			10						0.9	1.3	2	
			13							1	1.5	
			16								1.5	
			20									
		25										
		32										
		40										
		50										
63												

10

		E.		S800N							
L.		Char.	C								
		l _{cu}	36								
		[kA]	In [A]	25	32	40	50	63	80	100	125
S200P	B	25	6			0.4	0.5	0.7	1	1.5	2.6
			10				0.4	0.6	0.7	1	1.4
			13					0.5	0.7	0.9	1.3
			16						0.7	0.9	1.3
			20							0.9	1.3
			25							0.9	1.3
		32							0.8	1.1	
		40							0.8	1.1	
		50								1	
		63									0.9

E. = feed side
 L. = load side
 T = Total selectivity up to breaking capacity of the switch on load side
 Selectivity limit values indicated in kA

		E.	S800N							
Char.		C								
L.	Icu [kA]	In [A]	25	32	40	50	63	80	100	125
S200P	25	0.5	T	T	T	T	T	T	T	T
		1	3.3	T	T	T	T	T	T	T
		1.6	0.6	1.3	T	T	T	T	T	T
		2	0.4	0.7	1.3	T	T	T	T	T
		3		0.4	0.6	0.7	1.1	2.6	8.8	T
		4		0.4	0.6	0.7	1	1.7	3.1	7
		6			0.4	0.5	0.7	1	1.5	2.6
		8				0.4	0.6	0.7	1	1.4
		10				0.4	0.6	0.7	1	1.4
		13					0.5	0.7	0.9	1.3
	16						0.7	0.9	1.3	
	20							0.9	1.3	
	25							0.9	1.3	
	32								0.8	1.1
	40								0.8	1.1
	50									1
	63									0.9

		E.	S800N							
Char.		C								
L.	Icu [kA]	In [A]	25	32	40	50	63	80	100	125
S200P	25	0.2	T	T	T	T	T	T	T	T
		0.3	T	T	T	T	T	T	T	T
		0.5	T	T	T	T	T	T	T	T
		0.75	T	T	T	T	T	T	T	T
		1	0.8	5	T	T	T	T	T	T
		1.6	0.5	1	2.3	T	T	T	T	T
		2	0.3	0.5	0.7	2.3	T	T	T	T
		3		0.4	0.5	0.7	1.2	2.5	8.6	T
		4		0.4	0.4	0.7	1	1.7	3	7.7
		6				0.6	0.8	1.2	2	3.6
	8					0.7	0.9	1.3	2	
	10						0.9	1.3	2	
	13							1	1.5	
	16								1.5	
	20									
	25									
	32									
	40									
	50									
	63									

10

E. = feed side
L. = load side
T = Total selectivity up to breaking capacity of the switch on load side
Selectivity limit values indicated in kA

MCBs technical details

Coordination tables: selectivity

		E.		S800N							
L.		Char.		D							
		Icu [kA]	In [A]	36							
				25	32	40	50	63	80	100	125
S200P	B	25	6	0.5	1	1.2	2	2.8	9.9	21.3	T
			10	0.4	0.6	0.8	1.1	1.4	2.8	3.9	7.4
			13	0.4	0.6	0.8	1.1	1.4	2.5	3.3	5.6
			16		0.6	0.8	1.1	1.4	2.5	3.3	5.6
			20			0.8	1.1	1.3	2.3	3	4.7
			25			0.8	1.1	1.3	2.3	3	4.7
	15	32				0.9	1.1	1.9	2.4	3.7	
		40					1.1	1.9	2.4	3.7	
		50						1.5	1.9	2.3	
		63							1.7	2.3	

		E.		S800N								
L.		Char.		D								
		Icu [kA]	In [A]	36								
				25	32	40	50	63	80	100	125	
S200P	C	25	0.5	T	T	T	T	T	T	T	T	
			1	T	T	T	T	T	T	T	T	
			1.6	T	T	T	T	T	T	T	T	
			2	T	T	T	T	T	T	T	T	
			3	0.7	2.2	4.4	T	T	T	T	T	
			4	0.7	1.3	2.2	4.4	7.7	T	T	T	
			6	0.5	1	1.2	2	2.8	9.9	22	T	
			8	0.4	0.6	0.8	1.1	1.4	2.8	3.9	7.4	
			10	0.4	0.6	0.8	1.1	1.4	2.8	3.9	7.4	
			13	0.4	0.6	0.8	1.1	1.4	2.5	3.3	5.6	
			16		0.6	0.8	1.1	1.4	2.5	3.3	5.6	
			20			0.8	1.1	1.3	2.3	3	4.7	
			25			0.8	1.1	1.3	2.3	3	4.7	
			15	32				0.9	1.1	1.9	2.4	3.7
				40					1.1	1.9	2.4	3.7
				50						1.5	1.9	2.3
				63							1.7	2.3

E. = feed side
 L. = load side
 T = Total selectivity up to breaking capacity of the switch on load side
 Selectivity limit values indicated in kA

		E.	S800N									
L.		Char.	D									
		Icu [kA]	In [A]	25	32	40	50	63	80	100	125	
S200P	K	25	0.2	T	T	T	T	T	T	T	T	T
			0.3	T	T	T	T	T	T	T	T	T
			0.5	T	T	T	T	T	T	T	T	T
			0.75	T	T	T	T	T	T	T	T	T
			1	T	T	T	T	T	T	T	T	T
			1.6	T	T	T	T	T	T	T	T	T
			2	2.3	T	T	T	T	T	T	T	T
			3	0.7	1.3	4.4	T	T	T	T	T	
			4	0.7	1	2.2	4.4	7.7	T	T	T	
			6	0.6	0.8	1.5	2.5	3.6	12	24.2	T	
			8	0.5	0.7	1.1	1.5	2	4	5.5	9.9	
			10	0.5	0.7	1.1	1.5	2	4	5.5	9.9	
			13		0.6	0.9	1.2	1.5	2.6	3.4	5.2	
			16			0.9	1.2	1.5	2.6	3.4	5.2	
			20				0.9	1.1	1.8	2.2	3.2	
		25					1.1	1.8	2.2	3.2		
		32						1.7	2	2.9		
		40							1.9	2.6		
		50								2.2		
		63										

E. = feed side
L. = load side
T = Total selectivity up to breaking capacity of the switch on load side
Selectivity limit values indicated in kA

MCBs technical details

Coordination tables: selectivity

Functional diagram of selective main circuit breakers S 700

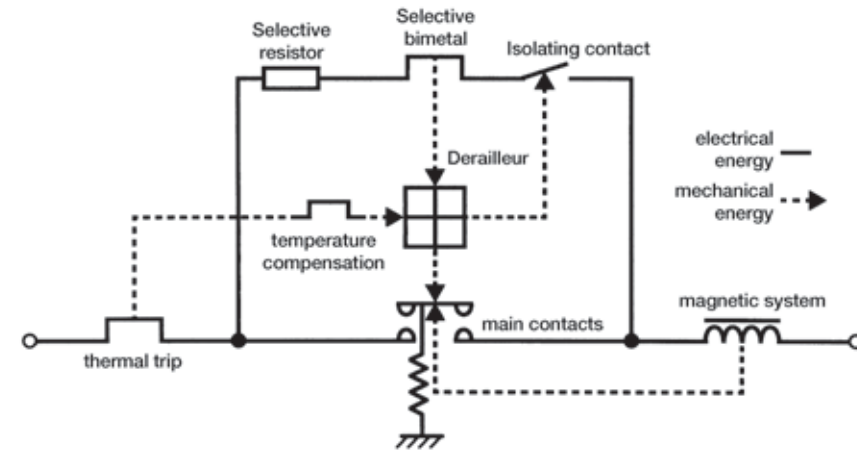

Functional diagram of selective main circuit breakers S 750 (DR)

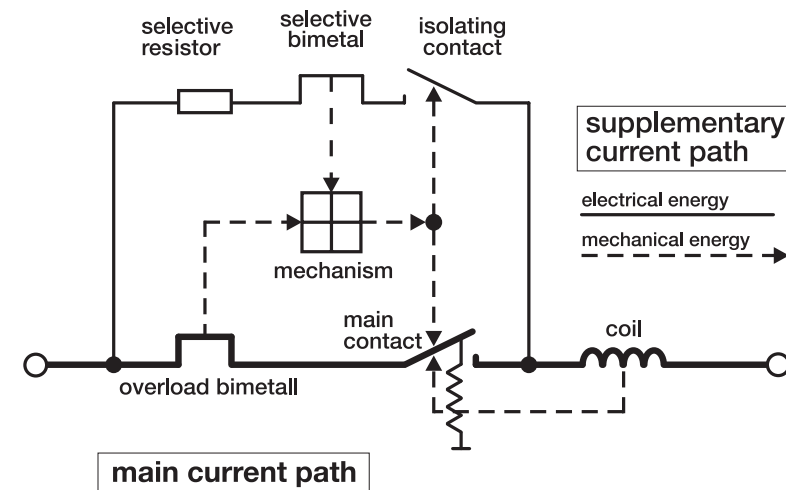

Back-up protection

Selective main circuit breakers of the S 700 and S 750 DR series are capable of switching off short-circuit currents of up to 25 kA automatically in networks with a rated voltage of 230/400 V.

Back-up protection is necessary only when the prospective short-circuit current may exceed 25 kA prosp. at the installation point. Further information on back-up protection on request.

Short circuit discrimination

When ABB miniature circuit-breaker are used in combination with the S 700 or S 750 DR, higher short-circuit currents can be disconnected than are indicated as permissible rated switching capacity of device. Considering the values given in the table, the S 700 and S 750 DR operates selectively with respect to the combination with the final device. If other mcb's are used selectivity for 6 kA and 10 kA devices is available up to the rated switching capacity of the final device.

MCB

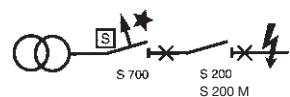



		Supply side	S 700										fuse									
Load side	Char.	E/K	gG										gG									
		Icu [kA]	25										25									
		In [A]	16	20	25	35	40	50	63	80	100	16	20	25	35	50	63	80	100			
S 200	C	≤ 2	>15	>15	>15	>15	>15	>15	>15	>15	>15	1	1.2	4	>15	>15	>15	>15	>15			
		3	10	10	10	10	10	10	10	8	8	0.3	0.7	1.2	4.6	6	6	6	6			
		4	10	10	10	10	10	10	10	8	8	0.3	0.6	0.9	2.8	6	6	6	6			
	B, C	6	10	10	10	10	10	10	10	8	8	0.2	0.5	0.8	2	3.3	5.5	6	6			
		8	10	10	10	10	10	10	10	8	8	0.2	0.4	0.7	1.7	2.8	4.5	6	6			
	B, C	6	10	10	10	10	10	10	10	8	8	0.2	0.4	0.7	1.5	2.5	3.5	5	6			
			13	10	10	10	10	10	10	8	8			0.7	1.5	2.5	3.5	5	6			
			16		10	10	10	10	10	8	8				1.3	2	2.9	4.1	6			
			20			10	10	10	10	8	8					1.8	2.6	3.5	5			
			25				10	10	10	8	8					1.8	2.6	3.5	5			
			32					10	10	8	8						2.2	3	4			
			40						10	10	8	8							2.5	4		
			50/63							8	8									3.5		
	S 200 M	C	≤ 2	>15	>15	>15	>15	>15	>15	>15	>15	>15	1	1.2	4	>15	>15	>15	>15	>15		
3			15	15	15	15	15	15	15	10	10	0.3	0.7	1.2	4.6	10	10	10	10			
4			15	15	15	15	15	15	15	10	10	0.3	0.6	0.9	2.8	10	10	10	10			
B, C		6	15	15	15	15	15	15	15	10	10	0.2	0.5	0.8	1.7	3.1	7	10	10			
		8	15	15	15	15	15	15	15	10	10	0.2	0.4	0.7	1.4	2.3	3.4	4.8	7.5			
B, C		6	10	15	15	15	15	15	15	15	10	10	0.2	0.4	0.7	1.4	2.3	3.4	4.8	7.5		
			13	15	15	15	15	15	15	15	10	10			0.7	1.4	2.3	3.4	4.8	7.5		
			16		15	15	15	15	15	15	10	10				1.3	2	2.9	4.2	6		
			20			15	15	15	15	15	10	10					1.9	2.7	3.8	5.6		
			25				15	15	15	15	10	10					1.9	2.6	3.6	5.4		
			32					15	15	15	10	10						2.4	3.2	4.2		
			40						15	15	10	10							3.2	4.2		
			50/63							10	10									3.8		

■ Limited overload selectivity

MCBs technical details

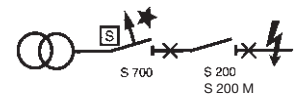
Coordination tables: selectivity

MCB																											
Supply side		S 700										fuse															
Load side		Char. E/K										gG															
		Icu [kA] 25																									
		In [A]	16	20	25	35	40	50	63	80	100	16	20	25	35	50	63	80	100								
S 200 S 200 M	K	6	≤ 2	>15	>15	>15	>15	>15	>15	>15	>15	>15	0.3	1.2	4	>15	>15	>15	>15	>15							
			3	10	10	10	10	10	10	10	10	10	10	0.3	0.7	1.2	4.6	6	6	6	6						
			4	10	10	10	10	10	10	10	10	10	10	0.3	0.6	0.9	2.8	6	6	6	6						
			6	10	10	10	10	10	10	10	10	10	10		0.7	1.7	3	5.9	6	6							
			8	10	10	10	10	10	10	10	10	10	10			1.3	2.2	3.6	6	6							
			10	10	10	10	10	10	10	10	10	10	10				1.7	2.5	4	6							
			16		10	10	10	10	10	10	10	10	10						2.2	3.1	4.6						
			20			10	10	10	10	10	10	10	10								3.1	4.6					
			25				10	10	10	10	10	10	10									2.6	3.5				
			32					10	10	10	10	10	10										3.5				
			40						10	10	10	10	10														
			50/63							10	10	10	10														
			S 200 S 200 M	Z	6	≤ 2	>15	>15	>15	>15	>15	>15	>15	>15	>15	0.5	2	>15	>15	>15	>15	>15	>15				
						3	10	10	10	10	10	10	10	10	10	10	0.3	0.7	1.8	6	6	6	6	6			
4	10	10				10	10	10	10	10	10	10	10	0.3	0.6	1.3	7	6	6	6	6						
6	10	10				10	10	10	10	10	10	10	10	0.2	0.5	0.9	2.7	6	6	6	6						
8	10	10				10	10	10	10	10	10	10	10	0.2	0.5	0.6	1.7	3.8	6	6	6						
10	10	10				10	10	10	10	10	10	10	10		0.4	0.6	1.3	2.4	4	6	6						
16		10				10	10	10	10	10	10	10	10			0.5	1.1	1.7	3	4.5	6						
20						10	10	10	10	10	10	10	10				0.9	1.5	2.3	3.5	5.2						
25							10	10	10	10	10	10	10					1.4	2	3	4						
32								10	10	10	10	10	10					1.4	2	3	4						
40									10	10	10	10	10							2	3	4					
50/63										10	10	10	10								2.2	3.5					

Limited overload selectivity

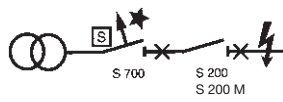
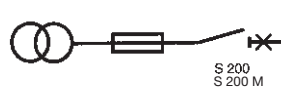
MCB																				
		Supply side										fuse								
Load side		S 700										gG								
Char.		E/K										gG								
		Icu [kA]																		
		25																		
		In [A]	16	20	25	35	40	50	63	80	100	16	20	25	35	50	63	80	100	
S 200 P	B	6	6	25	25	25	25	25	25	25	25	0.2	0.4	0.6	1.2	2.2	3.7	6	10	
			10	25	25	25	25	25	25	25	25	25	0.2	0.4	0.6	1.1	1.8	2.7	4	6
			13	25	25	25	25	25	25	25	25	25			0.6	1	1.7	2.5	3.7	5.5
			16		25	25	25	25	25	25	25	25				1	1.6	2.4	3.5	5.3
			20			25	25	25	25	25	25	25				1	1.6	2.2	3.3	4.7
			25				25	25	25	25	25	25					1.5	2	3	4
			32					25	25	25	25	25					1.3	2	2.8	3.6
			40						25	25	25	25						1.9	2.7	3.4
			50/63								10	10							2.7	3.4
						≤ 2	>25	>25	>25	>25	>25	>25	>25	1	2	>25	>25	>25	>25	>25
S 200 P	C	6	3	25	25	25	25	25	25	25	25	0.3	0.8	1.5	6	10	10	10	10	
			4	25	25	25	25	25	25	25	25	25	0.3	0.6	1	3.3	6	10	10	10
			6	25	25	25	25	25	25	25	25	25			0.6	1.3	3	5.5	10	10
			8	25	25	25	25	25	25	25	25	25				1.1	2.9	3.5	6	10
			10	25	25	25	25	25	25	25	25	25				1	1.7	2.5	4	6
			13	25	25	25	25	25	25	25	25	25					1.8	2.2	3	5.5
			16		25	25	25	25	25	25	25	25					1.6	2	3	5
			20			25	25	25	25	25	25	25						1.6	2.8	3.6
			25				25	25	25	25	25	25							2.4	3.5
			32					25	25	25	25	25								3.1
			≤ 2	>15	>15	>15	>15	>15	>15	>15	0.3	1	>15	>15	>15	>15	>15	>15		
S 200 P	K	6	3	15	15	15	15	15	15	15	15	0.3	0.8	1.5	6	6	6	10	10	
			4	15	15	15	15	15	15	15	15	15	0.3	0.6	1	3.3	6	6	6	10
			6	15	15	15	15	15	15	15	15	15			0.6	1.3	3	5.5	6	9.5
			8	15	15	15	15	15	15	15	15	15				1.1	2.5	3.5	6	6
			10	25	25	25	25	25	25	25	25	25				1	1.7	2.5	4	6
			13	25	25	25	25	25	25	25	25	25					1.6	2.2	3	5.5
			16		25	25	25	25	25	25	25	25					1.5	2	3	5
			20			25	25	25	25	25	25	25						1.6	2.6	3.6
			25				15	15	15	15	15	15							2.4	3.3
			32					15	15	15	15	15								3.1
			≤ 2	>15	>15	>15	>15	>15	>15	>15	0.3	1	>15	>15	>15	>15	>15	>15		

Limited overload selectivity

MCBs technical details

Coordination tables: selectivity

MCB																				
Supply side		S 700										fuse								
Load side		E/K										gG								
		Icu [kA]										25								
		In [A]										16 20 25 35 40 50 63 80 100 16 20 25 35 50 63 80 100								
S 200 P	Z	6	≤ 2	>15	>15	>15	>15	>15	>15	>15	>15	>15	0.3	1	>15	>15	>15	>15	>15	>15
			3	15	15	15	15	15	15	15	15	15	0.3	0.6	1.8	10	10	10	10	10
			4	15	15	15	15	15	15	15	15	15	0.3	0.6	0.6	1.3	6	10	10	10
			6	15	15	15	15	15	15	15	15	15			0.8	2.6	6	10	10	
			8	15	15	15	15	15	15	15	15	15				1.7	3.4	7	10	
			10	25	25	25	25	25	25	25	25	25				1.3	2.2	3.7	6	
			16		25	25	25	25	25	25	25	25					1.7	2.8	4.1	
			20			25	25	25	25	25	25	25						2.1	3.1	
			25				15	15	15	15	15	15							2.6	
			32					15	15	15	15	15								
			40						15	15	15	15								
			50/63								10	10								

Limited overload selectivity

Limit of selectivity

For the coordination of MCB, S 700 and upstream fuses the following selectivity limits can be assumed:

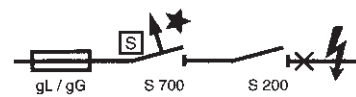

Upstream		fuse 63 A gG								fuse 80 A gG				
Supply side		S 700								S 700				
Load side		E/K								E/K				
		Icu [kA]								25				
		In [A]								35 40 50 63 80 100 35 40 50 63 80 100				
S 200	C	≤ 2	>15	>15	>15	>15				>15	>15	>15	>15	>15
		3	10	10	10	10				10	10	10	10	8
		4	10	10	10	10				10	10	10	10	8
	B, C	6	10	10	10	10				10	10	10	10	8
		8	7.5	7	7	6				10	10	10	8	8
	B, C	10	7.5	7	7	6				10	10	10	8	6
		13	6	6	6	6				10	10	9	7.5	6
		16	6	6	6	6				10	10	9	7.5	6
		20	6	6	5	5				9	8	8	6	6
		25		4.5	4.5	4.5					7.5	7.5	6	6
		32			4.5	4.5						6	6	6
		40				4							6	6
		50												4.5
50/63														

Values for < 6 A and 8 A are only valid for C characteristic.

Upstream			fuse 100 A gG							fuse M 125 A gG						
Supply side			S 700							S 700						
Load side	Char.	Icu [kA]	In [A]	E/K							E/K					
				25	35	40	50	63	80	100	25	35	40	50	63	80
S 200	C	6	≤ 2	>15	>15	>15	>15	>15	>15	>15	>15	>15	>15	>15	>15	>15
			3	10	10	10	10	8	8	10	10	10	10	8	8	
			4	10	10	10	10	8	8	10	10	10	10	8	8	
	B, C		6	10	10	10	10	8	8	10	10	10	10	8	8	
			8	10	10	10	10	8	8	10	10	10	10	8	8	
	B, C		10	10	10	10	10	8	8	10	10	10	10	8	8	
			13	10	10	10	10	8	8	10	10	10	10	8	8	
			16	10	10	10	10	8	8	10	10	10	10	8	8	
			20	10	10	10	10	8	8	10	10	10	10	8	8	
			25		10	10	10	8	8		10	10	10	8	8	
			32			10	10	8	7.5			10	10	8	8	
			40				10	8	7				10	8	8	
			50					7	6					8	8	
	63							5						8		

Upstream			fuse 63 A gG							fuse 80 A gG						
Supply side			S 700							S 700						
Load side	Char.	Icu [kA]	In [A]	E/K							E/K					
				25	35	40	50	63	80	100	25	35	40	50	63	80
S 200 M	C	10	≤ 2	>15	>15	>15	>15				>15	>15	>15	>15	>15	
			3	15	15	15	15				15	15	15	15	10	
			4	15	15	15	15				15	15	15	15	10	
	B, C		6	15	15	15	15				15	15	15	15	10	
			8	7.5	7	7	6				12.5	10	10	10	6	
	B, C		10	7.5	7	7	6				12.5	10	10	10	6	
			13	6	6	6	5				10	10	9	7.5	6	
			16	6	6	6	5				10	10	9	7.5	6	
			20	6	6	5	5				9	8	8	6	6	
			25		4.5	4.5	4.5					7.5	7.5	6	6	
			32			4.5	4.5						6	6	6	
			40				4							6	6	
			50												4.5	
	63															

10

Values for < 6 A and 8 A are only valid for C characteristic.

MCBs technical details

Coordination tables: selectivity

Upstream		fuse 100 A gG							fuse M 125 A gG							
Supply side		S 700							S 700							
Load side	Char.	Icu [kA]	E/K							E/K						
			In [A]	35	40	50	63	80	100	35	40	50	63	80	100	
S 200 M	C	10	≤ 2	>15	>15	>15	>15	>15	>15	>15	>15	>15	>15	>15	>15	>15
			3	15	15	15	15	10	10	15	15	15	15	10	10	
			4	15	15	15	15	10	10	15	15	15	15	10	10	
			6	15	15	15	15	10	10	15	15	15	15	10	10	
	B, C		8	15	15	15	15	10	10	15	15	15	15	10	10	
			10	15	15	15	15	10	10	15	15	15	15	10	10	
	B, C		13	15	12,5	12,5	12,5	10	10	15	15	15	15	10	10	
			16	15	12,5	12,5	12,5	10	10	15	15	15	15	10	10	
			20	12,5	10	12,5	10	10	10	15	15	15	15	10	10	
			25		10	10	10	10	9		15	15	15	10	10	
			32			10	10	10	7,5			15	15	10	10	
			40				10	9	7				15	10	10	
				50				7	6					10	10	
				63					5						10	

Upstream		fuse 63 A gG							fuse 80 A gG							
Supply side		S 700							S 700							
Load side	Char.	Icu [kA]	E/K							E/K						
			In [A]	35	40	50	63	80	100	35	40	50	63	80	100	
S 200 P	C	25	≤ 2	>25	>25	>15	>15			>25	>25	>25	>25	>25		
			3	15	15	15	15			25	25	15	15	15		
			4	15	15	15	15			25	25	15	15	15		
			6	15	15	15	15			25	25	15	15	15		
	B, C		8	7,5	7	7	6			12,5	10	12,5	10	10		
			10	7,5	7	7	6			12,5	10	12,5	10	6		
	B, C		13	6	6	6	5			10	10	10	8	6		
			16	6	6	6	5			10	10	10	8	6		
			20	6	6	5	5			9	8	8	7	6		
			25		4,5	4,5	4,5				7,5	7,5	6	6		
			32			4,5	4,5						6	6	6	
			40				4							6	6	
				50										4,5		
				63												

Values for < 6 A and 8 A are only valid for C characteristic.

Upstream		fuse 100 A gG								fuse 125 A gG						
Supply side		S 700								S 700						
Load side	Char.	Icu [kA]	In [A]	E/K						E/K						
				35	40	50	63	80	100	35	40	50	63	80	100	
S 200 P	C	25	≤ 2	>25	>25	>25	>25	>25	>25	>25	>25	>25	>25	>25	>25	>25
			3	25	25	25	25	25	25	25	25	25	25	25	25	25
			4	25	25	25	25	25	25	25	25	25	25	25	25	25
	B, C		6	25	25	25	25	25	25	25	25	25	25	25	25	25
			C	8	20	17	15	15	13	10	25	25	25	25	15	15
	B, C		10	20	17	15	15	13	10	25	25	25	25	25	25	25
			13	19	17	15	12.5	10	10	25	25	25	25	25	25	25
			16	19	17	15	12.5	10	10	25	25	25	25	25	25	25
			20	17	17	15	10	10	10	25	25	25	25	25	25	25
			25		15	15	10	10	9		25	22	20	20	20	
			32			15	10	10	9			20	20	15	20	
			40				10	9	9					15	15	15
			50					7	7						10	10
			63						6							10

Upstream		fuse 160 A gG								fuse 200 A gG						
Supply side		S 700								S 700						
Load side	Char.	Icu [kA]	In [A]	E/K						E/K						
				35	40	50	63	80	100	35	40	50	63	80	100	
S 200 P	C	25	≤ 2	>25	>25	>25	>25	>25	>25	>25	>25	>25	>25	>25	>25	>25
			3	25	25	25	25	25	25	25	25	25	25	25	25	25
			4	25	25	25	25	25	25	25	25	25	25	25	25	25
	B, C		6	25	25	25	25	25	25	25	25	25	25	25	25	25
			C	8	25	25	25	25	15	15	25	25	25	25	15	15
	B, C		10	25	25	25	25	25	25	25	25	25	25	25	25	25
			13	25	25	25	25	25	25	25	25	25	25	25	25	25
			16	25	25	25	25	25	25	25	25	25	25	25	25	25
			20	25	25	25	25	25	25	25	25	25	25	25	25	25
			25		25	25	25	25	25		25	25	25	25	25	25
			32			25	25	25	25			25	25	25	25	25
			40				25	25	25					25	25	25
			50					15	10						25	10
			63						10							10

Values for < 6 A and 8 A are only valid for C characteristic.

MCBs technical details

Coordination tables: selectivity

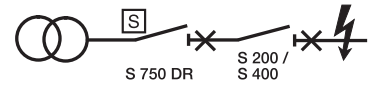
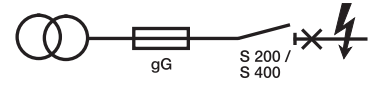

Short-circuit discrimination of S750 DR with respect to downstream MCB S200/S400 compared to fuse protection¹⁾

MCBs																
final circuit:	supply side:	S750 DR								fuse						
	Char.	E/K								gG						
circuit:	I_{cu} [kA]	25														
		I_n [A]	16	20	25	35	40	50	63	16	20	25	35	50	63	
S200	C	6	≤ 2	10	10	10	10	10	10	10	1	1.2	4	6	6	6
			3	10	10	10	10	10	10	10	0.3	0.7	1.2	4.6	6	6
			4	10	10	10	10	10	10	10	0.3	0.6	0.9	2.8	6	6
			6	10	10	10	10	10	10	10	0.2	0.4	0.7	1.5	3	5.5
S400E	B, C	6	8	10	10	10	10	10	10	0.2	0.4	0.7	1.4	2.8	4.5	
			10	10	10	10	10	10	10	10	0.2	0.4	0.6	1.2	2	3.3
S400E	B, C	6	13	10	10	10	10	10	10			0.6	1.2	2	3.3	
			16		10	10	10	10	10	10			0.6	1.1	1.8	2.8
			20			10	10	10	10	10				1	1.6	2.4
			25				10	10	10	10					1.6	2.4
			32					10	10	10					1.3	2.2
			40						10	10						2.2

final circuit:		supply side:	S750 DR								fuse					
circuit:	I_{cu} [kA]	Char.	E/K								gG					
		I_n [A]	16	20	25	35	40	50	63	16	20	25	35	50	63	
S200	K	6	≤ 2	10	10	10	10	10	10	10	0.3	1.2	4	6	6	6
			3	10	10	10	10	10	10	10	0.3	0.7	1	3.2	6	6
			4	10	10	10	10	10	10	10	0.3	0.6	0.8	2.1	5.3	6
			6	10	10	10	10	10	10	10	0.2	0.4	0.7	1.3	2.8	6
			8	10	10	10	10	10	10	10	0.2	0.4	0.6	1.1	2	3.5
			10	10	10	10	10	10	10	10	0.2	0.3	0.5	0.9	1.5	2.3
			16		10	10	10	10	10	10			0.4	0.8	1.3	2.1
			20			10	10	10	10	10				0.8	1.3	2.1
			25				10	10	10	10					1.1	1.7
			32					10	10	10					1.1	1.7
						10	10						1.3			

¹⁾ The selectivity limit current I_{s1} results from the let-through I^2t -value of S200/S400 and the pre-arcing (melting) I^2t -value of a fuse acc. to IEC/EN 60269

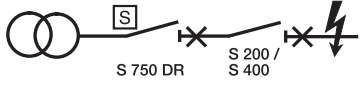
Short-circuit discrimination of S 750 DR with respect to downstream MCB S 200 / S 400 compared to fuse protection¹⁾

MCBs																	
final	supply side:	S750 DR								fuse							
	Char.	E/K								gG							
circuit:	I_{cu} [kA]	25															
		I_n [A]	16	20	25	35	40	50	63	16	20	25	35	50	63		
S 200	Z	6	≤2	10	10	10	10	10	10	10	0.5	2	6	6	6	6	
			3	10	10	10	10	10	10	10	0.3	0.7	1.2	6	6	6	
			4	10	10	10	10	10	10	10	0.3	0.6	1.1	4.2	6	6	
			6	10	10	10	10	10	10	10	0.2	0.4	0.8	2	5.2	6	
			8	10	10	10	10	10	10	10	0.2	0.4	0.6	1.3	3.1	6	
			10	10	10	10	10	10	10	10	0.3	0.5	1	2	3.6		
			16		10	10	10	10	10	10		0.5	0.9	1.5	2.8		
			20			10	10	10	10	10			0.7	1.2	2.1		
			25				10	10	10	10				1.1	1.8		
			32					10	10	10				1.1	1.8		
							10	10						1.8			

final	supply side:	S750 DR								fuse						
	Char.	E/K								gG						
circuit:	I_{cu} [kA]	25														
		I_n [A]	16	20	25	35	40	50	63	16	20	25	35	50	63	
S 200 M	C	10	≤2	15	15	15	15	15	15	15	1	1.2	4	10	10	10
			3	15	15	15	15	15	15	15	0.3	0.7	1.2	4.6	10	10
			4	15	15	15	15	15	15	15	0.3	0.6	0.9	2.8	10	10
			6	15	15	15	15	15	15	15	0.2	0.5	0.8	1.5	3	7
			8	15	15	15	15	15	15	15	0.2	0.4	0.7	1.4	2.8	4.5
S 400 M	B, C	10	10	15	15	15	15	15	15	0.2	0.4	0.6	1.2	2	3.3	
			13	15	15	15	15	15	15	15		0.6	1.2	2	3.3	
			16		15	15	15	15	15	15		0.6	1.1	1.8	2.8	
			20			15	15	15	15	15			1	1.6	2.4	
			25				15	15	15	15				1.6	2.4	
			32					15	15	15				1.3	2.2	
			40						15	15					2.2	

10

final	supply side:	S750 DR								fuse						
	Char.	E/K								gG						
circuit:	I_{cu} [kA]	25														
		I_n [A]	16	20	25	35	40	50	63	16	20	25	35	50	63	
S 200 M	K	10	≤2	10	10	10	10	10	10	10	0.3	1.2	4	10	10	10
			3	10	10	10	10	10	10	10	0.3	0.7	1	3.2	10	10
			4	10	10	10	10	10	10	10	0.3	0.6	0.8	2.1	5.3	10
			6	10	10	10	10	10	10	10	0.2	0.4	0.7	1.3	2.8	6
			8	10	10	10	10	10	10	10	0.2	0.4	0.6	1.1	2	3.5
S 400 M	K	10	10	10	10	10	10	10	10	0.2	0.3	0.5	0.9	1.5	2.3	
			16		10	10	10	10	10	10		0.4	0.8	1.3	2.1	
			20			10	10	10	10	10			0.8	1.3	2.1	
			25				10	10	10	10				1.1	1.7	
			32					10	10	10				1.1	1.7	
			40						10	10					1.3	

¹⁾ The selectivity limit current I_{s1} results from the let-through Pt-value of S 200/S 400 and the pre-arcing (melting) Pt-value of a fuse acc. to IEC/EN 60269

MCBs technical details

Coordination tables: selectivity

Short-circuit discrimination of S 750 DR with respect to downstream MCB S 200/S 400 compared to fuse protection¹⁾

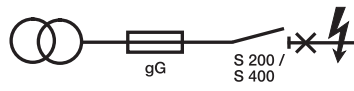
MCBs																
final circuit:	supply side:	S 750 DR								fuse						
	Char.	E/K								gG						
	I_{cu} [kA]	25														
	I_n [A]	16	20	25	35	40	50	63	16	20	25	35	50	63		
S 200 M	Z	10	≤ 2	10	10	10	10	10	10	10	0.5	2	10	10	10	10
			3	10	10	10	10	10	10	10	0.3	0.7	1.2	7	10	10
			4	10	10	10	10	10	10	10	0.3	0.6	1.1	4.2	10	10
			6	10	10	10	10	10	10	10	0.2	0.4	0.8	2	5.2	10
			8	10	10	10	10	10	10	10	0.2	0.4	0.6	1.3	3.1	8
			10	10	10	10	10	10	10	10		0.3	0.5	1	2	3.6
			16		10	10	10	10	10	10			0.5	0.9	1.5	2.8
			20			10	10	10	10	10				0.7	1.2	2.1
			25				10	10	10	10					1.1	1.8
			32					10	10	10					1.1	1.8
40						10	10						1.8			

final circuit:	supply side:	S 750 DR								fuse						
	Char.	E/K								gG						
	I_{cu} [kA]	25														
	I_n [A]	16	20	25	35	40	50	63	16	20	25	35	50	63		
S 200 P	B	25	6	25	25	25	25	25	25	25	0.2	0.4	0.6	1.2	2.6	6
			10	25	25	25	25	25	25	25	0.2	0.3	0.5	1	1.8	3.1
			13	25	25	25	25	25	25	25			0.5	1	1.7	3
			16		25	25	25	25	25	25			0.5	0.9	1.6	3
			20			25	25	25	25	25				0.9	1.4	2.3
			25				25	25	25	25					1.4	2.3
			32					15	15	15					1.2	2.1
			40						15	15						2.1

final circuit:	supply side:	S 750 DR								fuse						
	Char.	E/K								gG						
	I_{cu} [kA]	25														
	I_n [A]	16	20	25	35	40	50	63	16	20	25	35	50	63		
S 200 P	C	25	≤ 2	25	25	25	25	25	25	25	1	2	25	25	25	25
			3	25	25	25	25	25	25	25	0.3	0.8	1.5	6	10	10
			4	25	25	25	25	25	25	25	0.3	0.6	1	3.3	6	10
			6	25	25	25	25	25	25	25	0.2	0.4	0.6	1.2	2.6	6
			8	25	25	25	25	25	25	25	0.2	0.4	0.6	1.1	2.4	4
			10	25	25	25	25	25	25	25	0.2	0.3	0.5	1	1.8	3.1
			13	25	25	25	25	25	25	25			0.5	1	1.7	3
			16		25	25	25	25	25	25			0.5	0.9	1.6	3
			20			25	25	25	25	25				0.9	1.4	2.3
			25				25	25	25	25					1.4	2.3
			32					15	15	15					1.2	2.1
			40						15	15						2.1

¹⁾ The selectivity limit current I_{s1} results from the let-through I^2t -value of S 200/S 400 and the pre-arcing (melting) I^2t -value of a fuse acc. to IEC / EN 60269

Short-circuit discrimination of S 750 DR with respect to downstream MCB S 200/S 400 compared to fuse protection¹⁾

MCBs																	
final	supply side:	S 750 DR	fuse														
	Char.	E/K	gG														
circuit:	I_{cs} [kA]	25															
	I_n [A]	16	20	25	35	40	50	63	16	20	25	35	50	63			
S 200 P	K	25	≤ 2	25	25	25	25	25	25	25	0.4	0.7	3	25	25	25	
			3	25	25	25	25	25	25	25	0.4	0.6	1	3.5	10	10	
			4	25	25	25	25	25	25	25	0.3	0.5	0.9	2.1	7	10	
			6	25	25	25	25	25	25	25	0.3	0.4	0.6	1.2	2.8	5.5	
			8	25	25	25	25	25	25	25	0.3	0.4	0.5	1.2	2.5	4	
			10	25	25	25	25	25	25	25	0.2	0.3	0.4	0.9	1.7	3.1	
			13	25	25	25	25	25	25	25		0.3	0.4	0.8	1.3	2.2	
			16		25	25	25	25	25	25			0.4	0.8	1.2	2	
			20			25	25	25	25	25				0.7	1.1	1.8	
			25				25	25	25	25					1	1.5	
			15	32					15	15	15					1	1.5
				40						15	15						1.3

final		supply side:	S 750 DR						fuse								
Char.			E/K						gG								
circuit:		I_{cs} [kA]	25														
		I_n [A]	16	20	25	35	40	50	63	16	20	25	35	50	63		
S 200 P	Z	25	≤ 2	25	25	25	25	25	25	25	0.6	1.2	25	25	25	25	
			3	25	25	25	25	25	25	25	0.4	0.6	1	3.5	10	10	
			4	25	25	25	25	25	25	25	0.3	0.5	0.9	2.1	7	10	
			6	25	25	25	25	25	25	25	0.3	0.4	0.6	1.2	2.8	6	
			8	25	25	25	25	25	25	25	0.3	0.4	0.5	1.1	2.5	3.5	
			10	25	25	25	25	25	25	25	0.2	0.3	0.4	1	1.9	3.3	
			16		25	25	25	25	25	25			0.4	0.9	1.6	3	
			20			25	25	25	25	25				0.9	1.3	2.3	
			25				25	25	25	25					1.3	2.2	
			15	32					15	15	15					1.2	2.1
				40						15	15						2.1

¹⁾ The selectivity limit current I_{sl} results from the let-through I^2t -value of S 200/S 400 and the pre-arcing (melting) I^2t -value of a fuse acc. to IEC/EN 60269

MCBs technical details

Coordination tables: selectivity

Short-circuit discrimination (in kA) apply for combinations¹⁾: fuse gL/gG – S750 DR – S200/S400

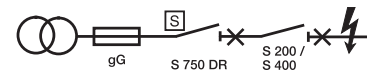

		fuse: 63A gG				80A gG				100A gG				≥ 125A gG					
final		supply side: S750 DR																	
Char.		E/K																	
circuit:	I _{co} [kA]	25																	
		I _n [A]	35	40	50	63	35	40	50	63	35	40	50	63	35	40	50	63	
S200 S400E	6	C	≤2	15	15	15	15	15	15	15	15	15	15	15	15	15	15	15	15
			3	10	10	10	10	10	10	10	10	10	10	10	10	10	10	10	10
			4	10	10	10	10	10	10	10	10	10	10	10	10	10	10	10	10
		B, C	6	10	10	10	10	10	10	10	10	10	10	10	10	10	10	10	10
			8	7	6	6	5	10	10	10	8	10	10	10	10	10	10	10	10
		B, C	10	7	6	6	5	10	10	10	8	10	10	10	10	10	10	10	10
			13	6	6	6	5	9	8	8	7	10	10	10	10	10	10	10	10
			16	6	6	6	5	9	8	8	7	10	10	10	10	10	10	10	10
			20	5	5	4.5	4.5	6	7	7	6.5	10	10	10	10	10	10	10	10
			25		4.5	4.5	4		7	6	6		10	10	10		10	10	10
	32			4	3.5			6	5.5			9	9			10	10		
	40				3				5				8				10		

		fuse: 63A gG				80A gG				100A gG				≥ 125A gG					
final		supply side: S750 DR																	
Char.		E/K																	
circuit:	I _{co} [kA]	25																	
		I _n [A]	35	40	50	63	35	40	50	63	35	40	50	63	35	40	50	63	
S200 S400E	6	K, Z	≤2	15	15	15	15	15	15	15	15	15	15	15	15	15	15	15	15
			3	10	10	10	10	10	10	10	10	10	10	10	10	10	10	10	10
			4	10	10	10	10	10	10	10	10	10	10	10	10	10	10	10	10
			6	10	10	10	10	10	10	10	10	10	10	10	10	10	10	10	10
			8	7	6	6	5	10	10	10	8	10	10	10	10	10	10	10	10
			10	7	6	6	5	10	10	10	8	10	10	10	10	10	10	10	10
			13	6	6	6	5	9	8	8	7	10	10	10	10	10	10	10	10
			16	6	6	6	5	9	8	8	7	10	10	10	10	10	10	10	10
			20	5	5	4.5	4.5	8	7	7	6.5	10	10	10	10	10	10	10	10
			25		4.5	4.5	4		7	6	6		10	10	10		10	10	10
	32			4	3.5			6	5.5			9	9			10	10		
	40				3				5				8				10		

¹⁾ The selectivity limit current I_{st} results from the let-through I²t-value of S750 DR plus S200/S400 and the pre-arcing (melting) I²t-value of a fuse acc. to IEC/EN 60269

Short-circuit discrimination (in kA) apply for combinations¹⁾: fuse gL/gG – S750 DR – S200/S400

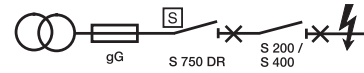

		fuse:				63A gG				80A gG				100A gG				≥ 125A gG			
		supply side:				S750 DR															
final circuit:	Char.	I _{cu} [kA]	E/K																		
			25																		
		I _n [A]	35	40	50	63	35	40	50	63	35	40	50	63	35	40	50	63			
S200 M	C	≤2	15	15	15	15	15	15	15	15	15	15	15	15	15	15	15	15			
		3	15	15	15	15	15	15	15	15	15	15	15	15	15	15	15	15			
		4	15	15	15	15	15	15	15	15	15	15	15	15	15	15	15	15			
	B, C	6	10	10	10	10	15	15	15	10	15	15	15	15	15	15	15	15			
		8	7	6	6	5	10	10	10	8	15	15	15	15	15	15	15	15			
	S400 M	B, C	10	7	6	6	5	10	10	10	8	15	15	15	15	15	15	15	15		
			13	6	6	6	5	9	8	8	7	10	10	10	10	15	15	15	15		
			16	6	6	6	5	9	8	8	7	10	10	10	10	15	15	15	15		
			20	5	5	4.5	4.5	8	7	7	6.5	10	10	10	10	15	15	15	15		
			25		4.5	4.5	4	7	6	6		10	10	10		15	15	15			
32					4	3.5		6	5.5			9	9			15	15				
40						3			5				8				14				

		fuse:				63A gG				80A gG				100A gG				≥ 125A gG			
		supply side:				S750 DR															
final circuit:	Char.	I _{cu} [kA]	E/K																		
			25																		
		I _n [A]	35	40	50	63	35	40	50	63	35	40	50	63	35	40	50	63			
S200 M	K, Z	≤2	15	15	15	15	15	15	15	15	15	15	15	15	15	15	15	15			
		3	15	15	15	15	15	15	15	15	15	15	15	15	15	15	15	15			
		4	15	15	15	15	15	15	15	15	15	15	15	15	15	15	15	15			
		6	10	10	10	10	15	15	15	10	15	15	15	15	15	15	15	15			
		8	7	6	6	5	10	10	10	8	15	15	15	15	15	15	15	15			
		10	7	6	6	5	10	10	10	8	15	15	15	15	15	15	15	15			
		13	6	6	6	5	9	8	8	7	10	10	10	10	15	15	15	15			
		16	6	6	6	5	9	8	8	7	10	10	10	10	15	15	15	15			
		20	5	5	4.5	4.5	8	7	7	6.5	10	10	10	10	15	15	15	15			
		25		4.5	4.5	4	7	6	6		10	10	10		15	15	15				
S400 M	K, Z	32			4	3.5		6	5.5			9	9			15	15				
		40				3			5				8				14				

10

¹⁾ The selectivity limit current I_{sl} results from the let-through I_t-value of S750 DR plus S200/S400 and the pre-arcing (melting) I_t-value of a fuse acc. to IEC/EN 60269

MCBs technical details

Coordination tables: selectivity

Short-circuit discrimination (in kA) apply for combinations¹⁾: fuse gL/gG – S 750 DR – S 200/S 400

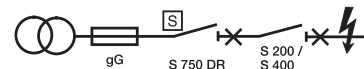

fuse:		63A gG				80A gG				100A gG				≥ 125A gG				
supply side:		S 750 DR																
final circuit:	Char.	I _{ca} [kA]	E/K															
			25															
		I _n [A]	35	40	50	63	35	40	50	63	35	40	50	63	35	40	50	63
S200P	C	≤ 2	15	15	15	15	25	25	25	25	25	25	25	25	25	25	25	25
		3	15	15	15	15	25	25	15	15	25	25	25	25	25	25	25	25
		4	15	15	15	15	20	20	15	15	25	25	25	25	25	25	25	25
	B, C	6	10	10	10	10	17	16	15	14	25	25	20	20	25	25	25	25
		8	7	6	6	5	10	10	10	8	20	20	15	15	25	25	25	25
	B, C	10	7	6	6	5	10	10	10	8	20	15	15	15	25	25	25	25
		13	6	6	6	5	9	8	8	7	15	15	15	15	22	22	20	20
		16	6	6	6	5	9	8	8	7	12	12	10	10	22	22	20	18
		20	5	5	4.5	4.5	8	7	7	6.5	12	12	10	10	20	20	20	18
		25		4.5	4.5	4		7	6	6		10	10	10		15	15	15
		32			4	3.5			6	5.5			10	10			15	15
		40				3				5				9				15

fuse:		63A gG				80A gG				100A gG				≥ 125A gG					
supply side:		S 750 DR																	
final circuit:	Char.	I _{ca} [kA]	E/K																
			25																
		I _n [A]	35	40	50	63	35	40	50	63	35	40	50	63	35	40	50	63	
S200P	K, Z	50	≤ 2	15	15	15	15	25	25	25	25	25	25	25	25	25	25	25	25
		3	15	15	15	15	25	25	15	15	25	25	25	25	25	25	25	25	
		4	15	15	15	15	20	20	15	15	25	25	25	25	25	25	25	25	
	25	6	10	10	10	10	17	16	15	14	25	25	20	20	25	25	25	25	
		8	7	6	6	5	10	10	10	8	20	20	15	15	25	25	25	25	
	15	10	7	6	6	5	10	10	10	8	20	15	15	15	25	25	25	25	
		13	6	6	6	5	9	8	8	7	15	15	15	15	22	22	20	20	
		16	6	6	6	5	9	8	8	7	12	12	10	10	22	22	20	18	
		20	5	5	4.5	4.5	8	7	7	6.5	12	12	10	10	20	20	20	18	
		25		4.5	4.5	4		7	6	6		10	10	10		15	15	15	
		32			4	3.5			6	5.5			10	10			15	15	
		40				3				5				9				15	

¹⁾ The selectivity limit current I_{st} results from the let-through I²t-value of S 750 DR plus S 200/S 400 and the pre-arcing (melting) I²t-value of a fuse acc. to IEC/EN 60269

Taking sub-metering to the next level? Absolutely.

ABB's MID-approved EQ meters offer the same quality as revenue meters, approved meters and verified meters. EQ meters are certified and have verified meter accuracy, which is a critical factor in establishing fairness in cost allocation and distribution among tenants. Many EQ meters are also delivered directly from our factory with first time verification. ABB's EQ meters are high-performance, modular DIN rail-mounted electricity meters that are safe, easy to install and can be integrated with existing and future electrical installations. EQ meters are designed to fulfill any type of sub-metering requirement. www.abb.com/lowvoltage



MCBs technical details

Coordination tables: selectivity

MCCB - S2.. B @ 415 V

				Supply S.	T2	T1 - T2							T1 - T2 - T3							
				Version	B, C, N, S, H, L							B, C, N, S, H, L, V								
Char.	Icu [kA]			Release	TM															
	10	15	25	In [A]	12.5	16	20	25	32	40	50	63	80	100	125	160				
Load S.	B	-	-	-	≤2															
		-	-	-	3															
		-	-	-	4															
		S200	S200M	S200P	6	5.5 ¹	5.5	5.5	5.5	5.5	5.5	5.5	5.5	10.5	T	T	T	T		
		S200	S200M	S200P	8			5.5	5.5	5.5	5.5	5.5	5.5	10.5	T	T	T	T		
		S200	S200M	S200P	10			3 ¹	3	3	3	4.5	7.5	8.5	17	T	T			
		S200	S200M	S200P	13			3 ¹		3	3	4.5	7.5	7.5	12	20	T			
		S200	S200M	S200P	16					3 ¹	3	4.5	5	7.5	12	20	T			
		S200	S200M	S200P	20					3 ¹		3	5	6	10	15	T			
		S200	S200M	S200P	25							3 ¹	5	6	10	15	T			
		S200	S200M-S200P	-	32							3 ¹		6	7.5	12	T			
		S200	S200M-S200P	-	40									5.5 ¹	7.5	12	T			
		S200	S200M-S200P	-	50									3 ¹	5 ²	7.5	10.5			
		S200	S200M-S200P	-	63										5 ²	6 ³	10.5			
		-	-	-	80															
-	-	-	100																	
-	-	-	125																	

1 Value valid only for T2 magnetic only supply side circuit-breaker
3 Value valid only for T3 magnetic only supply side circuit-breaker

2 Value valid only for T2-T3 magnetic only supply side circuit-breaker
4 Value valid only for T4 magnetic only supply side circuit-breaker

10

MCCB - S2.. C @ 415 V

				Supply S.	T2	T1 - T2							T1 - T2 - T3							
				Version	B, C, N, S, H, L							B, C, N, S, H, L, V								
Char.	Icu [kA]			Release	TM															
	10	15	25	In [A]	12.5	16	20	25	32	40	50	63	80	100	125	160				
Load S.	C	S200	S200M	S200P	≤2	T	T	T	T	T	T	T	T	T	T	T	T			
		S200	S200M	S200P	3	T	T	T	T	T	T	T	T	T	T	T	T			
		S200	S200M	S200P	4	T	T	T	T	T	T	T	T	T	T	T	T			
		S200	S200M	S200P	6	5.5 ¹	5.5	5.5	5.5	5.5	5.5	5.5	5.5	10.5	T	T	T	T		
		S200	S200M	S200P	8			5.5	5.5	5.5	5.5	5.5	5.5	10.5	T	T	T	T		
		S200	S200M	S200P	10			3 ¹	3	3	3	4.5	7.5	8.5	17	T	T			
		S200	S200M	S200P	13			3 ¹		3	3	4.5	7.5	7.5	12	20	T			
		S200	S200M	S200P	16					3 ¹	3	4.5	5	7.5	12	20	T			
		S200	S200M	S200P	20					3 ¹		3	5	6	10	15	T			
		S200	S200M	S200P	25							3 ¹	5	6	10	15	T			
		S200	S200M-S200P	-	32							3 ¹		6	7.5	12	T			
		S200	S200M-S200P	-	40									5.5 ¹	7.5	12	T			
		S200	S200M-S200P	-	50									3 ¹	5 ²	7.5	10.5			
		S200	S200M-S200P	-	63										5 ²	6 ³	10.5			

1 Value valid only for T2 magnetic only supply side circuit-breaker
3 Value valid only for T3 magnetic only supply side circuit-breaker
5 Value valid only for T4 In 160 magnetic only supply side circuit-breaker

2 Value valid only for T2-T3 magnetic only supply side circuit-breaker
4 Value valid only for T4 magnetic only supply side circuit-breaker

T3		T4											T5	T2			T4		T5	
TM													EL							
200	250	20	25	32	50	80	100	125	160	200	250	320÷500	10	25	63	100	160	100, 160	250, 320	320÷630
T	T	7.5	7.5 ⁴	7.5	7.5	T	T	T	T	T	T	T		T	T	T	T	T	T	T
T	T	7.5	7.5 ⁴	7.5	7.5	T	T	T	T	T	T	T		T	T	T	T	T	T	T
T	T	5	5 ⁴	5	6.5	9	T	T	T	T	T	T		T	T	T	T	T	T	T
T	T		5 ⁴	5	6.5	8	T	T	T	T	T	T		T	T	T	T	T	T	T
T	T		3 ⁴	5	6.5	8	T	T	T	T	T	T			T	T	T	T	T	T
T	T				5	7.5	T	T	T	T	T	T			T	T	T	T	T	T
T	T				5	7.5	T	T	T	T	T	T			T	T	T	T	T	T
T	T				5 ⁴	7.5	T	T	T	T	T	T			T	T	T	T	T	T
T	T					6.5	T	T	T	T	T	T				T	T	T	T	T
T	T					5 ⁴	T	T	T	T	T	T				10.5	10.5	T	T	T
T	T						T ⁴	T ⁴	T	T	T	T					10.5	T	T	T

T3		T4											T5	T2			T4		T5	
TM													EL							
200	250	20	25	32	50	80	100	125	160	200	250	320÷500	10	25	63	100	160	100, 160	250, 320	320÷630
T	T	T	T	T	T	T	T	T	T	T	T	T	T	T	T	T	T	T	T	T
T	T	T	T	T	T	T	T	T	T	T	T	T	T	T	T	T	T	T	T	T
T	T	T	T	T	T	T	T	T	T	T	T	T	T	T	T	T	T	T	T	T
T	T	7.5	7.5 ⁴	7.5	7.5	T	T	T	T	T	T	T		T	T	T	T	T	T	T
T	T	7.5	7.5 ⁴	7.5	7.5	T	T	T	T	T	T	T		T	T	T	T	T	T	T
T	T	5	5 ⁴	5	6.5	9	T	T	T	T	T	T		T	T	T	T	T	T	T
T	T		5 ⁴	5	6.5	8	T	T	T	T	T	T		T	T	T	T	T	T	T
T	T		3 ⁴	5	6.5	8	T	T	T	T	T	T			T	T	T	T	T	T
T	T				5	7.5	T	T	T	T	T	T			T	T	T	T	T	T
T	T				5	7.5	T	T	T	T	T	T			T	T	T	T	T	T
T	T				5 ⁴	7.5	T	T	T	T	T	T			T	T	T	T	T	T
T	T					6.5	T	T	T	T	T	T				T	T	T	T	T
T	T					5 ⁴	T	T	T	T	T	T				10.5	10.5	T	T	T
T	T						T	T	T	T	T	T					10.5	T	T	T

MCBs technical details

Coordination tables: selectivity

MCCB - S2.. D @ 415 V

				Supply S.	T2	T1 - T2										T1 - T2 - T3				
				Version	B, C, N, S, H, L										B, C, N, S, H, L, V					
Char.	Icu [kA]			Release	TM															
	10	15	25	In [A]	12.5	16	20	25	32	40	50	63	80	100	125	160				
Load S.	D	S200	S200M	S200P	≤2	T	T	T	T	T	T	T	T	T	T	T	T			
		S200	S200M	S200P	3	T	T	T	T	T	T	T	T	T	T	T	T			
		S200	S200M	S200P	4	T	T	T	T	T	T	T	T	T	T	T	T			
		S200	S200M	S200P	6	5.5 ¹	5.5	5.5	5.5	5.5	5.5	5.5	5.5	10.5	T	T	T	T		
		S200	S200M	S200P	8			5.5	5.5	5.5	5.5	5.5	10.5	12	T	T	T			
		S200	S200M	S200P	10			3 ¹	3	3	3	3	5	8.5	17	T	T			
		S200	-	S200P	13					2 ¹	2	2	3	5	8	13.5	T			
		S200	S200M	S200P	16					2 ¹	2	2	3	5	8	13.5	T			
		S200	S200M	S200P	20					2 ¹		2	3	4.5	6.5	11	T			
		S200	S200M	S200P	25							2 ¹	2.5	4	6	9.5	T			
		S200	S200M-S200P	-	32									4	6	9.5	T			
		S200	S200M-S200P	-	40									3 ¹	5	8	T			
		S200	S200M-S200P	-	50									2 ¹	3 ²	5	9.5			
		S200	S200M-S200P	-	63										3 ²	5 ³	9.5			

1 Value valid only for T2 magnetic only supply side circuit-breaker

3 Value valid only for T3 magnetic only supply side circuit-breaker

5 Value valid only for T4 In 160 magnetic only supply side circuit-breaker

2 Value valid only for T2-T3 magnetic only supply side circuit-breaker

4 Value valid only for T4 magnetic only supply side circuit-breaker

MCCB - S2.. K @ 415 V

				Supply S.	T2	T1 - T2										T1 - T2 - T3				
				Version	B, C, N, S, H, L										B, C, N, S, H, L, V					
Char.	Icu [kA]			Release	TM															
	10	15	25	In [A]	12.5	16	20	25	32	40	50	63	80	100	125	160				
Load S.	K	S200	S200M	S200P	≤2	T	T	T	T	T	T	T	T	T	T	T	T			
		S200	S200M	S200P	3	T	T	T	T	T	T	T	T	T	T	T	T			
		S200	S200M	S200P	4	T	T	T	T	T	T	T	T	T	T	T	T			
		S200	S200M	S200P	6	5.5 ¹	5.5	5.5	5.5	5.5	5.5	5.5	10.5	T	T	T	T			
		S200	S200M	S200P	8			5.5	5.5	5.5	5.5	5.5	10.5	12	T	T	T			
		S200	S200M	S200P	10			3 ¹	3	3	3	3	6	8.5	17	T	T			
		S200	-	S200P	13					2 ¹	3	3	5	7.5	10	13.5	T			
		S200	S200M	S200P	16					2 ¹	3	3	4.5	7.5	10	13.5	T			
		S200	S200M	S200P	20					2 ¹		3	3.5	5.5	6.5	11	T			
		S200	S200M	S200P	25							2 ¹	3.5	5.5	6	9.5	T			
		S200	S200M-S200P	-	32									4.5	6	9.5	T			
		S200	S200M-S200P	-	40									3 ¹	5	8	T			
		S200	S200M-S200P	-	50									2 ¹	3 ²	6	9.5			
		S200	S200M-S200P	-	63										3 ²	5.5 ³	9.5			

1 Value valid only for T2 magnetic only supply side circuit-breaker

3 Value valid only for T3 magnetic only supply side circuit-breaker

5 Value valid only for T4 In 160 magnetic only supply side circuit-breaker

2 Value valid only for T2-T3 magnetic only supply side circuit-breaker

4 Value valid only for T4 magnetic only supply side circuit-breaker

T3		T4											T5	T2			T4		T5	
TM													EL							
200	250	20	25	32	50	80	100	125	160	200	250	320÷500	10	25	63	100	160	100, 160	250, 320	320÷630
T	T	T	T	T	T	T	T	T	T	T	T	T	T	T	T	T	T	T	T	T
T	T	T	T	T	T	T	T	T	T	T	T	T	T	T	T	T	T	T	T	T
T	T	T	T	T	T	T	T	T	T	T	T	T	T	T	T	T	T	T	T	T
T	T	7.5	7.5 ⁴	7.5	7.5	T	T	T	T	T	T	T	T	T	T	T	T	T	T	T
T	T	7.5	7.5 ⁴	7.5	7.5	T	T	T	T	T	T	T	T	T	T	T	T	T	T	T
T	T	5	5 ⁴	5	5	9	T	T	T	T	T	T	T	T	T	T	T	T	T	T
T	T		5 ⁴		4	5.5	T	T	T	T	T	T	T	T	T	T	T	T	T	T
T	T				4	5.5	T	T	T	T	T	T	T	T	T	T	T	T	T	T
T	T				4 ⁴	5	T	T	T	T	T	T	T	T	T	T	T	T	T	T
T	T				4 ⁴	4.5	T	T	T	T	T	T	T	T	T	T	T	T	T	T
T	T					4.5 ⁴	T	T	T	T	T	T	T	T	T	T	T	T	T	T
T	T					4.5 ⁴	T	T	T	T	T	T	T	T	T	T	T	T	T	T
T	T						T	T	T	T	T	T	T	T	T	9.5	9.5	T	T	T
T	T							T	T	T	T	T	T	T		9.5	T	T	T	T

T3		T4											T5	T2			T4		T5	
TM													EL							
200	250	20	25	32	50	80	100	125	160	200	250	320÷500	10	25	63	100	160	100, 160	250, 320	320÷630
T	T	T	T	T	T	T	T	T	T	T	T	T	T	T	T	T	T	T	T	T
T	T	T	T	T	T	T	T	T	T	T	T	T	T	T	T	T	T	T	T	T
T	T	T	T	T	T	T	T	T	T	T	T	T	T	T	T	T	T	T	T	T
T	T	7.5	7.5 ⁴	7.5	7.5	T	T	T	T	T	T	T	T	T	T	T	T	T	T	T
T	T	7.5	7.5 ⁴	7.5	7.5	T	T	T	T	T	T	T	T	T	T	T	T	T	T	T
T	T		5 ⁴	5	5	9	T	T	T	T	T	T	T	T	T	T	T	T	T	T
T	T		5 ⁴	5	5	8	T	T	T	T	T	T	T	T	T	T	T	T	T	T
T	T		5 ⁴		5	8	T	T	T	T	T	T	T	T	T	T	T	T	T	T
T	T				5	6	T	T	T	T	T	T	T	T	T	T	T	T	T	T
T	T				5 ⁴	6 ⁴	T	T	T	T	T	T	T	T	T	T	T	T	T	T
T	T				5 ⁴	6 ⁴	T	T	T	T	T	T	T	T	T	T	T	T	T	T
T	T					5.5 ⁴	T	T	T	T	T	T	T	T	T	T	T	T	T	T
T	T					5 ⁴	T	T	T	T	T	T	T	T	T	9.5	9.5	T	T	T
T	T						T	T	T	T	T	T	T	T		9.5	T	T	T	T

MCBs technical details

Coordination tables: selectivity

MCCB - S2.. Z @ 415 V

				Supply S.	T2	T1 - T2										T1 - T2 - T3			
				Version	B, C, N, S, H, L										B, C, N, S, H, L, V				
Load S.	Char.	Icu [kA]			Release	TM													
		10	15	25	In [A]	12.5	16	20	25	32	40	50	63	80	100	125	160		
Z	S200	-	S200P	≤2	T	T	T	T	T	T	T	T	T	T	T	T	T		
	S200	-	S200P	3	T	T	T	T	T	T	T	T	T	T	T	T	T		
	S200	-	S200P	4	T	T	T	T	T	T	T	T	T	T	T	T	T		
	S200	-	S200P	6	5.5 ¹	5.5	5.5	5.5	5.5	5.5	5.5	5.5	10.5	T	T	T	T		
	S200	-	S200P	8			5.5	5.5	5.5	5.5	5.5	10.5	T	T	T	T			
	S200	-	S200P	10			3 ¹	3	3	3	4.5	8	8.5	17	T	T			
	-	-	S200P	13			3 ¹		3	3	4.5	7.5	7.5	12	20	T			
	S200	-	S200P	16					3 ¹	3	4.5	5	7.5	12	20	T			
	S200	-	S200P	20						3 ¹	3	5	6	10	15	T			
	S200	-	S200P	25							3 ¹	5	6	10	15	T			
	S200	S200P	-	32							3 ¹		6	7.5	12	T			
	S200	S200P	-	40									5.5 ¹	7.5	12	T			
	S200	S200P	-	50									4 ¹	5 ²	7.5	10.5			
	S200	S200P	-	63										5 ²	6 ³	10.5			

1 Value valid only for T2 magnetic only supply side circuit-breaker
 3 Value valid only for T3 magnetic only supply side circuit-breaker

2 Value valid only for T2-T3 magnetic only supply side circuit-breaker
 4 Value valid only for T4 magnetic only supply side circuit-breaker

T3		T4											T5		T2			T4		T5	
TM													EL								
200	250	20	25	32	50	80	100	125	160	200	250	320÷500	10	25	63	100	160	100, 160	250, 320	320÷630	
T	T	T	T	T	T	T	T	T	T	T	T	T	T	T	T	T	T	T	T	T	
T	T	T	T	T	T	T	T	T	T	T	T	T	T	T	T	T	T	T	T	T	
T	T	T	T	T	T	T	T	T	T	T	T	T	T	T	T	T	T	T	T	T	
T	T	7.5	7.5 ⁴	7.5	7.5	T	T	T	T	T	T	T	T	T	T	T	T	T	T	T	
T	T	7.5	7.5 ⁴	7.5	7.5	T	T	T	T	T	T	T	T	T	T	T	T	T	T	T	
T	T	5	5 ⁴	5	6.5	9	T	T	T	T	T	T	T	T	T	T	T	T	T	T	
T	T		5 ⁴	5	6.5	8	T	T	T	T	T	T	T	T	T	T	T	T	T	T	
T	T		5 ⁴	4.5	6.5	8	T	T	T	T	T	T	T	T	T	T	T	T	T	T	
T	T			5	6.5	T	T	T	T	T	T	T	T	T	T	T	T	T	T	T	
T	T			5	6.5	T	T	T	T	T	T	T	T	T	T	T	T	T	T	T	
T	T			5 ⁴	6.5	T	T	T	T	T	T	T	T	T	T	T	T	T	T	T	
T	T			5	T	T	T	T	T	T	T	T	T	T	T	T	T	T	T	T	
T	T				3.5 ⁴	T	T	T	T	T	T	T	T	T	T	10.5	10.5	T	T	T	
T	T					T	T	T	T	T	T	T	T	T	T	10.5	T	T	T	T	

MCCB - S800 @ 415 V

Load S.		Char.	Icu [kA]	In [A]	T1		T1 - T3						T1	T3							
Supply S.		Version													T1		T3				
Release		TM																			
Version		B, C, N, S, H, L, V																			
S800N	B C D	36	10			4.5	4.5	4.5	4.5	8	10	201	251	T	T	T	T				
			13				4.5	4.5	4.5	7.5	10	15	251	T	T	T	T				
			16					4.5	4.5	4.5	7.5	10	15	251	T	T	T	T			
			20							4.5	7.5	10	15	251	T	T	T	T			
			25								6	10	15	201	T	T	T	T			
			32									7.5	10	201	T	T	T	T			
			40										10	201	T	T	T	T			
			50											15	T	T	T	T			
			63												T	T	T	T			
			80													T	T	T	T		
			100														T		T		
			125																T		
			S800S	B C D K	50	10			4.5	4.5	4.5	4.5	8	10	201	251	361	361	361	T	
13							4.5	4.5	4.5	7.5	10	15	251	361	361	361	T				
16								4.5	4.5	4.5	7.5	10	15	251	361	361	361	T			
20										4.5	7.5	10	15	251	361	361	361	T			
25											6	10	15	201	361	361	361	T			
32												7.5	10	201	361	361	361	T			
40													10	201	361	361	361	T			
50														15	361	361	361	T			
63															361	361	361	T			
80																361		361	T		
100																361			T		
125																			T		

10

¹Select the lowest value between what is indicated and the breaking capacity of the supply side circuit-breaker

MCBs technical details

Coordination tables: selectivity

MCCB-S800 @ 415 V

			Supply S.	T4										T4 - T5	
			Version	N, S, H, L, V											
			Release	TM										EL	
Load S.	Char.	Icu [kA]	In [A]	20	25	32	50	80	100	125	160	200÷250	100÷630		
S800N/S	B	36-50	10	6.5	6.5 ¹	6.5	6.5	11	T	T	T	T	T		
			13	6.5	5 ¹	6.5	6.5	11	T	T	T	T	T		
			16		5 ¹	6.5	6.5	11	T	T	T	T	T		
			20		4 ¹	6.5	6.5	11	T	T	T	T	T		
			25				6.5	11	T	T	T	T	T		
			32				6.5	8	T	T	T	T	T		
			40				5 ¹	6.5	T	T	T	T	T		
			50					5 ¹	7.5	T	T	T	T		
			63						5 ¹	7	T	T	T		
			80								T	T	T		
			100									T	T		
			125										T		
			C	36-50	10	6.5	6.5 ¹	6.5	6.5	11	T	T	T	T	T
					13	6.5	5 ¹	6.5	6.5	11	T	T	T	T	T
					16		5 ¹	6.5	6.5	11	T	T	T	T	T
	20				4 ¹	6.5	6.5	11	T	T	T	T	T		
	25				4 ¹		6.5	11	T	T	T	T	T		
	32						6.5	8	T	T	T	T	T		
	40						5 ¹	6.5	T	T	T	T	T		
	50						4 ¹	5 ¹	7.5	T	T	T	T		
	63							4 ¹	6.5 ¹	7	T	T	T		
	80							4 ¹	5 ¹	6.5 ¹	6.5	T	T		
	100								4 ¹	5 ¹	5 ¹	6.5	T		
	125									4 ¹	4 ¹	5 ¹	T		
	D	36-50			10	6.5	6.5 ¹	6.5	6.5	11	T	T	T	T	T
					13		5 ¹		6.5	11	T	T	T	T	T
					16				6.5	11	T	T	T	T	T
			20				6.5 ¹	11	T	T	T	T	T		
			25				6.5 ¹	11	T	T	T	T	T		
			32					8 ¹	T	T	T	T	T		
			40					6.5 ¹	T	T	T	T	T		
			50						7.5 ¹	T	T	T	T		
			63							7 ¹	T	T	T		
			80								5 ¹	T	T		
			100									5 ¹	T		
			125										T		
			K	36-50	10		6.5 ¹	6.5	6.5	11	T	T	T	T	T
					13		5 ¹	5	6.5	11	T	T	T	T	T
					16		5 ¹		6.5	11	T	T	T	T	T
	20				4 ¹		6.5	11	T	T	T	T	T		
	25						6.5 ¹	11 ¹	T	T	T	T	T		
	32						5 ¹	8 ¹	T	T	T	T	T		
	40							6.5 ¹	T	T	T	T	T		
	50							5 ¹	7.5 ¹	T	T	T	T		
	63							4 ¹	6.5 ¹	7 ¹	T	T	T		
80								5 ¹	6.5 ¹	7 ¹	T	T			
100									5 ¹	6.5 ¹	7 ¹	T			
125										5 ¹	6.5 ¹	T			

1 Value valid only for magnetic only supply side circuit-breaker (with In = 50 A, please consider MA52 circuit-breakers)

2 For T4 In = 100 A, value valid only for magnetic only supply side circuit-breaker

3 For T4 In = 160 A, value valid only for magnetic only supply side circuit-breaker

MCBs technical details

MCBs internal resistance, power loss and max. permissible earth-fault loop impedance

Internal resistance and power loss of the miniature circuit-breakers
 Internal resistance per pole in mΩ, power loss per pole in W

Type	Rated current		Device series B, C, D *	
	In A		mW	W
SN201 L SN201 SN201 M	2		520	2.1
	4		147.5	2.4
	6		64	2.3
	10		19	1.9
	16		14	3.6
	20		12	4.8
	25		7,1	4.4
	32		6,5	6.7
	40		4,7	7.5

* Total power loss

Type	Rated current In A	Device series							
		B, C ①		D		K		Z	
		mΩ	W	mΩ	W	mΩ	W	mΩ	W
S 200 and S 200 M	0.5	5500	1.4	4300	1.1	4300	1.1	8100	2.4
	1	1440	1.4	1250	1.25	1250	1.25	2100	2.3
	1.6	630	1.6	600	1.5	600	1.5	1000	2.8
	2	460	1.8	410	1.65	410	1.65	619	2.5
	3	150	1.3	130	1.2	130	1.2	235	2.4
	4	110	1.8	105	1.7	105	1.7	149	2.4
	6	55	2.0	52	1.9	52	1.9	75	3.2
	8	23	1.5	24	1.5	24	1.5	27	2.0
	10	19	2.1	16	1.6	13.5	1.4	24	2.7
	13	14	2.3	14	2.2	13.5	1.4	–	–
	16	8.5	2.5	8.5	2.5	7.7	2.0	10.9	2.8
	20	6.25	2.5	6.1	2.3	6.7	2.7	6.0	2.4
	25	5.0	3.2	4.3	3.1	4.6	2.9	4.5	3.3
	32	3.6	3.7	3.5	3.6	3.5	3.6	3.5	3.6
	40	3.0	4.8	2.2	4.2	2.8	4.5	2.5	4.1
	50	1.3	3.25	1.25	2.9	1.25	3.1	1.5	4.1
63	1.2	4.8	1.2	4.8	1.0	4.4	1.3	5.2	

① Current intensities 0.5 – 4 apply exclusively to C-type trip characteristics.

MCBs technical details

MCBs internal resistance, power loss and max. permissible earth-fault loop impedance

Internal resistance and power loss per pole

Internal resistance in mΩ per pole in cold state, power loss in W per pole at rated current

Type	Tripping characteristics	Rated current	Ri	Pvmax
		A	mΩ	W
S 200 S	B, C	6	52.1	2.16
	C	8	22.9	1.65
	B, C	10	19.0	2.20
	B, C	13	13.7	2.62
	B, C	16	9.1	3.28
	B, C	20	6.2	3.14

Type	Rated current	Ri	Pvmax	Type	Ri	Pvmax
	A	mΩ	W		mΩ	W
S 700-E	10	38.0	4.9	S 700-K		
	16	15.5	5.2		10.5	3.1
	20	12.5	6.5		7.5	3.8
	25	7.4	6.5		5.7	3.9
	32	5.3	7.2			
	35	4.0	7.6		4.7	7.8
	40	4.0	8.0		3.8	6.8
	50	2.9	9.5		3.0	10.0
	63	2.0	9.9		2.0	9.6
	80	1.5	13.5		1.3	10.1
100	1.0	14.4	1.1	12.3		

Rated current I _n /A	S 750 DR E		S 750 DR K	
	Internal resistance ¹ R _i /mΩ	Power loss ² P _v /W	Internal resistance ¹ R _i /mΩ	Power loss ² P _v /W
16	15.3	4.1	14.5	3.9
20	11.3	5.4	10.7	5.1
25	8.7	5.9	8.3	5.5
35	4.5	6.3	4.3	6.2
40	3.4	6.1	3.2	5.8
50	2.9	7.6	2.8	7.2
63	2.1	8.7	2.1	8.7

¹ in cold state

² at rated current

S800S - S800N - S800C

Typical internal resistances and power losses at 25 °C ambient temperature (per pole)

Rated current I _n [A]	Internal resistance R _i [mΩ]			Power loss P _v [W]		
	B, C, D, K a	KM b	UCB, UCK b	B, C, D, K	KM b	UCB, UCK b
6	51.7	-	-	1.8	-	-
8	27.2	-	-	1.7	-	-
10	15.2	-	15.2	1.5	-	1.5
13	12.1	-	12.1	2.0	-	2.0
16	12.1	-	12.1	3.1	-	3.1
20	8.7	2.7	8.7	3.5	1.1	3.5
25	6.8	3.0	6.8	4.3	1.9	4.3
32	3.1	1.7	3.1	3.2	1.7	3.2
40	2.3	1.6	2.3	3.7	2.6	3.7
50	1.7	1.1	1.7	4.3	2.8	4.3
63	1.6	1.0	1.6	6.4	4.0	6.4
80	1.0	0.75	1.0	6.4	5.0	6.4
100	0.8	-	0.8	8.0	-	8.0
125	0.6	-	0.6	9.4	-	9.4

a K Applicable only for S800S-S800C

b KM, UCB, UCK Applicable only for S800S

S800B

Typical internal resistances and power losses at 25 °C ambient temperature (per pole)

Rated current I _n [A]	Internal resistance R _i [mΩ]		Power loss P _v [W]	
	B, C	D, K	B, C	D, K
32	3.1	3.1	3.2	3.2
40	2.3	2.3	3.7	3.7
50	1.7	1.7	4.3	4.3
63	1.6	1.6	6.4	6.4
80	1.0	1.0	6.4	6.4
100	0.8	0.8	8.0	8.0
125	0.7	-	10.9	-

MCBs technical details

MCBs internal resistance, power loss and max. permissible earth-fault loop impedance

Maximum permissible earth-fault loop impedance Z_S at $U_0 = 230\text{ V}$ ~ b to ensure compliance with the operation conditions pursuant to IEC 60364-4.

Operating time $< 0.4\text{ s}$; at 400 V ~ $< 0.2\text{ s}$ and at $> 400\text{ V}$ ~ $< 0.1\text{ s}$

The instantaneous release of the MCB ensures an operating time of $\leq 0.1\text{ s}$ (TN system).

Determined according to DIN VDE 0100-520 sheet 2:2002-11 (source impedance = $300\text{ m}\Omega$, $c = 0.95$ and conductor temperature $70\text{ }^\circ\text{C}$ = factor 0.8). The internal resistance of the MCB is already included.

S 200 and S 200 M

Rated current In A	B	C	D	K	Z
	max. Z_S	max. Z_S	max. Z_S	max. Z_S	max. Z_S
	q	q	q	q	q
0.5	–	46	33.0	33.0	153.3
1	–	23	16.5	16.5	76.7
1.6	–	14.4	10.3	10.3	47.9
2	–	11.5	8.2	8.2	38.3
3	–	7.7	5.5	5.5	25.6
4	–	5.8	4.1	4.1	19.2
6	7.7	3.8	2.7	2.7	12.8
8	–	2.8	2.1	2.1	9.5
10	4.6	2.2	1.6	1.6	7.7
13	3.5	1.7	1.2	1.2	–
16	2.9	1.4	1.0	1.0	4.8
20	2.3	1.2	0.8	0.8	3.8
25	1.8	0.9	0.7	0.7	3.1
32	1.4	0.7	0.5	0.5	2.4
40	1.1	0.6	0.4	0.4	1.9
50	0.9	0.5	0.3	0.3	1.5
63	0.7	0.4	0.3	0.3	1.2

b U_0 = rated voltage against earthed conductor; for $U_0 = 240\text{ V}$ ~ is $Z_S \cdot 1.04$; for $U_0 = 127\text{ V}$ ~ is $Z_S \cdot 0.55$

S 200 P

Rated current In A	B	C	D	K	Z
	max. ZS	max. ZS	max. ZS	max. ZS	max. ZS
	q	q	q	q	q
0.2	–	–	–	39.5	–
0.3	–	–	–	34.8	–
0.5	–	46	27.4	26.5	143
0.75	–	–	–	19.4	–
1	–	23	15	15	74.4
1.6	–	14.4	9.6	9.6	47.9
2	–	11.5	7.8	7.8	38.3
3	–	7.7	11.8	5.3	25.3
4	–	5.8	8.8	3.9	19.1
6	7.6	3.8	5.9	2.6	12.7
8	–	2.8	5.7	2.0	9.5
10	4.6	2.3	3.5	1.6	7.6
13	3.5	1.7	2.7	1.3	–
16	2.9	1.4	2.2	1.0	4.7
20	2.3	1.1	1.7	0.8	3.8
25	1.8	0.9	1.4	0.6	3.0
32	1.4	0.7	1.1	0.5	2.4
40	1.1	0.6	0.9	0.4	1.9
50	0.9	0.5	0.7	0.3	1.5
63	0.7	0.4	0.6	0.25	1.1

b U0 = rated voltage against earthed conductor; for U0 = 240 V- is ZS · 1.04; for U0 = 127 V- is ZS · 0.55

Take into account the voltage drop:

e.g. in the case of a 1.5 mm² conductor, protected by a B 16 circuit-breaker, the maximum cable length is 82 m. If the voltage drop is below 3%, this would result in a maximum cable length (2-strand) of 17 m. For more details on this topic, get your own copy of the technical information leaflet "Maximum cable lengths".

10

Maximum cable lengths in the case of different voltages and cross sections on request.

MCBs technical details

Performances at different ambient temperatures, altitudes and frequencies

Derating of load capability of MCBs

Derating of MCBs load capability takes in consideration 2 factors: ambient temperature and influence of adjacent devices. The rules to obtain the effective value of I_n are the following:

1. Deviating ambient temperature:

The rated value of the current of a miniature circuit-breaker refers to a temperature of 20 °C for circuit-breakers with characteristics K and Z and 30 °C for characteristics B, C and

D. The following tables contain the derating of load capability of S 200/S 200 M/S 200 P/S 200 S MCBs* with temperature from -40 °C to 70 °C for the curves B, C, D and K, Z.

S200 (B, C, and D characteristics)

Max. operating current depending on the ambient temperature of a circuit-breaker in load circuit of characteristics type B, C, D.

B, C and D	Ambient temperature T (°C)													
In (A)	- 40	- 30	- 25	- 20	- 10	0	10	20	30	40	50	55	60	70
0.5	0.67	0.65	0.64	0.62	0.60	0.58	0.55	0.53	0.50	0.47	0.44	0.43	0.41	0.37
1.0	1.33	1.29	1.27	1.25	1.20	1.15	1.11	1.05	1.00	0.94	0.88	0.85	0.82	0.75
1.6	2.13	2.07	2.04	2.00	1.92	1.85	1.77	1.69	1.60	1.51	1.41	1.36	1.31	1.19
2.0	2.67	2.58	2.54	2.49	2.40	2.31	2.21	2.11	2.00	1.89	1.76	1.7	1.63	1.49
3.0	4.0	3.9	3.80	3.7	3.6	3.5	3.3	3.2	3.0	2.8	2.6	2.5	2.4	2.2
4.0	5.3	5.2	5.1	5.0	4.8	4.6	4.4	4.2	4.0	3.8	3.5	3.4	3.3	3.0
6.0	8.0	7.7	7.6	7.5	7.2	6.9	6.6	6.3	6.0	5.7	5.3	5.1	4.9	4.5
8.0	10.7	10.3	10.15	10.0	9.6	9.2	8.8	8.4	8.0	7.5	7.1	6.8	6.5	6.0
10.0	13.3	12.9	12.7	12.5	12.0	11.5	11.1	10.5	10.0	9.4	8.8	8.5	8.2	7.5
13.0	17.3	16.8	16.5	16.2	15.6	15.0	14.4	13.7	13.0	12.3	11.5	11.1	10.6	9.7
16.0	21.3	20.7	20.4	20.0	19.2	18.5	17.7	16.9	16.0	15.1	14.1	13.6	13.1	11.9
20.0	26.7	25.8	25.4	24.9	24.0	23.1	22.1	21.1	20.0	18.9	17.6	17.0	16.3	14.9
25.0	33.3	32.3	31.8	31.2	30.0	28.9	27.6	26.4	25.0	23.6	22.0	21.2	20.4	18.6
32.0	42.7	41.3	40.6	39.9	38.5	37.0	35.4	33.7	32.0	30.2	28.2	27.2	26.1	23.9
40.0	53.3	51.6	50.8	49.9	48.1	46.2	44.2	42.2	40.0	37.7	35.3	34.0	32.7	29.8
50.0	66.7	64.5	63.5	62.4	60.1	57.7	55.3	52.7	50.0	47.1	44.1	42.5	40.8	37.3
63.0	84.0	81.3	80.0	78.6	75.7	72.7	69.6	66.4	63.0	59.4	55.6	53.5	51.4	47.0

S200 (K and Z characteristics)

Max. operating current depending on the ambient temperature of a circuit-breaker in load circuit of characteristics type K and Z

K and Z	Ambient temperature T (°C)													
In (A)	- 40	- 30	- 25	- 20	- 10	0	10	20	30	40	50	55	60	70
0.5	0.66	0.64	0.63	0.61	0.59	0.56	0.53	0.50	0.47	0.43	0.40	0.38	0.35	0.31
1.0	1.32	1.27	1.25	1.22	1.17	1.12	1.06	1.00	0.94	0.87	0.79	0.75	0.71	0.61
1.6	2.12	2.04	2.00	1.96	1.88	1.79	1.70	1.60	1.50	1.39	1.26	1.20	1.13	0.98
2.0	2.65	2.55	2.50	2.45	2.35	2.24	2.12	2.00	1.87	1.73	1.58	1.50	1.41	1.22
3.0	4.0	3.8	3.75	3.7	3.5	3.4	3.2	3.0	2.8	2.6	2.4	2.30	2.1	1.8
4.0	5.3	5.1	5.00	4.9	4.7	4.5	4.2	4.0	3.7	3.5	3.2	3.00	2.8	2.4
6.0	7.9	7.6	7.5	7.3	7.0	6.7	6.4	6.0	5.6	5.2	4.7	4.5	4.2	3.7
8.0	10.8	10.2	10.0	9.8	9.4	8.9	8.5	8.0	7.5	6.9	6.3	6.0	5.7	4.9
10.0	13.2	12.7	12.5	12.2	11.7	11.2	10.6	10.0	9.4	8.7	7.9	7.5	7.1	6.1
13.0	17.2	16.6	16.3	15.9	15.2	14.5	13.8	13.0	12.2	11.3	10.3	9.8	9.2	8.0
16.0	21.2	20.4	20.0	19.6	18.8	17.9	17.0	16.0	15.0	13.9	12.6	12.0	11.3	9.8
20.0	26.5	25.5	25.0	24.5	23.5	22.4	21.2	20.0	18.7	17.3	15.8	15.0	14.1	12.2
25.0	33.1	31.9	31.3	30.6	29.3	28.0	26.5	25.0	23.4	21.7	19.8	18.8	17.7	15.3
32.0	42.3	40.8	40.0	39.2	37.5	35.8	33.9	32.0	29.9	27.7	25.3	24.0	22.6	19.6
40.0	52.9	51.0	50.0	49.0	46.9	44.7	42.4	40.0	37.4	34.6	31.6	30.0	28.3	24.5
50.0	66.1	63.7	62.5	61.2	58.6	55.9	53.0	50.0	46.8	43.3	39.5	37.5	35.4	30.6
63.0	83.3	80.3	78.8	77.2	73.9	70.4	66.8	63.0	58.9	54.6	49.8	47.2	44.5	38.6

S200U / S200UP / S200UDC / SU200PR

K and Z	Ambient temperature T (°C)											
ln (A)	-40	-30	-20	-10	0	10	25	30	40	50	60	70
0,5	0,65	0,63	0,60	0,58	0,55	0,52	0,5	0,49	0,45	0,42	0,38	0,33
1	1,30	1,25	1,20	1,15	1,09	1,03	1	0,97	0,91	0,83	0,75	0,66
1,6	2,08	2,00	1,92	1,84	1,75	1,65	1,6	1,55	1,45	1,33	1,20	1,06
2	2,60	2,50	2,40	2,30	2,18	2,06	2	1,94	1,80	1,66	1,50	1,32
3	3,90	3,75	3,60	3,45	3,30	3,10	3	2,90	2,70	2,50	2,25	1,95
4	5,20	5,00	4,80	4,60	4,35	4,10	4	3,85	3,60	3,35	3,00	2,60
6	7,8	7,5	7,2	6,9	6,6	6,2	6	5,8	5,4	5,0	4,5	4,0
8	10,5	10,0	9,6	9,2	8,7	8,3	8	7,8	7,2	6,6	6,0	5,3
10	13,0	12,5	12,0	11,5	10,9	10,3	10	9,7	9,1	8,3	7,5	6,6
13	16,9	16,3	15,6	14,9	14,2	13,4	13	12,6	11,8	10,8	9,8	8,6
16	20,8	20,0	19,2	18,4	17,5	16,5	16	15,5	14,5	13,3	12,0	10,6
20	26,0	25,0	24,0	23,0	21,8	20,6	20	19,4	18,0	16,6	15,0	13,2
25	32,5	31,3	30,0	28,7	27,3	25,8	25	24,2	22,6	20,8	18,8	16,5
32	41,6	40,0	38,4	36,7	34,9	33,0	32	31,0	28,8	26,5	24,0	21,1
40	52,0	50,0	48,0	45,8	43,6	41,2	40	38,7	36,0	33,1	30,0	26,4
50	64,9	62,5	59,9	57,3	54,5	51,5	50	48,4	45,1	41,4	37,5	33,0
63	81,8	78,8	75,6	72,2	68,6	64,9	63	61,0	56,8	52,2	47,2	41,6

SN201

B, C and D											
ln (A)	-25	-20	-10	0	10	20	30	40	50	55	
2	2,37	2,32	2,26	2,18	2,12	2,06	2	1,95	1,91	1,89	
4	4,74	4,60	4,53	4,37	4,24	4,12	4	3,90	3,85	3,79	
6	7,2	7,0	6,8	6,4	6,3	6,2	6	5,9	5,8	5,7	
10	11,8	11,6	11,3	10,9	10,6	10,3	10	9,8	9,7	9,5	
16	18,1	17,7	17,4	16,9	16,6	16,3	16	15,8	15,7	15,5	
20	23,7	23,2	22,6	21,8	21,2	20,6	20	19,6	19,1	18,9	
25	29,4	29,0	28,2	27,4	26,7	26,0	25	24,2	23,5	23,1	
32	38,7	38,1	37,2	36,2	34,6	33,0	32	31,3	30,5	30,0	
40	48,3	47,5	45,8	44,4	42,7	41,0	40	39,5	38,6	38,2	

MCBs technical details

Performances at different ambient temperatures, altitudes and frequencies

S 750 DR

E	Ambient temperature T (°C)							
In (A)	-20	-10	0	10	20	30	40	50
16	19.8	19.1	18.4	17.6	16.8	16.0	15.1	14.2
20	24.7	23.8	22.9	22.0	21.0	20.0	18.9	17.8
25	30.9	29.8	28.7	27.5	26.3	25.0	23.6	22.2
35	43.2	41.7	40.1	38.5	36.8	35.0	33.1	31.1
40	49.4	47.7	45.9	44.0	42.1	40.0	37.8	35.5
50	61.8	59.6	57.4	55.0	52.6	50.0	47.3	44.4
63	77.8	75.1	72.3	69.3	66.2	63.0	59.6	56.0

K	Ambient temperature T (°C)							
In (A)	-20	-10	0	10	20	30	40	50
16	19.1	18.4	17.6	16.8	16.0	16.0	15.1	14.2
20	23.8	22.9	22.0	21.0	20.0	20.0	18.9	17.8
25	29.8	28.7	27.5	26.3	25.0	25.0	23.6	22.2
35	41.7	40.1	38.5	36.8	35.0	35.0	33.1	31.1
40	47.7	45.9	44.0	42.1	40.0	40.0	37.8	35.5
50	59.6	57.4	55.0	52.6	50.0	50.0	47.3	44.4
63	75.1	72.3	69.3	66.2	63.0	63.0	59.6	56.0

DS271 (B and C characteristics, for available values of rated current)

DDA200 + S200, DS200 with B, C and D characteristics

Max. operating current depending on the ambient temperature of a circuit-breaker in load circuit.

B and C	Ambient temperature T (°C)									
In (A)	-25	-20	-10	0	10	20	30	40	50	55
0.5	0.64	0.62	0.60	0.58	0.55	0.53	0.50	0.47	0.44	0.43
1	1.27	1.25	1.20	1.15	1.11	1.05	1.00	0.94	0.88	0.85
1.6	2.04	2.00	1.92	1.85	1.77	1.69	1.60	1.51	1.41	1.36
2	2.54	2.49	2.40	2.31	2.21	2.11	2.00	1.89	1.76	1.70
3	3.80	3.70	3.60	3.50	3.30	3.20	3.00	2.80	2.60	2.50
4	5.10	5.00	4.80	4.60	4.40	4.20	4.00	3.80	3.50	3.40
6	7.60	7.50	7.20	6.90	6.60	6.30	6.00	5.70	5.30	5.10
8	10.15	10.00	9.60	9.20	8.80	8.40	8.00	7.50	7.10	6.80
10	12.70	12.50	12.00	11.50	11.10	10.50	10.00	9.40	8.80	8.50
13	16.50	16.20	15.60	15.00	14.40	13.70	13.00	12.30	11.50	11.10
16	20.40	20.00	19.20	18.50	17.70	16.90	16.00	15.10	14.10	13.60
20	25.40	24.90	24.00	23.10	22.10	21.10	20.00	18.90	17.60	17.00
25	31.80	31.20	30.00	28.90	27.60	26.40	25.00	23.60	22.00	21.20
32	40.60	39.90	38.50	37.00	35.40	33.70	32.00	30.20	28.20	27.20
40	50.80	49.90	48.10	46.20	44.20	42.20	40.00	37.70	35.30	34.00
50	63.50	62.40	60.10	57.70	55.30	52.70	50.00	47.10	44.10	42.50
63	80.00	78.60	75.70	72.70	69.60	66.40	63.00	59.40	55.60	53.50

DDA200 + S200, DS200 (K and Z characteristics)

Max. operating current depending on the ambient temperature of a circuit-breaker in load circuit.

K and Z	Ambient temperature T (°C)									
	-25	-20	-10	0	10	20	30	40	50	55
In (A)										
0,5	0,63	0,61	0,59	0,56	0,53	0,50	0,47	0,43	0,40	0,38
1	1,25	1,22	1,17	1,12	1,06	1,00	0,94	0,87	0,79	0,75
1,6	2,00	1,96	1,88	1,79	1,70	1,60	1,50	1,39	1,26	1,20
2	2,50	2,45	2,35	2,24	2,12	2,00	1,87	1,73	1,58	1,50
3	3,75	3,70	3,50	3,40	3,20	3,00	2,80	2,60	2,40	2,30
4	5,00	4,90	4,70	4,50	4,20	4,00	3,70	3,50	3,20	3,00
6	7,5	7,30	7,00	6,70	6,40	6,00	5,60	5,20	4,70	4,5
8	10,0	9,80	9,40	8,90	8,50	8,00	7,50	6,90	6,30	6,0
10	12,5	12,20	11,70	11,20	10,60	10,00	9,40	8,70	7,90	7,5
13	16,3	15,90	15,20	14,50	13,80	13,00	12,20	11,30	10,30	9,8
16	20,0	19,60	18,80	17,90	17,00	16,00	15,00	13,90	12,60	12,0
20	25,0	24,50	23,50	22,40	21,20	20,00	18,70	17,30	15,80	15,0
25	31,3	30,60	29,30	28,00	26,50	25,00	23,40	21,70	19,80	18,8
32	40,0	39,20	37,50	35,80	33,90	32,00	29,90	27,70	25,30	24,0
40	50,0	49,00	46,90	44,70	42,40	40,00	37,40	34,60	31,60	30,0
50	62,5	61,20	58,60	55,90	53,00	50,00	46,80	43,30	39,50	37,5
63	78,8	77,20	73,90	70,40	66,80	63,00	58,90	54,60	49,80	47,2

DS201 and DS202C

Max. operating current depending on the ambient temperature of a circuit-breaker in load circuit of characteristics type B, C and K

B, C and K	Ambient temperature T (°C)									
	-25	-20	-10	0	10	20	30	40	50	55
In (A)										
2	2,6	2,5	2,4	2,3	2,2	2,1	2,0	1,9	1,8	1,7
4	4,9	4,8	4,6	4,5	4,3	4,2	4	3,8	3,7	3,6
6	7,95	7,8	7,4	7,1	6,7	6,4	6	5,6	5,3	5,1
8	10,3	10,1	9,7	9,3	8,8	8,4	8	7,6	7,2	6,95
10	11,8	11,6	11,3	11,0	10,7	10,3	10	9,7	9,3	9,15
13	15,65	15,4	14,9	14,4	14,0	13,5	13	12,5	12,0	11,8
16	18,65	18,4	17,9	17,4	17,0	16,5	16	15,5	15,0	14,8
20	23,1	22,8	22,2	21,7	21,1	20,6	20	19,4	18,9	18,6
25	30,8	30,3	29,2	28,2	27,1	26,1	25	23,9	22,9	22,35
32	39,3	38,6	37,3	36,0	34,7	33,3	32	30,7	29,3	28,65
40	50,7	49,7	47,8	45,8	43,9	41,9	40	38,1	36,1	35,15

MCBs technical details

Performances at different ambient temperatures, altitudes and frequencies

2. Multiply the rated current (equivalent) referring to the new temperature by another factor only in case of presence of several devices installed alongside each other; see table.

Influence of adjacent devices S200, DS200, DDA200+S200

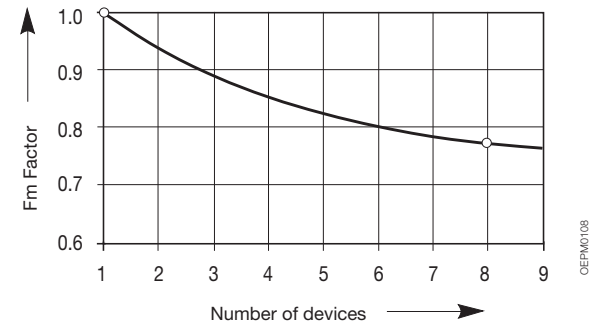

Influence of adjacent devices Correction factor Fm	
No. of adjacent devices	Fm
1	1
2	0.95
3	0.9
4	0.86
5	0.82
6	0.795
7	0.78
8	0.77
9	0.76
>9	0.76

Example: S 202 C 16 with T=40 °C

Type of use	Values to use	Formula	Calculation	Result
Load at ambient temperature	In (amb. t°) - see tables-			In=15.1 A
Load at ambient temperature with 8 adj. devices	In (amb. t°) - see tables- Fm (0.77)	In (amb. t°)x0.77	15.1x0.77	In=11.63 A

Influence of adjacent devices SN201

Influence of adjacent devices Correction factor Fm	
No. of adjacent devices	Fm
1	1.00
2	0.99
3	0.97
4	0.96
5	0.94
6	0.93
7	0.92
8	0.91
9	0.90
> 9	0.90

Influence of adjacent devices DS201 and DS202C

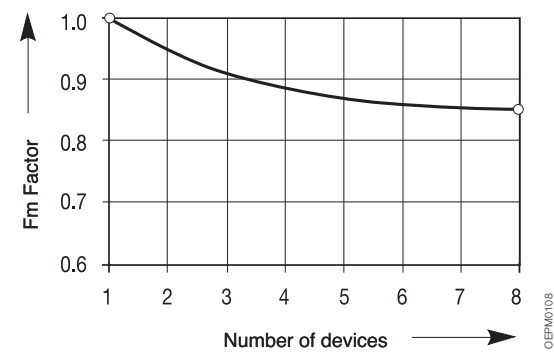

Influence of adjacent devices Correction factor Fm	
No. of adjacent devices	Fm
1	1.00
2	0.95
3	0.91
4	0.88
5	0.87
6	0.86
7	0.85
> 7	0.85

MCBs technical details

Use of MCBs in direct current circuits

Use of S 200/S 200 M/S 200 P miniature circuit-breakers in direct current circuits 72 VDC/125 VDC

In DC systems up to 72 VDC or, as the case may be, series connection up to 125 VDC, customary S 200/S 200 M series MCBs can be used. Polarity does not need to be taken into consideration, the outgoing circuit may be implemented from above or below the device. For higher direct voltage up to 440 VDC devices of the S 280 UC series must be used.

Example for max. permissible voltages between conductors depending on the number of poles and type of connection.

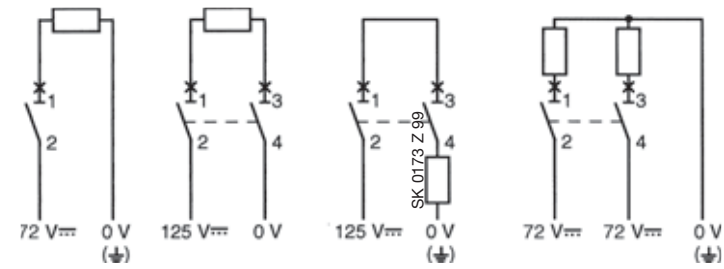

Examples for different voltages between a conductor and earth where voltages between conductors are identical:

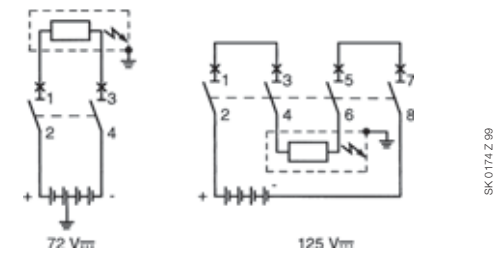

MCBs technical details

S 200 UDC series DC Applications

DC = Direct Current

S 200 UDC MCBs can be used in the one-pole version as 60 V DC, and in the 2-pole version with series connection of two poles up to 125 V DC.

S 200 UDC contains fitted permanent magnets, which assists in the forced extinguishing of the arc.

If voltages to earth exceeding 60 V DC may occur, 2-pole S 200 UDC is to be used for one-pole disconnection.

For DC incoming supply from above S 200 UDC-... MCBs have, in the area of arc chutes, permanent magnets, it is

therefore necessary to take into account the polarity during the installation process.

Doing so ensures that in the case of a short circuit the magnetic field of the permanent magnets corresponds with the electromagnetic field of the short-circuit current, therefore safely leading the short circuit into the arc chute.

Incorrect polarities may cause damage to the MCB. This is why – in the case of top-fed devices – terminal 1 must be connected to (-) and terminal 3 (+).

Example for permissible voltages between the conductors depending on the number of poles and circuit layout:

voltage between conductors	Un	60 V–	125 V–	125 V–	125 V–
voltage between conductor and earth	Un	60 V–	60 V–	125 V–	60 V–
MCB		1-pole	2-pole	2-pole	2-pole
		S 201 UDC	S 202 UDC	S 202 UDC	S 202 UDC
supply from below					
supply from above					

Examples for different voltage levels between conductor and earth in the case of identical voltage between conductors:

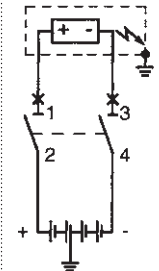
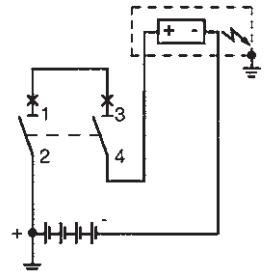
voltage between conductors	Un	125 V– all-pole disconnection	125 V– 1-pole disconnection
voltage between conductor and earth	Un	60 V– circuit symmetrically earthed	125 V– circuit unsymmetrically earthed
MCB		2-pole S 202 UDC	2-pole S 202 UDC
			

① in the circuit diagram, the negative pole is earthed.
 ② in the circuit diagram, the positive pole is earthed.

MCBs technical details

S 200 MUC - S 280 UC series AC/DC Applications

UC = Universal Current = AC/DC

S 200 MUC/S 280 UC MCBs can be used in the one-pole version as 220 V DC, and in the 2-pole or 4-pole version with series connection of two poles up to 440 V DC.

S 200 MUC/S 280 UC contains fitted permanent magnets, which assists in the forced extinguishing of the arc.

If voltages to earth exceeding 220 V DC may occur, 2-pole S 200 MUC/S 280 UC is to be used for one-pole disconnection, and four-pole S 200 MUC/280 UC for all-pole disconnection.

For DC incoming supply from above S 200 MUC/S 280 UC...

MCBs have, in the area of arc chutes, permanent magnets, it is therefore necessary to take into account the polarity during the installation process.

Doing so ensures that in the case of a short circuit the magnetic field of the permanent magnets corresponds with the electromagnetic field of the short-circuit current, therefore safely leading the short circuit into the arc chute.

Incorrect polarities may cause damage to the MCB. This is why – in the case of top-fed devices – terminal 1 must be connected to (-) and terminal to 3 (+).

Example for permissible voltages between the conductors depending on the number of poles and circuit layout:

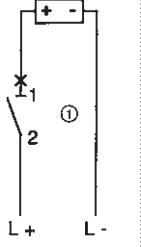
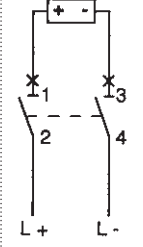
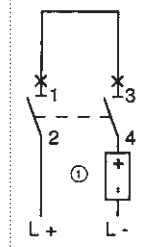
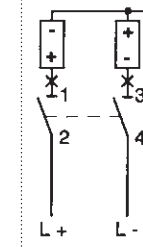
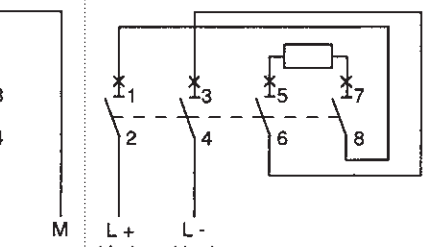
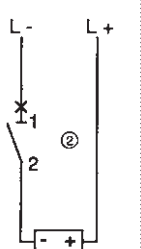
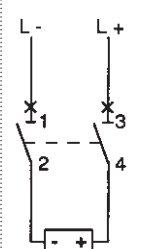
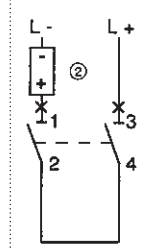
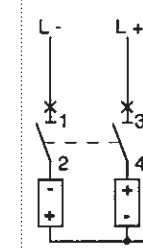
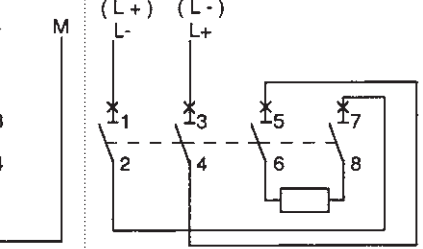
voltage between conductors	U_n	220 V–	440 V–	440 V–	440 V–	440 V– (voltage reversal)
voltage between conductor and earth	U_n	220 V–	220 V–	440 V–	220 V–	220 V–
MCB		1-pole S 201 MUC/ S 281 UC	2-pole S 202 MUC/ S 282 UC	2-pole S 202 MUC/ S 282 UC	2-pole S 202 MUC/ S 282 UC	4-pole S 204 MUC/ S 284 UC
supply from below						
supply from above						

Examples for different voltage levels between conductor and earth in the case of identical voltage between conductors:

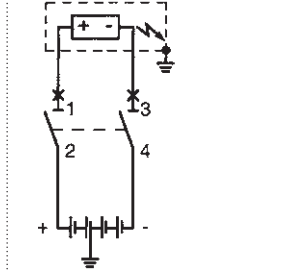
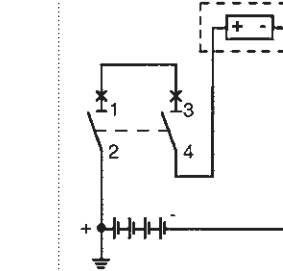
voltage between conductors	U_n	440 V– all-pole disconnection	440 V– 1-pole disconnection	440 V– all pole disconnection
voltage between conductor and earth	U_n	220 V– circuit symmetrically earthed	440 V– circuit unsymmetrically earthed	440 V– circuit unearthed or unsymmetrically earthed
MCB		2-pole S 202 MUC/S 282 UC	2-pole S 202 MUC/S 282 UC	4-pole S 204 MUC/S 284 UC
				

① in the circuit diagram, the negative pole is earthed. ② in the circuit diagram, the positive pole is earthed.

MCBs technical details

Use of MCBs in direct current circuits

Performance in altitude of MCBs

Up to the height of 2000 m, MCBs do not undergo any alterations in their rated performances. Over this height the properties of the atmosphere change in terms of composition, dielectric capacity, cooling capacity and pressure, therefore

the performances of the MCBs undergo derating, which can basically be measured in terms of variations in significant parameters, such as the maximum operating voltage and the rated current.

S 200/S 200 M/S 200 P/ S 200 S

Altitude	[m]	2000	3000	4000
Rated service voltage Ue	[V]	440	380	340
Rated current In		In	0.96xIn	0.93xIn

S800

Altitude	[m]	2000	3000	4000	5000
Rated impulse withstand voltage Uimp	[V]	8	6	6	6
Rated operational voltage Ue	[V]	690	600	540	470
Max. rated current In		In	0.96xIn	0.93xIn	0.9xIn

Variation of tripping thresholds of MCBs according to network frequency

The circuit-breakers are calibrated for a current with a frequency range between 50 and 60 Hz.

	AC			DC
	100 Hz	200 Hz	400 Hz	
Multiplier	1.1	1.2	1.5	1.5

The thermal tripping performance is independent from the network frequency.

Example:

S 202 C10 supplied at 50-60 Hz, the electro-magnetic tripping current is: $50 A \leq I_m \leq 100 A$;
 S 202 C10 supplied at 400 Hz, the electro-magnetic tripping current is: $75 A \leq I_m \leq 150 A$.

MCBs technical details

Instruction for use of S 200 S

Connection and disconnection of different types of cables on the load side

Type of cables and cross sections

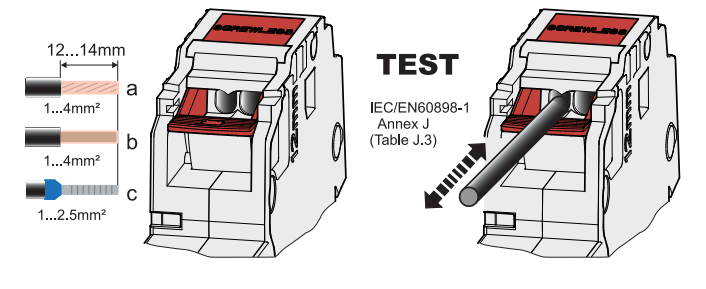

Connection of cables

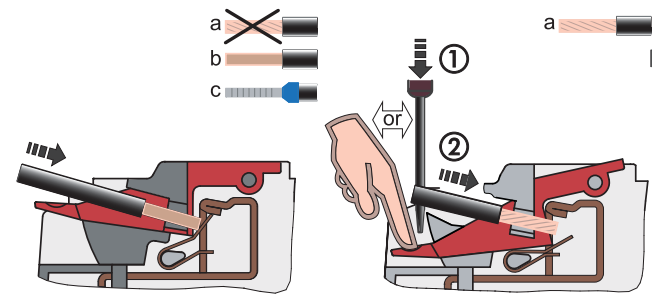

- Connection of one cable per opening.
- Rigid and flexible cables with end sleeves may be directly connected.
- If flexible cables without end sleeves are to be connected, the terminal must be opened. Splicing of the wires must be avoided.
- The cable must be inserted into the terminal either as far as possible or in such a way that a sufficient connection is obvious.
- The tightness of the connection must be checked.

Disconnection of cables

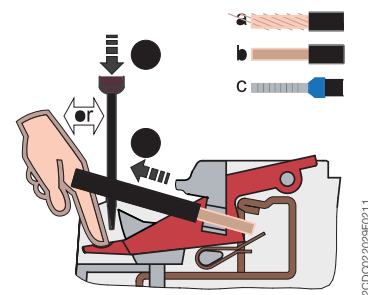

- The cables may only be removed after operating the terminal's opening mechanism.
- If one cable is removed, the correct position of the remaining cable must be checked.

Processing instructions

The screwless terminal at the load side of the S 200 S is designed so that copper cables basically may be connected without further preparation. If end sleeves are used as splicing protection for flexible cables, the compression of the end sleeves must comply with the pull-out forces in accordance with standard IEC/EN 60898-1 table J.3.

Recommended tools for flexible cables with end sleeves

Crimp tool with trapezoid compression profile

Wire stripping length / size of end sleeves for all cables

Wire stripping length and end sleeve length 12 (+2) mm

Distribution boards with metal cover

The distance from a metallic cover to the "shoulder" of the miniature circuit breaker must be at least 6 mm on the load side due to the arrangement of the easily accessible measurement point.

MCBs technical details

Particular supply sources and loads

Lighting circuit protection

Selection of circuit-breakers for the protection of lighting circuit and calculation of their rated current

To select the correct circuit-breaker for use in the protection of lighting circuits you need to know the type of load based on which you will work out the breaker's rated current. The protection circuit utilization current can be calculated simply starting with the rated power and the lighting voltage, or it

may be supplied directly by the device manufacturer.

Considering the utilization current, it is important to select the version of the breaker with a rated current just above the value calculated, defining the cable cross-section accordingly. The tables below show the rated current values of the circuit-breakers to be used according to the type and power of the device connected.

Table 1 High pressure discharge lamps

230 V and 400 VAC three-phase with or without power factor correcting capacitors, star or delta connection

Mercury vapour fluorescent lamp	Pw [W]	<700	<1000	<2000
	I [A]	6	10	16
Mercury vapour metal halogen lamp	Pw [W]	<375	<1000	<2000
	I [A]	6	10	16
High pressure sodium discharge lamp	Pw [W]	<400		<1000
	I [A]	6		16

Table 2 Fluorescent lamps

230 VAC single-phase/three-phase with neutral (400 V), with star connection.

The tables indicate the rated current of the circuit-breakers according to the lamp power and type of power supply.

Example of calculation

- Starter dissipated power: 25% of lamp power
- Reference temperature: 30 and 40 °C according to circuit-breaker
- Power factor: lamp without capacitors $\cos \varphi=0.6$
lamp with capacitors $\cos \varphi=0.86$

Method of calculation

- $IB = (PL * n^{\circ}L * KST * KC) / (Un * \cos \varphi)$ where:
 - Un = rated voltage 230 V
 - $\cos \varphi$ = power factor
 - PL = lamp power
 - $n^{\circ}L$ = number of lamps per phase
 - KST = 1.25
 - KC = 1 for star connection and 1.732 for delta connection

Type of lamp	Tube diss. pwr. [W]	Number of lamps per phase													
Single without capacitors	18	4	9	14	29	49	78	98	122	157	196	245	309	392	490
	36	2	4	7	14	24	39	49	61	78	98	122	154	196	245
	58	1	3	4	9	15	24	30	38	48	60	76	95	121	152
Single with capacitors	18	7	14	21	42	70	112	140	175	225	281	351	443	562	703
	36	3	7	10	21	35	56	70	87	112	140	175	221	281	351
	58	2	4	6	13	21	34	43	54	69	87	109	137	174	218
Double with capacitors	2x18=36	3	7	10	21	35	56	70	87	112	140	175	221	281	351
	2x36=72	1	3	5	10	17	28	35	43	56	70	87	110	140	175
	2x58=116	1	2	3	6	10	17	21	27	34	43	54	68	87	109
In [A] - 2P and 4P circuit-breakers		1	2	3	6	10	16	20	25	32	40	50	63	80	100

Fluorescent lamps. 230 VAC three-phase – Delta connection

Type of lamp	Tube diss. pwr. [W]	Number of lamps per phase													
Single without capacitors	18	2	5	8	16	28	45	56	70	90	113	141	178	226	283
	36	1	2	4	8	14	22	28	35	45	56	70	89	113	141
	58	0	1	2	5	8	14	17	21	28	35	43	55	70	87
Single with capacitors	18	4	8	12	24	40	64	81	101	127	162	203	255	324	406
	36	2	4	6	12	20	32	40	50	64	81	101	127	162	203
	58	1	2	3	7	12	20	25	31	40	50	63	79	100	126
Double with capacitors	2x18=36	2	4	6	12	20	32	40	50	64	81	101	127	162	203
	2x36=72	1	2	3	6	10	16	20	25	32	40	50	63	81	101
	2x58=116	0	1	1	3	6	10	12	15	20	25	31	39	50	63
In [A] - 3P circuit-break.		1	2	3	6	10	16	20	25	32	40	50	63	80	100

Transformer protection

Insertion current

When the LV/LV transformers are powered up, very strong currents occur, which must be considered when selecting the protective device. The peak value of the first current wave often reaches a value between 10 and 15 times the transformer's effective rated current.

For power ratings below 50 kVA, it may reach between 20 and 25 times the rated current. This transient current decreases very rapidly with a time constant T varying from several ms to 10, 20 ms.

Main protection on the primary side

The tables below are the result of a set of tests on co-ordination between circuit-breakers and BT/BT transformers. The transformers used in the tests are normalized. The table, referring to a primary supply voltage of 230 or 400 V and to single-phase and three-phase transformers, indicate which circuit-breaker should be used according to the transformer power rating.

The transformers considered have the primary winding outside the secondary winding.

The circuit-breakers suggested allow:

- transformer protection in the event of maximum short-circuit;
- prevention of unwanted tripping when the primary winding is powered up using
 1. modular circuit-breakers with a high magnetic threshold, curve D or K
 2. circuit-breakers with magnetic only releaser;
- guaranteed circuit-breaker electrical life.

Protection on the secondary side

Due to the transformer's high insertion current, the circuit-breaker on the primary winding may not guarantee thermal protection for the transformer and its feeder line on the primary side.

This is typical of modular circuit-breakers which must have a higher rated current than the transformers. In such cases, in the event of a single-phase short-circuit at the transformer's primary terminals (minimum I_{cc} at end of line), check that the circuit-breaker's magnetic releaser is tripped. In the normal application in distribution panels, this condition is always satisfied provided that the length of the feeder lines is reduced.

The transformer can be provided with thermal protection by installing a circuit-breaker with a rated current less than or equal to that of the transformer secondary winding immediately downstream of the LV/LV transformer.

In lighting systems protection against overloads is not necessary if the number of light points is clearly defined (no overloads).

Moreover, the Standard in force for these systems recommends the omission of protection against overloads in circuits in which unwanted tripping may prove hazardous, e.g.: circuits which supply fire-fighting equipment.

MCBs technical details

Particular supply sources and loads

Single-phase transformer (primary voltage 230 V)-1P and 1P+N MCBs

Pn [kVA]	In [A]	ucc (%)	Circuit-breaker on primary side (1) and (2)
0.1	0.4	13	S 2* D1 o K1
0.16	0.7	10.5	S 2* D2 o K2
0.25	1.1	9.5	S 2* D3 o K3
0.4	1.7	7.5	S 2* D4 o K4
0.63	2.7	7	S 2* D6 o K6
1	4.2	5.2	S 2* D10 o K10
1.6	6.8	4	S 2* D16 o K16
2	8.4	2.9	S 2* D16 o K16
2.5	10.5	3	S 2* D20 o K20
4	16.9	2.1	S 2* D40 o K40
5	21.1	4.5	S 2* D50 o K50
6.3	27	4.5	S 2* D63 o K63

Single-phase transformer (primary voltage 400 V)-2P MCBs

Pn [kVA]	In [A]	ucc (%)	Circuit-breaker on primary side (1) and (2)
1	2.44	8	S 2* D6 o K6
1.6	3.9	8	S 2* D10 o K10
2.5	6.1	3	S 2* D16 o K16
4	9.8	2.1	S 2* D20 o K20
5	12.2	4.5	S 2* D32 o K32
6.3	15.4	4.5	S 2* D40 o K40
8	19.5	5	S 2* D50 o K50
10	24	5	S 2* D63 o K63
12.5	30	5	S 2* D63 o K63

Three-phase transformer (primary voltage 400 V)-3P, 3P+N and 4P MCBs

Pn [kVA]	In [A]	ucc (%)	Circuit-breaker on primary side (1) and (2)
5	7	4.5	S 2* D20 o K20
6.3	8.8	4.5	S 2* D20 o K20
8	11.6	4.5	S 2* D32 o K32
10	14	5.5	S 2* D32 o K32
12.5	17.6	5.5	S 2* D40 o K40
16	23	5.5	S 2* D63 o K63
20	28	5.5	S 2* D63 o K63

S 2*.. = S 200, S 200 M, S 200 P

(1) With modular or magnetic only circuit-breakers, without thermal adjustment, thermal protection is required for the transformer's secondary winding.

(2) Breaking capacity selected according to estimated Icc at the point where the breaker is installed.

Double tampoprinting of S 200 P

The breaking capacity

For the modular circuit-breakers realized according to IEC/EN 60898 standard, the breaking capacity is expressed by the Icn quantity, indicated in Ampere, contained within a rectangle on the front side of the device. The max value of rated short-

circuit capacity (Icn) considered by this standard is 25000 A.

Always according to IEC/EN 60898 standard, the ratio between the service short-circuit capacity (Ics) and the rated short-circuit capacity (Icn) – K factor – shall have to be conforming to the enclosed table.

Icn	K
< 6000 A	1
> 6000 A	0.75(*)
< 10000 A	
>10000 A	0.5(**)

(*) Ics minimum value: 6000 A (**) Ics minimum value: 7500 A

Limiting class

The Manufacturer of the circuit-breaker has the right to declare the energy limiting class of the device. According to IEC/EN 60898 standard, the Manufacturer classifies the

circuit-breaker with a limiting class which ranges from 1 to 3 according to the I2t values let through by the circuit-breaker for rated current up to 16 A and rated currents exceeding 16 A up to 32 A included, according to the table below.

Rated current up to 16 A:

Short-circuit rated capacity	Limited energy classes				
	1	2		3	
	I2t max (A2s)	I2t max (A2s)		I2t max (A2s)	
(A)	B-C Type	B Type	C Type	B Type	C Type
3000	No	31000	37000	15000	18000
4500	limits	60000	75000	25000	30000
6000	are	100000	120000	35000	42000
10000	specified	240000	290000	70000	84000

10

Rated current exceeding 16 A up to 32 A included:

Short-circuit rated capacity	Limited energy classes				
	1	2		3	
	I2t max (A2s)	I2t max (A2s)		I2t max (A2s)	
(A)	B-C Type	B Type	C Type	B Type	C Type
3000	No	40000	50000	18000	22000
4500	limits	80000	100000	32000	39000
6000	are	130000	160000	45000	55000
10000	specified	310000	370000	90000	110000

MCBs technical details

Particular supply sources and loads

For instance, a circuit-breaker with rated current 16 A, B characteristic, with short-circuit rated capacity equal to 6 kA belongs to class 3 if it lets through max 35000 A²s of specific energy.

The limiting class value (1, 2 or 3) is indicated on the front side of the device, within a square, in addition to the breaking capacity.

As regards the miniature circuit-breakers S200P series, two different breaking capacities are indicated on the front side of the device, contained in a rectangle.

The breaking capacity indicated above the operating toggle is the one of the device, according to IEC/EN 60898 standard, the breaking capacity indicated under the lever is regarding the limiting class which, according to the standard, can be expressed only for values up to 10000 A.

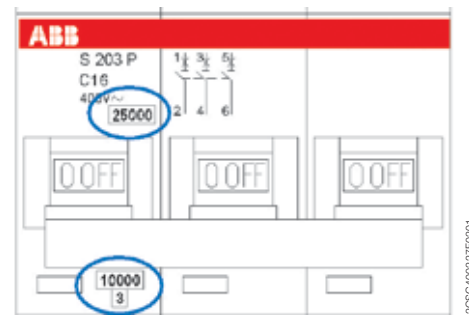

MCBs technical details

WT63

10

Motor starter combinations acc. to IEC/EN 60947-4-1

690 V AC, 35 kA, type 2, normal start-up

Motor		Short-circuit protection		Contactor		Overload protection		Wiring	
Rated output	Rated current	Current limiter	Manual motor starter	Tripping current	Type	Safety clearance	Type	Current setting range	WT63-MMS
[kW]	[A]			[A]		[mm]		[A]	[mm ²]
0.37	0.61	WT63-3 or	MS/MO 325-1.0	11.50	A9	15	TA 25 DU 1.0	0.63-1.0	max. 16
1.5	2.08	WT63-3 HS	MS/MO 325-2.5	28.75	A12	15	TA 25 DU 2.4	1.7-2.4	max. 16
1.1	2.36		MS/MO 325-2.5	28.75	A12	15	TA 25 DU 3.1	2.3-3.1	max. 16
3	3.6		MS/MO 325-4.0	40.00	A12	15	TA 25 DU 4.0	2.8-4.0	max. 16
4	4.97		MS/MO 325-6.3	78.75	A26	15	TA 25 DU 6.5	4.5-6.5	max. 16
7.5	8.7		MS/MO 325-12.5	187.50	A26	15	TA 25 DU 11	7.5-11	max. 16

For further combinations please contact the manufacturer.

Application notes

- WT63 may only be used for motor starter combinations confirmed by the manufacturer
 - Max. no. of motor groups to be protected by WT63: 5
 - The wiring between WT63 and MMS has to be short-circuit proof
 - WT63 has to be installed with fitted terminal covers (factory assembled)
- The max. total operating current of WT63 has to be limited to 63 A, the max. total start-up current shall not exceed 450 A
- For more details see separate product brochure.

RCDs technical details

Functions and classification criteria for RCDs

Functions and classification criteria for RCDs

A residual current operated circuit-breaker is an amperometric protection device which is tripped when the system leaks a significant current to earth.

This device continuously calculates the vector sum of the single-phase or three-phase system line currents and while the sum is equal to zero allows electricity to be supplied. This supply is rapidly interrupted if the sum exceeds a value preset according to the sensitivity of the device.

Residual current operated circuit-breakers can be classed according to four parameters:

- type of construction
- detectable wave form
- tripping sensitivity
- tripping time.

Depending on the type of construction, RCDs may be classed as:

- RCBOs (magnetothermic with overcurrent protection)
- RCCBs (without overcurrent protection releaser incorporated)
- RCD blocks.

RCBOs combine, in a single device, the residual current function and the overcurrent protection function typical of MCBs. RCBOs are tripped by both current leakage to earth and overloads and short-circuits and they are self-protecting up to a maximum short-circuit current value indicated on the label. RCCBs are only sensitive to current leakage to earth. They must be used in series with an MCB or fuse which protects them from the potentially damaging thermal and dynamic stresses of any overcurrents.

These devices are used in systems already equipped with MCBs which preferably limit the specific energy passing through, also acting as the main disconnecting switches upstream of any derived MCBs (e.g.: domestic consumer

unit).

RCD blocks are residual current devices suitable for assembly with a standard MCB. IEC/EN 61009 app. G only allows assembly of RCBOs once on site, that is to say outside the factory, using adaptable RCD blocks and the appropriate MCBs. Any subsequent attempts to separate them must leave permanent visible damage. The residual current operated circuit-breaker obtained in this way maintains both the electrical characteristics of the MCB and those of the RCD block.

According to the wave form of the earth leakage currents they are sensitive to, the RCDs may be classed as:

- AC type (for alternating current only)
- A type (for alternating and/or pulsating current with DC components)
- B type (for alternating and/or pulsating current with DC components and continuous fault current).

AC type RCDs are suitable for all systems where users have sinusoidal earth current.

They are not sensitive to impulsive leakage currents up to a peak of 250 A (8/20 wave form) such as those which may occur due to overlapping voltage impulses on the mains (e.g.: insertion of fluorescent bulbs, X-ray equipment, data processing systems and SCR controls).

A type RCDs are not sensitive to impulsive currents up to a peak of 250 A (8/20 wave form).

They are particularly suitable for protecting systems in which the user equipment has electronic devices for rectifying the current or phase cutting adjustment of a physical quantity (speed temperature, light intensity, etc.) supplied directly by the mains without the insertion of transformers and insulated in class I (class II is, by definition, free of faults to earth). These devices may generate a pulsating fault current with DC components which the A type RCD can recognise.

RCDs technical details

Functions and classification criteria for RCDs

B type RCDs are recommended for use with drives and inverters for supplying motors for pumps, lifts, textile machines, machine tools, etc., since they recognise a continuous fault current with a low level ripple.

Type AC, A and B RCDs comply with IEC/EN 61008/61009, moreover type B is covered by IEC 62423 Ed. 1 and by IEC/EN 60755 for residual current operated protective devices.

According to tripping sensitivity ($I_{\Delta n}$ value), RCDs may be divided into the following categories:

- low-sensitivity ($I_{\Delta n} > 0.03$ A), not suitable for protection against direct contacts; co-ordinated with the earth system according to the formula $I_{\Delta n} < 50/R$, to provide protection against indirect contacts;
- high-sensitivity ($I_{\Delta n}$: 0.01...0.03 A), or "physiologically sensitivity" for protection against indirect contacts, with simultaneous additional protection against direct contacts.
- against fire (up to 500 mA) according to IEC/EN 60364

Residual current sensitivity and environment

Household and special environments



$I_{\Delta n}$
≤ 30 mA

High-sensitivity or physiologically sensitive RCDs

IEC/EN 60364 makes the use of these devices mandatory in all bathrooms, showers and private and public swimming pools and environments in which plugs and sockets may be installed without insulating or low safety voltage transformers.

Laboratories, service industry and small industry



$I_{\Delta n}$
from 30 mA
to 500 mA

Low-sensitivity RCDs

Large service industry and industrial complex



$I_{\Delta n}$
from 500 mA
to 1000 mA

According to their tripping time, RCDs can be classed as:

- instantaneous (or rapid or general)
- type S selective (or - incorrectly - delayed).

Selective RCDs (RCBOs - RCCBs or RCD-blocks) have a delayed tripping action and are installed upstream of other rapid residual current operated circuit-breakers to guarantee selectivity and limit the power out only to the portion of the system affected by a fault.

The tripping time is not adjustable. It is set according to a pre-determined time – current characteristic with an intrinsic delay for small currents, tending to disappear as the current grows.

IEC/EN 61008 and 61009 establish the tripping times relative to the type of RCD and the $I_{\Delta n}$.

Type AC	I_n [A]	I_{Δ} [A]	Tripping times (s)xcurrents			
			$1 \times I_{\Delta}$	$2 \times I_{\Delta}$	$5 \times I_{\Delta}$	500A
Generic	Any	Any	0.3	0.15	0.04	0.04
S (selective)	Any	>0.030	0.13-0.5	0.06-0.2	0.05-0.15	0.04-0.15

The indicated maximum tripping times are also valid for A type RCDs, but increasing the current values of factor 1.4 for RCDs with $I_{\Delta n} > 0.01$ A and of factor 2 for RCDs with $I_{\Delta n} \leq 0.01$ A.

The range of ABB RCDs also includes AP-R (anti-disturbance) devices which trip according to the limit times allowed by the Standards for instantaneous RCDs. This function is due to the slight tripping delay (approx. 10 ms) relative to the standard instantaneous ones.

The graph shows the comparison of the qualitative tripping curves for:

- a 30 mA instantaneous RCD
- a 30 mA AP-R instantaneous RCD
- a 100 mA selective RCD (type S)

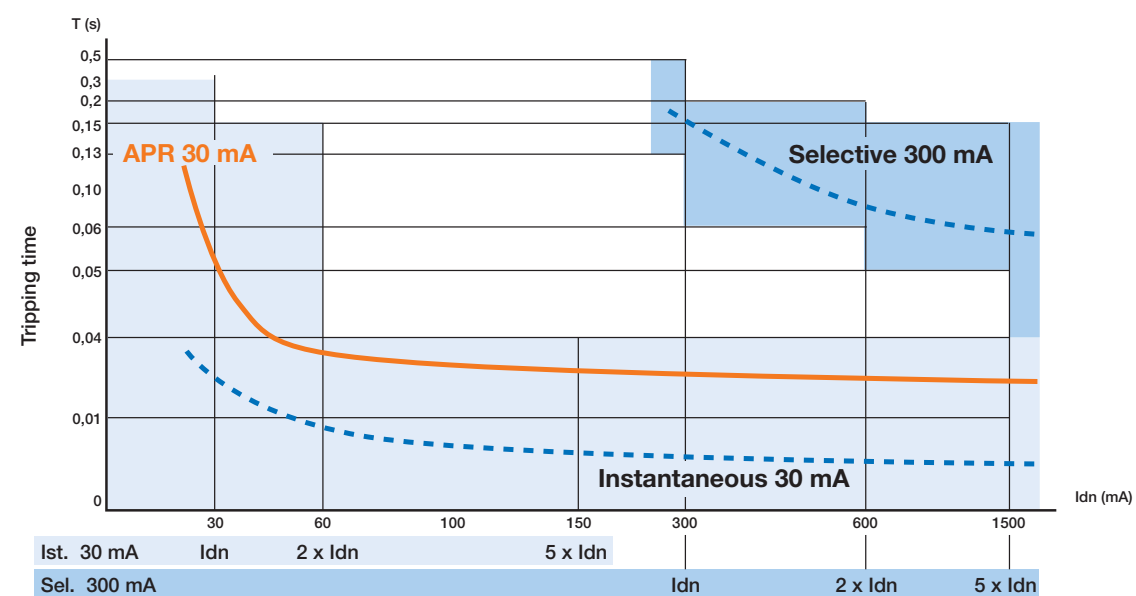

Note: this is a qualitative chart; it is referred only to industrial frequencies of 50-60 Hz.

RCDs technical details

Coordination tables: F 200 RCCBs

Coordination tables between Short Circuit Protection Devices (SCPD) and F 200 RCCBs

If you are using an RCCB you must verify that the Short Circuit Protection Device (SCPD) protects it from the effects of high current that arise under short-circuit conditions. The IEC/EN 61008 provides some tests to verify the behaviour of RCCB in short-circuit conditions. The tables below provide

the maximum withstanding short-circuit current expressed in eff. kA for which the RCCBs are protected thanks to the coordination with the SCPD installed upstream or downstream. The tests are performed with SCPD with a rated current (thermal protection) less than or equal to the rated current of the associated RCCB.

F 202

	Single-phases 230-240 V circuit					
	25 A	40 A	63 A	80 A	100 A	125 A
SN201L/S201L Na	4,5	4,5				
SN201/S201 Na	6	6				
SN201M/S201M Na	10	10				
S202L	10	10				
S202	20	20	20			
S202M	25	25	25			
S202P	40	25	25			
S292	25	25	25	25	25	25
S702	10	10	10	10	10	
S752	10	10	10			
S802N	36	36	36	36	36	36
S802S	50	50	50	50	50	50
Fuse 25 gG	100					
Fuse 40 gG	60	60				
Fuse 63 gG	20	20	20			
Fuse 100 gG	10	10	10	10	10	
Fuse 125 gG						10

F 202

	400-415 V circuits with isolated neutral (IT) under double faults					
	25 A	40 A	63 A	80 A	100 A	125 A
SN201N/SN201/SN201M	3	3				
S201L/S201L Na/S202L	4,5	4,5				
S201/S201 Na/S202	6	6	6			
S201M/S201M Na/S202M	10	10	10			
S201P/S201P Na/S202P	25	15	15			
S291/S292	10	10	10	10	10	10
S801N/S802N	20	20	20	20	20	20
S801S/S802S	25	25	25	25	25	25

F 204

	Three-phases circuits with neutral (y/D) 230-240 V/400-415 V*					
	25 A	40 A	63 A	80 A	100 A	125 A
SN201L/S201L/S201LNa*	4.5	4.5				
SN201/S201/S201Na*	6	6				
SN201M/S201M/S201MNa*	10	10				
S202L*	10	10				
S202*	20	20	20			
S202M*	25	25	25			
S202P*	40	25	25			
S292*	25	25	25	25	25	25
S702	10	10	10	10	10	
S752	10	10	10			
S802N*	36	36	36	36	36	36
S802S*	50	50	50	50	50	50
Fuse 25 gG	100					
Fuse 40 gG	60	60				
Fuse 63 gG	20	20	20			
Fuse 100 gG	10	10	10	10	10	
Fuse 125 gG						10

* The switches are considered between phase and neutral (230/240V)

F 204

	Three-phases circuits with neutral (y/D) 230-240 V/400-415 V					
	25 A	40 A	63 A	80 A	100 A	125 A
S203L/S204L	4.5	4.5				
S203/S204	6	6	6			
S203M/S204M	10	10	10			
S203P/S204P	25	15	15			
S293/S294	10	10	10	10	10	10
S702	10	10	10	10	10	
S752	10	10	10			
S803N/S804N	20	20	20	20	20	20
S803S/S804S	25	25	25	25	25	25
Fuse 25 gG	50					
Fuse 40 gG	30	30				
Fuse 63 gG	20	20	20			
Fuse 100 gG	10	10	10	10	10	
Fuse 125 gG						10

RCDs technical details

Coordination tables: F 200 RCCBs

F 204

	Three-phases circuits with neutral (y/D) 133-138V/230-240V					
	25 A	40 A	63 A	80 A	100 A	125 A
SN201L	10	10				
SN201	15	15				
S201M	20	20				
S203L/S204L	10	10				
S203/S204	20	20	20			
S203M/S204M	25	25	25			
S203P/S204P	40	25	25			
S293/S294	25	25	25	25	25	25
S702	10	10	10	10	10	
S752	10	10	10			
S803N-S804N	36	36	36	36	36	36
S803S-S804S	50	50	50	50	50	50
Fuse 25 gG	100					
Fuse 40 gG	60	60				
Fuse 63 gG	20	20	20			
Fuse 100 gG	10	10	10	10	10	
Fuse 125 gG						10

RCDs technical details

Coordination tables: residual current protection selectivity

Selectivity

RCDs raise similar issue to those surrounding the installation of MCBs, and in particular the need to reduce to a minimum the parts of the system out of order in the event of a fault. For RCBOs the problem of selectivity in the case of short-circuit currents may be handled with the same specific criteria as for MCBs.

However, for correct residual current protection, the more important aspects are linked to tripping times. Protection against contact voltages is only effective if the maximum times indicated on the safety curve are not exceeded.

If an electrical system has user devices with earth leakage currents which exceed the normal values (e.g.: presence of capacitor input filters inserted between the device phase and earth cables) or if the system consists of many user devices, it is good practice to install various RCDs, on the main branches, with an upstream main residual current or non-residual current device instead of a single main RCD.

Horizontal selectivity

The non-residual current main circuit-breaker provides “horizontal selectivity”, preventing an earth fault at any point on the circuit or small leakage from causing unwanted main circuit-breaker tripping, which would put the entire system out of order.

However, in this way, section k of the circuit between the main circuit-breaker and the RCDs remains without “active” protection. Using a main RCD to protect it would lead to problems with “vertical selectivity”, which require tripping of the various devices to be co-ordinated, so that service continuity and system safety are not compromised. In this case, selectivity may be amperometric (partial) or chronometric (total).

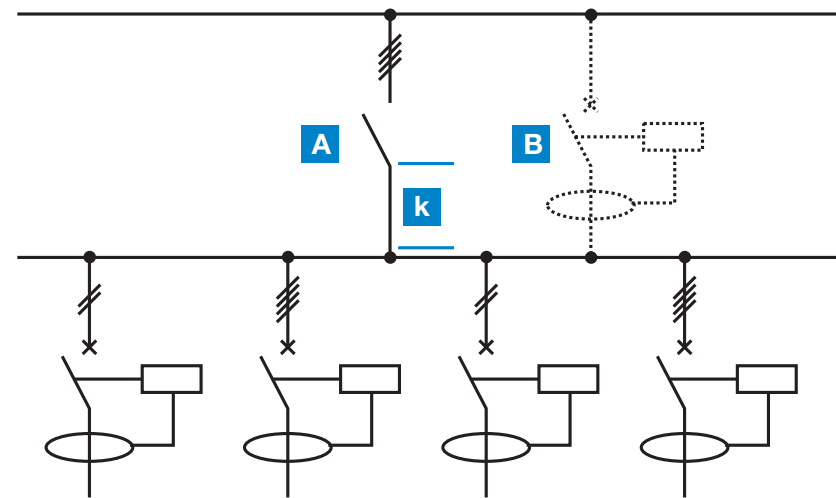

10

Vertical selectivity

Vertical selectivity may also be established for residual current tripping, bearing in mind that in working back from system peripheral branches to the main electrical panels the risk of unskilled persons coming into contact with dangerous parts is significantly reduced.

RCDs technical details

Coordination tables: residual current protection selectivity

Amperometric (partial) selectivity

Selectivity may be created by placing low-sensitivity RCDs upstream and higher-sensitivity RCDs downstream.

An essential condition which must be satisfied in order to achieve selective co-ordination is that the $I\Delta 1$ value of the breaker upstream (main breaker) is more than double the $I\Delta 2$ value of the breaker downstream. The operative rule to obtain

an amperometric (partial) selectivity is $I\Delta n$ of the upstream breaker = $3 \times I\Delta n$ of the downstream breaker (e. g.: F 204, A type, 300 mA upstream; F 202, A type, 100 mA downstream). In this case, selectivity is partial and only the downstream breaker trips for earth fault currents $I\Delta 2 < I\Delta m < 0.5 \cdot I\Delta 1$.

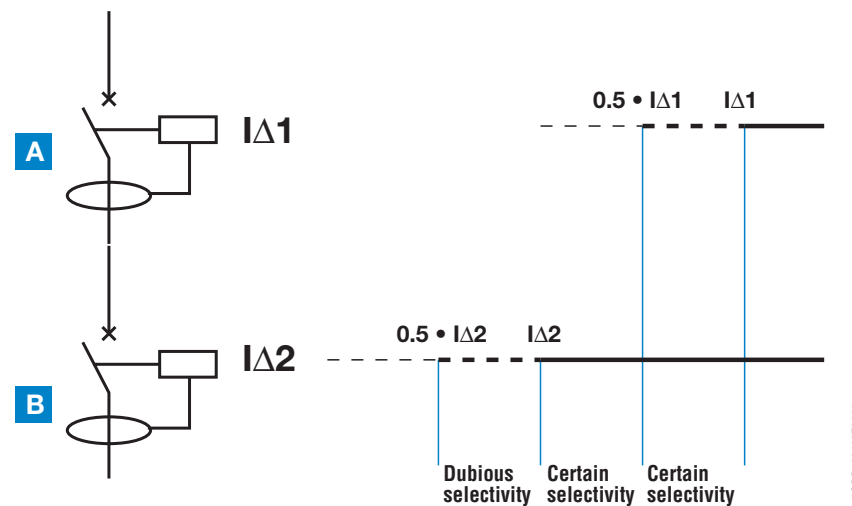

Chronometric (total) selectivity

To achieve total selectivity, delayed or selective RCDs must be installed.

The tripping times of the two devices connected in series must be co-ordinated so that the total interruption time t_2 of the downstream breaker is less than the upstream breaker's no-response limit time t_1 , for any current value. In this way, the downstream breaker completes its opening before the upstream one.

To completely guarantee total selectivity, the $I\Delta$ value of the upstream device must also be more than double that of the downstream device in accordance with IEC 64-8/563.3, comments. The operative rule to obtain an amperometric (partial) selectivity is $I\Delta n$ of the upstream breaker = $3 \times I\Delta n$ of the downstream breaker (e. g.: F 204, S type, 300 mA upstream; F 202, A type, 100 mA downstream). For safety reasons, the delayed tripping times of the upstream breaker must always be below the safety curve.

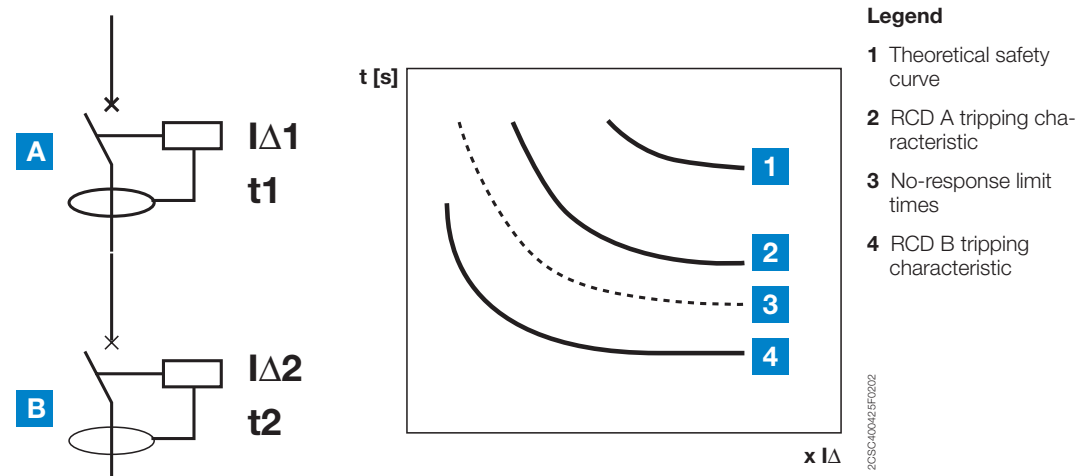

Table of RCD selectivity

	Upstream I Δ n [mA]	10	30	100	300	300	500	500	1000	1000
Downstream I Δ n [mA]	inst	inst	inst	inst	S	inst	S	inst	S	
10	inst		■	■	■	■	■	■	■	■
30	inst			■	■	■	■	■	■	■
100	inst				■	■	■	■	■	■
300	inst								■	■
300	S								■	■
500	inst									
500	S									
1000	inst									
1000	S									

inst=instantaneous S=selective ■=amperometric (partial) selectivity ■=chronometric (total) selectivity

RCDs technical details

Power loss, derating and performance in altitude

Power loss and internal resistance of RCDs and RCBOs

RCCBs F200 series		
Rated current In [A]	Power loss W [Ⓞ]	
	[W]	
	2P	4P
16	1.5	-
25	1.0	1.3
40	2.4	3.2
63	3.2	4.4
80	8.8	33,3
100	15.2	44,4
125	-	28

RCD-Blocks DDA200 series		
Rated current Ib [A]	Power loss Wlb* [Ⓞ]	
	[W]	
	2P	3P,4P
25	2.0	3.0
40	3.2	4.8
63	5.0	7.6

* The power loss W_{lb} shown in the table refers to I_b . For use with circuit-breakers with lower rated current I_n the power loss W must be determined using the formula: $W = (I_n / I_b) \cdot W_{lb}$

RCD-Blocks DDA800		
Rated current Ib [A]	Power loss Wlb* [Ⓞ]	
	[W]	
	2P	4P
63	9	13.5
100	7	10.5

* The power loss W_{lb} shown in the table refers to I_b . For use with circuit-breakers with lower rated current I_n the power loss W must be determined using the formula: $W = (I_n / I_b) \cdot W_{lb}$

RCBOs DS 200, DS 200 M series				
Rated current In [A]	Power loss W [Ⓞ]			
	[W]		[W]	
	Characteristic B-C		Characteristic K	
	2P	3P/4P	2P	3P/4P
6	4.1	6.2	3.9	5.9
10	2.9	4.4	2.9	4.2
13	5.2	7.7	3.1	4.5
16	4.5	6.6	4.9	7.2
20	6.4	9.3	6.8	9.9
25	8.5	12.4	7.9	11.5
32	10.9	15.7	10.7	15.4
40	15	21.6	14.4	20.7
50	11.4	18.4	10.7	17.4
63	17.4	28.2	18.2	29.4

RCBOs DS201, DS202C series				
Rated current In [A]	DS201		DS202C	
	Power loss [Ⓞ]	Internal resistance	Power loss [Ⓞ]	Internal resistance
	[W]	[mW]	[W]	[mW]
1	1,0	1011		
2	1,6	411		
4	2,5	155		
6	4,4	123,4	8,1	224,8
8	1,5	23,1		
10	2,3	23,1	4,1	40,6
13	2,2	13,3	3,5	21
16	3,4	13,3	5,4	21
20	4,4	11,1	6,6	16,6
25	3,9	6,2	5,5	8,8
32	5,9	5,8	8,2	8
40	8,6	5,4		

[Ⓞ] datas available in the tables are referred to the Power Loss per device

Derating of load capability of RCBOs DS 200 series, DS201 and DS202C

For DS 200 see tables for S 200 MCBs in technical details MCBs and dedicated tables for DS201 and DS202C, within the range of temperatures from -25 °C to +55 °C.

Performance in altitude of RCDs

ABB RCDs are able to operate at altitude higher than foreseen by the relevant standard IEC/ EN 61008 and IEC/ EN 61009 taking into account the corrective factor below detailed:

Elevation	[m]	3000	4000	5000	6000
Rated Current	[A]	0,96 x In	0,94 x In	0,92 x In	0,90 x In
Rated Voltage	[V]	0,877 x Un	0,775 x Un	0,676 x Un	0,588 x Un

For altitude higher than 3.000 m the isolating characteristic is no longer available.

For DDA800 RCD Blocks according to IEC/EN 60947-2, up to 2000 meters above sea level, the rated characteristics remain unchanged.

With increasing altitude, the properties of the atmosphere change regarding composition, dielectricity, the cooling capa-

city and the pressure.

The characteristics of the DDA800 RCD Blocks therefore change: this can be measured for the most part using the change in significant parameters such as the maximum rated operational voltage and the rated current:

Elevation	[m]	2000	3000	4000	5000
Rated operational voltage U _o	[V]	690	600	540	470
Max rated current I _n	[A]	1x I _n	0,96 x I _n	0,93 x I _n	0,9 x I _n

RCDs technical details

Emergency stop using DDA 200 AE series



RCD-blocks type AE

Emergency stop using DDA 200 AE series RCD-blocks

The AE series RCD-block combines the protection supplied by the RCBOs with a positive safety emergency stop function for remote tripping.

In the AE version, the DDA 200 AE series RCD-blocks are available.

Operating principle (patented)

Two additional primary circuits powered with the same voltage and equipped with the same resistance have been added to the transformer; under normal conditions the same current would flow through, but since they are wound by the same number of coils in opposite directions they cancel each other out and do not produce any flow.

One of these two windings acts as the remote control circuit: the emergency stop is obtained by interrupting the current flow in this circuit.

The positive safety is therefore obvious: an accidental breakage in the circuit is equivalent to operating an emergency control button.

Advantages

Compared with the devices which are normally used in emergency circuits, DDA 200 AE blocks have the following advantages:

- positive safety
- no unwanted tripping if there is a temporary reduction or interruption of the mains voltage
- efficient immediate operation even after long off-service periods of the installation

Use

Application of the DDA 200 AE blocks complies with the requirements of IEC 60364-8. They are therefore suitable, for example, for escalators, lifts, hoists, electrically operated gates, machine tools, car washes and conveyor belts.

No more than one DDA 200 AE can be controlled using the same control circuit. Each DDA 200 AE requires a dedicated control circuit.

10

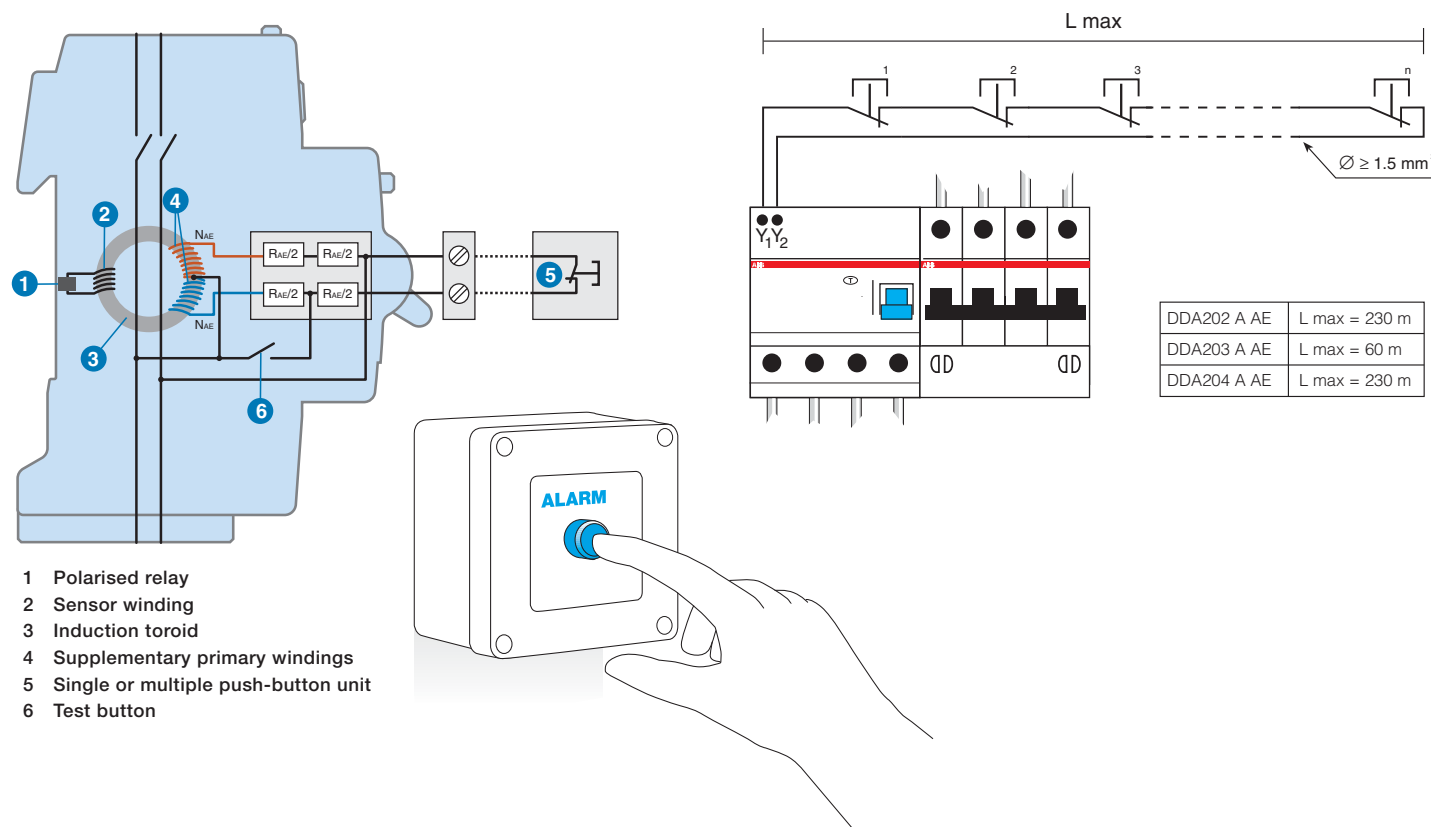

RCDs technical details

Unwanted tripping - AP-R solution (high immunity)

Unwanted tripping

In the event of disturbance in the mains, the RCDs normally present in the system are tripped, breaking the circuit even in the absence of a true earth fault.

Disturbances of this kind are most often caused by:

- operation overvoltages caused by inserting or removing loads (opening or closing protection of control devices, starting and stopping motors, switching fluorescent lighting systems on and off, etc.)
- overvoltages of atmospheric origin, caused by direct or indirect discharges on the electrical line.

Under these circumstances, breaker tripping is unwanted, since it does not satisfy the need to avoid the risks due to direct and indirect contacts. On the contrary, the sudden and unjustified interruption of the power supply may result in very serious problems.

AP-R RCDs

The ABB range of AP-R anti-disturbance residual current circuit-breakers and blocks was designed to overcome the problem of unwanted tripping due to overvoltages of atmospheric or operation origin.

The electronic circuit in these devices can distinguish between temporary leakage caused by disturbances on the mains and permanent leakage due to actual faults, only breaking the circuit in the latter case.

AP-R residual current circuit-breakers and blocks have a slight delay into the tripping time, but this does not compromise the safety limits set by the Standards in force (release time at $2 I_{\Delta n} = 150$ ms).

Guaranteeing conventional residual current protection, their installation in the electrical circuit therefore allows any unwanted tripping to be avoided in domestic and industrial systems in which service continuity is essential.

This delay makes the AP-R residual current devices especially suited for installations involving motor starters/variable speed drives, fluorescent lamps or IT/electronic equipment.

The use of multiple electronic reactors for the supply of fluorescent lamps instead generates permanent leakage currents and inrush currents that can cause nuisance tripping of a standard residual current circuit breaker.

IT system loads and other electronic equipment (e.g. dimmers, computers, inverters) with capacitive input filters connected between the phases and ground can also generate permanent earth leakage currents whose sum may provoke the nuisance tripping of a standard residual current circuit breaker. For these situations, the AP-R breakers allow a greater number of devices to be connected to the installation.

Frequency converters include a rectifier section and an inverter section.

In case of fault within a single-phase frequency converter AP-R type RCDs provide complete protection, because an earth fault occurring downstream the inverter, produces an earth fault current with multi-frequency shape with high amount of harmonics.

While, in case of fault within a three-phase frequency converter, B type RCDs ensure complete protection because in case of insulation fault between the rectifier and the inverter or downstream the inverter we can have a smooth DC earth fault current.

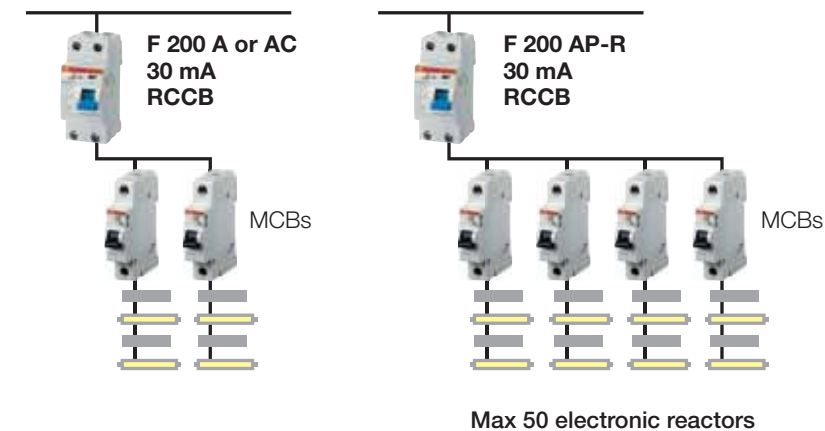

RCDs technical details

Unwanted tripping - AP-R solution (high immunity)

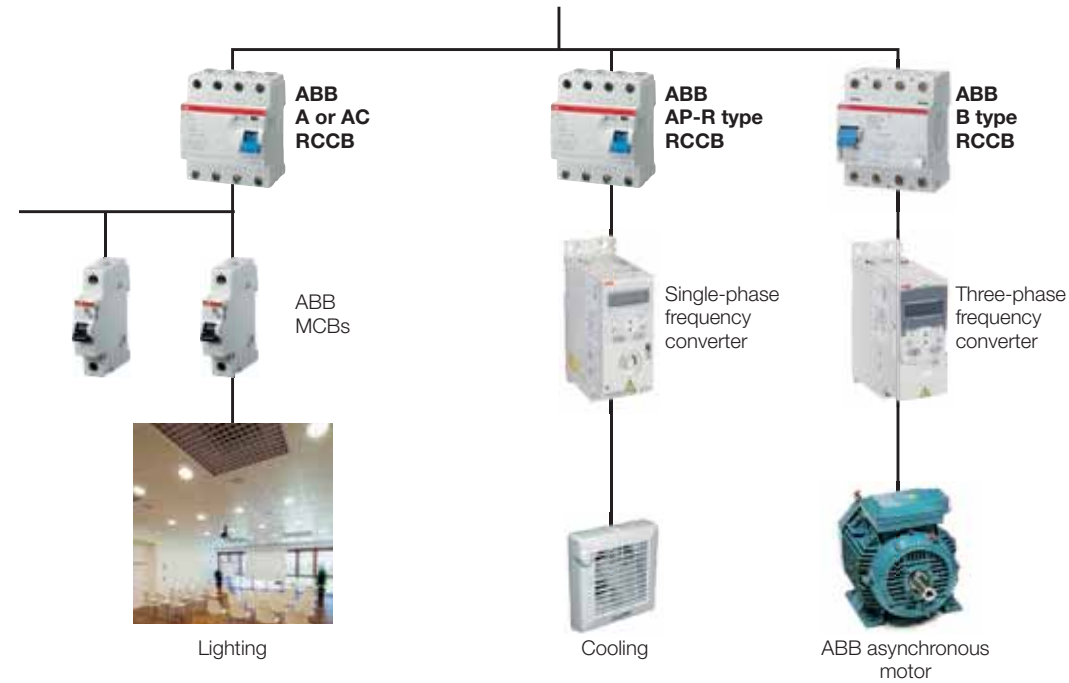

Compared with standard type breakers, AP-R residual current breakers are therefore characterised, for any given sensibility, by:

- Higher residual trip current
- Tripping time delay
- Better resistance to overvoltages, harmonics and impulse disturbances.

Regulations

The tests set out in the IEC 61008 and IEC 61009 standards verify the resistance of residual current breakers to unwanted tripping provoked by operation overvoltages, using a ring wave impulse shape of 0.5 μ s/100 kHz. All residual current

circuit-breakers are required to pass this test with a peak current value of 200 A.

For what concerns atmospheric overvoltages, the IEC 61008 and 61009 standards prescribe the 8/20 μ s surge test with a 3000 A peak current, but limit the requirement to residual current devices classified as selective; no test is required for other types.

The ABB range of AP-R anti- nuisance tripping breakers and blocks pass the general 0.5 μ s/100 kHz ring wave test and also withstand the 8/20 μ s impulse test with the same peak current of 3000 A prescribed for selective devices.

	A or AC	AP-R	B	Selective
Resistance to unwanted tripping caused by network disturbances with wave shape (0.5 μ s/100 kHz)	250	250	200	250
Resistance to nuisance tripping due to overvoltages (operational or atmospheric) peak (8/20 wave)	250	3000	3000	5000

RCDs technical details

Unwanted tripping - F2C-ARH solution

The F2C-ARH is an auto-reclosing device particularly suited for household and similar uses. It doesn't require a separate low voltage power supply, and can be supplied by the associated RCCBs (2 pole RCCBs up to 63 A – 30 mA) at the 230 V a.c. rated voltage. Another feature that makes the product ideal for home applications is an internal control unit that checks there are no

insulation faults in the system before allowing the RCCB to reclose. This ensures that reclosing occurs only in case of unwanted tripping of the RCCB (i.e. overvoltages induced by electrical storms), thus assuring continuity of power supply also in these situations.

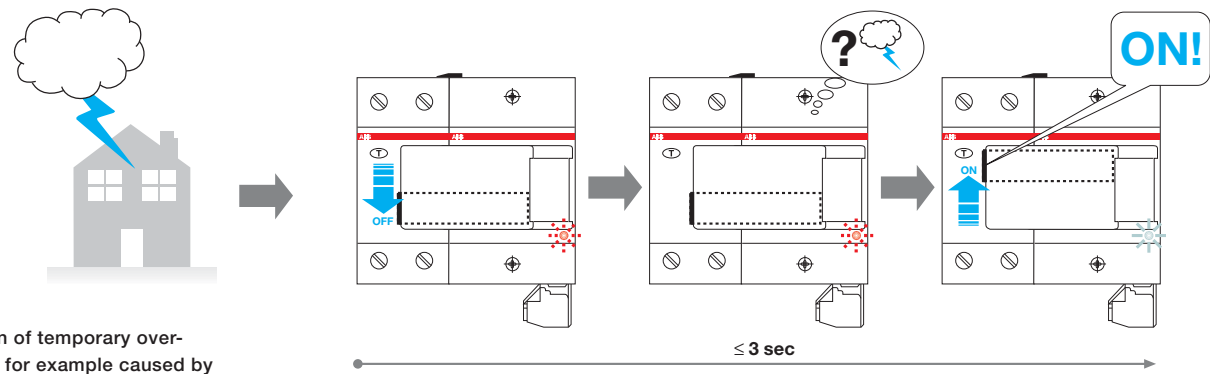

Situation of temporary over-voltage, for example caused by a lightning, that causes RCCB's untimely tripping.

When the RCCB operates in presence of an effective insulation fault, the auto-reclosing device doesn't allow its reclosing and guarantees the system insulation.

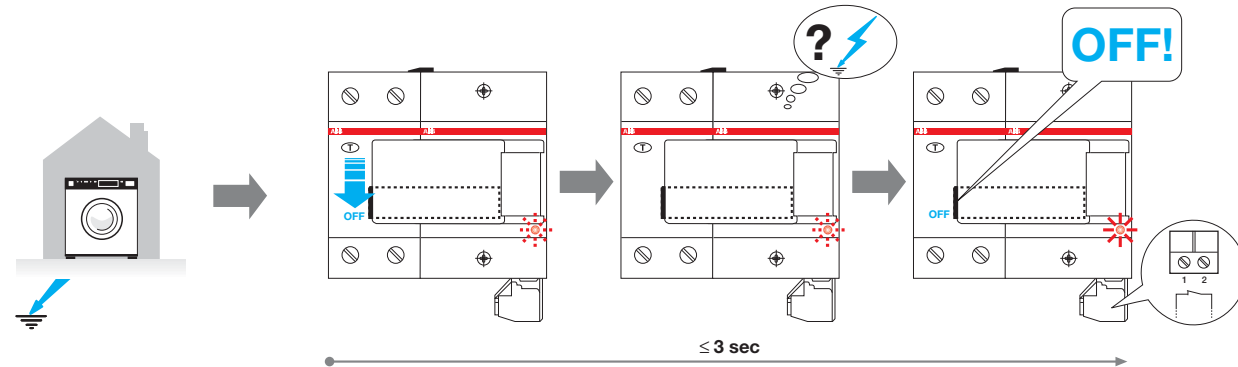

Situation of permanent earth fault that causes RCCB's tripping.

RCDs technical details

Type B RCDs

Type B RCDs

In industrial electrical applications it is more and more common to use devices where in the event of an earth fault current unidirectional direct currents or currents with a minimum residual ripple which flow through the PE conductor can emerge. These devices can be for example inverters, medical equipment (e.g. x-ray equipment and CAT), or UPS.

Type A RCDs sensitive to pulsating currents (in addition to sinusoidal currents detected by RCDs of type AC as well) cannot detect and break these earth fault direct currents or currents with a minimum level residual ripple. In case there are electrical appliances which generate this type of currents in the event of an earth fault the use of RCDs of type AC or type A would not be appropriate.

In order to meet these new demands, type B RCDs have been designed (which are able to detect the same earth fault currents detected by type AC and type A RCDs). This type of RCD (type B) is not mentioned in the reference standards for RCDs (IEC 61008-1 and IEC 61009-1). An international standard has been introduced in 2007 and it specifies additional requirements for B type RCDs.

This new standard, IEC 62423, can only be referred to together with IEC 61008-1 (for RCCBs) and IEC 61009-1 (for RCD-blocks and RCBOs), this means that B type RCDs have to be compliant to all the prescriptions of IEC 61008/9.

As already said, type B RCDs are not only sensitive to alternating and pulsating earth fault currents with DC components at a frequency of 50/60 Hz (type A), but they are also sensitive to:

- alternating currents up to a frequency of 1000 Hz;
- alternating and/or pulsating currents with DC components overlapping with a direct current;
- earth fault currents generated by a rectifier with two or more phases;
- direct earth fault currents without residual ripple

...independently of the polarity or whether the earth fault current appears suddenly or increases gradually.

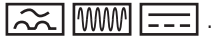

Type B RCDs must be marked with the following symbols highlighting the switches' capacity to detect every type of current:  .

Construction features

Type B RCDs consist of one section for the detection of alternating earth fault currents and unidirectional pulsating earth fault currents, which functions independently of the line voltage. For the detection of direct earth fault currents or currents with a minimum residual ripple, type B RCDs have a second electronic section, the functioning of which depends on the line voltage.

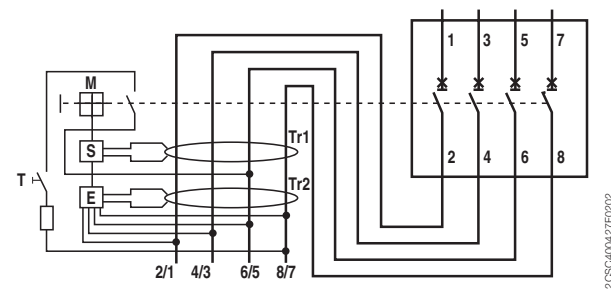
The structure of the product is illustrated in the following diagram.



- S** Release
- M** Protection device mechanism
- E** Electronics for the intervention with direct unidirectional earth fault currents
- T** Test device
- Tr1**  Residual current transformer for the detection of sinusoidal earth fault currents
- Tr2**  Residual current transformer for the detection of direct unidirectional currents.

The residual current transformer Tr1 monitors the presence of pulsating and alternating earth fault currents in the electronic installation while residual current transformer Tr2 measures the direct unidirectional currents. In the event of a fault the second transformer transmits the opening command to the release S via the (printed) circuit board E. In type B RCCBs, the section whose functioning depends on the line voltage is supplied by all three-phase conductors and the neutral, so that the functioning as type B is guaranteed even if there is a voltage only in two of the 4 power conductors. In addition, the supply of the electronic section is sized in such a way that the device can safely intervene even if there is a voltage drop of 70%.

In this way an intervention takes place when direct unidirectional earth fault currents emerge, even in the event of faults in the electric power supply grid, for example if there is no neutral conductor.

Direct or similar earth fault currents

An increasing amount of industrial equipment is supplied by circuits which in the event of a fault generate direct earth fault currents with a very low residual ripple, which can be even less than 10%. For example with direct current supplied motor drives for pumps, elevators, textile machines etc. it is becoming more common to use inverters with a three-phase rectifier bridge.

In the event of an earth fault current the wave of the earth fault is as indicated in the figure below.

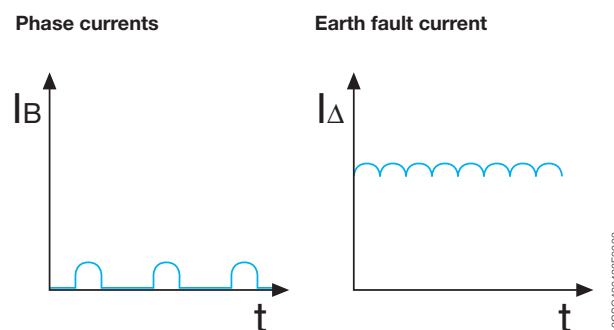
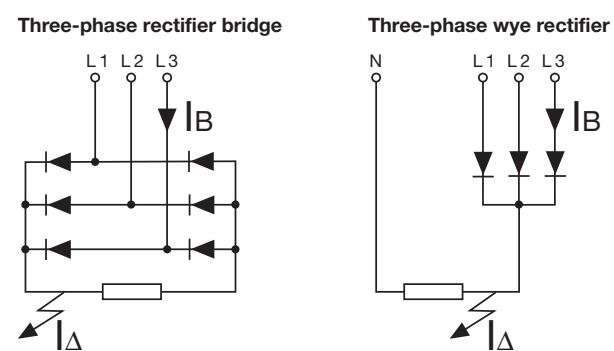

RCDs technical details

Type B RCDs

Variation of residual current tripping thresholds according to frequency

F 200 B type, 30 mA

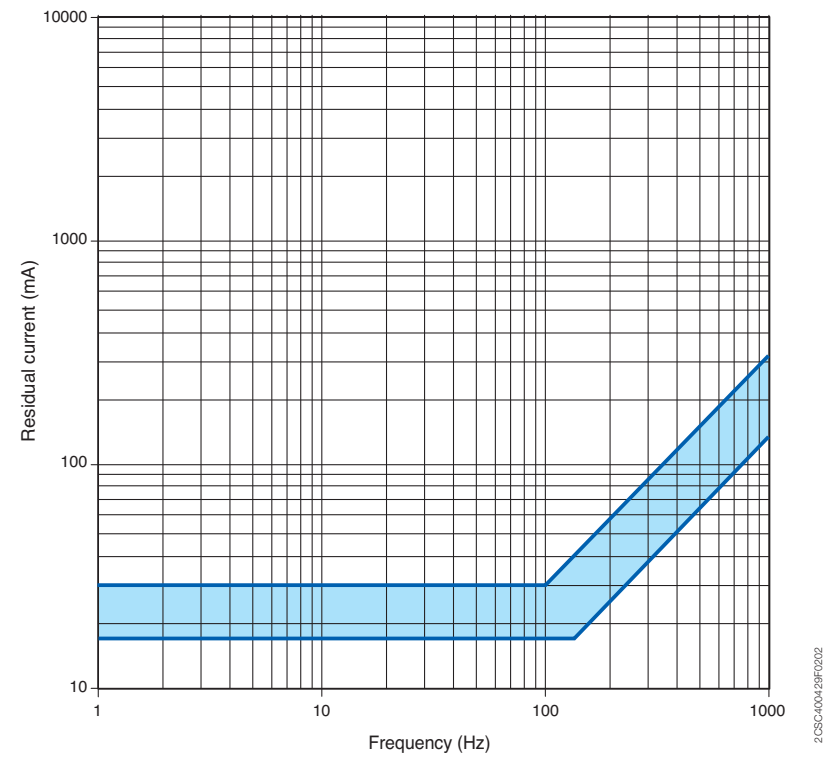

2CSC4004397002

10

F 200 B type, 300 mA

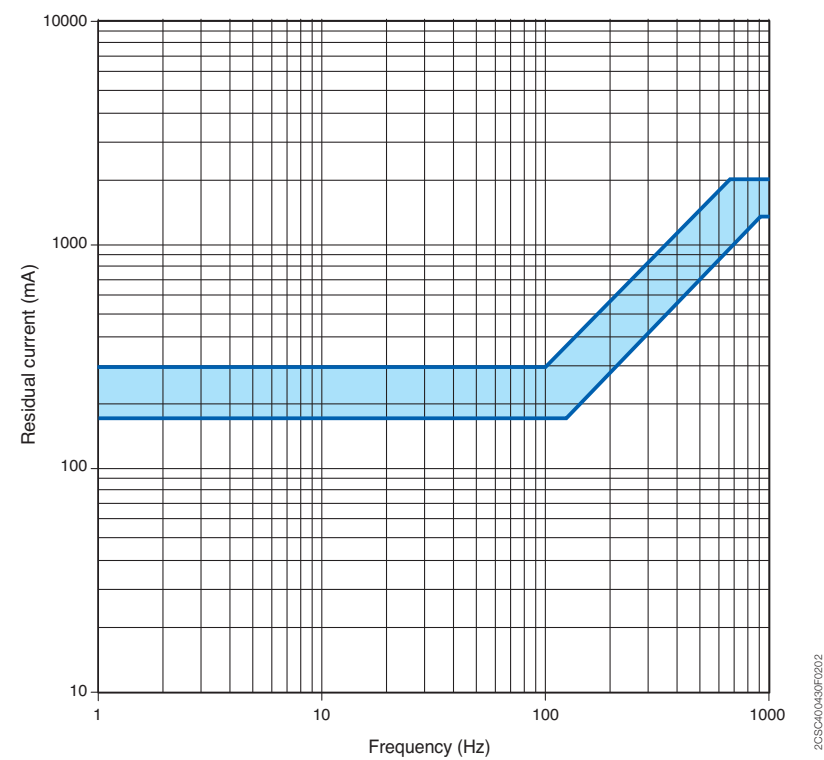

2CSC4004397002

F 200 B type, 500 mA

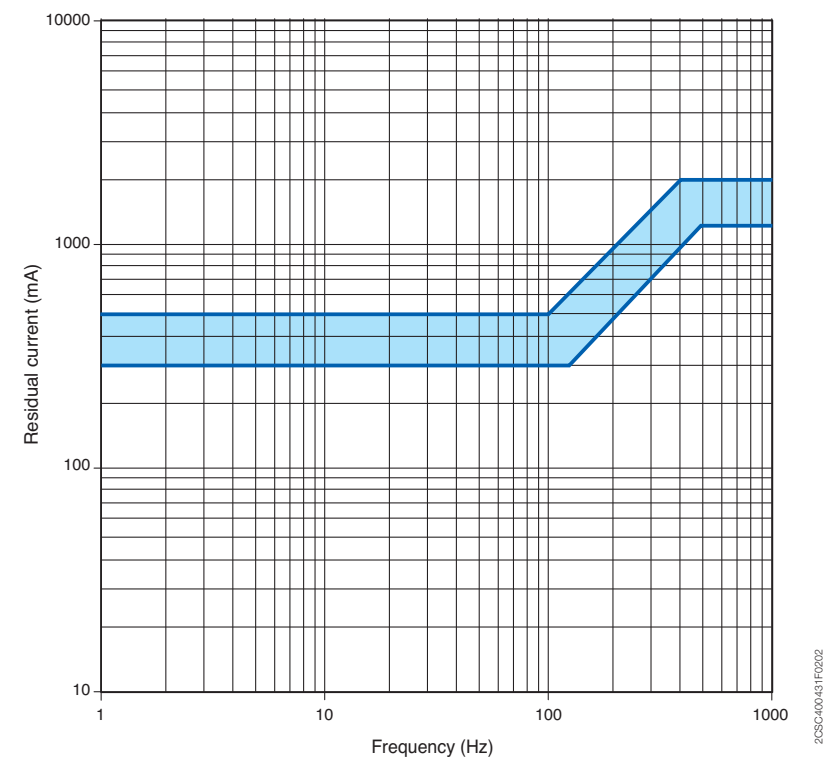

DDA 200 B type, 30 mA

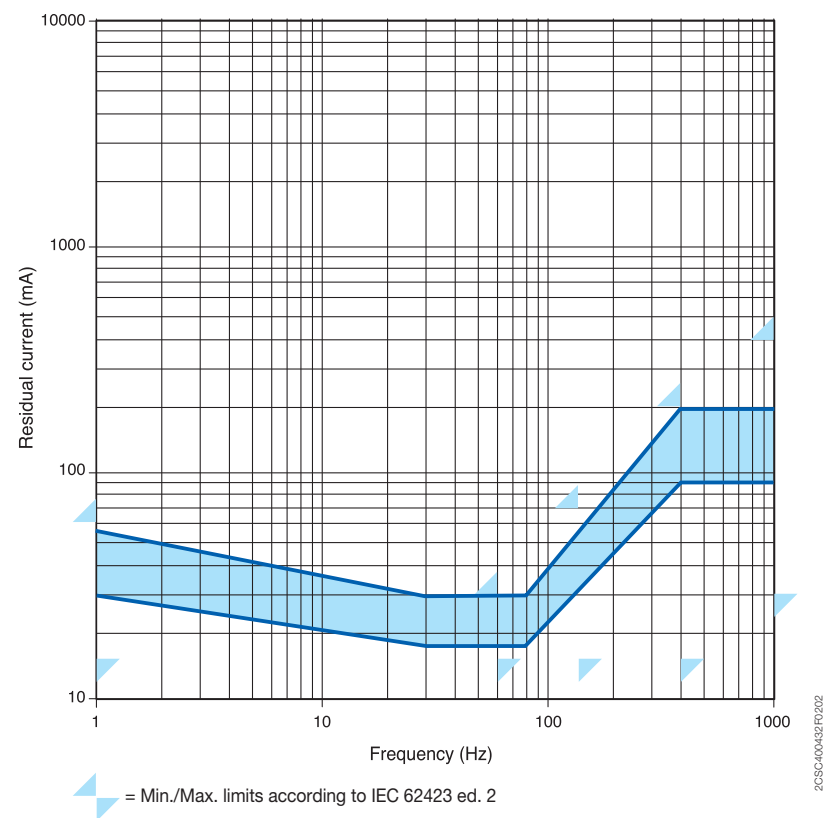

▲ = Min./Max. limits according to IEC 62423 ed. 2

RCDs technical details

Type B RCDs

DDA 200 B type, 300 mA

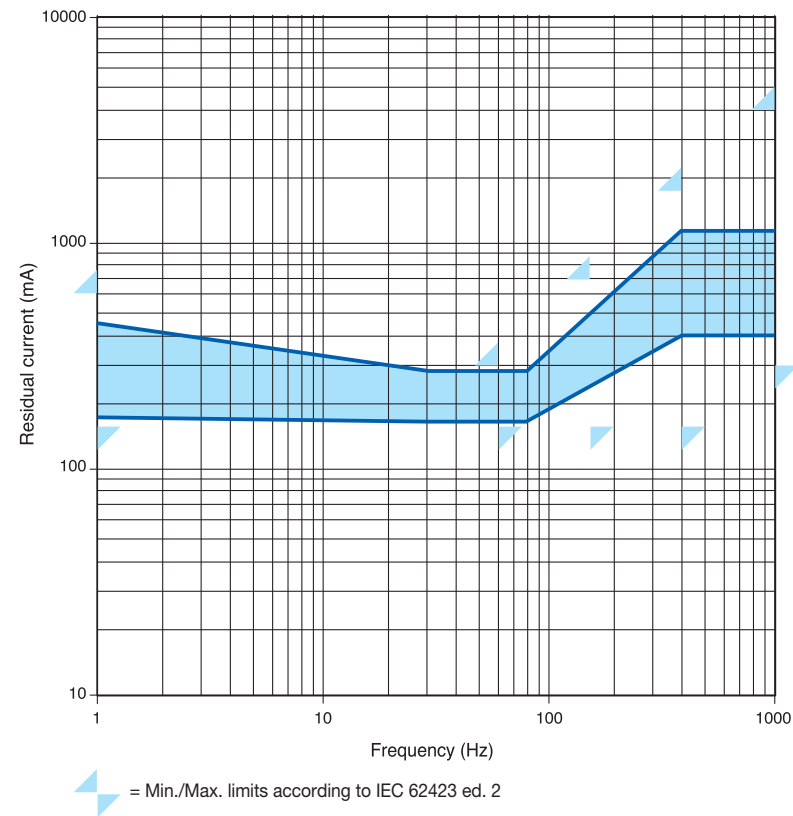

10 DDA 200 B type, 500 mA

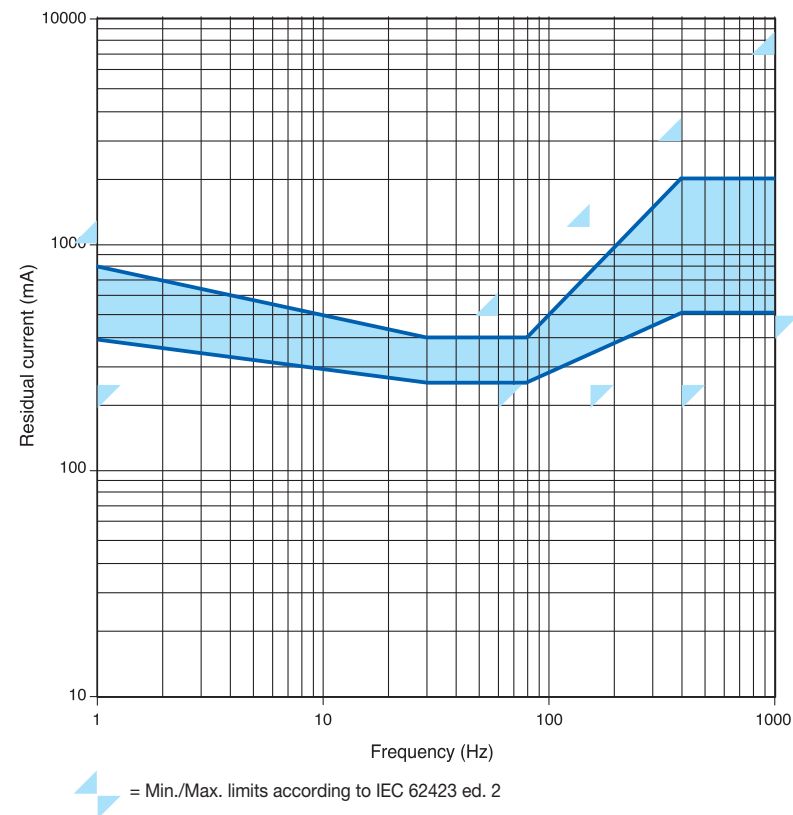

DDA 200 B S type, 300 mA

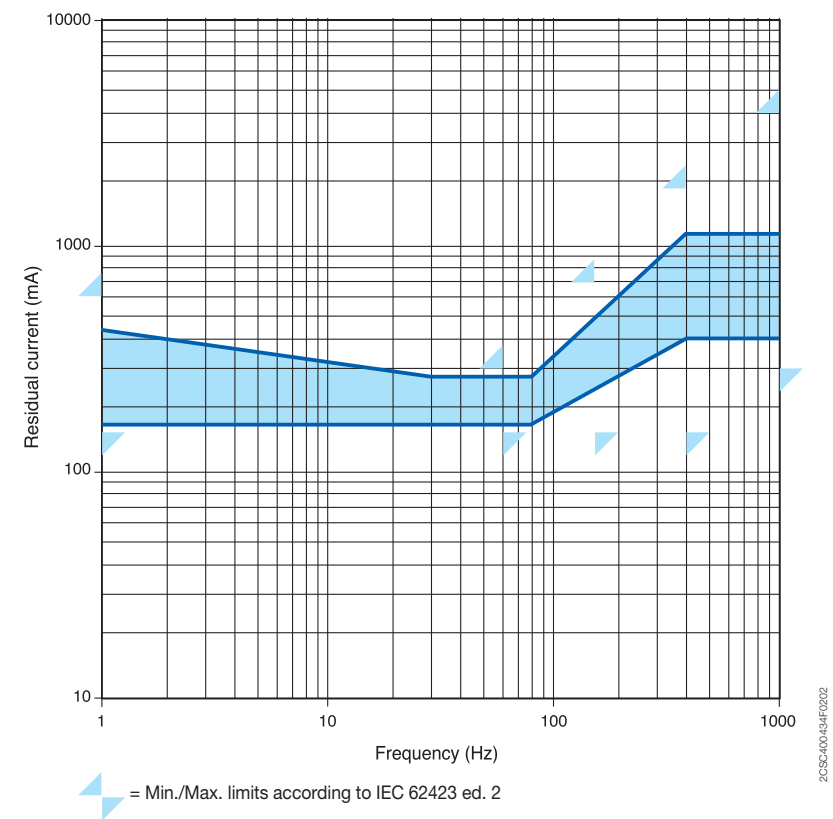

RCDs technical details

Use of 4P RCCBs in 3-phase system without neutral pole

Use of a 4P RCCB in a 3-phase circuit without neutral

The test button circuit of these RCCBs 4P F 200 is wired inside the device between terminal 5/6 and 7/8/N as indicated below, and has been sized for an operating voltage between 110 and 254 V (110 and 277 V according to UL 1053).

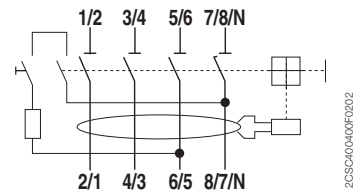

In case of installation in a 3 phase circuit without neutral, if the concatenate voltage is between 110 and 254 V (277 V according to UL 1053) for the correct working of the test button there are two possible solutions:

- 1) To connect the 3 phases to the terminals 3/4 5/6 7/8/N and the terminals 4/3 6/5 8/7/N (supply and load side respectively)
- 2) To connect the 3 phases normally (supply to terminals 1/2 3/4 5/6 and load to terminals 2/1 4/3 6/5) and to bridge terminal 1/2 and 7/8/N in order to bring to the terminal 7/8/N the potential of the first phase. In this way the test button is supplied with the phases' concatenate voltage.

10 If the circuit is supplied with a concatenate voltage higher than 254 V, as in the typical case of 3 phase net with concatenate voltage of 400 V - or 480 V according to UL 1053 - (and voltage between phase and neutral of 230 V or 277 V according to UL 1053), it is not possible to use these connections because the circuit of the test button will be supplied at 400 V and could be damaged by this voltage.

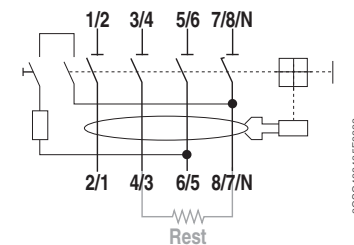

$I\Delta n$ [A]	Rest [Ω]
0.03	3300
0.1	1000
0.3	330
0.5	200

In order to allow the correct operation of the test button also in 3 phase nets at 400 V - 480 V according to UL 1053 - (concatenate voltage) it is necessary to connect normally the phases (supply to terminals 1/2 3/4 5/6 and load to terminals 2/1 4/3 6/5) and to jump terminal 4/3 and 8/7/N by mean of an electric resistance as indicated above.

In this way the test button circuit is fed at 400 V - 480 V according to UL 1053 - but for example in an RCCB with $I\Delta n=0.03$ A there will be the Rest=3.3 kOhm resistance in series to the test circuit resistance. Rest will cause a voltage drop that leaves in the test circuit a voltage less than 254 V - 277 V according to UL 1053. Rest resistance must have a power loss higher than 4 W.

In the normal operation of the RCCB (test circuit opened) the Rest resistance is not fed so it does not cause any power loss.

The solution RCCBs with neutral pole on left side

The test button circuit of these RCCBs is wired inside the device between terminal 3/4 and 5/6 as indicated below, and it has been sized for an operating voltage between 195 V and 440 V - 480 V. In case of a three phase system without neutral with concatenate voltage between phases of 230 V or 400 V - 277 V or 480 V - it is enough to connect the 3 phases normally (supply to terminals 1/2 3/4 5/6 and load to terminals 2/1 4/3 6/5) without any bridge.

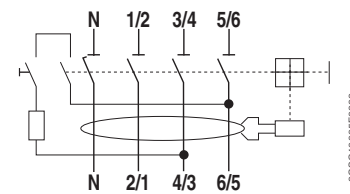

RCDs technical details

Operating voltage of test button

Operating voltage of test button

The operation of RCDs depends on the maximum and minimum operating voltage of the test button.

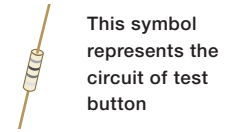

Maximum and minimum operating voltage of DS201 and DS202C test button

DS201
Ut = 110-254 V

DS202C
Ut = 110-254 V

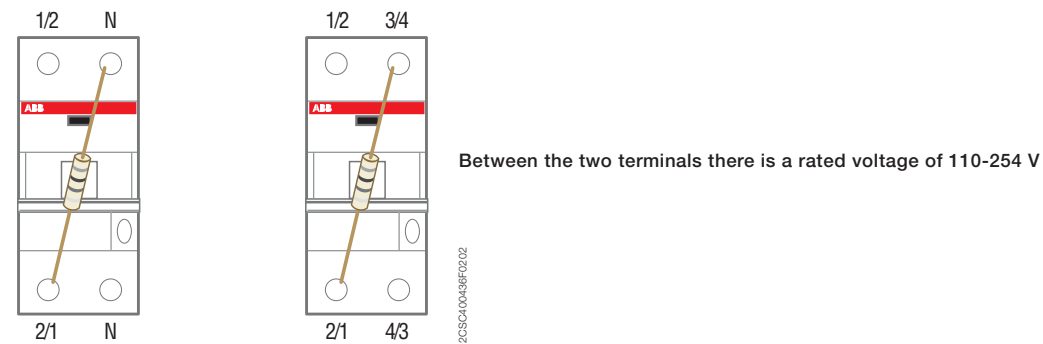

Maximum and minimum operating voltage of DS 200 and DDA 200 test button

DDA 202 and DS 202
In = 25-40 A
Ut = 110-254 V

DDA 203 and DS 203
In = 25-40 A
Ut = 195-440 V

DDA 204 and DS 204
In = 25-40 A
Ut = 195-440 V

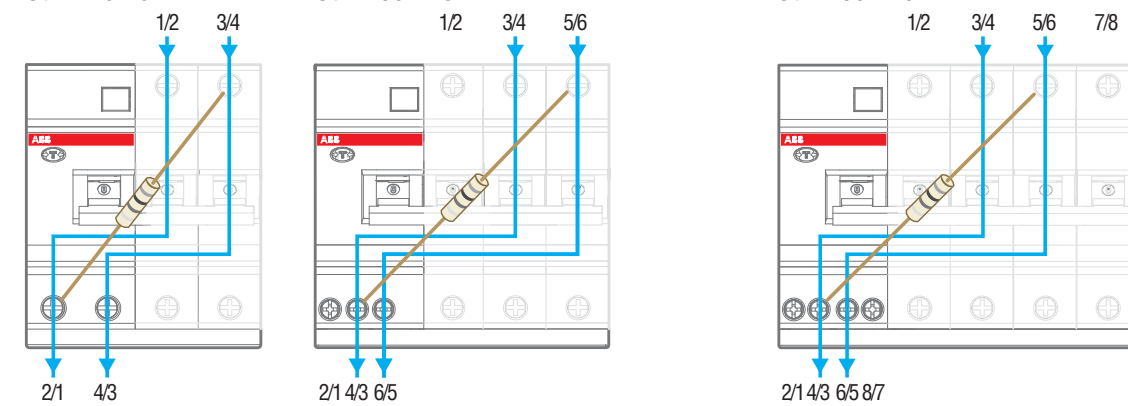

DDA 202 and DS 202
In = 63 A
Ut = 110-254 V

DDA 203 and DS 203
In = 63 A
Ut = 195-440 V

DDA 204 and DS 204
In = 63 A
Ut = 195-440 V

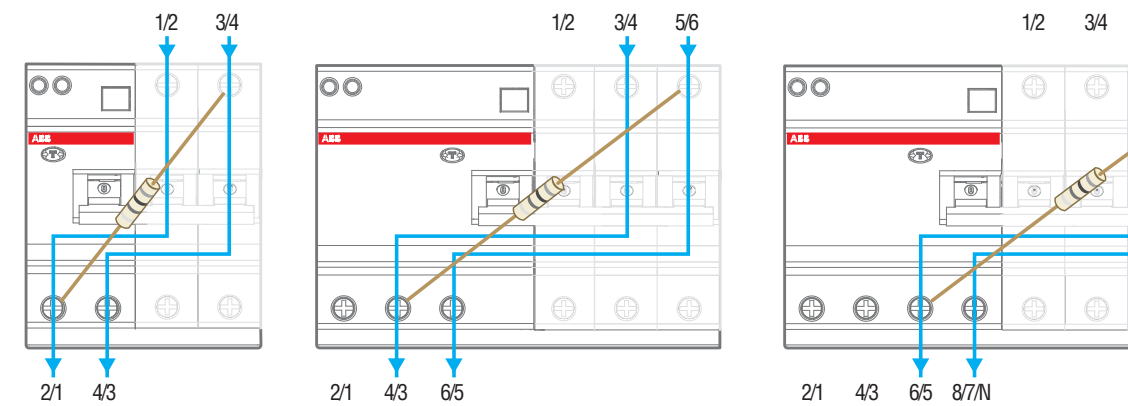

RCDs technical details

Operating voltage of test button

Maximum and minimum operating voltage of DDA 200, special version 110 V

DDA 203 110 V
In = 40 A
Ut = 110-254 V

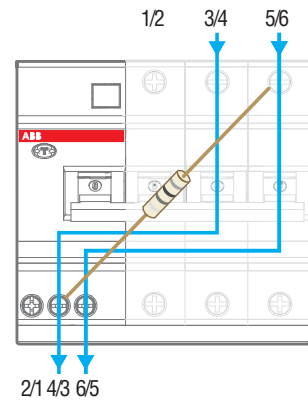

DDA 203 110 V
In = 63 A
Ut = 110-254 V

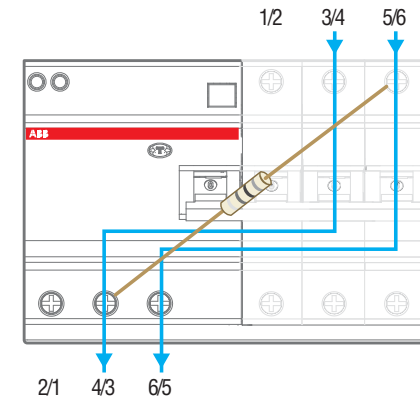

DDA 204 110 V
In = 63 A
Ut = 110-254 V

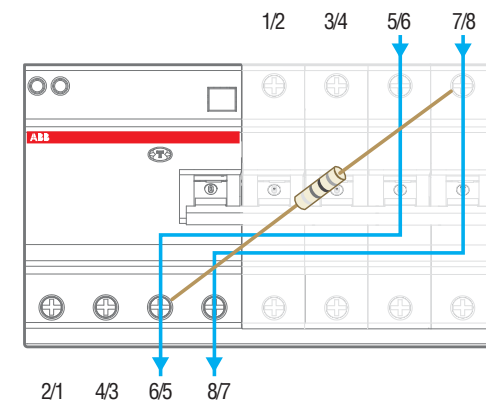

2CSC400437F0002

Maximum and minimum operating voltage of DDA 200, special version 400 V

DDA 202
In = 63 A
Ut = 400 V

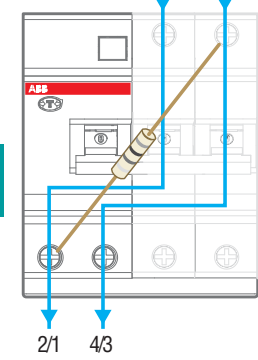

10

Maximum and minimum operating voltage of DDA 200 B type test button

DDA 202 B
In = 63 A
Ut=195-254 V (170-254 V for 30 mA)

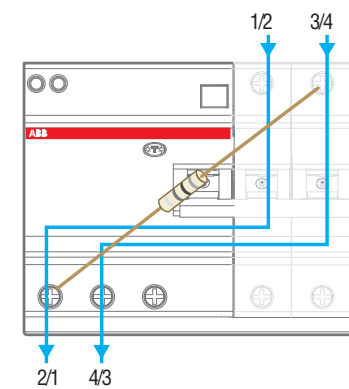

DDA 203 B
In = 63 A
Ut=310-440 V (300-440 V for 30 mA)

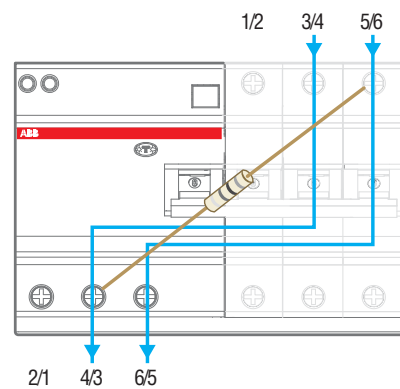

DDA 204 B
In = 63 A
Ut=195-254 V (300-440 V for 30 mA)

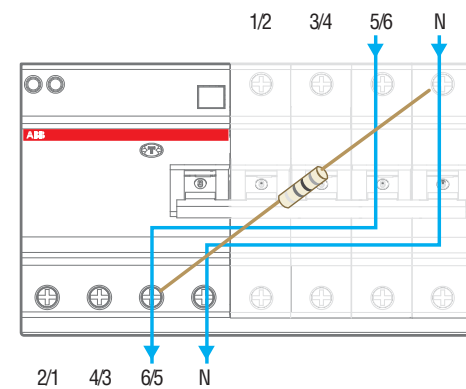

2CSC400438R0202

Maximum and minimum operating voltage of DDA 200 AE test button

DDA 202 AE
In = 63 A
Ut = 184-264 V

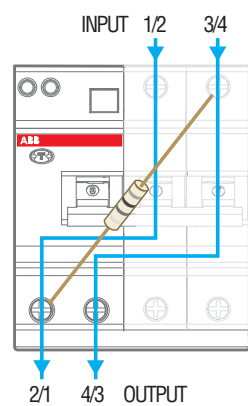

DDA 203 AE
In = 63 A
Ut = 310-440 V

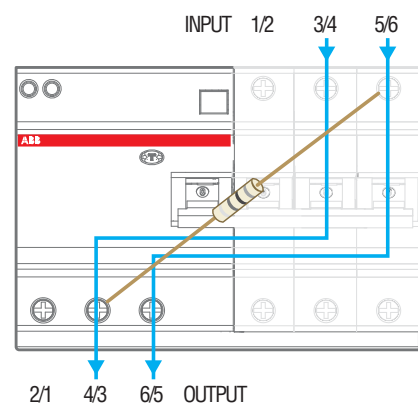

DDA 204 AE
In = 63 A
Ut = 184-264 V

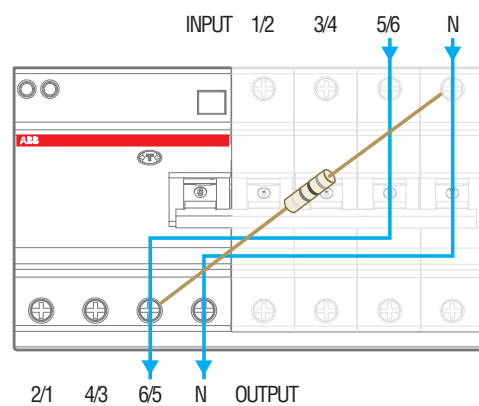

2CSC400438F0202

Maximum and minimum operating voltage of F 200 standard test button

F 202 standard
In = ≤ 100 A
Ut = 110-254 V

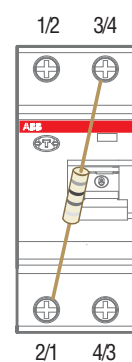

F 204 standard
In = ≤ 100 A
Ut = 110-254 V

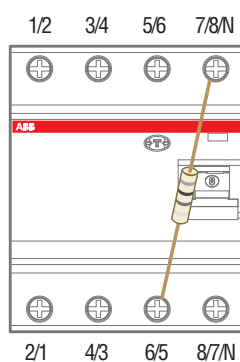

F 204 standard
In = 125 A
Ut = 185-440 V

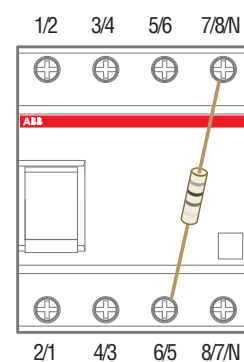

2CSC400438F0202

Maximum and minimum operating voltage of F 200 B and F 200 B (N on the left) type test button

F 204 B
In = ≤ 63 A
Ut = 185-440 V

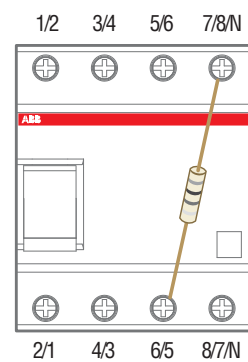

F 204 B
In = 125 A
Ut = 185-440 V

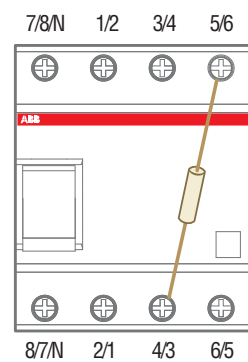

F 202 PV B
In = ≤ 63 A
Ut = 230 V

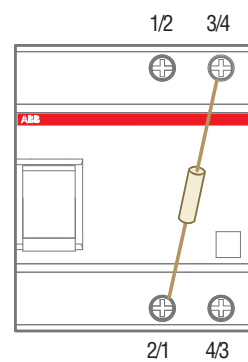

2CSC400438F0202

RCDs technical details

Operating voltage of test button

Maximum and minimum operating voltage of F 200 (N on the left) test button

F 204 neutral on left
 $I_n \leq 100 \text{ A}$
 $U_t = 195\text{-}440 \text{ V}$

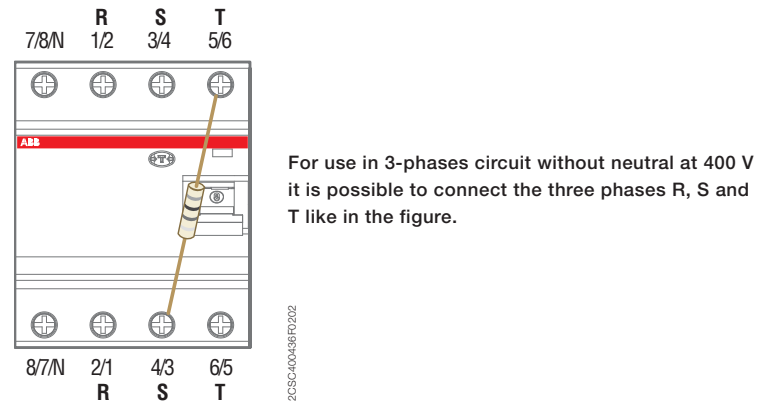

Maximum and minimum operating voltage of DDA 800 and DS800 test button

DDA 802
 DS802
 $I_N \leq 125 \text{ A}$
 $U_t = 195\text{-}690 \text{ V}$

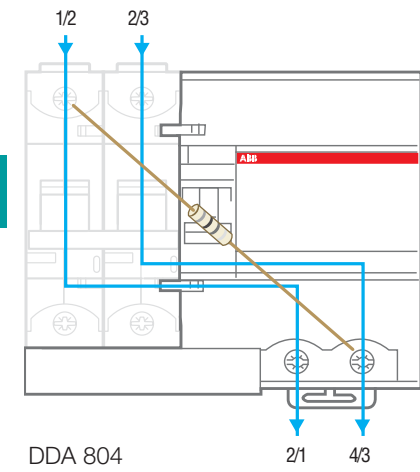

DDA 803
 DS803
 $I_N \leq 125 \text{ A}$
 $U_t = 195\text{-}690 \text{ V}$

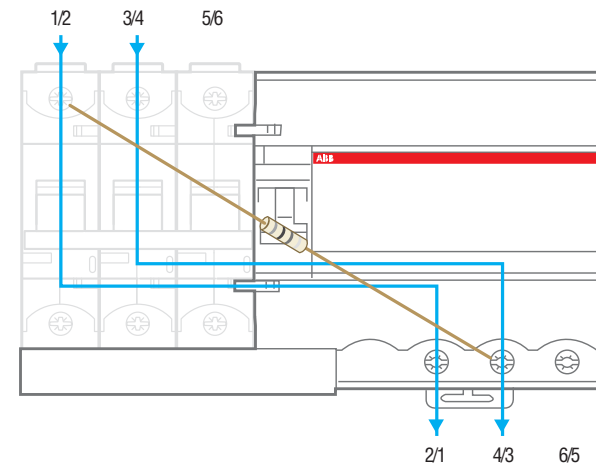

DDA 804
 DS804
 $I_N \leq 125 \text{ A}$
 $U_t = 195\text{-}690 \text{ V}$

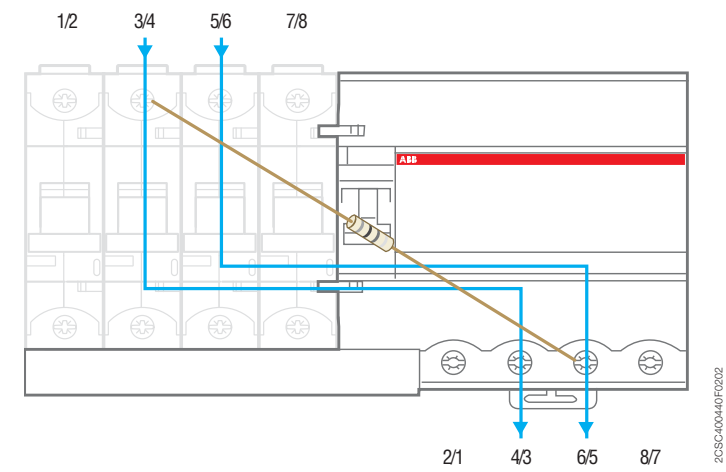

RCDs technical details

RD2 residual current relays

RD2 residual current monitors

They operate combined with appropriate toroidal transformers (in 9 different diameters).

The relay can command the tripping of the protection circuit-breaker release, thus opening the circuit.

According to the IEC 62020 Standard, these relays are "A Type". They are sensitive to leakage sinusoidal currents and to leakage pulsating currents with direct components. Thus they can be defined as "A type".



More technical characteristics

Calibration tolerances		- sensitivity	75% ± 10%
		- time	75% ± 10%
Power consumption	[W]	0.45 at 48 V AC/DC	
		1.2 at 110 V AC/DC	
		3.4 at 230 V AC	
		11 at 400 V AC	
Dielectric test voltage at ind. freq. for 1 min.	[kV]	2.5	
Max. peak current with 8/20 µs wave	[A]	5000	
Installation position		any	
Protection degree		IP20	

RCDs technical details

RD3 residual current relays

RD3 electronic residual current relay

RD3 is a residual current device that in combination with a toroidal transformer is able to detect and evaluate earth fault current. If used in combination with a shunt-trip or undervoltage release, it can realize the opening of a circuit breaker ensuring earth leakage current protection.

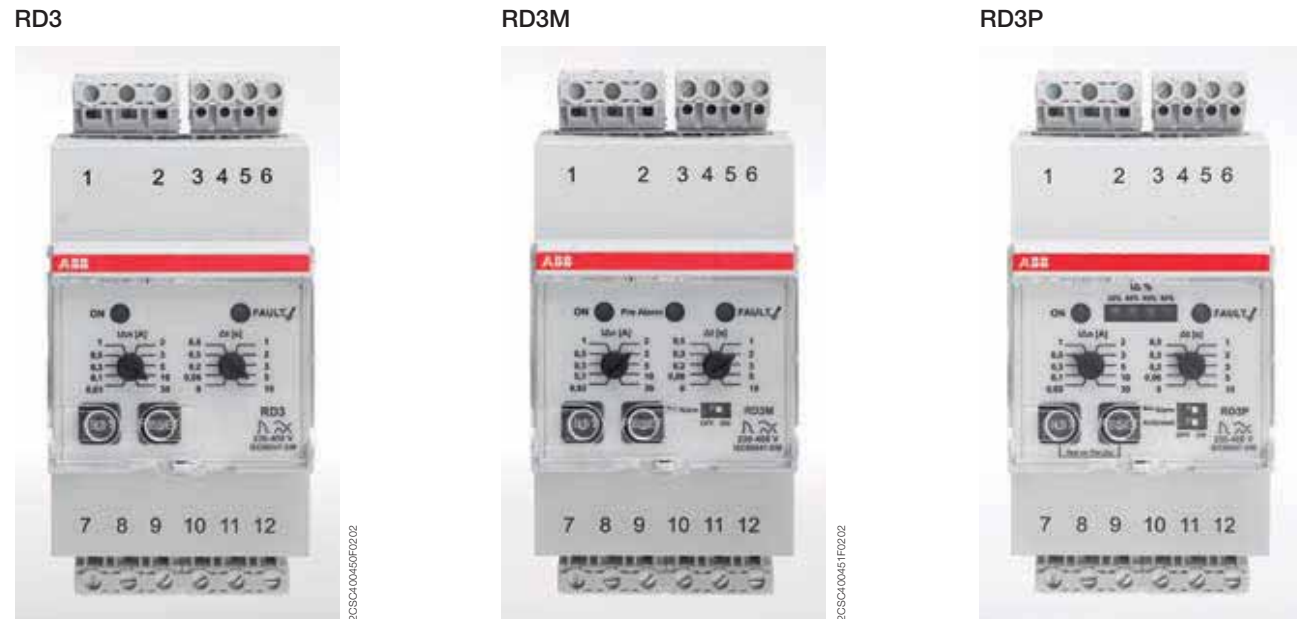

10

Setting of residual operating current and trip time delay.

Using the rotary selectors on the front of the device, it is possible to adjust the residual operating current and the trip time delay.

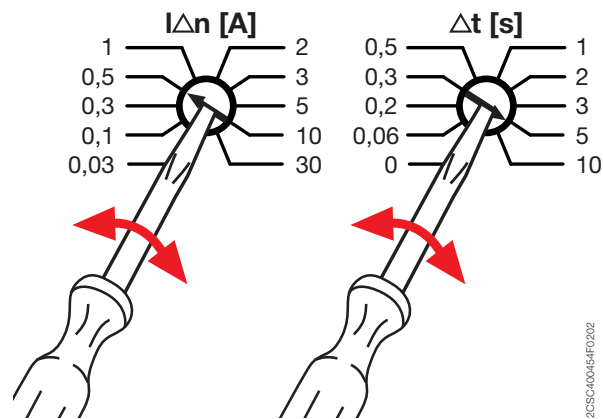

2CSC400465F0202

Adjustment of residual operating current ($I_{\Delta n}$ [A]) and trip time delay (Δt [s]).

Main features

	Pre-alarm Placing the dip-switch in the ON position enables the pre-alarm function: the output contact on terminals 7 8 9 will change state in the event of a residual current exceeding 60% I_{Δ} .	Autoreset Placing the dip-switch in the ON position enables the automatic Reset function: the Relay OUTPUT contacts revert to their original state once the fault condition ceases.	Fail-safe Built into the device (positive safety). In case of absence of supply to the device RD3 the output contact on terminals 10 11 12 will change state as shown in the figures.
RD3			■
RD3M	■		■
RD3P	■	■	■

Indicators



	RD3	RD3M	RD3P
Stand by	ON FAULT	ON Pre Alarm FAULT	ON 1Δ% FAULT
Fault	ON FAULT	ON Pre Alarm FAULT ON Pre Alarm FAULT	ON 1Δ% FAULT
Absent connection with toroid	ON FAULT	ON Pre Alarm FAULT	ON 1Δ% FAULT

RCDs technical details

RD3 residual current relays

Test

To perform the relay test, press the button on the front.

The relay can be reset via the front button or a remote button, as shown in the figure:

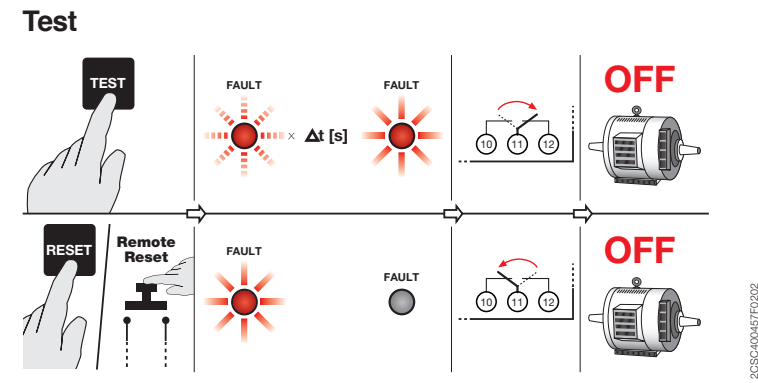

On RD3P version, a no trip test can also be performed by simultaneously pressing the front test and reset buttons for 3 seconds. In this case, the output contacts will not switch, as shown in the figure below:

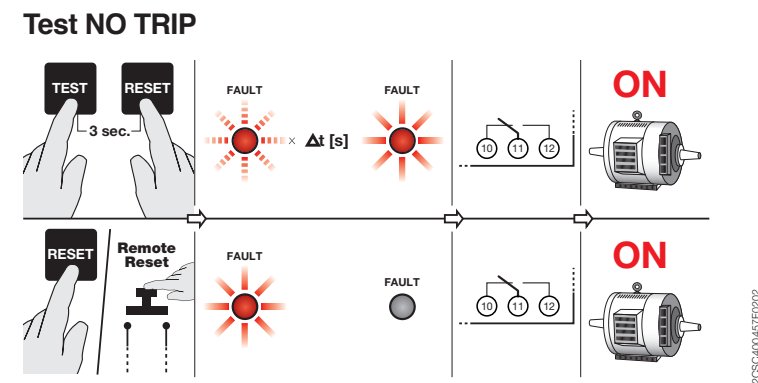

Associated circuit breakers (and relative releasers)

- Tmax range from T1 to T5, In up to 630 A, Ue up to 690 V, with UVR undervoltage release or SOR shunt opening release
- pro M Compact S200 range with In up to 63 A, Ue up to 440 V, with S 2C-A shunt trip or S 2C-UA undervoltage release

Tripping time (RD3 output relay switching time), cumulative time (with associate circuit breakers), non-trip time limit:

RD3: tripping time. cumulative time. non intervention time

Time selection Dt [s]	1 IΔn		2 IΔn			5 IΔn		10 IΔn	
	tripping time ≤ [s]	cumulative time with associate circuit breaker ≤ [s]	non-intervention time [s]	tripping time ≤ [s]	cumulative time with associate circuit breaker ≤ [s]	tripping time ≤ [s]	cumulative time with associate circuit breaker ≤ [s]	tripping time ≤ [s]	cumulative time with associate circuit breaker ≤ [s]
0	0.2	0.3	0.1	0.12	0.15	0.02	0.04	0.02	0.04
0.06	0.3	0.5	0.12	0.17	0.2	0.09	0.15	0.09	0.15
0.2	0.45	0.5	0.3	0.45	0.5	0.45	0.5	0.45	0.5
0.3	0.55	0.6	0.4	0.55	0.6	0.55	0.6	0.55	0.6
0.5	0.6	0.6	0.5	0.6	0.6	0.6	0.6	0.6	0.6
1	1.2	-	1	1.2	-	1.2	-	1.2	-
2	2.2	-	2	2.2	-	2.2	-	2.2	-
3	3.2	-	3	3.2	-	3.2	-	3.2	-
5	5.2	-	5	5.2	-	5.2	-	5.2	-
10	10.2	-	10	10.2	-	10.2	-	10.2	-

RCDs technical details

ELR front panel residual current relays

ELR: tripping time, cumulative time, non intervention time

Time selection Δt [s]	$1 \Delta n$		$2 \Delta n$		$5 \Delta n$		$10 \Delta n$		
	tripping time \leq [s]	cumulative time with associate circuit breaker \leq [s]	non-interventi- on time [s]	tripping time \leq [s]	cumulative time with associate circuit breaker \leq [s]	tripping time \leq [s]	cumulative time with associate circuit breaker \leq [s]	tripping time \leq [s]	cumulative time with associate circuit breaker \leq [s]
0	0.04	0.3	-	0.025	0.15	0.02	0.04	0.02	0.04
0.06	0.1	0.5	0.06	0.08	0.2	0.08	0.15	0.08	0.15
0.2	0.16 +15%	-	0.2	0.15 +15%	-	0.15 +15%	-	0.15 +15%	-
0.3	0.3 +15%	-	0.3	0.3 +15%	-	0.3 +15%	-	0.3 +15%	-
0.5	0.5 +15%	-	0.5	0.5 +15%	-	0.5 +15%	-	0.5 +15%	-
1	1 +15%	-	1	1 +15%	-	1 +15%	-	1 +15%	-
2	2 +15%	-	2	2 +15%	-	2 +15%	-	2 +15%	-
3	3 +15%	-	3	3 +15%	-	3 +15%	-	3 +15%	-
5	5 +15%	-	5	5 +15%	-	5 +15%	-	5 +15%	-

RCDs technical details

Toroidal transformers

Toroidal transformers

The choice of toroidal transformers is made according to the useful diameter and the minimum value of the leakage current to be detected.

Toroidal transformers selection for use with ELR according to IEC/ EN 60947-2 Annex M in combination with MCBs S200 range and MCCBs Tmax range up to T5

Type	Toroid useful diameter [mm]	Max rated current [A]	Min measurable current [mA]
TRM	29	65	30
TR1	35	75	30
TR2	60	85	30
TR3	80	160	100
TR4	110	250	100
TR4/A	110	250	300
TR160	160	400	300
TR160/A	160	400	500
TR5	210	630	300
TR5/A	210	630	500

Technical features of the toroidal transformers

Type	Toroid useful diameter [mm]	Min measurable current [mA]	Maximum capacity [A]
TRM	29	30	160
TR1	35	30	250
TR2	60	30	400
TR3	80	100	800
TR4	110	100	1250
TR4/A	110	300	1250
TR160	160	300	2000
TR160/A	160	500	2000
TR5	210	300	3200
TR5/A	210	500	3200

RCDs technical details

Toroidal transformers

More technical characteristics

		TRM	TR1	TR2	TR3	TR4	TR4A	TR160	TR160A	TR5	TR5A
Core		closed	closed	closed	closed	closed	open	closed	open	closed	open
Available internal diameter	[mm]	29	35	60	80	110	110	160	160	210	210
Weight	[kg]	0.17	0.22	0.28	0.45	0.52	0.6	1.35	1.6	1.45	1.85
Minimum measurable current	[mA]	30	30	30	100	100	300	300	500	300	500
Installation position		Any									
Operating temperature	[°C]	-10...+70									
Storage temperature	[°C]	-20...+80									
Transformation ratio		500/1									
Dielectric test voltage at industrial freq. for 1 min.	[kV]	2.5									
Max. insulating voltage	[V a.c.]	1000									
Max. thermal overload	[kA]	40/1 sec.									
Connections		Screw terminal boards, max. section 2.5 mm ²									
Protection degree		IP20									

Generality

They must be mounted with residual current monitors upstream the lines or loads to be protected; all active conductors (phases and neutral) of single-phase as well as of three-phases lines must pass through them.

In this way these devices perform the vector sum of line currents detecting the possible homopolar differential currents that leak to earth: their core of sheet iron has high magnetic properties that allow to detect even very low leakage currents. The choice of a toroidal transformer depends on the conductor or on the bar to be used.

It is suggested to use the open versions in case of revamping or upgrading of an existing installation.

Installation

All active conductors can be introduced in the toroidal transformers without the need of respecting any specific sense of introduction (P1-P2 or P2-P1). The output signal must be

picked up from terminals 1 (S1) and 2 (S2) and connected to the residual current monitor, while terminals 3 and 4 must be connected to the test output of those relays of FPP range with this function. With RD2 they must remain disconnected. For this connection it is better to use twisted or shielded cables, possibly far from busbars. The minimum recommended section of connection cables should have a maximum resistance of 3 Ω; anyway consider a maximum length of connection of 20 m for 0.5 mm² and of 100 m for 2.5 mm².

For versions with openable core it is necessary to control that the contact surface of the two semi-cores is clean, that bolts are tight and that connection cables connections on both sides are intact.

Connection cables with metallic shielding or armor must be earthed downstream the toroidal transformer; if they run within the transformer they must be earthed in the opposite direction.

Accessories for MCBs and RCDs Busbars

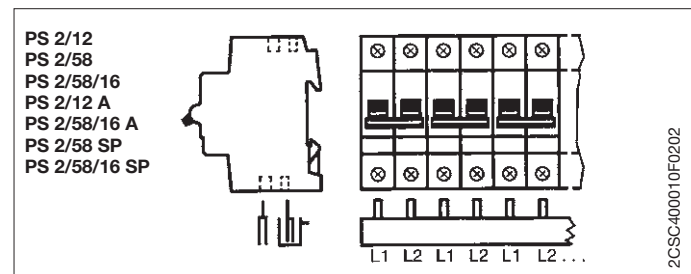
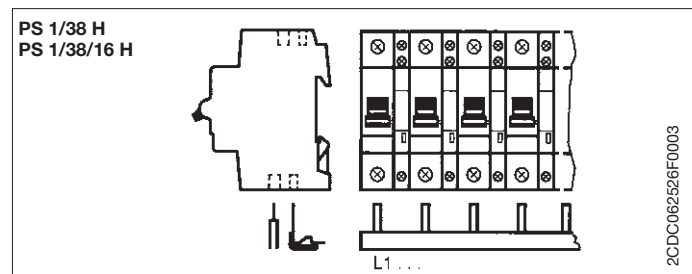
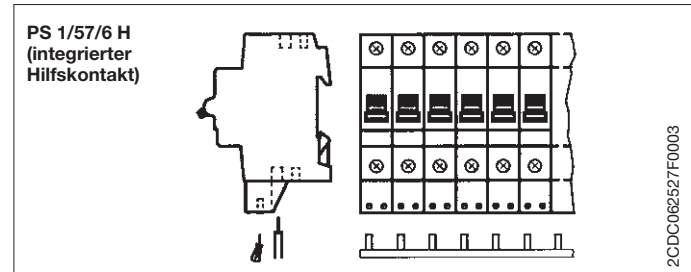
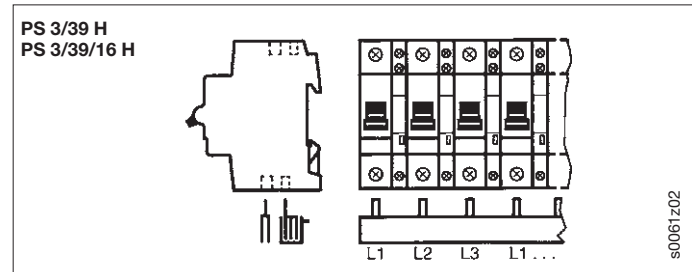
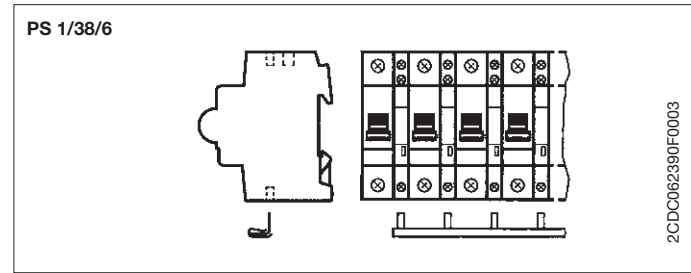
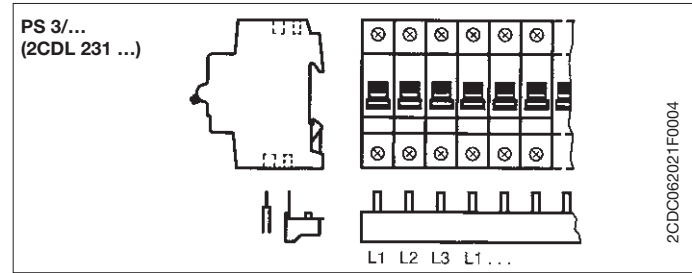
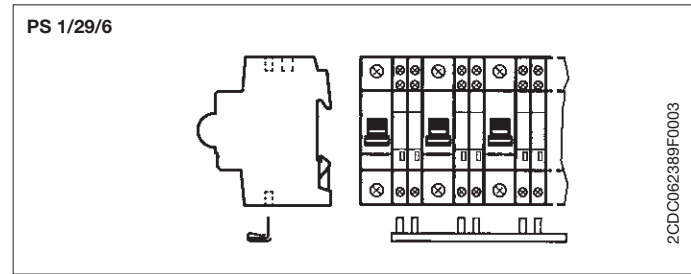
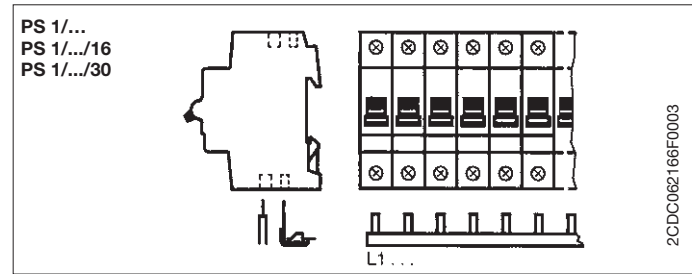

10

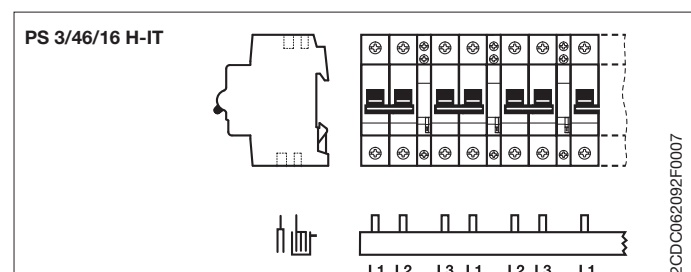
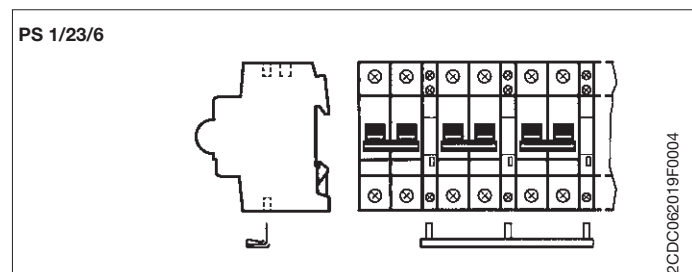
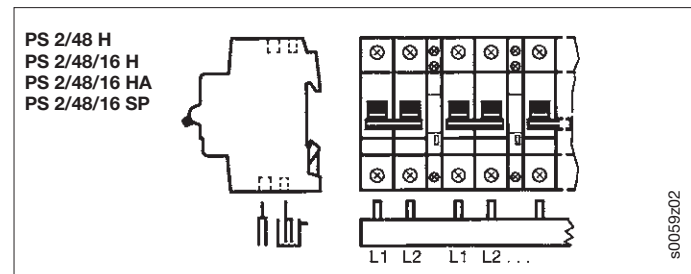
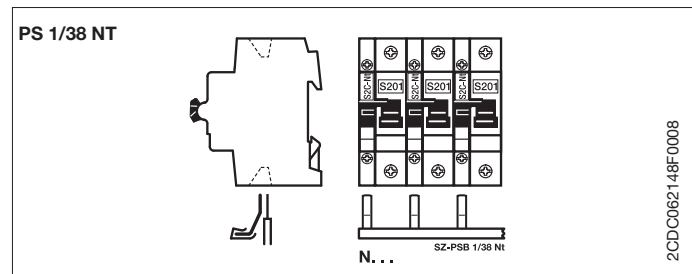

Accessories for MCBs and RCDs Busbars

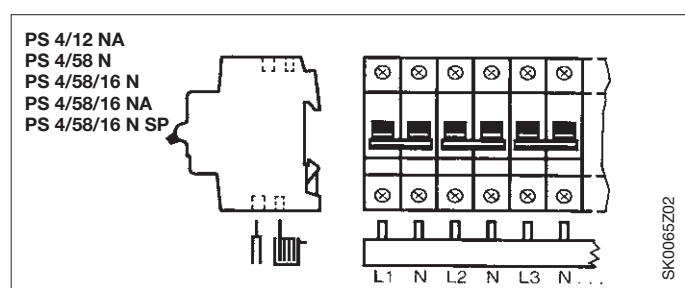
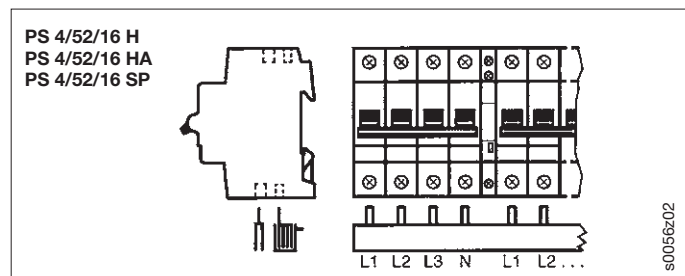
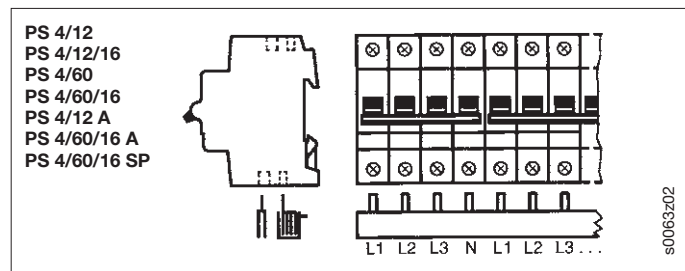
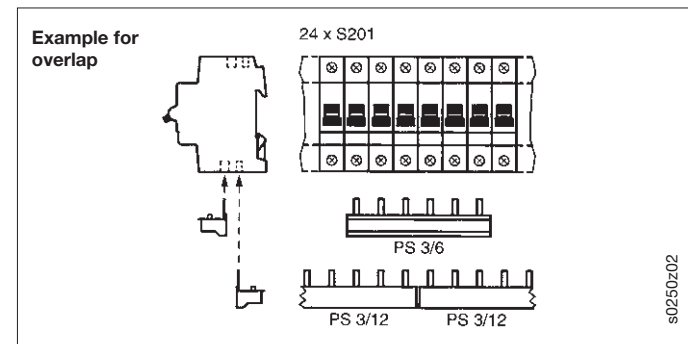
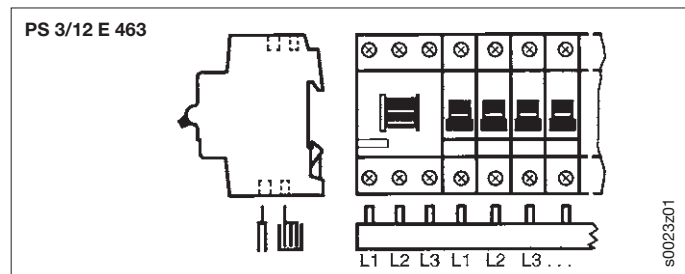
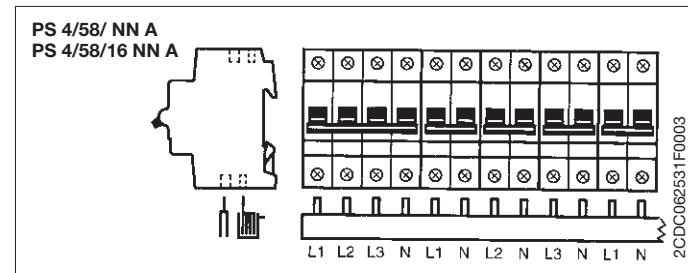
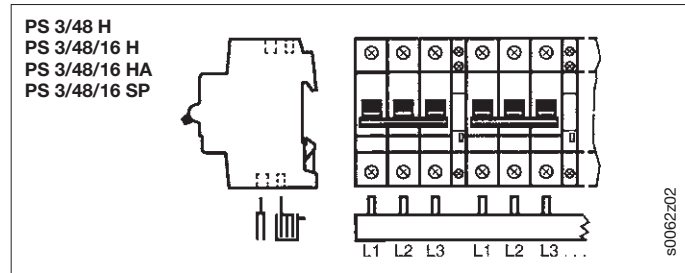
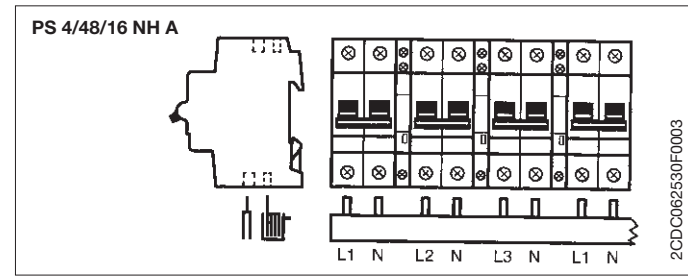
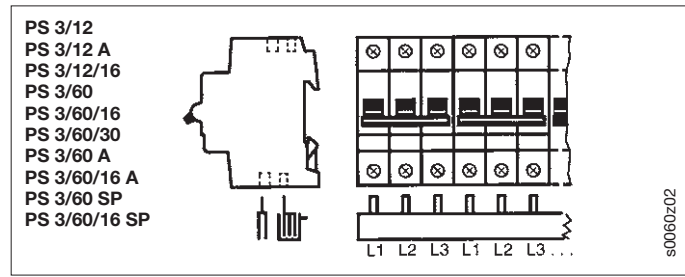

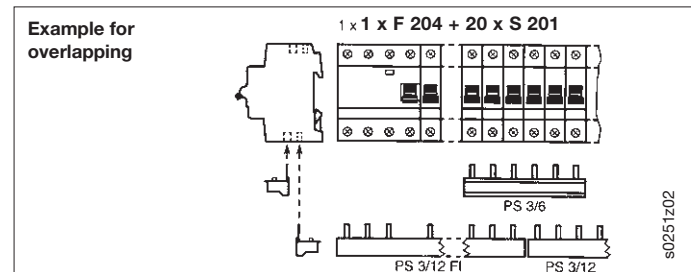
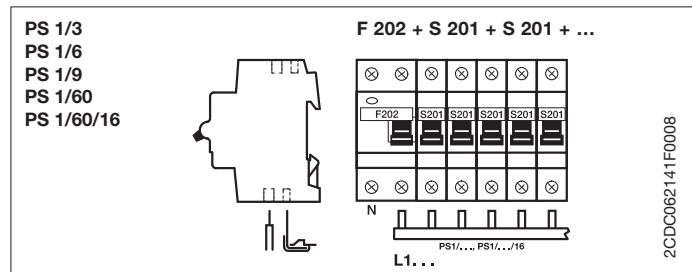
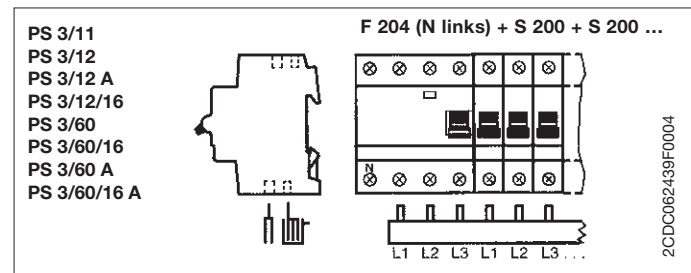
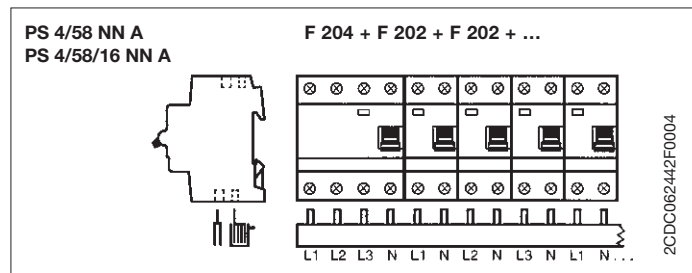
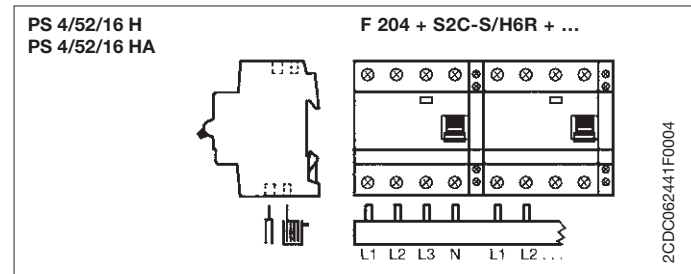
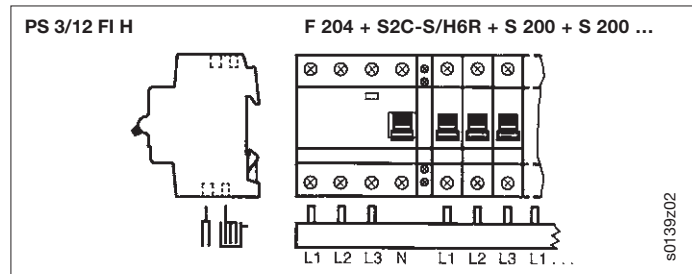
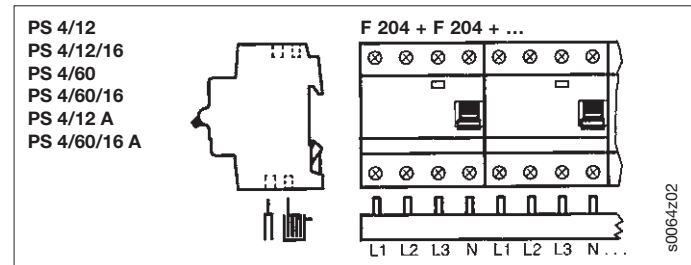
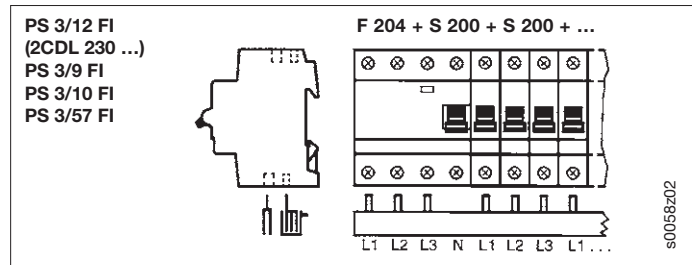
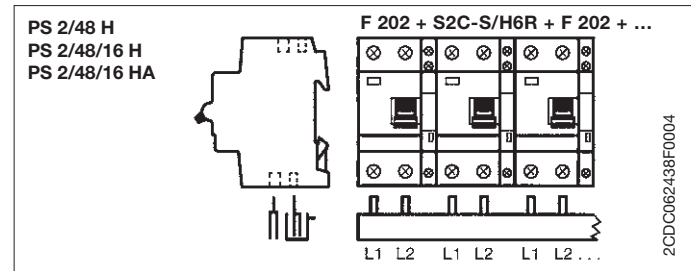
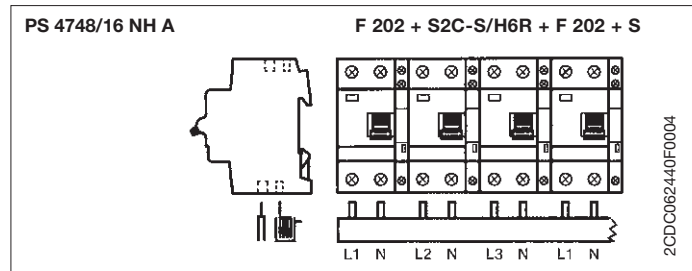
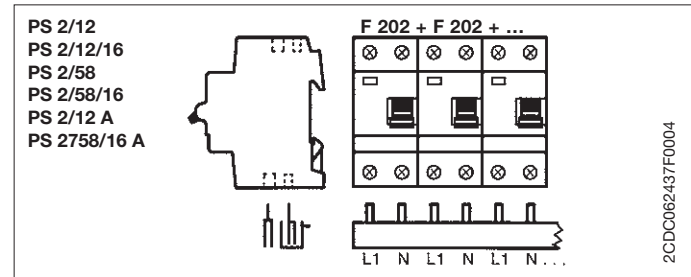
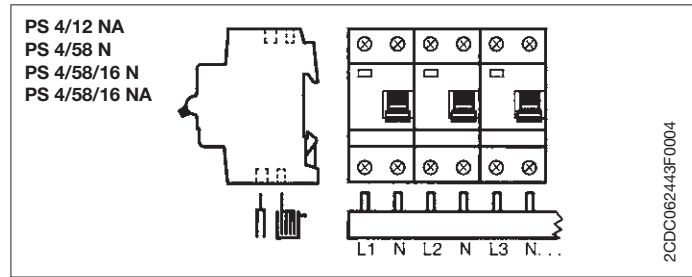

Accessories for MCBs and RCDs Busbars

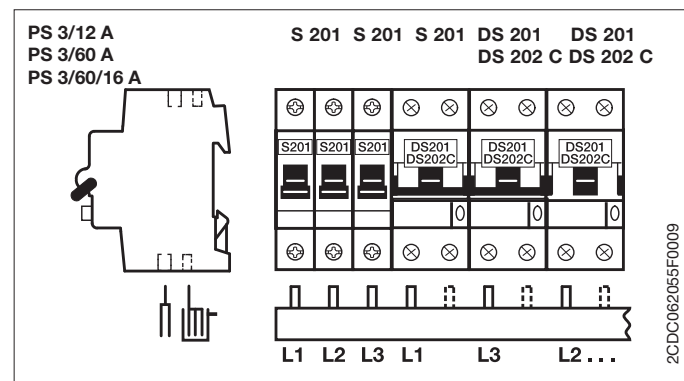
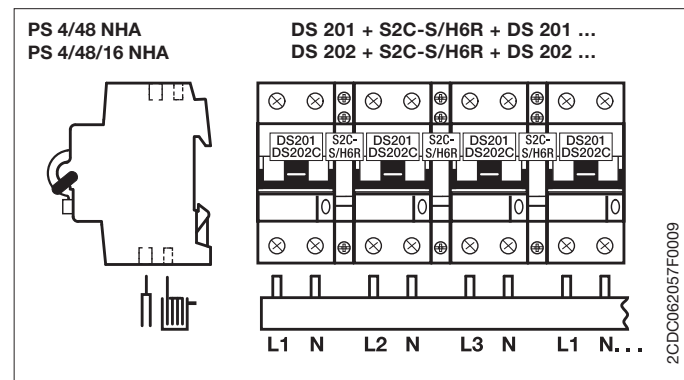
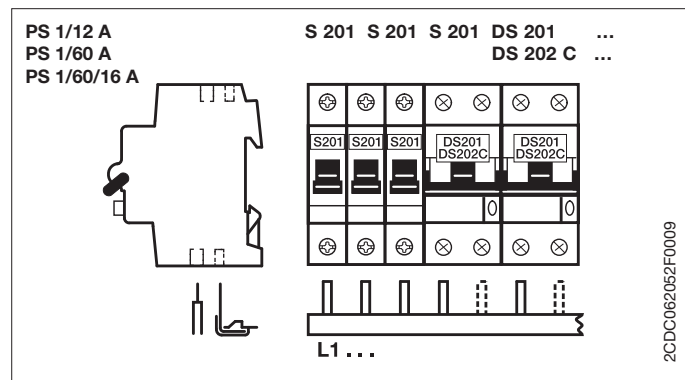
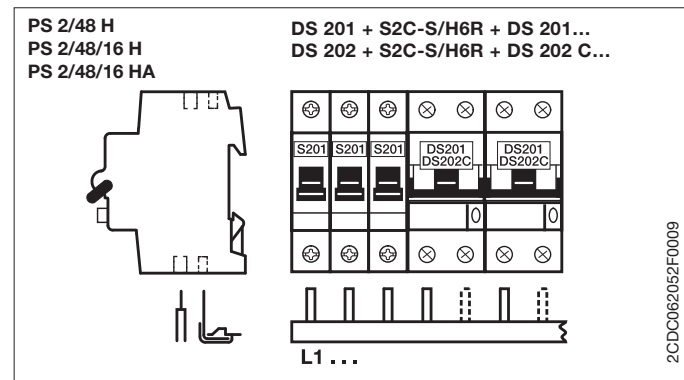
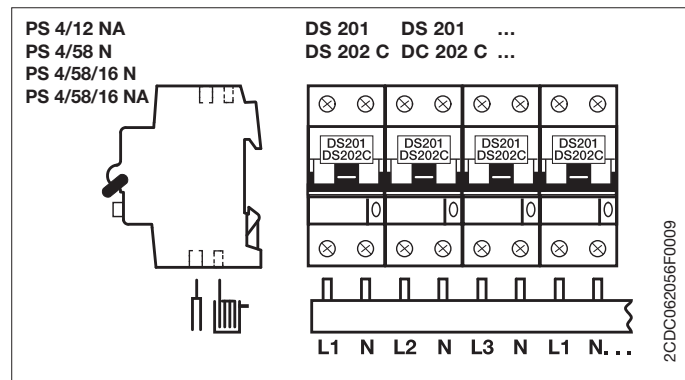
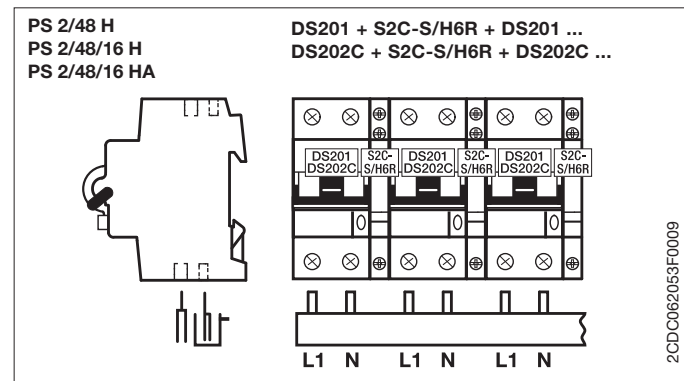
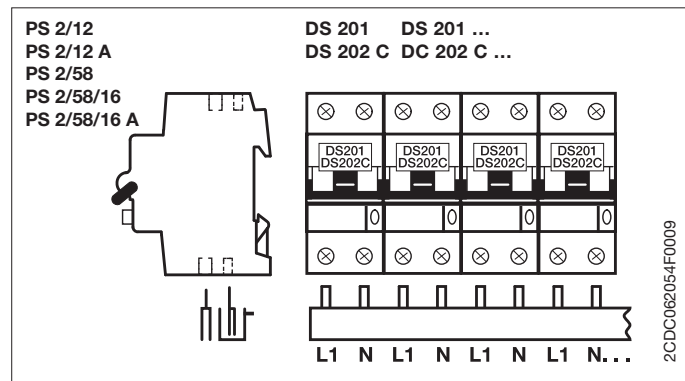

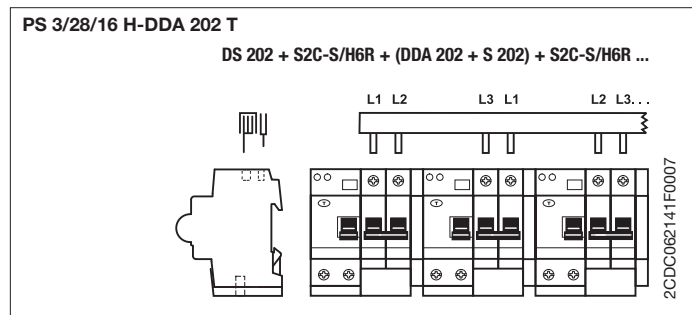
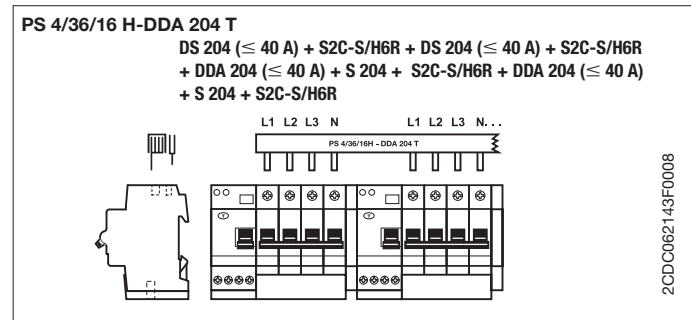
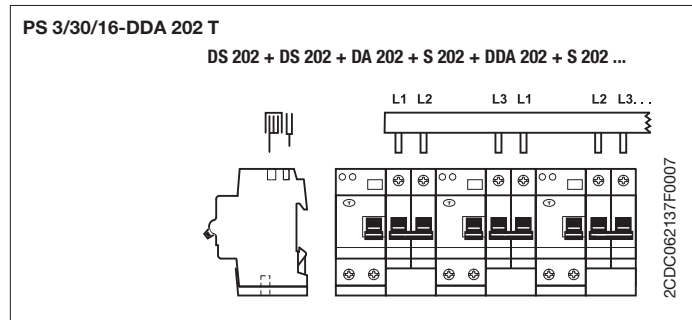
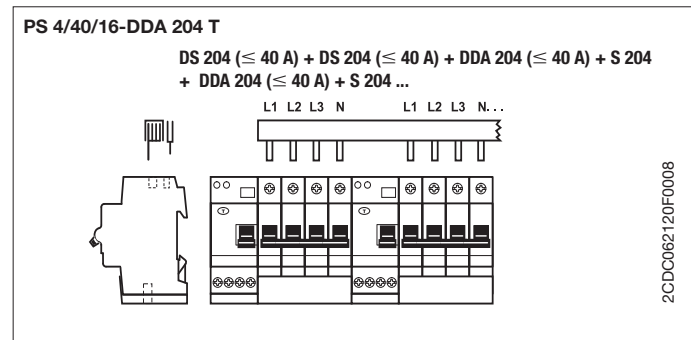
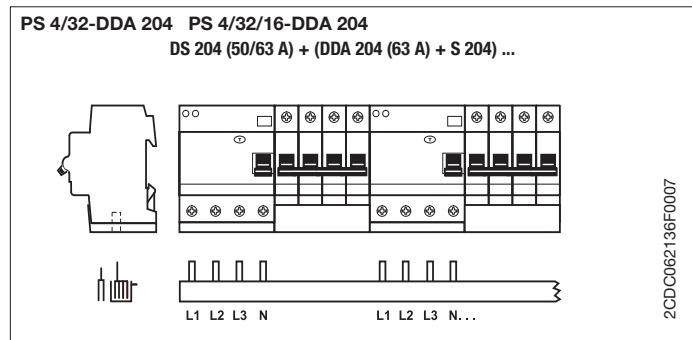
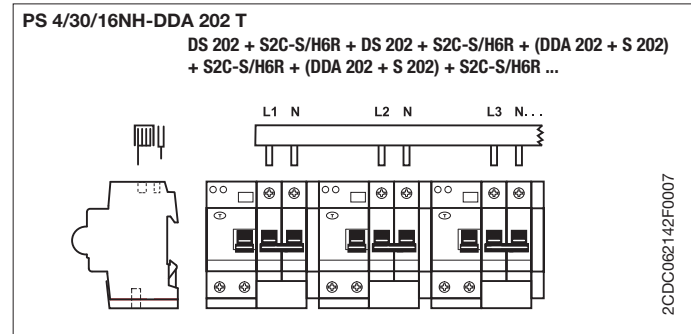
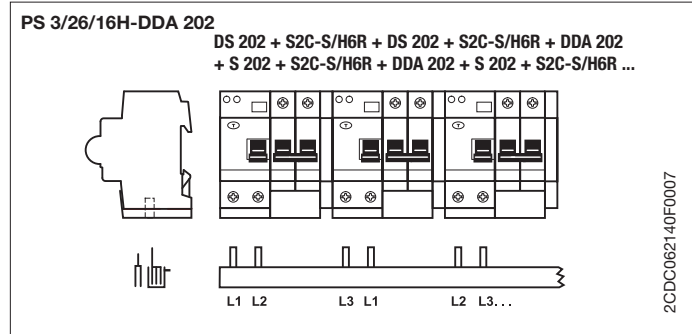
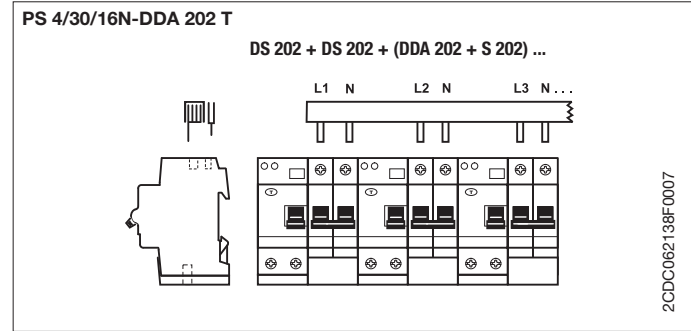
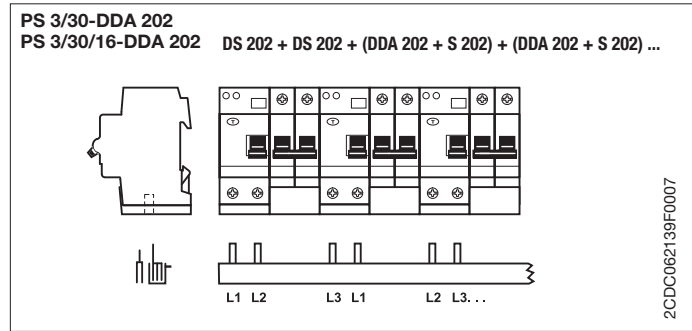

Protection and safety technical details

OVR Surge Protective Devices

Selection of surge protective devices

The IEC standard introduced the concept of lightning protection zones (LPZ) to help in selecting the correct surge protection. This concept ensure the gradual reduction by stages of the energies and overvoltage caused by lightning or switching operations. This logic of coordination in the protection is what we call the “stepping protection”.

External Zones:

- LPZ 0A Unprotected zone outside the building subject to direct lightning strikes and therefore may have to handle to the full lightning current and lightning electromagnetic field.
- LPZ 0B Zone protected against direct lightning strikes by external air terminal and where the threat is the full lightning electromagnetic field.

Internal Zones:

Zones inside the building which are protected against direct lightning flashes.

- LPZ 1 Zone subject to partial lightning or surge currents. Type I SPDs shall be installed at the boundary between LPZ 0A and LPZ 1 to reduce the entrance of lightning currents through power lines.
- LPZ 2...n Zone where the surge energy is limited by current sharing and where the surge energy is reduced by additional surge protection like SPDs. Type 2 SPDs are installed at the boundaries of each zone, i.e. LPZ 1 and LPZ 2, LPZ 2 and LPZ 3, etc.

Lightning protection zones description (IEC 62305-4):

It consists in dividing a building in several volumes: the protection zone. The objective is to ensure that the LPZ gives enough protection to the equipment inside this zone. To do so, SPDs are installed at the protection zone boundaries. Each time an SPD is installed, a new protection zone is created.

Current impulse:

The 10/350 and 8/20 impulse waves are used in the Class I and Class II SPDs tests. The first number gives the rising time of the current impulse to reach 90% of the peak level and the second number gives the time to half value in micro-seconds (μ s).

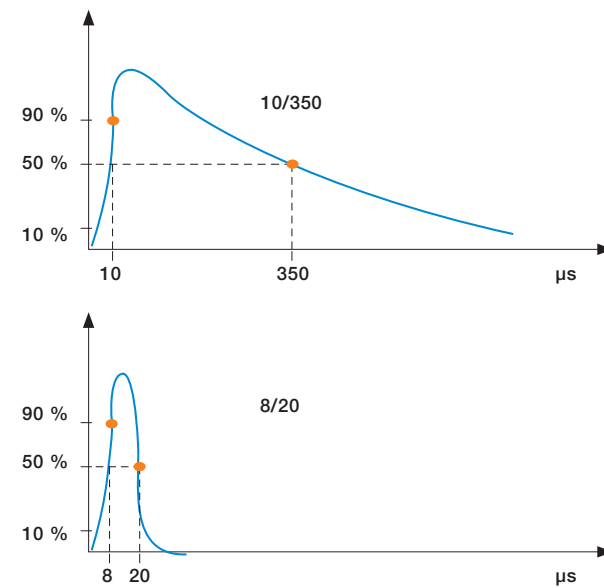

External lightning protection system

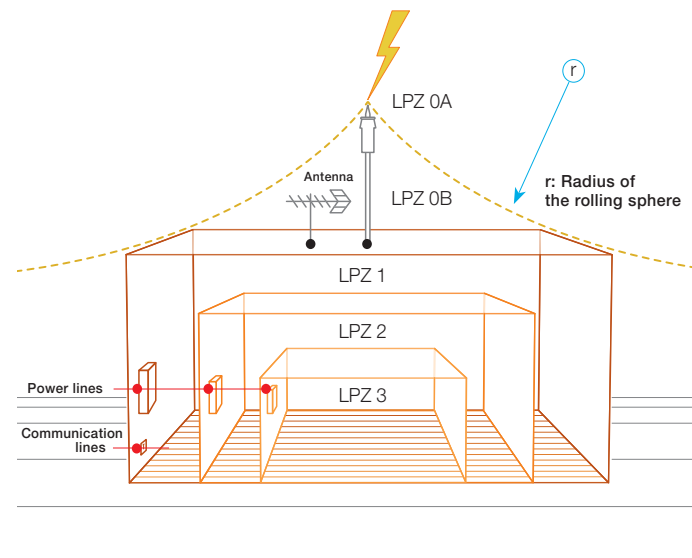

Mode of surge protection

Protection in common and/or differential mode

Common mode

Overvoltages in common mode concern all neutral point connections. They occur between the live conductors and earth (e.g. phase/earth or neutral/earth). The neutral conductor is a live cable, as well as the phase conductors.

This overvoltage mode destroys not only earthed equipment (Class I), but also non-earthed equipment (Class II) with insufficient electrical insulation (a few kilovolts) located close to an earthed mass.

Class II equipment that is not situated close to an earthed mass is theoretically protected from this type of attack.

Differential mode

Overvoltages in differential mode circulate between the live phase/phase or phase/neutral conductors. They can cause considerable damage to any equipment connected to the electrical network, particularly "sensitive" equipment.

These overvoltages concern TT earthing systems. They also affect TN-S systems if there is a significant difference in length between the neutral cable and the protective cable (PE).

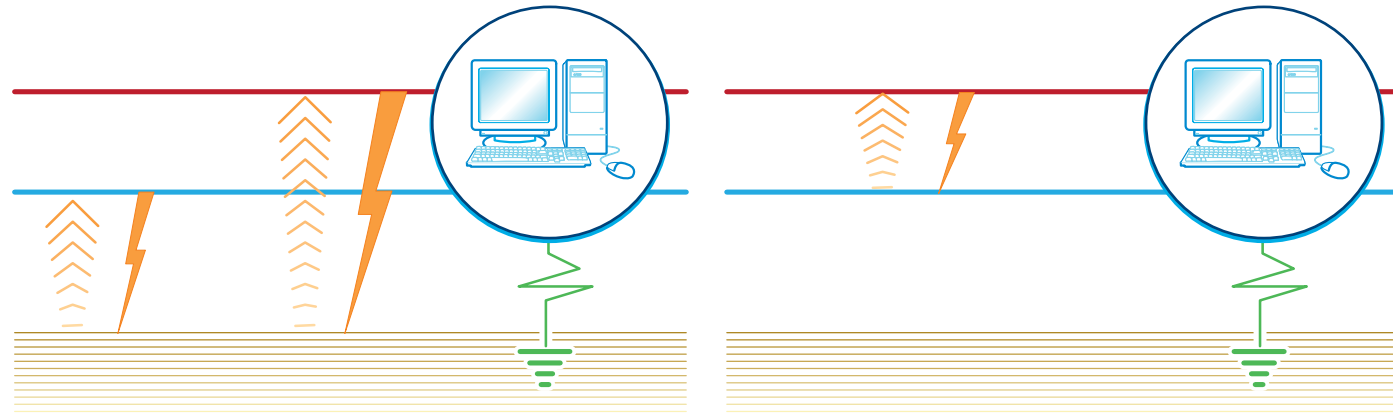

Overvoltages in common mode

Overvoltages in differential mode

10

Different types of OVR configuration

Either Common mode or differential mode of protection are required depending on the system configuration (IT, TNC, TNS, TT). For that purpose, you can find different OVR configuration (single pole, 3L, 4L, 1N, 3N).

Common mode configurations (TNC networks)



Common and differential mode configurations (TNS, TT networks)

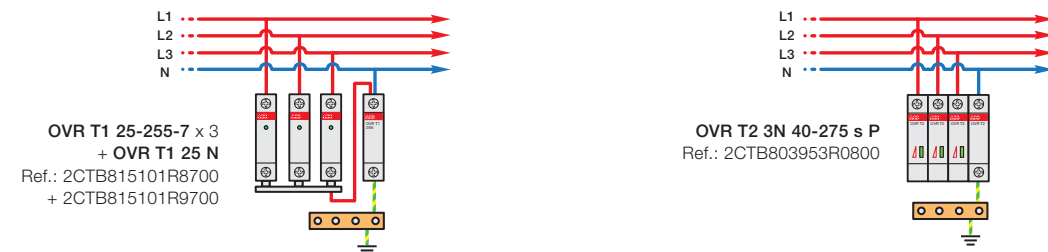

Protection and safety technical details

OVR Surge Protective Devices

Coordination and wiring principals

The SPD installed at the line entrance of an installation may not ensure an effective protection to the whole system. As a matter of fact, the selection of the voltage protection level (U_p) of SPDs depends on many parameters: Type of equipment to be protected, the length of the connections to the SPDs, the length in between the SPDs and the equipment to be protected.

Coordination required if :

The protection level (U_p) of the SPDs is not low enough to protect the equipment.
If the distance in between the SPDs and the equipment is >10 m.

NOTE:

The first SPD is diverting most of the surge current to the ground, and the second SPD will ensure a good protection level to the equipment.

It is what we call the stepping protection.

Coordination between Type 1 and Type 2 surge protective device

Type 1
25 kA (10/350)
 $I_n = 50$ kA

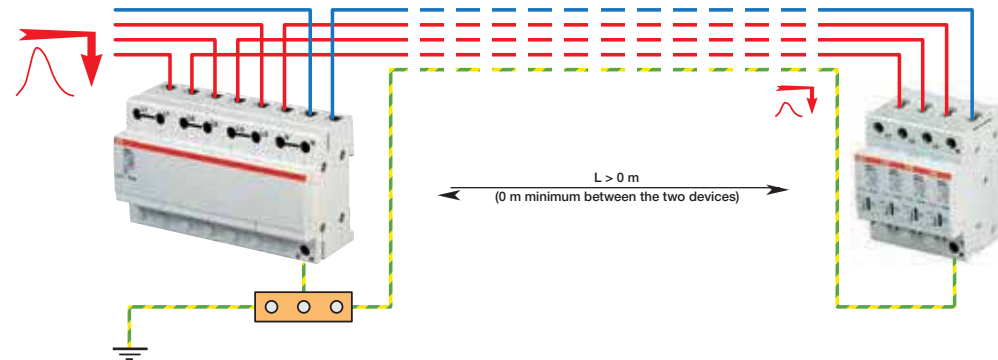

Type 2
40 kA (8/20)

10
Type 1
25 kA (10/350)
 $I_n = 7$ kA

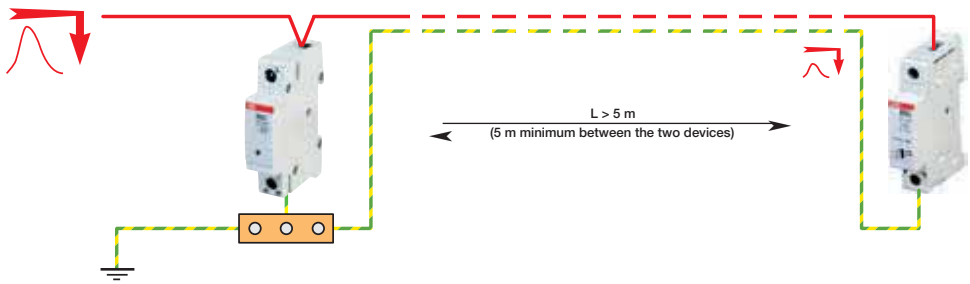

Type 2
40 kA (8/20)

Coordination between Type 2 surge protective devices

Type 2
70 kA (8/20)

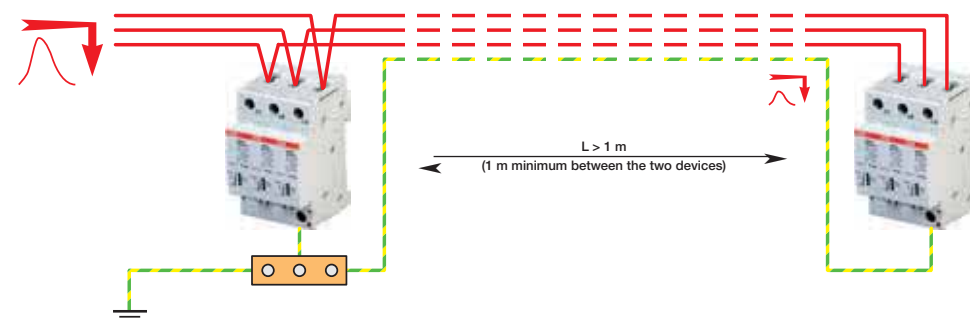

Type 2
40 kA (8/20)

Surge protective device disconnectors - Choice of backup protection

Surge protective device must have disconnectors which are internal and external. Internal is the so called thermal disconnection which helps to disconnect the SPD at the end of life (varistors technology). External is the backup protection which can be an MCB or a fuse dedicated to the SPD protection in case of short circuit due to very high surge transient current for example.



Designation	Function
Protection against indirect contact	Residual current devices (RCDs) assure a protection to people and installation. When installed with SPDs they must be of selective type "S" to avoid nuisance tripping. In ABB portfolio you can choose the F200 S type range for a safer installation.
Protection against fault currents	Miniature circuit breakers (MCBs) or fuses protect the installation against overload and short circuit. They can be associated with SPDs for the backup protection in agreement with coordination installation rules. You can either choose MCBs from the S200 or S800 series or fuses from the E90 range.
Thermal protection	The thermal disconnection is an internal disconnection which is there to bring a safer protection to the equipment. ABB is always developing new patents and has developed a thermal disconnection mechanism specifically dedicated to PV installation with the OVR PV range for a better and safer protection.

Type of Surge Protective Devices	System earthing	Circuit breaker maximum ratings * curve B or C Prospective short circuit current at SPD location (I _p)				Fuses maximum ratings* (gL - gG)
		I _p ≤ 6 kA	I _p ≤ 10 kA	I _p ≤ 25 kA	I _p ≤ 50 kA	
Type 1						
OVR T1	TNC	—	—	—	S803S - 125	E 933/125 - 125 A
I _{imp} 25 kA / I _{fi} ≤ 50 kA	TNS/TT 1Ph+N	—	—	—	S802S - 125	E 931N/125 - 125 A
U _c 255 and 440 V	TNS/TT 3Ph+N	—	—	—	S804S - 125	E 933N/125 - 125 A
Type 1+2						
OVR T1+2	TNC	—	—	—	S803S - 125	E 933/125 - 125 A
I _{imp} 25 kA / I _{fi} ≤ 15 kA	TNS/TT 1Ph+N	—	—	—	S802S - 125	E 931N/125 - 125 A
U _c 255 V	TNS/TT 3Ph+N	—	—	—	S804S - 125	E 933N/125 - 125 A
OVR T1+2	TNC	—	—	—	S803S - 125	E 933/125 - 125 A
I _{imp} 15 kA / I _{fi} ≤ 7 kA	TNS/TT 1Ph+N	—	—	—	S802S - 125	E 931N/125 - 125 A
U _c 255 V	TNS/TT 3Ph+N	—	—	—	S804S - 125	E 933N/125 - 125 A
OVR T1+2	TNC	S203 - 50	S203 M - 50	S203 P - 50	S803S - 50	E 933/50 - 50 A
I _{imp} 7 kA	TNS/TT 1Ph+N	S201 - 50 NA	S201 M - 50 NA	S201 P - 50 NA	S802S - 50	E 931N/50 - 50 A
U _c 275 V	TNS/TT 3Ph+N	S203 - 50 NA	S203 M - 50 NA	S203 P - 50 NA	S804S - 50	E 933N/50 - 50 A
OVR HL	TNC	S203 - 50	S203 M - 50	S203 P - 50	S803S - 50	E 933/50 - 50 A
I _{imp} 15 kA	TNS/TT 1Ph+N	S201 - 50 NA	S201 M - 50 NA	S201 P - 50 NA	S802S - 50	E 931N/50 - 50 A
U _c 440 V	TNS/TT 3Ph+N	S203 - 50 NA	S203 M - 50 NA	S203 P - 50 NA	S804S - 50	E 933N/50 - 50 A
Type 2						
OVR T2 pluggable	TNC	S203 - 16	S203 M - 16	—	—	E 93/32 - 16 A
I _{max} 15 kA	TNS/TT 1Ph+N	S201 - 16 NA	S201 M - 16 NA	—	—	E 91N/32 - 16 A
U _c 75 V	TNS/TT 3Ph+N	S203 - 16 NA	S203 M - 16 NA	—	—	E 93N/32 - 16 A
OVR T2 pluggable	TNC	S203 - 50	S203 M - 50	S203 P - 50	S803S - 50	E 933/50 - 50 A
I _{max} 15, 40 and 70 kA	TNS/TT 1Ph+N	S201 - 50 NA	S201 M - 50 NA	S201 P - 50 NA	S802S - 50	E 931N/50 - 50 A
U _c 275 and 440 V	TNS/TT 3Ph+N	S203 - 50 NA	S203 M - 50 NA	S203 P - 50 NA	S804S - 50	E 933N/50 - 50 A
OVR T2 non-pluggable	TNC	S203 - 63	S203 M - 63	S203 P - 63	S803S - 63	E 933/125 - 125 A
I _{max} 20 and 40 kA	TNS/TT 1Ph+N	S201 - 63 NA	S201 M - 63 NA	S201 P - 63 NA	S802S - 63	E 931N/125 - 125 A
U _c 150 V, 275 and 440 V	TNS/TT 3Ph+N	S203 - 63 NA	S203 M - 63 NA	S203 P - 63 NA	S804S - 63	E 933N/125 - 125 A
Type 3						
OVR T3	TNC	S203 - 10	S203 M - 10	—	—	E 93/32 - 25 A
I _{max} 10 kA	TNS/TT 1Ph+N	S201 - 10 NA	S201 M - 10 NA	—	—	E 91N/32 - 25 A
U _c 275 V	TNS/TT 3Ph+N	S203 - 10 NA	S203 M - 10 NA	—	—	E 93N/32 - 25 A

* Maximum ratings, must be in accordance with the installation to follow coordination rules with main or upstream short circuit protection(s).

Service entrance SPDs	PE connection cable size
Type 1	16 mm ²
Type 2	4 mm ²

Protection and safety technical details

OVR Surge Protective Devices

Selection tool: TNC-S network 230/400 V
Industry, commercial building

Configuration 1
 $15 \text{ kA} \leq I_p \leq 50 \text{ kA}$

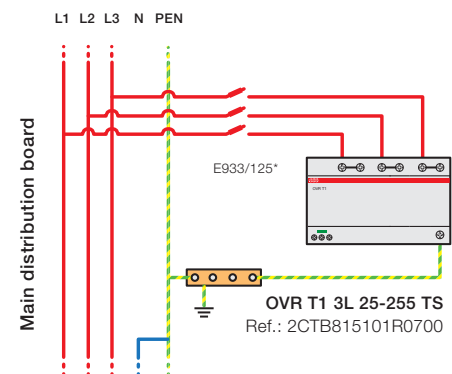

> 10 meters cable

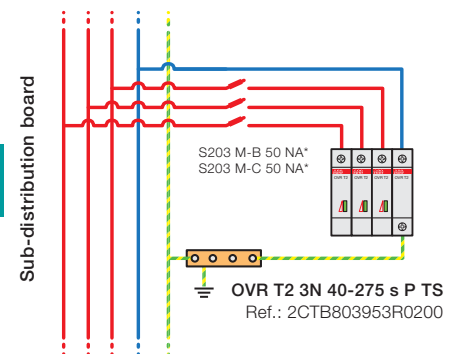

> 10 meters cable

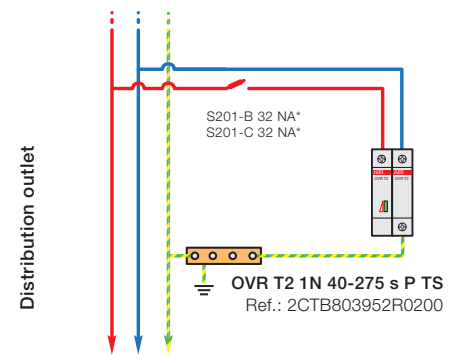

Configuration 2
 $7 \text{ kA} \leq I_p \leq 15 \text{ kA}$

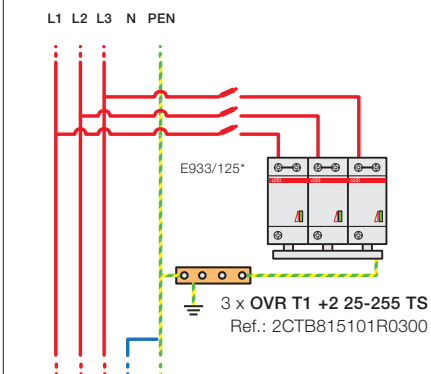

> 10 meters cable

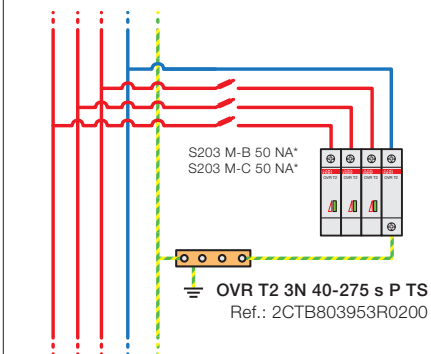

> 10 meters cable

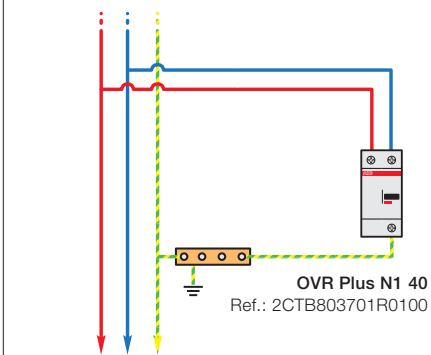

Configuration 3
 $I_p \leq 7 \text{ kA}$

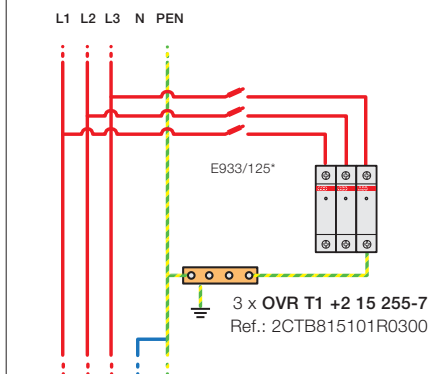

> 10 meters cable

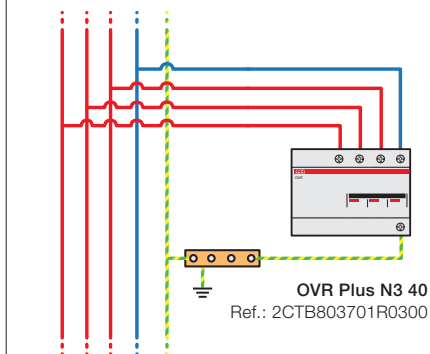

> 10 meters cable

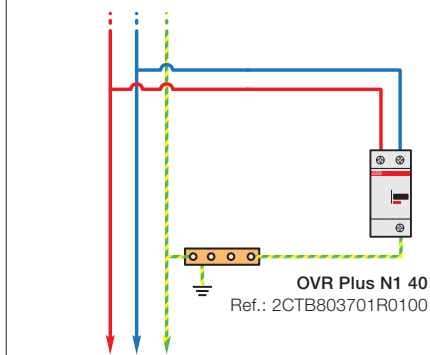

10

I_p : prospective short circuit current of the power supply
* Must be according to the coordination rules with main or upstream short circuit protection(s).

Selection tool: TT network 230/400 V
Industry, commercial building

Configuration 1
 $15 \text{ kA} \leq I_p \leq 50 \text{ kA}$

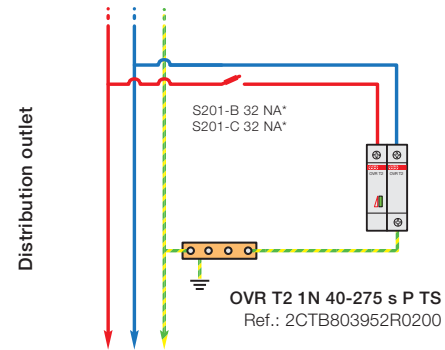
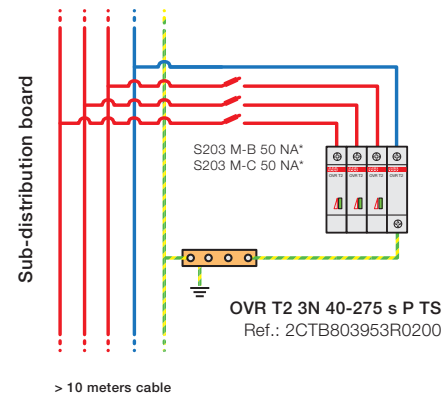
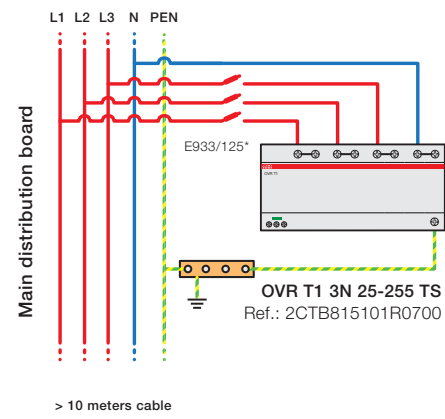

Configuration 2
 $7 \text{ kA} \leq I_p \leq 15 \text{ kA}$

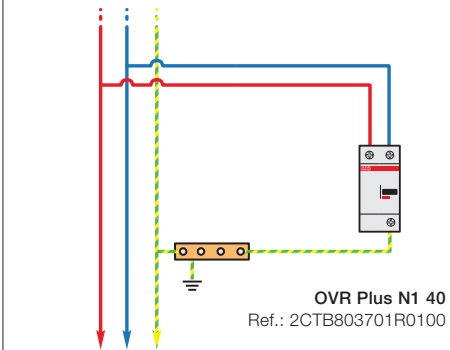
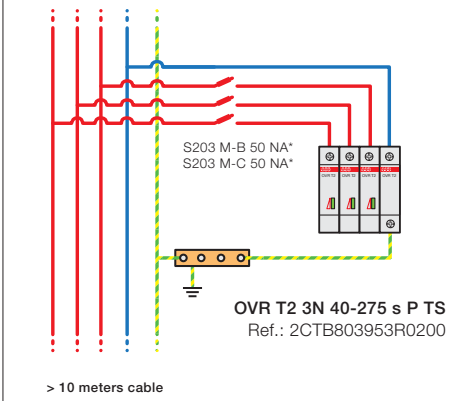
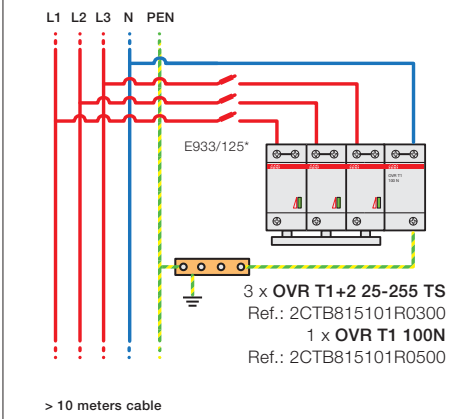

Configuration 3
 $I_p \leq 7 \text{ kA}$

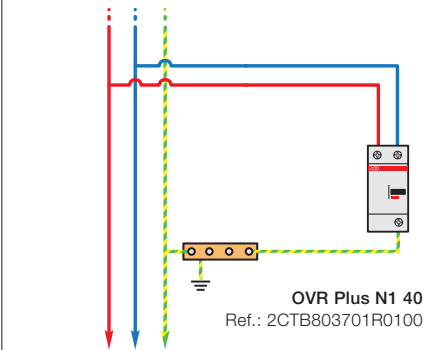
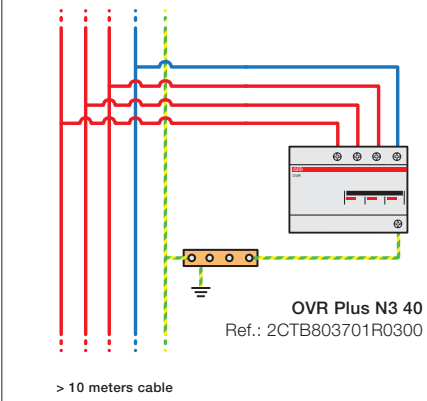
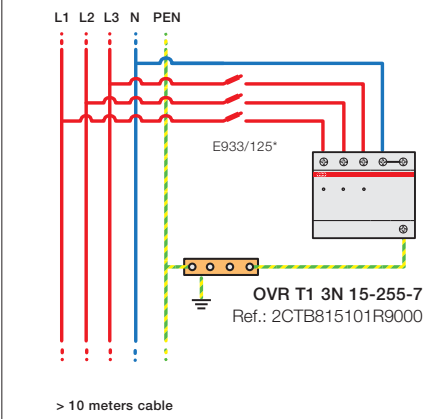

I_p : prospective short circuit current of the power supply
* Must be according to the coordination rules with main or upstream short circuit protection(s).

Protection and safety technical details

OVR Surge Protective Devices

Selection tool: IT network 230 V without neutral
Commercial, residential

The IT system has all live parts at the source isolated from earth or one part connected to earth with a high impedance.

Configuration 1
 $I_p \leq 50 \text{ kA}$

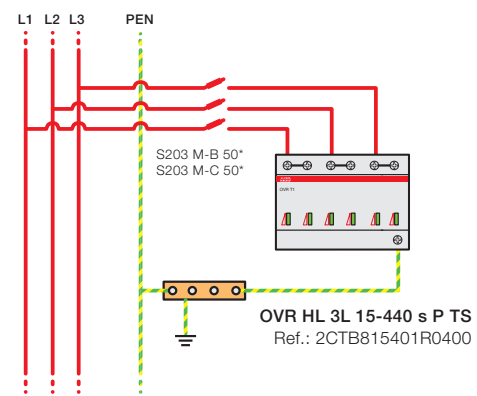

Configuration 2
 $I_p \leq 15 \text{ kA}$

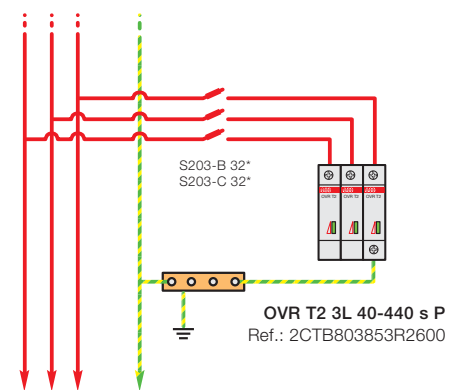
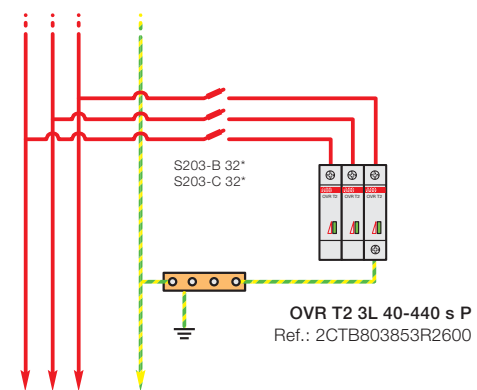
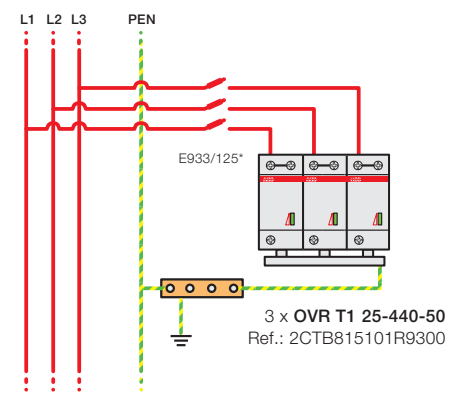

10

I_p : prospective short circuit current of the power supply
* Must be according to the coordination rules with main or upstream short circuit protection(s).

Selection tool: TNC, TNS/TT networks 230/400 V Residential

With external conductive parts (external lightning protection air terminal, antenna...) or powered by aerial lines

YES



NO



Neighbour with external lightning protection system (or generally with earthed extraneous conductive parts), or proximity of high points

YES

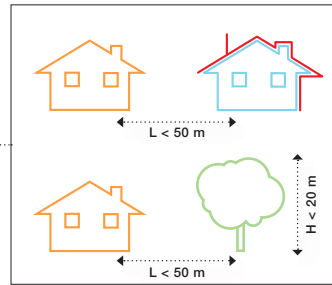

NO

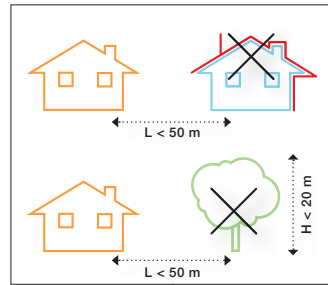

Configuration 1

With risk of direct lightning current (external protection, aerial lines...)

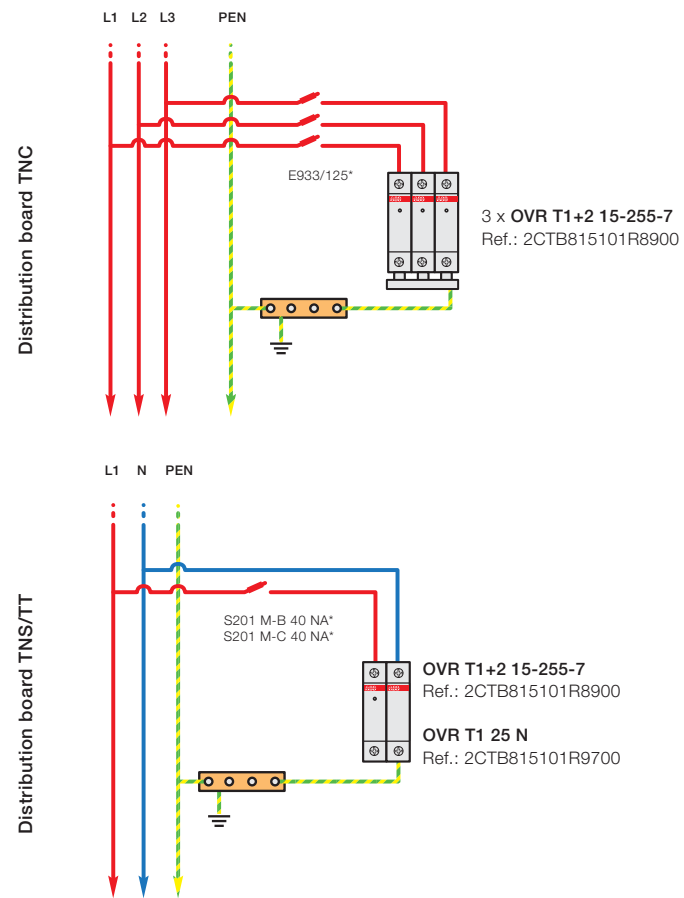

Configuration 2

With risk of indirect lightning current, transient surges

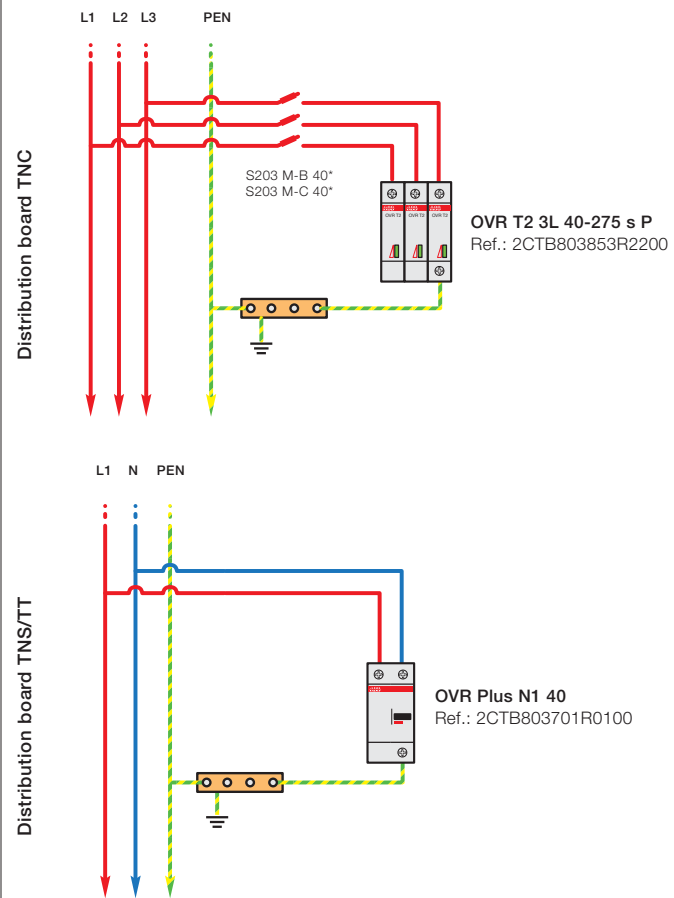

* Should be according to the coordination rules with installed main breakers

Protection and safety technical details

E 90 fuse-holders

E 90 fuse-holders

IEC 60947-3: Switches, disconnectors, switch-disconnectors and fuse combination units

This standard sets out the requirements of devices for connect/disconnect and switching operations.

Disconnector:

The disconnector is a mechanical device that, in the open position, meets the requirements specified for the disconnect function by the international IEC 60947-3 standard. The opening of a disconnector guarantees that the downstream circuit is electrically isolated from the upstream circuit. This is a required condition before personnel can access the equipment on the network, for example to perform maintenance.

The IEC 60364 standard prohibits carrying out maintenance on the installation if the circuits have not been disconnected.

Fuse disconnector:

This is the definition of a fuse carrier that performs a disconnect function. Not all fuse carriers are disconnectors: in order to be classified as such they must meet the requirements and pass the tests prescribed by the IEC 60947-3 standard.

Fuse switch-disconnector:

This is the designation given by the IEC 60947-3 standard to a fuse disconnector that permits switching under load. Not all fuse disconnectors allow this type of operation: in order to be classified as a fuse switch-disconnector, a device must have utilization category AC-21B or higher.

Utilization categories:

Not all connect/disconnect devices have the same performance specifications: the permitted operations depend on a parameter which defines the specific conditions of use, called the utilization category.

It specifies:

- The type of network (a.c./d.c.)
- The permitted type of operation (under no load, for resistive loads, for highly inductive loads, ecc...)
- The frequency of use

The E90 fuse switch-disconnectors have utilization category AC-22B. The E 90 PV fuse disconnectors have utilization category DC-20B.

Type of current	Utilization category		Typical applications
	A	B	
Alternating current	AC-20A	AC-20B	Connecting and disconnecting under no load.
	AC-21A	AC-21B	Switching of resistive loads, including moderate overloads
	AC-22A	AC-22B	Switching of mixed, resistive and inductive loads, including moderate overloads
	AC-23A	AC-23B	Switching of motors or other highly inductive loads
Direct current	DC-20A	DC-20B	Connecting and disconnecting under no load.
	DC-21A	DC-21B	Switching of resistive loads including moderate overloads
	DC-22A	DC-22B	Switching of mixed, resistive and inductive loads, including moderate overloads (e.g. shunt motors)
	DC-23A	DC-23B	Switching of highly inductive loads (e.g. series connected motors)

What loads can be connected/disconnected by a product with utilization category AC-22B?

Utilization category AC-22B permits occasional switching of mixed, resistive and inductive loads, including moderate overloads, in alternating current circuits. Examples of mixed loads are: transformers, power-factor corrected motors, capacitor banks, discharge lamps, heating, etc..

What loads can be connected/disconnected by a product with utilization category AC-20B?

Utilization category AC-20B does not permit connecting or disconnecting under load. An additional load break device is required.

IEC 60269-1: Fuses with voltage rating not exceeding 1000 V for alternating current and 1500 V for direct current

This standard sets out the requirements for low voltage fuses, and consequently the requirements for the fuse carrier devices that hold them.

The standard has two separate sections with different requirements, depending on the type of person using the equipment.

IEC 60269-2: supplementary requirements for fuses for use by authorized persons, mainly for industrial applications.

IEC 60269-3: supplementary requirements for fuses for use by unskilled persons, mainly for household and similar applications.

Meaning	Suffix A	Frequent use
	Suffix B	Infrequent use

What is the difference between a fuse carrier conforming to the IEC 60947-3 standard and one conforming to the IEC 60269-2 standard?

These are two complementary standards: IEC 60269-2 sets out the characteristics of the fuses, which in turn also determine the general requirements for the fuse carriers. It is therefore the reference standard for overcurrent protection, but not for connecting/disconnecting and switching.

Is a fuse carrier conforming to IEC 60269-1 a disconnecter?

A device conforming only to IEC 60269 has a “disconnect function” but is not classified as a disconnecter under the more stringent IEC 60947-3 standard.

Why does the E 90 series have a lower direct current voltage rating under the IEC 60269-3 standard than under the IEC 60269-2 standard?

IEC 60269-2 sets out the requirements for industrial appli-

cations, and therefore the reference voltages are higher than those for the residential and commercial applications covered by IEC 60269-3. In other words, the rated voltage of the fuse carrier depends on the type of installation in which it is used, and the regulations applicable to it.

Is it possible to create multi-pole configurations using an assembly kit?

Multi-pole units made up using an assembly kit to combine single pole units will no longer conform to the reference standards.

In case of installations with many poles side by side, or installations in particular climate conditions, what derating of the nominal values should be taken into account?

The following tables give the parameters for derating the nominal current as a function of the number of poles installed side by side or the temperature and relative humidity.

Installation of multiple poles side by side:

E 91/32		E 91hN/32		E930 50/125	
Poles	Maximum current	Poles	Maximum current	Poles	Maximum current
1 ..4	I_n	1 ..3	I_n	1..3	I_n
5..7	$0.8 \times I_n$	4..9	$0.7 \times I_n$	4..6	$0.95 \times I_n$
more than 7	$0.7 \times I_n$	more than 10	$0.6 \times I_n$	more than 7	$0.9 \times I_n$

10

Climate conditions:

	20 °C	30 °C	40 °C	50 °C
Maximum temperature	20 °C	30 °C	40 °C	50 °C
Maximum humidity	95 %	90 %	80 %	50 %
Maximum current	I_n	$I_n \times 0.95$	$I_n \times 0.9$	$I_n \times 0.8$

Protection and safety technical details

E 90 fuse-holders

Protection and disconnection of 1000 V DC lines

String protection

To avoid equipments damage on DC lines and to ensure isolation of the PV system in case of maintenance, E90 PV disconnectors fuses can be installed downstream the inverter to protect each single string. The fuses must be selected according to the rated current of the line and to the maximum dissipated power.

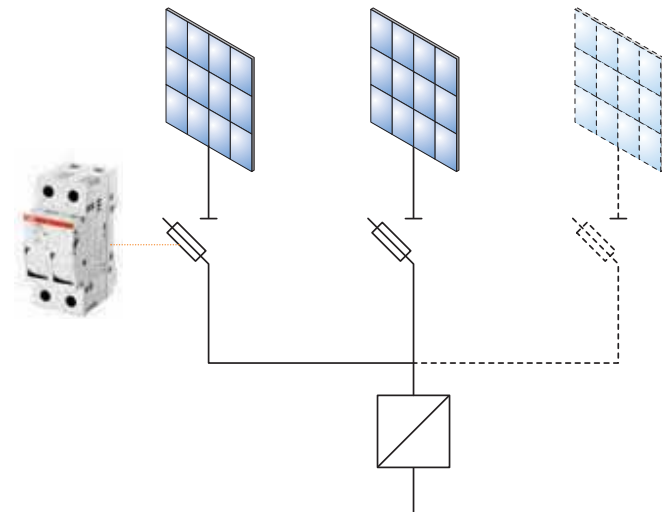

Back-Up Download

When the lcc short circuit current, at the point of installation, is greater than 100 A DC, the OVR PVs Surge Protective Devices require a back-up protection with a specific type gR fuse.

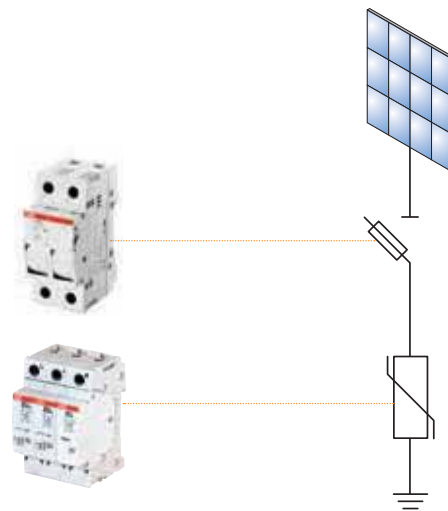

DC side of the inverter

For small size photovoltaic systems, E 90 PV fuse disconnectors can be used to protect the DC side of the inverter. The fuse should be chosen according to the rated current of the inverter.

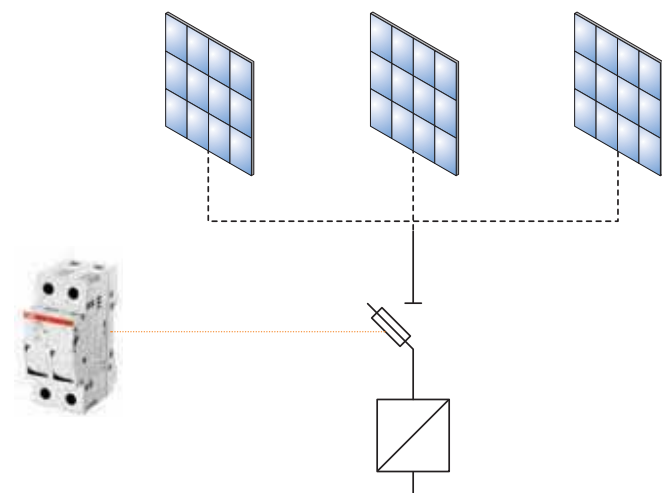

2CSC400039F002

Protection and safety technical details

E 930 fuse-holders

Padlocked in open position

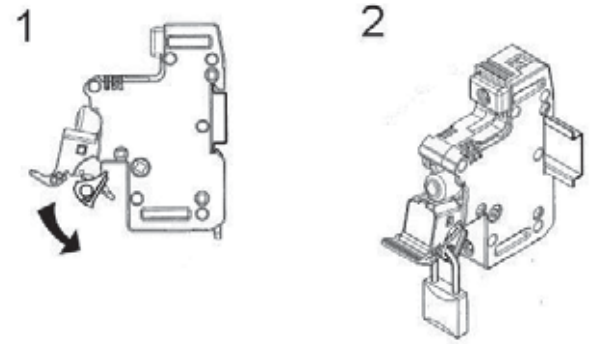

State of the E 930/MCR microswitch contact

Closed fuseholders with fuse

Open fuseholders without fuse

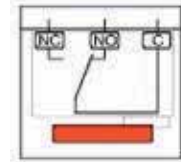
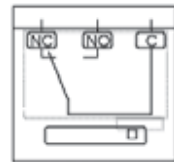

2CSC400034F0202

Microswitch functions enabled thanks to fuses with striker pin

a - fuse blown : indicates fuse break condition

b - pre-opening: indicates when the fuseholders cover is open

c - presence: indicates when the cover is closed but there is no fuse in

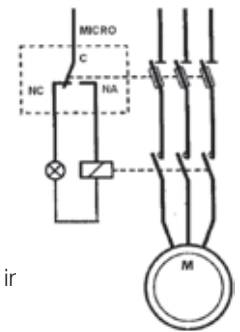

2CSC400034F0202

Microswitch assembly and disassembly steps

1- assembly

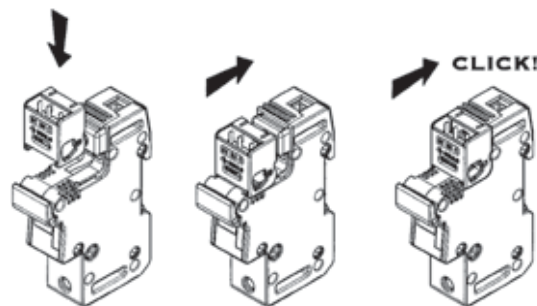

2- disassembly

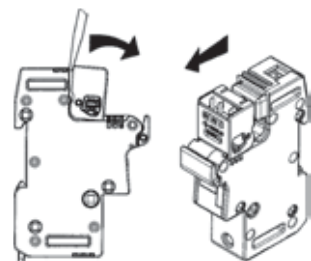

Protection and safety technical details

E 930 fuse-holders

Protection system selection

Maximum fuse rated current

Rated voltage		Fuseholder			
		E 90/20 8.5 x 31.5 mm	E 90/32 10.3 x 38 mm	E 930/50 14 x 51 mm	E 930/125 22 x 58 mm
400 V a.c.	gG	20 A	32 A	50 A	100 A
	aM	10 A	32 A	50 A	125 A*
500 V a.c.	gG	-	25 A	40 A	100 A
	aM	-	25 A	40 A	100 A
690 V a.c.	gG	-	10 A	25 A	80 A
	aM	-	-	25 A	80 A

* = to be used in combination with a device which guarantees protection against overload.

In the table above you will find indication about the highest rated current fuse that you can host inside a fuseholder, depending on the rated voltage of the circuit, the fuse size and the tripping curve characteristic.

ABB fuses and fuseholders comply with all regulatory requirements and sometimes they allow to install a fuse with rated current higher than the one set by the Standard IEC EN 60269-2-1.

Protection and safety technical details

E 9F fuses

E 9F fuses

Can fuses with rated current values higher than the one indicated in the table be used? For example, can a 10.3 x 38 mm 32 A gG fuse be used in a 10.3 x 38 mm E 90/32 fuse holder?

Yes, by following the manufacturer's instructions: you have to check that the power dissipated at the rated voltage value declared by the manufacturer for the size considered does not exceed the maximum dissipated power limit of the fuse holder. In this specific case, an E 9F10 GG32 fuse dissipates 3 W at 400 V rated voltage.

Since an E 90/32 series fuse holder for 10.3 x 38 mm fuses achieves 3 W thermal dissipation, the fuse in question can be used at 400 V rated voltage or less.

Can a 10.3 x 38 mm 32 A gG fuse be used in a 10.3 x 38 mm E 90/32 fuse holder with a rated voltage exceeding 400 V?

In the specific case of E 9F10 GG32, use of rated voltage exceeding 400 V fails to allow the equipment to comply with the maximum dissipated power limit.

Must the rated voltage always be derated if a fuse with a rated current exceeding the value in the table is used?

No, it depends on the technical specifications of the fuse. Derating is not required for E 9F 8 gG 20 fuses since they ensure (at 400 V AC) 2.30 W dissipated power, which is lower than the 2.5 W limit imposed by the standard.

Maximum dissipated power value for cylindrical fuses according to IEC EN 60269-2-1 (Art. 5-5)

Characteristic curve	Fuse			
	8.5 x 31.5	10.3 x 38	14 x 51	22 x 58
gG	2.5 W	3 W	5 W	9.5 W
aM	0.9 W	1.2 W	3 W	7 W

The table lists the maximum dissipated power values of the fuses, considering the size and the characteristic curve. The highlighted values correspond to the maximum dissipated power limit for fuse holders.

Protection and safety technical details

E 9F fuses

E9F gG

Power dissipation [W]

In [A]	Size			
	8.5x31.5	10.3x38	14x51	22x58
0.5	0.55	2		
1	0.35	2.5	3.4	
2	0.45	0.70	1	1.20
4	0.06	0.80	1.10	1.30
6	0.83	0.90	1.20	1.40
8	1	1.10	1.50	1.65
10	1.2	1.35	1.80	2
12	1.3	1.55	2.10	2.40
16	1.7	1.90	2.55	3
20	2	2.30	3	3.40
25	2.4	2.80	3.50	3.80
32		3	3.80	4.30
40			4.40	5.10
50			4.70	5.50
63				6.70
80				8
100				9
125				12.5

10 It is important verify that the power dissipation by the fuse does not exceed the limit allowed by the fuse it is hosted. In blue are shown the maximum values of power dissipation according with the range E 90 and E 930 specifications.

Characteristics tI

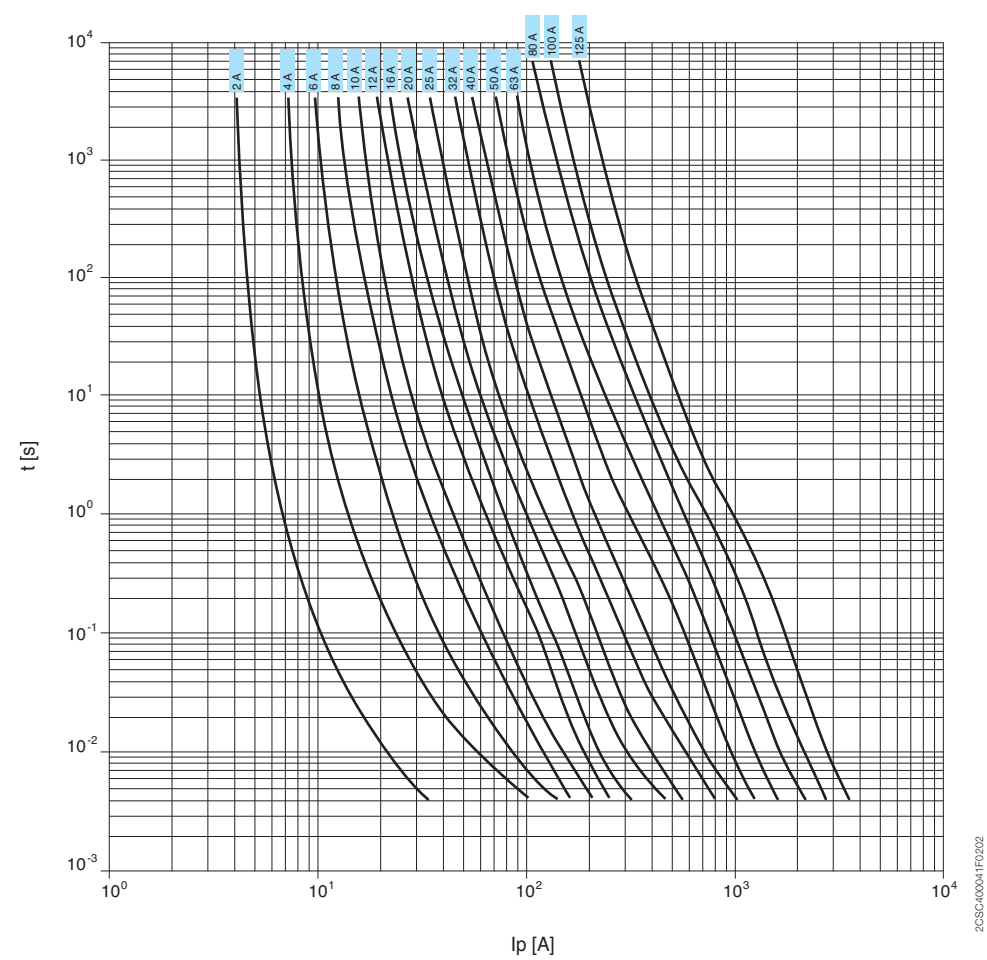

Protection and safety technical details

E 9F fuses

Characteristics I²t

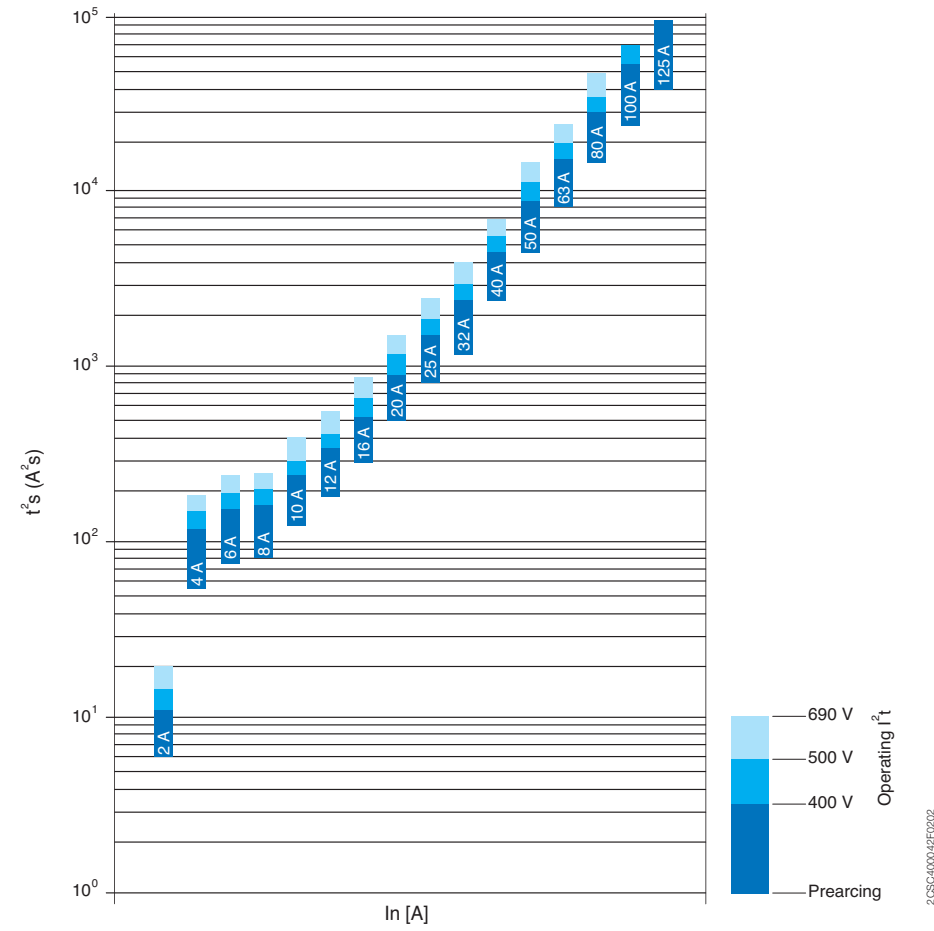

10

Temperature increase

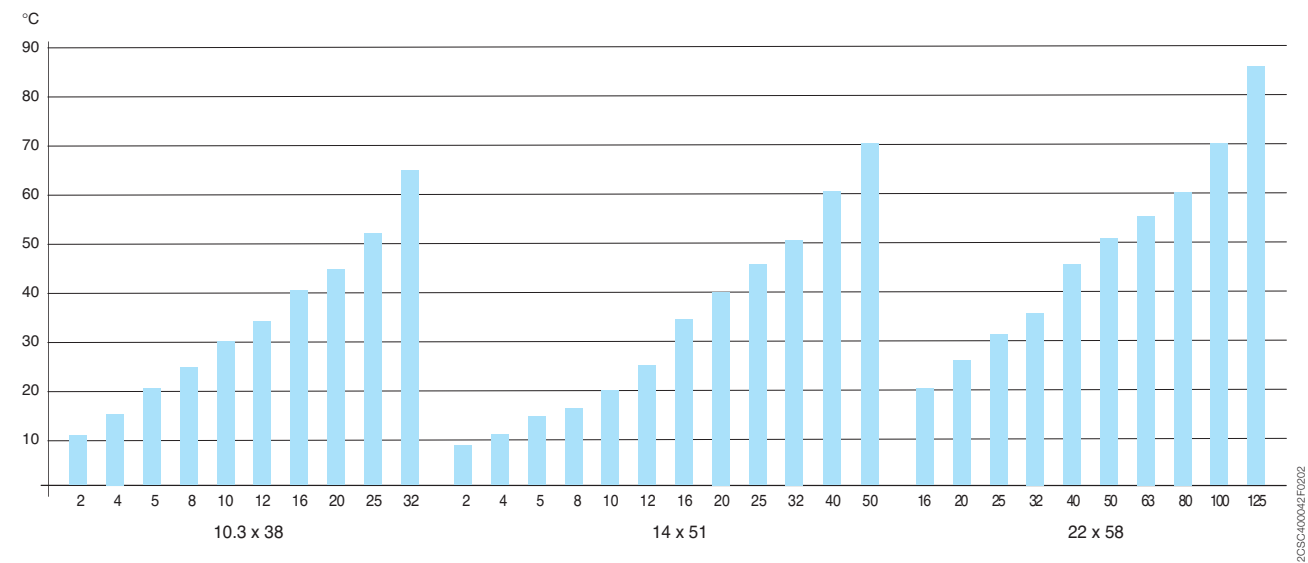

E9F aM

Power dissipation [W]

In [A]	Size			
	8.5x31.5	10.3x38	14x51	22x58
0.5		0.50	0.75	
1	0.09	0.13	0.18	0.20
2	0.15	0.20	0.25	0.30
4	0.26	0.30	0.40	0.50
6	0.35	0.45	0.55	0.65
8	0.47	0.55	0.65	0.75
10	0.55	0.65	0.75	0.85
12	0.7	0.75	0.85	1
16		0.90	1.20	1.40
20		1.10	1.50	1.70
25		1.40	1.80	2
32		2	2.10	2.60
40			2.60	3.20
45			2.80	
50			2.90	3.90
63				4.60
80				5.60
100				6.50
125				9.50

It is important verify that the power dissipation by the fuse does not exceed the limit allowed by the fuse it is hosted. In blue are shown the maximum values of power dissipation according with the range E 90 and E 930 specifications.

Protection and safety technical details

E 9F fuses

Characteristics tI

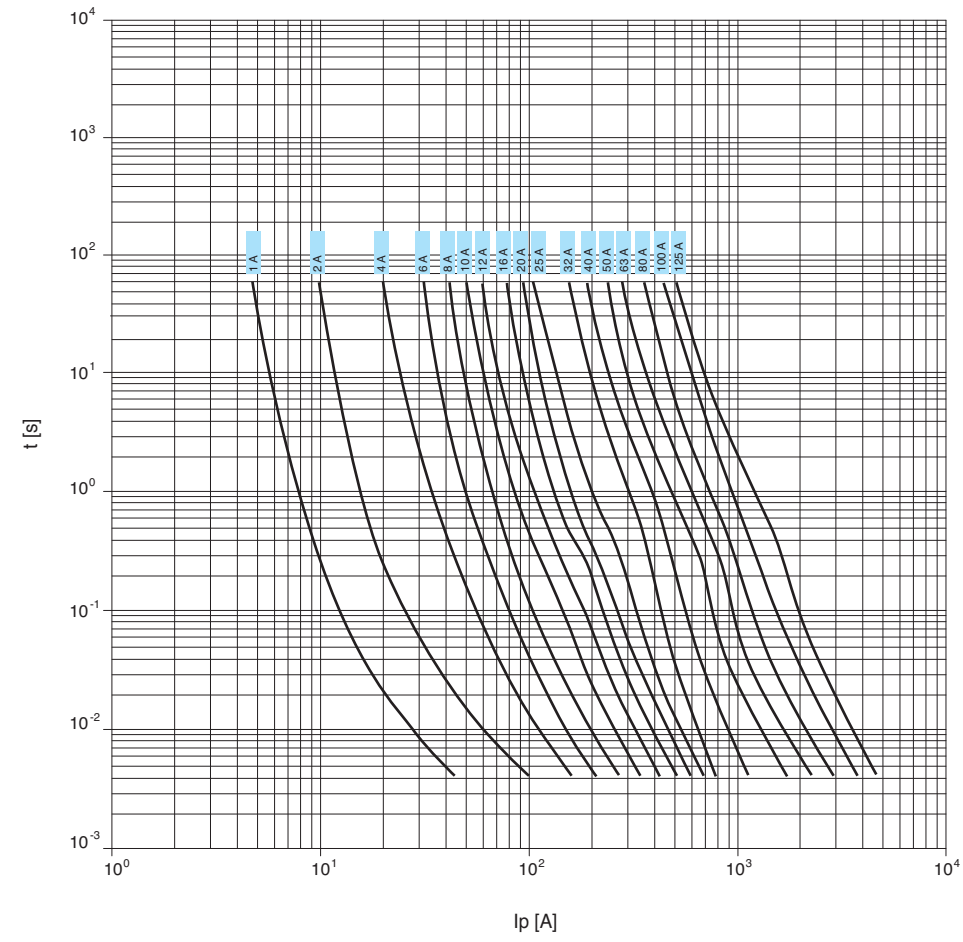

ZCS0400045F0202

Characteristics I²t

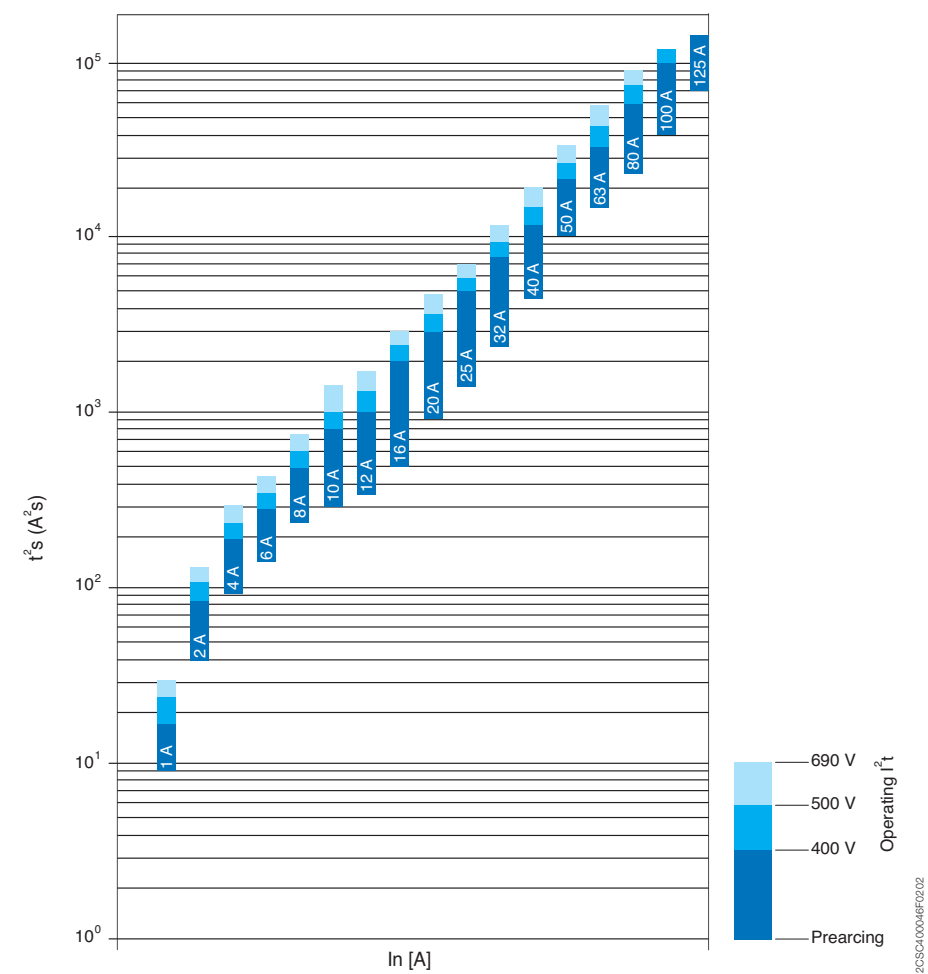

10

Temperature increase (testing in superior contact)

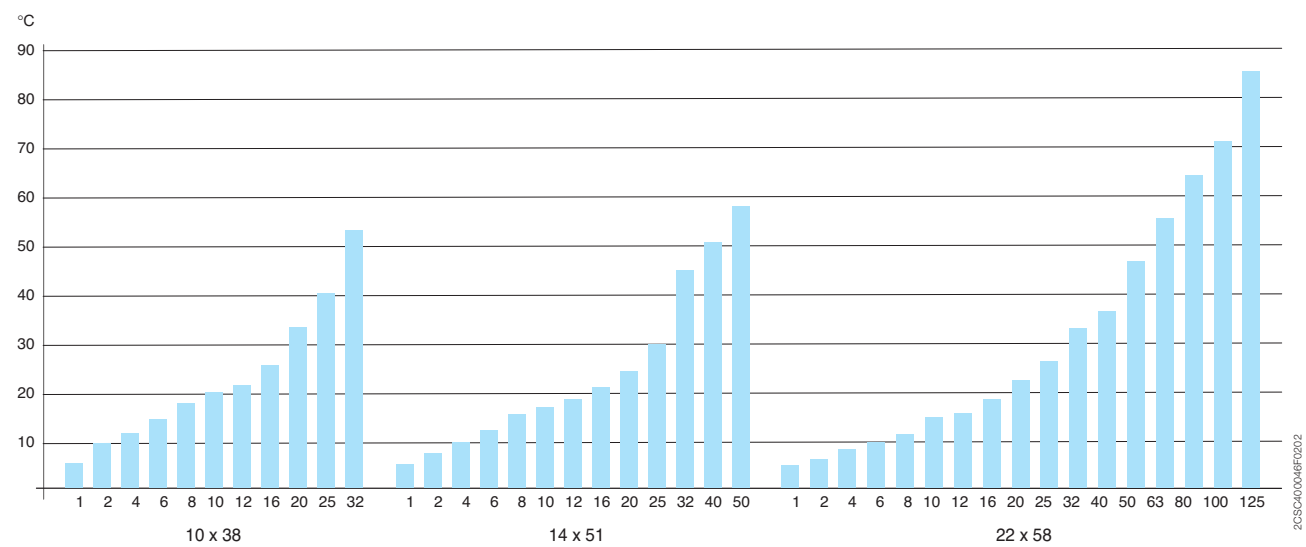

Protection and safety technical details

E 9F fuses

E9F gPV 10.3 x 38 mm cylindrical fuses

Type	Rated current [A]	Dissipated power 0.7 I _n [W]	Dissipated power 0.8 I _n [W]	Dissipated power I _n [W]	I ² t PreArc [A ² s]	Total I ² t [A ² s]
E 9F1 PV	1	0.12	0.16	0.32	1.2	19
E 9F2 PV	2	0.15	0.20	0.43	10.4	120
E 9F3 PV	3	0.70	0.90	1.40	3.1	130
E 9F4 PV	4	0.70	0.80	1.30	10.4	220
E 9F5 PV	5	0.70	0.90	1.40	22	330
E 9F6 PV	6	0.70	0.90	1.50	49	410
E 9F7 PV	7	0.80	1	1.50	65	630
E 9F8 PV	8	0.80	1	1.10	6.5	105
E 9F10 PV	10	0.90	1.20	1.50	10	127
E 9F12 PV	12	2	1.30	2	17	215
E 9F15 PV	15	1.20	1.60	3	25	495
E 9F20 PV	20	1.40	1.90	4.4	49	755
E 9F25 PV	25	1.20	1.70	2.90	132	1650
E 9F30 PV	30	1.50	2.10	3.80	197	1850

The power dissipation of the fuse cannot exceed the maximum power dissipation accepted by the fuseholder

Derating in combination with ambient temperature

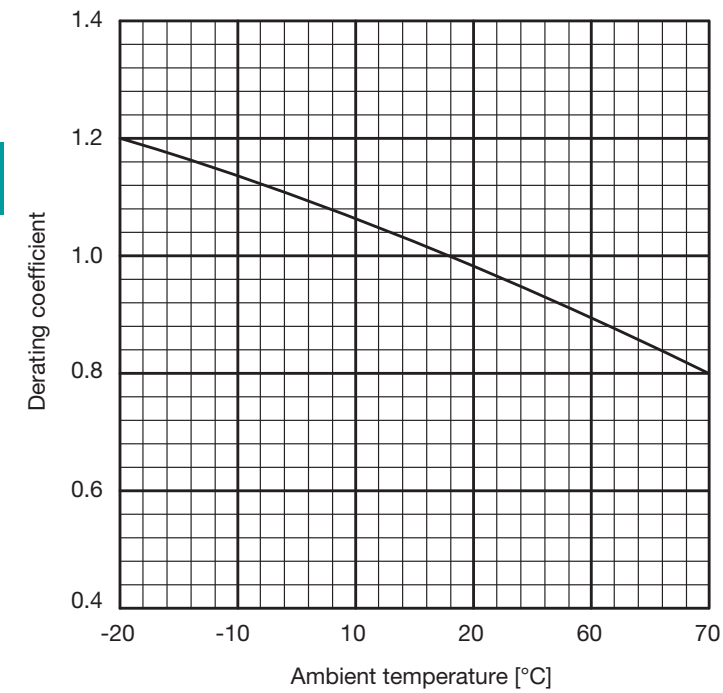

Melting time - Current data

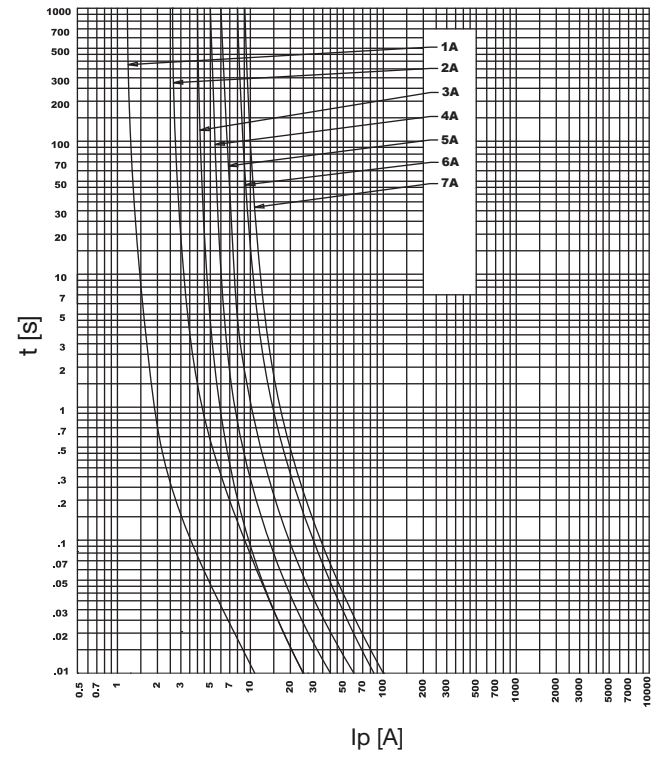

Melting time - Current data

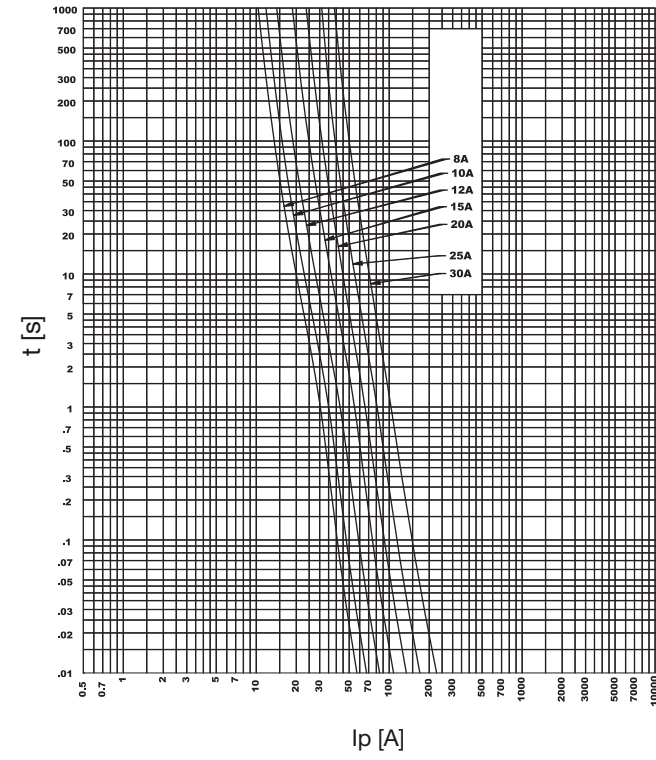

Voltage capabilities vs. time constant

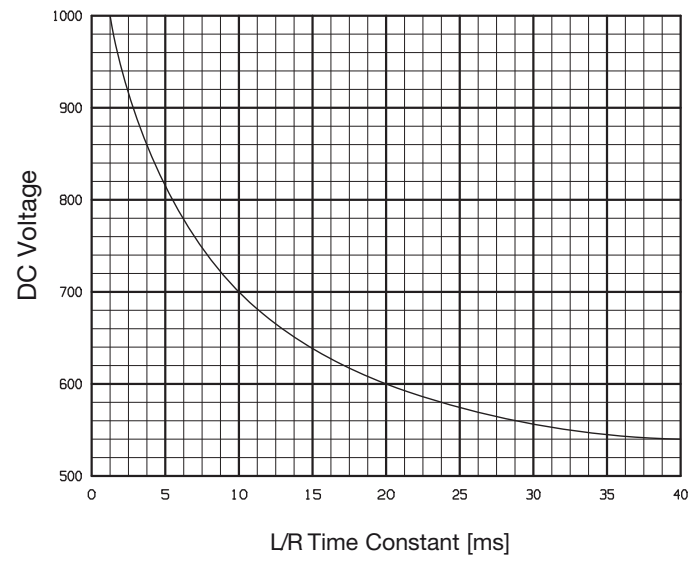

2CSC400048F0202

Protection and safety technical details

EPD 24-TB-101

EPD 24

Time/Current characteristic curve (TU = 25 °C)

The trip time is typically 3 s in the range between 1.1 and 1.8 x IN1).

Electronic current limitation occurs at typically 1.8 x IN1) which means that under all overload conditions (independent

of the power supply and the resistance of the load circuit) the max. overload before disconnection will not exceed 1.8 x IN1) times the current rating.

Trip time is between 100 ms and 3 sec (depending on overload or at short circuit).

Without this current limitation a considerably higher overload current would flow in the event of an overload or short circuit.

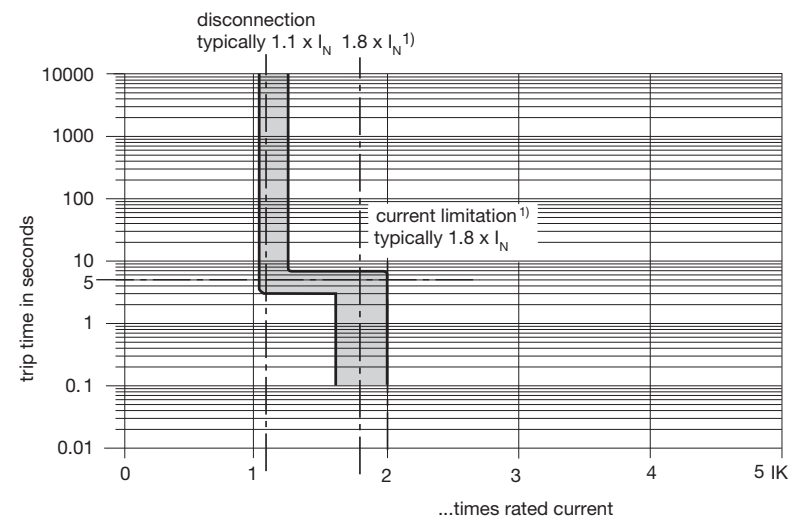

¹⁾ Current limitation typically 1.8 x I_N at I_N = 0.5 A...6 A
 Current limitation typically 1.5 x I_N at I_N = 8 A or 10 A
 Current limitation typically 1.3 x I_N at I_N = 12 A

10

Maximum cable lengths

EPD24 reliably trips from 0 Ω up to max. circuit resistance R_{max}.

Calculation of R _{max}		
Selected rating I _N (A)	3	6
Operating voltage U _S (V DC) (= 80 % of 24 V) ²⁾	19.2	19.2
Trip current I _{ab} = 1.25 x I _N (A) (EPD24 trips after 3 s)	3.75	7.50
R _{max} (Ω) = (U _B /I _{ab}) - 0.050	5.07	2.51

²⁾ Voltage drop of EPD24 and tolerance of trip point (typically 1.1 x I_N = 1.05 ... 1.35 x I_N) have been taken into account

Selection table for the incoming cable lengths with different cable cross-sections

Cable cross section A (mm ²)	0.14	0.25	0.34	0.5	0.75	1.00	1.50
Cable length L (m) (= single length)	cable resistance (Ω) = (ρ ₀ x 2 x L) / A 3)						
5	1.27	0.71	0.52	0.36	0.24	0.18	0.12
10	2.54	1.42	1.05	0.71	0.47	0.36	0.24
15	3.81	2.14	1.57	1.07	0.71	0.53	0.36
20	5.09	2.85	2.09	1.42	0.95	0.71	0.47
25	6.36	3.56	2.62	1.78	1.19	0.89	0.59
30	7.63	4.27	3.14	2.14	1.42	1.07	0.71
35	8.90	4.98	3.66	2.49	1.66	1.25	0.83
40	10.17	5.70	4.19	2.85	1.90	1.42	0.95
45	11.44	6.41	4.71	3.20	2.14	1.60	1.07
50	12.71	7.12	5.24	3.56	2.37	1.78	1.19
75	19.07	10.68	7.85	5.34	3.56	2.67	1.78
100	25.34	14.24	10.47	7.12	4.75	3.56	2.37
125	31.79	17.80	13.09	8.90	5.93	4.45	2.97
150	38.14	21.36	15.71	10.68	7.12	5.34	3.56
175	44.50	24.92	18.32	12.46	8.31	6.23	4.15
200	50.86	28.48	20.94	14.24	9.49	7.12	4.75
225	57.21	32.04	23.56	16.02	10.68	8.01	5.34
250	63.57	35.60	26.18	17.80	11.87	8.90	5.93

3) Resistivity of copper ρ₀ = 0.0178 (Ω x mm²)/m

Example 1: max. length for 1.5 mm² and 3 A: 214 m

Example 2: max. length for 1.5 mm² and 6 A: 106 m

Example 3: mixed wiring: (Control cabinet --- sensor/actuator level)

R1 = 40 m for 1.5 mm² and R2 = 5 m for 0.25 mm²:

R1 = 0.95 Ω, R2 = 0.71 Ω, total (R1 + R2) = 1.66 Ω

Please note

The user should ensure that the cable cross sections of the relevant load circuit are suitable for the current rating of the EPD24 used.

Automatic start-up of machinery after shut down must be prevented (Machinery Directive 98/37/EG and EN 60204-1).

In the event of a short circuit or overload the load circuit will be disconnected electronically by the EPD24.

Protection and safety technical details

EPD 24-TB-101

Information on UL approvals/CSA approvals

 UL1604

Operating Temperature Code T5

- This equipment is suitable for use in Class I, Division 2, Groups A, B, C and D or non-hazardous locations only

WARNING:

- Exposure to some chemicals may degrade the sealing properties of materials used in the following device: relay

Sealant Material:

Generic Name: Modified diglycidyl ether of bisphenol A

Supplier: Fine Polymers Corporation

Type: Epi Fine 4616L-160PK

Casing Material:

Generic Name: Liquid Crystal Polymer

Supplier: Sumitomo Chemical

Type: E4008, E4009, or E6008

RECOMMENDATION:

- Periodically inspect the device named above for any degradation of properties and replace if degradation is found

WARNING – EXPLOSION HAZARD:

- Do not disconnect equipment unless power has been removed or the area is known to be non-hazardous
- Substitution of any components may impair suitability for Class I, Division 2

 UL2367
Non-hazardous use

 UL 508
Non-hazardous use

 CSA C22.2 No. 213 (Class I, Division 2)
CSA C22.2 No. 142

Class 2

Meets requirement for Class 2 current limitation (EPD24 ...
-0,5 A/1 A/2 A/3 A)

The EPD24 features an integral power distribution system.

The following wiring modes are possible with various pluggable current and signal busbars:

- LINE+ (24 V DC)
- 0 V

Caution: The electronic devices EPD24 require a 0 V connection

- Auxiliary contacts

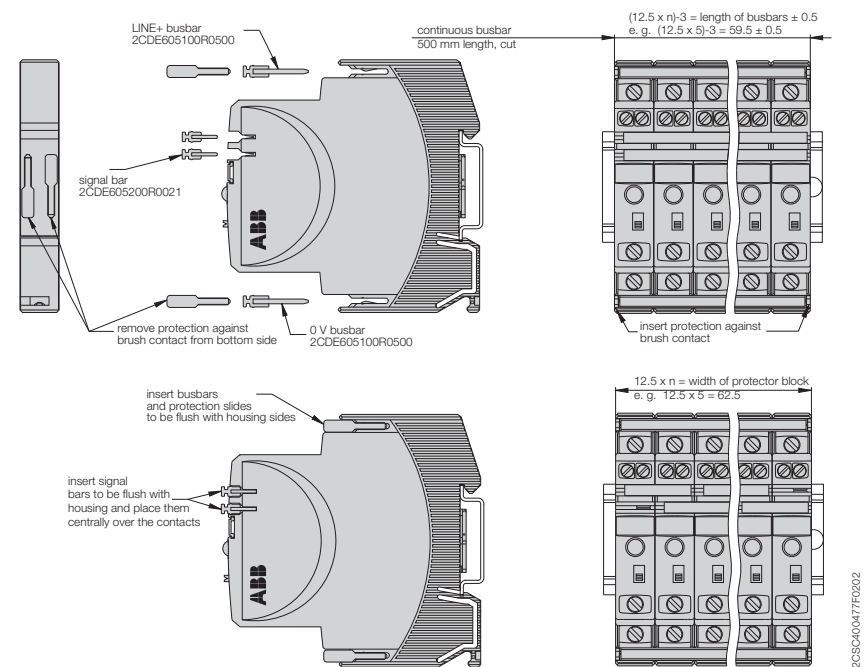

Mounting procedure

Before wiring insert busbars into protector block. A maximum of 10 connection cycles are permissible using connecting busbars.

10

Recommendation

After 10 units the busbars should be interrupted and receive a new entry live.

Table of length for busbars

(Order code 2CDE605100R0500)

No. of units	2	3	4	5	6	7	8	9	10
Length of busbar (mm) ± 0.5 mm	22	34.5	47	59.5	72	84.5	97	109.5	122

Protection and safety technical details

SQZ3 phase and sequence relays

Operating principle

Through an output relay with contact in safety switching, the SQZ3 phase and sequence presence devices for 400 V a.c. three-phase networks enable the phase and sequence presence management monitoring also the minimum voltage (adjustable up to 70% of V_n). In case of any defect, the device operates within a range from 2 to 20 seconds, with the opportunity to control the appropriate acoustic signals, motor controlling contactors or circuit breakers.

Application environments

The installation of the SQZ3 phase and sequence presence relays are particularly suitable for any environment and situation where it is necessary to control the three-phase network operation promptly signalling any defect.

Example of installation

As shown in the diagrams, one of the possible applications is the installation of the SQZ3 phase and sequence presence relays in a department store, where the escalator supply circuit has a phase variation determining the SQZ3 relay intervention on the ESB contactor and causing the motor block and the alarm lighting indication.

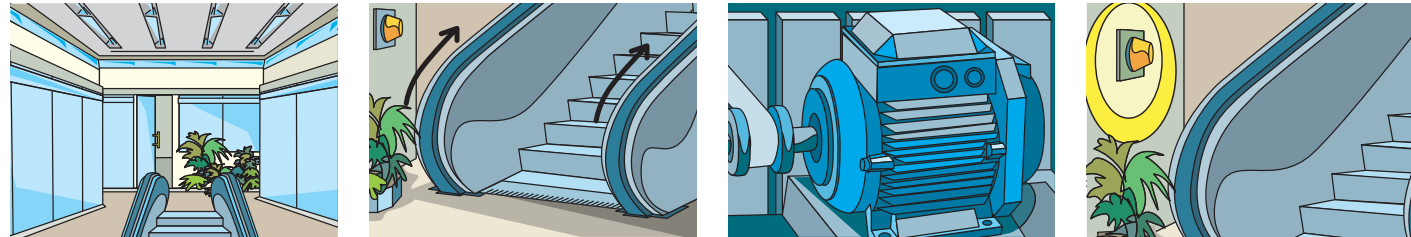

10

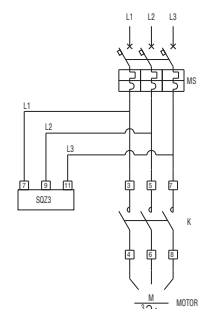
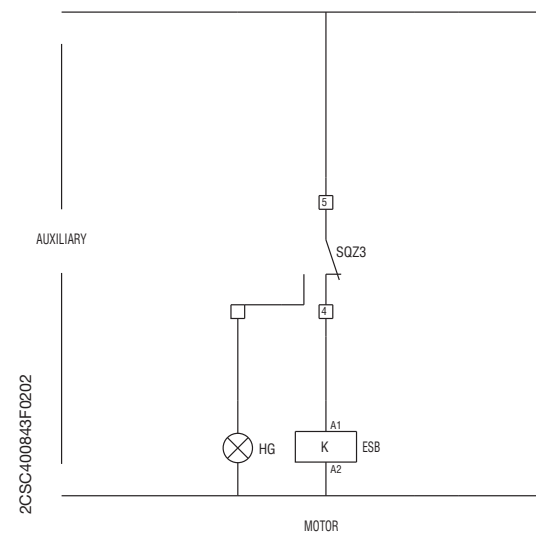
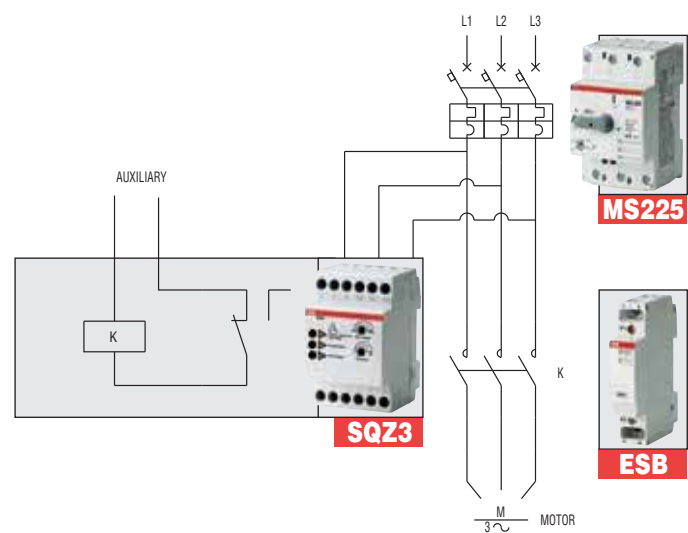

Protection and safety technical details

RH/RL maximum and minimum current/voltage relays

Maximum voltage relay (RHV) application example

Monitoring a load with the following ratings:

- $I_n = 5 \text{ A}$ (standard rated operating current)
- $V_n = 230 \text{ V a.c.}$ (standard rated operating voltage)
- $V_{max} = 250 \text{ V a.c.}$ (RHV relay intervention voltage)

1. Connect as in the diagram (since $V_{max}=250 \text{ V}$).

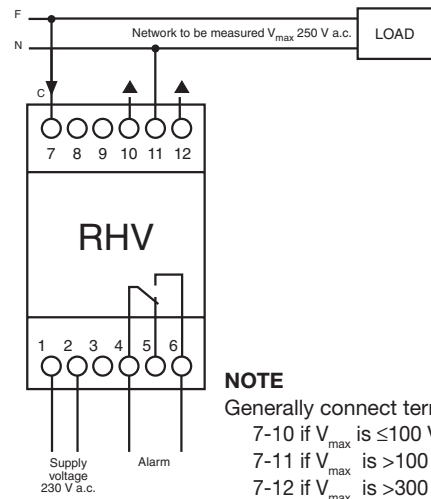

NOTE
Generally connect terminals:
7-10 if V_{max} is $\leq 100 \text{ V}$
7-11 if V_{max} is $> 100 \text{ V}$ and $\leq 300 \text{ V}$
7-12 if V_{max} is $> 300 \text{ V}$ and $\leq 500 \text{ V}$

2. Set the "Voltage%" trimmer to 83.33%, since:
$$V\% = \frac{250 (V_{max})}{300 (V_{set})} \times 100 = 83.33\%$$
being terminal 7-11 wired.
3. Set the "hysteresis %" trimmer; choosing 5% gives a intervention range from 237.5 to 250 V ($250 - 5\% = 237.5 \text{ V}$). The relay will switch at 250 V and return to its normal state at 237.5 V
4. Adjust the "delay" trimmer to select the desired relay intervention delay (1...30 sec). During this delay the "Power ON" LED blinks; at the end of the delay the "Alarm" LED becomes steadily lit and the relay intervenes.

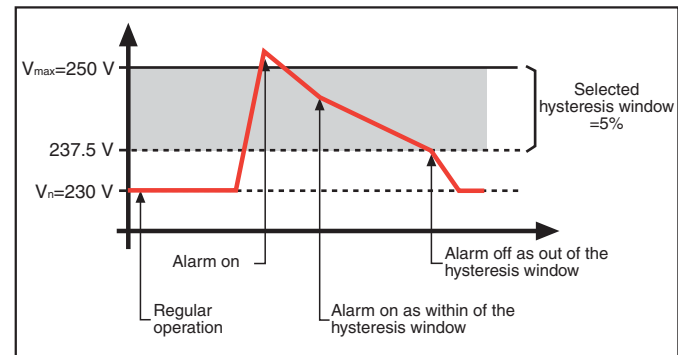

Protection and safety technical details

E 236 undervoltage monitoring relays

Function

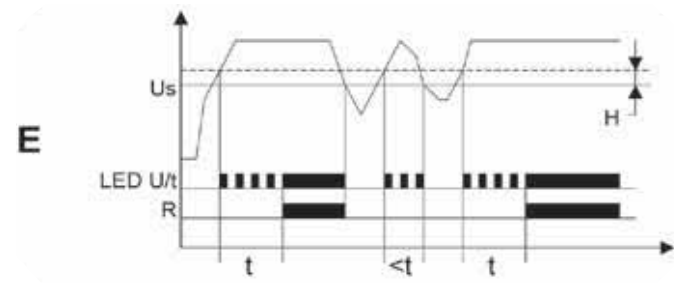

Function E 236-US 1.1D

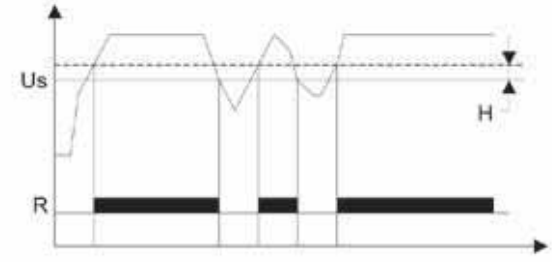

Function E 236-US 1.1, E 236-US 2.1, E 236-US 1 and E 236-US 2

Protection and safety technical details

Insulation monitoring devices

ISOLTESTER-DIG-PLUS

The new Isoltester-DIG-PLUS stands out for its superior and outstanding constructional and functional characteristics. Unlike conventional insulation monitors, state-of-the-art technology is used to monitor the condition of the network insulation. These control the network by applying a direct voltage between the power-supply line of the device and the earth. The direct current generated in this way is made up of ohmic components and capacitive components whose ratio establishes the total leakage level; if this is higher than the preset threshold value, the device triggers an alarm signal. However, the recording of the current values may be distorted by the direct-type components emitted by the electro-medical equipment that is more and more frequently connected to the system, resulting in triggering of the insulation monitor even when the reason the monitored values exceed the threshold is not due to an actual earth fault.

The new Isoltester- DIG-PLUS, on the other hand, inject into the encoded control signal circuit, which does not affect the calculation of the total leakage. In this way, false alarms can be avoided, thus increasing the efficiency of the control carried out on the insulation of the supply line. ISOLTESTER-DIG-

PLUS monitoring devices also offer new functions, including:

- the possibility to set a precise network insulation threshold value from 50 to 1 M Ω , rather than selecting a range preset by the manufacturer.
- temperature control of both the primary and secondary windings (T1 and T2) of the isolation transformer
- monitoring via current transformers of the maximum current to detect any overload status
- a screen on the display showing all recorded measurements
- a programmable relay output for the remote signalling of faults inside the device, low insulation status, recording high temperature values and achieving the maximum current threshold
- a RS485 serial port for connecting the device to other control and protection equipment, personal computers, etc. through the Modbus RTU communication protocol
- Error/Link Fail mode, a self-test to search for any faults inside the device, for the control of the connection to the network to be monitored and the correct operation of the thermometric probe.

The new ISOLTESTER-DIG is also available in the RZ version, for the insulation monitoring in networks up to 230 V AC

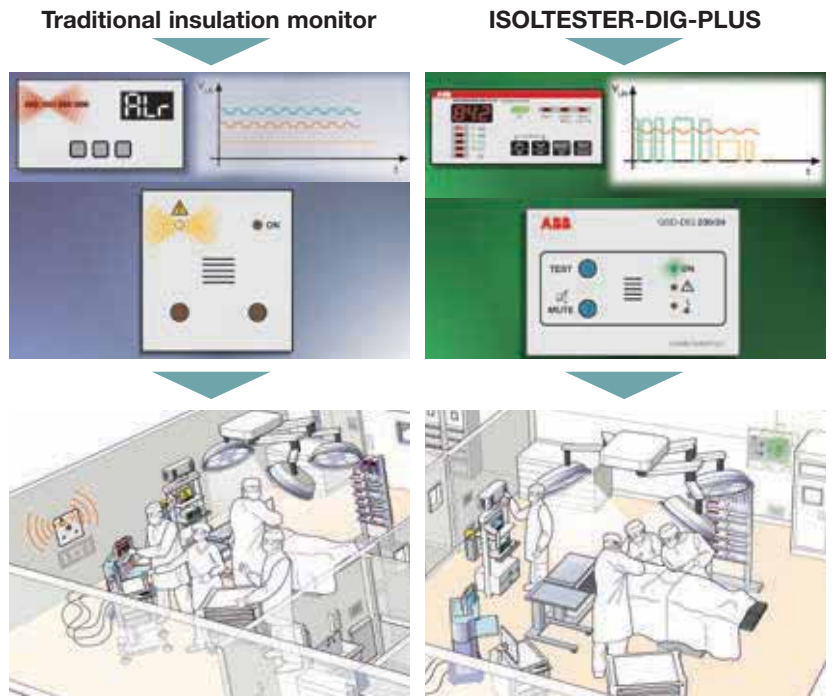

Protection and safety technical details

Insulation monitoring devices

QSD-DIG 230/24

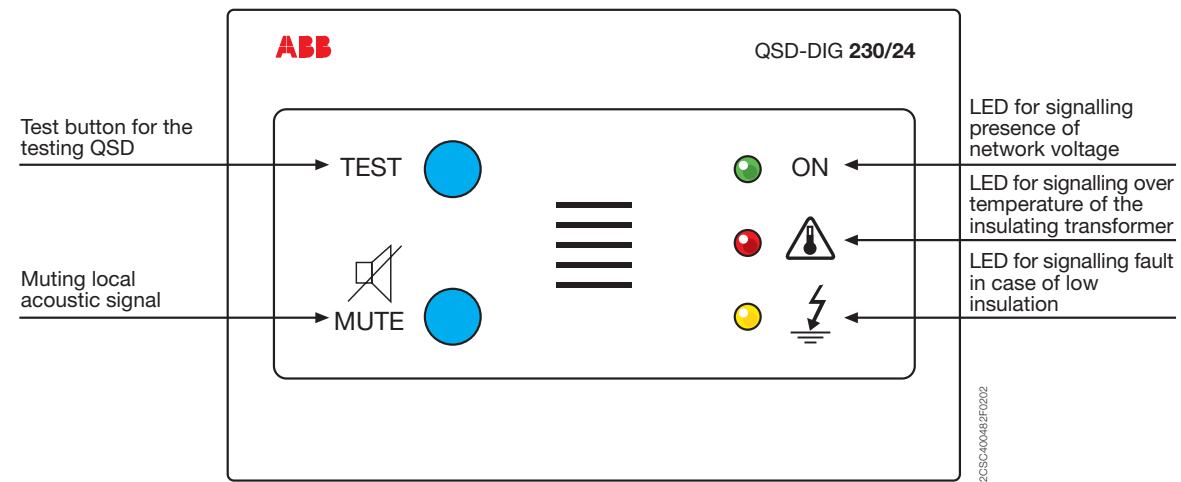

Functioning of the frontal operators

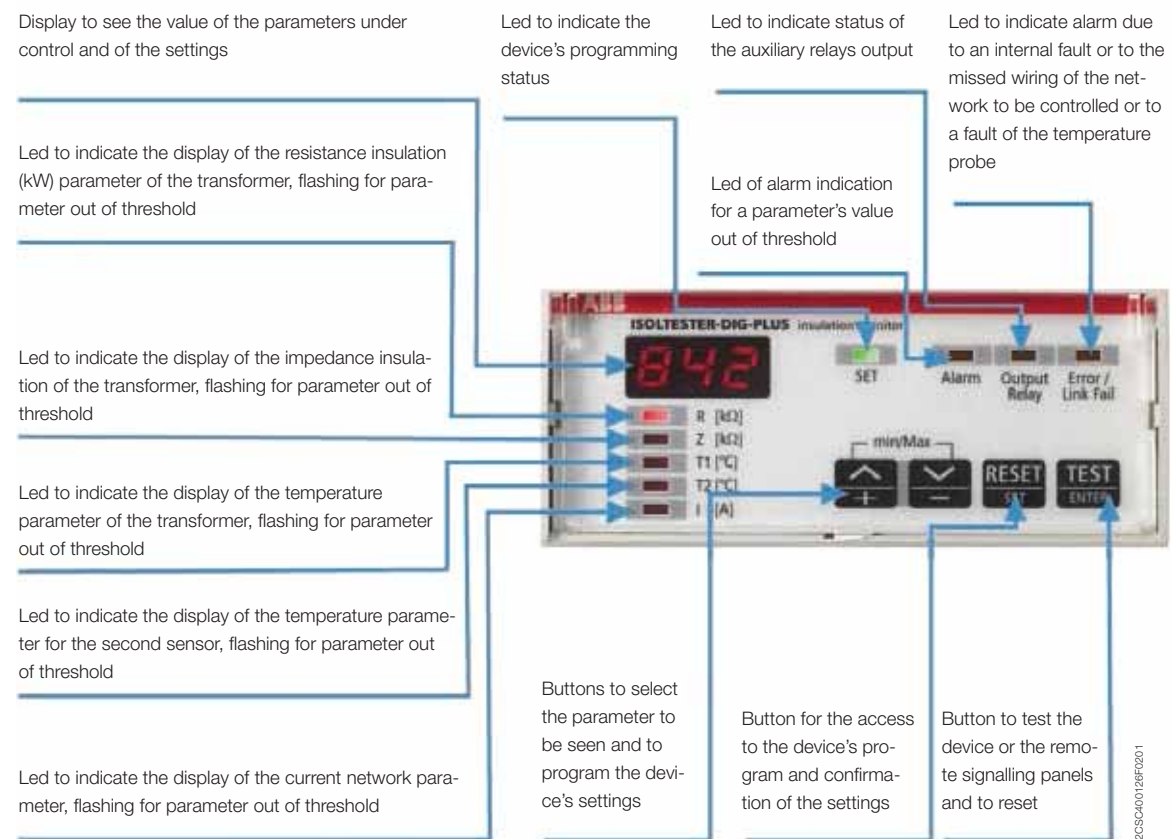

Protection and safety technical details

Insulation monitoring devices

Operating principle

ISOLTESTER-DIG-PLUS uses an encoding measuring signal that guarantees reliable measurements even in the presence of strong harmonic distortions.

Unlike conventional insulation monitoring devices ISOLTESTER-DIG-PLUS uses an encoded measuring signal that is not affected by network disturbances

The medical staff are thus able to continue working as normal, without any interruptions due to nuisance tripping.

Application environments

Thanks to the fact that it prevents nuisance tripping, ISOLTESTER-DIG-PLUS is ideal for all group 2 medical locations that need high operational continuity.

Example of installation

Conventional CRT or LCD displays, portable oxygen delivery systems, X-ray and sterilizing equipment can all provoke network disturbances.

Without ISOLTESTER-DIG-PLUS

With ISOLTESTER-DIG-PLUS

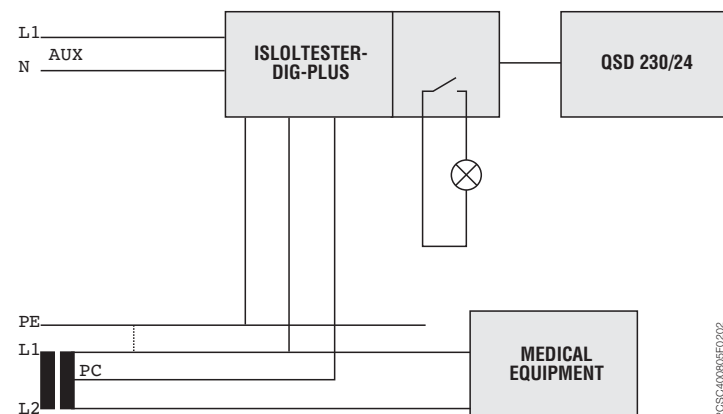
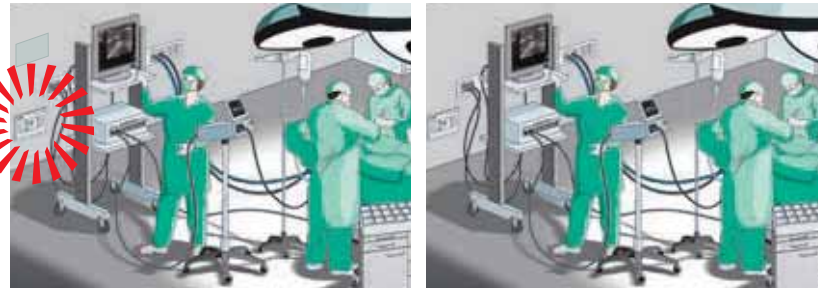

2CSC40005F0202

Protection and safety technical details

Monitor for medical locations

ISOLTESTER MRM

CP415

Features	
Front panel dimensions L x H x D	96 x 96 x 7 mm
Mounting depth	40.6 mm
Cut-out dimensions	89.3 x 89.3 mm
Front panel degree of protection	IP65/NEMA 4X (indoor use only)
Weight	0.21 kg
COM1	9 pin female connector: RS232,RS422, RS485
COM2	-
USB Port	-
CF card port	-
Ethernet	-
Flash ROM	4 MB
RAM	256 KB
CPU	32-bit RISC
Backup battery	-
Data/ Instructions	-
Internal clock	Yes, with rechargeable lithium battery
Display	Mono STN LCD, 16 grayscale, 240x240 pixel
	Backlight LED life: about 30,000 hours at 25°C
Usable display area LxH	58.5 x 58.5 mm
	30 x 30, characters 8 x 8 pixels
Display adjustments	Via touch screen
Touch screen	Analog
Power supply	24 V dc +-15%. Power consumption less than 4 W
Ambient temperature	from 0 to +50 °C
Storage temperature	from -10 to +60 °C
Ambient humidity	20-90% relative humidity without condensate
Vibration endurance	0.5 mm displacement, 10-55 Hz, 2 hours for X, Y and Z-axis
Shock endurance	10 G, 11 ms for 3 times on each X, Y and Z-axis
CE	EN61000-6-4, EN61000-6-2
Cooling	Natural cooling

10

Description

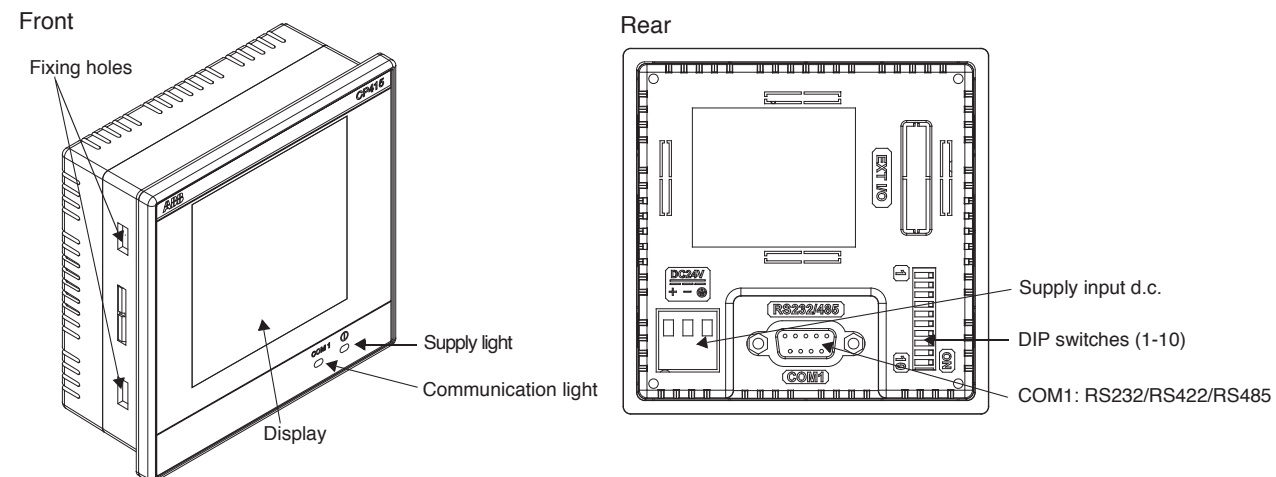

Protection and safety technical details

TI insulating transformers for medical locations

Wirings and serial number location

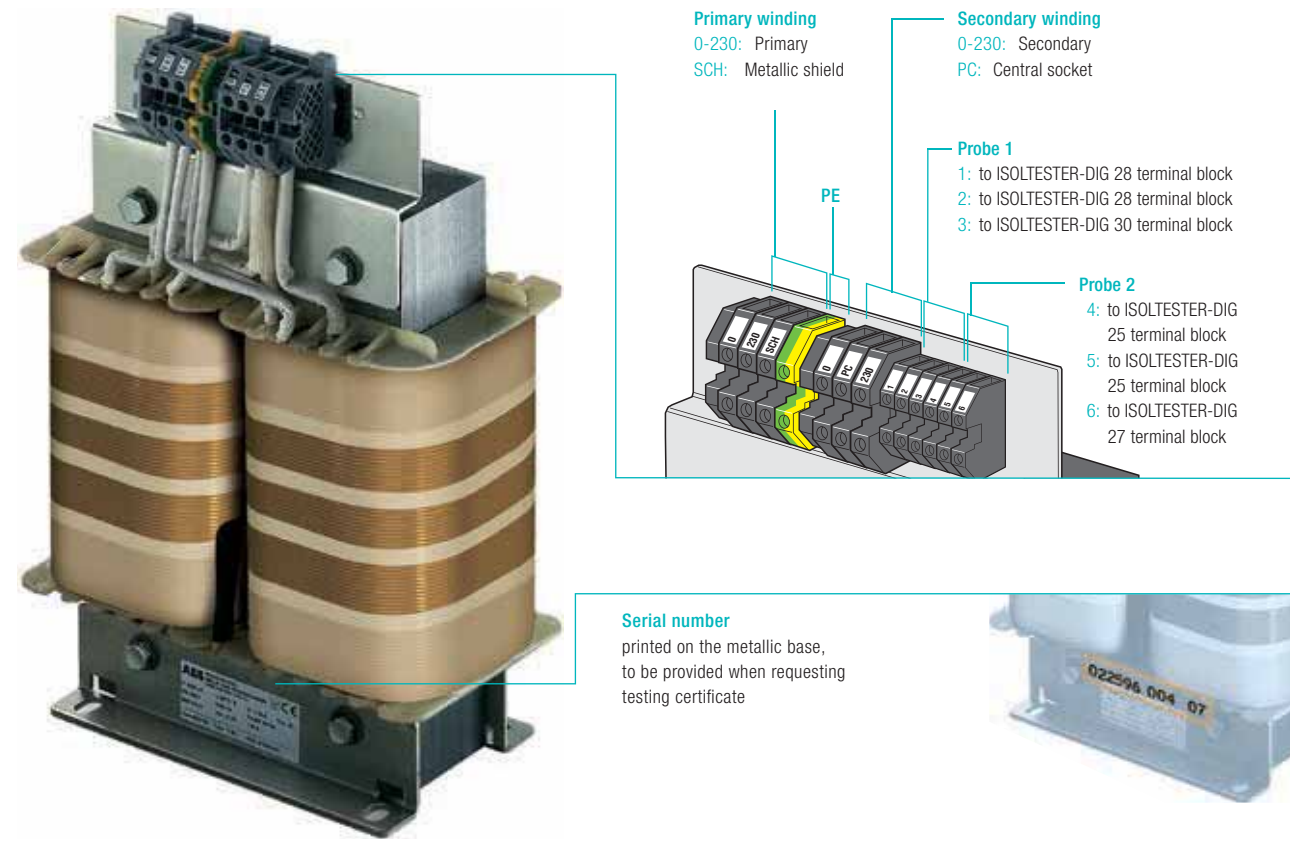

Protection and safety technical details

QSO switchboard for medical locations

Operating diagrams

QSO S

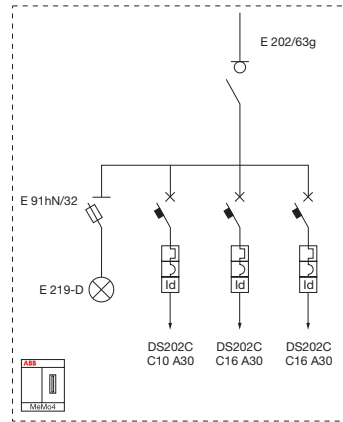

The devices inside the dotted areas are available only in the premium installation

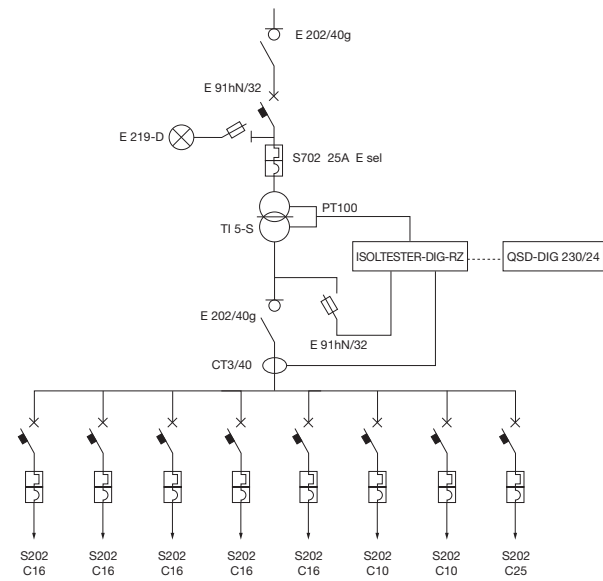

2CSC400185F004

Description	QSO 3S Classic	QSO 5S Classic	QSO 3S Premium	QSO 5S Premium
Switch disconnecter 2P 40 A E202/40g	2	2	2	2
Switch disconnecter 2P 63 A E202/63g			1	1
Fuse holder E 91hN/32	2	2	3	3
Green indicator lamp 1/2 network on E219-D	1	1	2	2
USB2.0 modular storage device 4GB MeMo4	1	1	1	1
Insulation monitoring device ISOLTESTER-DIG-RZ	1	1	1	1
MCB 6 kA 2P C10 S202	2	2	2	2
MCB 6 kA 2P C16 S202	5	5	5	5
MCB 6 kA 2P C25 S202	1	1	1	1
MCB 25 kA 2P E25 S702	1	1	1	1
RCBO 1N 10 A 0,03 A DS202 C C10 A30			1	1
RCBO 1N 16 A 0,03 A DS202 C C16 A30			2	2
Damper set AMM	4	4	4	4
Current transformer CT3 40/5 A	1	1	1	1
Insulating transformer for medical locations 3000 VA 230/230 V TI 3-S	1		1	
Insulating transformer for medical locations 5000 VA 230/230 V TI 5-S		1		1
Fuse 10 x 38 gG 2A E 9F10 GG2	4	4	6	6

Protection and safety technical details

QSO switchboard for medical locations

QSO M

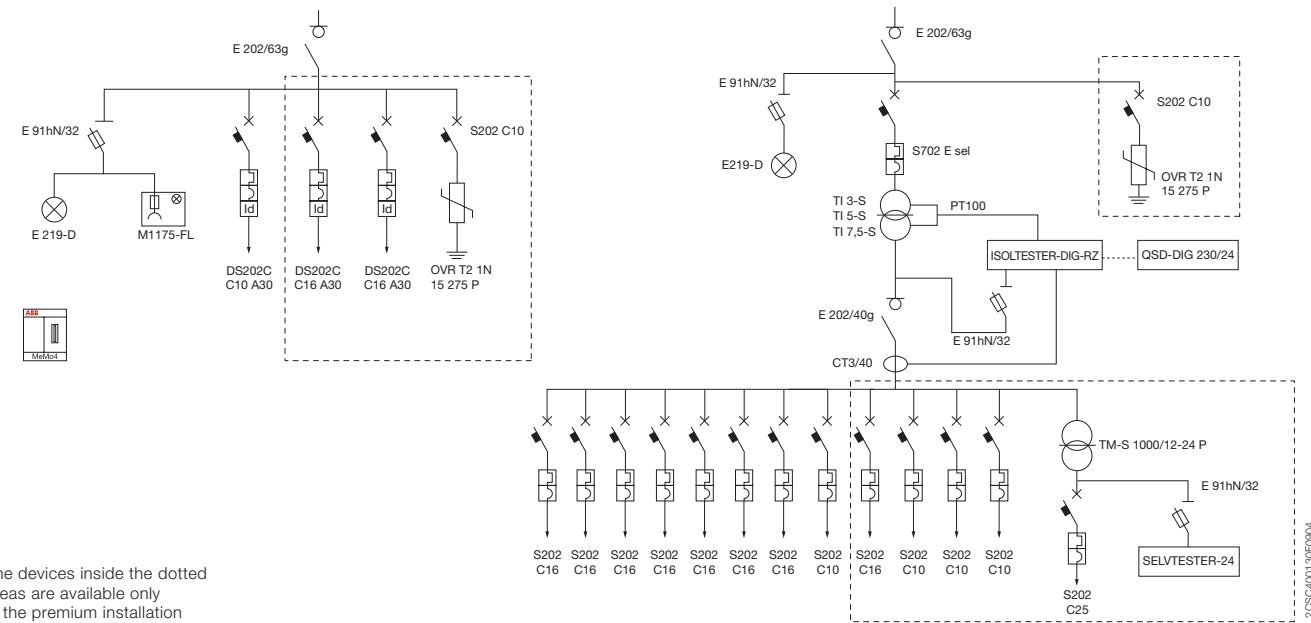

10

Description	QSO 3M Classic	QSO 5M Classic	QSO 7,5M Classic	QSO 3M Premium	QSO 5M Premium	QSO 7,5M Premium
Switch disconnector 2P 63 A E202/63g	3	3	3	3	3	3
Fuse holder E 91hN/32	3	3	3	4	4	4
Green indicator lamp 1/2 network on E219-D	2	2	2	2	2	2
USB2.0 modular storage device 4GB MeMo4	1	1	1	1	1	1
Insulation monitoring device ISOLTESTER-DIG-RZ	1	1	1	1	1	1
Insulation monitoring device 24 V SELVTESTER-24				1	1	1
Surge protection device OVRT2 1N 15 275				2	2	2
MCB 6 kA 2P C10 S202	3	3	3	8	8	8
MCB 6 kA 2P C16 S202	7	7	7	8	8	8
MCB 6 kA 2P C25 S202				1	1	1
Shucko socket with light and fuse 2P+T 16 A M1175-FL	1	1	1	1	1	1
MCB 25 kA 2P E25 S702	1	1	1			1
MCB 25 kA 2P E35 S702			1			1
RCBO 1N 10 A 0,03 A DS202 C C10 A30	1	1	1	1	1	1
RCBO 1N 16 A 0,03 A DS202 C C16 A30				2	2	2
Damper set AMM	4	4	4	8	8	8
Current transformer CT3 40/5 A	1	1	1	1	1	1
Control and safety transformer TM-S 1000/12-24 P. 230-400V S. 24V				1	1	1
Insulating transformer for medical locations 3000 VA 230/230 V TI 3-S	1			1		
Insulating transformer for medical locations 5000 VA 230/230 V TI 5-S		1			1	
Insulating transformer for medical locations 7500 VA 230/230 V TI 7.5-S			1			1
Fuse 10 x 38 gG 2A E 9F10 GG2	6	6	6	8	8	8

QSO L

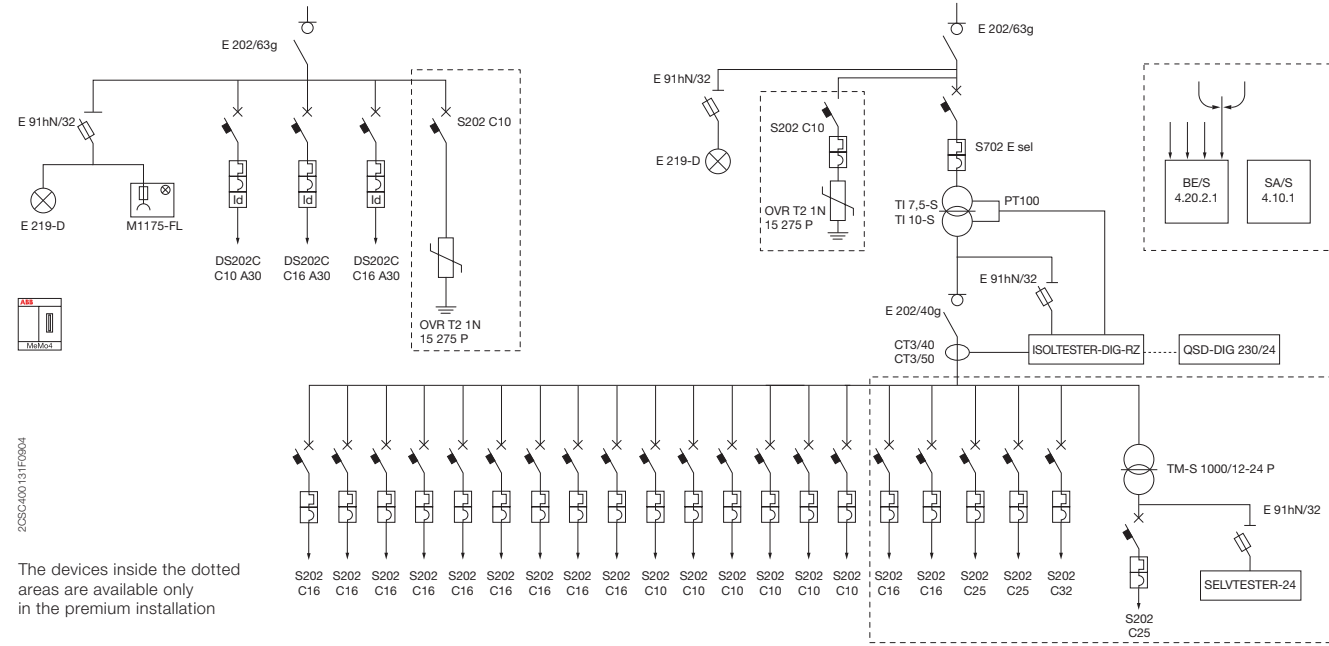

Description	QSO 10L Classic	QSO 7,5L Premium	QSO 10L Premium
Switch disconnecter 2P 63 A E202/63g	3	3	3
Fuse holder E 91hN/32	2		4
Green indicator lamp 1/2 network on E219-D	2	2	2
USB2.0 modular storage device 4GB MeMo4	1	1	1
Binary Input 4-fold BE/S 4.20.2.1			1
Insulation monitoring device ISOLTESTER-DIG-RZ	1	1	1
Insulation monitoring device 24 V SELVTESTER-24		1	1
Switch actuator 4-fold 10 A SA/S 4.10.1			1
Surge protection device OVRT2 1N 15 275		2	2
Auxiliary contact 1 change over S2-CS/H6R			1
MCB 6 kA 2P C10 S202	5	7	7
MCB 6 kA 2P C16 S202	9	11	11
MCB 6 kA 2P C25 S202		3	3
MCB 6 kA 2P C32 S202		1	1
Shucko socket with light and fuse 2P+T 16 A M1175-FL	1	1	1
MCB 25 kA 2P E25 S702			
MCB 25 kA 2P E35 S702		1	
MCB 25 kA 2P E50 S702	1		
MCB 25 kA 2P S702-E 50+H2WR selettivo			1
RCBO 1N 10A 0,03A DS202 C C10 A30	1	1	1
RCBO 1N 16A 0,03A DS202 C C16 A30	2	2	2
Damper set AMM	4	8	8
Current transformer CT3 40/5 A		1	
Current transformer CT3 50/5 A	1		1
Control and safety transformer TM-S 1000/12-24 P. 230-400 V S.24 V		1	1
Insulating transformer for medical locations 7500 VA 230/230 V TI 7,5-S		1	
Insulating transformer for medical locations 10000 VA 230/230 V TI 10-S	1		1
Fuse 10 x 38 gG 2A E 9F10 GG2		8	8

Protection and safety technical details

QSO switchboard for medical locations

QSO XL

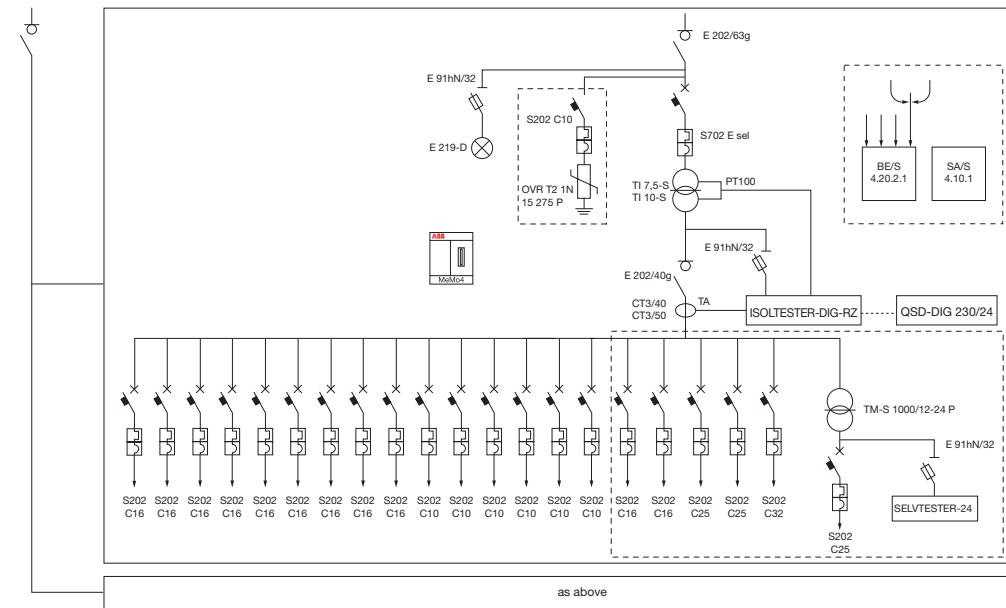

2CSC400105F002

The devices inside the dotted areas are available only in the premium installation

Description	QSO 7.5XL Premium	QSO 10XL Premium
OT80F3C Switch disconnecter 3P 80 A	1	1
Switch disconnecter 2P 63 A E202/63g	3	3
Fuse holder E 91hN/32	7	7
Green indicator lamp 1/2 network on E219-D	3	3
USB2.0 modular storage device 4GB MeMo4	1	1
Binary Input 4-fold BE/S 4.20.2.1	2	2
Insulation monitoring device ISOLTESTER-DIG-RZ	2	2
Insulation monitoring device 24 V SELVTESTER-24	2	2
Switch actuator 4-fold 10 A SA/S 4.10.1	2	2
Surge protection device OVRT2 1N 15 275	3	3
MCB 6 kA 2P C10 S202	15	15
MCB 6 kA 2P C16 S202	23	23
MCB 6 kA 2P C25 S202	6	6
MCB 6 kA 2P C32 S202	2	2
Shucko socket with light and fuse 2P+T 16 A M1175-FL	1	1
MCB 25 kA 2P S702-E 35+H2WR selettivo	2	
MCB 25 kA 2P S702-E 50+H2WR selettivo		2
RCBO 1N 10 A 0,03 A DS202 C C10 A30	1	1
RCBO 1N 16 A 0,03 A DS202 C C16 A30	2	2
Damper set AMM	16	16
Current transformer CT3 40/5A	2	
Current transformer CT3 50/5A		2
Control and safety transformer TM-S 1000/12-24 P. 230-400V S.24V	2	2
Insulating transformer for medical locations 7500 VA 230/230 V TI 7.5-S	2	
Insulating transformer for medical locations 10000 VA 230/230 V TI 10-S		2
Fuse 10 x 38 gG 2A E 9F10 GG2	14	14
Shaft for disconnecter square sect. 6 mm, lenght 360 mm	1	1
Handle for disconnecter I-0-II 45mm OHB45J6E011	1	1

Protection and safety technical details

Insulation monitoring devices

Insulation monitoring devices ISL for industrial applications

ISL-A 24-48

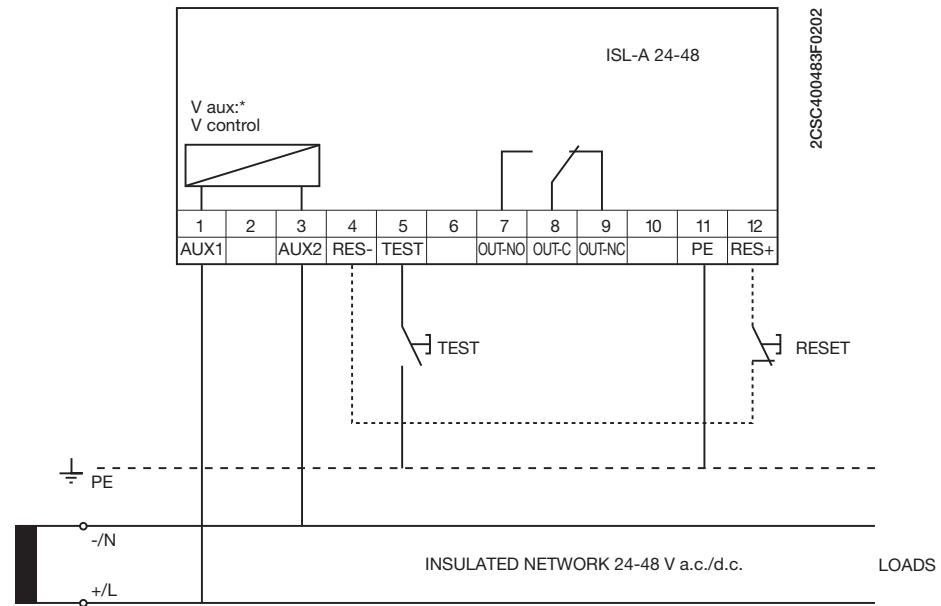

MICROSWITCH SETTINGS

The front microswitches allow the insulation threshold level to be adjusted between 10 and 60 kΩ, as shown below:

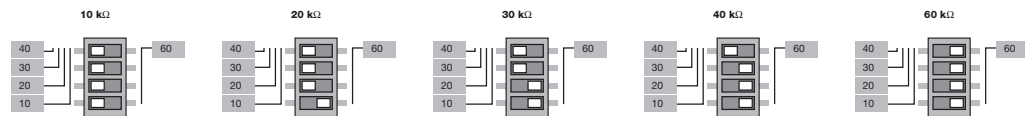

Protection and safety technical details

Insulation monitoring devices

ISL-A 115 and ISL-A 230

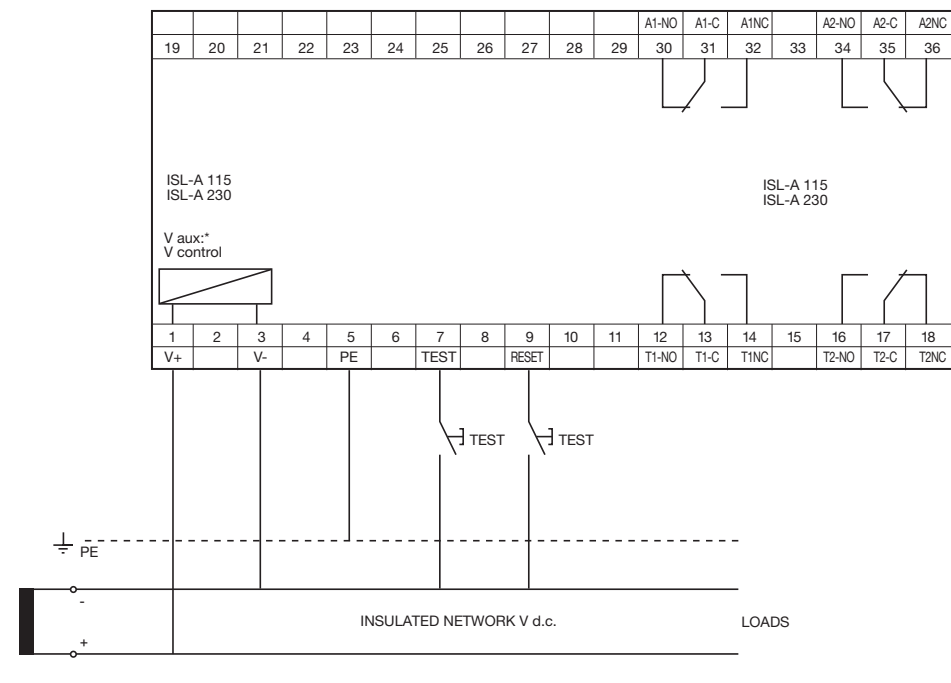

MICROSWITCH SETTINGS

The front microswitches are used for adjusting the insulation threshold level, enabling the fail-safe function and configuring the reset mode for both the alarm and trip thresholds.

Microswitches A, B, C, D for programming the trip and alarm thresholds:

ALARM		TRIP	
300 kΩ:	A=0, B=0, C=0, D=0	100 kΩ:	A=0, B=0, C=0, D=0
150 kΩ:	A=1, B=0, C=0, D=0	60 kΩ:	A=1, B=0, C=0, D=0
80 kΩ:	A=1, B=1, C=0, D=0	40 kΩ:	A=1, B=1, C=0, D=0
50 kΩ:	A=1, B=1, C=1, D=0	20 kΩ:	A=1, B=1, C=1, D=0
30 kΩ:	A=1, B=1, C=1, D=1	10 kΩ:	A=1, B=1, C=1, D=1

Microswitch E for configuring the FAIL SAFE mode

E=0 fail safe mode disabled

E=1 fail safe mode enabled

Microswitch F for configuring the RESET mode

F=0 manual reset

F=1 automatic reset

ISL-A 600

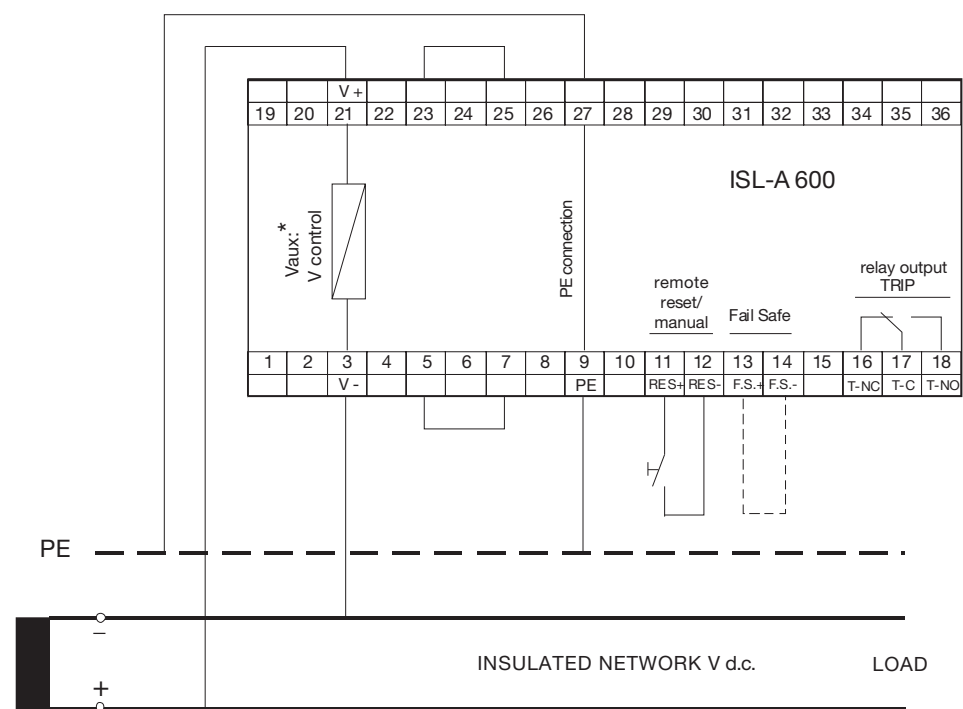

2CSC400481F0202

Protection and safety technical details

Insulation monitoring devices

ISL-C 230

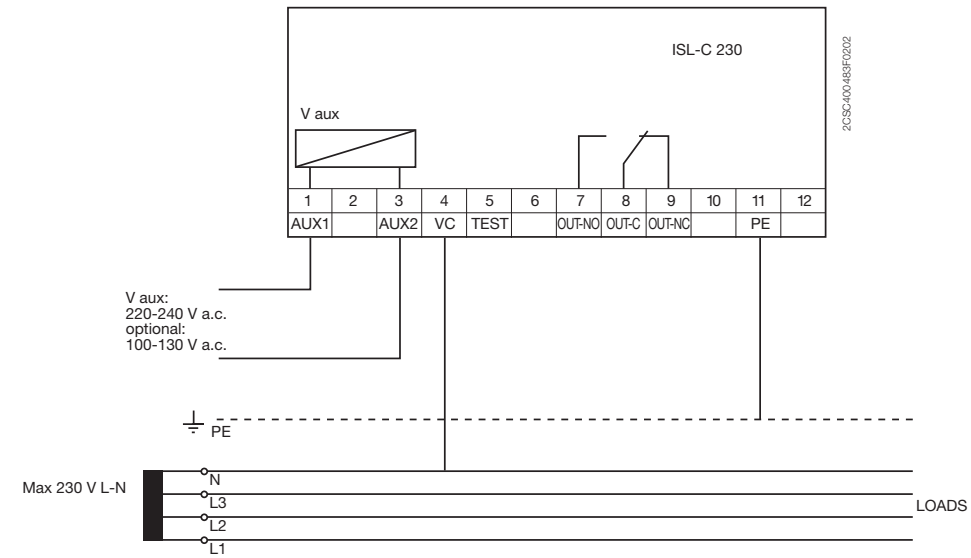

ISL-C 440

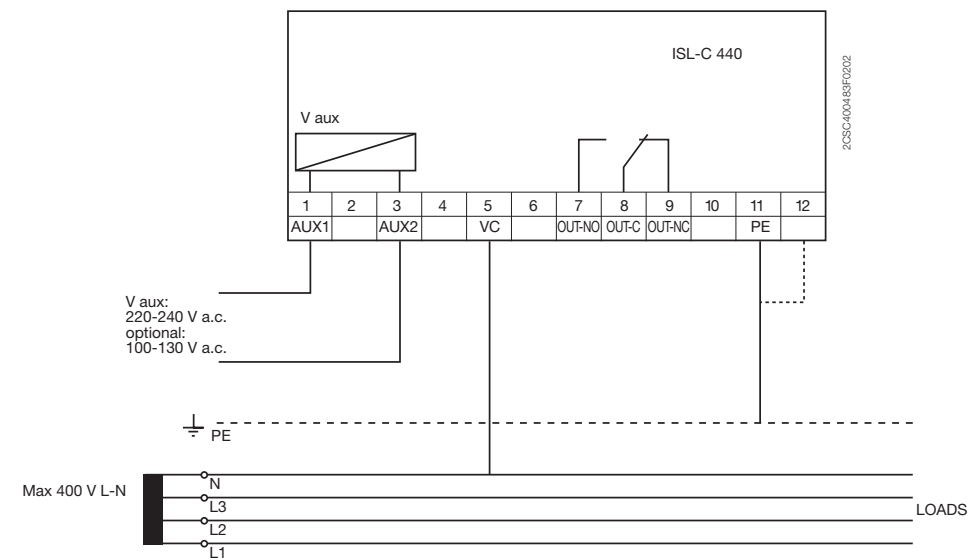

MICROSWITCH SETTINGS

The front microswitches are used for adjusting the insulation threshold level between 10 and 150 k Ω , as shown below:



ISL-C 600

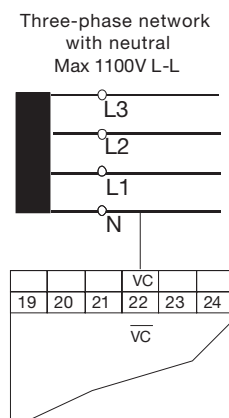
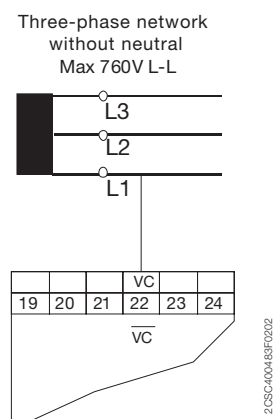
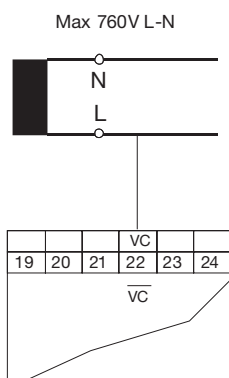
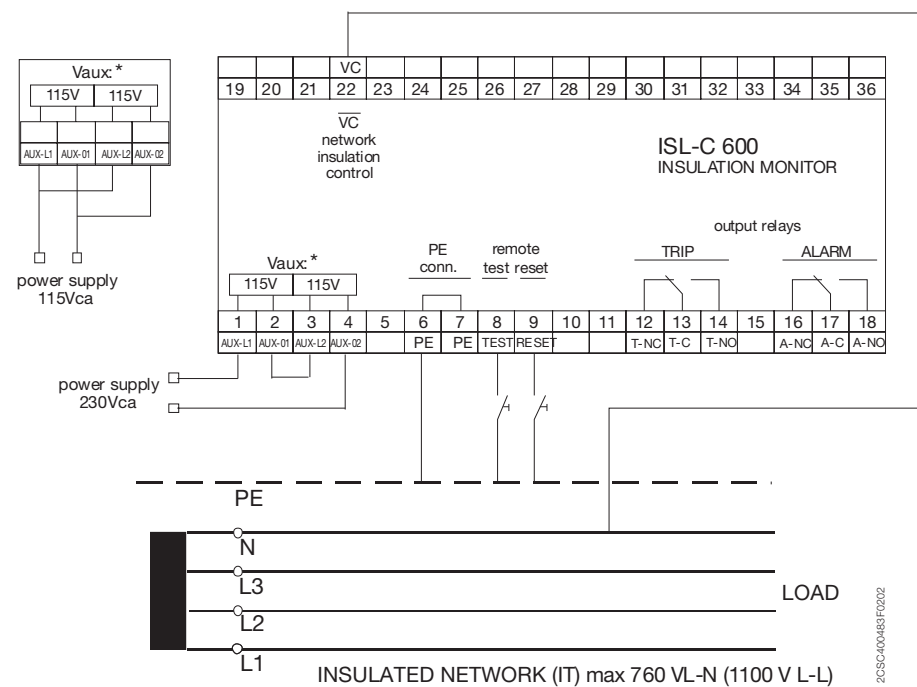

Protection and safety technical details

Insulation monitoring devices

ISL-MOT 1000

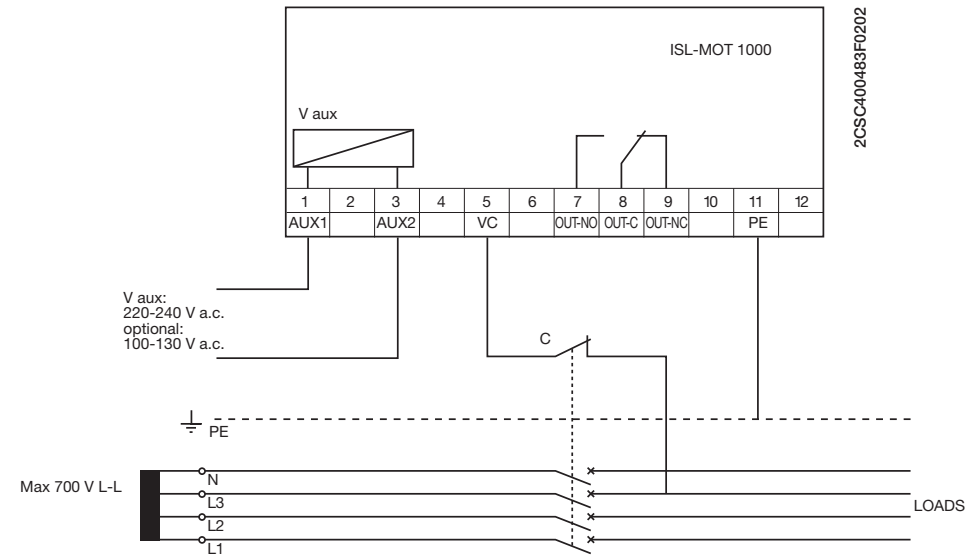

MICROSWITCH SETTINGS

The front microswitches are used for adjusting the insulation threshold level between 0.1 and 10 MΩ. A total of 7 microswitches are used, divided into two groups as shown below:

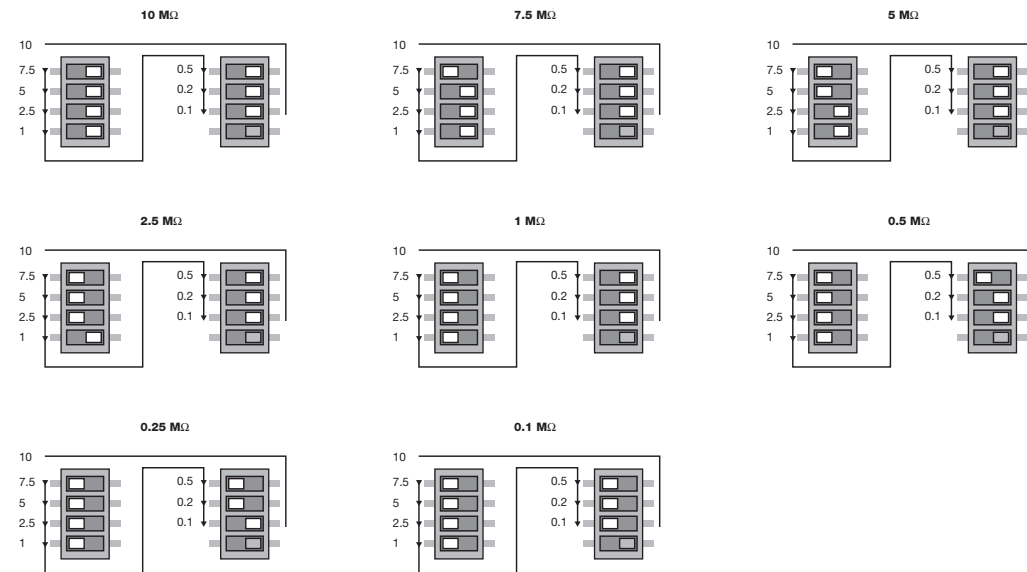

Operating principle

In IT electrical distribution systems that supply critical applications, where operational continuity is essential, ISL insulation monitoring devices assure continuous surveillance to promptly detect any insulation loss.

Application environments

All IT distribution systems in which operational continuity is a critical factor, and in particular:

- 24-28 V, 100-144 V and 220 V d.c. networks
- 24-48 V, 100-144 V and 380-415 V a.c. networks
- 20-700 V a.c./d.c. voltageless networks

Example of installation

ISL-MOT 1000 is suitable for preventive protection of voltageless circuits such as alarm and fire-fighting systems, pumps, etc.

ISL-MOT 1000 continually monitors the insulation level between the line and earth, to guarantee that the system will function correctly when needed.

The trip threshold is programmable, and insulation loss can be signalled via a change-over contact, which can also be used for switching loads.

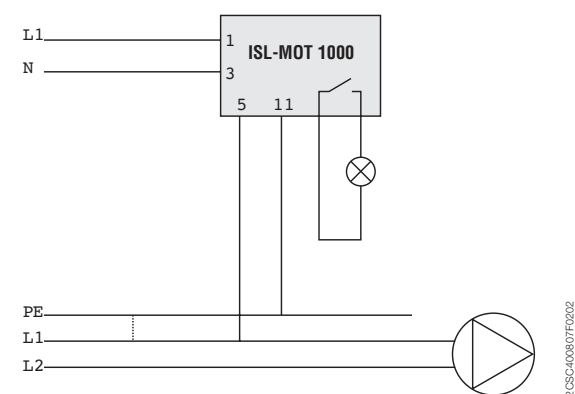
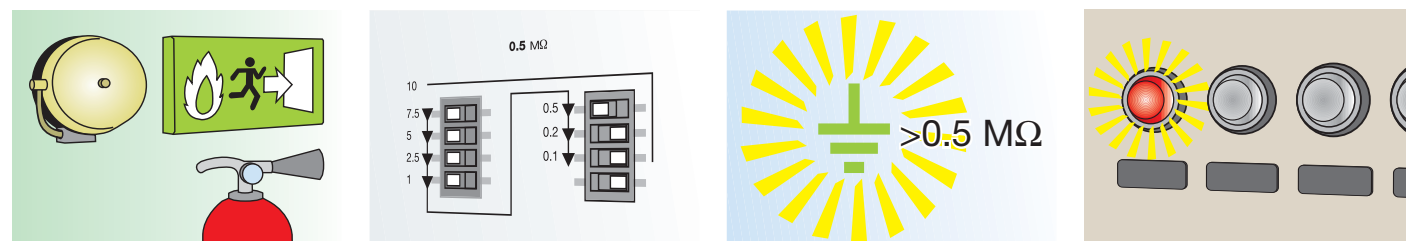

Command and signalling technical details

E 200 switches

E200 Short-circuit withstand capacity

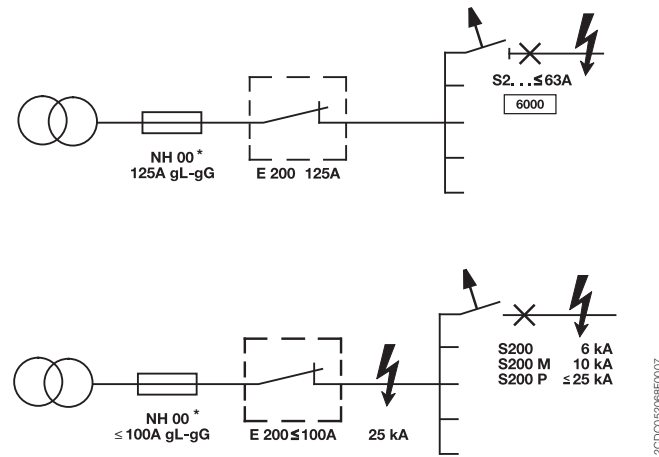

Assembling of S2C-H 6R and E 200

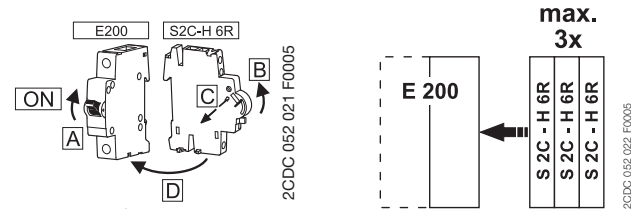

E 200 DC switching capacity

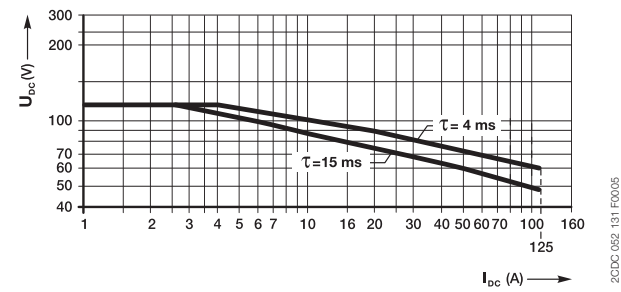

Command and signalling technical details

E 463 switches

E463 / E480 Short-circuit withstand capacity

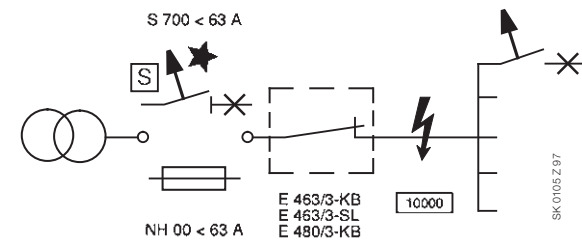

Command and signalling technical details

E 210 switches

DC switching capacity E211 16A

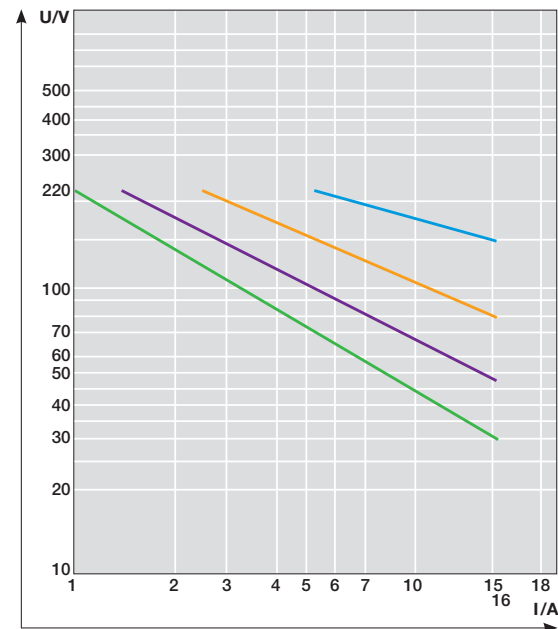

DC switching capacity E211 25A

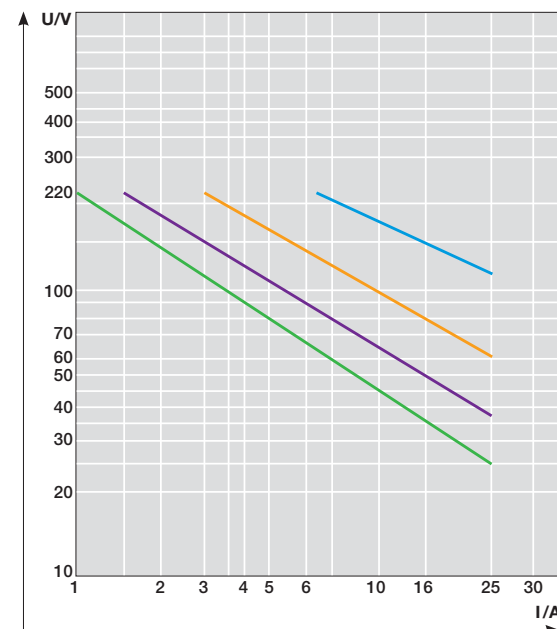

DC switching capacity E211 32A

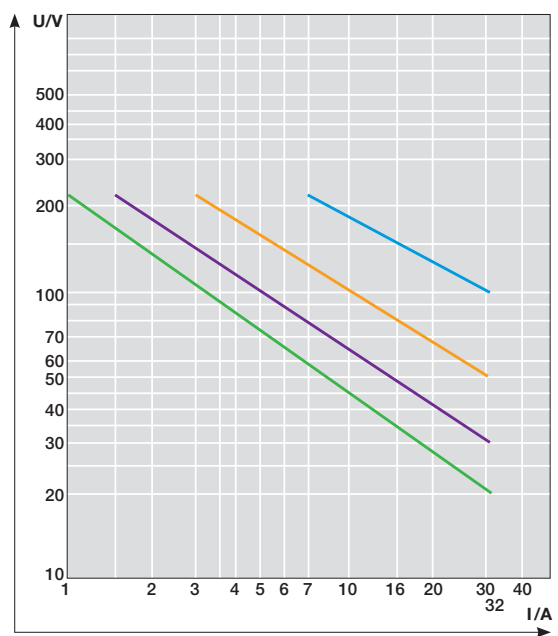

- Ohmic load
 - Normally-open contact
 - Normally-closed contact
- Load with time constant $t = 15\text{ms}$ (inductive load)
 - Normally-open contact
 - Normally-closed contact

Command and signalling technical details

ESB installation contactors

Certifications and Approvals



Mounting positions

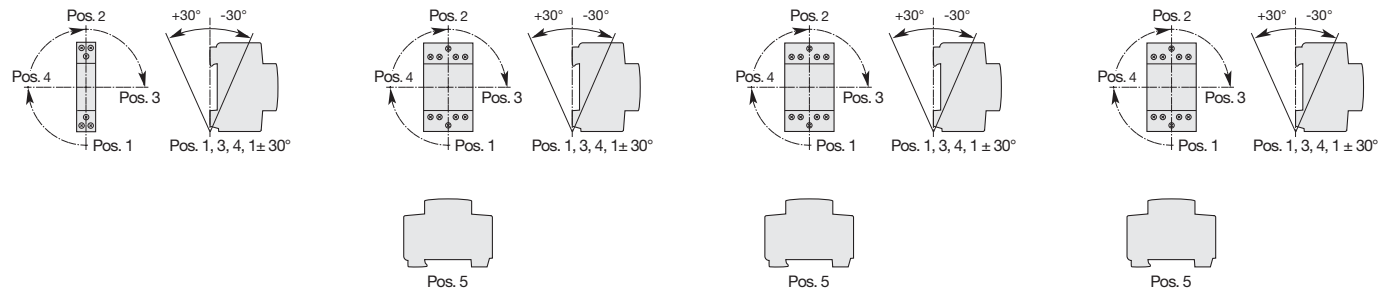

Electrical durability

AC-1 / 400 V / 3-phase for ESB 20, 24, 40, 63

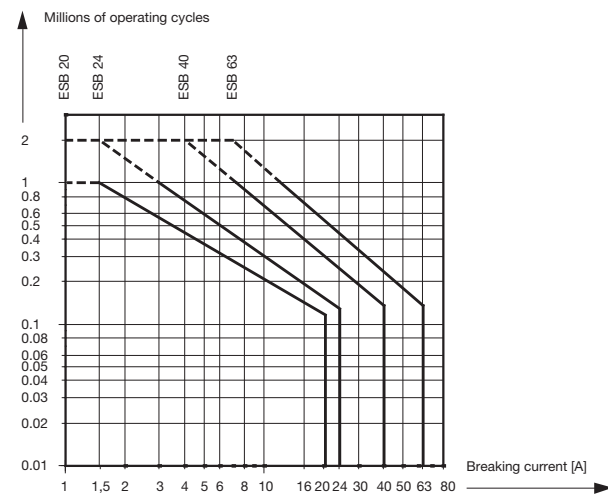

AC-3 / 400 V / 3-phase for ESB 24, 40, 63

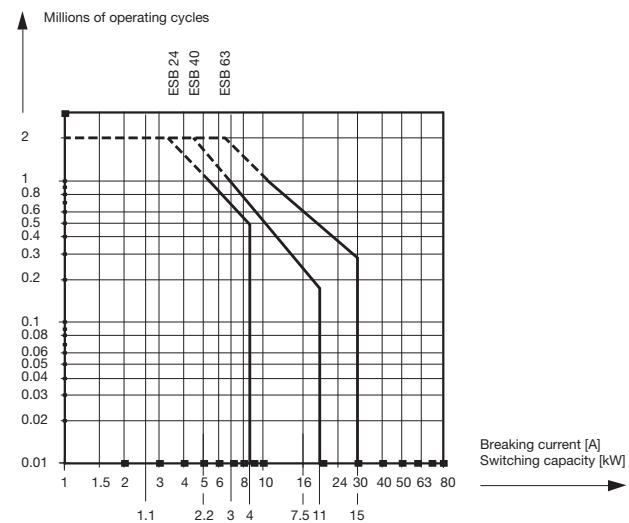

Command and signalling technical details EN installation contactors

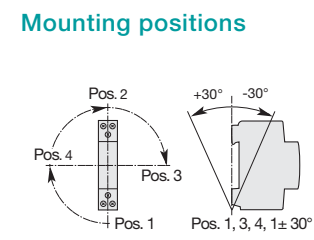
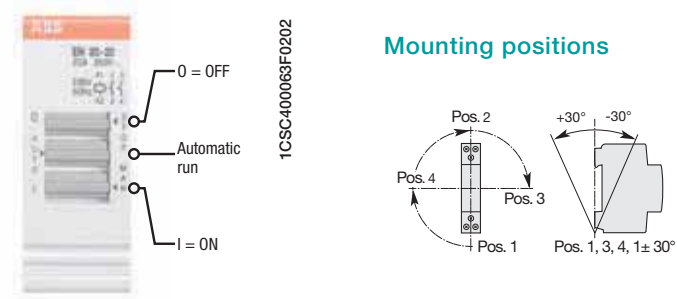

Sealing cover



Auxiliary Contact Blocks

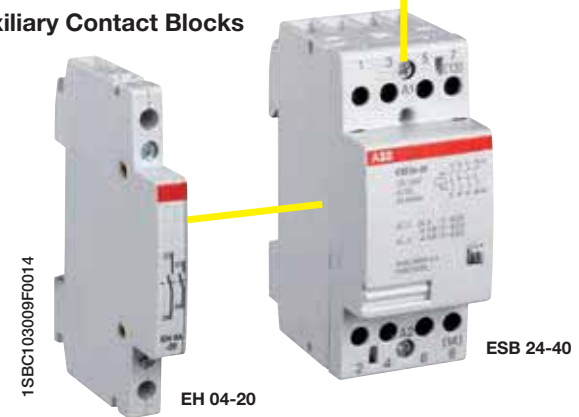





Command and signalling technical details

E 259 installation relays

E 259 INSTALLATION RELAYS

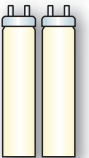
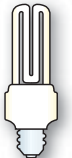
Information about lamp insertion between phase and neutral

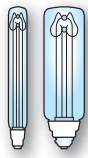
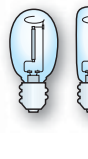
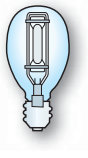
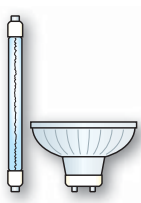
	Power [W]	Number of switchable lamps
Incandescent lamps (230 V a.c.)		
	15	120
	25	72
	40	45
	60	30
	75	24
	100	18
	150	12
	200	9
	300	6
	500	3
Fluorescent lamps without power factor capacitors		
	18	50
	36	25
	40	23
	58	16
	65	13
Fluorescent lamps with power factor capacitors		
	18	17
	36	13
	40	12
	58	8
	65	7
Fluorescent twin-lamps		
	2 x 18	50
	2 x 36	25
	2 x 40	23
	2 x 58	16
	2 x 65	13
Lamps with electronic reactor		
	1 x 18	38
	1 x 36	30
	1 x 58	17
	2 x 18	19
	2 x 36	15
	2 x 58	8

	Power [W]	Number of switchable lamps
Low pressure sodium vapor lamps (SOX)		
	55	6
	90	4
	135	3
	180	2
	185	2
High pressure sodium vapor lamps (NAV)		
	70	10
	150	5
	250	3
	400	2
	1000	-
Metal halide and high pressure mercury vapor lamps (HQL)		
	50	16
	80	10
	125	7
	250	3
	400	2
	1000	-
230 V halogen lamps (HQI)		
	150	12
	250	7
	300	6
	400	4
	500	3
	1000	2
Very low voltage halogen lamps (12 or 24 V AC)		
	20	72
	50	29
	75	20
	100	15
	150	10
	200	7
	300	5

Operating principle

The E 259 installation relays are 16 A contactors specifically engineered for residential and commercial applications and are available in a wide range of contact layouts and coil voltages.

Application environments

The E 259 installation relays are particularly indicated in residential and commercial buildings for lighting control.

Example of installation

As shown in the diagrams, one of the possible applications is to mount the E 259 16-11 installation relay with a NO and a NC contact inside the electric system of a hospital ward. The first control sent through a switch to the command circuit of the relay will turn off the ceiling lights and turn on the corridor lamps, while the second command returns to the previous state.

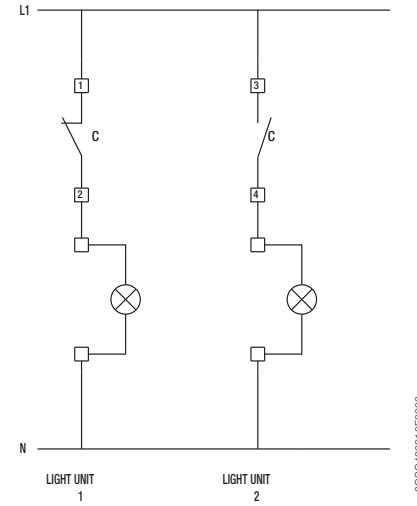
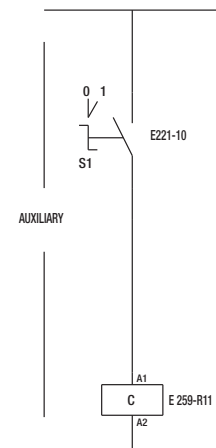
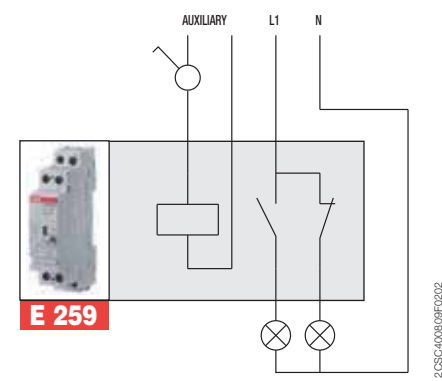
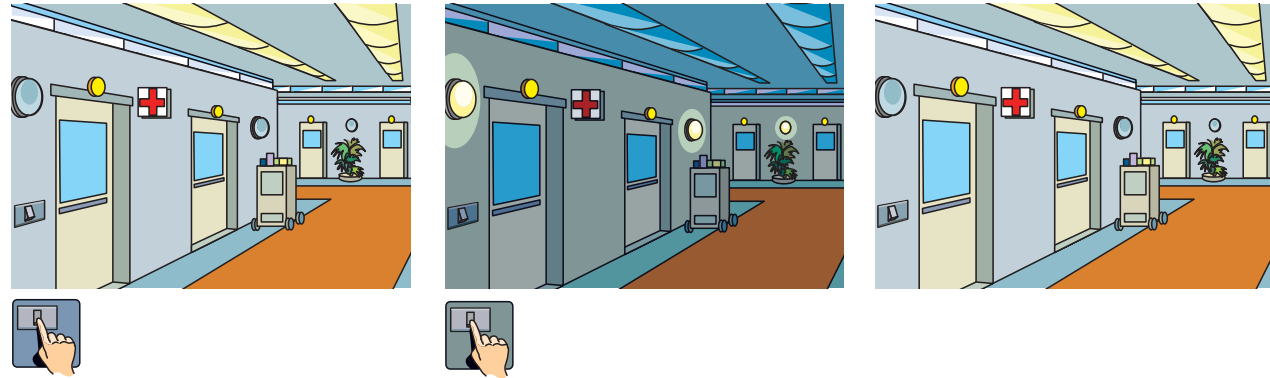







Command and signalling technical details

E 250 latching relays

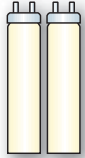
E 250 LATCHING RELAYS

Information about lamp insertion between phase and neutral

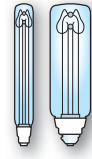
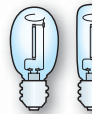
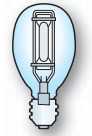
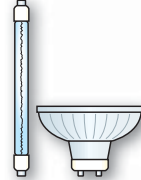
	Power	Number of switchable lamps	
	[W]	E 250 - 16 A	E 250 - 32 A
Incandescent lamps (230 V a.c.)			
	15	200	266
	25	120	160
	40	75	102
	60	50	65
	75	40	52
	100	30	40
	150	20	26
	200	15	20
	300	9	12
	500	5	7
Fluorescent lamps without power factor capacitors			
	18	81	110
	36	44	58
	40	38	53
	58	29	35
	65	26	34
Fluorescent lamps with power factor capacitors			
	18	103	132
	36	63	81
	40	40	77
	58	41	52
	65	37	48
Fluorescent twin-lamps			
	2 x 18	82	110
	2 x 36	41	55
	2 x 40	35	50
	2 x 58	23	30
	2 x 65	22	30
Lamps with electronic reactor			
	18	83	112
	36	46	61
	58	31	38
	2 x 18	40	56
	2 x 36	23	30
	2 x 58	14	19

	Power	Number of switchable lamps	
	[W]	E 250 - 16 A	E 250 - 32 A
Low pressure sodium vapor lamps (SOX)			
	55	27	36
	90	16	22
	135	11	14
	180	8	11
	185	8	10
High pressure sodium vapor lamps (NAV)			
	70	15	18
	150	8	10
	250	4	6
	400	3	4
	1000	1	1
Metal halide and high pressure mercury vapor lamps (HQL)			
	50	30	40
	80	18	25
	125	12	16
	250	6	8
	400	3	5
	1000	1	2
230 V halogen lamps (HQL)			
	150	20	27
	250	12	16
	300	10	13
	400	7	10
	500	6	8
	1000	3	4
Very low voltage halogen lamps (12 or 24 V AC)			
	20	116	160
	50	46	64
	75	31	42
	100	24	32
	150	15	21
	200	12	16
300	7	10	

Use of lighted pushbuttons

Latching relays can be controlled through lighted pushbuttons, without any limitations in terms of connection of three-terminal types.

In two-terminals pushbuttons the current that flows through pushbutton lamps can trigger an unwanted activation; in order to avoid this there is the E 250 CP compensation module, installed in parallel on the coil.

Number of E 250 CP compensation modules	Number of connectable lighted pushbuttons	
	1P – 2P types	3P – 4P types
0	8	9
1	18	22
2	45	38

Maximum length of very low voltage connections

Too long feeding cables can cause a drop in the supply voltage, which could be inadequate for guaranteeing standard operating conditions of latching relays, in particular for very low voltage types.

For this reason the wiring must not exceed the maximum lengths (outward and return) shown in the table.

UN	0.5 mm ²	0.75 mm ²	1 mm ²	1.5 mm ²
8 V~	28 m	41 m	55 m	90 m
12 V~	68 m	102 m	136 m	224 m
24 V~	272 m	412 m	548 m	896 m
48 V~	1096 m	1640 m	2184 m	3584 m

Relay DC switching capacity

V DC	E 259	E 250 (16 A a.c.)	E 250 (32 A a.c.)
≤ 12	16	16	32
24	16	16	20
30	16	16	16
48	10	10	10
60	8	8	8
110	5	5	5
230	2	2	2

10

E250-series and E259-series DC switching capacity

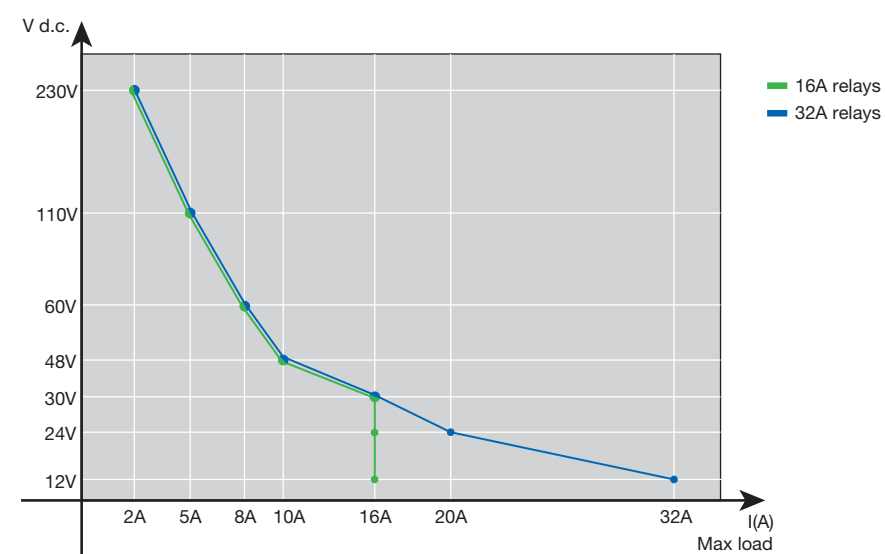

Command and signalling technical details

E 250 latching relays

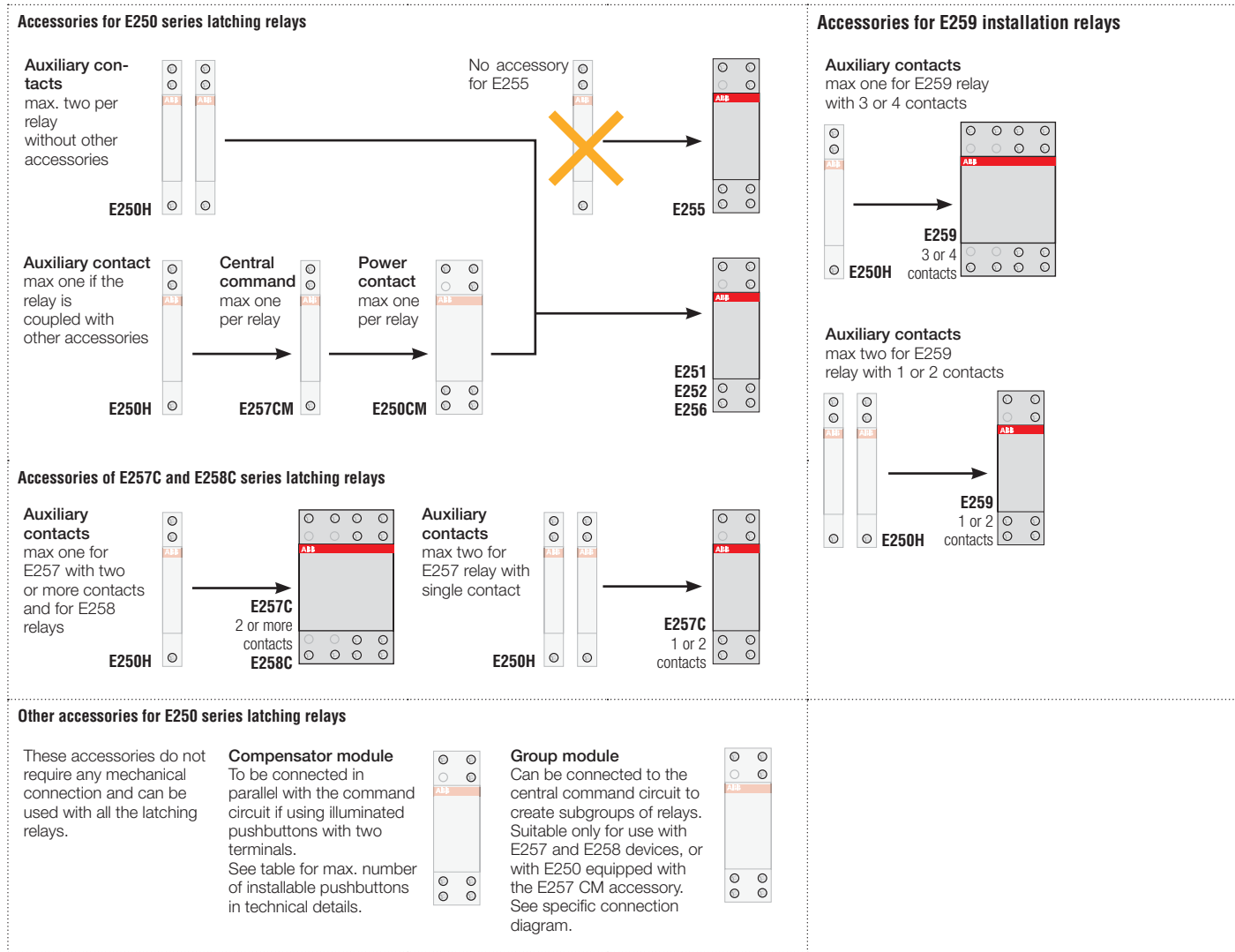

10

E 257 - local and central command by push-buttons

Each local push-button controls a single relay. Pressing the central ON/OFF button puts all the relays in the ON (/OFF) position irrespective of their previous state.

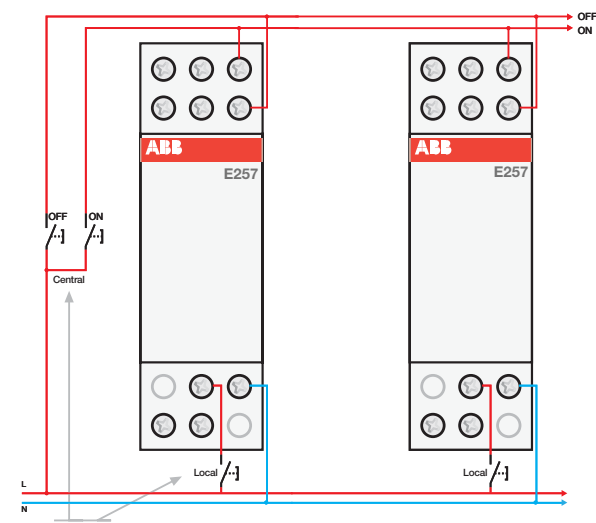

Connect the push-buttons on the same line for both local and central command. With alternating current use either the phase (L) or neutral (N). With direct current the positive (+) pole must be used.

E 257 - permanently supplied

It is possible to permanently supply the central command, for example using a change-over switch to control the relay.

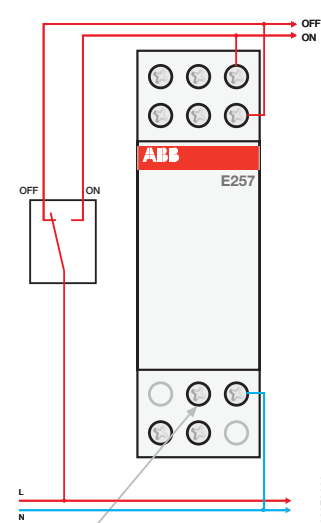

In this configuration a local actuating coil cannot be used.

Grouped central command: connection diagram for E 250 GM

The E250 GM module allows the creation of subgroups of relays with a central command for each group of relays and a general command. This function requires using an E 250 GM for each subgroup.

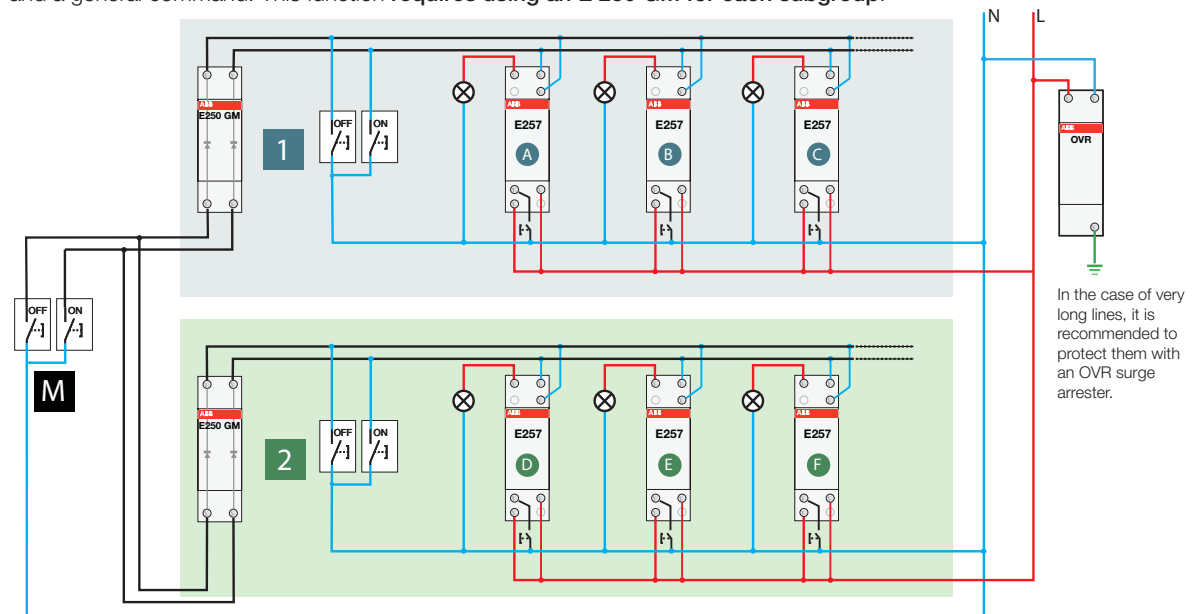

Local: each relay can be individually commanded from the local pushbuttons.

Group: each group can be centrally commanded, therefore the ON/OFF **1** button controls relays **A B C** while the ON/OFF **2** button controls relays **D E F**.

General: the ON/OFF buttons **M** command both groups **1 2** at simultaneously, allowing all the relays to be commanded.

1CSC400068R/202

Command and signalling technical details

E 250 latching relays

E 255 latching relays with sequential contacts

Operating principle

The two contacts of the E 255 latching relays switch independently their position (open/closed) at each impulse according to a preset sequence in the control circuit.

Application environments

The E 255 latching relays are particularly indicated in environments and situations requiring the load sequential control through a single pushbutton circuit (offices, restaurants, etc.).

Example of installation

As shown in the diagrams, one of the possible applications is to mount the E 255 latching relays inside the lighting system of an art gallery. The first pushbutton impulse will switch on the ceiling lights, the second triggers the wall lamps, the third switches off the ceiling lights and the fourth switches off the wall lamps.

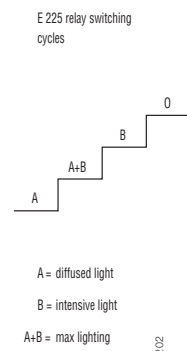
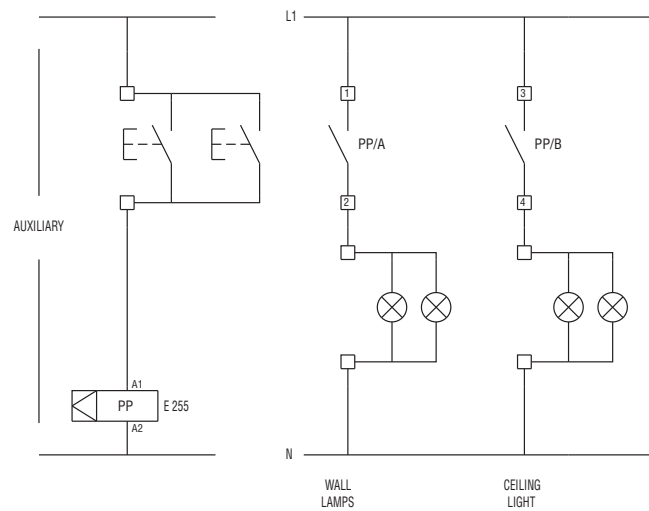
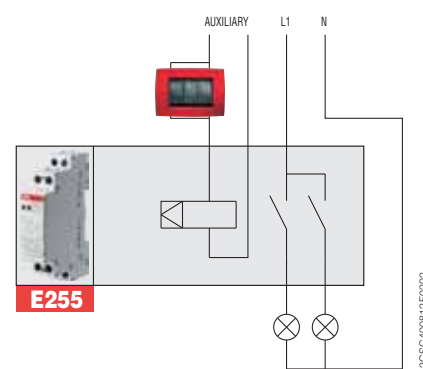
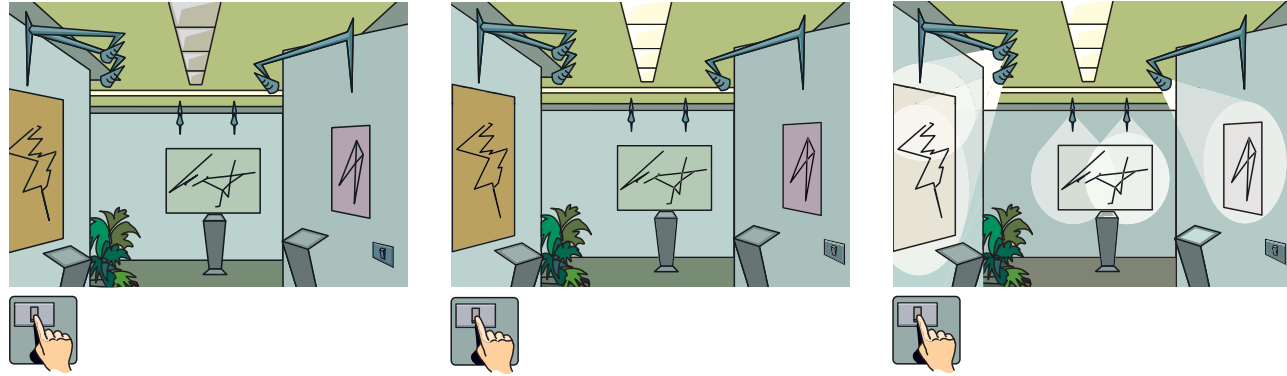

E 257 latching relay with central command

Operating principle

The E257 relays have a central command that allows the contacts of all the relays to be brought to the same position by sending a pulse to the ON (or OFF) circuit.

Application environments

The E257 relays are suitable for applications in which loads (i.e. in a lighting circuit) are controlled through multiple relays, commanded both locally and through a central command for resetting all the relays.

Example of installation

As illustrated in the diagrams, the E257 relays (installed in the panel of a yacht) allow loads to be controlled from the main panel through pulses sent to the local coil of each E257.

In the event of an accidental reset of the main control panel, it will lose track of the individual state of the E257 relays. For this reason, the reboot procedure requires all the E257 relays to be reset to OFF.

The main control panel accomplishes this by sending a pulse to all the OFF contacts of the E257 relays, through a type E259 support relay, thus bringing all the relays to the same state.

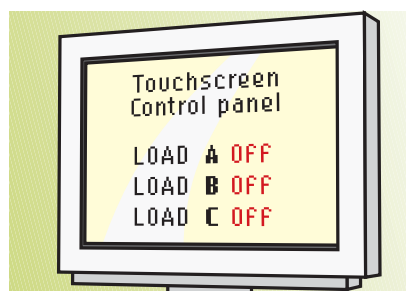
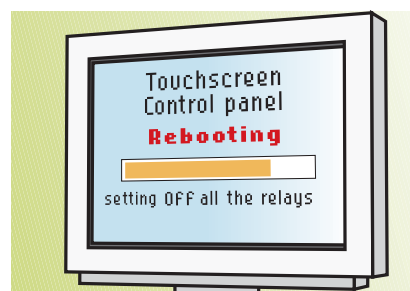
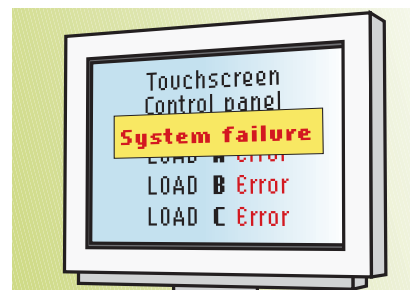
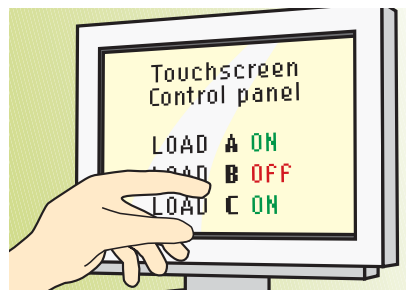
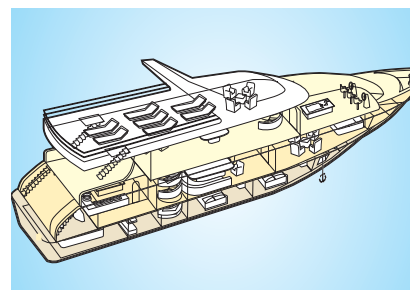

Command and signalling technical details

E 250 latching relays

E 257 latching relay with central command

Operating principle

The E 257 latching relay is controlled by two circuits. The first is operated by a button and causes it to switch its contacts (open/closed). The second circuit instead changes the state of the relay's contacts to open or closed irrespective of their previous state.

Application environments

The E 257 latching relay with central command is particularly suited to those situations which require sending a single command to switch on/off multiple loads irrespective of the preceding open/closed state of their circuits (lighting circuits in office complexes, hotels, museums, theatres, etc).

Example of installation

As illustrated in the figures, one example application is to install the E 257 latching relay with central command in the electrical system of an office complex, in which the lights of individual offices can be turned on or off either from switches in the various rooms, or by operating on all the circuits simultaneously from the porter's lodge or other central location.

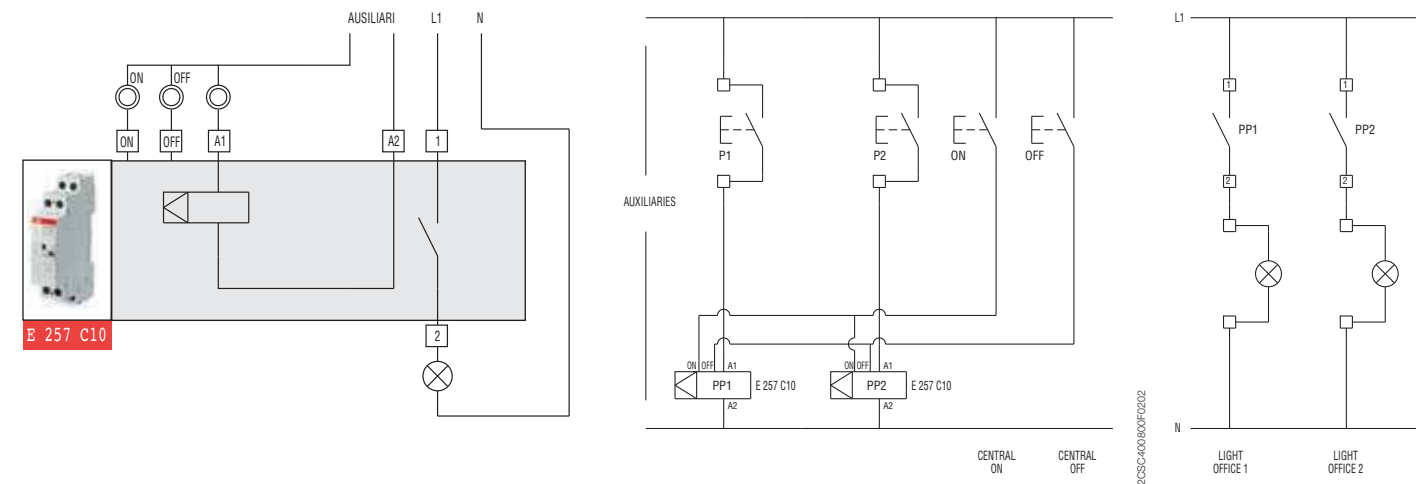
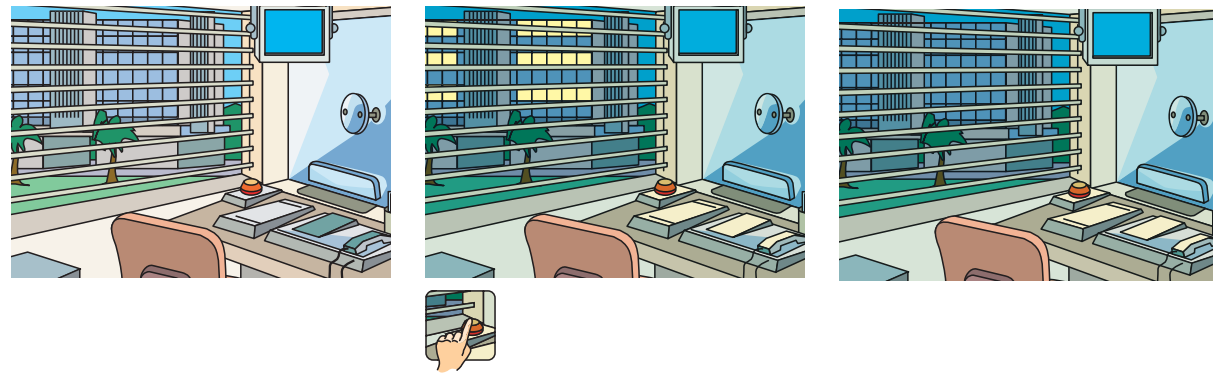

Command and signalling technical details

E 260 latching relays

E 261-SRV

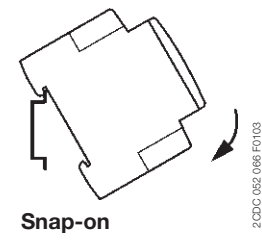
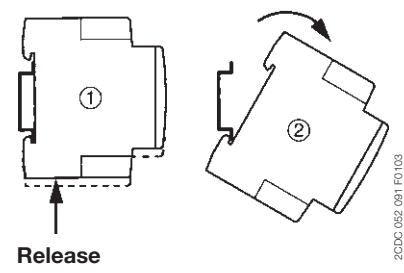
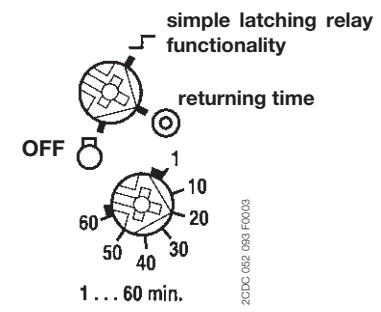

Command and signalling technical details STD dimmers

Control power
 STD 50-3: 20-500 W/VA
 STD 50-4: 40-420 W/VA

Influence of ambient temperature on the control power
 The certified rated power is indicated on the dimmer.
 Where higher ambient temperatures occur, reduce values as
 is specified in the diagram.
 At 50 °C /122°F ambient temperature, the permissible load
 drops to 57%.

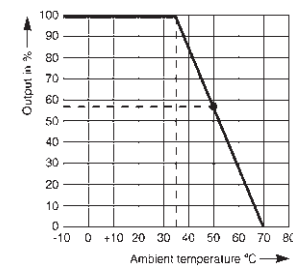

SK 045 Z 99

Electronic potentiometer

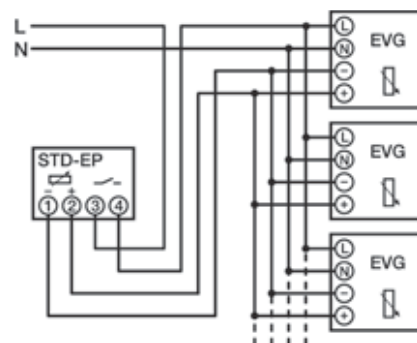

Dimmer STD 50-4 in two-way circuit, iv halogen lamps via electronic transformer

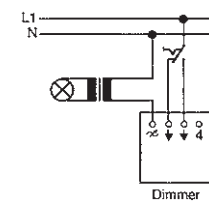

SK 0190 Z 99

Brightness control of fluorescent lamps with 1 -10 V control input. Control of more than one memory touch controller STD-MTS via one push-button.

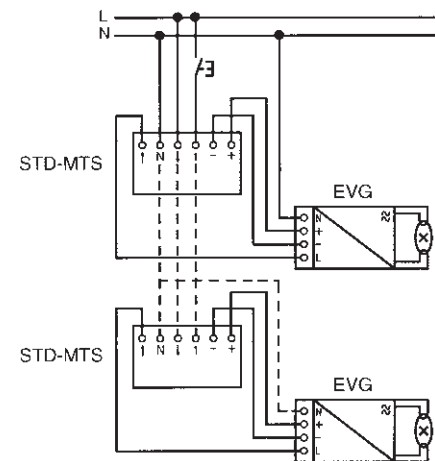

SK 0189 Z 99

Brightness control of a fluorescent lamp with 1 -10 V DC control input with memory touch controller STD-MTS with external pushbutton, e.g. E 225

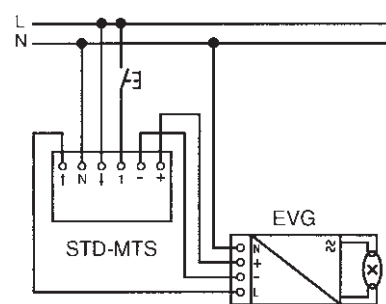

SK 0190 Z 99

Connected load / ambient temperature diagram

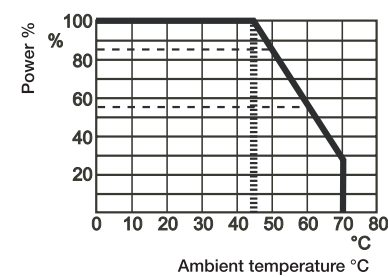

2CSC 052 081 F0207

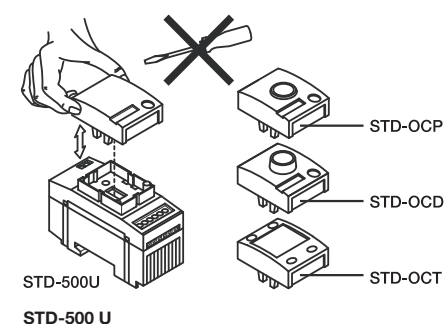

2CSC 052 138 F0006

Command and signalling technical details

Modular transformers

Modular transformers

The range of System pro M compact modular transformers consists of a series of safety transformers for general use, TS-C with 12-24 V secondary and powers of 25, 40 and 63 VA, the TM range of bell transformers, with secondary voltages of 12-24 V and a maximum rated power of 10-15-30-40 VA, and the TS range of bell transformers, with secondary voltages of 8-12-24 V and a rated secondary power of 8-16-24 VA (some TS types are available with an integrated switch ON/OFF).

Modular safety transformers for general use TS-C, continuous functioning

Standard: IEC EN 61558-2-6

The TS-C safety transformer is an insulation transformer for supplying SELV circuits (with extremely low safety voltage) or PELV circuits (with extremely low protection voltage). In contrast to the bell transformers, TS-C transformers can be used to continuously supply low voltage loads and they have a reduced voltage drop value. Even after a short-circuit they maintain their temperature below the specified limits. In addition they are equipped with a thermal sensitive restoring device which automatically restores power when the transformer is sufficiently cooled down or the overload has been removed.

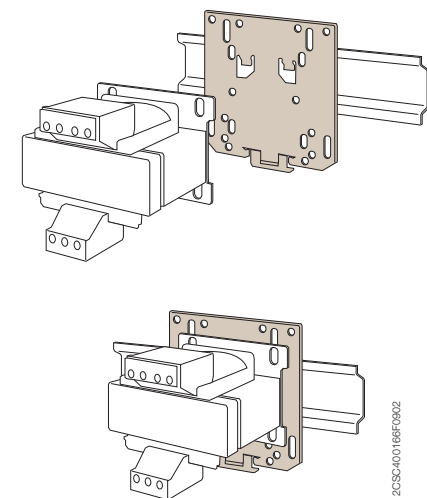

Fail proof bell transformers TM series

Standard: IEC EN 61558-2-8

Following a short-circuit or an overload use the products may not continue to operate, but they continue assuring separation between primary and secondary circuits, safeguarding the user and adjacent electric parts: the serie includes 8 models with 10, 15, 30 and 40 VA power and 4, 8, 12 and 24 V output voltages.

Non-inherently short-circuit proof bell transformers TS series

Standard: IEC EN 61558-2-8

Even after a short-circuit they maintain their temperature below the specified limits. In fact they are equipped with a thermal protection device which automatically restores power when the transformer is sufficiently cooled down or the overload has been removed. The TS series includes 10 models with 8, 16, 24 VA power and output voltages of 4, 6, 8 and 12 and 24 V AC.

The TS8/SW series is equipped with an ON-OFF switch on the front side that allows the control of the load connected to transformer's secondary circuit. It includes 5 models with 8 VA power and output voltages of 4, 6, 8 and 12 V.

Command and signalling technical details

Control, isolating and safety transformers

Control, isolating and safety transformers

The choice of supply voltage for a control circuit must take into account two factors: the safety of users, and the functional reliability of the circuits, which can be dependent on the voltage drop.

Control transformer

Reference standard: CEI EN 61558-2-2:

Transformer for supplying control circuits, for example commands, signalling, interlocks, etc.

Isolating transformer

Reference standard: CEI EN 61558-2-4:

Transformer in which the primary and secondary windings are electrically separated by a double or reinforced insulation, to protect the circuit supplied by the secondary against hazards due to accidental simultaneous contact with earth and live parts, or grounded parts that may become live in the event of an insulation fault.

Safety transformer

Reference standard: CEI EN 61558-2-6:

Isolation transformer for supplying safety extra low voltage circuits (<50 V on no load). Accidental contact with the secondary winding phases can be withstood without any danger.

Impregnation and tropicalization

ABB transformers are fully impregnated using a thermal class F resin. This treatment improves the characteristics of the insulating materials, making the transformers suitable for installation in harsh environments. It also augments heat exchanges, thereby lowering the transformer temperature, prevents moisture from penetrating the windings and core, and minimises vibrations and the resultant noise.

Insulation classes

The duration of the insulation in the products depends on many factors, and in cases where the insulating material electrically segregates live parts from accessible parts, any alteration in its characteristics may put the safety of the user at risk.

The standards prescribe maximum temperature limits for transformer windings as a function of the insulation class. ABB transformers are constructed using class B materials. The maximum permitted ambient temperature is specified on the transformer rating plate as well as on this catalog.

Insulation class	T MAX
A	100 °C
E	115 °C
B	120 °C
F	140 °C
H	165 °C

Protection of transformers

Protection on primary

On the primary side, the transformer cannot generate any overload by itself. During power up, however, a very high inrush current (approx. 25-30 In) is generated. Protections

should therefore be calibrated in order to prevent their tripping during the transformer connection phase. The most suitable types of protection are:

- aM fuses
- S202 miniature circuit breakers, D characteristic.

Minimum protection on primary

Transformer power (VA)		230 V single phase	400 V single phase
50	aM fuse	0.5 A	0.315 A
100	aM fuse	1 A	0.63 A
	Breaker capacity	1.6 A	1 A
	Trip characteristic	D	D
160	aM fuse	1.6 A	1 A
	Breaker capacity	3 A	2 A
	Trip characteristic	D	D
200	aM fuse	2 A	1.25 A
	Breaker capacity	3 A	2 A
	Trip characteristic	D	D
250	aM fuse	2.5 A	1.6 A
	Breaker capacity	4 A	3 A
	Trip characteristic	D	D
320	aM fuse	3.15 A	2 A
	Breaker capacity	5 A	3 A
	Trip characteristic	D	D
400	aM fuse	4 A	2.5 A
	Breaker capacity	8 A	5 A
	Trip characteristic	D	D
630	aM fuse	6.3 A	4 A
	Breaker capacity	13 A	8 A
	Trip characteristic	D	D
1000	aM fuse	10 A	6 A
	Breaker capacity	20 A	13 A
	Trip characteristic	D	D
1600	aM fuse	16 A	10 A
	Breaker capacity	32 A	20 A
	Trip characteristic	D	D
2000	aM fuse	20 A	12 A
	Breaker capacity	40 A	25 A
	Trip characteristic	D	D
2500	aM fuse	25 A	16 A
	Breaker capacity	50 A	32 A
	Trip characteristic	D	D

Notes:

The protection specified in the table is the minimum "recommended" for protecting the supply line.
The breaking capacity of the primary miniature circuit breakers is a function of the supply line.

Protection on secondary

The secondary circuit must be protected against overload and short-circuit. Moreover, additional protection may need to be adopted depending on the distribution system type.

- Overload: The tripping current value of the protection used should be equal to or lower than the secondary current of the transformer.

- Short-circuit: Any short-circuit in the most distant point of the line should make the protection device trip in less than 5 seconds (IEC 60364). The protection of the transformer and the protection of the line may coincide when the transformer supplies power to a single line and a full compatibility has been ensured. The suitable secondary protection can be found on the selection tables.

Command and signalling technical details

Control, isolating and safety transformers

Transformer			MS116 Motor starter			MS132 Motor starter		
Rated power (VA)	Input voltage (V)	Nominal Current (A)	Type	Ordering Code	Thermal curve setting	Type	Ordering Code	Thermal curve setting
50	230	0,22	MS116-1.0	1SAM250000R1005	0,63	MS132-1.0	1SAM350000R1005	0,63
100	230	0,43	MS116-1.6	1SAM250000R1006	1	MS132-1.6	1SAM350000R1006	1
160	230	0,7	MS116-2.5	1SAM250000R1007	1,6	MS132-2.5	1SAM350000R1007	1,6
200	230	0,87	MS116-4.0	1SAM250000R1008	2,5	MS132-4.0	1SAM350000R1008	2,5
250	230	1,09	MS116-4.0	1SAM250000R1008	2,5	MS132-4.0	1SAM350000R1008	2,5
320	230	1,39	MS116-6.3	1SAM250000R1009	4	MS132-6.3	1SAM350000R1009	4
400	230	1,74	MS116-10	1SAM250000R1010	4	MS132-6.3	1SAM350000R1009	4
630	230	2,74	MS116-10	1SAM250000R1010	6,3	MS132-10	1SAM350000R1010	6,3
1000	230	4,35	MS116-16	1SAM250000R1011	12,5	MS132-16	1SAM350000R1011	12,5
1600	230	6,96	MS116-20	1SAM250000R1013	20	MS132-25	1SAM350000R1014	20
50	400	0,13	MS116-0.63	1SAM250000R1004	0,4	MS132-0.63	1SAM350000R1004	0,4
100	400	0,25	MS116-1.0	1SAM250000R1005	0,63	MS132-1.0	1SAM350000R1005	0,63
160	400	0,4	MS116-2.5	1SAM250000R1007	1,6	MS132-2.5	1SAM350000R1007	1,6
200	400	0,5	MS116-2.5	1SAM250000R1007	1,6	MS132-2.5	1SAM350000R1007	1,6
250	400	0,63	MS116-2.5	1SAM250000R1007	1,6	MS132-2.5	1SAM350000R1007	1,6
320	400	0,8	MS116-4.0	1SAM250000R1008	2,5	MS132-4.0	1SAM350000R1008	2,5
400	400	1	MS116-6.3	1SAM250000R1009	2,5	MS132-4.0	1SAM350000R1008	2,5
630	400	1,58	MS116-10	1SAM250000R1010	4	MS132-6.3	1SAM350000R1009	4
1000	400	2,5	MS116-12	1SAM250000R1012	9	MS132-16	1SAM350000R1011	9
1600	400	4	MS116-12	1SAM250000R1012	12,5	MS132-16	1SAM350000R1011	12,5
2000	400	5	MS116-16	1SAM250000R1011	16	MS132-20	1SAM350000R1013	16
2500	400	6,25	MS116-20	1SAM250000R1013	20	MS132-25	1SAM350000R1014	20

10

Properties

Each type of transformer detailed in the table above can be supplied on the primary side with a line protected by the corresponding Manual Motor Starter.

The indicated devices are calibrated to prevent from tripping

during the transformer connection phase.

Caution: the motor starter do not protect the transformer, for this scope another compulsory protection must be installed on the secondary side as detailed on the transformers datasheet.

Wiring diagram with motorstarter

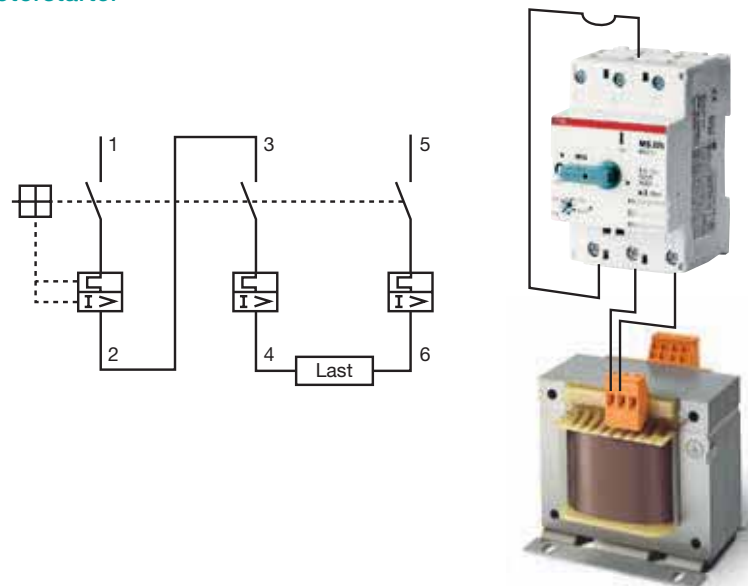

Power draw according to temperature and altitude

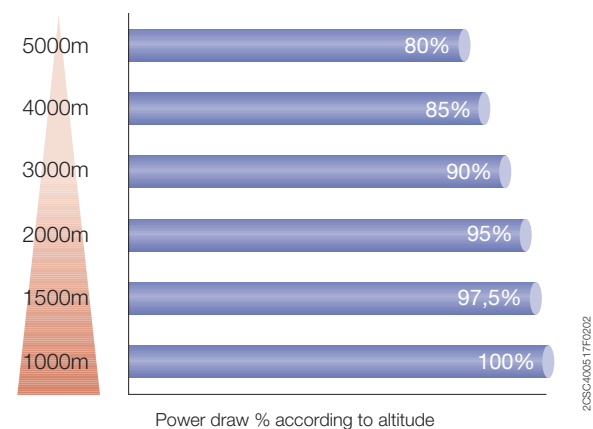
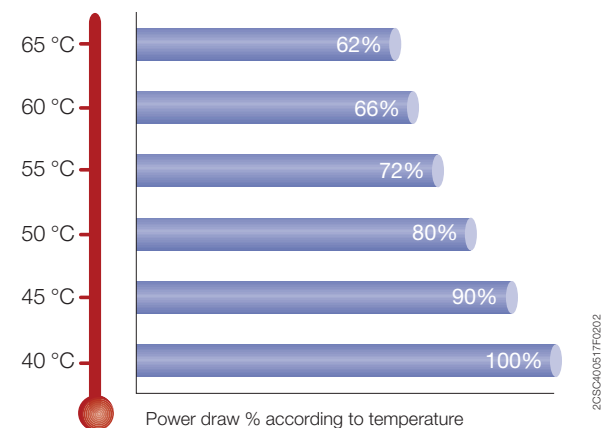

Voltage variation and short-circuit voltage data

Power (VA)	50	100	160	200	250	320	400	630	1000	1600	2000	2500
Vcc (%)	10,6	7,5	5,2	4,8	9,5	6,9	6	4	3,5	3	2,8	2,3
ΔV (%)	11	7,8	6	5,8	6,7	7	5,4	4,3	3,3	2,8	2	1,8

Transformer leaks

Power (VA)	No-load loss (W)	Load loss (W)
50	4	8,5
100	6,5	14
160	9	21
200	9	22
250	12	25
320	13	30
400	15	32
630	23	45
1000	36	60
1600	50	75
2000	60	90
2500	65	105

Command and signalling technical details

Control, isolating and safety transformers

Short circuit voltage, no-load output voltage variations and power loss data

Power	(VA)	50	100	160	200	250	320	400	630	1000	1600	2000	2500
V _{cc} ①	(%)	10.6	7.5	5.2	4.8	9.5	6.9	6	4	3.5	3	2.8	2.3
ΔV ②	(%)	11	7.8	6	5.8	6.7	7	5.4	4.3	3.3	2.8	2	1.8

① Percent of rated supply voltage; ② Percent of rated output voltage

Inrush power trend

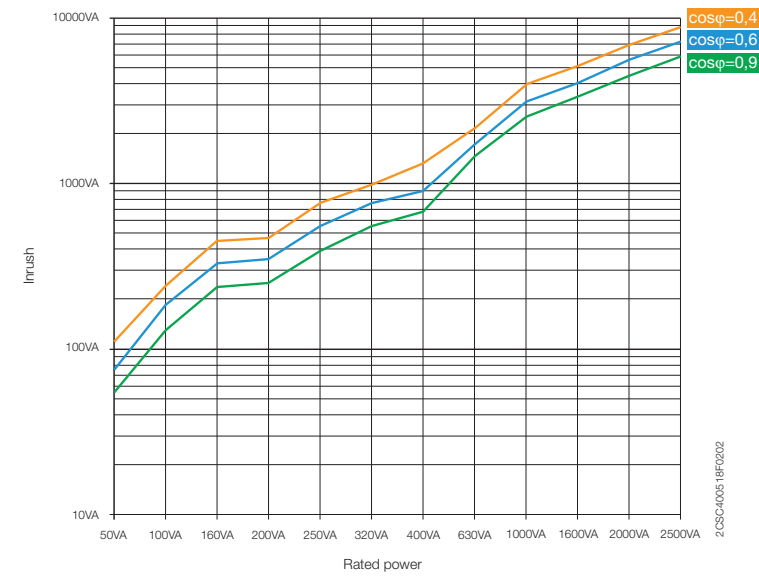

Admissible overload

If the transformer rated power is not drawn on a continuous basis, the transformer may be overloaded, according to the diagram below:

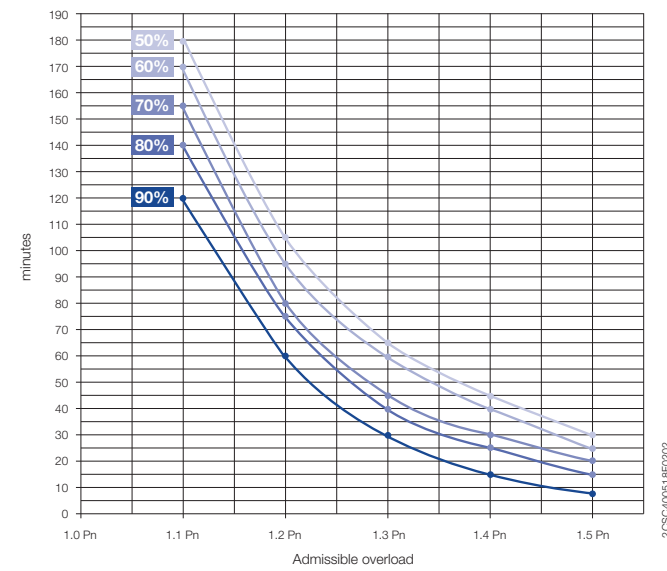

If a transformer is used with an intermittent duty cycle, it can be sized according to the formula:

$$P_{\text{transformer}} = P_{\text{intermittent}} \cdot \sqrt{\frac{\text{operating time}}{\text{total cycle time (operating + pause time)}}}$$

with time expressed in minutes

In control equipment, can I use the two secondary outputs of a single transformer to supply two different auxiliary circuits?

It is possible to simultaneously use both the secondary outputs of an ABB transformer to supply two circuits with different voltage ratings. The sum of the power draw from each circuit must not exceed the power rating of the transformer.

What type of transformer should be used to supply safety extra low voltage (SELV) circuits?

To construct a SELV circuit it is necessary to use a safety transformer compliant with the IEC EN 61558-2-6 standard, which guarantees both electrical separation of the systems by means of double insulation and the required extra low voltage (12-24 V±5%).

Can the secondary windings of two or more ABB single-phase transformers be connected in parallel?

It is possible to connect in parallel up to a maximum of 3 ABB transformers of equal power, bearing in mind that the total power which can be drawn will be equal to 90% of the sum of the individual powers. Pay great attention to terminal connection and, if necessary, test the circuit first in series and then in parallel.

In a piece of equipment supplied at 24 V a.c., I need to supply a cooling fan with a voltage rating of 230 V a.c. Can I use a transformer, supplying it from the secondary?

It is possible to supply the transformers on the secondary side, but due to the nature of their construction, the voltage output from the primary may vary by 10-30% relative to the rated voltage.

How can I quickly size the power of a transformer?

$$P = 0.8 (\Sigma P_m + \Sigma P_r + P_a)$$

ΣP_m = Sum of all continuous power consumptions of contactors

ΣP_r = Sum of all the resistive powers

P_a = Inrush power of the largest contactor

Use of two output voltages at the same time

Case A	Case B	Case C
Use of one output voltage: 24 V	Use of one output voltage: in 12 V	Use of two output voltages: Output 1: 24 V Output 2: 12 V

Command and signalling technical details

Control, isolating and safety transformers

Wiring rules for case c:

- The combined power delivered of the two outputs must not exceed the rated power.
- The power delivered on the output with less voltage must be at most:
 - lower voltage $P \leq 0,5 \times (\text{ratedP} - \text{higher voltageP})$
- The protection device for the secondary must be positioned at the point of the passing current of the two outputs and selected based on the higher voltage of the two loads:

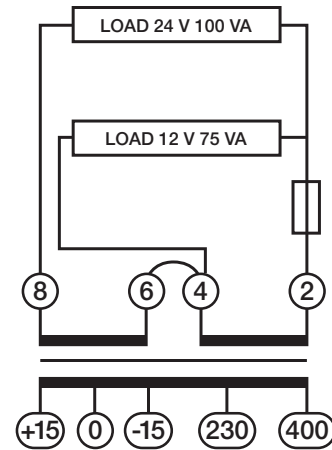

The fuse must be selected based on the higher voltage of the load and positioned in the point where the current of the two loads passes.

Example:

Transformer with ratedP 250 VA
12-24 V
Fuse 10 A gG or S 202 C10 automatic circuit breaker.

Examples:

Transformer with a rated power of 250 VA and 12/24 V secondary voltage:

	Power on 24 V output	Power on 12 V output	Comment
Es.1	250 VA	-	Case A is: the full power is delivered on the 24 V output
Es.2	-	250 VA	Case B is: the full power is delivered on the 12 V output
Es.3	100 VA	75 VA	Case C is: The power is delivered on the two outputs.
			Rule 1: Total power \leq ratedP Total power \leq 250 VA OK
			Rule 2: lower voltageP \leq $0,5 \times (\text{ratedP} - \text{higher voltageP})$ lower voltageP \leq $0,5 \times (250 - 100)$ lower voltageP \leq 75 VA OK

Connecting the transformer with the central point of the secondary to ground

Connection of the central point of the secondary of the transformer to ground makes it possible to decrease the potential of the secondary circuit in respect to ground, while maintaining the same output voltage.

Example:

with a transformer with 12/24 V output you can connect the central zero and deliver a voltage of -12 V / 0 V / +12 V. The voltage available to the secondary is always 24 V while the difference in potential in respect to the ground does not exceed 12 V, during normal operation.

Warning for grounding the central point for safety and insulating transformers:

If the lamination is grounded (with the Faston plug for example), the insulation properties of the safety and insulating transformers will be reduced: the insulation between the secondary and primary becomes one and not double/reinforced, thus decreasing the transformer properties.

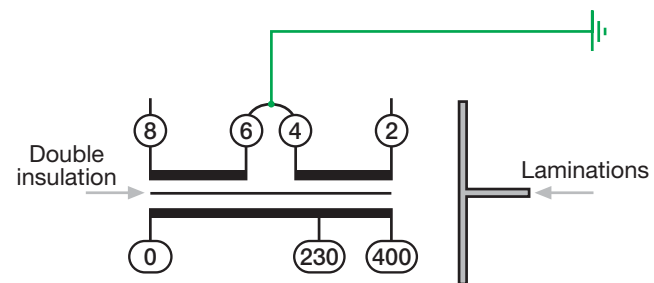

Lamination not grounded
Connection 12-0-12 preserving double insulation

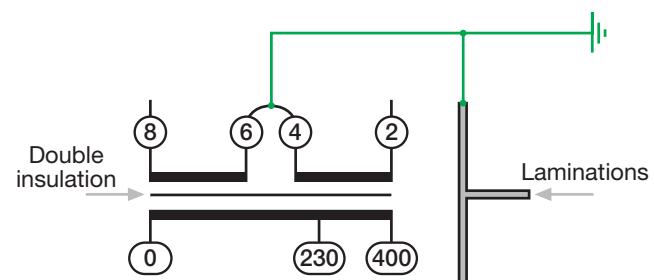

Lamination grounded
The insulation between the primary and secondary is reduced to that between the laminations and primary. Consequently, this assembly takes away the advantage of double insulation.

Command and signalling technical details

Modular sockets

Modular sockets

This table gives an indication of the voltage, frequency and modular socket solutions in each country.

Country	Volt.		Freq.		Modular sockets							
	110-130 V	220-250 V	50 Hz	60 Hz	M1011	M1363	M1170	M1173	M1174	M1175	M1176	M2071
Afghanistan		■	■				■	■	■	■		
Albania		■	■				■	■	■	■		
Algeria	■	■	■				■	■	■	■		
American Samoa	■	■		■			■	■	■	■	■	
Andorra		■	■				■	■	■	■		
Angola		■	■				■	■	■	■		
Argentina		■	■				■	■	■	■		■
Armenia		■	■				■	■	■	■		
Aruba	■	■		■			■	■	■	■		
Australia		■	■								■	
Austria		■	■				■	■	■	■		
Azerbaijan		■	■				■	■	■	■		
Azores		■	■				■	■	■	■		
Bahrain		■	■			■						
Balearic Islands		■	■				■	■	■	■		
Bangladesh		■	■			■						
Belarus		■	■				■	■	■	■		
Belgium		■	■							■		
Belize	■	■		■		■						
Benin		■	■							■		
Bhutan		■	■				■	■	■	■		
Bolivia	■	■	■				■	■	■	■		
Bosnia & Herzegovina		■	■				■	■	■	■		
Botswana		■	■			■						
Brazil	■	■	■				■	■	■	■		
Brunei		■	■			■						
Bulgaria		■	■				■	■	■	■		
Burkina Faso		■	■				■	■	■	■		
Burundi		■	■				■	■	■	■		
Cambodia		■	■			■						
Cameroon		■	■				■	■	■	■		
Canary Islands		■	■				■	■	■	■		
Cape Verde		■	■				■	■	■	■		
Central African Republic		■	■				■	■	■	■		
Chad		■	■				■	■	■	■		
Channel Islands		■	■			■						
Chile		■	■				■	■	■	■		
Comoros		■	■				■	■	■	■		
Congo Dem. Rep. (Zaire)		■	■				■	■	■	■		
Congo, People's Rep. of		■	■				■	■	■	■		
Cook Islands		■	■								■	
Croatia		■	■				■	■	■	■		
Cuba	■	■		■			■	■	■	■		
Cyprus		■	■				■	■	■	■		
Czech Republic		■	■							■		
Denmark		■	■				■	■	■	■		
Djibouti		■	■				■	■	■	■		
Dominica		■	■			■						

Main countries are highlighted

Please consider that installation rules may change in each country, and control the local regulations before installing.

Country	Volt.		Freq.		Modular sockets							
	110-130 V	220-250 V	50 Hz	60 Hz	M1011	M1363	M1170	M1173	M1174	M1175	M1176	M2071
East Timor		■	■				■	■	■	■	■	
Egypt		■	■				■	■	■	■		
Equatorial Guinea		■	■				■	■	■	■		
Eritrea		■	■				■	■	■	■		
Estonia		■	■				■	■	■	■		
Ethiopia		■	■			■				■		
Faeroe Islands		■	■				■	■	■	■		
Falkland Islands		■	■				■					
Fiji		■	■								■	
Finland		■	■				■	■	■	■		
France		■	■							■		
French Guyana	■	■					■	■	■	■		
Gabon		■	■				■	■	■	■		
Gambia		■	■				■					
Georgia		■	■				■	■	■	■		
Germany		■	■				■	■	■	■		
Ghana		■	■				■					
Gibraltar		■	■				■	■	■	■		
Greece		■	■				■	■	■	■		
Greenland		■	■				■	■	■	■		
Grenada		■	■				■					
Guadeloupe		■	■				■	■	■	■		
Guatemala	■	■		■			■				■	
Guinea		■	■				■	■	■	■		
Guinea-Bissau		■	■				■	■	■	■		
Guyana		■	■				■					
Hong Kong		■	■				■					
Hungary		■	■				■	■	■	■		
Iceland		■	■				■	■	■	■		
India		■	■				■	■	■	■		
Indonesia	■	■					■	■	■	■		
Iran		■	■				■	■	■	■		
Iraq		■	■				■	■	■	■		
Ireland		■	■				■					
Isle of Man		■	■				■	■	■	■		
Israel		■	■				■	■	■	■		
Italy		■	■				■	■	■	■		
Ivory Coast		■	■				■	■	■	■		
Jordan		■	■			■	■	■	■	■		
Kazakhstan		■	■				■	■	■	■		
Kenya		■	■				■					
Kiribati		■	■								■	
Korea, North		■		■			■	■	■	■		
Korea, South	■	■		■			■	■	■	■		
Kuwait		■	■				■	■	■	■		
Kyrgyzstan		■	■				■	■	■	■		
Laos		■	■				■	■	■	■		
Latvia		■	■				■	■	■	■		

Country	Volt.		Freq.		Modular sockets							
	110-130 V	220-250 V	50 Hz	60 Hz	M1011	M1163	M1170	M1173	M1174	M1175	M1176	M2071
Lebanon	■	■	■			■	■	■	■	■		
Lithuania		■	■				■	■	■	■		
Luxembourg		■	■				■	■	■	■		
Macau		■	■			■						
Macedonia		■	■				■	■	■	■		
Madagascar	■	■	■				■	■	■	■		
Madeira		■	■				■	■	■	■		
Malawi		■	■			■						
Malaysia		■	■			■						
Maldives		■	■		■	■	■					
Mali		■	■			■	■	■	■	■		
Malta		■	■			■						
Martinique		■	■			■	■	■	■	■		
Mauritania		■	■			■	■	■	■	■		
Mauritius		■	■			■	■	■	■	■		
Moldova		■	■			■	■	■	■	■		
Monaco		■	■			■	■	■	■	■		
Mongolia		■	■			■	■	■	■	■		
Montenegro		■	■			■	■	■	■	■		
Morocco	■	■	■			■	■	■	■	■		
Mozambique		■	■			■	■	■	■	■		
Myanmar (form. Burma)		■	■			■	■	■	■	■		
Nauru		■	■								■	
Nepal		■	■			■	■	■	■	■		
Netherlands		■	■			■	■	■	■	■		
Netherlands Antilles	■	■	■	■		■	■	■	■	■		
New Caledonia		■	■			■	■	■	■	■		
New Zealand		■	■								■	
Niger		■	■			■	■	■	■	■		
Nigeria		■	■			■						
Norway		■	■			■	■	■	■	■		
Oman		■	■			■						
Pakistan		■	■			■	■	■	■	■		
Papua New Guinea		■	■								■	
Paraguay		■	■			■	■	■	■	■		
Peru		■	■	■		■	■	■	■	■		
Philippines		■	■	■		■	■	■	■	■		
Poland		■	■			■	■	■	■	■		
Portugal		■	■			■	■	■	■	■		
Qatar		■	■			■						
Réunion Island		■	■			■		■				
Romania		■	■			■	■	■	■	■		

Country	Volt.		Freq.		Modular sockets							
	110-130 V	220-250 V	50 Hz	60 Hz	M1011	M1163	M1170	M1173	M1174	M1175	M1176	M2071
Russian Federation		■	■					■	■	■	■	
Rwanda		■	■			■		■	■	■	■	
Samoa		■	■					■	■	■	■	■
San Marino		■	■					■	■	■	■	
Saudi Arabia	■	■		■			■	■	■	■	■	
Senegal		■	■				■	■	■	■	■	
Serbia		■	■				■	■	■	■	■	
Seychelles		■	■			■						
Sierra Leone		■	■			■						
Singapore		■	■			■						
Slovakia		■	■						■	■		
Slovenia		■	■					■	■	■	■	
Somalia	■	■						■	■	■	■	
Spain		■	■					■	■	■	■	
Sri Lanka		■	■				■					
St. Kitts and Nevis		■	■	■			■					
St. Lucia		■	■				■					
St. Vincent		■	■						■	■	■	■
Sudan		■	■					■	■	■	■	
Suriname	■	■		■				■	■	■	■	
Sweden		■	■					■	■	■	■	
Swiss		■	■			■		■	■	■	■	
Syria		■	■					■	■	■	■	
Tahiti	■	■		■				■	■	■	■	
Tajikistan		■	■					■	■	■	■	
Tanzania		■	■					■				
Thailand		■	■					■	■	■	■	
Togo		■	■					■	■	■	■	
Tonga		■	■									■
Tunisia		■	■					■	■	■	■	
Turkey		■	■					■	■	■	■	
Turkmenistan		■	■					■	■	■	■	
Uganda		■	■					■				
Ukraine		■	■					■	■	■	■	
United Arab Emirates		■	■					■				
United Kingdom		■	■					■				
Uruguay		■	■					■	■	■	■	
Uzbekistan		■	■					■	■	■	■	
Vietnam	■	■	■					■	■	■	■	
Yemen, Rep. of		■	■					■				
Zambia		■	■					■	■	■	■	
Zimbabwe		■	■					■				

Fuse detail



2CSC400759F0001

Indicator light detail



2CSC400759F0001

Command and signalling technical details

Modular sockets

M1173-L-R red modular socket with indicator light

Operating principle

The colour-coded modular sockets are suitable wherever the specific purpose of a socket must be clearly indicated to unequivocally distinguish it from the other sockets in the panel. The indicator light signals the presence of the supply voltage, showing immediately whether or not the socket is under power.

Application environments

The modular sockets are suitable for installation in all electrical distribution or automation panels, to allow the connection of non-modular devices such as measuring or maintenance instruments, etc.

Example of installation

As illustrated in the figures, a modular socket can be used to supply non-modular devices directly from the electrical panel.

It is possible to use a red socket to indicate that it is supplied through a UPS and therefore should be used only in case of emergency.

Using a socket with indicator light also provides a clear indication of whether the upstream supply is connected.

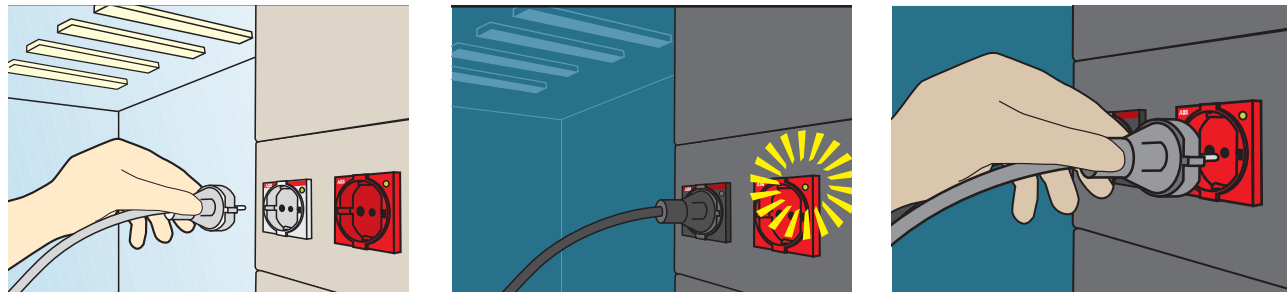

M1175-FL modular socket with fuse

Operating principle

The modular sockets with fuse are ideal wherever continuity of service is essential. The embedded fuse protecting the phase prevents tripping of the main protection switch in the event of a malfunction of the device plugged into the socket.

Application environments

The modular sockets are suitable for all electrical distribution or automation panels, to allow connection of non modular equipment such as measuring and maintenance instruments etc.

Example of installation

As illustrated in the figures, a modular socket allows to supply non modular devices directly from the electrical panel.

If the connected device malfunctions, there is the risk that the entire electrical system will be put out of service due to tripping of an MCB.

This is prevented by blowing of the fuse incorporated into the socket, thus assuring continuity of service.

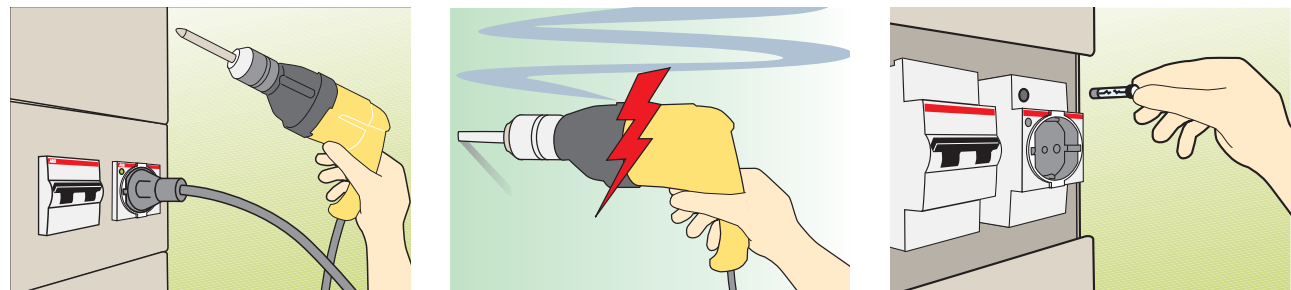

Control and automation technical details

AT and ATP electro-mechanical time switches

Time setting

AT2 - AT2-R

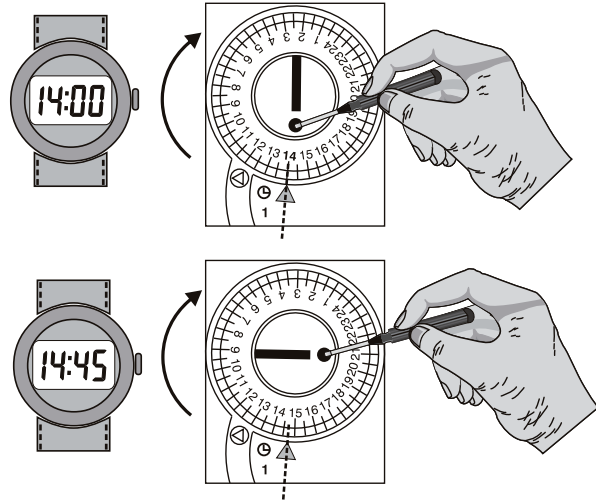

AT2-7R

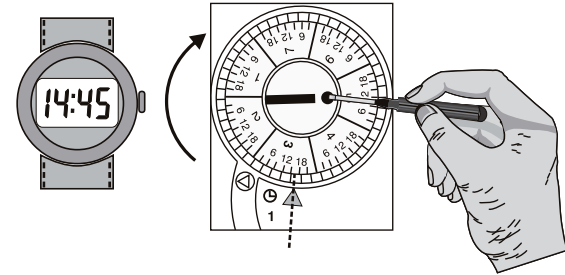

GB Example: 3 = Wednesday 14:45

1CSC40078F0202

Programming

Type mode

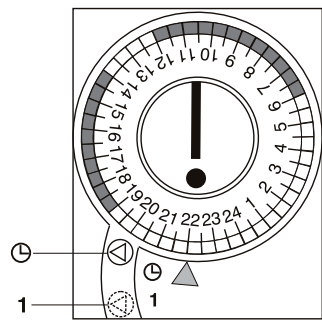

- ⊖ = Working according to the scheduled program
- 1 = Permanent ON

Switching dial

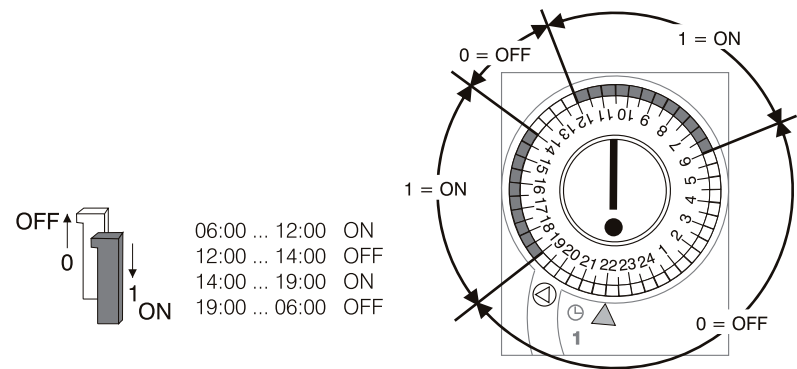

1CSC40078F0202

Operating principle

The AT electro-mechanical time switches enable to control the circuit opening/closing according to a daily or weekly program or to manually set permanent ON/OFF operation.

Application environments

The AT electro-mechanical time switches are particularly indicated in any environment and situation where it is necessary to program system load operation according to a daily or weekly frequency (shop lighting system, public buildings, heating systems, irrigation systems, etc.).

Example of installation

As shown in the diagrams, one of the possible applications is to mount the AT3-7R electro-mechanical time switch inside the power supply circuit of a golf field. In this case the device programming enables the daily activation of the irrigation system at a preset time

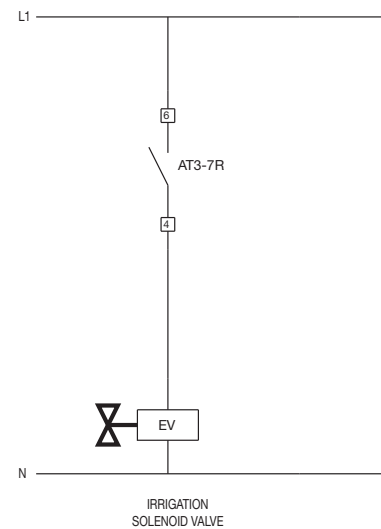
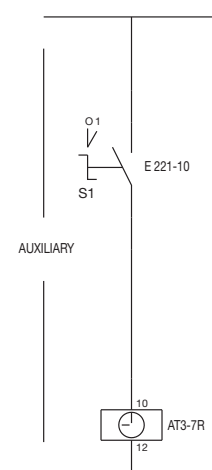
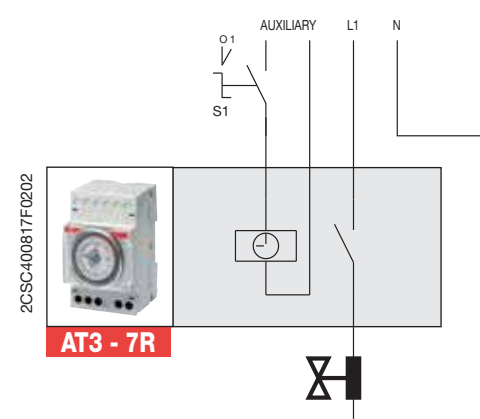
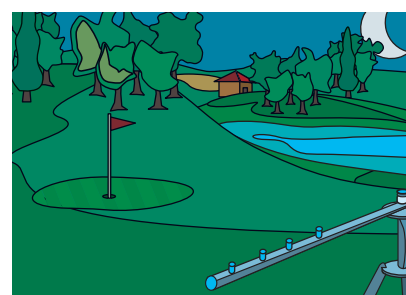

Control and automation technical details

AT and ATP electro-mechanical time switches

Operating principle

The ATP electro-mechanical switches enable to control the circuit opening/closing according to a daily or weekly program or to manually set permanent ON/OFF operation.

Application environments

The ATP electro-mechanical time switches are particularly indicated in any environment and situation where it is necessary to program system load operation according to a daily or weekly frequency (lighting system, heating systems, venting systems, etc.).

Example of installation

One of the possible applications is to mount the ATP-R near to the home boiler. In this case the device programming enables the heating activation at specific times during the day allowing a consistent energy saving.

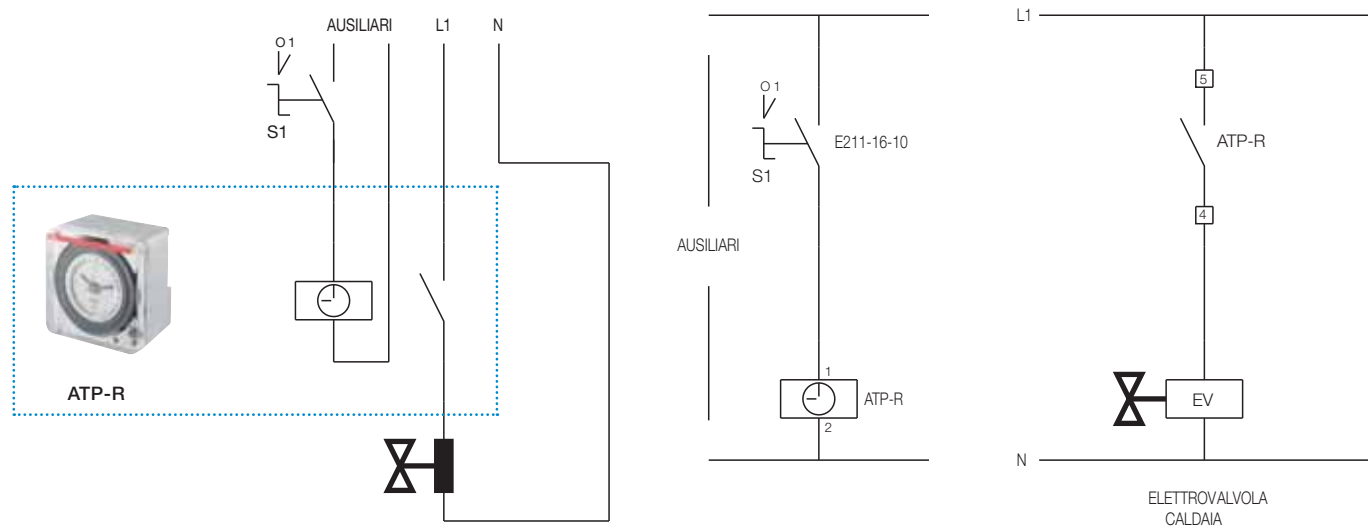

Control and automation technical details

D Line digital time switches

Innovations

- Holiday management with the possibility of programming them in various period throughout the year
 - Product warranty management: the internal clock and battery start at the first installation
 - Menu programming with 4 simple keys
 - Minimum switch time is 1 second
 - Multilingual menu with 11 language choices
- Connected load maintenance management: According to the "count down", it sends an alert on the display after a set number of operating hours
 - Zero load switching to guarantee higher load relay working life.
 - Load reserves for 6 years from the first start-up guaranteed by the lithium battery

Furthermore, the PLUS and SYNCHRO

D KEY programming key to run programs saved on the key, program transfer from timer switch to key and vice versa to read programs on key.



D SW programming software lets you quickly, simply and easily create complex programs from your desktop. Once created, the program can be printed or saved to file.



The D DCF77 antenna that receives the DCF77 radio synchronisation signal transmitted by the atomic clock installed c/o Mainflingen, near Frankfurt, increases digital clock precision.

The GPS antenna that receives time from the Global Positioning System, that offers a more accurate value than land transmissions in addition to the possibility of receiving the signal anywhere in the world.

Control and automation technical details

D Line digital time switches

Displays

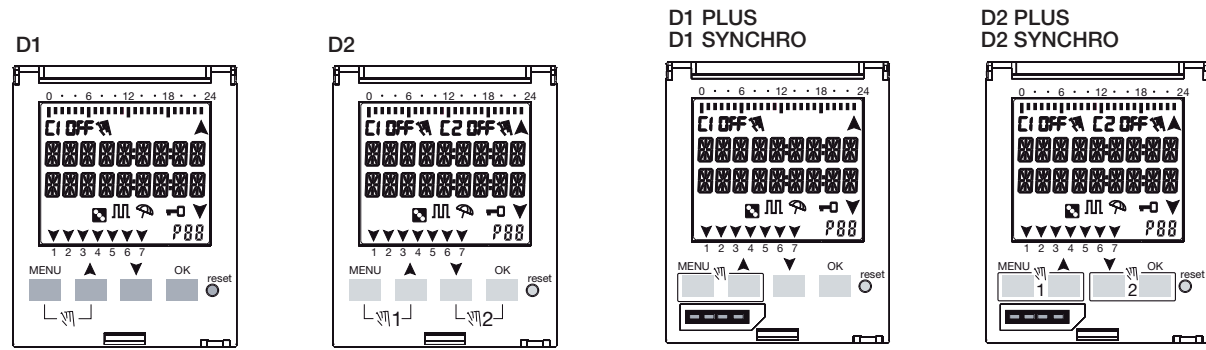

1C564-0008970302

Programming menu without programming key

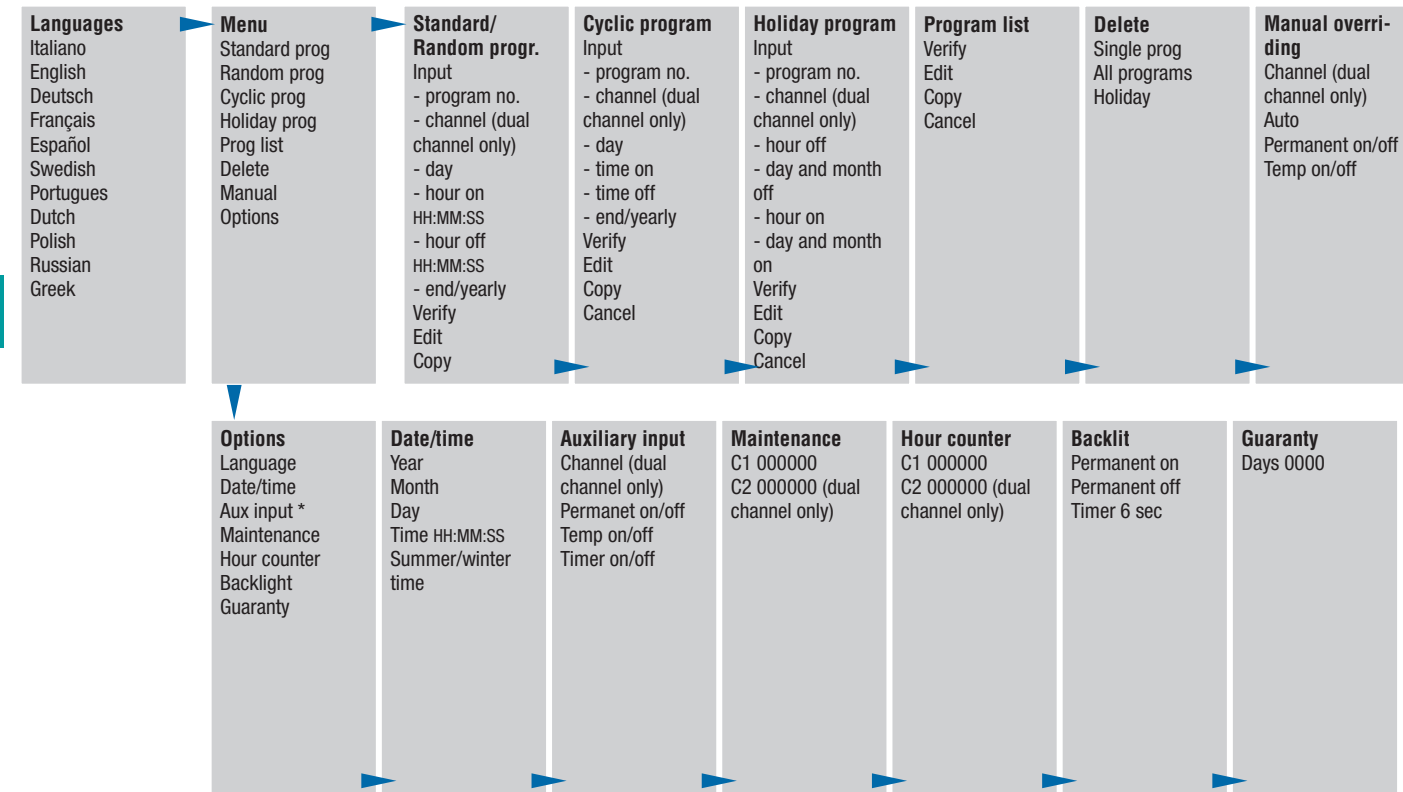

* not allowed for SYNCHRO type

Programming menu with programming key

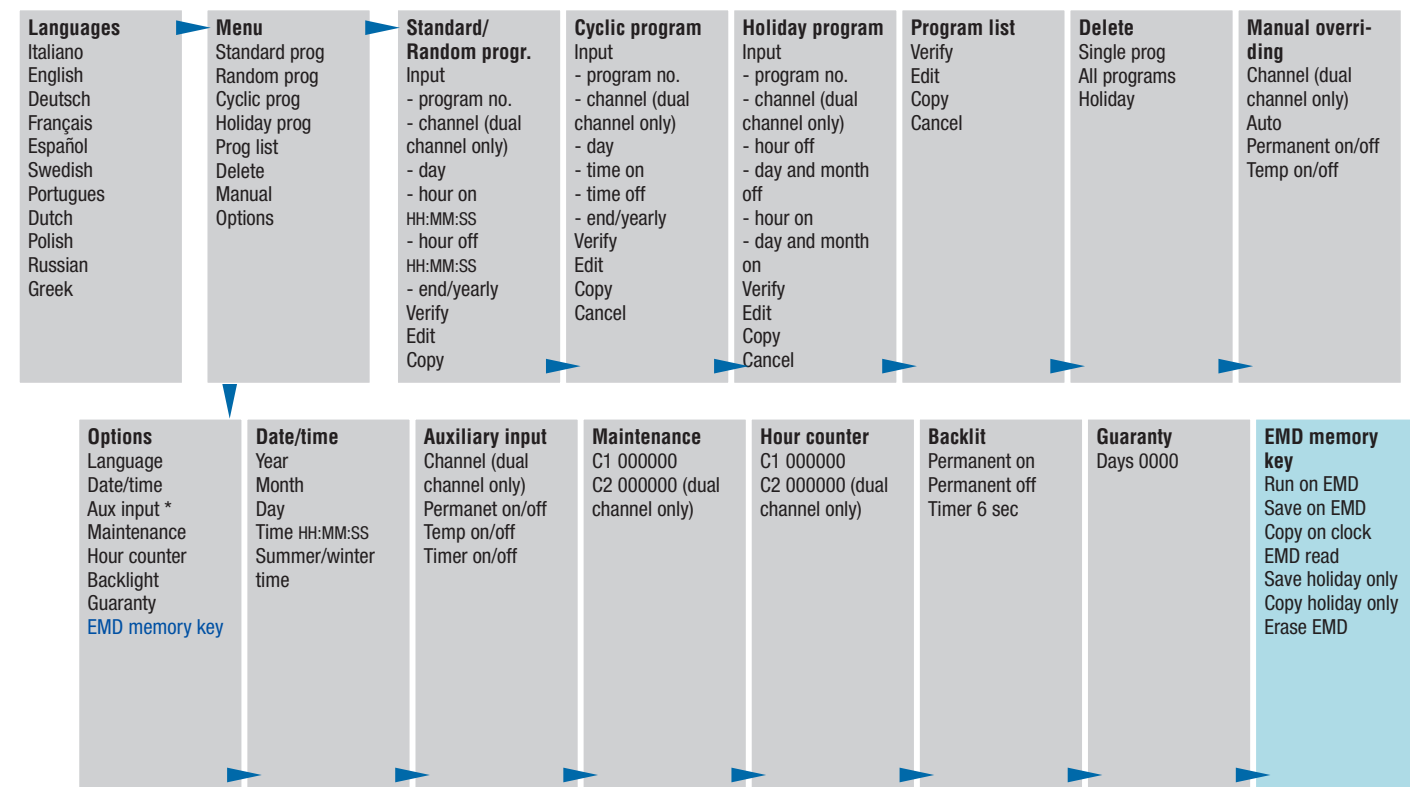

* not allowed for SYNCHRO type

TWP mounting diagram

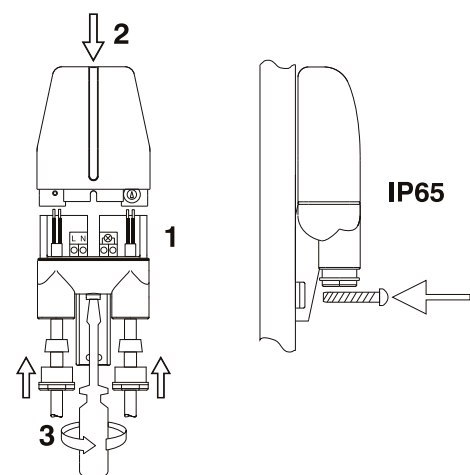

Control and automation technical details

D Line digital time switches

Programming key

Allows to run a program in EMD external memory automatically, to save the programs in the clock or to create programs using the D SW software, on the EMD external memory or

viceversa.

Furthermore, the holiday programs can be loaded and unloaded on D KEY.

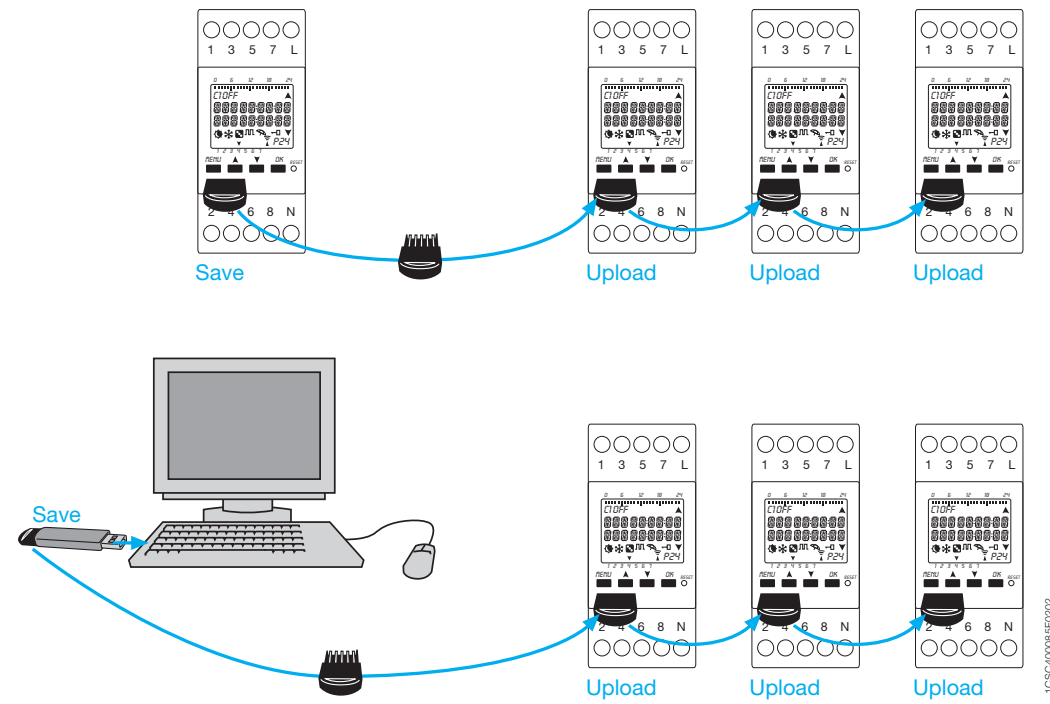

10

DCF77 antenna

Operating principle:

This antenna receives scheduled messages broadcasted from the Frankfurt on Main (Germany) based DCF77 emitter. Thanks to this signal, the time switches are automatically set to: hour, date and proper daylight saving time. The broadcast power is 50 kW and the range is approximately

2500 kilometers from Frankfurt on Main.

Sometimes the signal is received intermittently and not in all locations, especially in countries far enough from the D DCF77 emitter.

For optimal signal reception the arrow marked side of the antenna must be rotated towards Frankfurt on Main.



GPS antenna

Operating principle:

The Global Positioning System provides an accurate location and time information for an unlimited number of people in all weather, day or night, anywhere in the world.

The synchronization received from GPS is far more precise regarding to terrestrial broadcast.

The GPS system relies upon time from satellite based atomic clocks, constantly controlled and corrected from a ground stations network.

The time is derived from different sources simultaneously, the digital time switches can automatically compensate for propagation delays and other problems by providing more precise values than terrestrial.

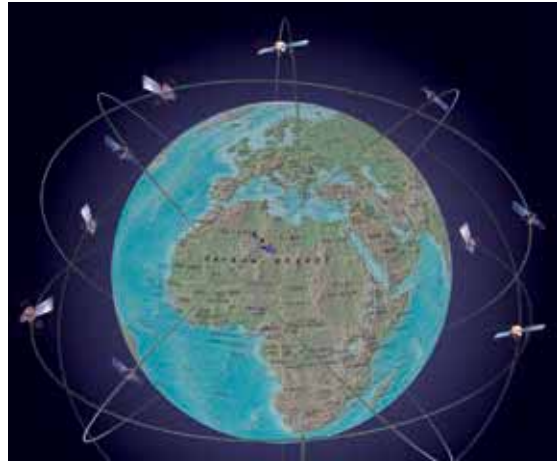

Control and automation technical details

D Line digital time switches

D 365

Display and functions

D 365

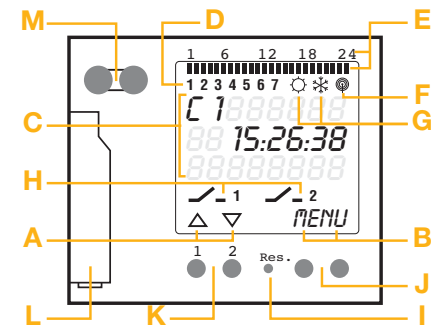

D 365 CE

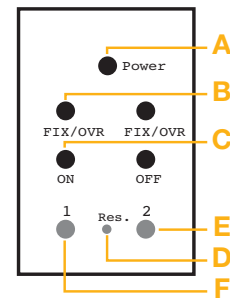

D 365 LAN

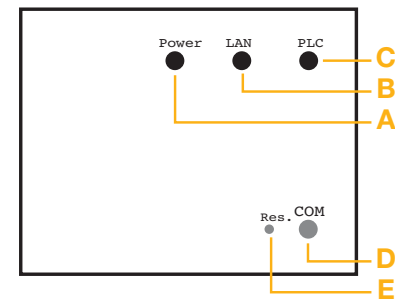

Display

- A Functions of the two left keys
- B Functions of the two right keys
- C 3 line display
- D Days of the week, can be modified from the DATE/ HOUR menu, e.g. 1= Sunday
- E Programmed switching times
- F Radio antenna
- G Standard/ daylight savings time
- H Switching status (ON/OFF/OVR/FIX)

Keys/interface

- I Reset
- J Right keys
- K Left keys, with manual function in automatic operation
- L Battery
- M Infrared interface

Display

- A Red Power LED
- B Yellow FIX/OVR LED
- C Green ON/OVR LED
- D Reset
- E Right key (FIX ON/FIX OFF/Override/Automatic operation)
- F Left key (FIX ON/FIX OFF/Override/Automatic operation)

LED meaning

	OFF	ON	Blinking
Red LED	Power	Power	-
Power	OFF	ON	-
Yellow LED			
FIX/OVR - Channel function	Automatic operations	FIX ON/ FIX OFF	Override function
Green LED			
ON/OFF - Channel state	Channel OFF	Channel ON	-

LED

- A Power
- B LAN – Connection to LAN
- C PLC (PowerLine Communication) Synchronization with timer

Function keys

- D Startup (COM)
- E Reset

Power Line communication

Standard 50/60 Hz a.c.

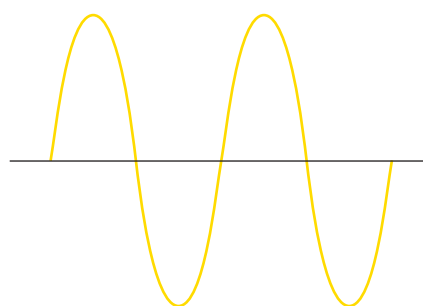

PLC signal

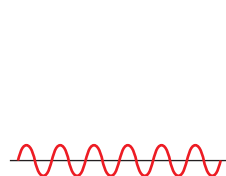

Modulated signal

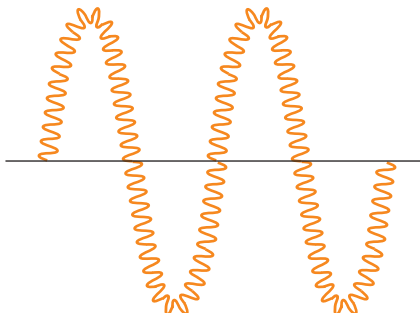

PowerLine is the communication protocol used for transmitting data through the power cord of the yearly time switch used in narrowband within the electric network. The exchange of information between programmers, channel extensions and LAN device, are ensured via the connection of the power terminals of the individual devices.

Main features of the modem used:

- Modulation: FSK (Frequency Shift Keying)
- Transmission frequency: 132.5 kHz
- PowerLine Interface compliant with Cenelec C band, EN50065
- Maximum distance between programmer, channel extensions, and LAN device, no greater than 50 m.

Control and automation technical details

D Line digital time switches

LAN/Internet communication

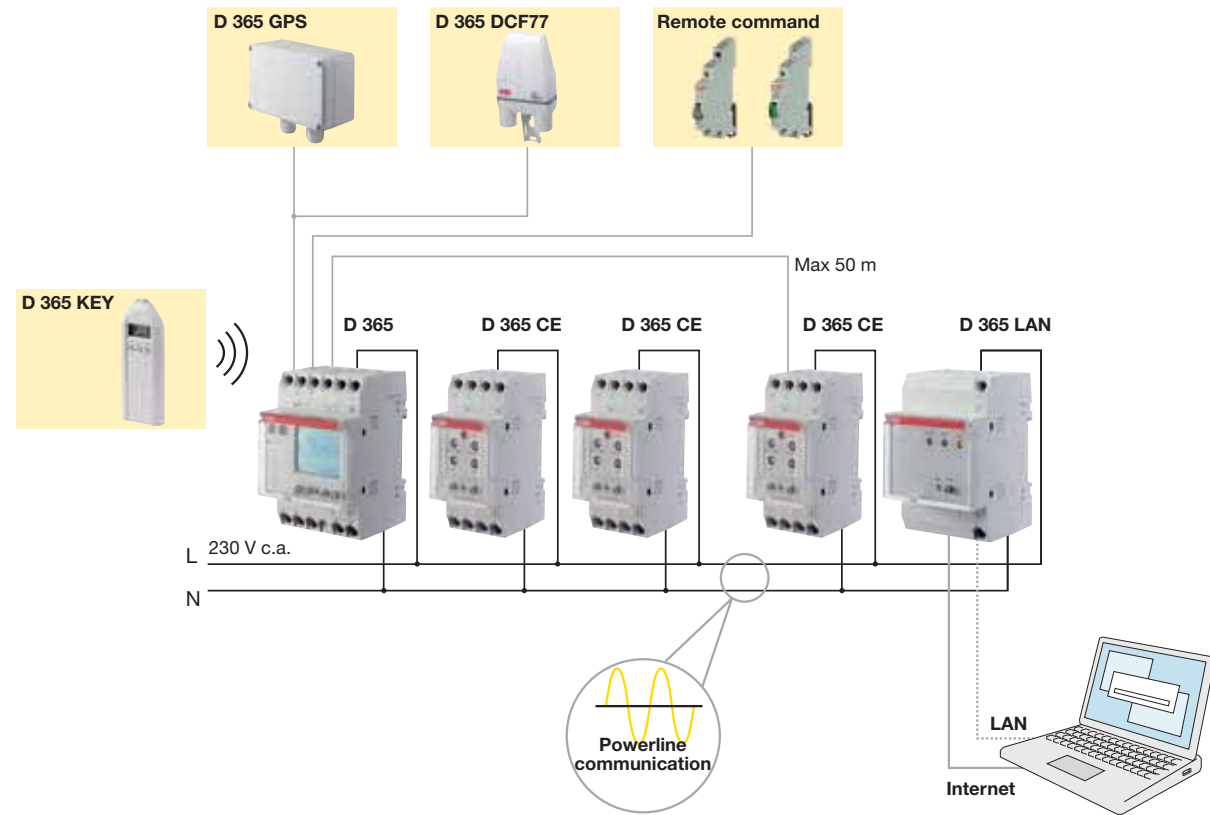

10

The new LAN module allows you to establish a connection between the yearly time switch and the local network or internet.

If the programs are created using the programming software, they can be transmitted easily from your desktop via the local network or internet to the LAN module which is then able to communicate with the yearly time switch using the PowerLine communication protocol.

In addition to enabling the exchange of programs, the LAN module also carries out the service function at the same time. In fact you can be informed of any faults, power failures, low batteries, etc.

Thanks to this type of transmission you can control the incoming programs and the service functions in a remote area of the system such as an office or control room, thus avoiding any bothersome movements and accordingly, wasting time.

Webserver



The web server is a useful tool that through communication with D 365 LAN allows you to monitor on a moment by moment basis and modify, if necessary, the status of the channels on the D 365 yearly programmer or on the D 365 CE channel expansions. In fact, thanks to the possibility to receive information about any failures, power outages, battery status, status of the tasks, or correct transmission of the program via email, the user is always updated on the status of the system, thus improving the secure state as well as guaranteeing rapid maintenance or overhaul.

Programming key



The external memory D 365 KEY manages up to 4 programs, including holidays. It allows you to run a program, contained within it, on the D 365 yearly time switch, to save or copy the programs in the clock or created using the programming software.

Control and automation technical details

D Line digital time switches

LAN module



Thanks to the D 365 LAN module, if connected to a router or a switch, you can easily create the program on your home computer, transfer it through the internet or local network to the D 365 LAN module, and then to the D 365 yearly time switch via the PowerLine communication protocol. Using the D 365 LAN you can:

- Upload/download programs
- Download count times
- Set the time and the date of the programmer

CE channel extension



The D 365 CE channel expansion unit allows you to expand the number of channels of D 365 up to a maximum of 8. In fact thanks to the switching commands received through the PowerLine communication protocol, you can install D 365 and the related D 365 expansions in separate switchboards, for example on different floors, but you must always take care to respect the maximum distance of 50 m. On the front of the device you can view the state of the channels on a moment by moment basis by means of the LED lights.

DCF77 antenna



The D 365 DCF77 antenna receives scheduled messages broadcasted from the DCF77 emitter located in Mainflingen, Germany. The broadcast power is 50kW with a range of 2500 km. Sometimes the signal is received intermittently and not all locations may be covered due to shadows caused by the land, especially in countries far away from the emitter; in any case, Italy has full coverage.

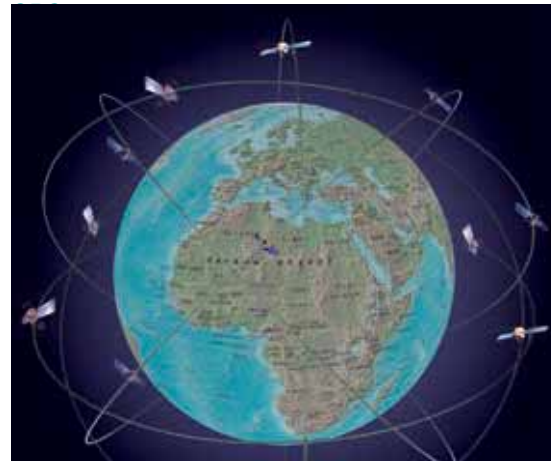

The D 365 GPS antenna allows you to receive the time signal broadcast by the Global Positioning System. Due to the high broadcasting frequency, this type of signal, unlike terrestrial broadcasts, offers the advantage of being immune to atmospheric disturbances with no risk of interruption, but the greatest advantage is that it can be received anywhere in the world. Therefore, thanks to no disturbances, the extreme precision, and full coverage, GPS receivers are soon bound to completely replace terrestrial signals in all industrial sectors.

Control and automation technical details

D Line digital time switches

Operating principle

The D2 two-channel digital time switches enable to open and close circuits according to a daily or weekly program, controlling single loads or group of loads even when they require different time controls with a common time reference. In this example, the digital time switch D2 allows the operation of heating as well as lighting systems of a church when services are performed; when no service is performed, the device only controls the heating system.

Application environments

The D2 two-channel digital time switches are particularly indicated in environments and situations requiring the management of multiple loads according to a time program flexible enough to include or exclude their application based on the day of the week (offices, schools, public areas, etc.).

Example of installation

As shown in the diagrams, one of the possible applications is to mount the D2 two-channel digital time switch inside the power supply circuit of a church, where in the days when no service is performed only the heating system is activated (programmed on one of the two channels) at a preset time, while on Sundays and when services are performed the lighting system is also switched on (through a program on the second channel). According to the controlled system power, the activation is performed by an ESB contactor.

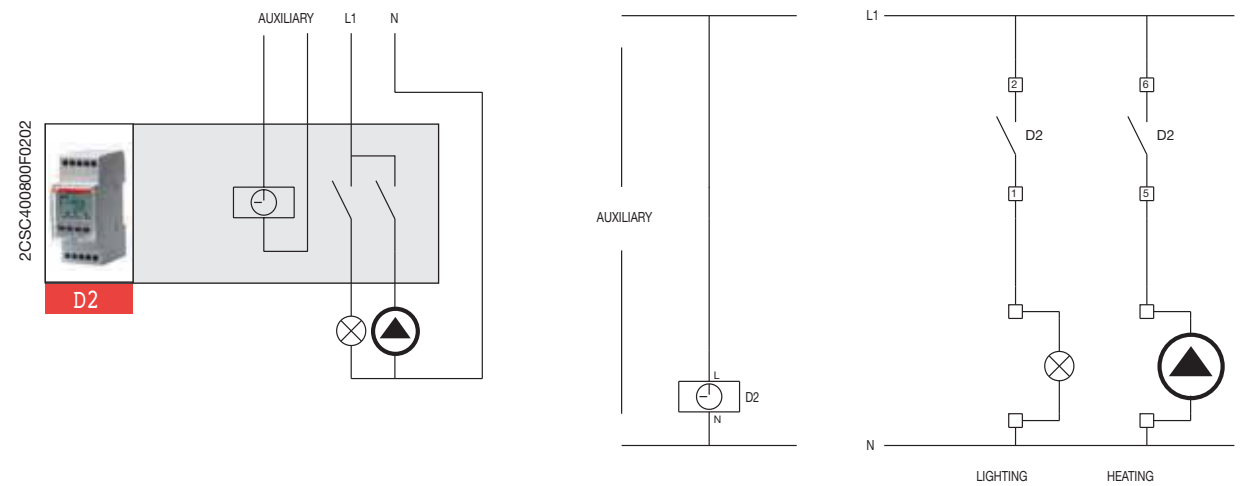
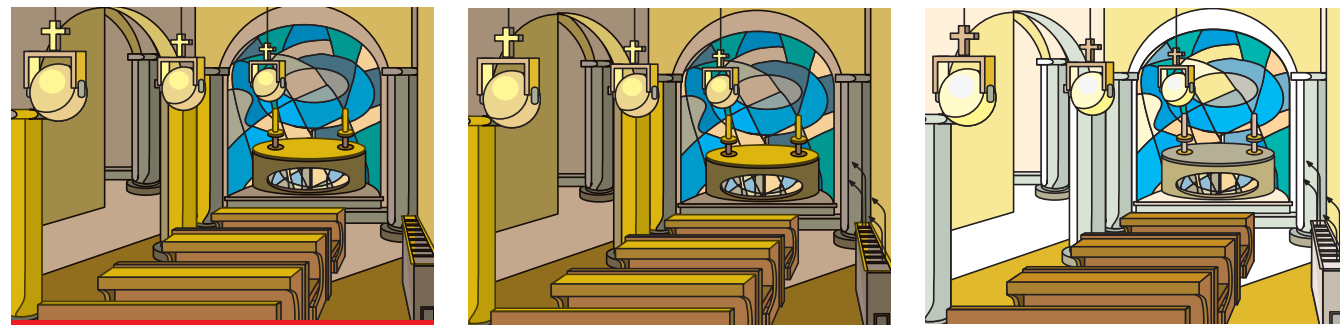

Operating principle

As illustrated in the diagrams, among one of the possible applications involves the installation of a D 365 yearly digital time switch with two D 365 CE channel extensions in the power supply circuit of an industrial building, where during workdays the lighting and heating system of the various levels of the building turn on in the morning and remain on until the evening, in addition to periodically enabling the shift change sirens. The large amount of memory space in the time switch makes it possible to automate the system for the entire current year and define all holiday periods where the loads remain shut off. This helps to save energy and prevent the risk of reprogramming errors. When associated with the D 365 DCF77 antenna, the time switch will always be synchronized with the exact time, thus avoiding having to make adjustments over time.

Application environments

The installation of a D 365 yearly digital time switch, is particularly suited for schools, hospitals, train stations, airports, industrial factories, public buildings, malls, etc. where the perfect operation of all devices are required at a set time.

Example of installation

With yearly digital time switches you can automate one or more utilities according even complex and articulated programs with daily, weekly, monthly, and annual frequency. In addition to switching, programming includes impulsive controls, cyclical ON/OFF, and even astronomical functions. Under the constant control of the D365 model, lighting and heating, and even sirens, will start in the various floors at a set hour.

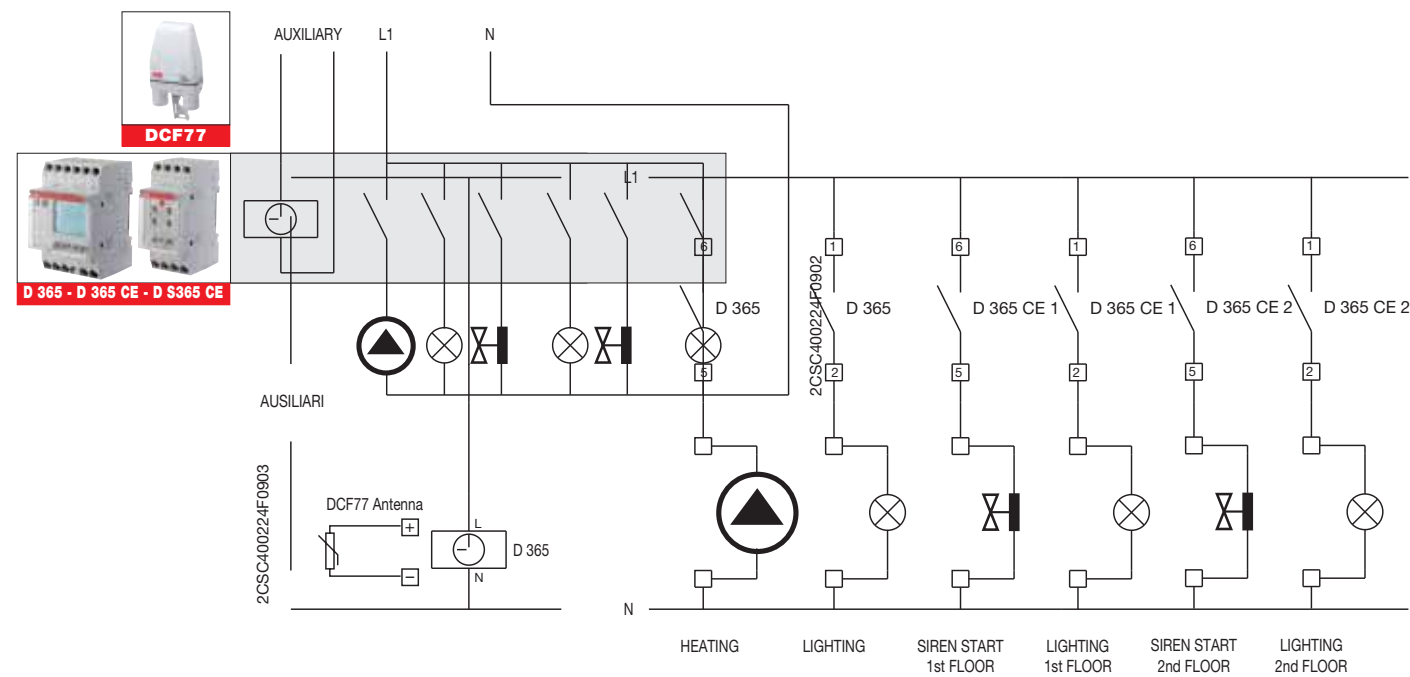
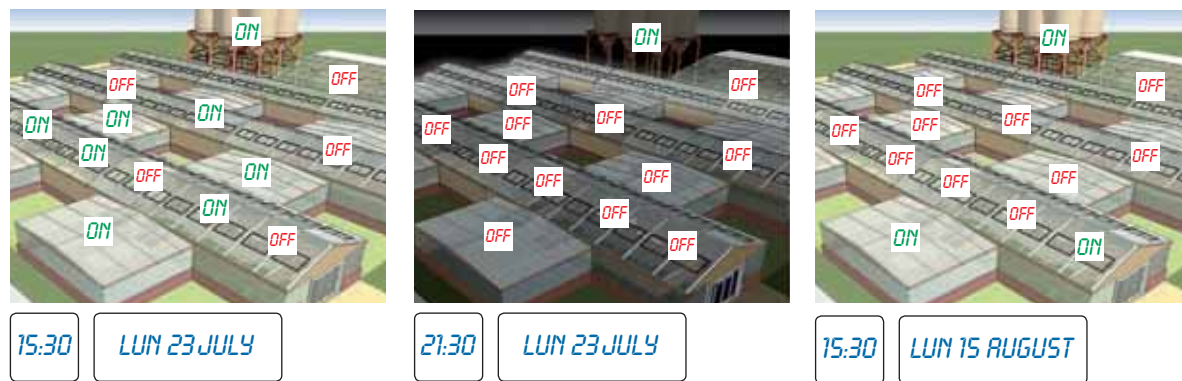

Control and automation technical details

E 232 staircase lighting time-delay switches

E 232E-230 Multi 10, 8/230 Multi 10

Functions: Staircase lighting time-delay switch

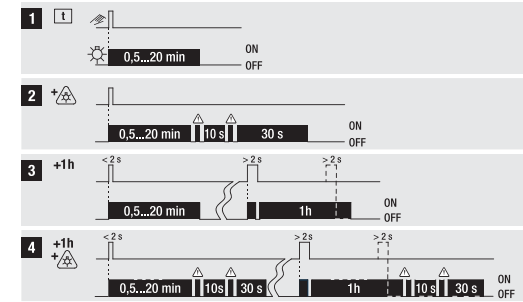

2CDC052043F0207

Function: Latching relay, Latching relay with returning time

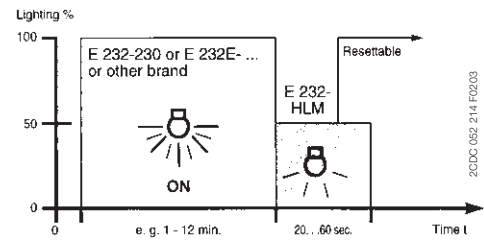
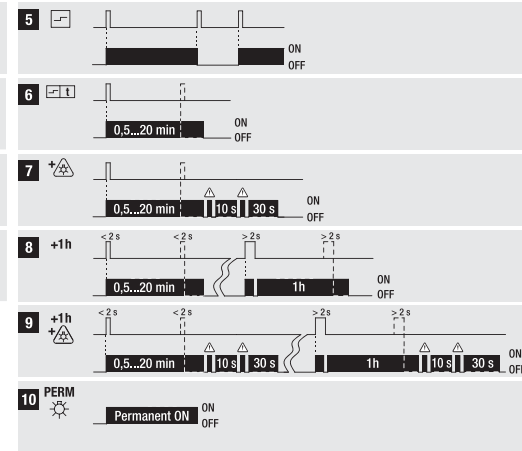

timing of a staircase lighting time-delay switch with semi-light module E 232-HLM

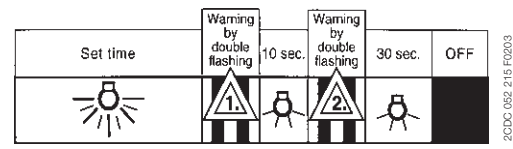

warning function of E 232E-8/230 Plus

DIN 18015-2 provides that "that the automatic disconnection of lighting equipment fitted in staircases of apartment buildings must provide for warning signals, e.g. dimming, in order to avoid sudden unexpected darkness".

Operating principle

Activated by a pulse command of a push-button, the E 232 staircase switch turns on the plant's light for a T1 time that can be protracted, with a 50% dimming of the light intensity, by means of the parallel wiring of a HLM half-light module.

Application environments

Installation of E 232 staircase switch, coupled with the HLM half-light module, can be ideal wherever timing of the lighting is requested (staircase and pathways of public places, cellars, garage, etc.).

Example of installation

As illustrated, one among the possible applications concern installation of the E 232 staircase switch, coupled to a HLM half-light module, in the staircase lighting plant of a multistory building. Pushing the push-button, the timer of the E 232 switch turns on the lights for a settable T1 time. At the end of T1 time, the HLM half-light module dims the light by a 50% for a T2 time in the while is possible turn on again the full lighting.



10

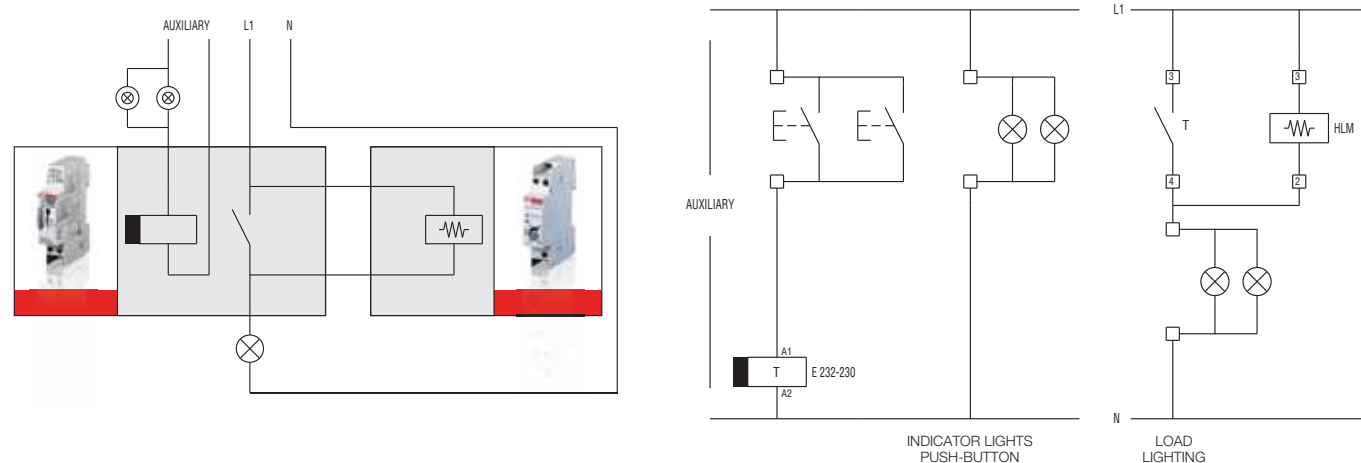

Control and automation technical details

E 234 CT-D electronic timers

Technical diagrams

Load limit curves

AC load (resistive)

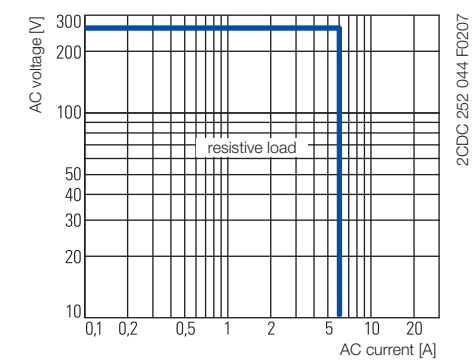

CT-D.1x

DC load (resistive)

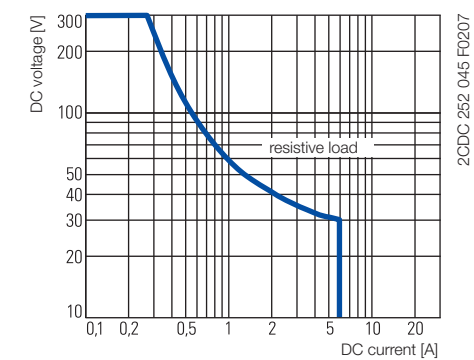

CT-D.1x

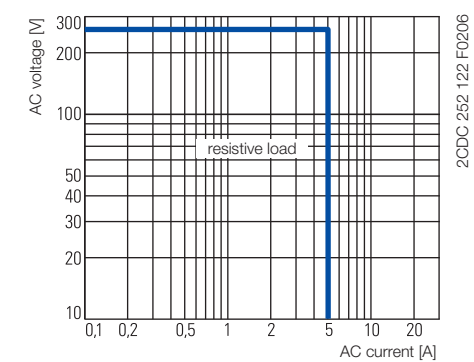

CT-D.2x

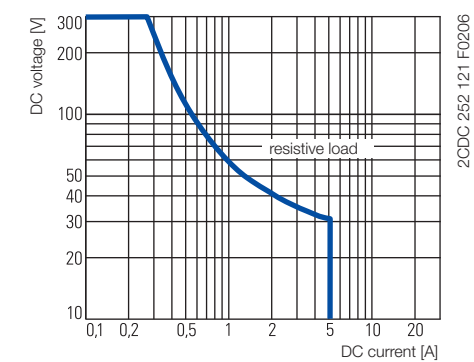

CT-D.2x

Derating factor F

for inductive AC load

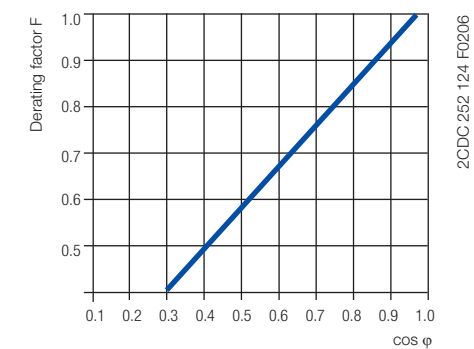

Contact lifetime

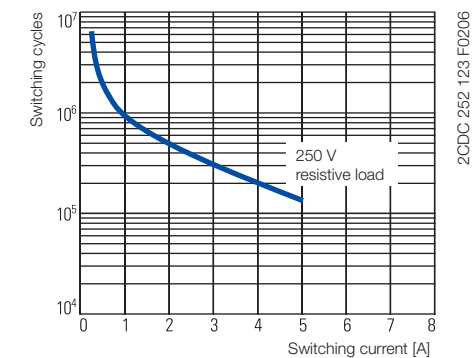

Remarks

Legend

- Control supply voltage not applied / Output contact open
- Control supply voltage applied / Output contact closed
- A1-Y1/B1 Control input with voltage-related triggering

Terminal designations on the device and in the diagrams

- The 1st c/o contact is always designated **15-16/18**.
- The 2nd c/o contact is designated **25-26/28**.
- The n/o contacts of the star-delta timers are designated with **17-18** and **17-28**.
- Control supply voltage is always applied to terminals **A1-A2**.

Function of the yellow LED

The yellow LED **R** glows as soon as the output relay energizes and turns off when the output relay de-energizes.

- ON-delay**
(Delay on make)
CT-ERD, CT-MFD

This function requires continuous control supply voltage for timing.

Timing begins when control supply voltage is applied. The green LED flashes during timing. When the selected time delay is complete, the output relay energizes and the flashing green LED turns steady. If control supply voltage is interrupted, the output relay de-energizes and the time delay is reset. Control input **A1-Y1/B1** of the CT-MFD is disabled when this function is selected.

- OFF-delay with auxiliary voltage**
(Delay on break)
CT-AHD, CT-MFD

This function requires continuous control supply voltage for timing. If control input **A1-Y1/B1** is closed, the output relay energizes immediately. If control input **A1-Y1/B1** is opened, the time delay starts. The green LED flashes during timing. When the selected time delay is complete, the output relay de-energizes and the flashing green LED turns steady. If control input **A1-Y1/B1** recloses before the time delay is complete, the time delay is reset and the output relay does not change state. Timing starts again when control input **A1-Y1/B1** re-opens. If control supply voltage is interrupted, the output relay de-energizes and the time delay is reset.

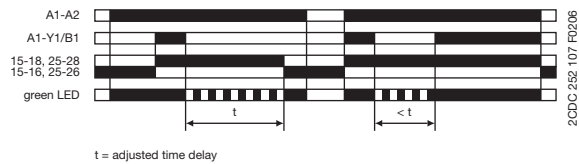
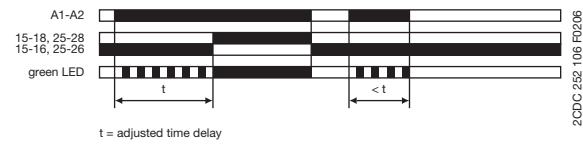

Control and automation technical details

E 234 CT-D electronic timers

Impulse-ON (Interval) CT-VWD, CT-MFD

This function requires continuous control supply voltage for timing. The output relay energizes immediately when control supply voltage is applied and de-energizes after the set pulse time is complete. The green LED flashes during timing. When the selected pulse time is complete, the flashing green LED turns steady. If control supply voltage is interrupted, the output relay de-energizes and the time delay is reset. Control input **A1-Y1/B1** of the CT-MFD is disabled when this function is selected.

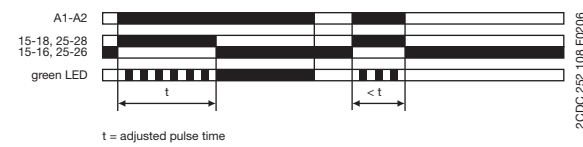

Impulse-OFF with auxiliary voltage (Trailing edge interval) CT-MFD

This function requires continuous control supply voltage for timing. If control supply voltage is applied, opening control input **A1-Y1/B1** energizes the output relay immediately and starts timing. The green LED flashes during timing. When the selected pulse time is complete, the output relay de-energizes and the flashing green LED turns steady. Closing control input **A1-Y1/B1**, before the time delay is complete, de-energizes the output relay and resets the time delay. If control supply voltage is interrupted, the output relay de-energizes and the time delay is reset.

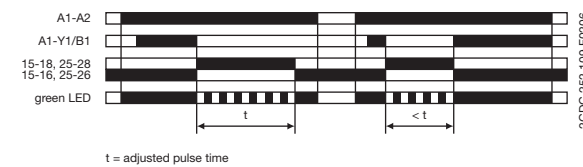

Flasher, starting with the ON time (Recycling equal times, ON first) CT-EBD, CT-MFD

Applying control supply voltage starts timing with symmetrical ON & OFF times. The cycle starts with an ON time first. The ON & OFF times are displayed by the flashing green LED, which flashes twice as fast during the OFF time. If control supply voltage is interrupted, the output relay de-energizes and the time delay is reset. Control input **A1-Y1/B1** of the CT-MFD is disabled when this function is selected.

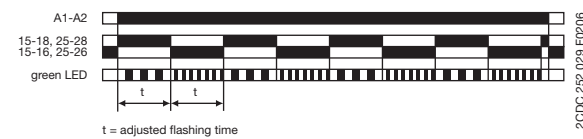

Flasher, starting with the OFF time (Recycling equal times, OFF first) CT-MFD

Applying control supply voltage starts timing with symmetrical ON & OFF times. The cycle starts with an OFF time first. The ON & OFF times are displayed by the flashing green LED, which flashes twice as fast during the OFF time. If control supply voltage is interrupted, the output relay de-energizes and the time delay is reset. Control input **A1-Y1/B1** of the CT-MFD is disabled when this function is selected.

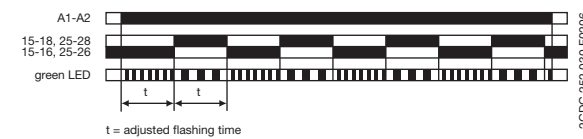

Pulse former (Single shot)
CT-MFD

This function requires continuous control supply voltage for timing.

Closing control input **A1-Y1/B1** energizes the output relay immediately and starts timing. Operating the control contact switch **A1-Y1/B1** during the time delay has no effect. The green LED flashes during timing. When the selected ON time is complete, the output relay de-energizes and the flashing green LED turns steady. After the ON time is complete, it can be restarted by closing control input **A1-Y1/B1**. If control supply voltage is interrupted, the output relay de-energizes and the time delay is reset.

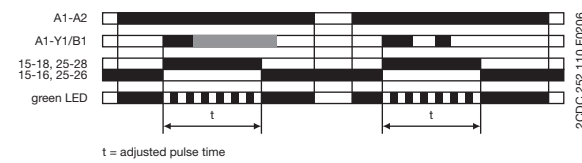

Pulse generator, starting with the ON or OFF time (Recycling unequal times, ON or OFF first)
CT-TGD

This function requires continuous control supply voltage for timing.

Applying control supply voltage, with open control input **A1-Y1/B1**, starts timing with an ON time first. Applying control supply voltage, with closed control input **A1-Y1/B1**, starts timing with an OFF time first. The ON & OFF times are displayed by the flashing green LED, which flashes twice as fast during the OFF time. The ON & OFF times are independently adjustable. If control supply voltage is interrupted, the output relay de-energizes and the time delay is reset.

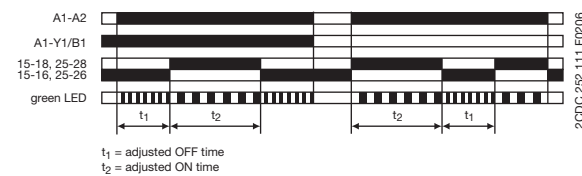

Star-delta change-over (Star-delta starting)
CT-SDD, CT-SAD

This function requires continuous control supply voltage for timing.

Applying control supply voltage to terminals **A1-A2**, energizes the star contactor connected to terminals **17-18** and begins the set starting time t_1 . The green LED flashes during timing. When the starting time is complete, the first output contact de-energizes the star contactor.

Now, the transition time t_2 starts. When the transition time is complete, the second output contact energizes the delta contactor connected to terminals **17-28**. The delta contactor remains energized as long as control supply voltage is applied to the unit.

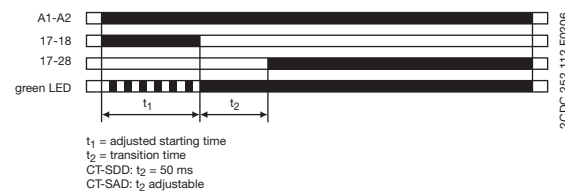

10

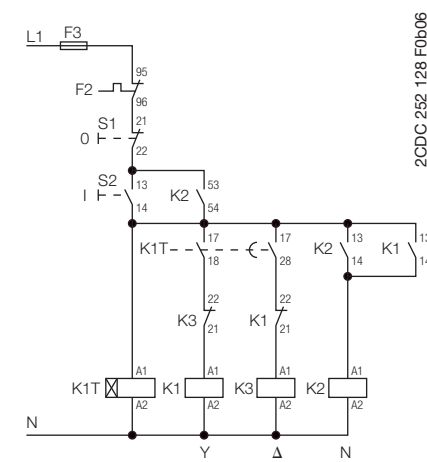

Control circuit diagram

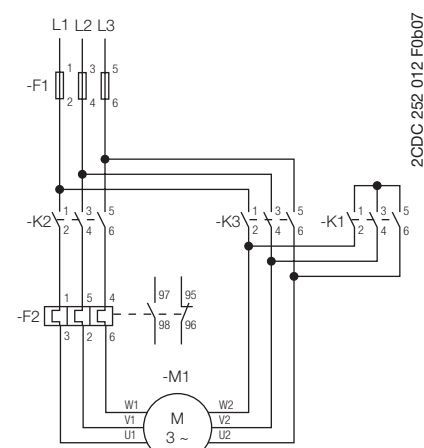

Power circuit diagram

Control and automation technical details

T1, T1 PLUS, T1 POLE, TWA-1 and TWA-2 twilight switches

Main features



Version for DIN profile

- 2 indication leds: one for contact status and one for threshold
- Four different type of lux range adjustment
- Adjustable switching delay
- Preset a 10 lux from factory
- Screw-less version
- 1 module width
- RoHS compliant



Pole/wall version

- Innovative design for direct installation on a pole/wall
- Quick and easy to install, thanks to the simple wiring and ease of adjustment
- Laser etched connection diagram on the back of the product
- Integrated brightness sensor preset at 10 Lux from factory
- Adjustable threshold value from 2 to 200 Lux
- Switching delay of 30 sec. +10% for ON and 40 sec. +10% for OFF
- Unlosable screw terminals
- Protection degree IP65
- Preset a 10 lux
- RoHS compliant



Astronomical version

- Astronomical and time programming
- Holiday program
- Automatic summer and winter time change
- 56 stored memory locations
- Opportunity to correct the astronomical time up to ± 120 min
- 1 or 2 changeover contacts
- latitude adjustment range from $+90^\circ$ North to -90° South.
- longitude adjustment range from 180° East to 180° West.
- Manual and permanent override, activated with one touch on the front of the device
- Memory key for improved program management
- Clear display of contact status
- Unlosable hinged window
- Keypad security lock with PIN code to prevent interference by unauthorised persons
- PC software for quick and easy programming
- Wiring diagram printed on the side of the product
- Complies with RoHS directives

T line

T1 operating principle

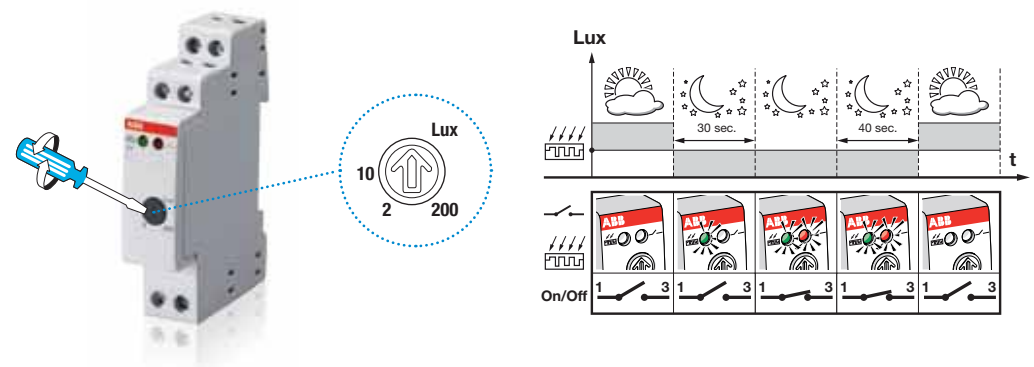

T1 PLUS operating principle

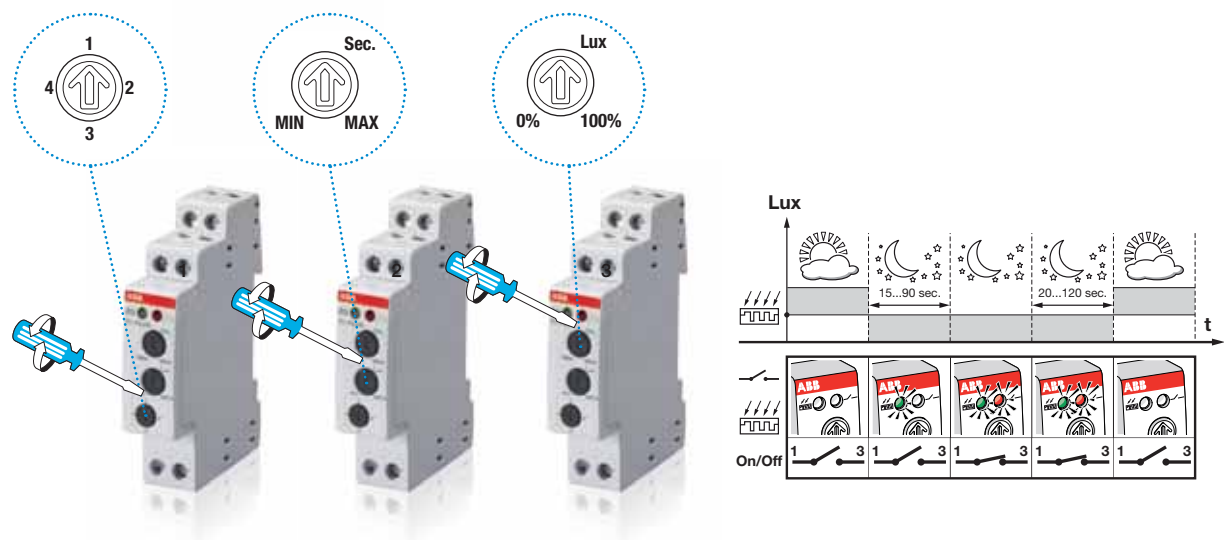

10

T1 POLE

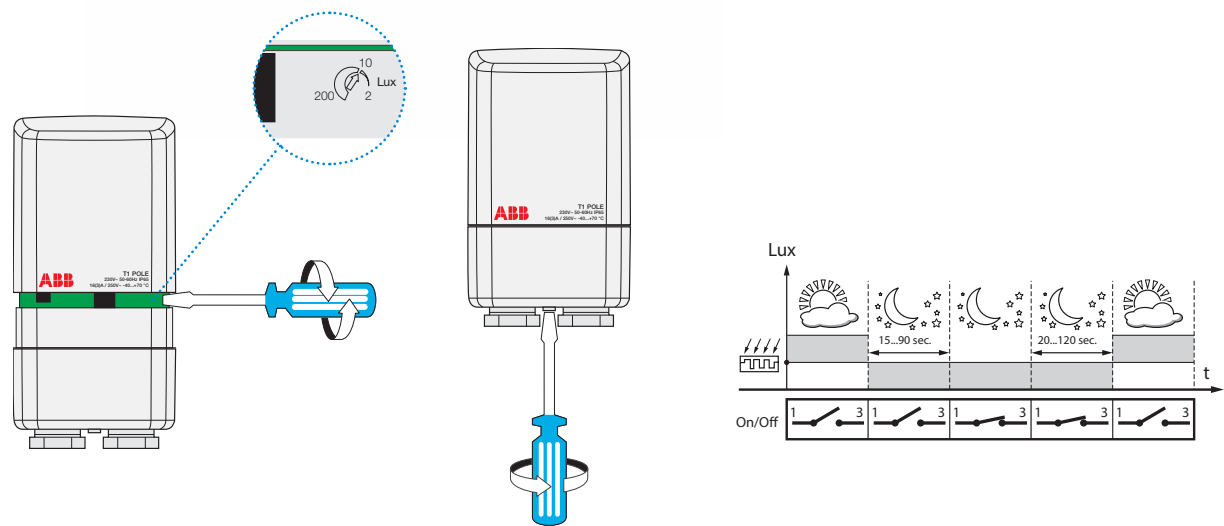

Control and automation technical details

T1, T1 PLUS, T1 POLE, TWA-1 and TWA-2 twilight switches

TWA-1 and TWA-2

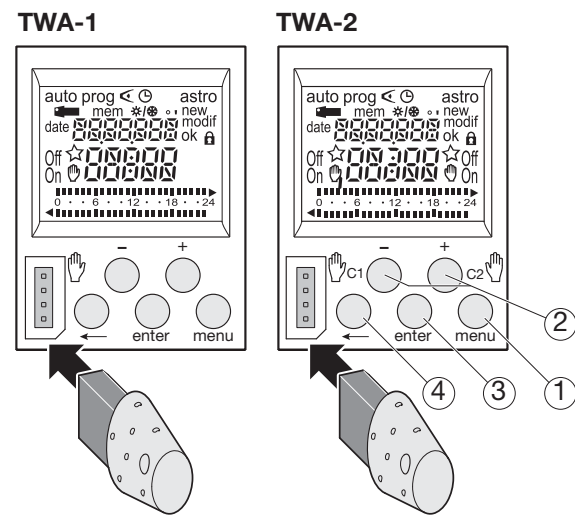

Keys

- ① **menu** : selection of operating mode.
- auto** : mode of running according to the program selected.
- prog** : **new** for programming mode.
- prog** : **modif** to modify an existing program.
- ◀ : checking of the program.
- 🕒 : modification of time, date and selection of the winter/summer timechange mode ⚙️/🌞
- astro** : astronomical mode.
- ☆ : indicates that the channel is in astronomical mode.
- ② + and - : navigation or setting of values.
- 👉 (TWA-1) : in auto mode, selection of overrides, or waivers.
- C1 👉, C2 👉 (TWA-2) : in auto mode, selection of overrides, or waivers.
- ③ **enter** : to validate flashing information on display.
- ④ ← : to return to the previous step.

Programming example

Ex: Rome

- Lo Longitude 12° EAST
- La Latitude 41° NORTH
- UDT +1 Universal Date Time = +1 hour

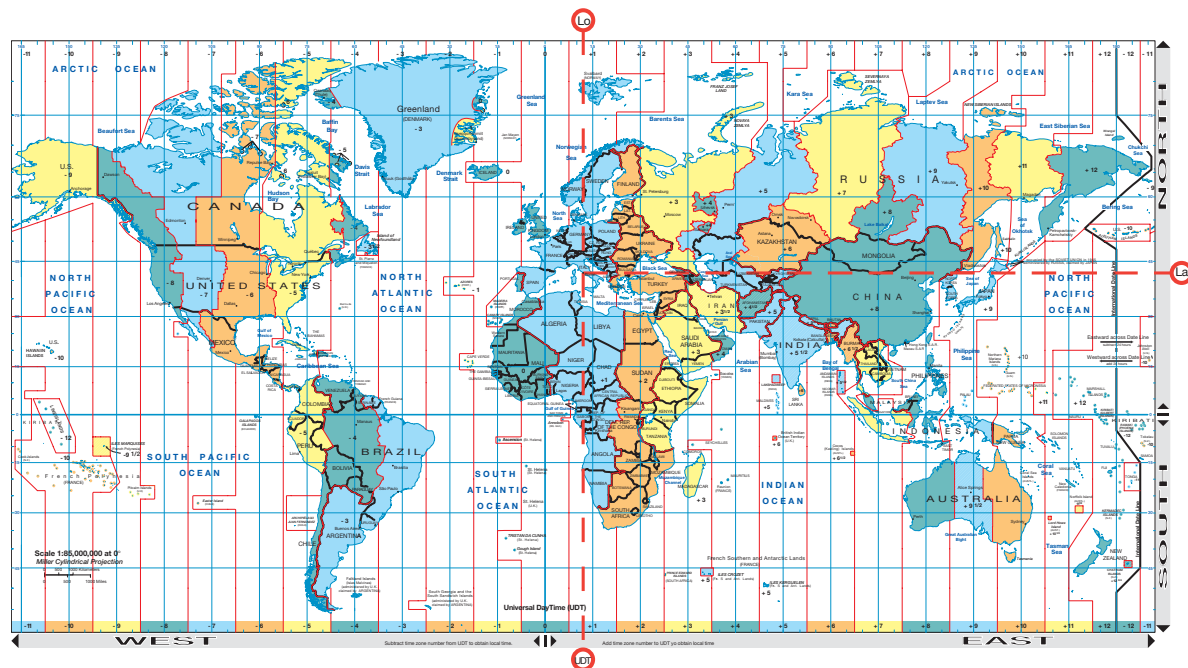
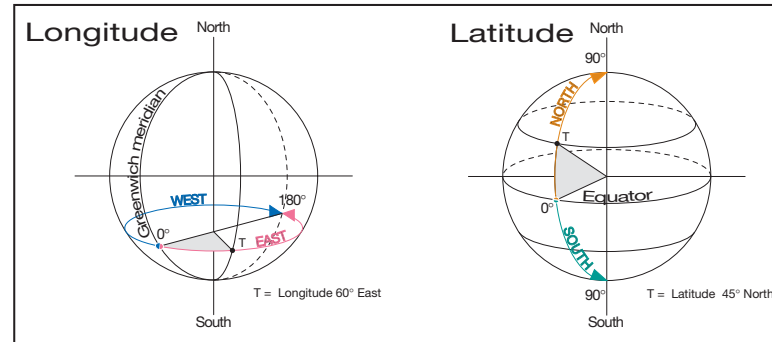



Programming

The astronomical twilight switches TWA-1 and TWA-2 can be programmed directly on a PC thanks to the Handytimer software. Once created, the program can be transferred to the DT-VK memory key and copied to several devices (-K versions only), thus avoiding any re-programming errors.

Minimal configuration

Operating system	Microsoft Window 95, 98, 2000, NT, Millennium, XP
Memory	15 Mb of free hard disk space



10

Use

1a	Connect the USB cable to the programming interface device and to your PC
1b	Insert CD, install the HANDYTIMER software with easy step by step instruction
1c	Create the required program
2a	Insert the DT-VK memory key into the programming interface device
2b	Copy the program on the DT-VK memory key
3	Insert the DT-VK memory key into TWA-1 or TWA-2 to save the program



Control and automation technical details

T1, T1 PLUS, T1 POLE, TWA-1 and TWA-2 twilight switches

Applications

- program creation (standard or non-standard)
- program reading and writing on electronic keys

Functions

- creation and editing of programs on PC with user-friendly display graphics
- program saving
- graphic printouts of programs, reading and transfer of programs between PC and electronic keys

Advantages for the installer

- management of the client's programs from the office
- traceability of written programs
- customer service (programming can be copied to an electronic key and sent by courier to the plant for rapid installation and use)
- option to modify the created programs directly on the installed products
- time-saving for repetitive installations. The program is written once only and then copied to a number of astronomical twilight switches

Advantages for the user

- option to save a copy of the program on an electronic key
- option to save a number of non-standard programs on different keys
- easy management of non-standard programs (simply insert and remove the key containing the non-standard program)

10 Easy-to-read programming display: day of the week, duration of the ON or OFF periods, number of steps available, ...

Programming access page

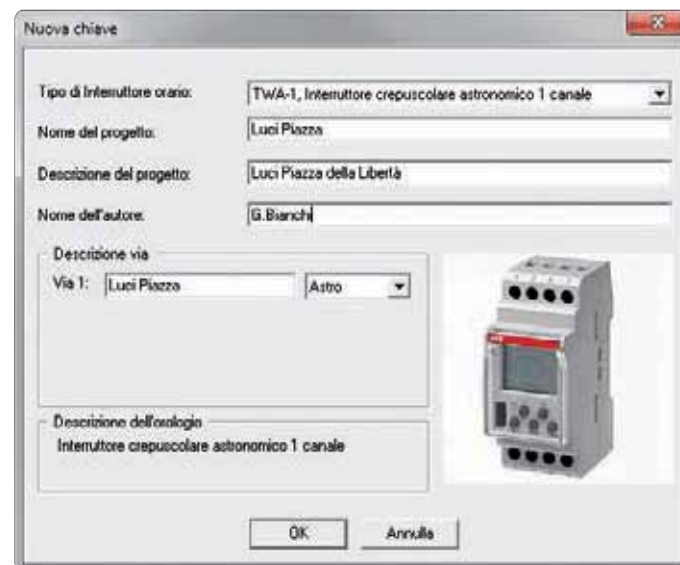

Control and automation technical details

T1 twilight switch

Operating principle

The diagram shows an example of the installation of the T1 twilight switch in the lighting system of a commercial establishment. When the external light falls below a certain level (e.g. during the evening when the shop is closed), the device switches on the window lights and the shop sign. The lights can be switched off late evening to reduce power consumption thanks to the AT1 switch timer.

Application environments

The installation of the T1 twilight switch with an AT electromechanical timer is particularly useful in settings and situations where energy saving is a prime concern (shops, office corridors and public passageways, car parks, parks, etc.).

Example of installation

As shown in the diagrams, one of the possible applications is the installation of a T1 twilight switch in the lighting system of a commercial establishment.

When the external light falls below a certain level (e.g. when the shop is closed), the twilight switch switches on the window lights and the sign. The lights can be switched off late evening to reduce power consumption thanks to the AT1 switch timer which keeps the circuit open until the next morning. When the external light returns to above the threshold value, the twilight switch relay returns to the open position.



10

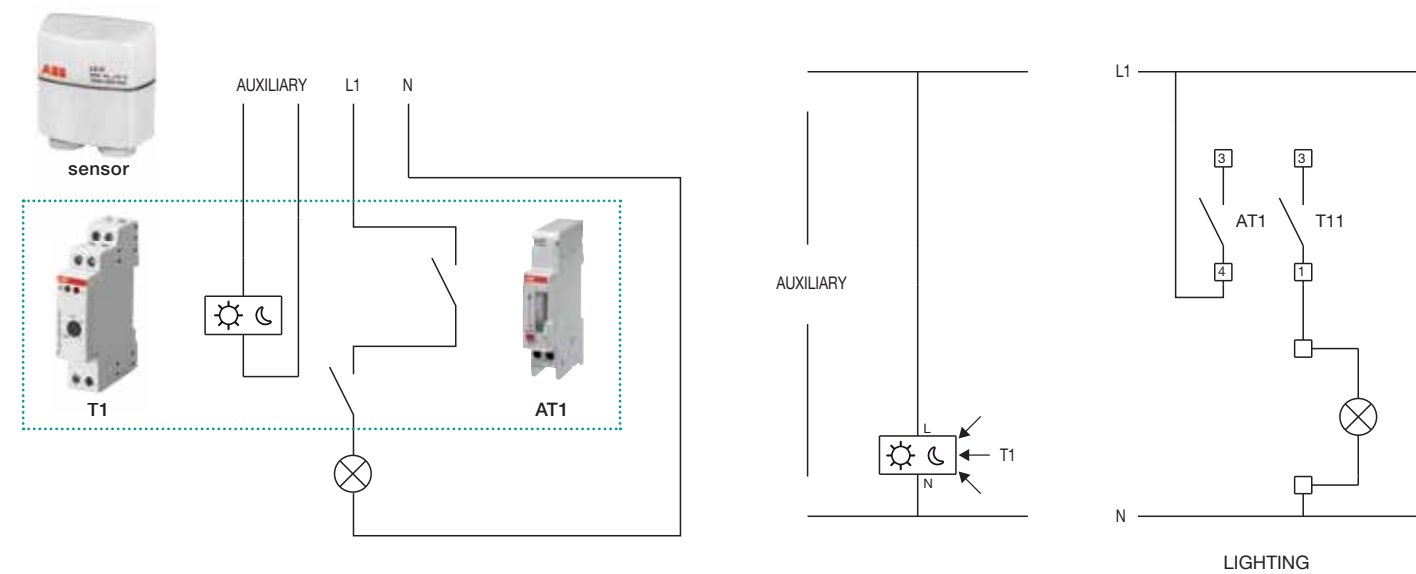

Control and automation technical details

T1 PLUS twilight switch

Operating principle

The diagram shows an example of the installation of the T1 PLUS twilight switch in the lighting system of a greenhouse. When the external light exceeds a certain level (e.g. during the warmest hours of the day, i.e. early afternoon), the device activates the shading system, e.g. roller blinds. Thanks to the option to advance or delay the activation-deactivation time, the T1 PLUS can also maintain the roller blinds closed in the case of passing clouds.

Application environments

The installation of the T1 PLUS twilight switch is particularly useful in settings and situations where lighting control is required for locations where there are consistently high brightness values, thus guaranteeing substantial savings in energy consumption (greenhouses, arcades, photovoltaic plants, etc.).

Example of installation

As shown in the diagrams, one of the possible options is to install a T1 PLUS twilight switch in the lighting system of a greenhouse.

When the external light exceeds a certain level (for example during peak hours in the early afternoon) the twilight switch activates the roller blinds, protecting the plants in the greenhouse against burning by the strong sunlight.

When the external light returns to below the threshold value, the twilight switch relay opens the blinds to allow the sunlight to pass through.



10

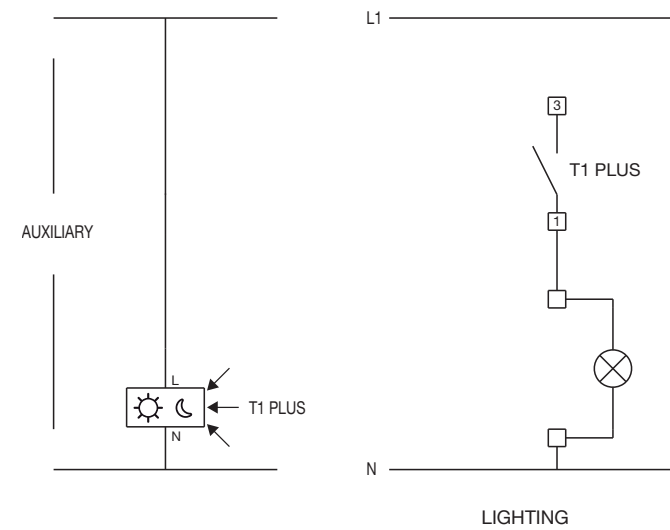
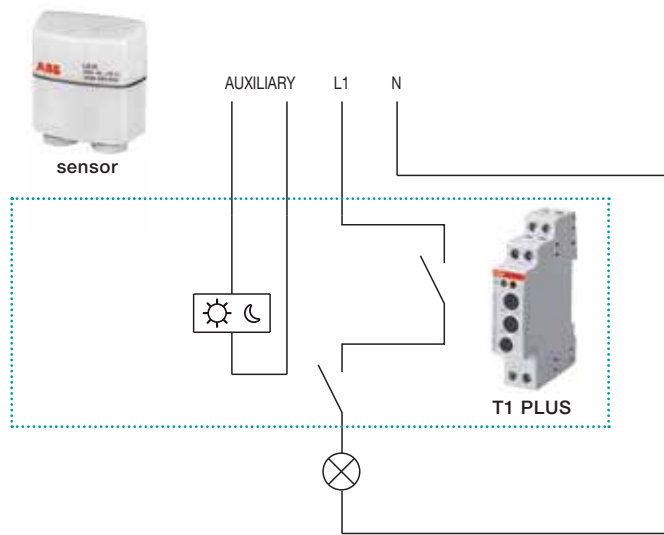

Control and automation technical details

T1 POLE twilight switch

Operating principle

The diagram shows an example of the installation of the pole-mounted T1 POLE twilight switch for motorway lighting systems. When the external light falls below a certain level, 10 lux for example, the device switches on the lights present in tunnels, service areas, near to junctions, etc. The lights are then switched off by the T1 POLE in the morning when the 10 lux value is exceeded.

Application environments

The installation of the T1 POLE twilight switch is particularly suitable for controlling public street lighting, thanks to the fact that they can be installed on poles, lamp standards, etc.

Example of installation

As shown in the diagrams, one of the possible applications is the installation of a T1 POLE twilight switch in the motorway lighting system.

When the external light falls below a certain level (for example at sunset), the pole-mounted twilight switch switches on the lights to provide the correct lighting for the setting. At sunrise, the external brightness exceeds the threshold value and the twilight relay returns to the open position.



10

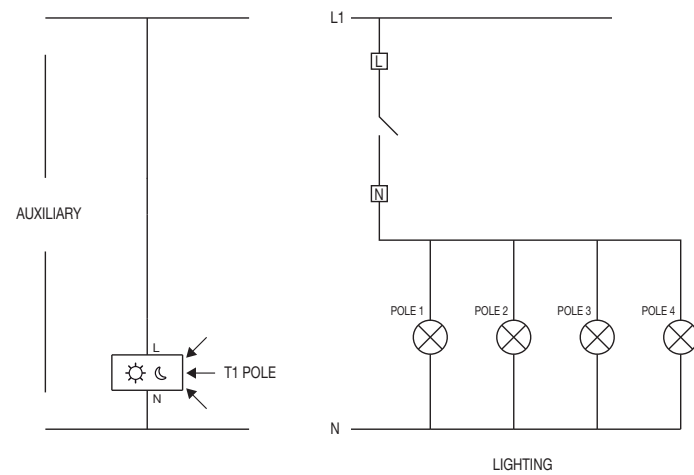
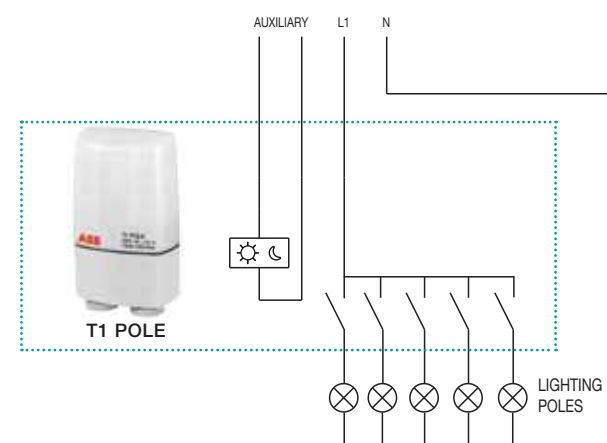

Control and automation technical details

TWA astronomical twilight switch

Operating principle

The installation of an astronomical twilight switch in a system is a particularly useful addition for settings and situations in which light sources, or other environmental conditions, can cause changes in the brightness level and falsify the reading. In these cases, the TWA-1 and TWA-2 astronomical switches can control the lighting system according to the sunrise and sunset times of the geographic zone in which the system is installed.

Application environments

The installation of the TWA-1 and TWA-2 astronomical twilight switches is particularly suitable for applications in which the operation of a twilight switch with external probe can be falsified or compromised by external agents (such as environmental pollution, overexposure to light, vandalism, etc.).

Example of installation

Atmospheric pollution is one of the causes of a reduction in the level of environmental light. Dust deposits on the external probe of a traditional twilight switch can compromise the operation of the device, preventing it from automatically switching off the controlled lighting system in the presence of external light.

As shown in the example, this problem can be resolved by installing a TWA-1 astronomical twilight switch that controls the lighting system according to the level of light calculated from the preset longitude and latitude parameters.

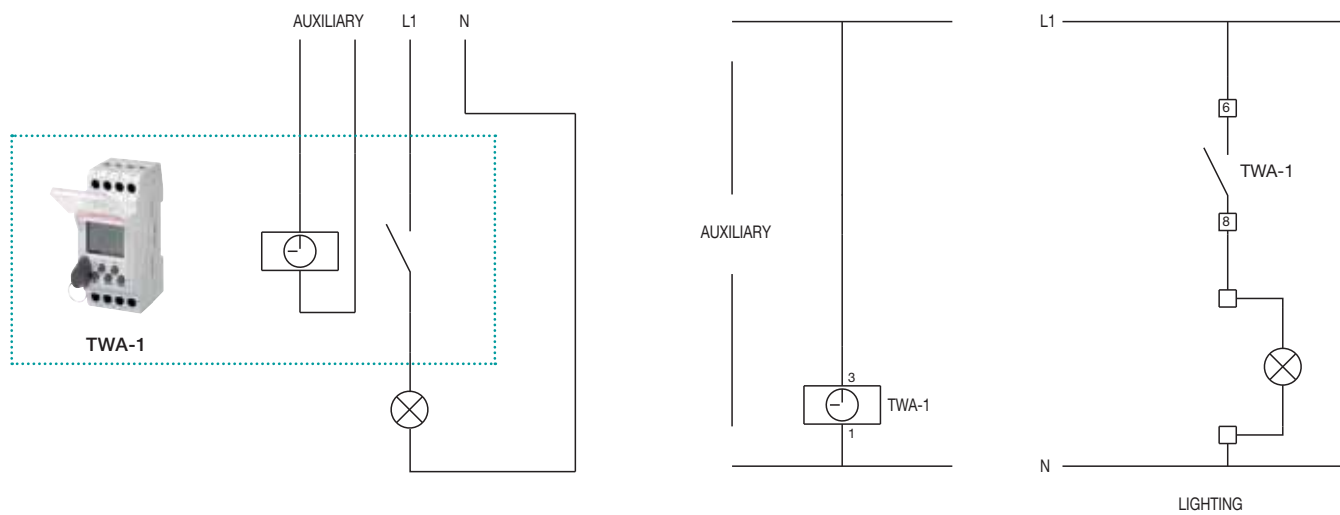
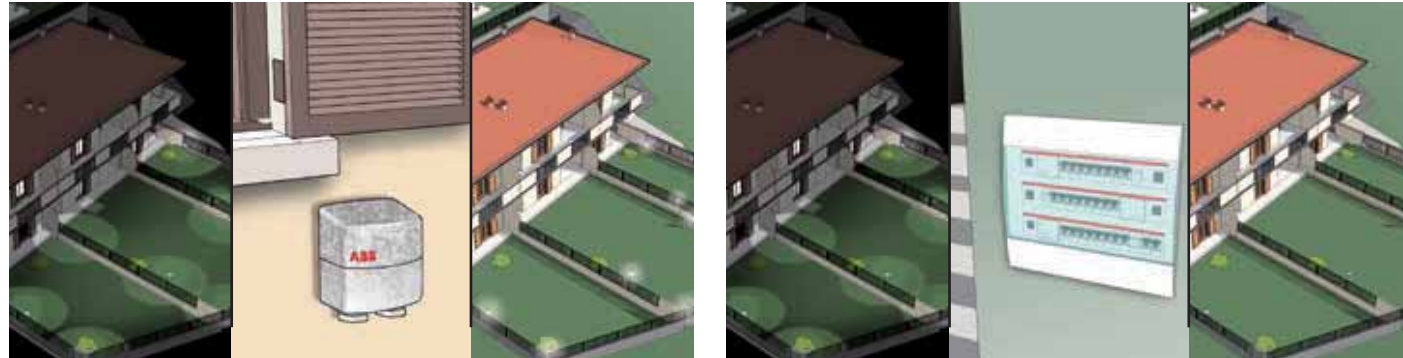

Control and automation technical details

THS modular thermostats

Controls and indicators

THS-C, THS-W

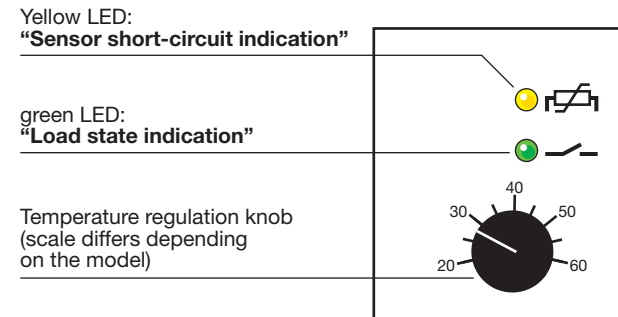

THS-S

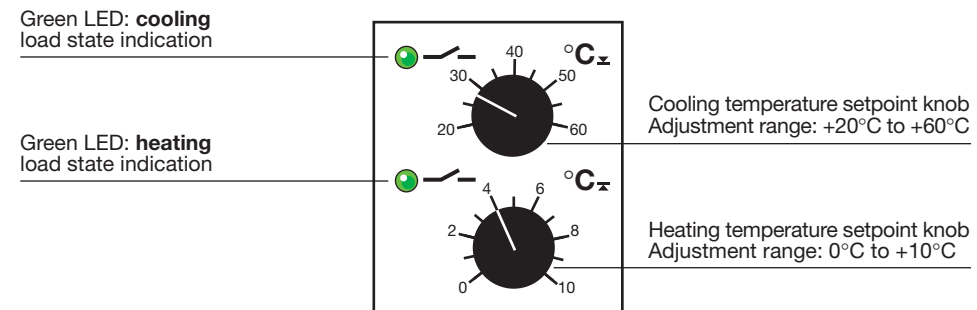

Mode of operation

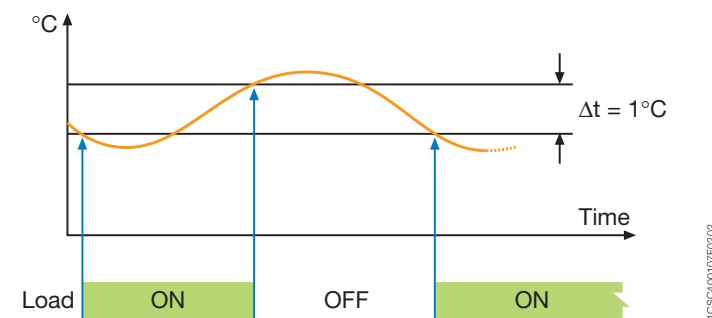

When the THS-C detects a temperature below the programmed setpoint, it closes contact 1 until the temperature returns above the setpoint. It then reopens the contact, and when the temperature again drops below the differential, the cycle is repeated.

THS-W operates in a similar manner, but the relay closes contact 5 when the temperature exceeds the programmed setpoint.

Sensor installation

The THS-1 and THS-4 remote temperature sensors (supplied separately) are waterproof and encapsulated in silicone rubber. They have an operating temperature range between -30°C and +130°C and are respectively 1.5 and 4 meters long.

Control and automation technical details

THS modular thermostats

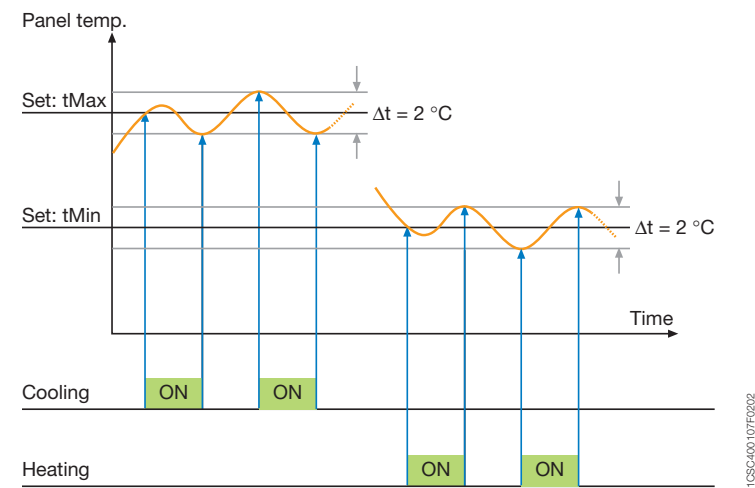

As shown in the figure, the THS-S switches on:

- The fan or air conditioner when the temperature in the panel exceeds the maximum setpoint programmed with the upper knob.
- The heating device when the panel temperature falls below the minimum setpoint programmed with the lower knob

Sensor installation

The remote temperature sensor is waterproof and able to withstand temperatures in the range from -30°C to $+85^{\circ}\text{C}$; it has a maximum connection length of 100m.

Operating principle

Modular thermometers let you control and keep a heating or cooling element at a set temperature, comparing the value read by the sensor with the one set by the user.

The THS range can thus guarantee switchboard operating reliability, perfect product conservation in refrigerated counters or cells, promote greenhouse production, optimise drying cycles, etc.

Application environments

THS thermostat installation is thus the best way to regulate temperature in automation and distribution switchboards, in heating systems, in industrial applications or to control refrigerator systems, greenhouses, dryers or isothermal folding portals.

Example of installation

As shown in the diagrams, one of the possible applications consists in the installation of a THS-S modular thermostat inside an automation or distribution switchboard where the temperature must be kept at a set value. Thanks to the THS-S thermostat, you can thus control the temperature, permitting cooling regulations between $+20 \div +60$ °C and anti-condensation between $0 \div +10$ °C. Furthermore, you can manage up to 3kW of point heaters without having to use any external contactors to manage the load.

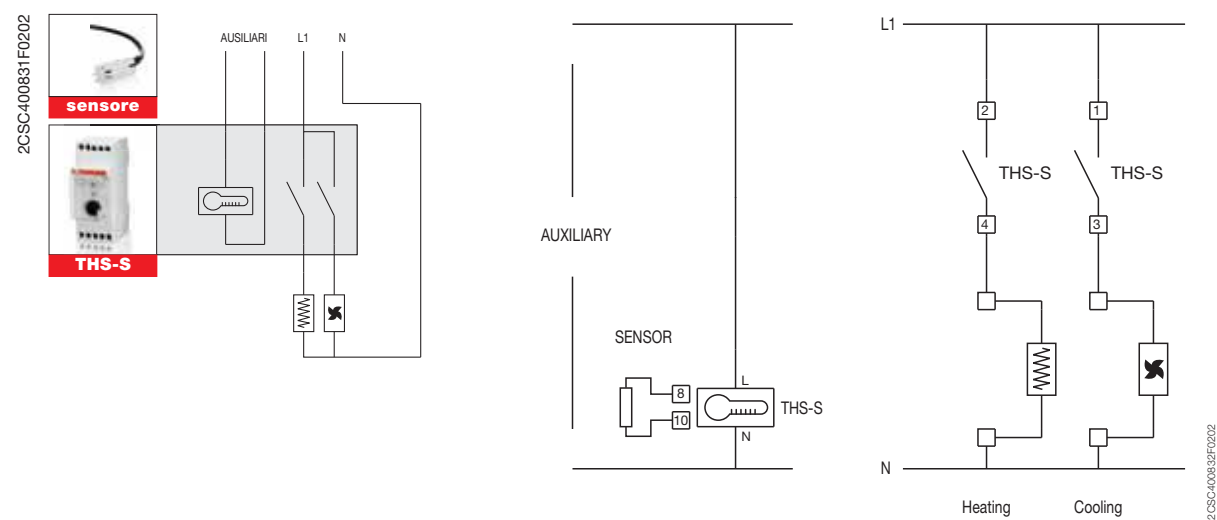

Control and automation technical details

ATT GSM modules

ATT-Tool

ATT-Tool configuration and programming software allows users to fully customise GSM ATT telephone module to their specific requirements. ATT-Tool has a simple and intuitive interface that allows ATT to be quickly configured without having to remember complicated programming strings or consult a manual to learn the programming syntax. ATT-Tool, available in all the main languages, makes it possible to:

- Add/remove up to 250 users authorised for complete or conditional use of ATT module.
- Add/remove up to 100 recipients of call rings, sms messages, faxes or emails.
- Configure the analog or digital activation mode of the inputs.
- Configure the activation mode of the outputs.
- Define actions to be performed at pre-established intervals.
- Remotely track users and events.
- Customise commands and alerts.
- Perform program debugging.

Operating principle

ATT-22 module is a GSM terminal with 2 outputs and 2 inputs for transmitting commands and alarms via SMS message, free phone call ring, fax or e-mail. Configuration is accomplished by means of SMS messages, or using the ATT-Tool software with ATT-22 connected to a PC.

Application environments

The ATT-22 module is especially suited for residential and services-sector installations in which loads need to be remotely monitored or controlled. ATT-22E version is equipped with a pre-wired external antenna, indispensable when the module is installed in places that do not guarantee adequate GSM coverage.

Example of installation

The figures illustrate an example application in which ATT-22 module is installed in the control panel of a second home in the mountains.

With a cell phone call ring to ATT-22, it is possible to switch on the boiler just before arriving at the house, or to keep it continually in operation. In the event of a problem with the boiler, ATT-22 sends a notification SMS.

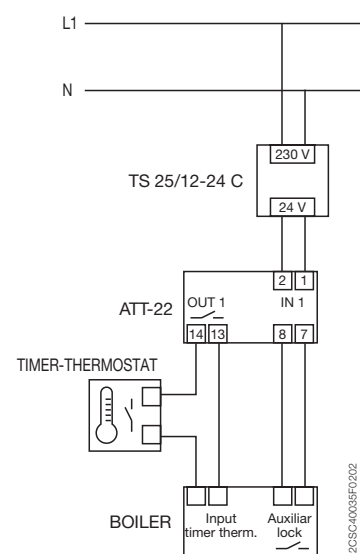
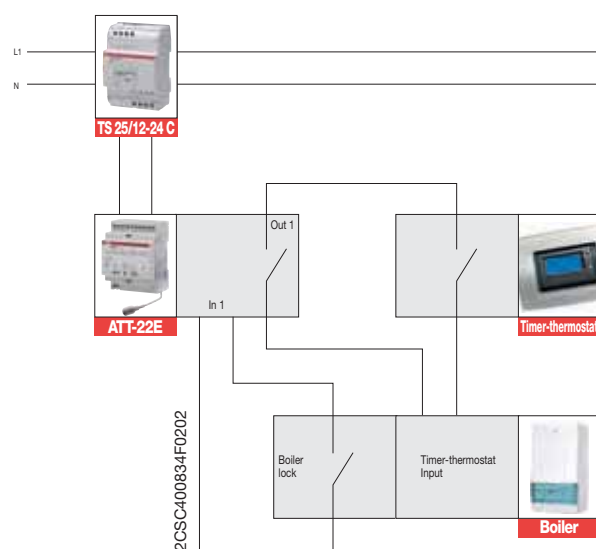
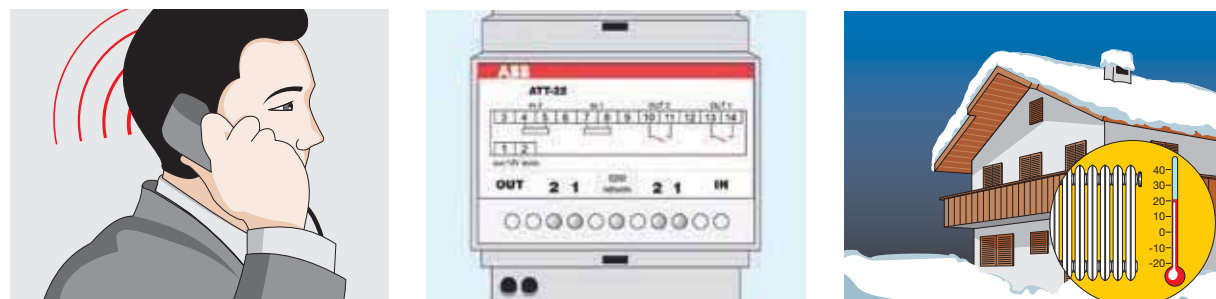

Control and automation technical details

ATT GSM modules

Operating principle

ATT-81 module is a GSM terminal with 8 inputs and one output for transmitting commands and alarms via SMS message, free phone call ring, fax or e-mail. Configuration is accomplished by means of SMS messages, or using the ATT-Tool software with ATT-81 connected to a PC.

Application environments

ATT-81 module is ideally suited to industrial and services-sector installations which require loads to be remotely monitored or controlled. ATT-81E version is provided with a pre-wired external antenna, indispensable when the module is installed in places that do not assure adequate GSM coverage.

Example of installation

The figures illustrate an example application in which ATT-81 is installed in the circuit of an unsupervised facility. In the event of a power outage, ATT-81 sends an alarm notification to the list of authorised users, while at the same time actuating the motor-driven command which reinstates the power supply.



10

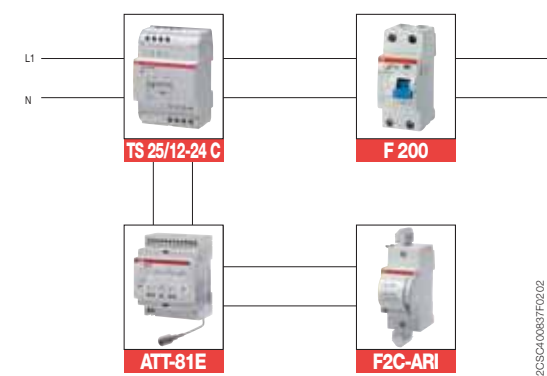

2CSC40002F0202

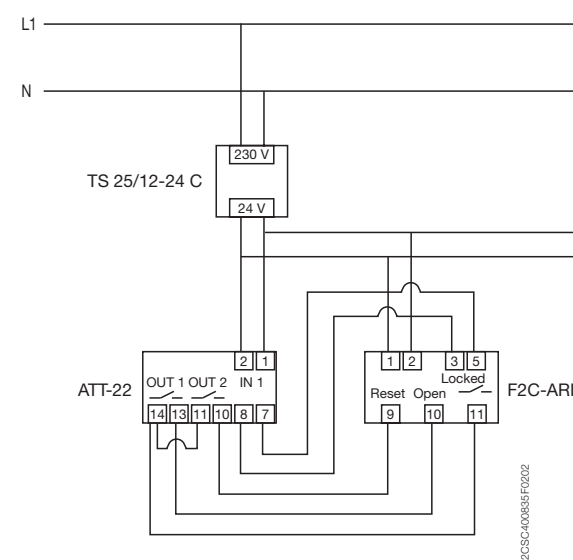

2CSC40002F0202

Control and automation technical details

RAL overload relays

Load release

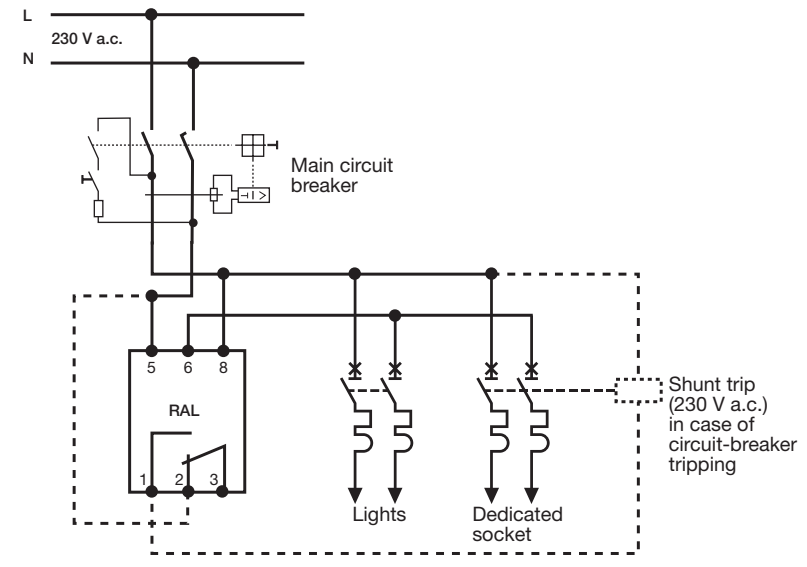

05FMO002

Control and automation technical details

RAL overload relays

Operating principle

The RAL overload relays constantly compare the maximum preset power consumption value to effective system power consumption.

Approaching allowed threshold, they signal to disconnect one of the loads through acoustic alarm avoiding the main circuit breaker tripping.

Connecting the undervoltage release to the appropriate contact, the RAL overload relays provide an acoustic alarm and simultaneously opens the circuit-breaker protecting one or more not primary loads.

Application environments

The installation of the RAL overload relays is suitable for any environment and situation in order to avoid power consumption which could trip the limiting circuit breaker of the system.

Example of installation

As shown in the diagrams, one of the possible applications is the installation of the RAL overload relays in the domestic system where the electric oven and washing machine are simultaneously switched on increasing the power consumption. When the power consumption approaches the preset threshold values, an acoustic alarm is activated and the washing machine switches off automatically through an undervoltage release.

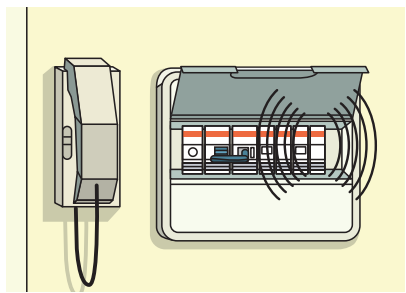
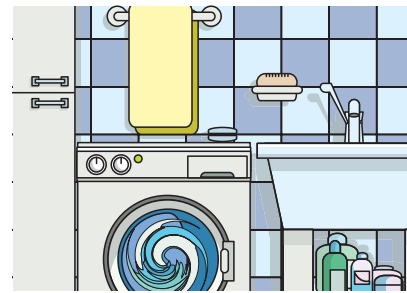
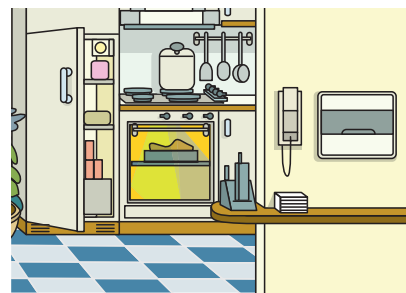
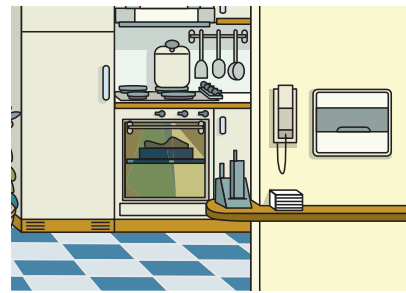

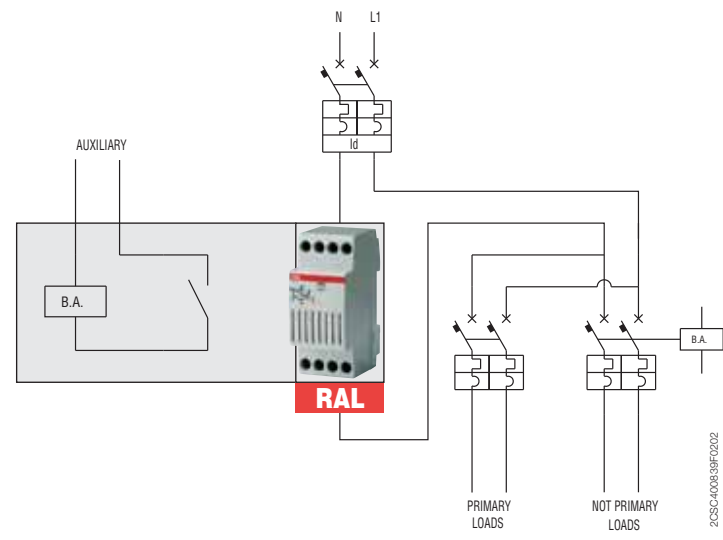

2CSC400838F0202

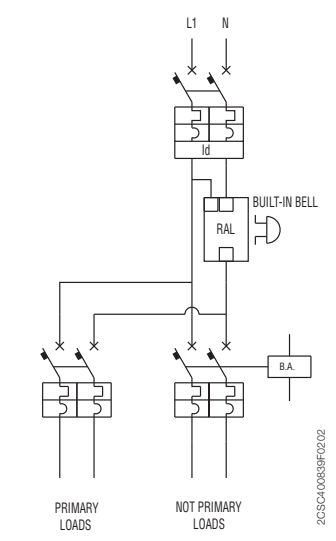
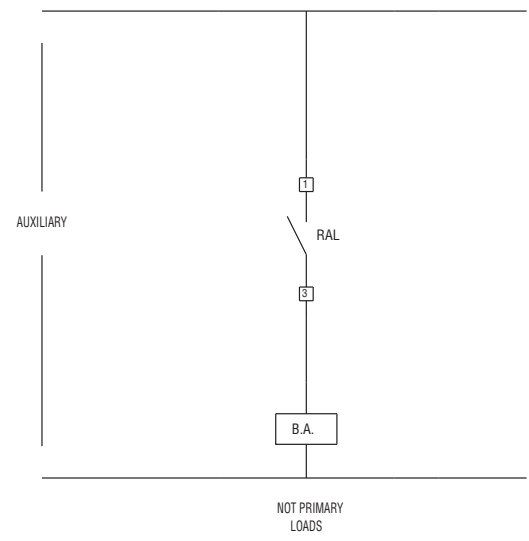

2CSC400838F0202

Control and automation technical details

LSS1/2 load shedding switch

Single-phase wiring diagram for non-prioritary loads with 16 A or more current consumption

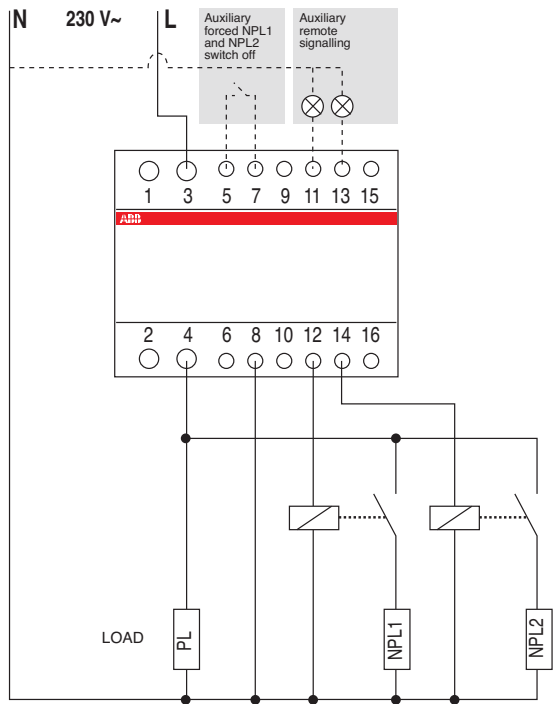

Single-phase wiring diagram

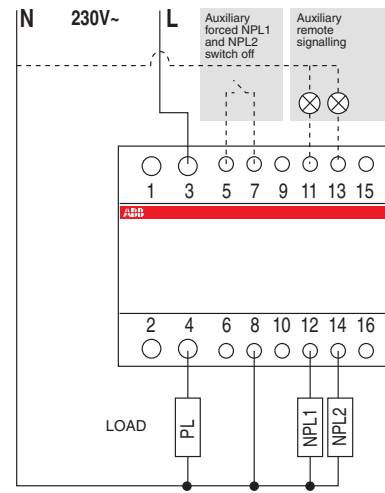

Balanced three-phase wiring diagram

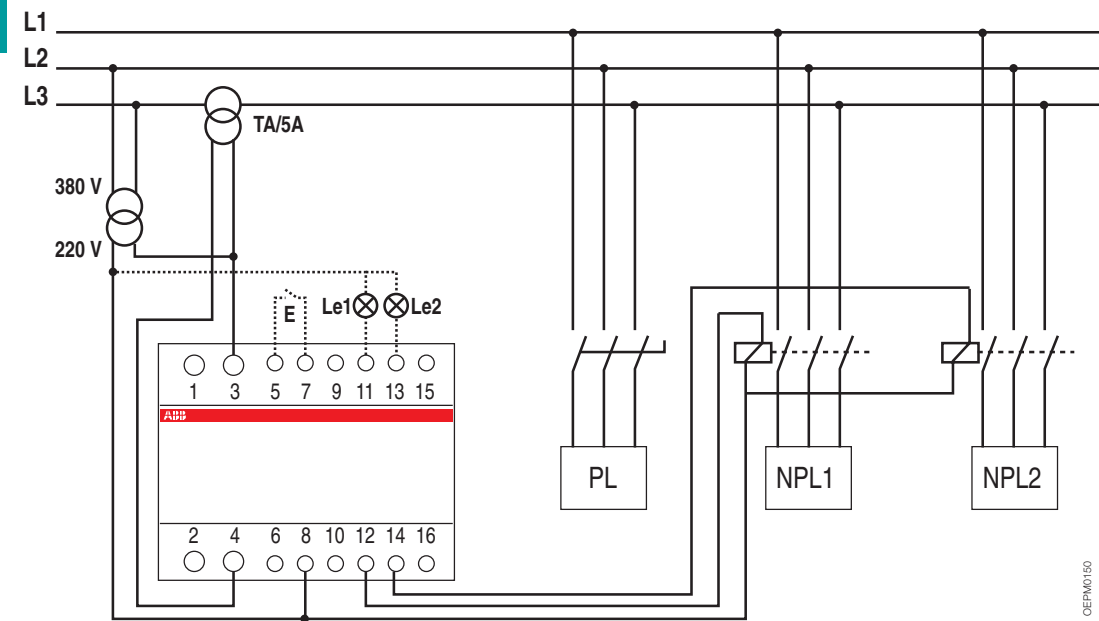

DEFRM0150

Operating principle

LSS1/2 load shedding switches are used in case of exceeding of consumption threshold allowed in the system by switching off in sequence one or two loads, if necessary. At preset intervals and until current consumption is not below the reference level, the switch tries to reset the disconnected loads.

Application environments

The installation of the LSS1/2 load shedding switches is suitable for any environment and situation where it is necessary to control electric energy consumption within consumption limits allowed in the system.

Example of installation

As shown in the diagrams, one of the possible applications is the installation of the LSS1/2 load shedding switches in a printing office system, where the conditioning switch-on causes the exceeding of the energy consumption threshold defined with the supplying company by contract. The LSS1/2 load shedding switch preserves printing machines operation by switching off one or two primary loads automatically (i.e. night conditioning and lighting), where ON red leds indicate temporary OFF. After a preset interval, the switch checks that current consumption values fall within the limits again trying to reset the previously disconnected loads.

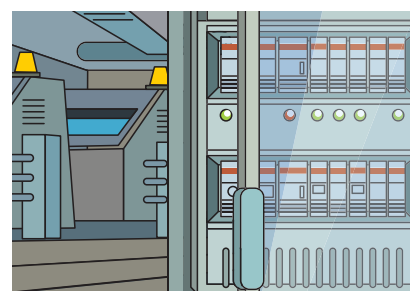

10



Control and automation technical details

LSS1/2 load shedding switch

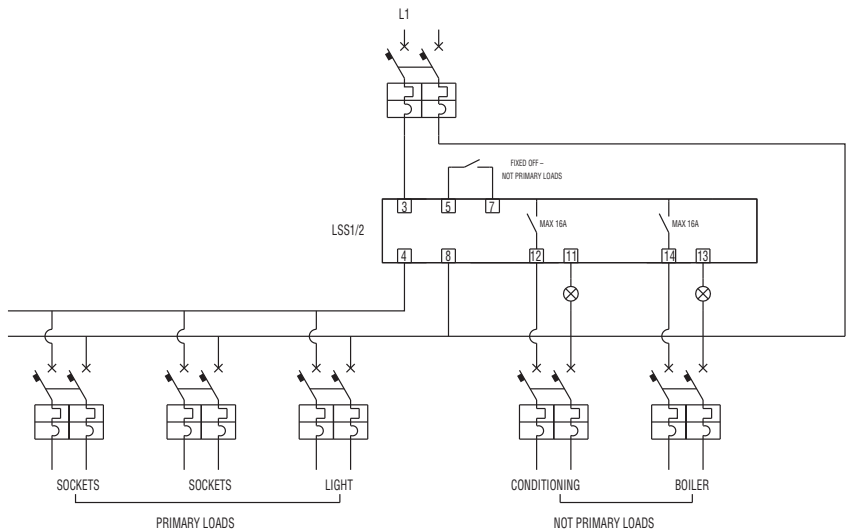
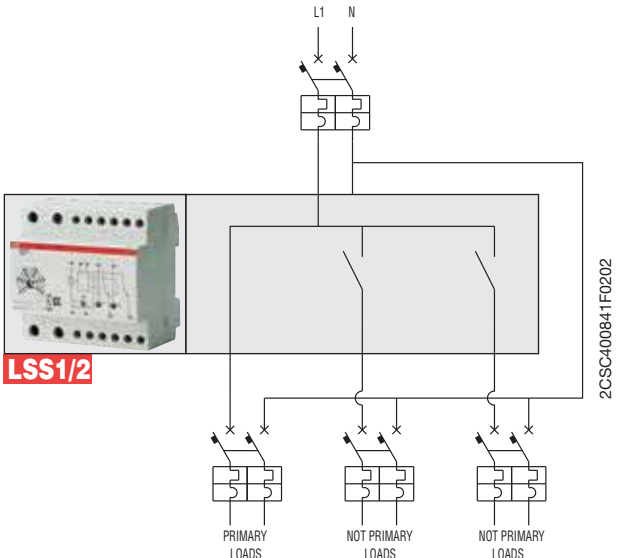

10

Control and automation technical details MeMo USB modular DIN rail device

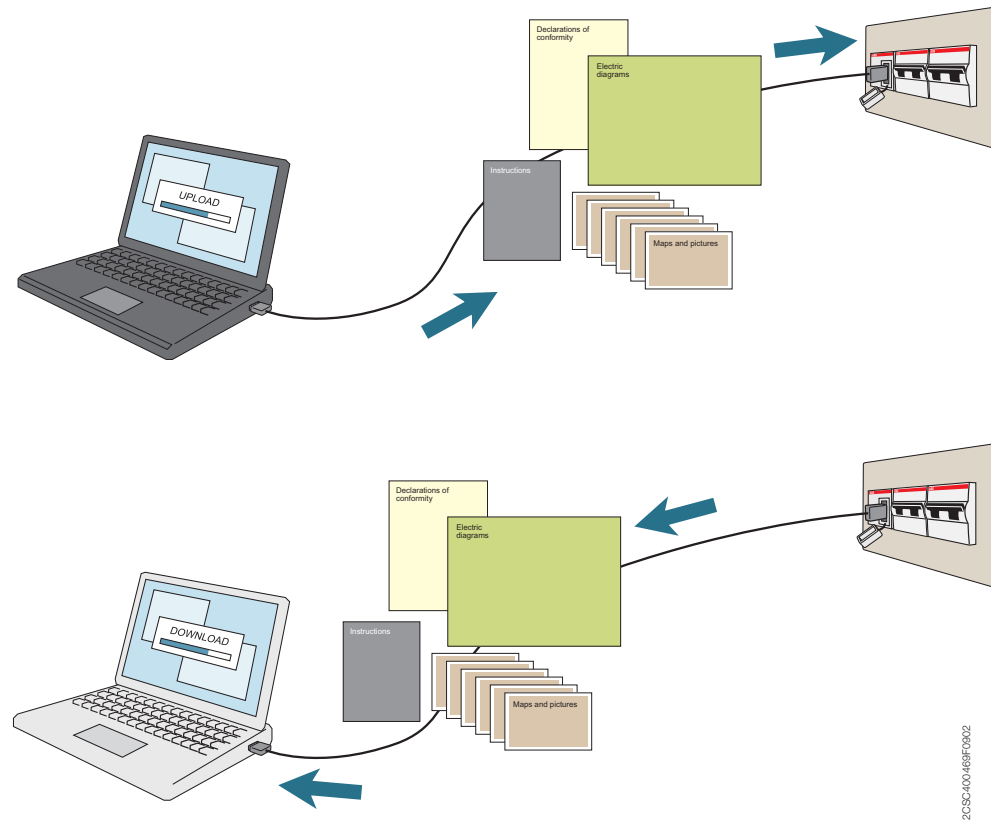

Operating principle

MeMo2 is USB device for DIN rail in two modules width to store and keep handy useful electronic information, such as files and applications, directly in the switchboards.

No electrical wiring is required, just mount the device on DIN rail choosing a convenient position to easily connect it to the PC.

MeMo2 is provided with a bidirectional roll cable to connect the device to all USB ports of your PC.

The PC or laptop automatically recognizes the device as an external memory allowing the transfer of files - no additional software is required.

The 60 cm roll cable is compliant with USB 2.0 standard to ensure maximum speed and reliability in uploading and downloading data.

You can easily protect your files by installing any encryption software on MeMo.

Application environments

MeMo is a useful device to get all your information inside switchboards or consumer units

Industrial applications:

- electric diagrams
- declarations of conformity
- products certifications
- test reports
- instructions
- warranties

Control and automation technical details

MeMo USB modular DIN rail device

Domestic applications:

- declaration of conformity for the installations (electric/thermal-hydraulic)
- maps and pictures of pipes of the building
- anti-intrusion system programming
- cadastral documentation if available in electronic format

Plus

- 2 GB and 4 GB versions
- information always available in the switchboard
- no more paper documentation
- save time: instant, easy and free update of documentation
- set up a master for serial switchboard
- easily find and edit your documentation
- customize information
- OEMs could save useful information such as spare parts list, technical assistance contacts, scheduled maintenance calendar.

Example of installation

Mounted in a convenient position inside the switchboard MeMo can save crucial information, files and applications concerning the plant. Data stored inside MeMo are always available for regular maintenance or in case of emergency.

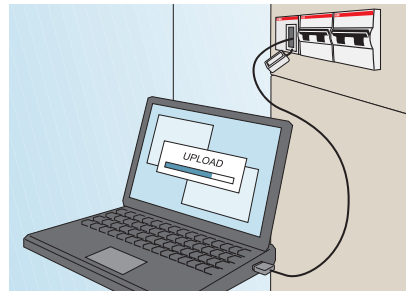
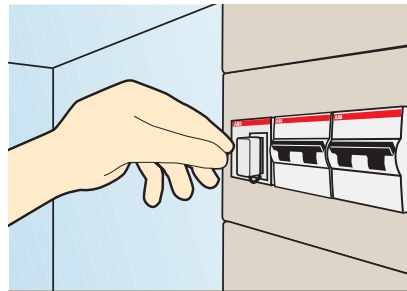

Energy efficiency technical details

Multimeters and network analyser

Communication networks with Modbus RTU protocol

Modbus is a serial communication protocol created for use with programmable logic controllers (PLC). It has become an industry standard and is the most widely used protocol for connecting of industrial electronic devices.

Its principal benefits are:

- Ease of use
- Low resource requirements
- Openly published and royalty-free
- Allows communication between many devices connected to the same network

The Modbus support was created for controlling transfer on the line and pipeline monitoring. The system's flexibility and reliability make it suitable for a wide variety of processes and operations in nearly every industry.

Modbus determines how many MASTERS and SLAVES to recognise and connect together, how many senders and receivers are identified, how many messages are exchanged in an orderly manner and how many errors occur.

Every peripheral that needs to communicate via Modbus is assigned a unique address.

Any one of them can then send a Modbus command, although generally (necessarily, in the case of serial) only one peripheral acts as a master.

A Modbus command contains the Modbus address of the peripheral it is intended for, and only that peripheral will act on the command, even though all the others receive it as well.

All Modbus commands incorporate control information to ensure that the received command is correct.

Conventional I/O system

Plus

Field devices unaffected from wiring error caused by other devices thanks to independent wiring
Devices are cheaper
Well known technology

Minus

Higher installation complexity caused by:
point to point wiring
many terminal blocks, need additional rack space or more cabinets
troubleshooting on complex wiring
increased number of point of failure
longer initial check and start up
Expensive installation

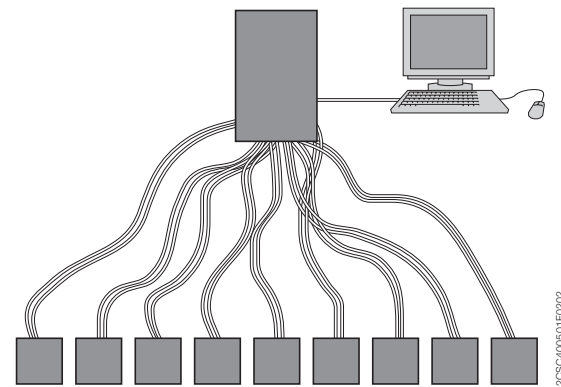

10

Modbus Network

Plus

Well known protocol, fully documented
Many PLC, DCS and process systems are supporting this protocol
Many facilities already use it
Optimum choice when:
Modbus network or devices are being used
Modbus protocol is already used as a facility standard

Minus

Device operations require separate power
Limited diagnostic capabilities (device applications)
Limited use as a device bus

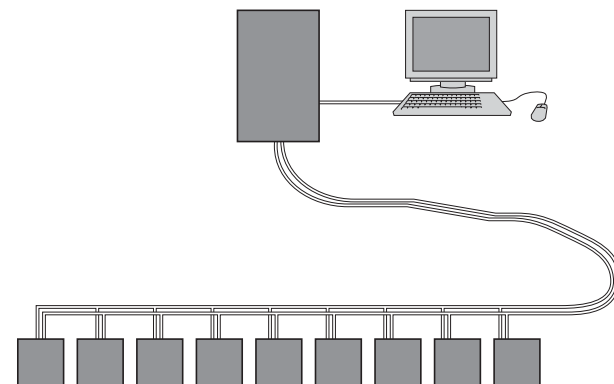

Energy efficiency technical details

Multimeters and network analyser

Application example

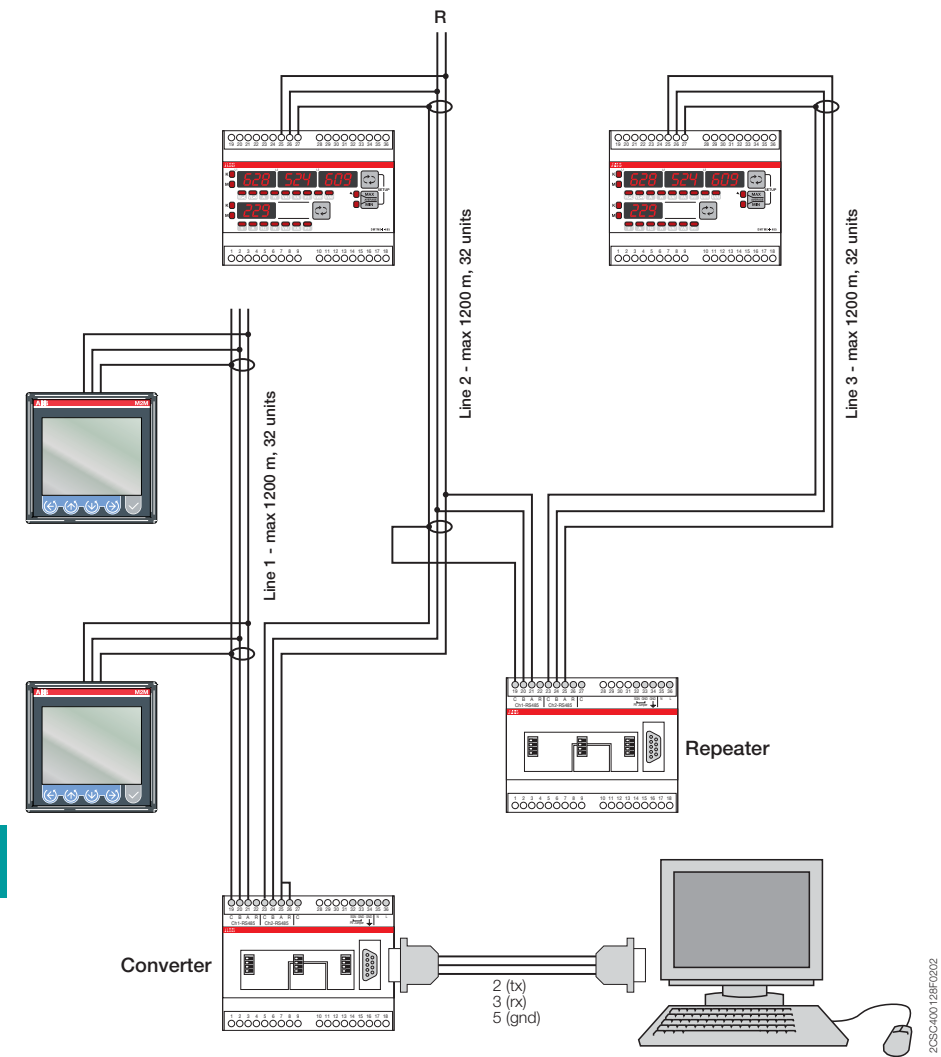

Connection among the devices

The protocol has one Master and up to 247 Slaves on a common line covering a maximum distance of 1200 metres. Only the Master initiates transactions. The transactions are of the request/reply type (addressed to a single Slave) or of the broadcast/reply type (addressed to all Slaves).

Modbus is often used for connecting a supervisory computer with a remote terminal unit (RTU) in supervisory control and data acquisition systems (SCADA). There are two versions of the protocol: one for serial ports (RS232 by default, but also RS485) and one for Ethernet.

Modbus uses a compact hexadecimal data representation. The RTU format appends to commands/data a cyclic redundancy checksum (CRC) field, while the ASCII format uses an LRU type (longitudinal redundancy check) checksum.

Unicast mode

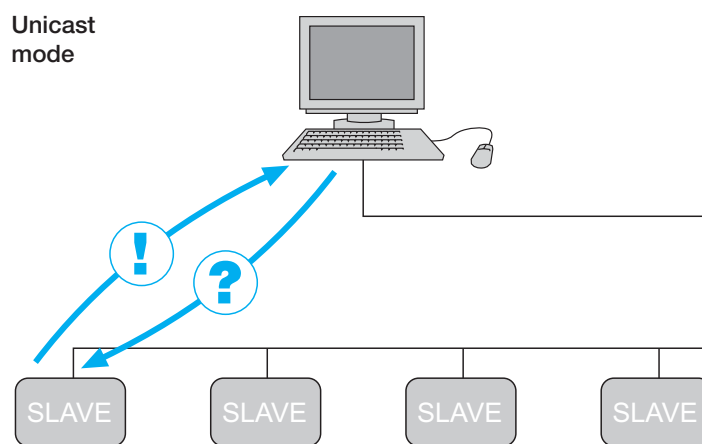

Broadcast mode

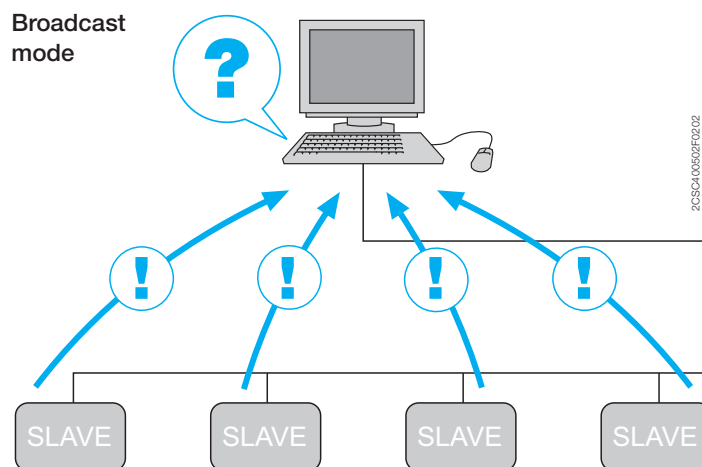

Energy efficiency technical details

DMTME multimeters

DMTME multimeters

The DMTME series instruments are digital multimeters that measure the true rms value of the principal electrical quantities in 230/400 V a.c. networks, with the ability to store in memory the maximum/minimum/average measured values, and meter active and reactive energy.

Four red LED displays provide a clear local readout of multiple measurements simultaneously. The DMTME multimeters perform the functions of a voltmeter, ammeter, power factor meter, wattmeter, varmeter, frequency meter, active and reactive energy meter in a single instrument, thus substantially reducing installation space requirements and wiring time.

The DMTME-I-485 version is additionally equipped with a pulse output and RS485 port for communicating the measured parameters via a Modbus network.

All versions come with a mini CD containing the instruction manuals, technical documentation, communication protocol and the DMTME-SW software.

The main innovations of the range are:

- Automatic recognition of the C.T. connection polarity, which simplifies installation of the instrument, making it error-proof.
- An hour counter for scheduled maintenance and an instrument life time display, to assist the installer with routine activities.
- Separate auxiliary 115/230 V a.c. power supply on all models, with extractable terminal blocks.

The DMTME-SW software can perform real-time acquisition of all the readings of a multimeter or network of DMTME multimeters, with the values displayed in a single on-screen window. The measurements are shown in both numeric and "analog instrument" format.

DMTME-SW also functions as a simple Modbus communication test instrument, allowing the installer to check the correct operation of the network prior to testing by the system integrator. Configuration example of networked DMTME multimeters

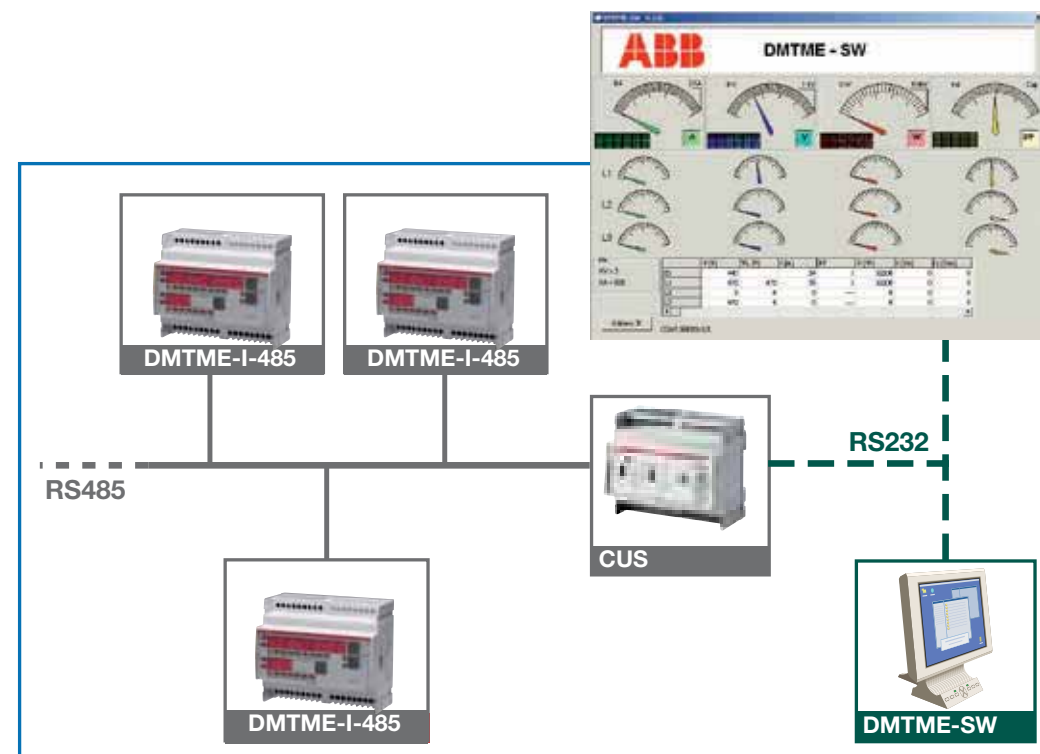

Operating principle

Beyond the custom functions of electric measure, the DMTME-I-485 multimeter is equipped with two programmable relays used as output alarms.

The setting of the alarm thresholds of all the network electrical parameters allows the customer to hold always under control its own system.

Application environments

The installation of DMTME-I-485 multimeter is adapt in all those cases in which the customer must hold under remote control its own system.

The use of the multimeter allows to set up system automation, to prevent malfunctions, dued to overloads and undervoltages, to manage maintainance and to prevent overcoming of the contractual power, avoiding penal from the energy supplier.

The multimeter can carry out the same functions of the LSS1/2 load shedding switch, with the advantage of allowing installation in three-phase systems, instead of only single phase systems.

Example of installation

A possible application is the installation of DMTME-I-485 inside an electrical distribution switchboard of an industrial system.

It's possible to set up an alarm based on the total absorbed power from the system. When the power exceeds the set up threshold, the switching of the multimeter inner contact excitates the coil of an auxiliary external relay.

The switching of the external relay, a ESB contactor or a E234 electronic timer, detaches a non primary load to lower the absorption levels of the entire system.

This application can be performed also by using M2M and ANR network analyser.

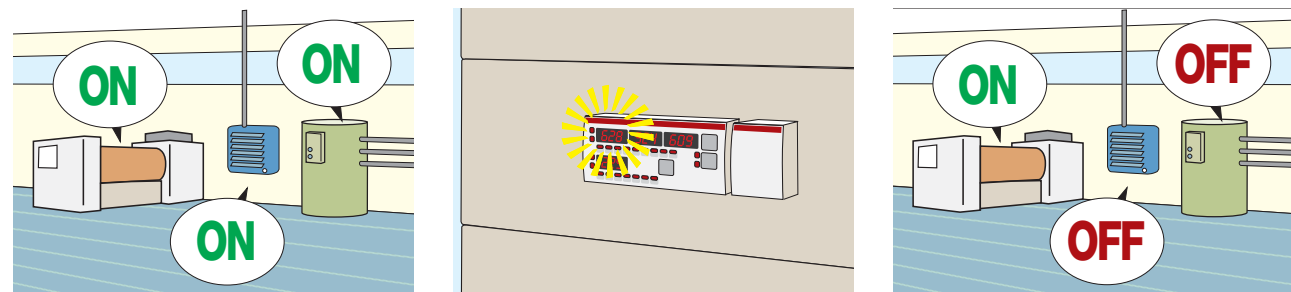

10

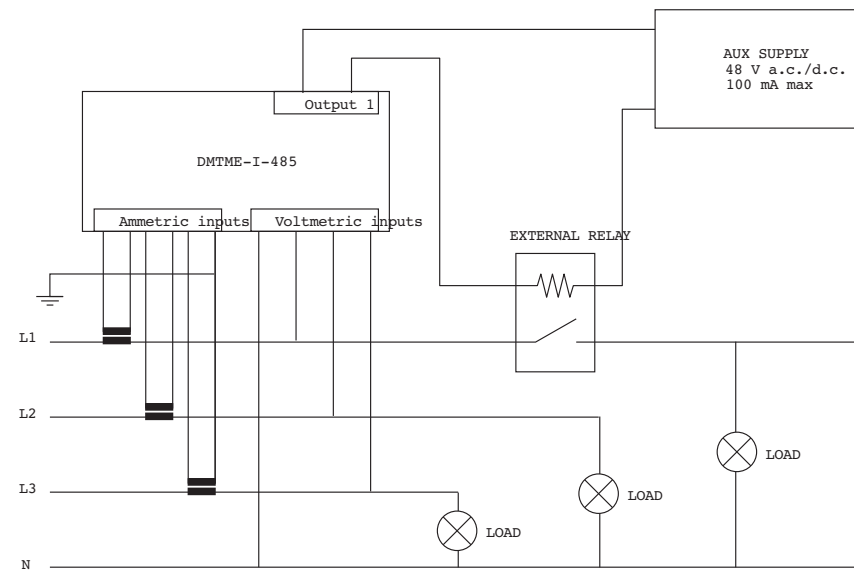

2CSC40049C022

Energy efficiency technical details

DMTME multimeters

Operating principle

In addition to measuring the main electrical quantities, the DMTME-I-485-96 digital front panel multimeter has a serial port for implementing a communication network, and two digital outputs which can be configured as alarm outputs. Programmable alarm thresholds on all the electrical parameters of the network allow the user to continually monitor the entire installation.

Application environments

The DMTME-I-485-96 multimeter is ideal for those situations where users must remotely monitor their installation. The multimeter makes it possible to implement system automation, prevent malfunctions due to overloads and undervoltages, manage maintenance, and monitor the functioning of the installation.

Example of installation

The figures show an application example in which the DMTME-I-485-96 is installed in a motorway tunnel panel, with an alarm threshold programmed on the total power consumption of the row of lights.

If one or more lamps burn out, the total power consumption drops and triggers an alarm.

Remote acquisition of this data thus allows a maintenance technicians to be sent out only when effectively needed.

This application can be performed also by using M2M and ANR network analyser.

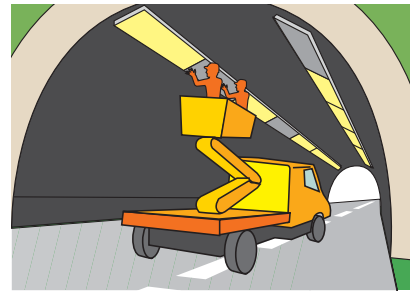

10

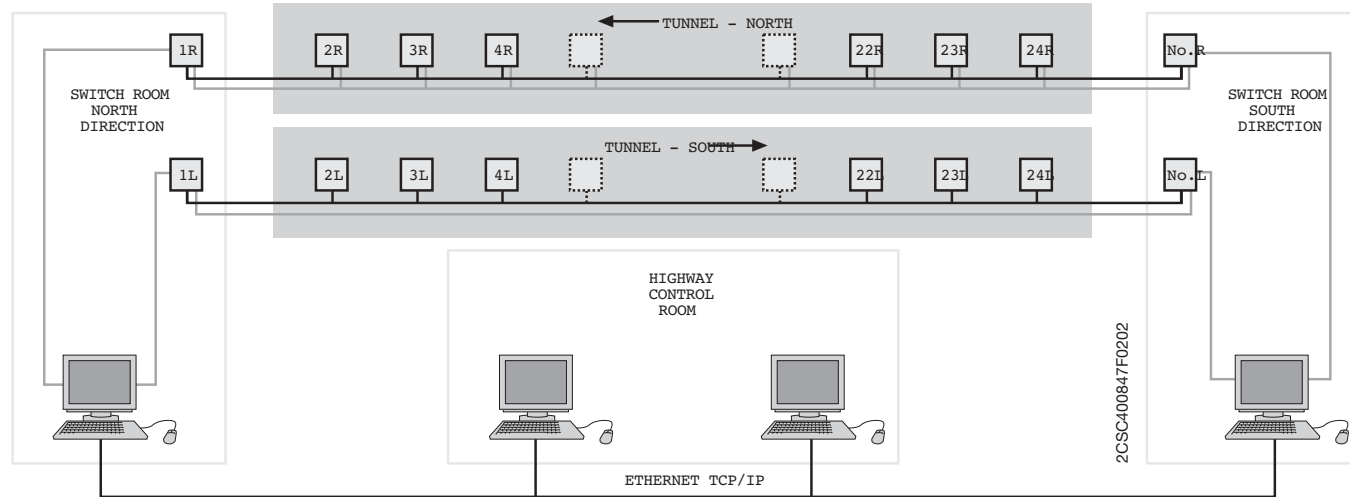

Energy efficiency technical details

ANR Network analyser

Operating principle

The ANR network analyser can perform a variety of functions. In this example the ANR is used as a data concentrator, acquiring incoming data from other measuring devices and energy meters, and as a load manager.

The digital outputs in fact allow alarm thresholds to be programmed which, if breached, will trigger audible and visible alarm signals, or command the energising of a relay coil or switch to disconnect a particular load, thereby implementing effective automated management of energy consumption to comply with the maximum power draw permitted under the contract with the energy supplier.

Application environments

ANR is suitable for industrial and services sector applications which require implementing control of energy consumption, optimising service continuity and managing the quality of the network.

Example of installation

As illustrated in the figures, the ANR can be used to allocate power consumption among production cycles and track the share of energy costs in the total product cost.

Through its digital inputs, the ANR is able to acquire the pulse signals output by various energy meters and thus keep track of their totals.

This application can be performed also by using M2M and DMTME network analyser.

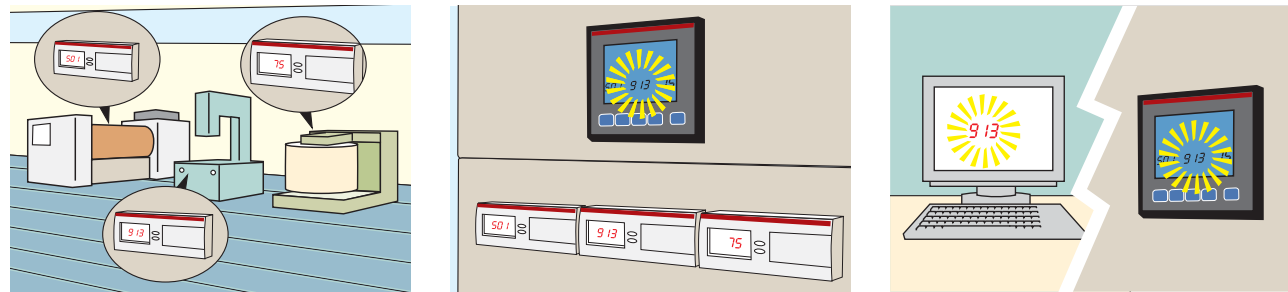

Energy efficiency technical details

M2M Network analyser

Operating principle

Among its several functionalities, M2M performs bidirectional metering of energy and power on the 4 quadrants, allowing both production and consumption of energy to be monitored with a single device.

With the M2M analyser it is possible to keep the electrical consumption of all types of system under control, measuring them in real time both in economic and environmental impact terms, thanks to the immediate conversion of the energy balance into Euros and CO₂ kg.

Application environment

M2M bidirectional reading allows the amount of produced and consumed energy, saved money and avoided pollution to be displayed, optimal in systems generating energy from renewable sources. At the same time the possibility of keeping the quality of electrical parameters under control helps in achieving positive results on safety and operating costs.

Example of installation

A typical application where to use these M2M functionalities is a photovoltaic plant. By activating the GENERATION option, the energy counts will be carried out on 4 quadrants separating energy and absorbed power. Through the monitoring of network THD and Power factor, M2M can control harmonic distortion introduced in the system by non-linear loads such as inverter, computers, etc.

The integration of electrical consumption measurement in a supervision system can be done via the most advanced communication protocols (Modbus RTU, Modbus TCP/IP and Profibus DP) allowing 360° analysis of system performances.

This application can be performed also by using ANR network analyser.

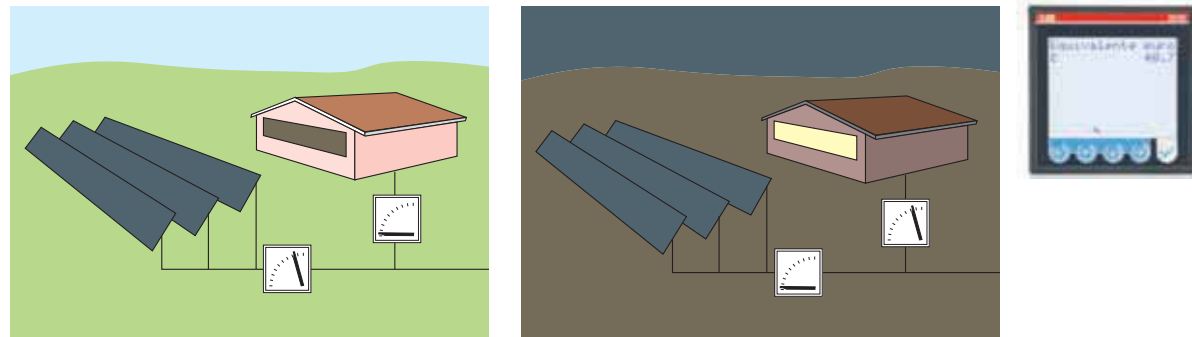

Energy efficiency technical details

Digital instruments

Alarm activation logic

Device status	NO polarity (default)	NC polarity
Instrument not supplied		
Instrument supplied - no alarm		
Instrument supplied - alarm condition		

Digital measurement instruments with relays

Control of a load with the following characteristics:

$I_n = 5 \text{ A}$ (rated normal operating current)

$V_n = 230 \text{ V a.c.}$ (rated normal operating voltage)

$V_{min} = 200 \text{ V a.c.}$ (RLV relay trip)

To scroll through the menu items press briefly (<3sec); to confirm press and hold (>3sec).

- 1 Connect as shown in the diagram ($V_{min} = 200 \text{ V}$).
- 2 Press and hold the key to enter the programming menu.
- 3 Scroll to the ACC menu item and confirm, then choose CC to select direct current operation, and confirm.
- 4 Set the full scale value to 300 V
- 5 Set the alarm threshold at 70 and confirm.
- 6 Adjust the Delay trimmer: scroll to the dLY menu item and confirm, then select the relay tripping delay (1...30 sec).
- 7 Program the alarm reset hysteresis (HySTeresis) at 10% of the threshold: scroll to the HST menu item, confirm, and select the value 10. This results in a trip window between 200 and 220 V. The relay will be tripped at 200 V and return to normal operation at 220 V.
- 8 Set the alarm output polarity: scroll to the OUt menu item and confirm, then choose whether the contact opens or closes when an alarm is triggered (N.O. by default).

10

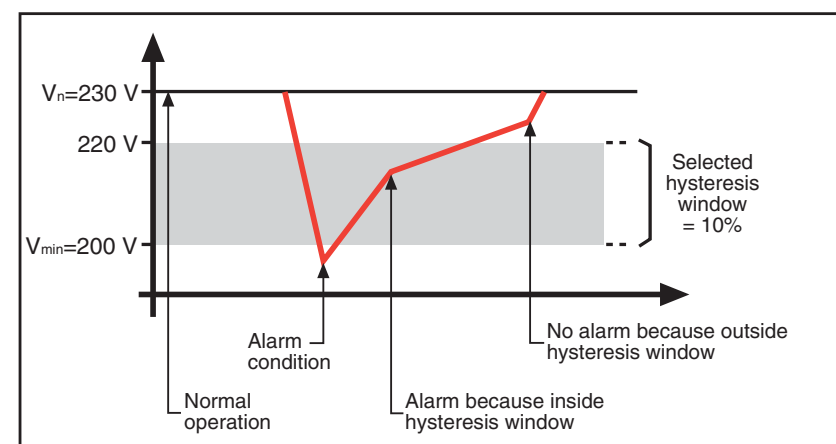
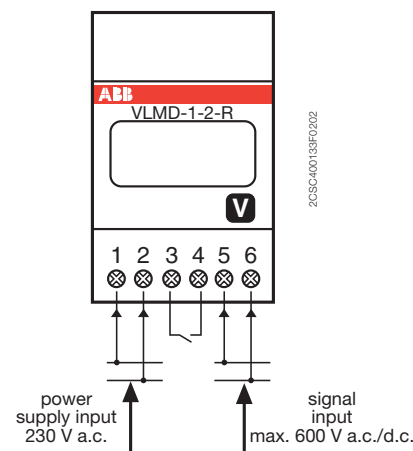

Energy efficiency technical details

Digital instruments

Voltmeters menu layout

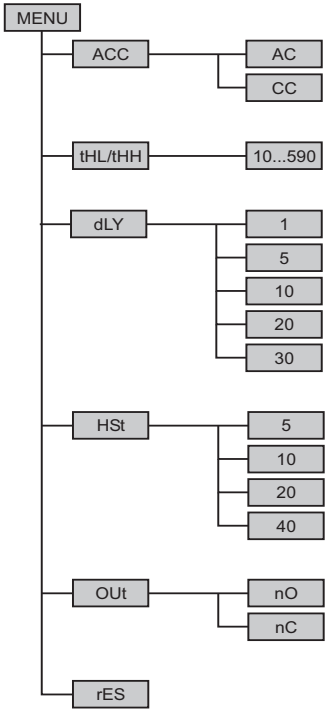

Ammeters menu layout

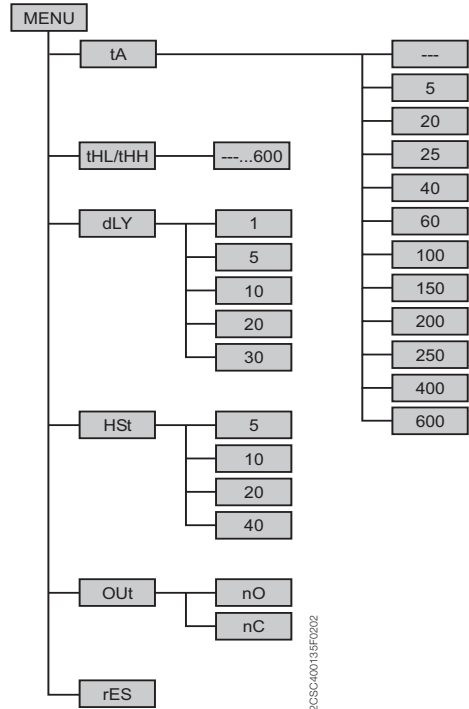

2CSC400195F0202

Energy efficiency technical details

TMD temperature control units

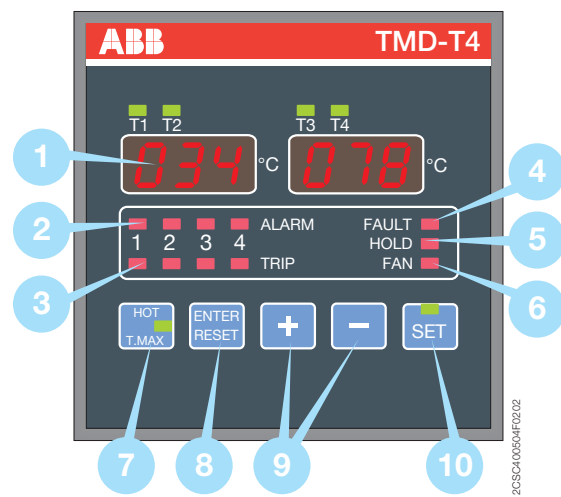

- 1 Display for viewing temperature values and settings
- 2 ALARM LED for viewing alarm status of measuring channels
- 3 TRIP LED for viewing trip status (second-level alarm) of measuring channels
- 4 FAULT LED for indicating temperature control unit and sensor faults
- 5 HOLD LED for indicating whether manual reset function is enabled
- 6 FAN LED for indicating whether fan output is enabled
- 7 MAX T. pushbutton for selecting to view the max temperature level
- 8 ENTER/RESET pushbutton for confirming the programmed settings and for manually resetting any alarms that have been tripped
- 9 +/- pushbuttons for selecting the measuring channels and for adjusting the programming parameters
- 10 SET pushbutton with status LED for accessing and programming the device's settings

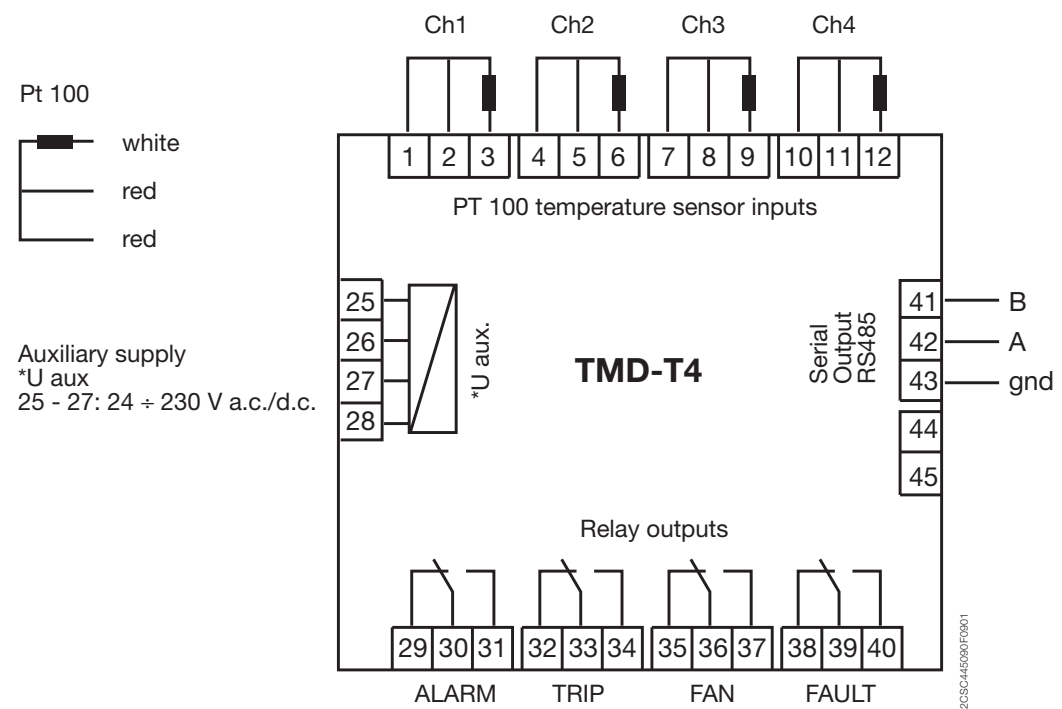

Energy efficiency technical details

Measurement current transformers with through primary

Power consumption of copper cables between the device and the transformer

For 5 A secondary

Cable section mm ²	Power (two-pole cable) VA					
	VA					
	Distance					
	1 m	2 m	4 m	6 m	8 m	10 m
1.5	0.58	1.15	2.31	3.46	4.62	5.77
2.5	0.36	0.71	1.43	2.14	2.86	3.57
4	0.22	0.45	0.89	1.34	1.79	2.24
6	0.15	0.30	0.60	0.89	1.19	1.49
10	0.09	0.18	0.36	0.54	0.71	0.89

Maximum load (A) on copper bars according to DIN 43670 and 43671

Bar dimensions mm	Rated current (In) A		
	1 bar	2 bars	3 bars
20x5	325	560	
20x10	427	925	1180
30x5	379	672	896
30x10	573	1060	1480
40x5	482	836	1090
40x10	715	1290	1770
50x10	852	1510	2040
60x10	985	1720	2300
80x10	1240	2110	2790
100x10	1490	2480	3260

Rating	Ratio fault limit in %			
	0.05 In	0.2 In	In	1.2 In
0.5	±1	±0.75	±0.5	±0.5
1	±2	±1.5	±1	±1
3	From 0.5 In to 1.2 In = ±3			

Rating	Angle fault limit in %			
	0.05 In	0.2 In	In	1.2 In
0.5	±1.8	±1.35	±0.9	±0.9
1	±3.6	±2.7	±1.8	±1.8
3	No prescriptions			

Accuracy rating

- 0.5 rating is required for power meters.
- 1 rating is required for unofficial power measures and power meters (measurements within the firm).
- 3 rating is required for relays and protection devices.

Error Curves

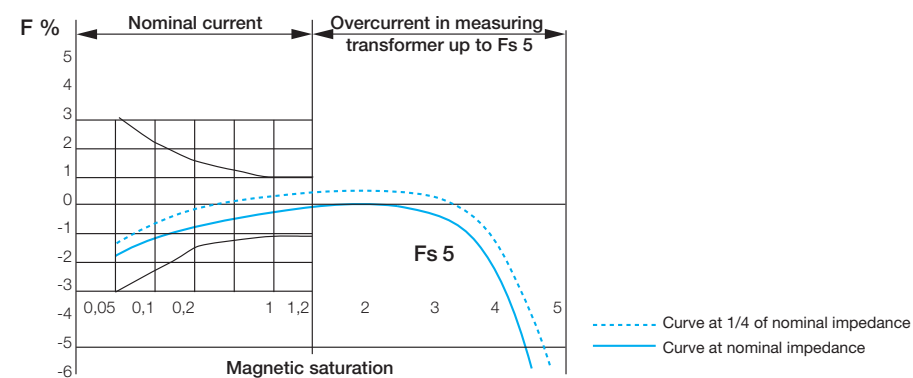

System pro M compact®

Quick product references

Wiring diagrams

MCBs	11/2
RCDs	11/4
RCD-blocks	11/6
RCBOs	11/7
Residual current relays	11/8
Auxiliary elements	11/12
Protection and safety	11/17
Command and signalling	11/33
Control and automation	11/41
Energy efficiency	11/49

Overall dimensions

Product with modular profile	11/58
Product without modular profile	11/65

Worldwide marks and approvals

MCBs and RCDs	11/92
MDRCs	11/96







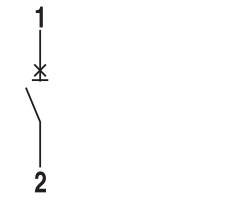
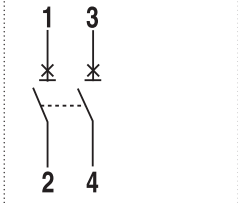
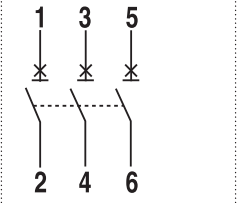
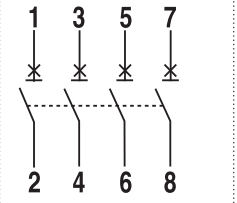
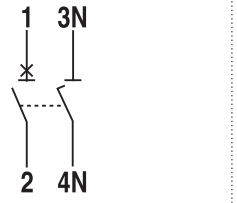
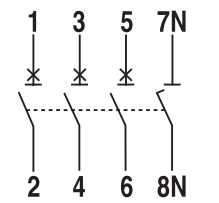

Alphabetical index

Alphabetical index	11/98
--------------------	-------

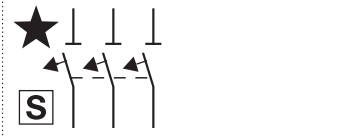
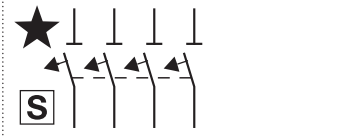
Quick product references

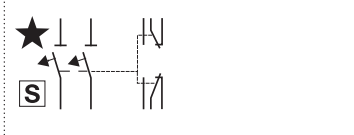
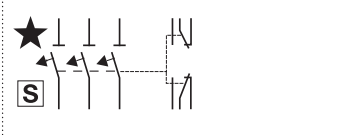
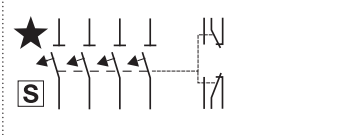
MCBs wiring diagrams

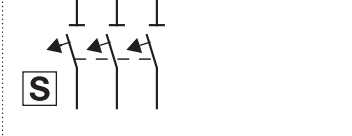
MCBs

<p>S 201</p> 	<p>S 202</p> 	<p>S 203</p> 	<p>S 204</p> 	<p>S 201 Na</p> 	<p>S 203 Na</p> 		
<p>S 701</p> 		<p>S 702</p> 		<p>S 703</p> 		<p>S 704</p> 	
<p>S 701+H2WR</p> 		<p>S 702+H2WR</p> 		<p>S 703+H2WR</p> 		<p>S 704+H2WR</p> 	
<p>S 751 DR</p> 		<p>S 752 DR</p> 		<p>S 753 DR</p> 		<p>S 754 DR</p> 	

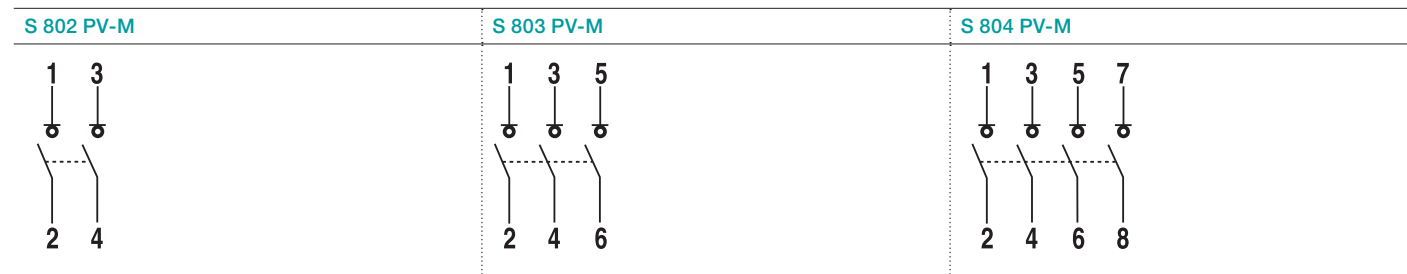
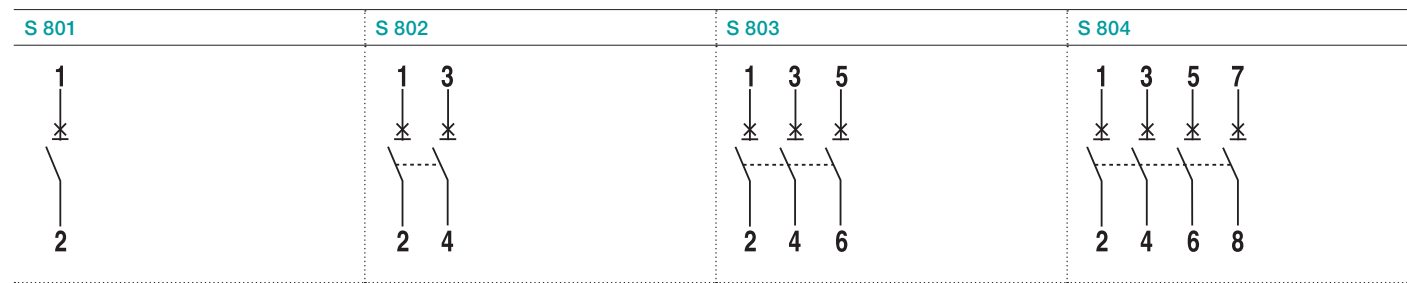

Quick product references

RCDs wiring diagrams

RCDs

<p>F 202</p>	<p>F 204</p>	<p>F 204 left neutral</p>
<p>F 202 PV B type</p>	<p>F 204 PV B type</p>	<p>F 204 PV B type left neutral</p>

RCD-blocks

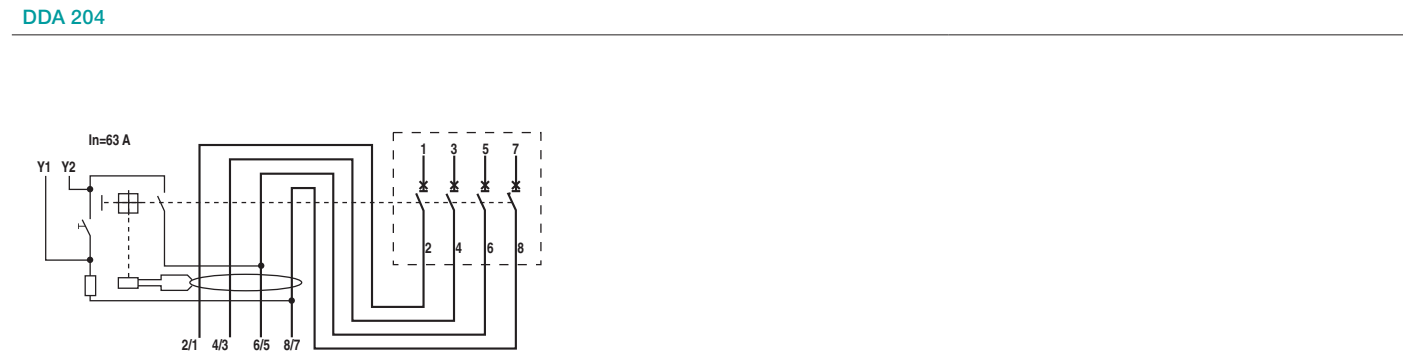
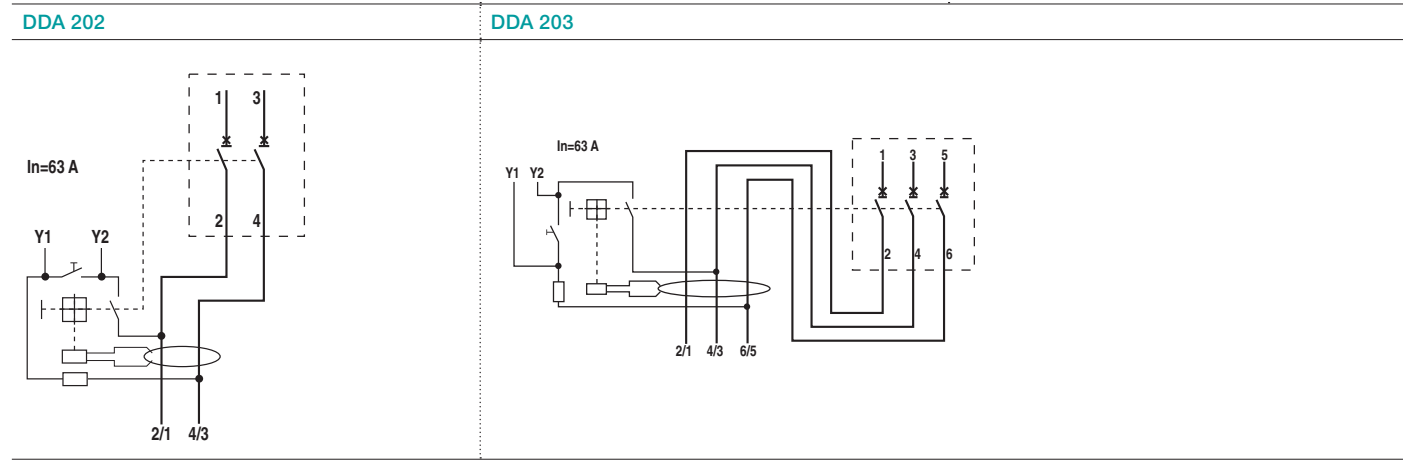
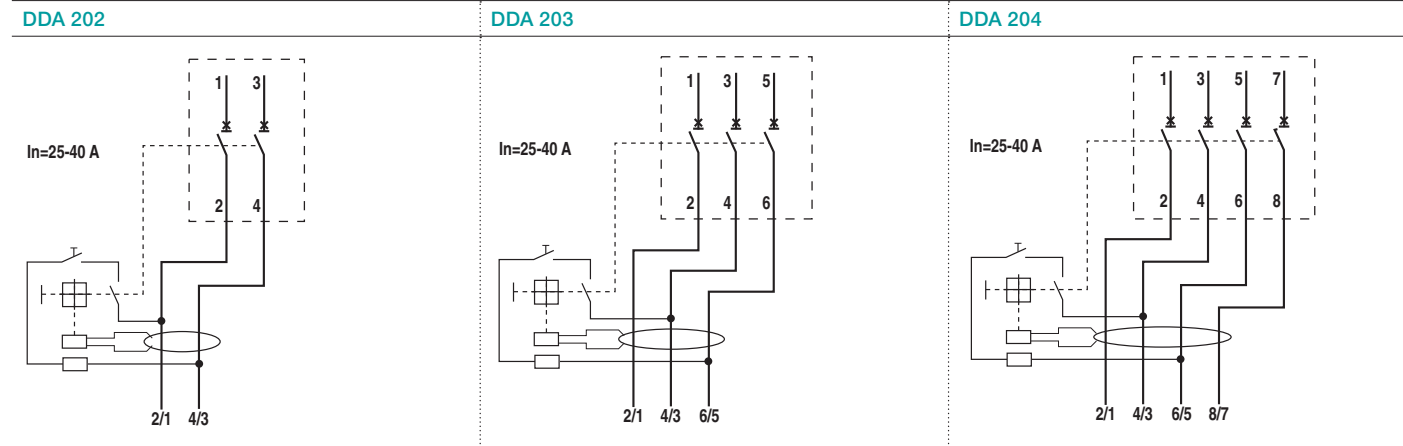

Quick product references

RCDs wiring diagrams

RCD-blocks

DDA 202 AE	DDA 203 AE	DDA 204 AE
DDA 202 B type	DDA 203 B type	DDA 204 B type
<p>In=25 A</p>	<p>In=25 A</p>	<p>In=25 A</p>
<p>In=40-63 A</p>	<p>In=40-63 A</p>	<p>In=40-63 A</p>
DDA 802	DDA 803	DDA 804

RCBOs

DS201

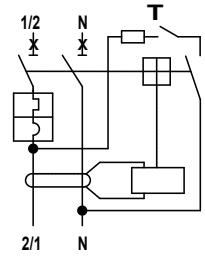

DS202C

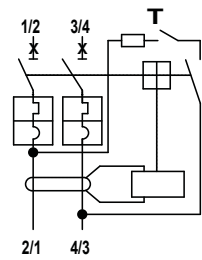

DS 202

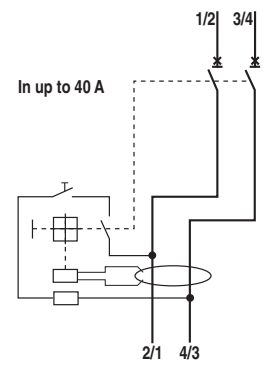

DS 203

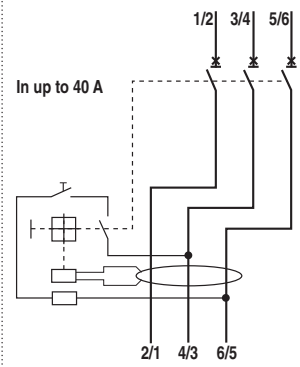

DS 204

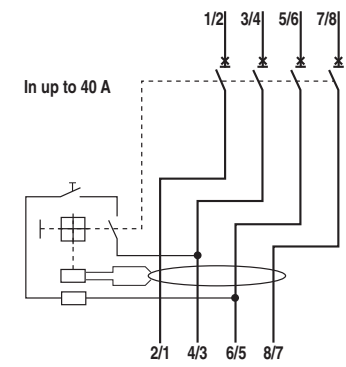

DS 202

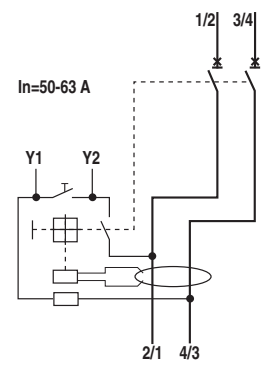

DS 203

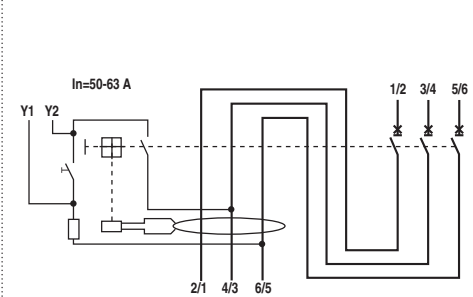

DS 204

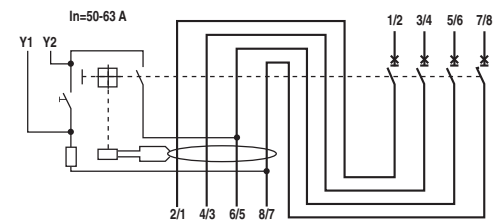

Quick product references

RCDs wiring diagrams

Residual current relays

RD2 residual current relays

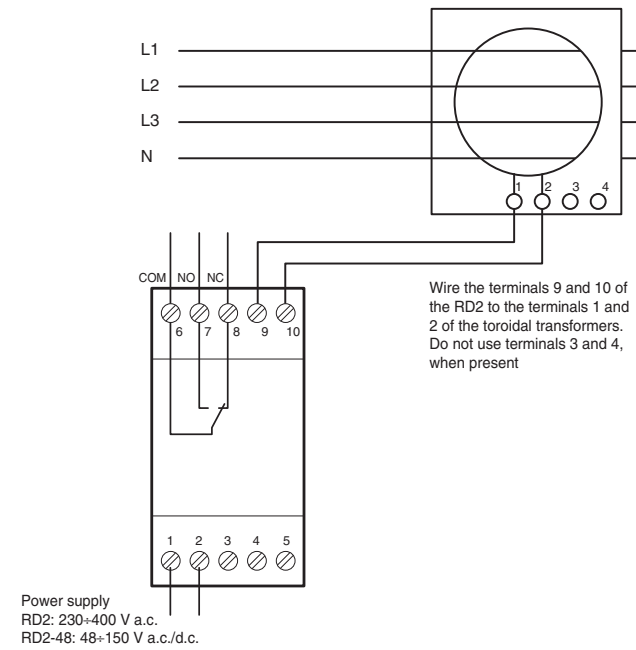

RD3 - undervoltage release wiring

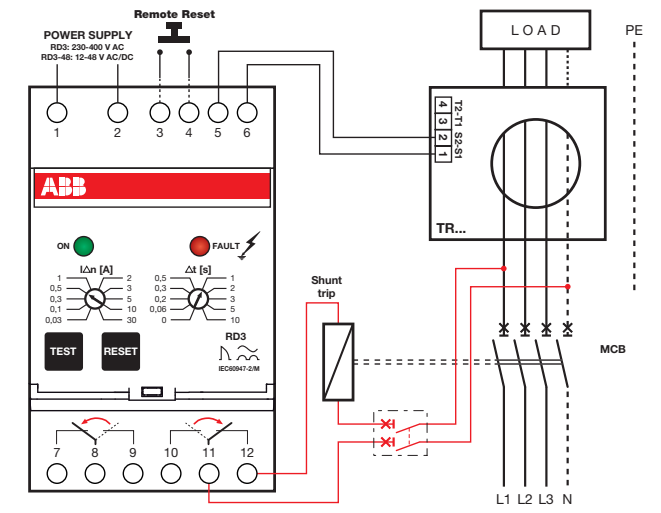

RD3 - shunt trip wiring

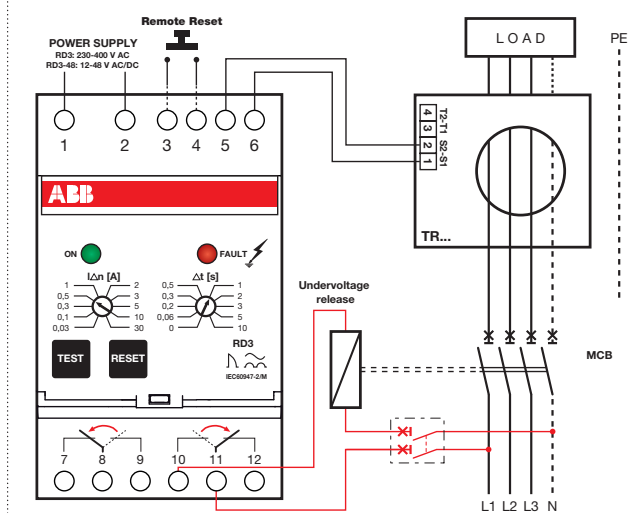

* The residual current protection is not active when this circuit breaker is switch-off

ELR48P - shunt trip wiring

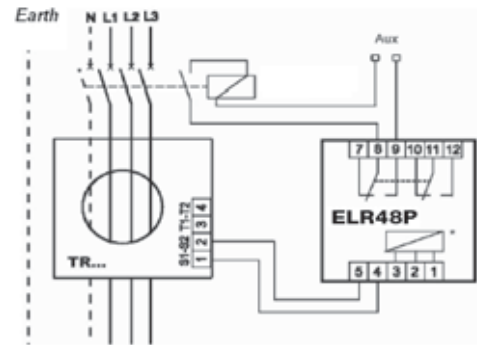

ELR48P - undervoltage release wiring

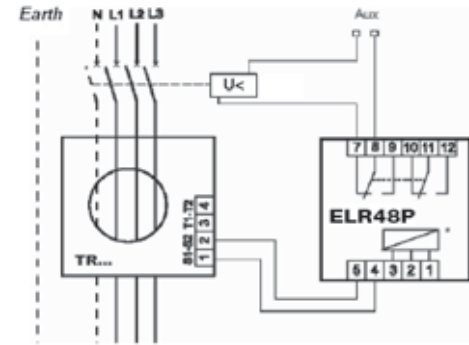

ELR72 - shunt trip wiring

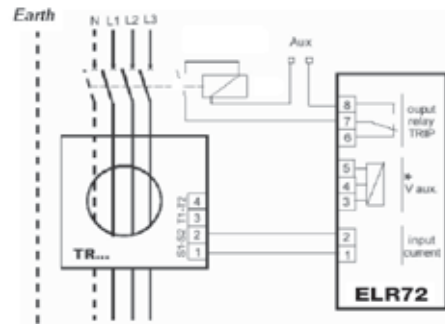

ELR72 - undervoltage release wiring

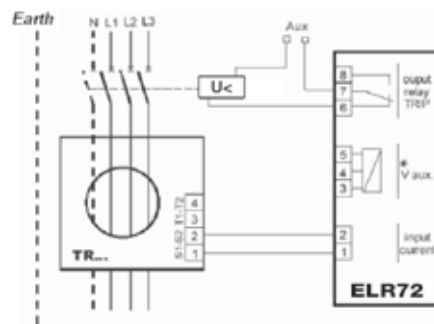

ELR96 - shunt trip wiring

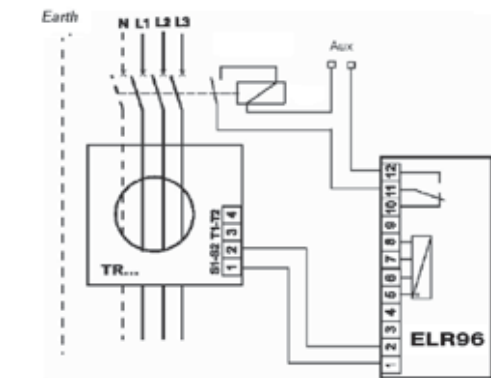

ELR96 - undervoltage release wiring

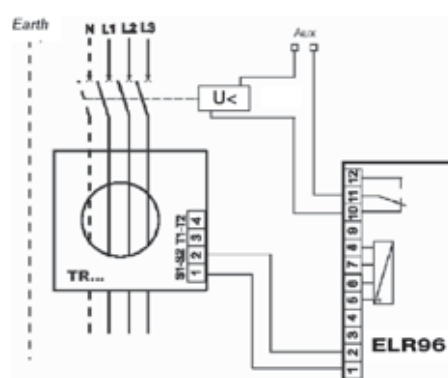

Quick product references

RCDs wiring diagrams

ELR72P - shunt trip wiring

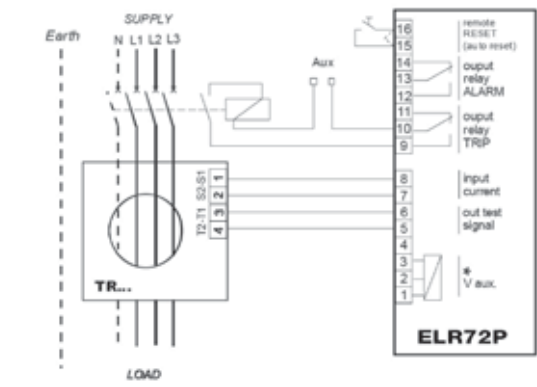

ELR72P - undervoltage release wiring

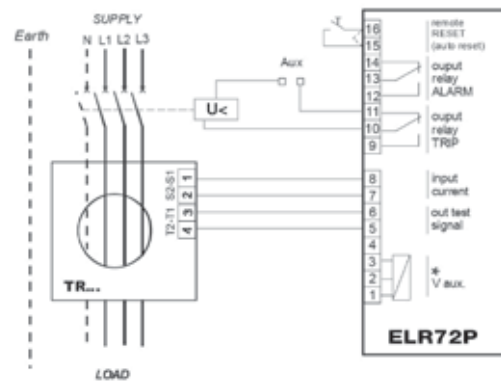

ELR96P - shunt trip wiring

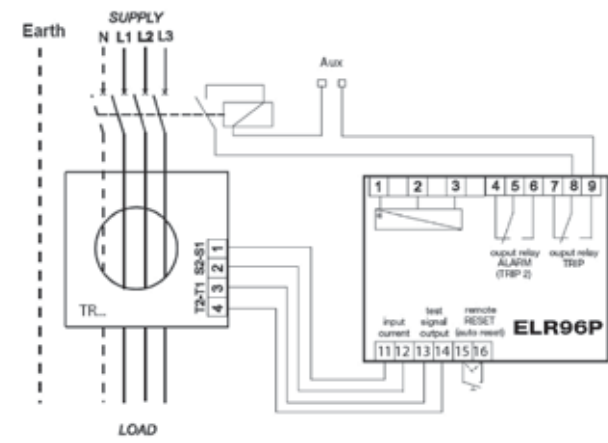

ELR96P - undervoltage release wiring

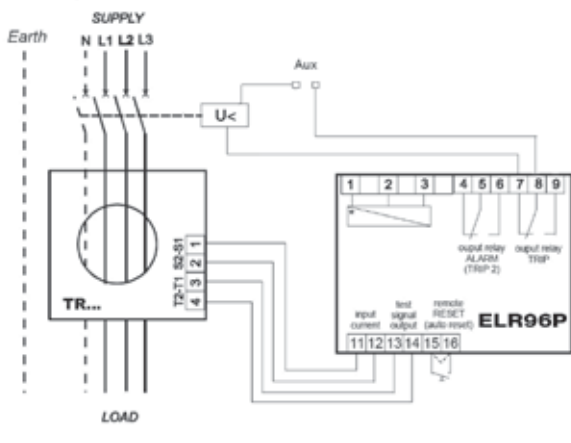

ELR96PF - shunt trip wiring

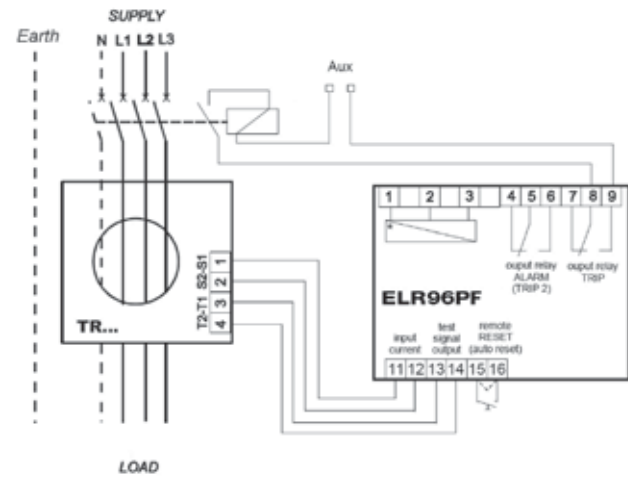

ELR96PF - undervoltage release wiring

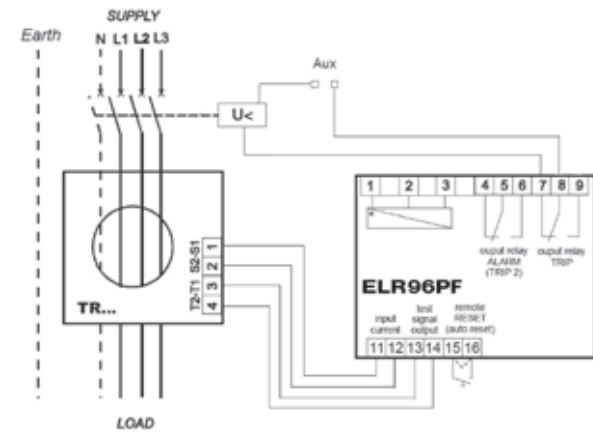

ELR96PD - shunt trip wiring

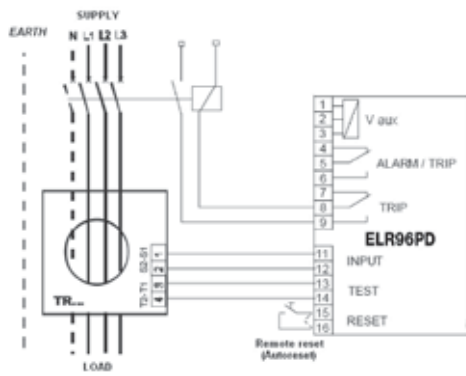



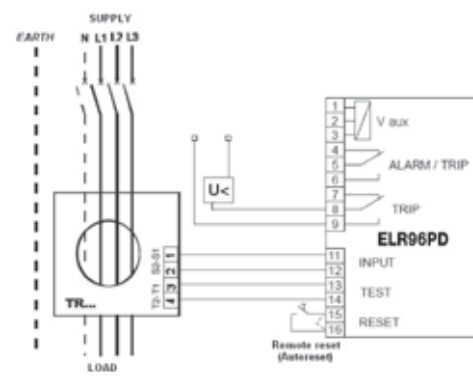





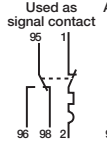
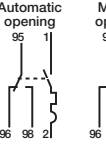

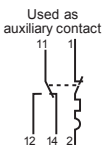
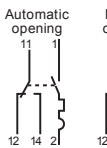
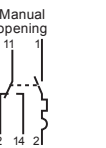
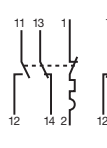
ELR96PD - undervoltage release wiring

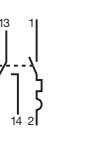
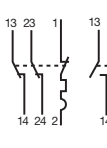
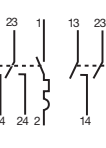

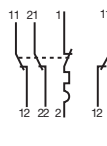
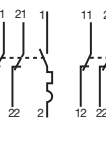
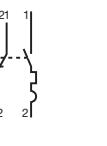
Quick product references

Auxiliary elements

S2C-S/H6R	S2C-H6R	S2C-H6-11R	S2C-H6-20R
<p>Used as signal contact</p>  <p>Automatic opening</p>  <p>Manual opening</p> 	<p>Used as auxiliary contact</p>  <p>Automatic opening</p>  <p>Manual opening</p> 	  	  
S2C-H6-02R	SN201-S	SN201-IH	
  	<p>Automatic opening</p>  <p>Manual opening</p> 	<p>Automatic opening</p>  <p>Manual opening</p> 	

Wiring diagrams for S2C-CM motor operating devices

Low voltage use: 12...30 V AC, 12...48 V DC

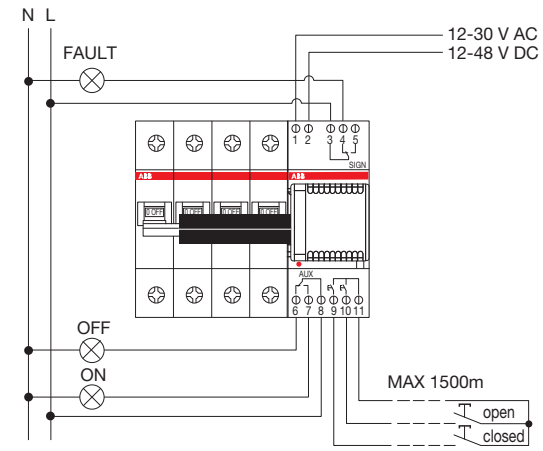

Use at 230 V AC via a TM15/12 bell transformer

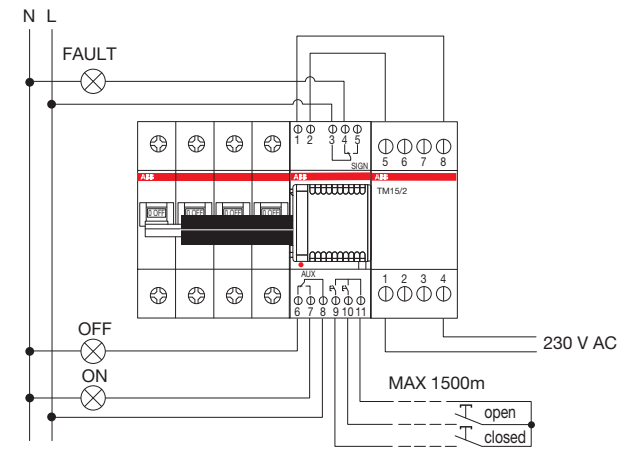

Low voltage use of several motor operating devices: 12...30 V AC, 12...48 V DC

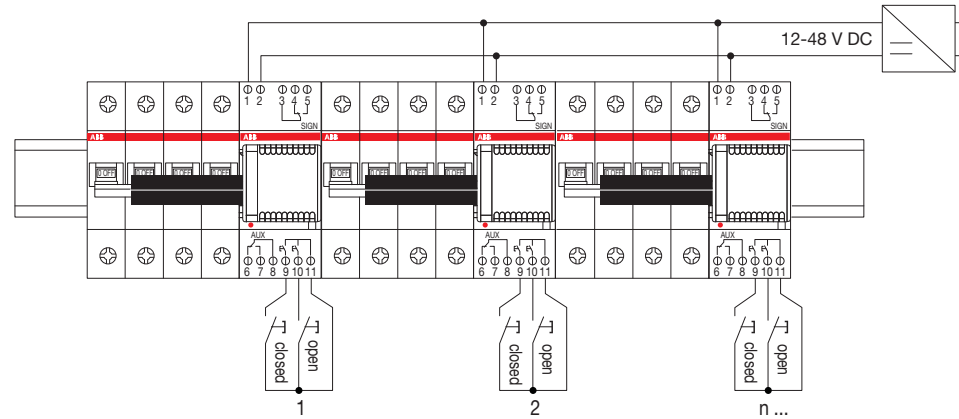

Use of several motor operating devices at 230 V AC via a single safety transformer

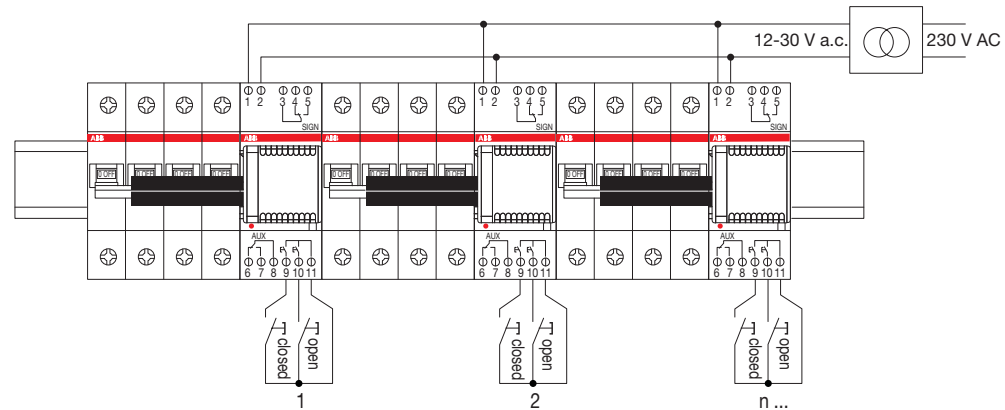

Quick product references

Auxiliary elements

Wiring diagrams for DS2C-CM motor operating devices

Low voltage use 12...30 V AC, 12...48 V DC

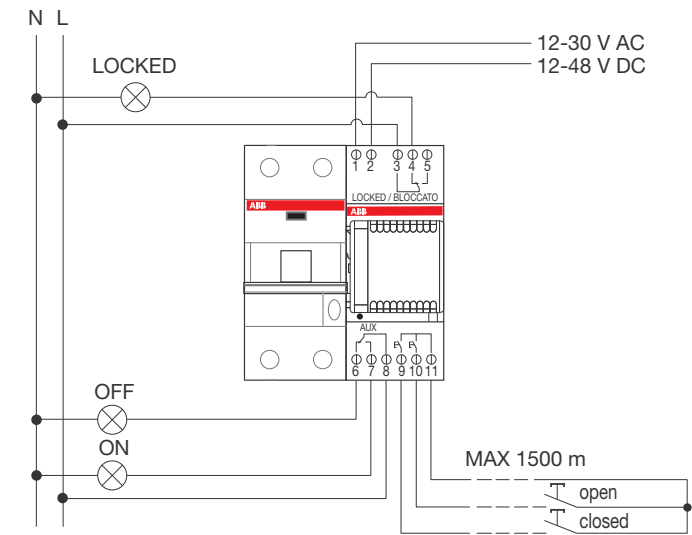

Use at 230 V AC via a TN15/12 transformer

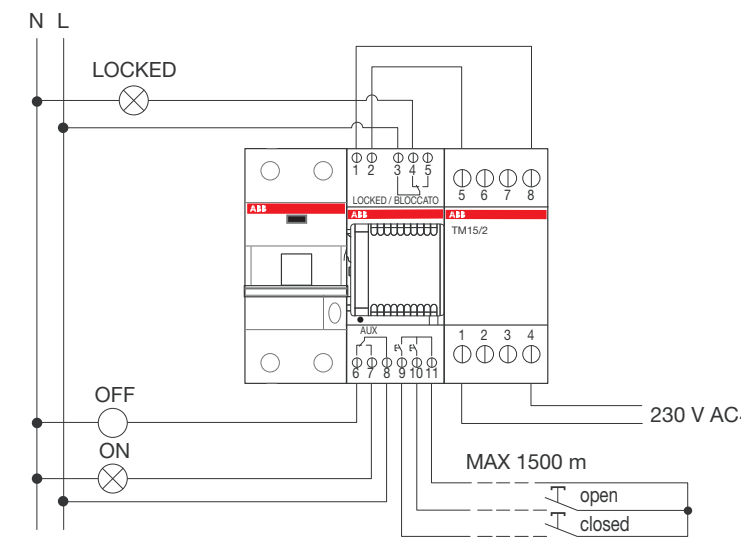

Wiring diagrams for motor operating device F2C-CM and F2C-ARI auto-reclosing unit

Low voltage use: 12...30 V AC, 12...48 V DC

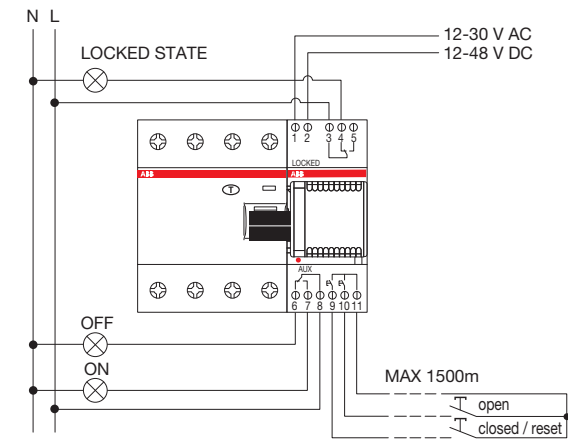

Use at 230 V AC via a TM15/12 bell transformer

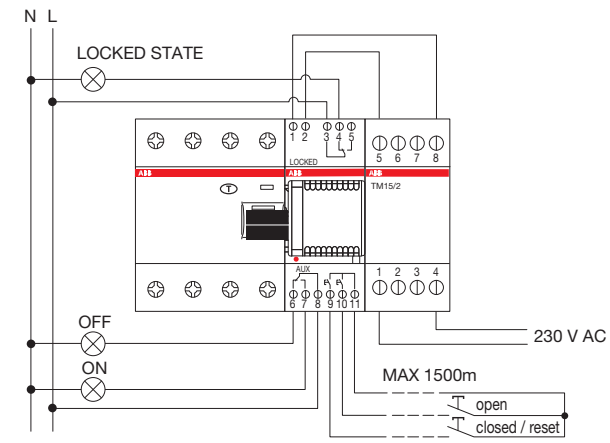

Low voltage use of several motor operating devices or auto-reclosing units: 12-30 V AC, 12-48 V DC

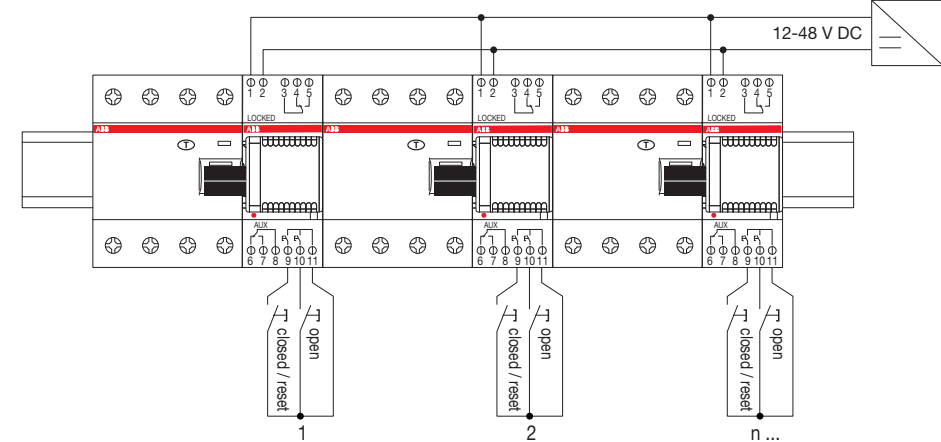

Use of several motor operating devices or auto-reclosing units at 230 V AC via a single transformer

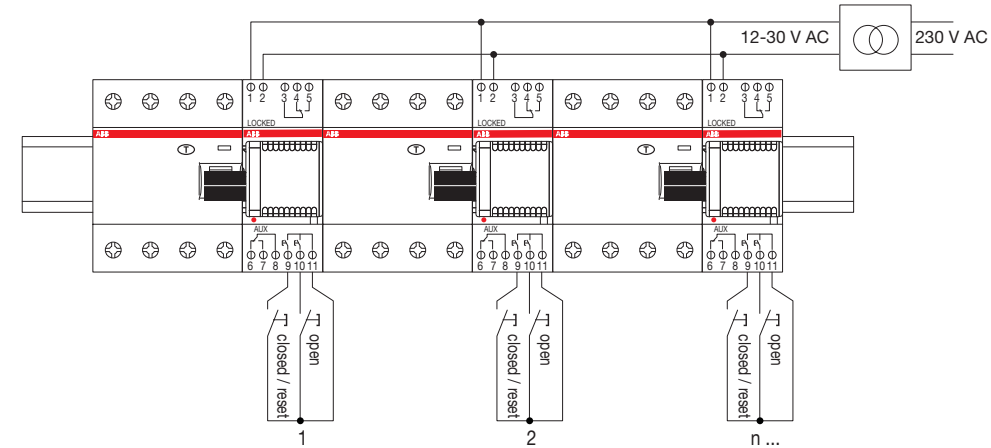

Quick product references

Auxiliary elements

Wiring diagram for F2C-ARH and F2C-ARH-T

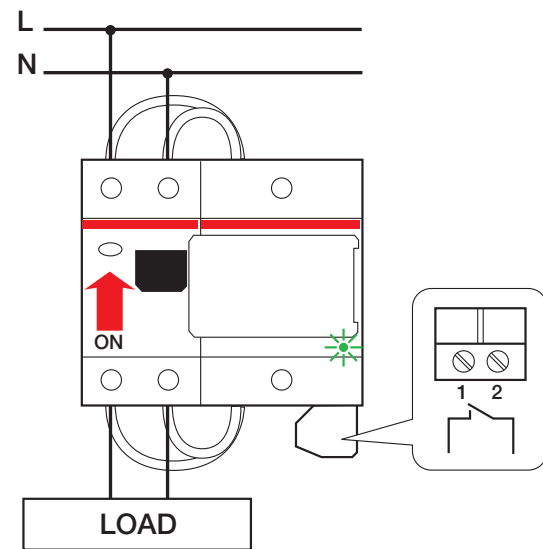

Quick product references

Protection and safety wiring diagrams

Surge Protective Devices - Type 1

Single pole Type 1 SPD

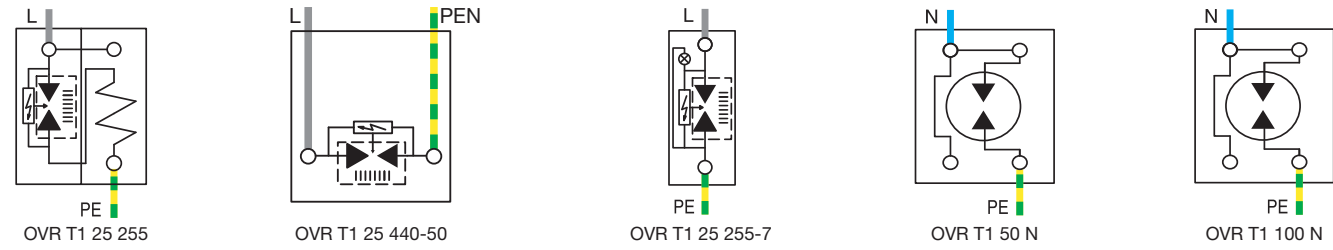

Multipole Type 1 SPD

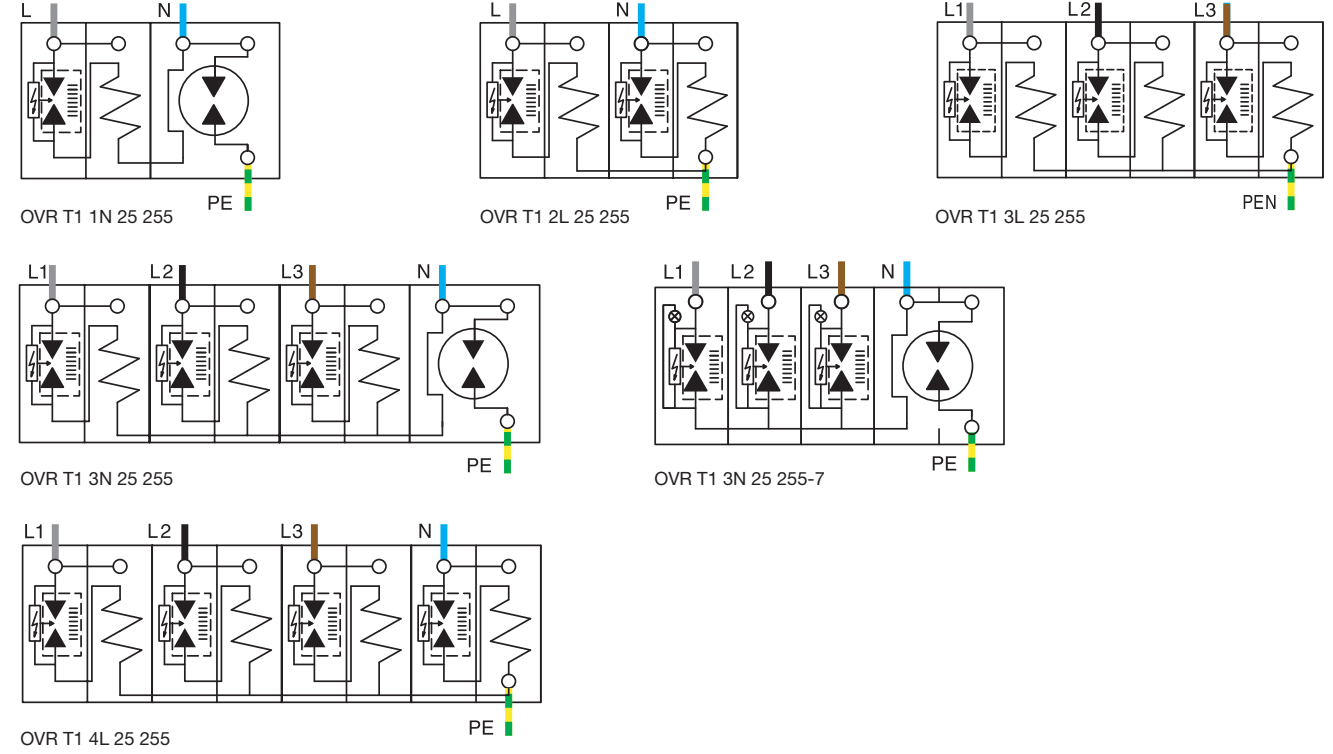

Multipole Type 1 SPD with remote indication (TS)

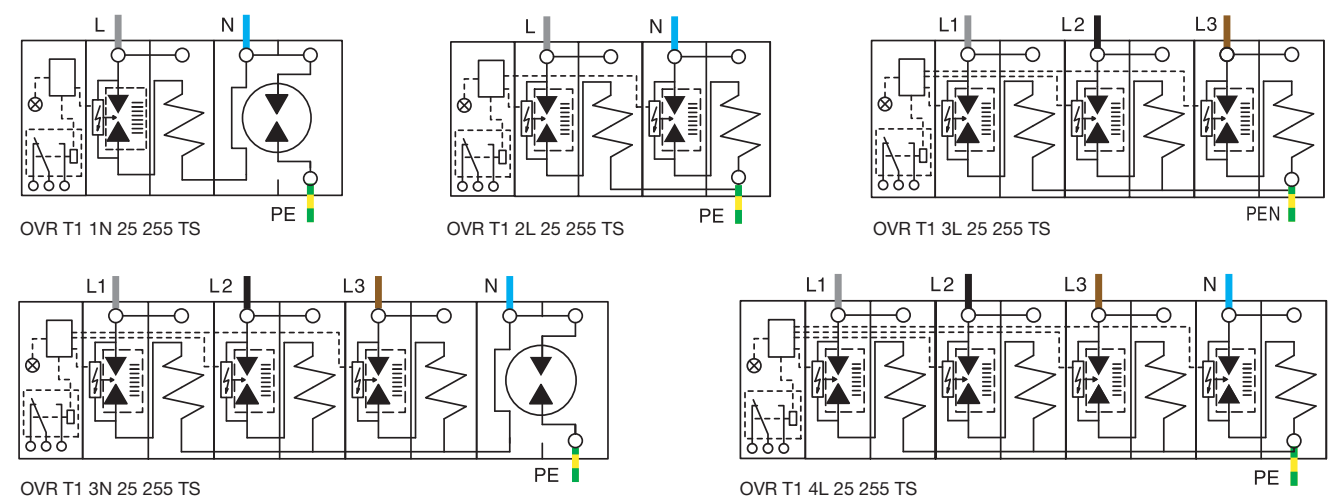

Quick product references

Protection and safety wiring diagrams

Surge Protective Devices - Photovoltaic SPDs - OVR PV

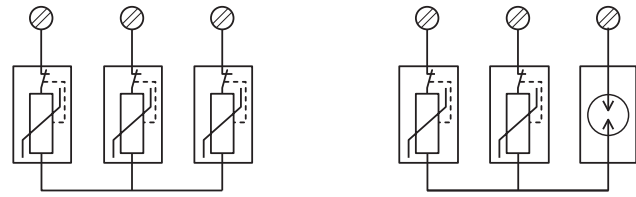

OVR PV 1000 V

OVR PV 600 V

Surge Protective Devices - Low Current SPDs - OVR TC



OVR TC 200 V in parallel

OVR TC / xx V / 200 FR in series

Surge Protective Devices - Type 1+2

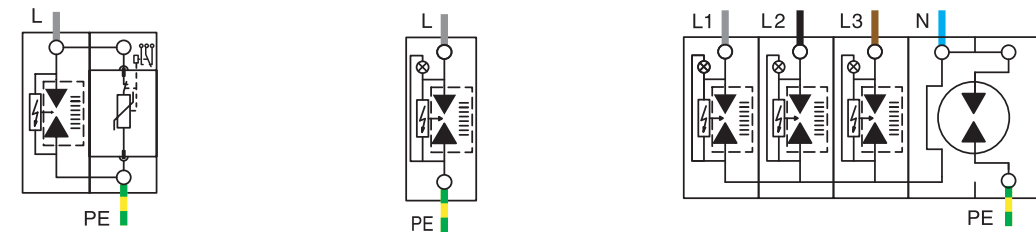

OVR T1+2 25 255 TS

OVR T1+2 15 255-7

OVR T1+2 3N 15 255-7

Surge Protective Devices - Type 1+2 / Type 2

Non pluggable Type 2 SPDs

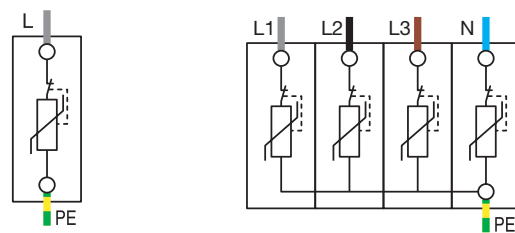

OVR T2 40 275
OVR T2 15 275

OVR T2 4L 40 275

Pluggable Type 1+2 / Type 2 SPDs

Single pole Type 2 SPD

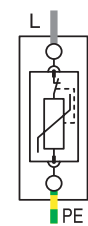

OVR T2 15 275 P
OVR T2 40 275 P
OVR T2 15 440 P
OVR T2 40 440 P

Single pole Type 2 SPD with safety reserve (s)

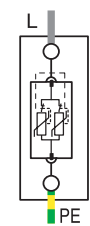

OVR T2 40 275s P
OVR T2 70 275s P
OVR T2 40 440s P
OVR T2 70 440s P
OVR T1+2 7 275s P

Single pole Type 2 SPD with remote indication (TS)

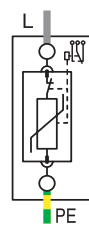

OVR T2 15 275 P TS
OVR T2 40 275 P TS
OVR T2 15 440 P TS
OVR T2 40 440 P TS

Single pole Type 2 SPD with safety reserve (s) and remote indication (TS)

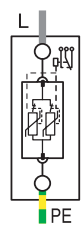

OVR T2 40 275s P TS
OVR T2 70 275s P TS
OVR T2 40 440s P TS
OVR T2 70 440s P TS

Multipole Type 2 SPD

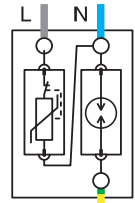

OVR T2 1N 15 275 P
OVR T2 1N 40 275 P

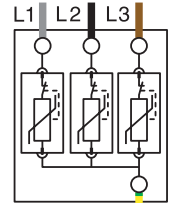

OVR T2 3L 15 275 P
OVR T2 3L 40 275 P

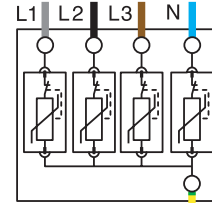

OVR T2 4L 15 275 P
OVR T2 4L 40 275 P

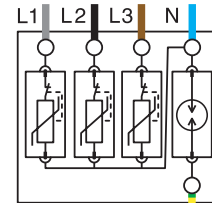

OVR T2 3N 15 275 P
OVR T2 3N 40 275 P

Multipole Type 2 SPD with safety reserve (s)

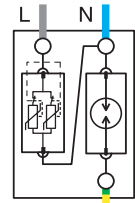

OVR T2 1N 40 275s P
OVR T2 1N 70 275s P
OVR T1+2 1N 7 275s P

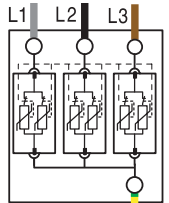

OVR T2 3L 40 275s P
OVR T2 3L 70 275s P
OVR T1+2 3L 7 275s P

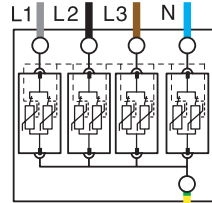

OVR T2 4L 40 275s P
OVR T2 4L 70 275s P
OVR T1+2 4L 7 275s P

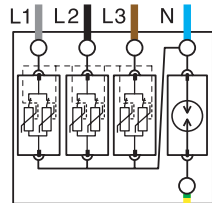

OVR T2 3N 40 275s P
OVR T2 3N 70 275s P
OVR T1+2 3N 7 275s P

Multipole Type 2 SPD with remote indication (TS)

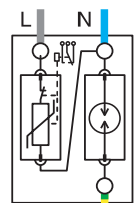

OVR T2 1N 15 275 P TS
OVR T2 1N 40 275 P TS

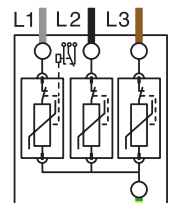

OVR T2 3L 15 275 P TS
OVR T2 3L 40 275 P TS

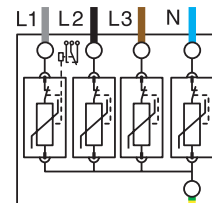

OVR T2 4L 15 275 P TS
OVR T2 4L 40 275 P TS

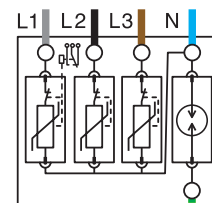

OVR T2 3N 15 275 P TS
OVR T2 3N 40 275 P TS

Multipole Type 2 SPD with safety reserve (s) and remote indication (TS)

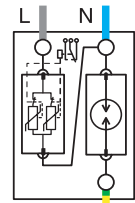

OVR T2 1N 40 275s P TS
OVR T2 1N 70 275s P TS

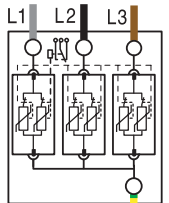

OVR T2 3L 40 275s P TS
OVR T2 3L 70 275s P TS

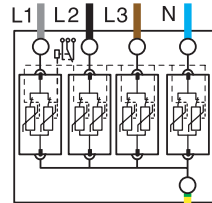

OVR T2 4L 40 275s P TS
OVR T2 4L 70 275s P TS

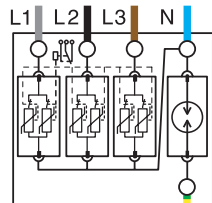

OVR T2 3N 40 275s P TS
OVR T2 3N 70 275s P TS

Type 2 auto-protected SPD

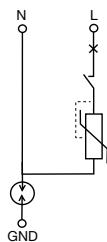

OVR Plus N1 20

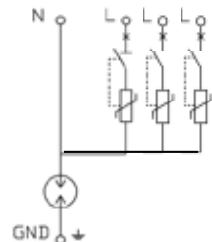

OVR Plus N3 20

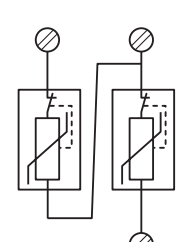

OVR T2 2L 15 75 P

Type 2 Special 24/48 AC & DC - OVR 75 V

Quick product references

Protection and safety wiring diagrams

E90

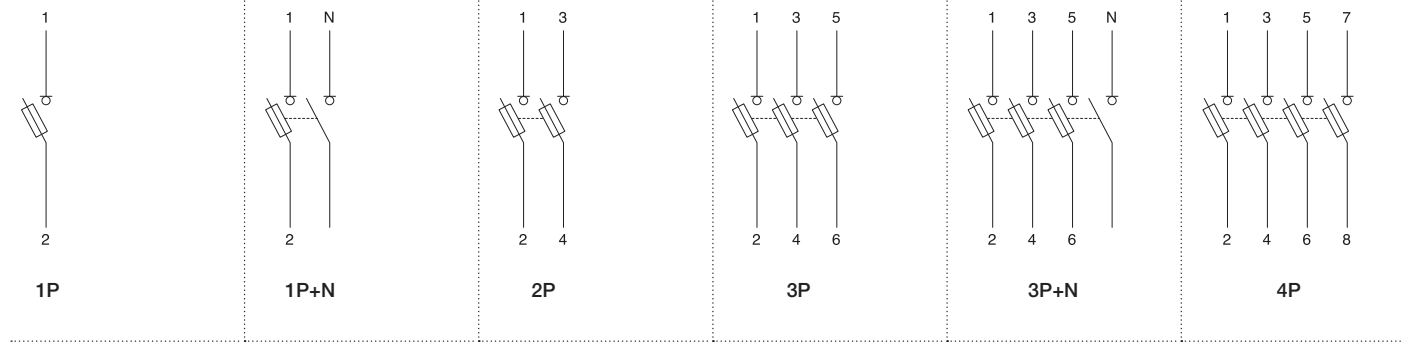

E 90 with blown fuse indicator light in alternate current

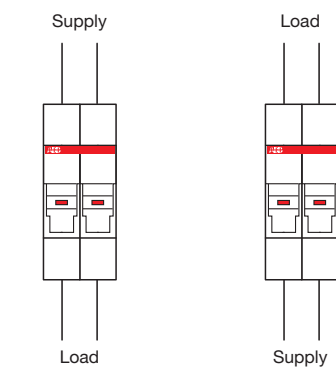

For direct current systems please refer to E 90 PV wiring diagram

E90h

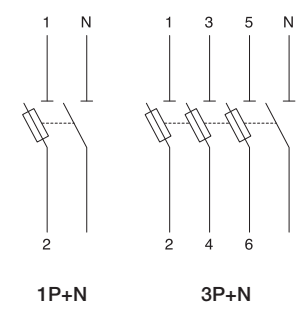

E90 PV

E 90 PV with blown fuse indicator light in direct current

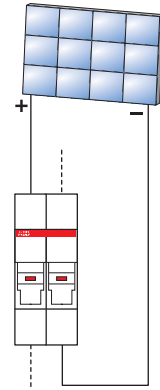
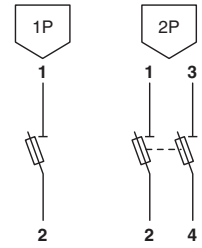

In direct current systems, since the LED allows the current to flow only from positive to negative, the wiring of the blown fuse indicator version should follow the current direction as shown in the diagram

E930

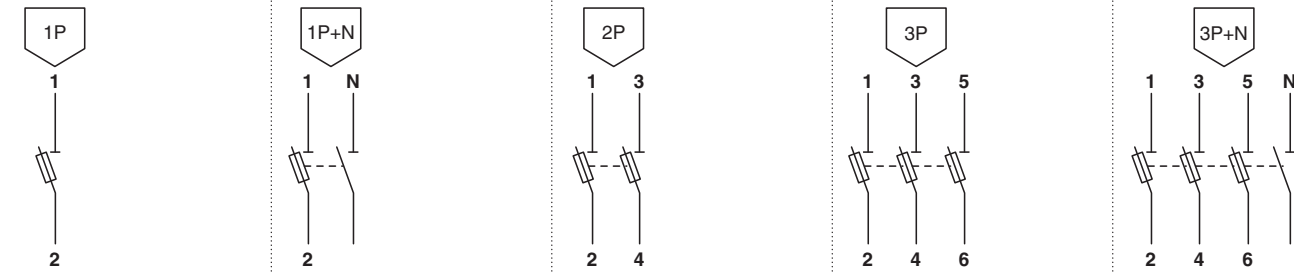

ILTS-E



Quick product references

Protection and safety wiring diagrams

EPD24

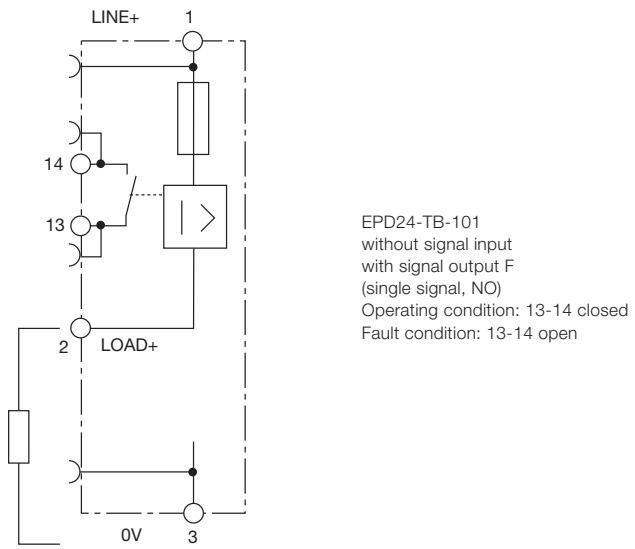

SQZ3

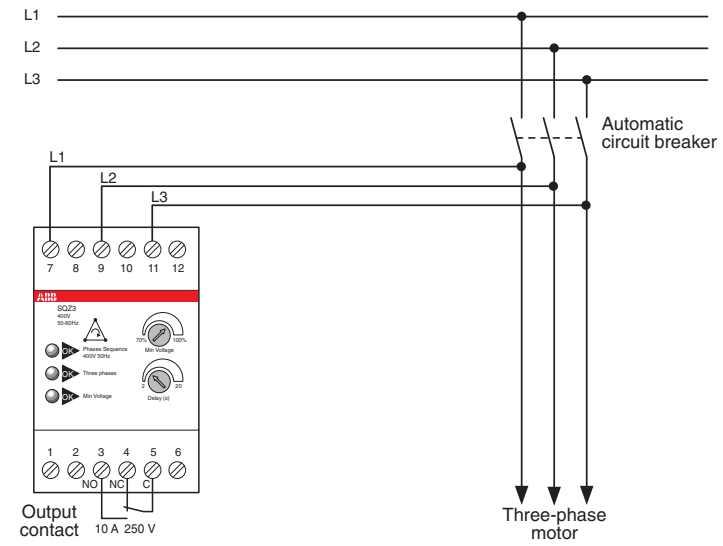

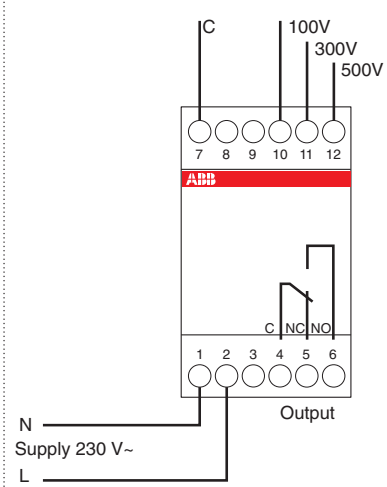
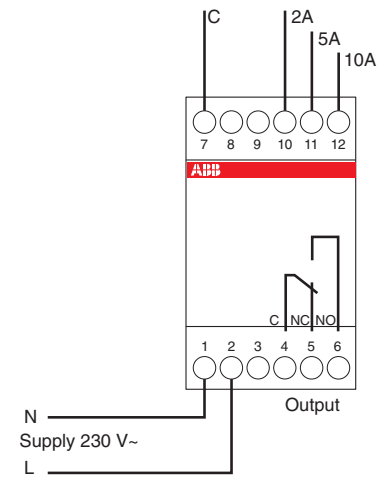

E 236 US 1, E 236 US 2

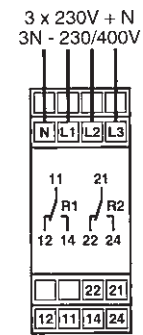

E236-US 1.1 and US 2.1

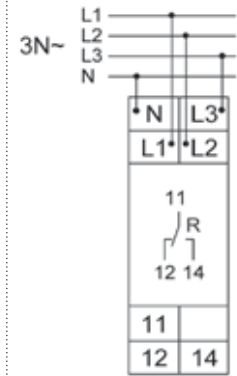

E236-US 1.1D

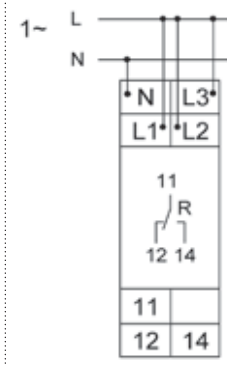

E236-US 1.1D

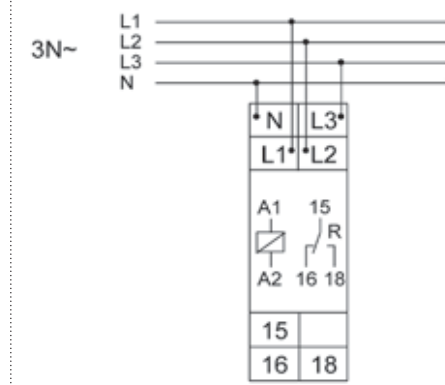

Quick product references

Protection and safety wiring diagrams

ISOLTESTER-DIG, QSD-DIG and SELVTESTER-24 - with transformer with central socket (PC)

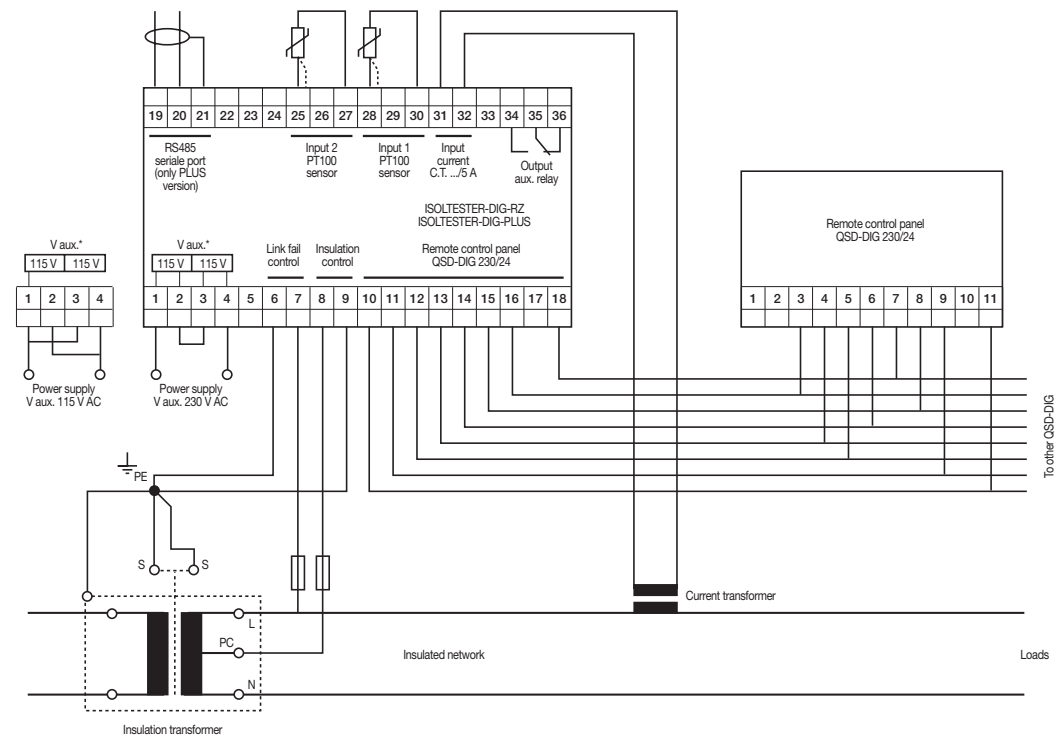

ISOLTESTER-DIG, QSD-DIG and SELVTESTER-24 -

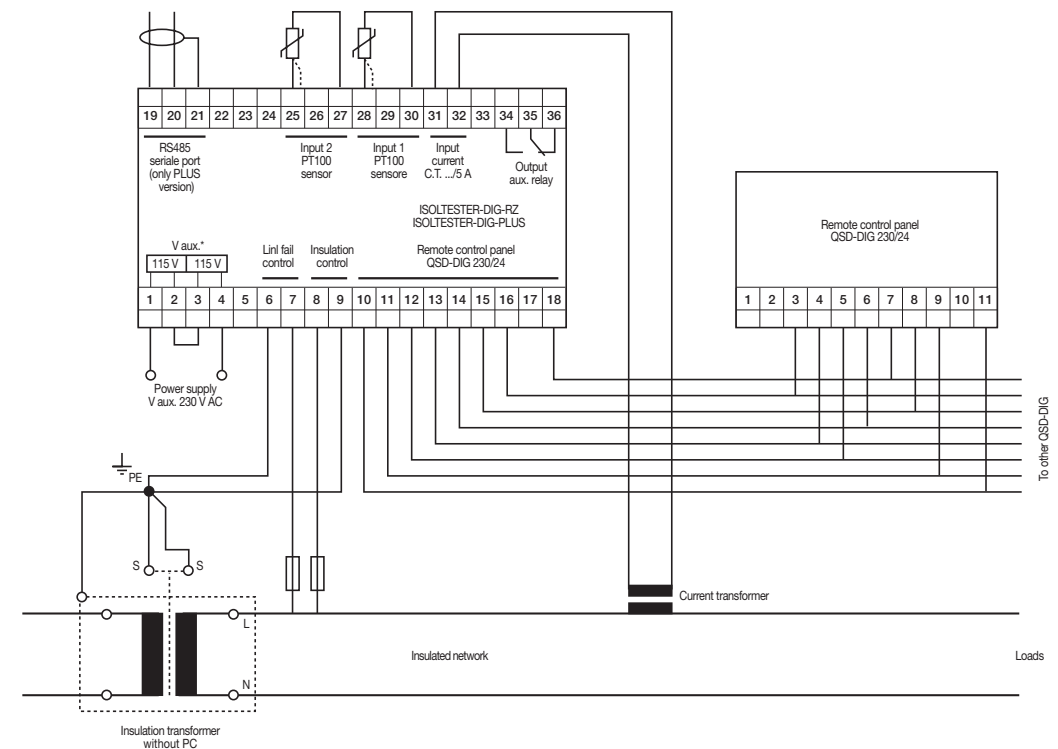

11

ISOLTESTER-DIG, QSD-DIG and SELVTESTER-24 -

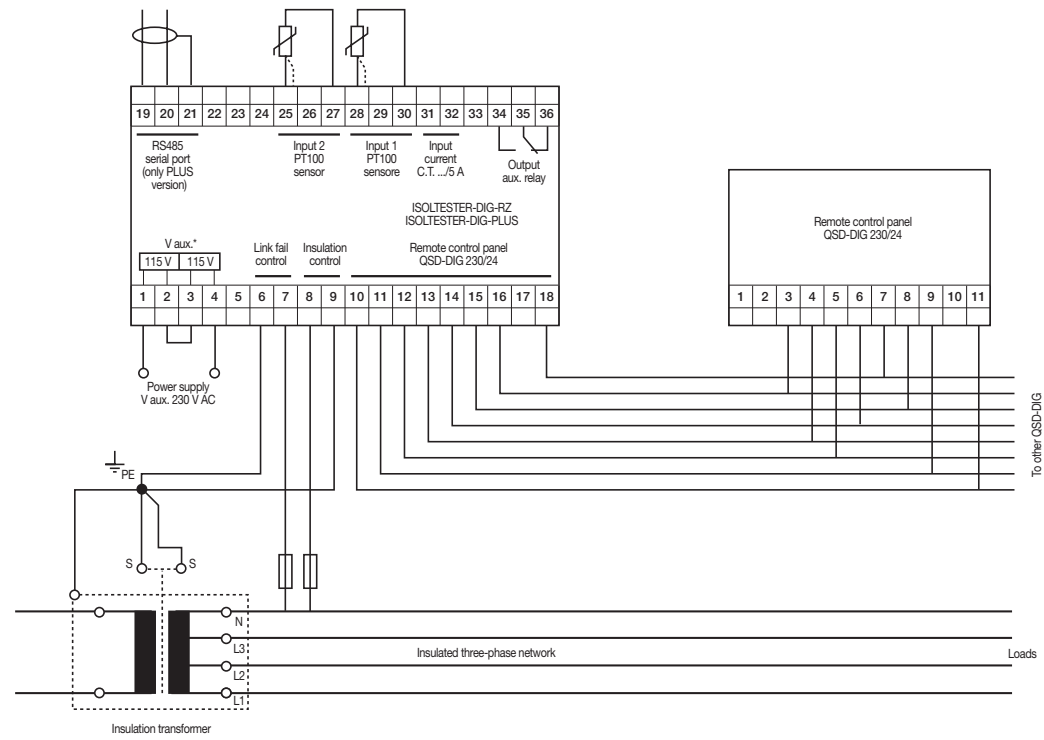

ISOLTESTER-DIG, QSD-DIG and SELVTESTER-24 -

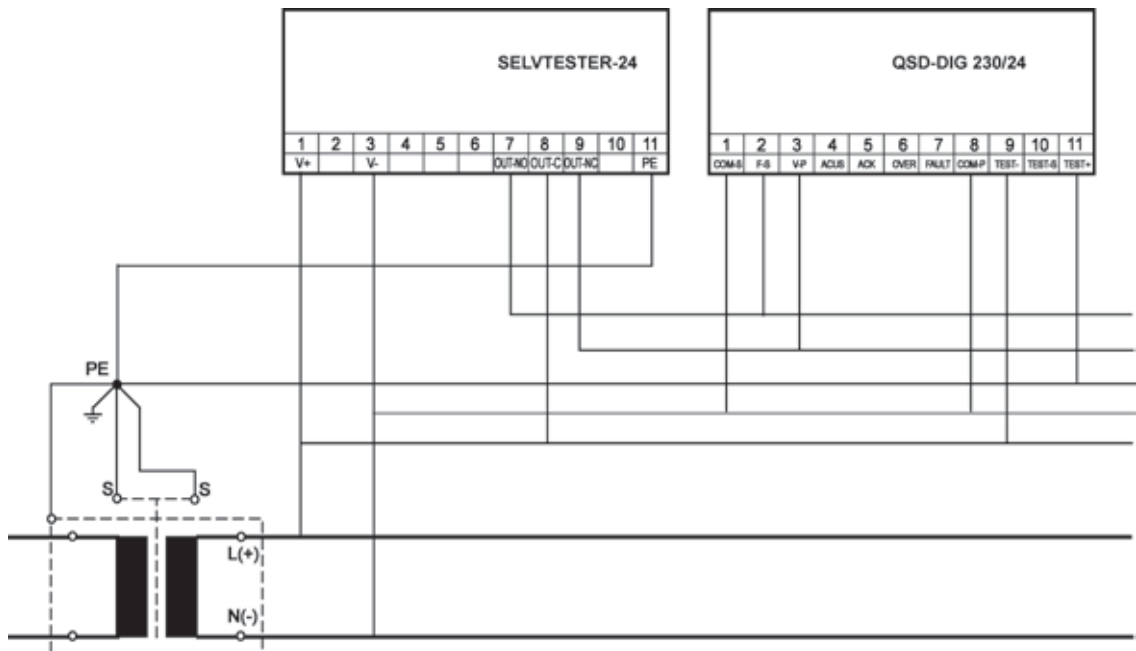

Quick product references

Protection and safety wiring diagrams

ISL-A 24-48

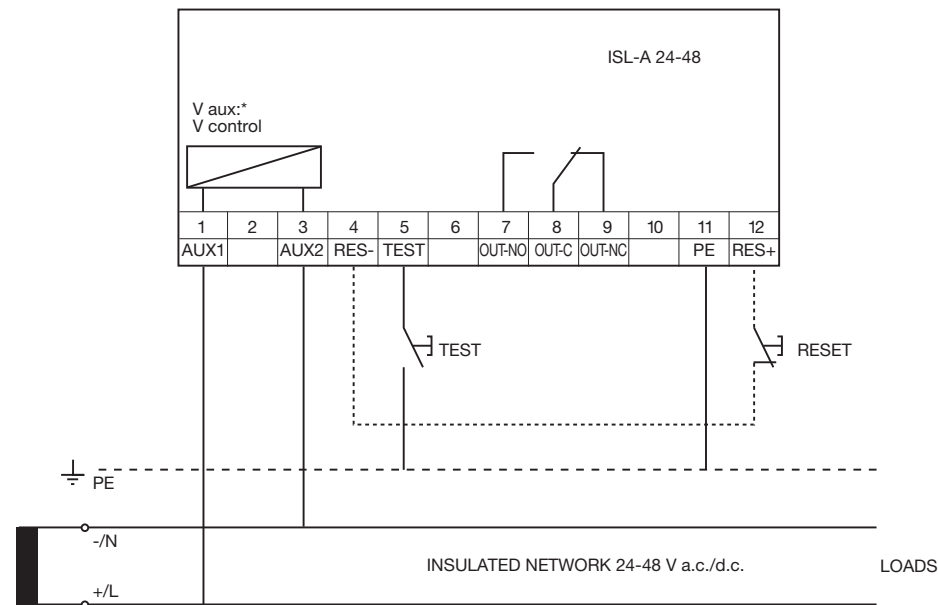

MICROSWITCH SETTINGS

The front microswitches allow the insulation threshold level to be adjusted between 10 and 60 kΩ, as shown below:

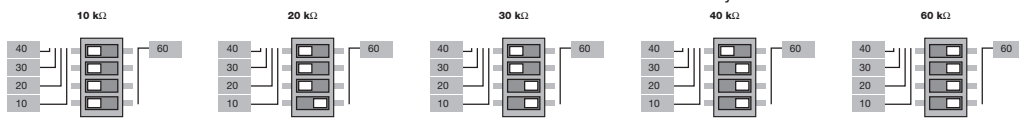

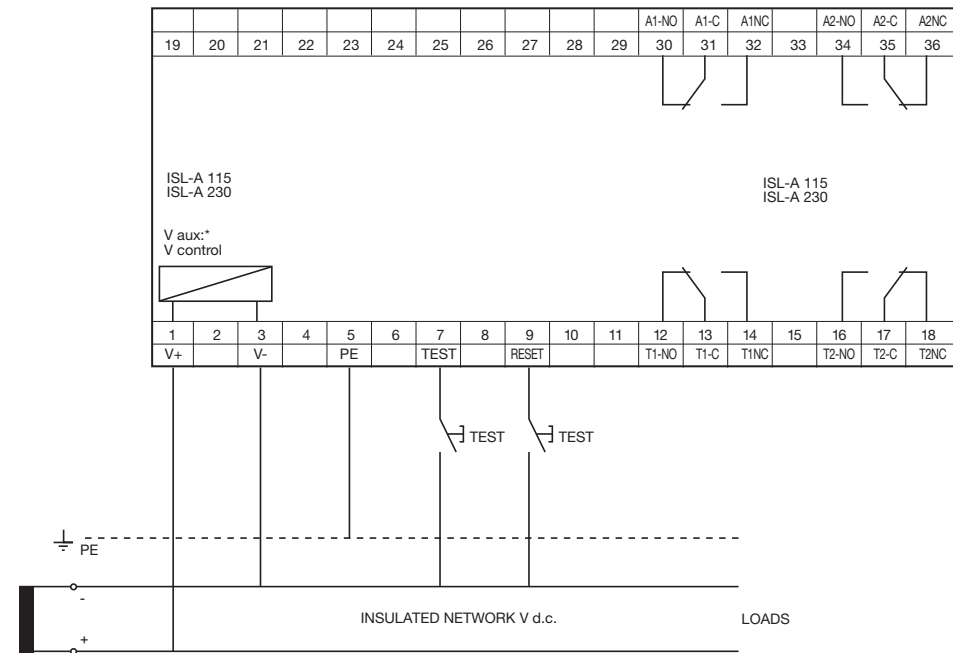

MICROSWITCH SETTINGS

The front microswitches are used for adjusting the insulation threshold level, enabling the fail-safe function and configuring the reset mode for both the alarm and trip thresholds.

Microswitches A, B, C, D for programming the trip and alarm thresholds:

ALARM		TRIP	
300 kΩ:	A=0, B=0, C=0, D=0	100 kΩ:	A=0, B=0, C=0, D=0
150 kΩ:	A=1, B=0, C=0, D=0	60 kΩ:	A=1, B=0, C=0, D=0
80 kΩ:	A=1, B=1, C=0, D=0	40 kΩ:	A=1, B=1, C=0, D=0
50 kΩ:	A=1, B=1, C=1, D=0	20 kΩ:	A=1, B=1, C=1, D=0
30 kΩ:	A=1, B=1, C=1, D=1	10 kΩ:	A=1, B=1, C=1, D=1

Microswitch E for configuring the FAIL SAFE mode

E=0 fail safe mode disabled

E=1 fail safe mode enabled

Microswitch F for configuring the RESET mode

F=0 manual reset

F=1 automatic reset

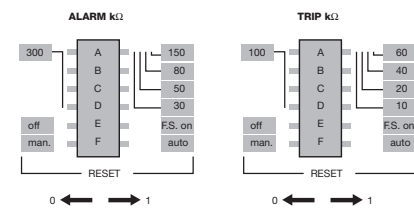

Quick product references

Protection and safety wiring diagrams

ISL-A 600

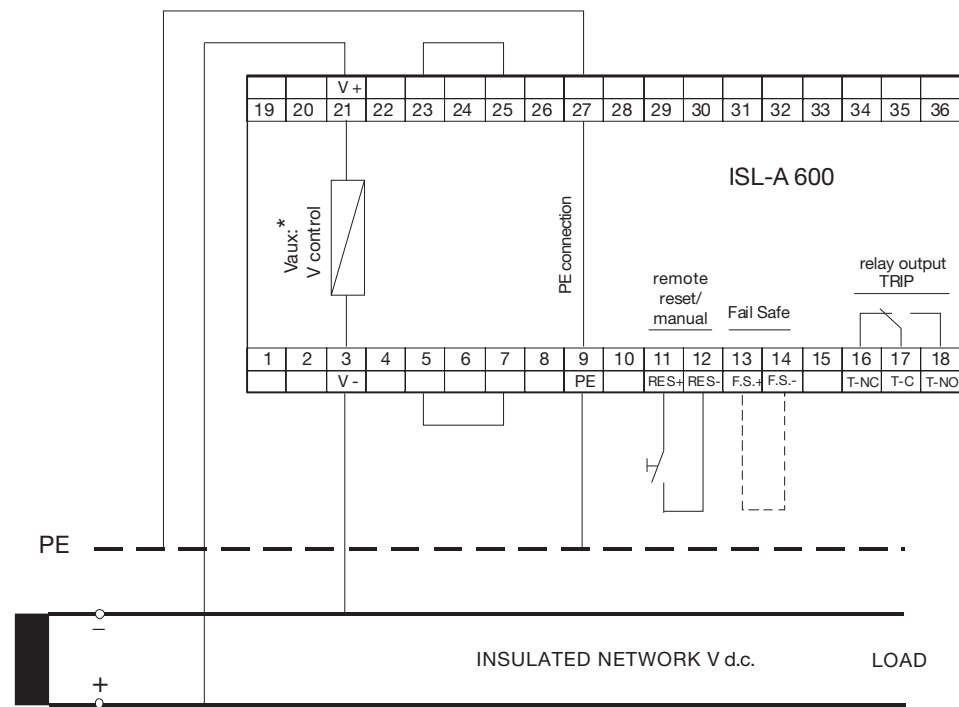

ISL-C 230

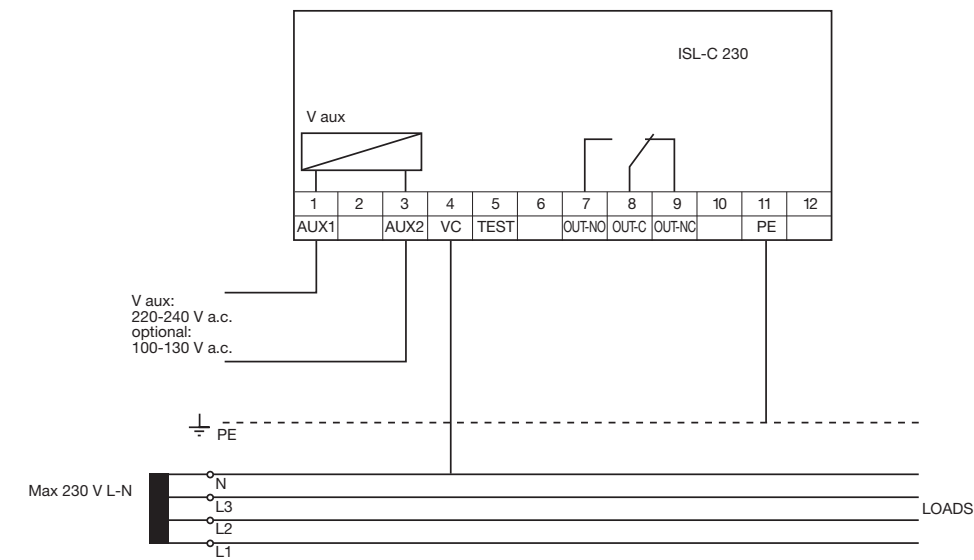

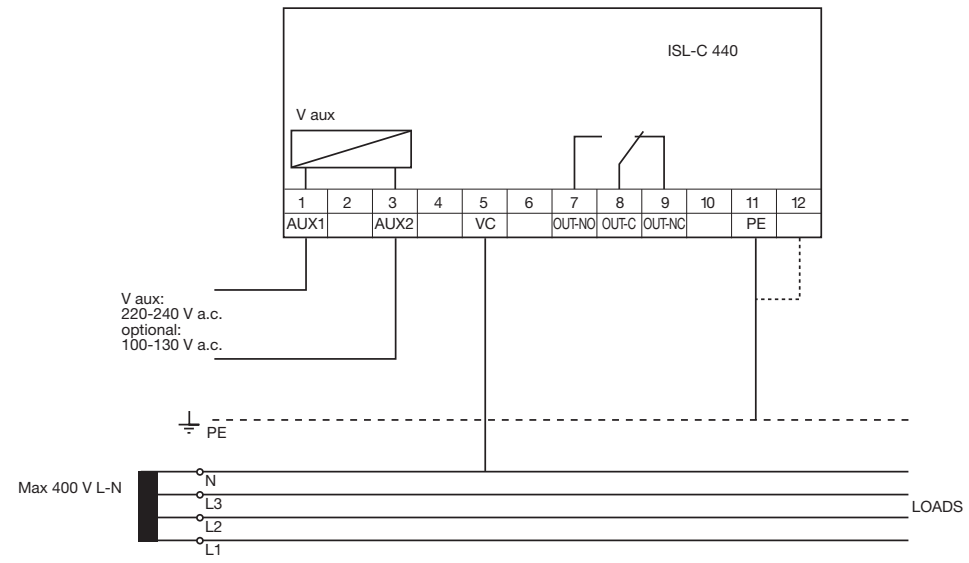

MICROSWITCH SETTINGS

The front microswitches are used for adjusting the insulation threshold level between 10 and 150 kΩ, as shown below:

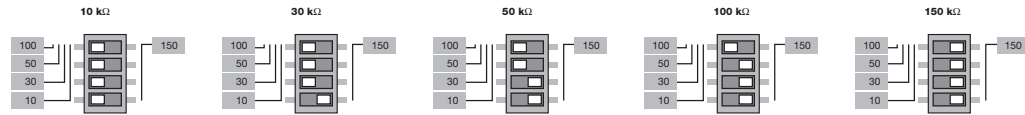

Quick product references

Protection and safety wiring diagrams

ISL-C 600

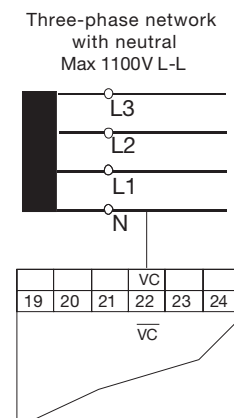
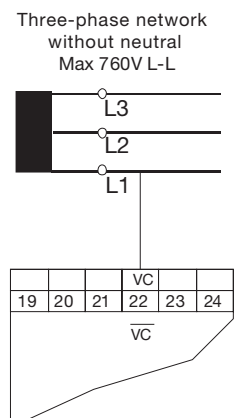
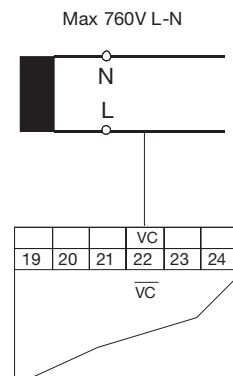
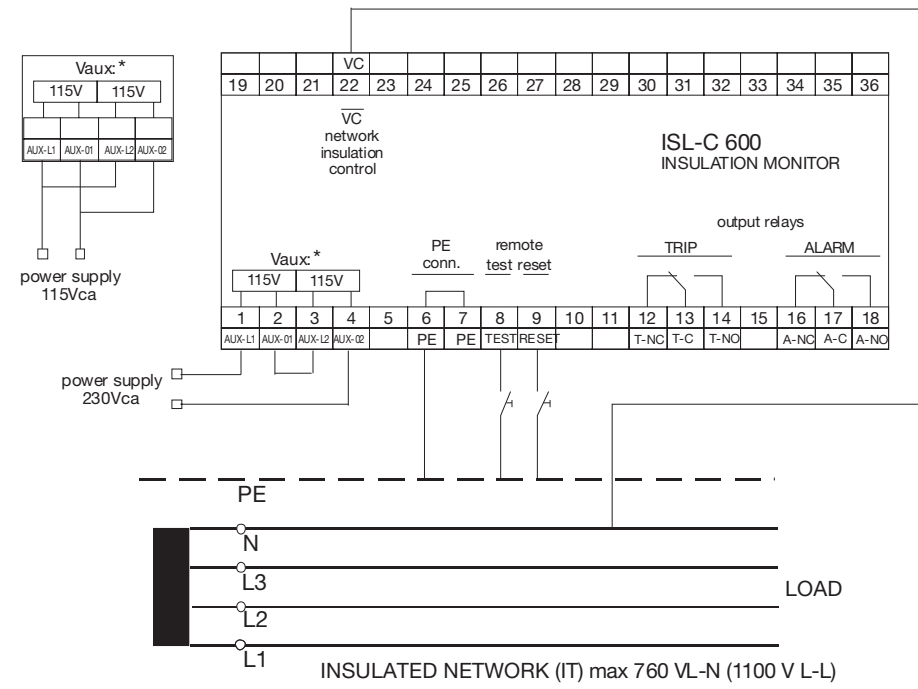

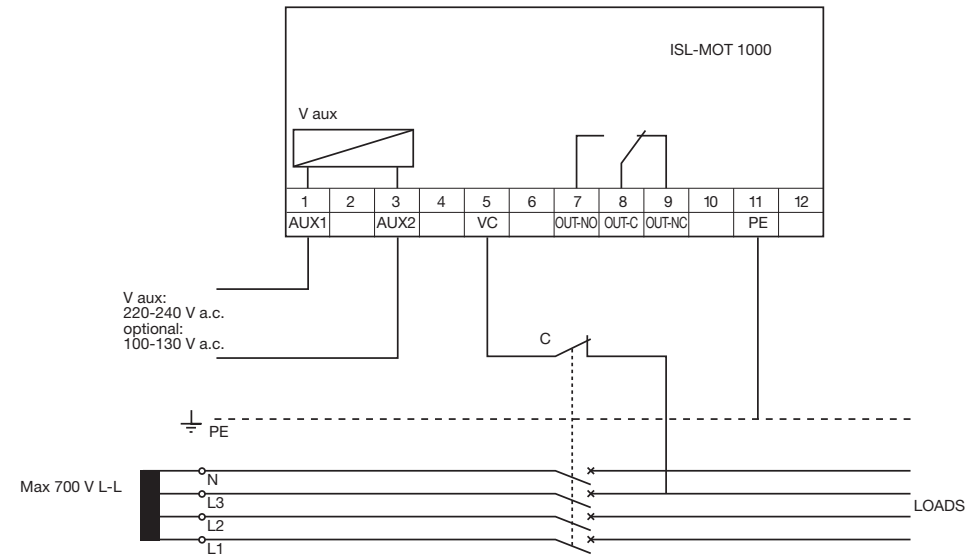

MICROSWITCH SETTINGS

The front microswitches are used for adjusting the insulation threshold level between 0.1 and 10 MΩ. A total of 7 microswitches are used, divided into two groups as shown below:

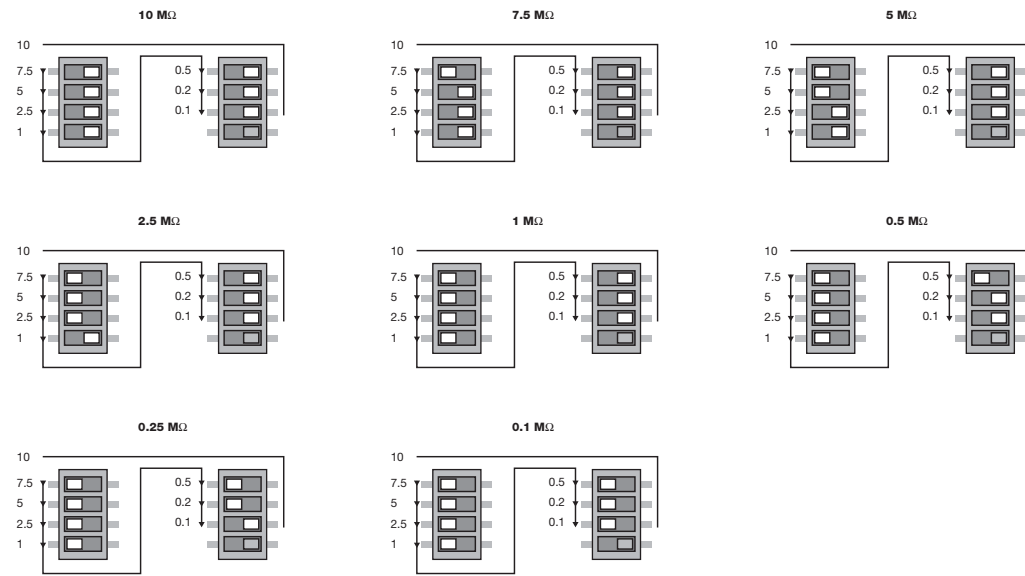

Quick product references

Protection and safety wiring diagrams

TI

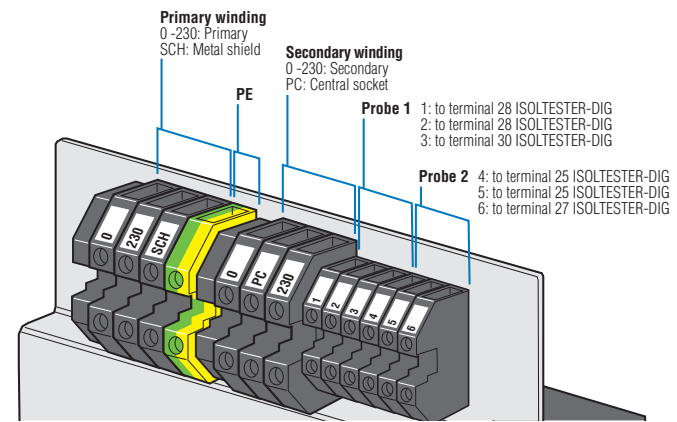

Quick product references

Command and signalling wiring diagrams

E200/SD 200/SHD 200

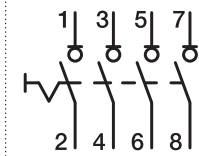
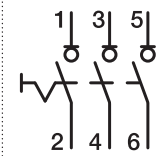

E210

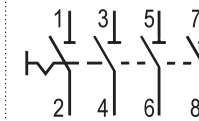
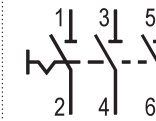
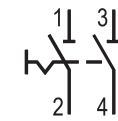
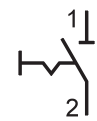

ON / OFF switch

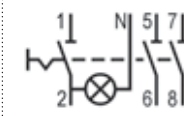
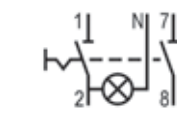
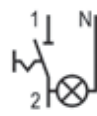

Off switches with indicator lamps

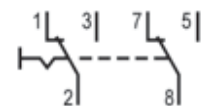
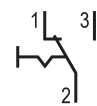

Change-over switches

Quick product references

Command and signalling wiring diagrams

E210 group switches

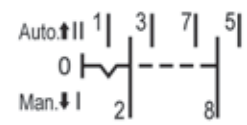
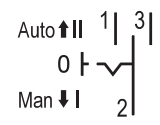

E210 control switches

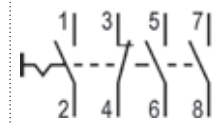
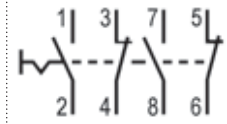
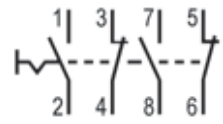

E210 pushbutton

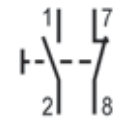

E210 luminous Pushbutton

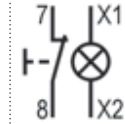

E210 indicator Light

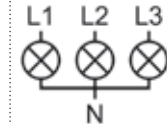
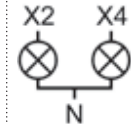
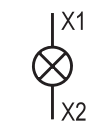

SL

SL-3-48 24Vac/dc
 SL-3-48 48Vac/dc
 SL-3-48 115Vac
 SL-3-48 115Vdc
 SL-3-48 230Vac

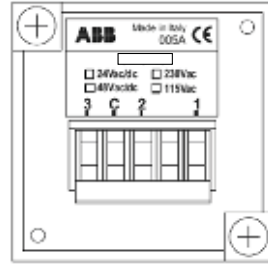

SL-4-48 24Vac/dc
 SL-4-48 48Vac/dc
 SL-4-48 115Vac
 SL-4-48 115Vdc
 SL-4-48 230Vac

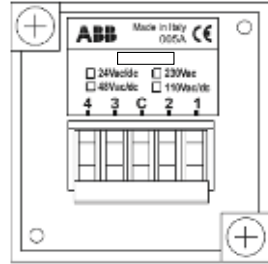

SL-12-96 24Vac/dc
 SL-12-96 48Vac/dc
 SL-12-96 115Vac
 SL-12-96 115Vdc
 SL-12-96 230Vac

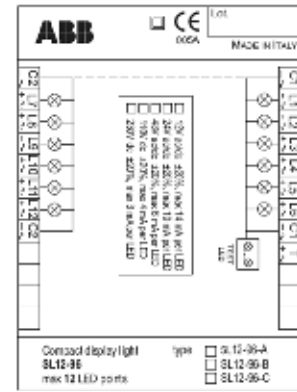

SL-12-72144 24Vac/dc
 SL-12-72144 48Vac/dc
 SL-12-72144 115Vac
 SL-12-72144 115Vdc
 SL-12-72144 230Vac

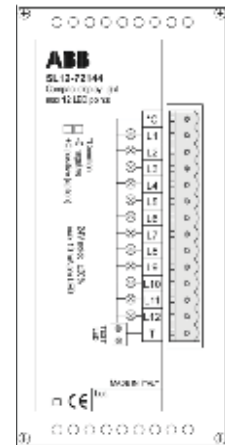

ESB EN

Contact Blocks

EH 04-20



EH 04-11

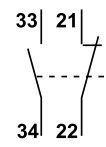

E259

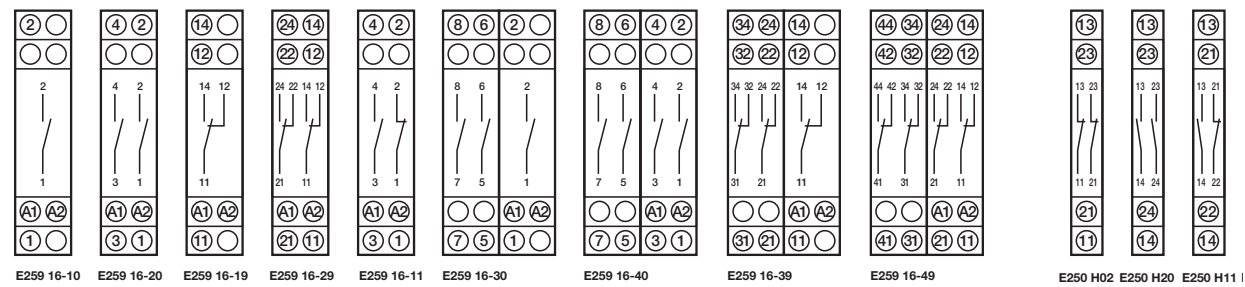

Quick product references

Command and signalling wiring diagrams

E250

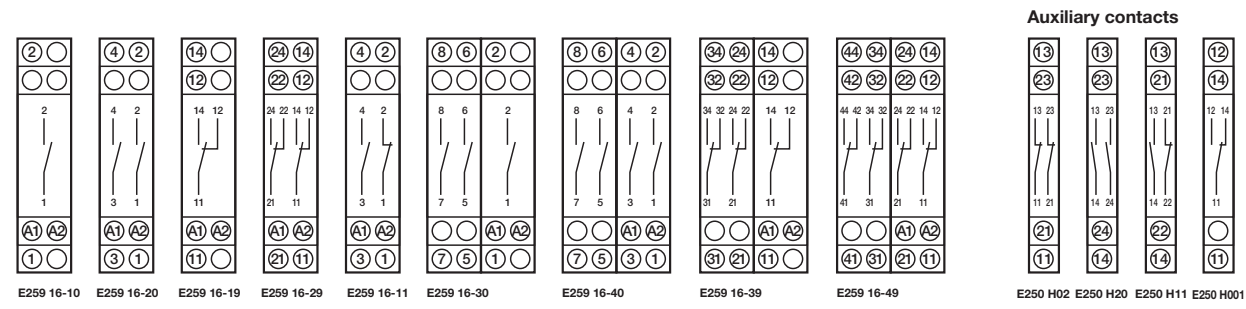

E255, E257

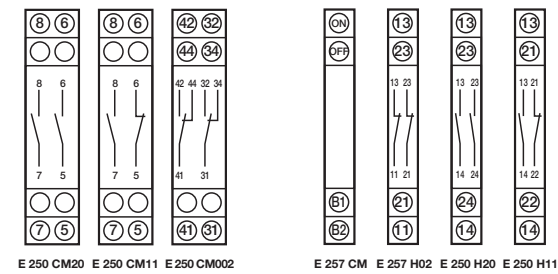
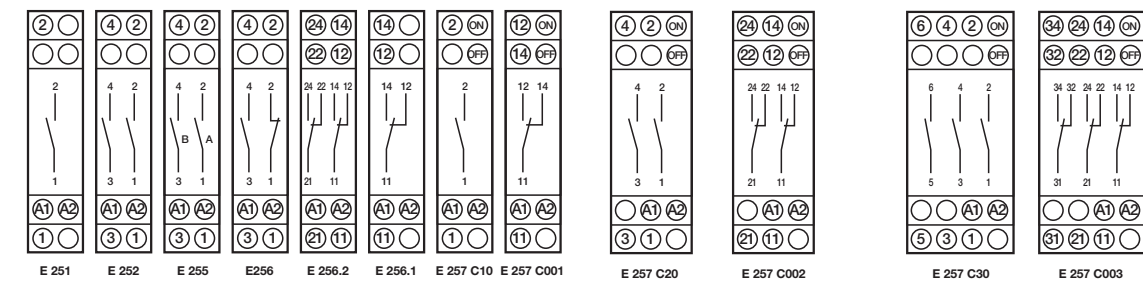

FLR

FLR1-12, FLR1-230

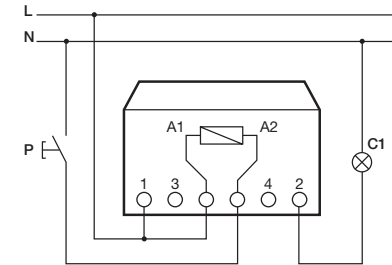

FLR5-12, FLR5-230

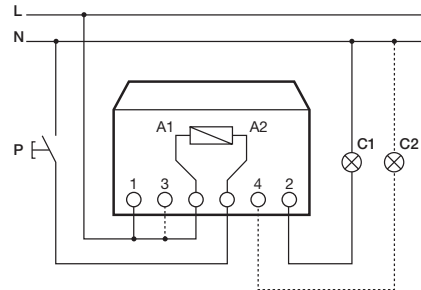

E260

E 261-230

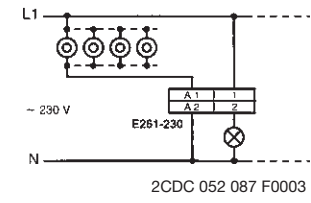

E 261 C-230

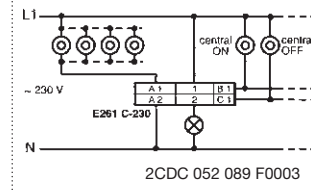

E 266 C-230

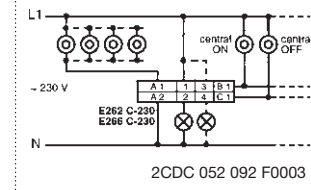

E 261-24

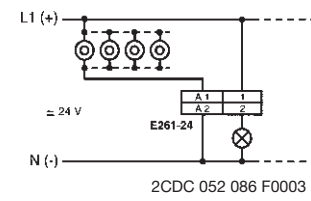

E 261 C-24

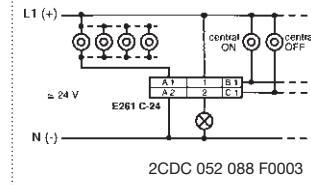

* E 260 C
Caution!
The same electr. potential must be applied to terminals A1, B1 and C1.

E2600

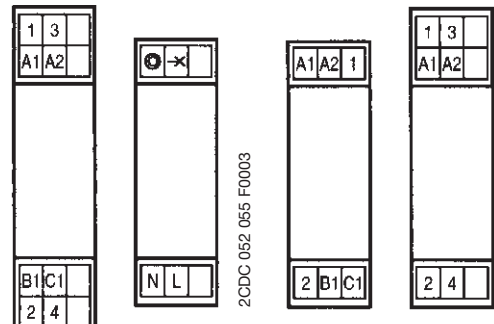

E 266 C
E 262 C E 261-SRV E 261
E 261 C E 266
E 262



E 261-

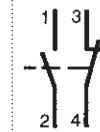

E 266

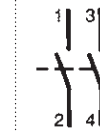

E 262

Quick product references

Command and signalling wiring diagrams

STD

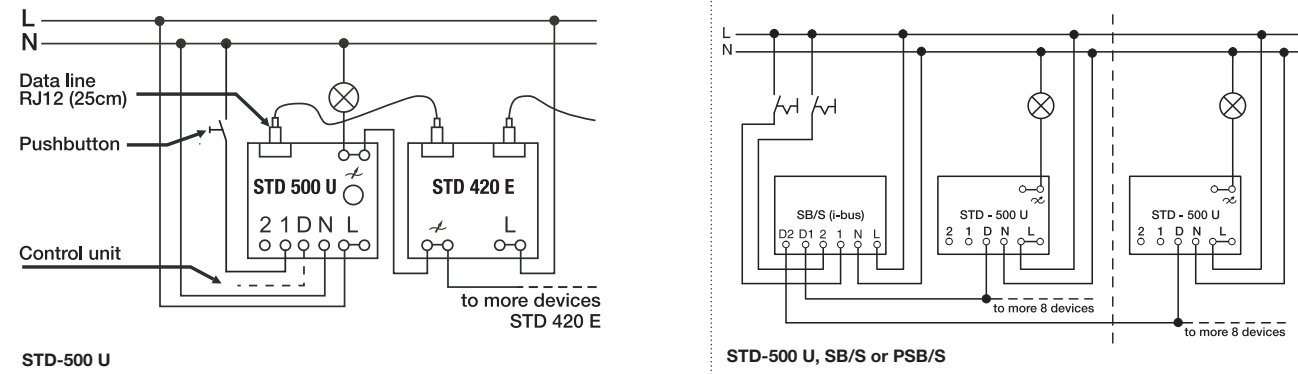

TM-C, TM-S, TM-I

TM-C

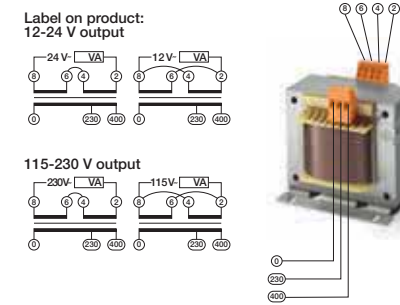

TM-S, TM-I

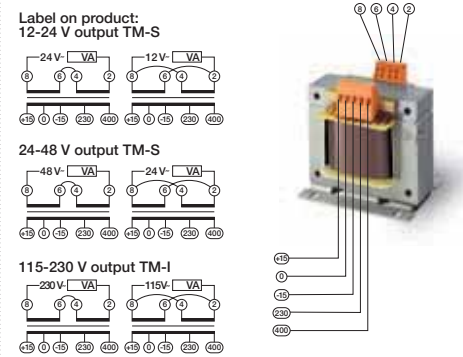

11

Primary voltage TM-I, TM-S

		Cable 2	
		230	400
Cable 1	-15	215V	385V
	0	230V	400V
	15	245V	415V

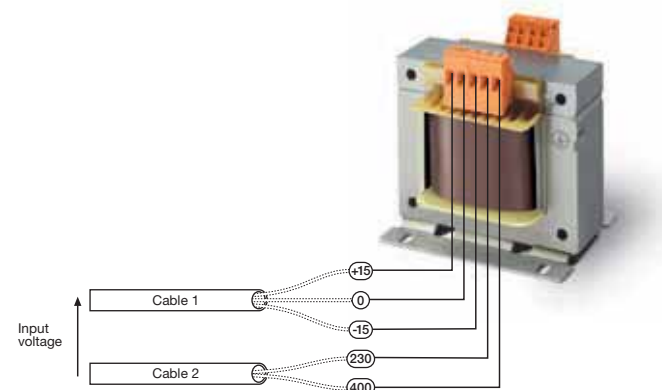

TS-C

TS25/12-24 C

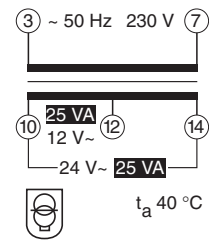

TS40/12-24 C

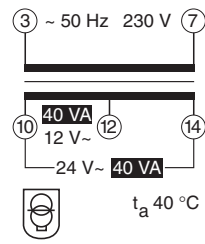

TS63/12-24 C

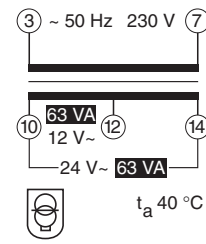

TM

TM10/12

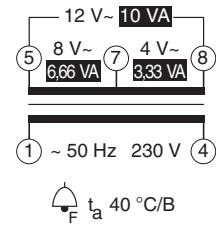

TM10/24

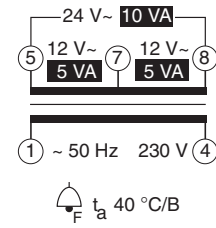

TM15/12

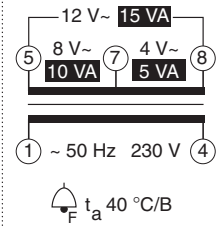

TM15/24

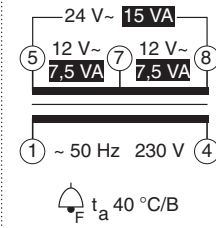

TM30/12

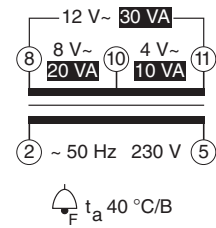

TM30/24

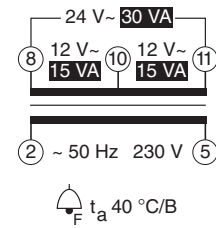

TM40/12

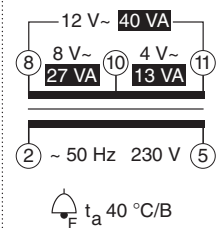

TM40/24

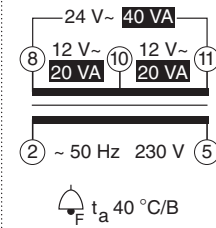

Quick product references

Command and signalling wiring diagrams

TS

TS8/8

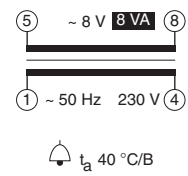

TS8/12

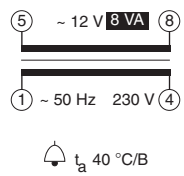

TS8/24

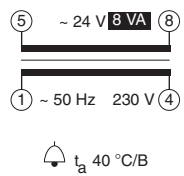

TS8/8 SW

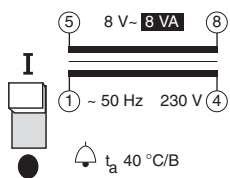

TS8/12 SW

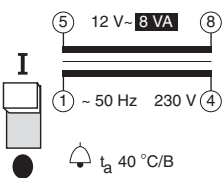

TS8/4-6-8 SW

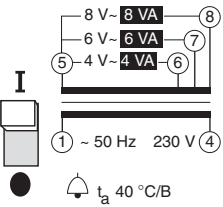

TS8/4-8-12 SW

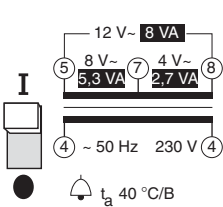

TS16/8

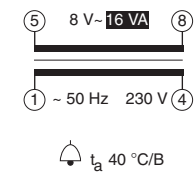

TS16/12

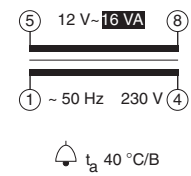

TS16/24

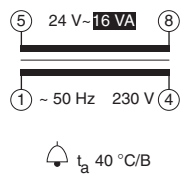

TS16/4-6-8

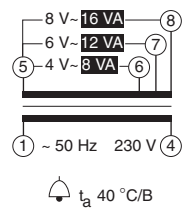

TS16/4-8-12

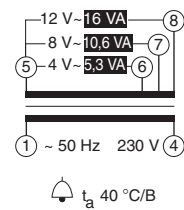

TS24/4-8-12

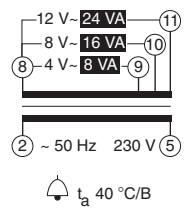

TS24/8-12-24

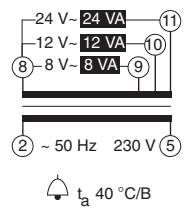

SM, RM...

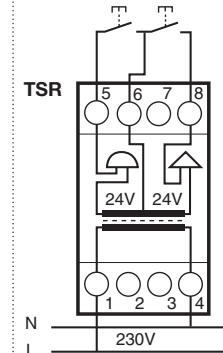
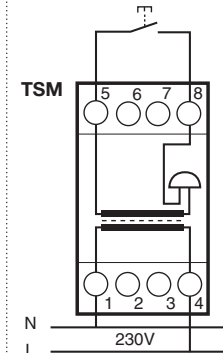
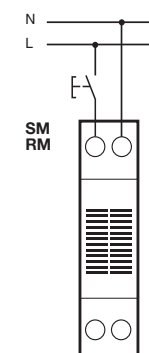

Quick product references

Control and automation wiring diagrams

AT

AT1, AT1-R

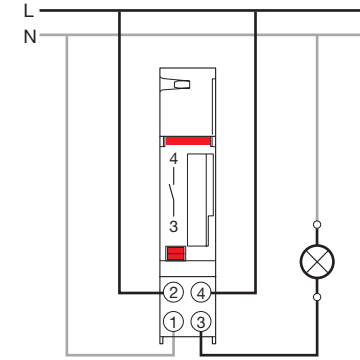

AT3, AT3-R, AT3-7R

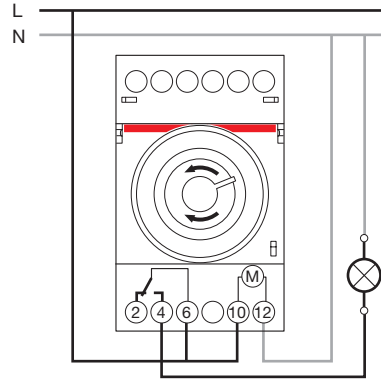

AT2

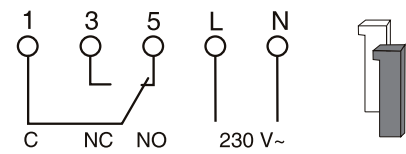
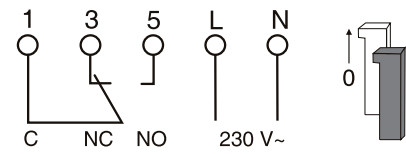

ATP

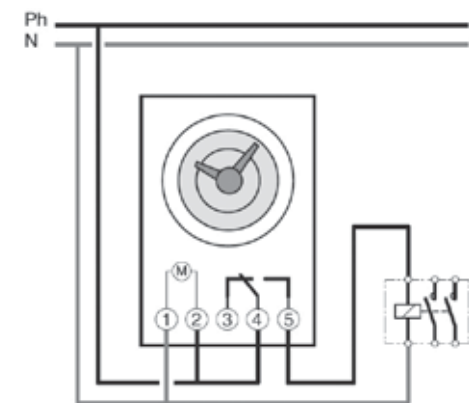

Quick product references

Control and automation wiring diagrams

D Line

D1 and D1 PLUS

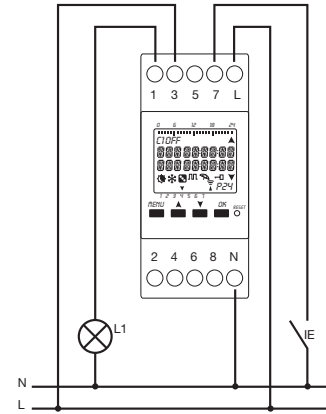

D2 and D2 PLUS

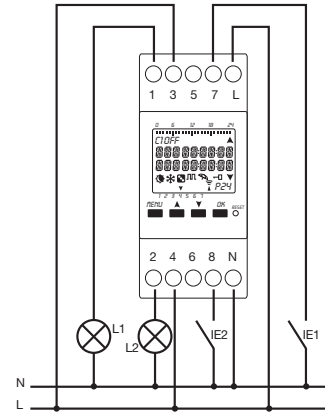

D1 SYNCHRO

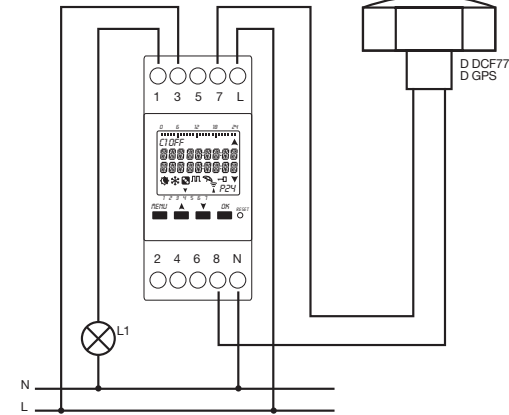

D2 SYNCHRO

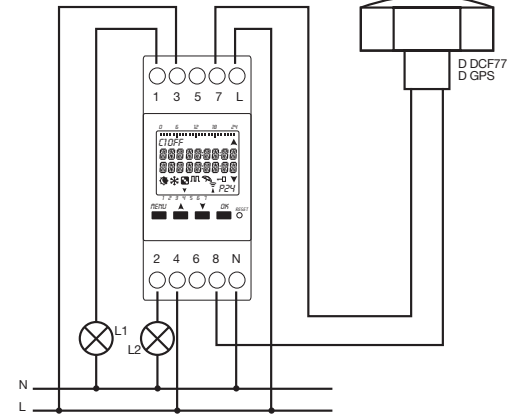

DCF77 and GPS antenna wirings

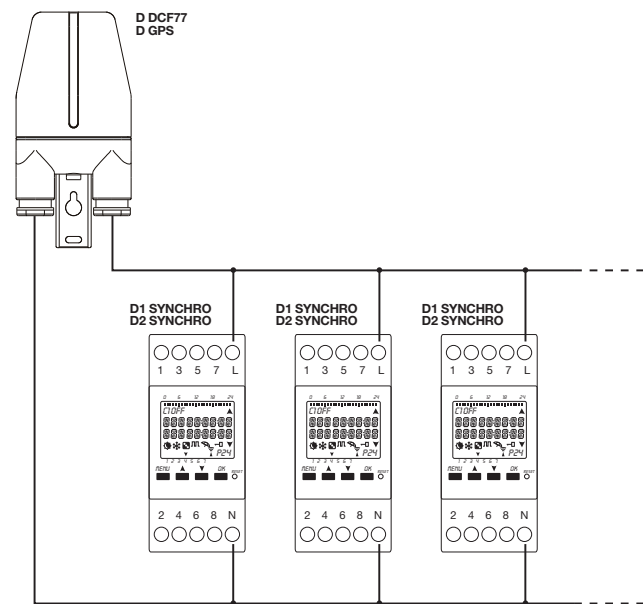

The D DCF77 or D GPS antenna allows you to control up to 10 instruments. The polarity of the first instrument is regardless, while the others have to respect the polarity of the first one.

D 365

D 365

BUS DCF77/GPS

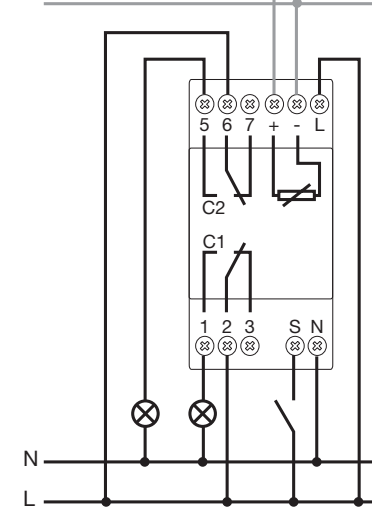

D 365 CE

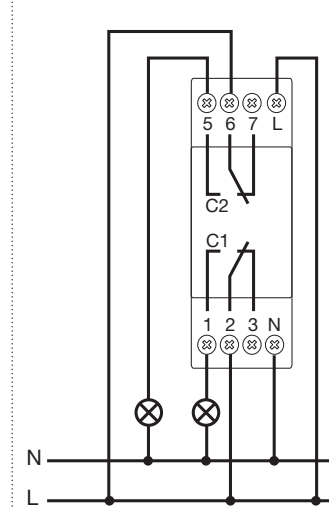

D 365 LAN

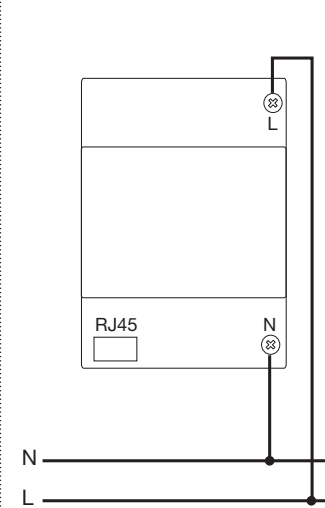

E 232

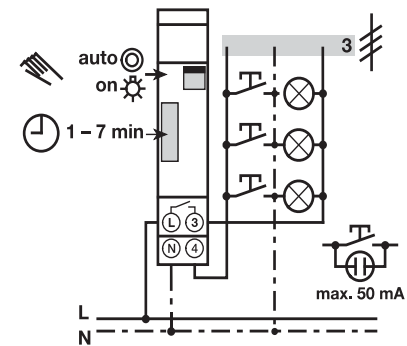

E 232-230 3 conductor

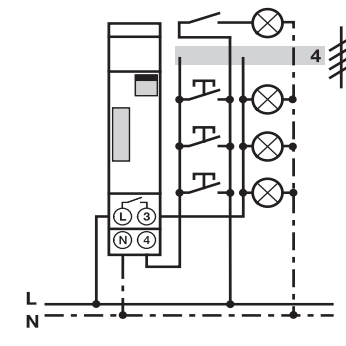

E 232-230 4 conductor

2CDC 052 031 F0007

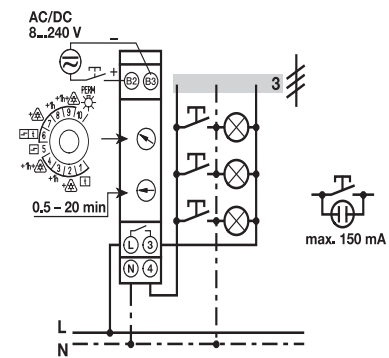

E 232E-8/230 Multi 10 3 conductor

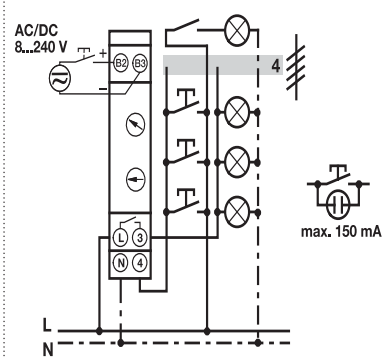

E 232E-8/230 Multi 10 4 conductor

2CDC 052 035 F0007

Quick product references

Control and automation wiring diagrams

E 232

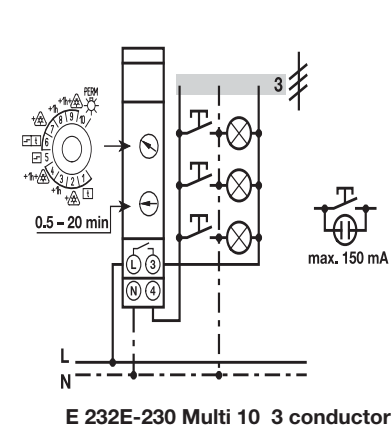

2CDC 052 032 F0007

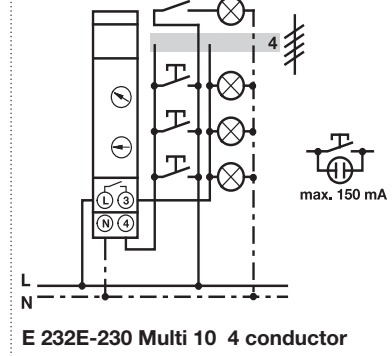

2CDC 052 033 F0007

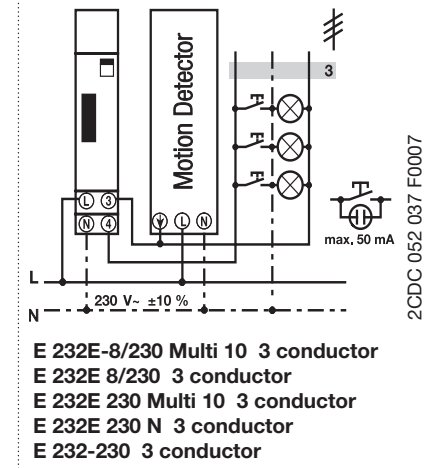

E 232E-8/230 Multi 10 3 conductor
E 232E 8/230 3 conductor
E 232E 230 Multi 10 3 conductor
E 232E 230 N 3 conductor
E 232-230 3 conductor

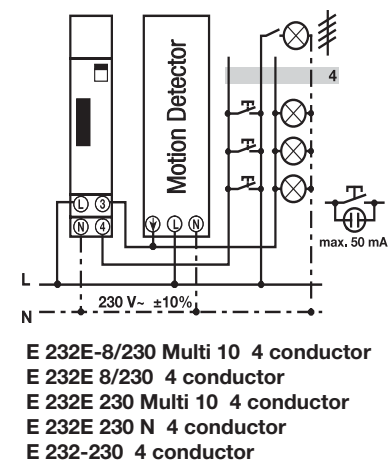

E 232E-8/230 Multi 10 4 conductor
E 232E 8/230 4 conductor
E 232E 230 Multi 10 4 conductor
E 232E 230 N 4 conductor
E 232-230 4 conductor

Staircase lighting time-delay switches E 232 HLM

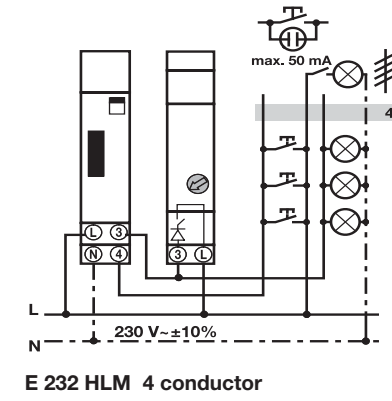
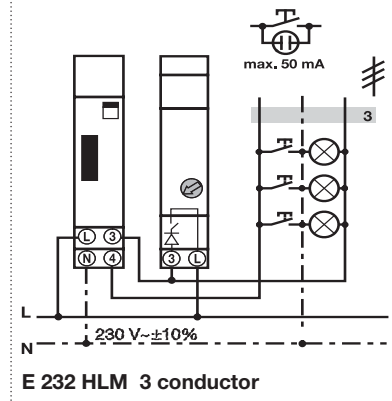

11

CT-MFD.21

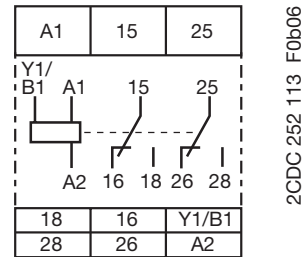

2CDC 252 113 F0b06

CT-MFD.12

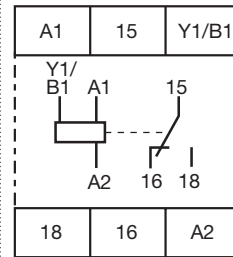

2CDC 252 114 F0b06

CT-ERD.22

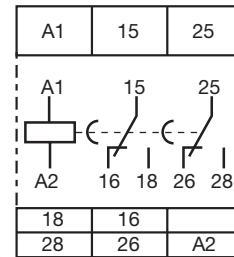

2CDC 252 115 F0b06

CT-ERD.12

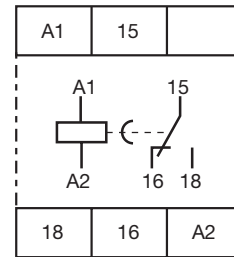

2CDC 252 177 F0b05

CT-AHD.22

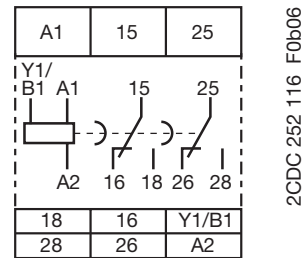

2CDC 252 116 F0b06

CT-AHD.12

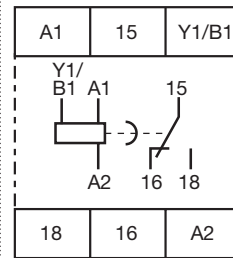

2CDC 252 117 F0b06

CT-VWD.12

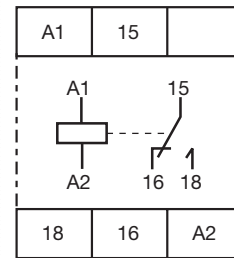

2CDC 252 179 F0b05

CT-EBD.12

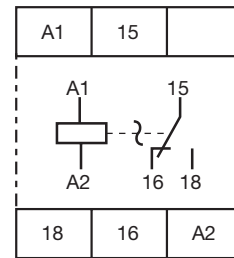

2CDC 252 180 F0b05

CT-TGD.22

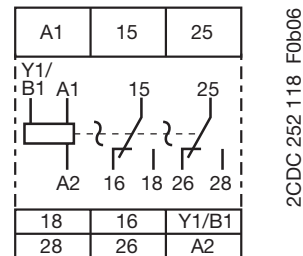

2CDC 252 118 F0b06

CT-TGD.12

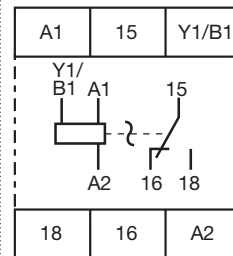

2CDC 252 119 F0b06

CT-SDD.22

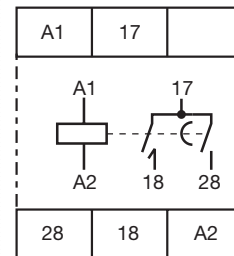

2CDC 252 160 F0b06

CT-SAD.22

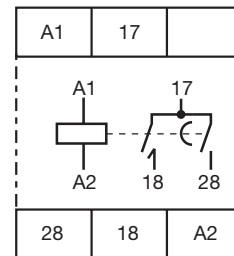

2CDC 252 160 F0b06

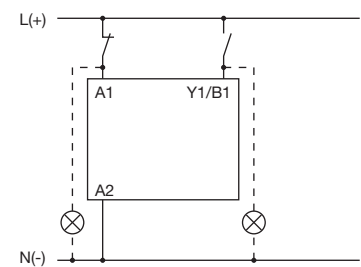

2CDC 252 102 F0b06

Wiring notes for devices with control input
A parallel load to the control input is possible

Quick product references

Control and automation wiring diagrams

T1, T1 PLUS

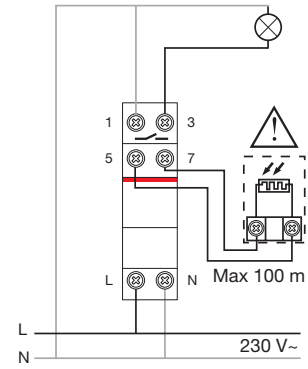

T1 POLE

230 V~ -30T60
 ~ 16 (3)A / 250 V~

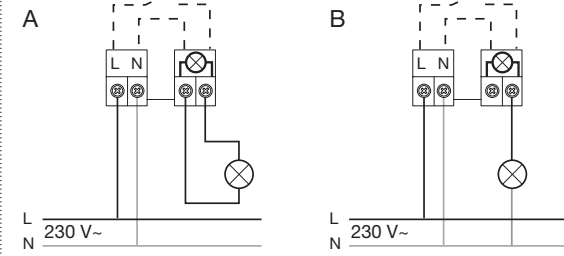

TWA-1

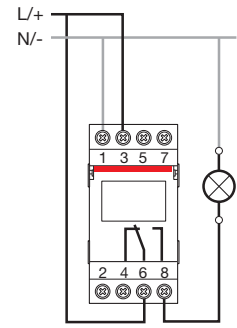

TWA-2

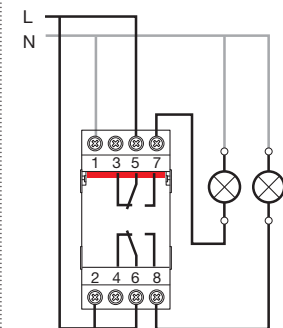

THS-C, THS-W

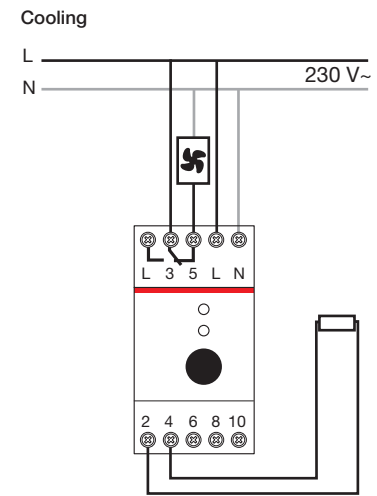
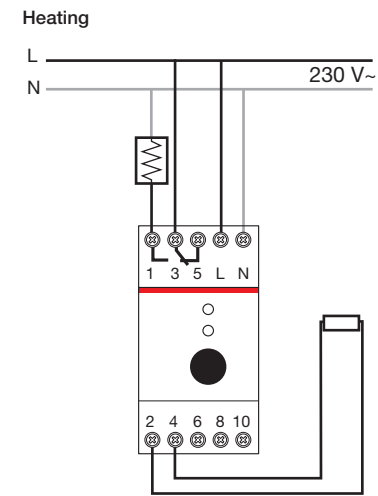

THS-S

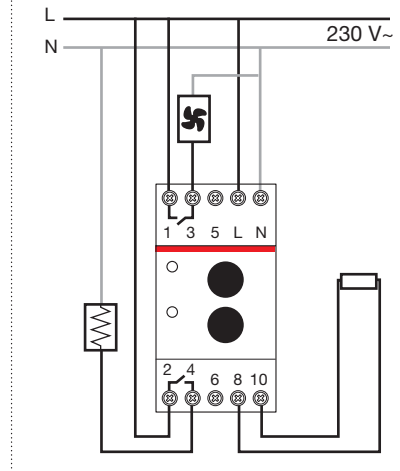

CL

Logic links instead of wiring

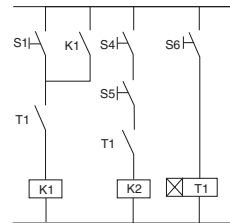

E 450

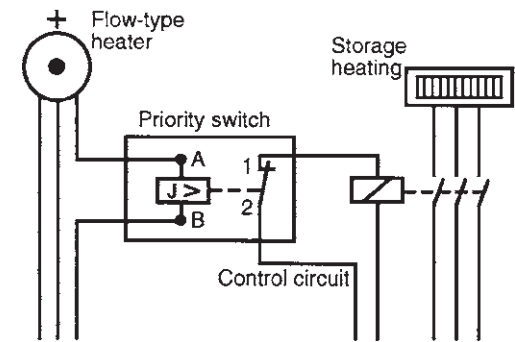

Quick product references

Control and automation wiring diagrams

RAL

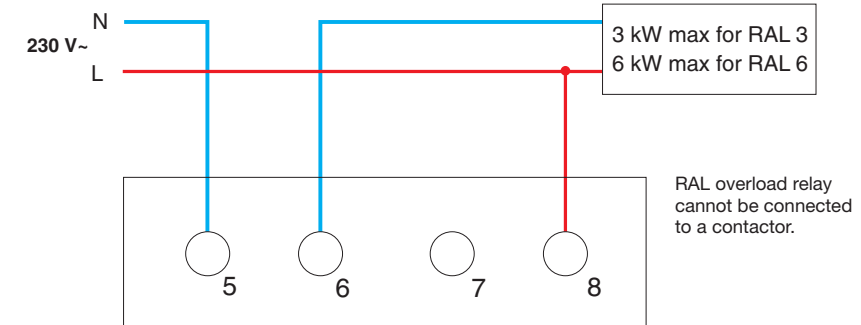

E 235



Quick product references

Energy efficiency wiring diagrams

M2M measurement input and auxiliary power supply connections

Three-phase + neutral with 3 CT

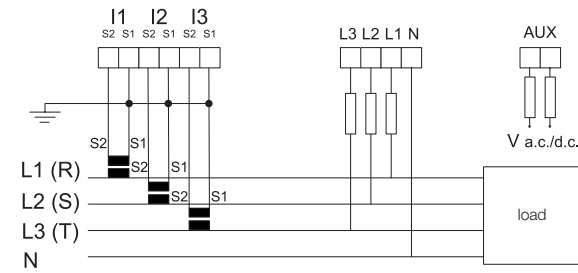

Three-phase with 3 CT

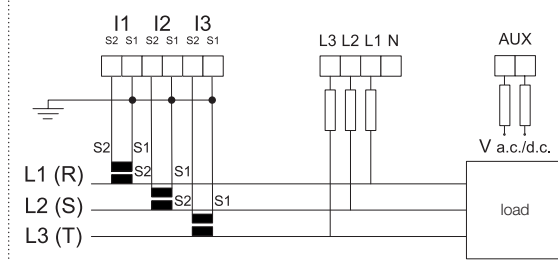

Three-phase + neutral with 3 CT and 3 VT

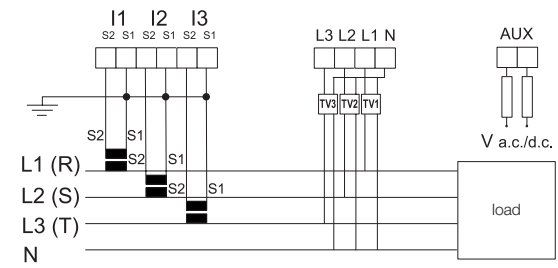

ARON Three-phase with 2 CT and 2 VT

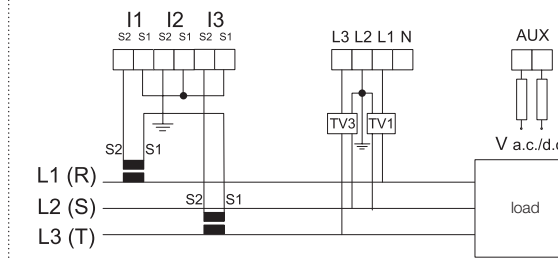

Not suitable for the M2M LV and M2M LV MODBUS models.

Single-phase with 1 CT

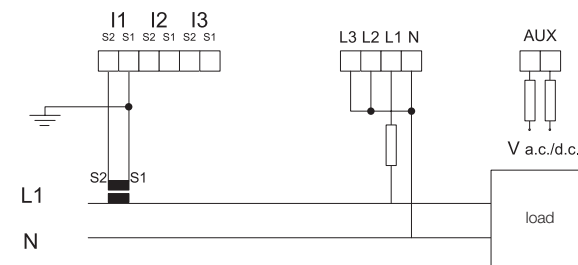

Balanced three-phase with 1 CT

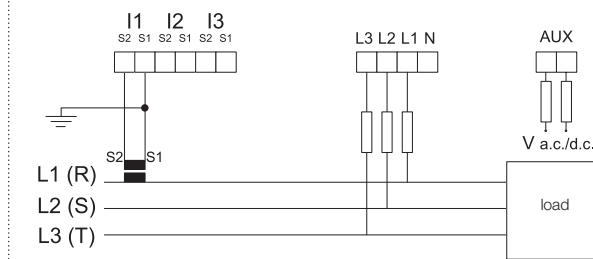

Quick product references

Energy efficiency wiring diagrams

M2M Analogue and digital output connections, digital inputs

Digital outputs as alarms with external relay for control of loads

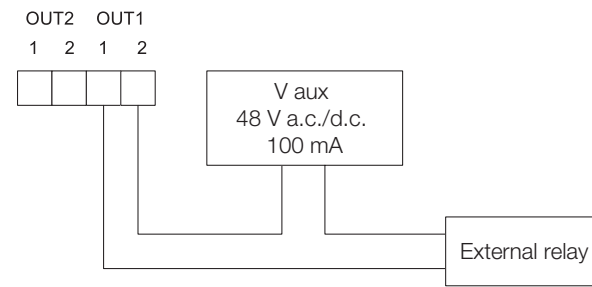

Digital outputs as pulses

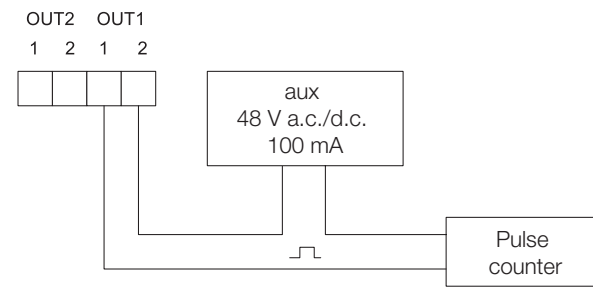

M2M ALARM electromechanical relay outputs

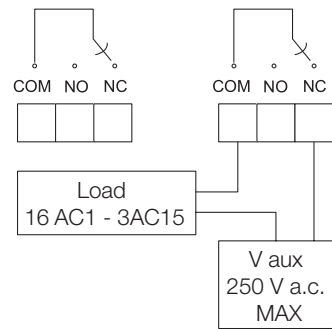

M2M I/O digital inputs (example in NPN mode)

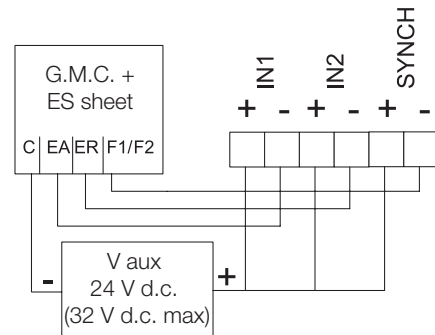

M2M I/O analogue outputs

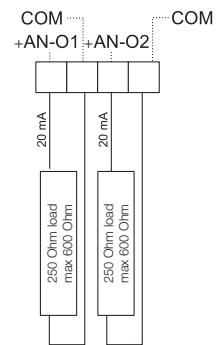

4 wires insertion

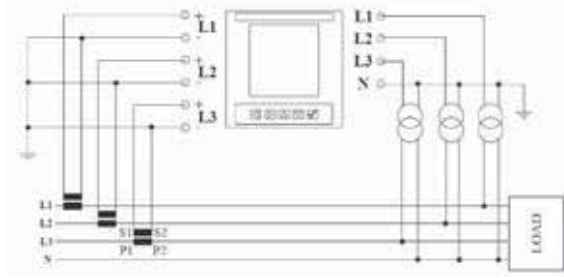

Insertion with 3 CTs and 3 VTs

3 wires insertion

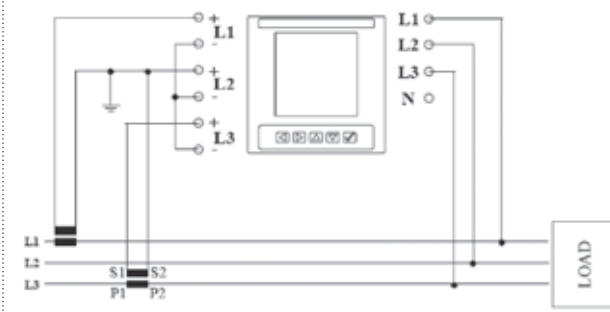

Insertion with 2 CTs

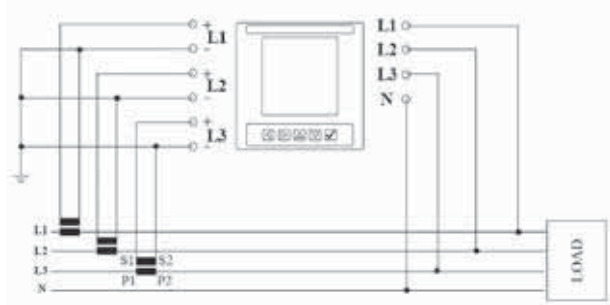

Insertion with 3 CTs

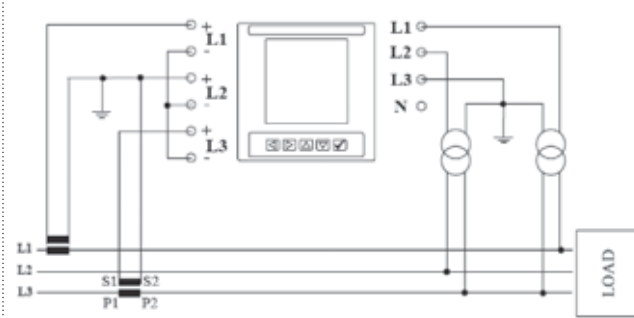

Insertion with 2 CTs and 2 VTs (Aron)

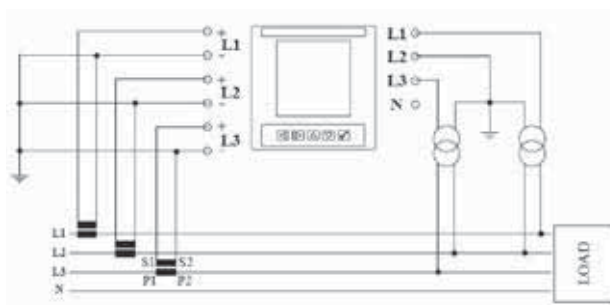

Insertion with 3 CTs and 2 VTs

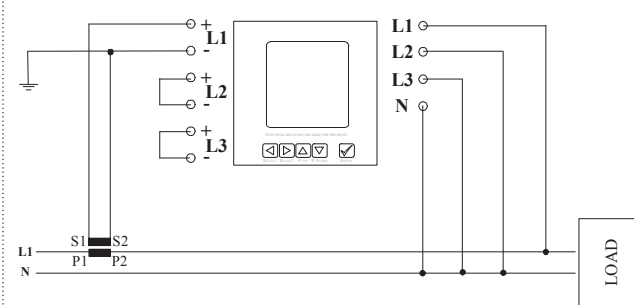

Single phase insertion with 1CT

Quick product references

Energy efficiency wiring diagrams

DMTME

Three-phase with neutral and 3 CTs

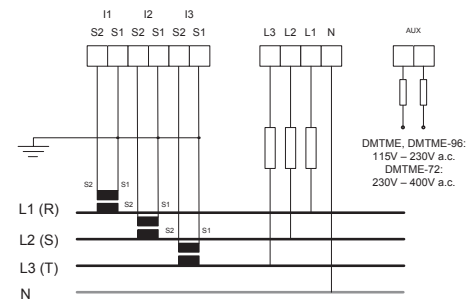

Three-phase with 3 CTs

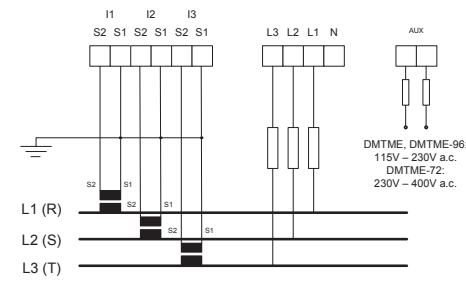

Three-phase with neutral and 3 CTs and 3 VTs
Up to 500 V phase-neutral a direct connection is possible

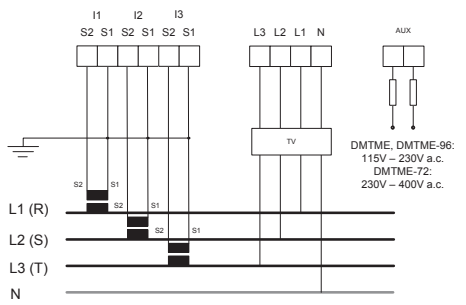

Aron type three-phase with 2 CTs and 2 VTs
With symmetric and unbalanced network, 3 CTs and up to 800 V, beyond this value must use VT.

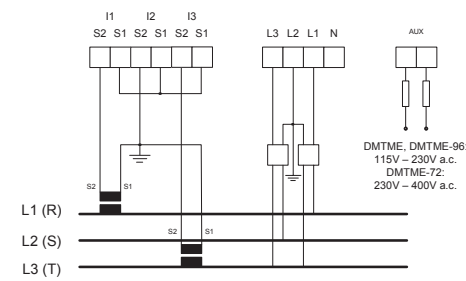

11

Digital output used as alarm with external relays for load command

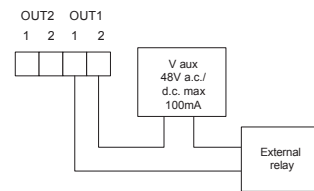

Single phase with neutral and 1 CTs

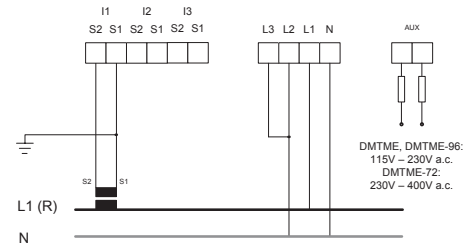

Digital output used as pulses

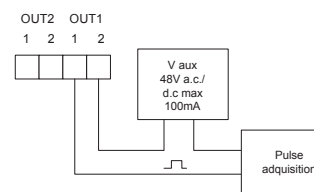

CUS

CUS RS485/232

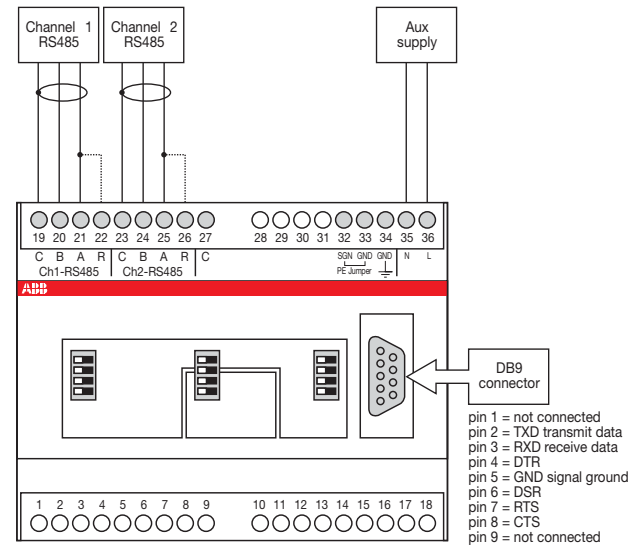

CUS 485 TCP/IP

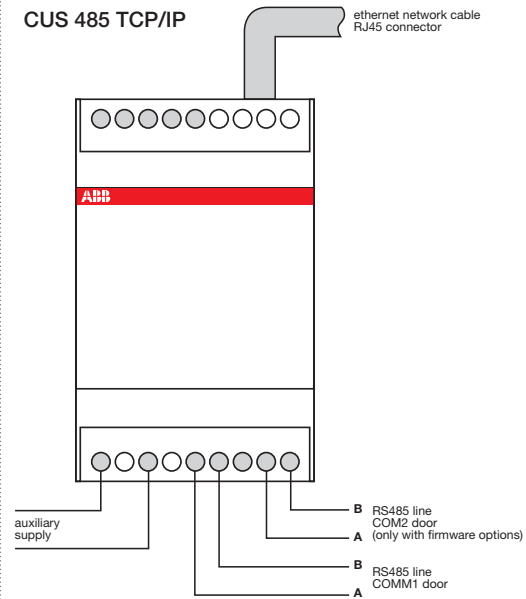

A series A41

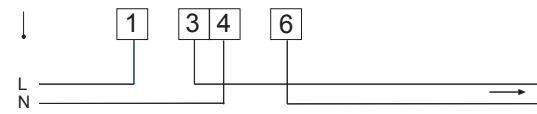

A series A42

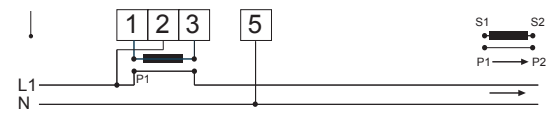

A series A43

3 wire connection, 2 elements

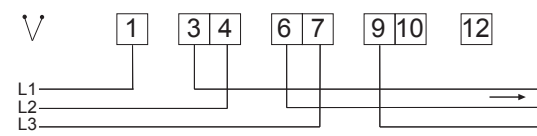

4 wire connection, 3 elements

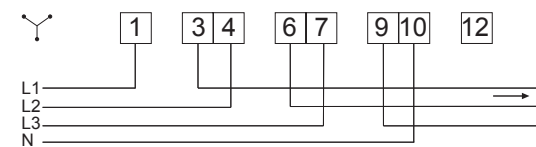

Quick product references

Energy efficiency wiring diagrams

A series A44

3 wire connection, 2 elements

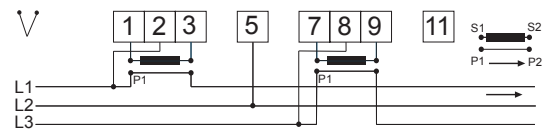

4 wire connection, 3 elements

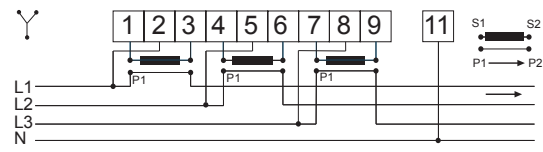

B series B21

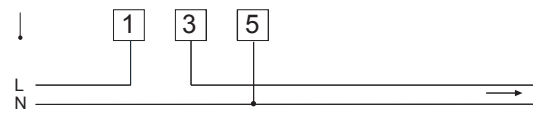

B series B23

3 wire connection, 2 elements

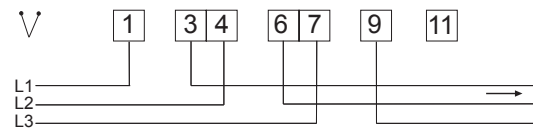

4 wire connection, 3 elements

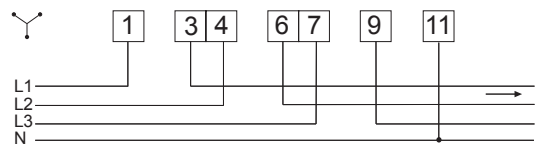

B series B24

3 wire connection, 2 elements

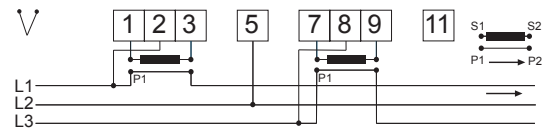

4 wire connection, 3 elements

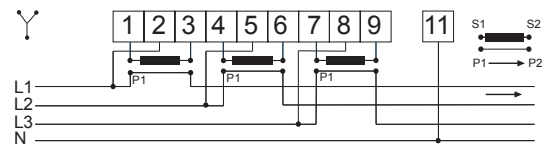

C series C11

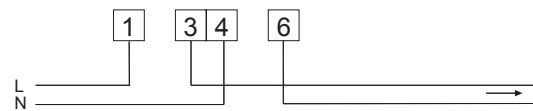

C series C13

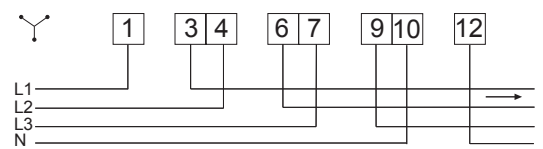

Digital instruments

VLMD-1-2 and VLMD-1-2-R
VLMD P and VLMD-R P

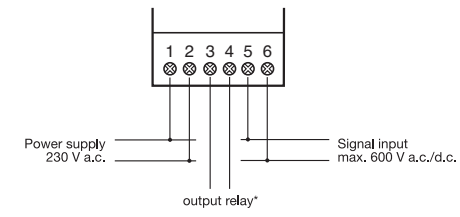

FRZ-DIG

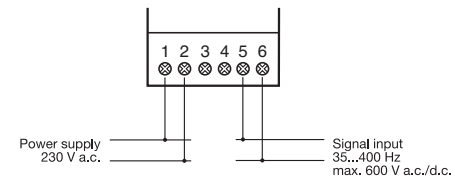

AMTD-1 and AMTD-1-R
AMTD-1 P and AMTD-1-R P

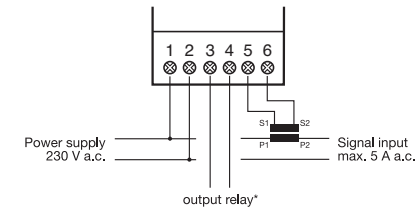

AMTD-2 and AMTD-2-R
AMTD-2 P and AMTD-2-R P

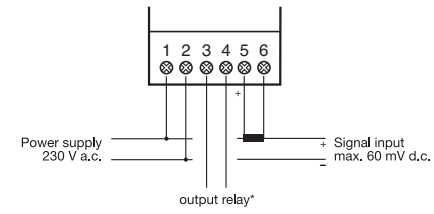

*Only for instruments with output relay

Analogue instruments

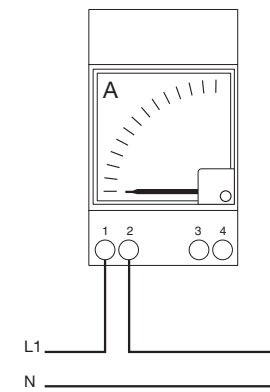
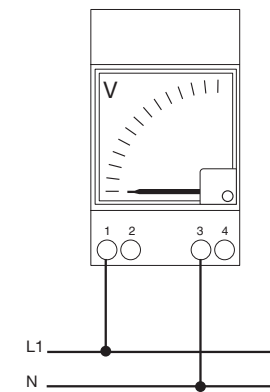

Direct insertion

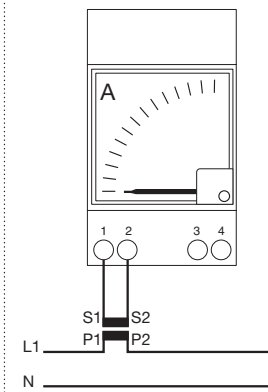

Indirect insertion using C.T.

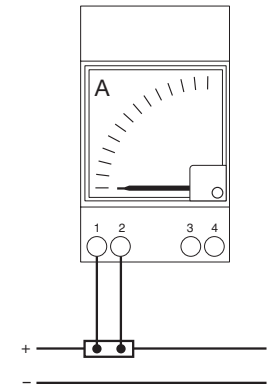

Indirect insertion using shunt

Quick product references

Energy efficiency wiring diagrams

Front panel analogue instruments

Voltmeter for alternating current

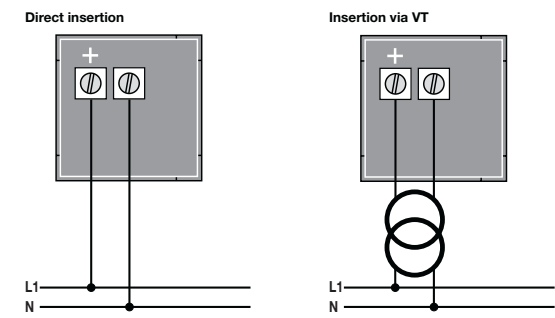

Voltmeter for direct current

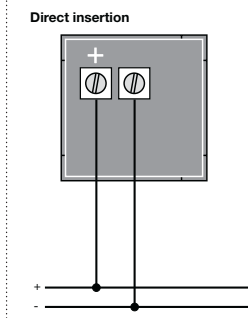

Ammeter for alternating current

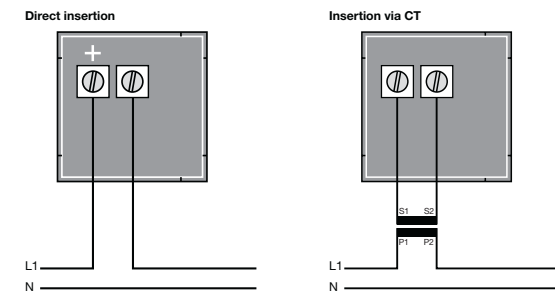

Ammeter for direct current

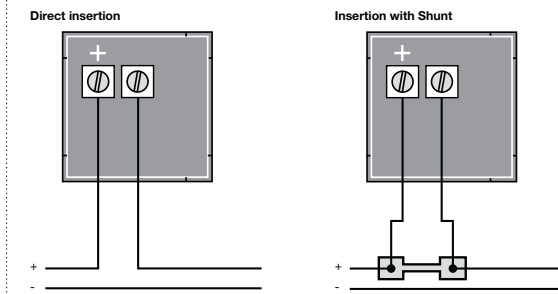

MCV, MCA, QCV and QCA

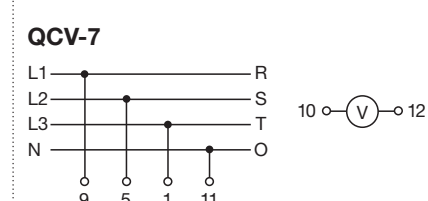
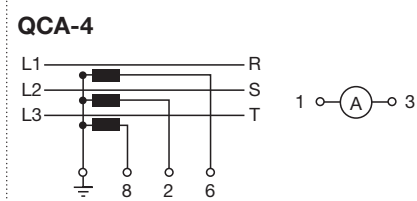
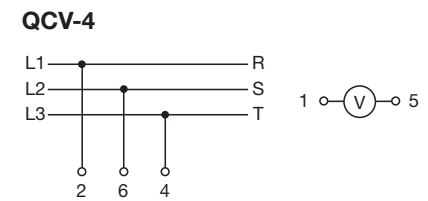
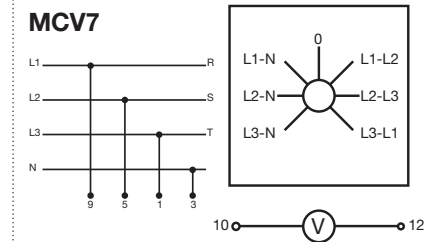
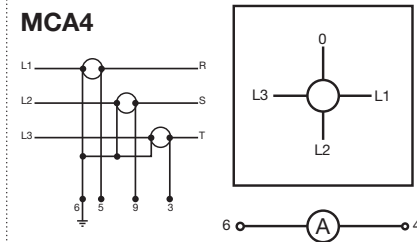
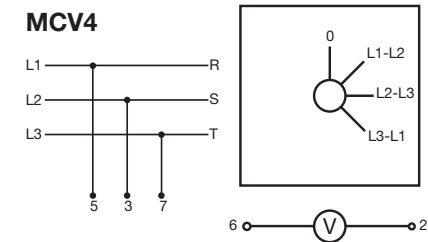

E 233

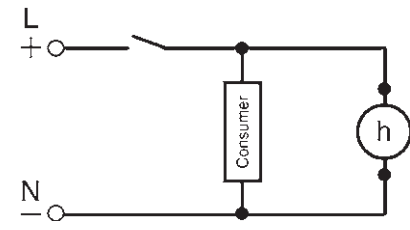

elapsed-time meter

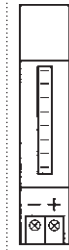

E 233-12/48 DC

HMT

HMT 1

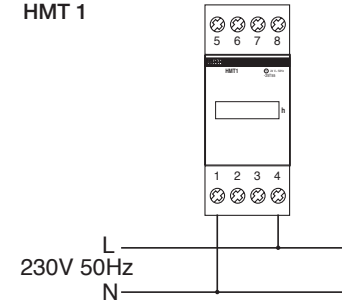

HMT 11

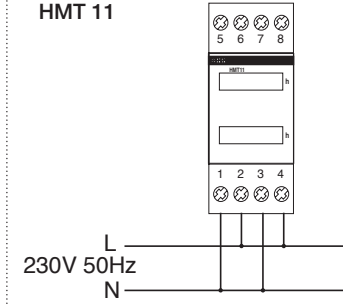

SNT

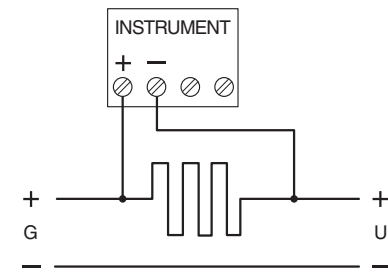

Quick product references

Overall dimensions

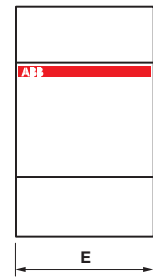
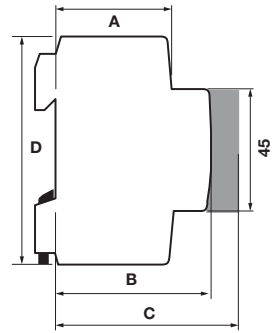

Product (with modular profile)	A [mm]	B [mm]	C [mm]	D [mm]	E [mm]	Modules
Miniature circuit breakers						
S 201	44	-	69	88	17.5	1
S 201 Na					35	2
S 202					35	2
S 203					52.5	3
S 203 Na					70	4
S 204					70	4
S 200 with bottom aux. cont.	See drawings					
S 201 S	44	-	69	89	17.5	1
S 203 S					52.5	3
S 201 U	44	-	71	92	17.5	1
S 202 U					35	2
S 203 U					52.5	3
S 204 U					70	4
S 201 UDC	44	-	71	92	17.5	1
S 202 UDC					35	2
S 203 UDC					52.5	3
S 204 UDC					70	4
S 201 UP	49	-	71	100	17.5	1
S 202 UP					35	2
S 203 UP					52.5	3
S 204 UP					70	4
SN 201	43.5	58	68.9	91.8	17.6	1
S 281	43.5	58	68	90	17.5	1
S 282					35	2
S 283					52.5	3
S 284					70	4
S 291	43.5	65	68	90	26.25	1.5
S 292					52.5	3
S 293					78.75	4.5
S 294					105	6
S 700	See drawings					
S 700 with aux. cont.	See drawings					
S 700 with DIN rail adapter	See drawings					
S 801	52	82.5	88.5	95	26.5	1.5
S 802					53	3
S 803					79.5	4.5
S 804					106	6
S 801_R	52	82.5	88.5	142	26.5	1.5
S 802_R					53	3
S 803_R					79.5	4.5
S 804_R					106	6
S 501	56.5	80	92	91	25	1.5
S 502					50	3
S 503					75	4.5
S 504					100	6

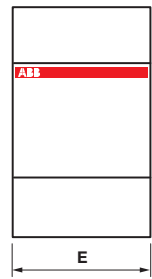
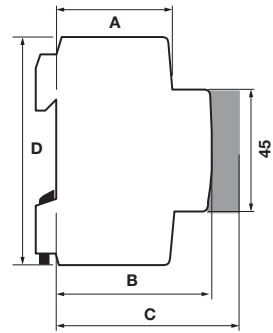

Product (with modular profile)	A [mm]	B [mm]	C [mm]	D [mm]	E [mm]	Modules
Residual current devices						
F 202	44	-	69	88	35	2
F 204					70	4
F 204 B	44	60	69.5	-	72	4
F 204 125 A						2
F 204 PV B						2
DDA 200	See drawings					
DS 202 up to 40 A	44	-	69	93	70	4
DS 203 up to 40 A					87.5	5
DS 204 up to 40 A					105	6
DS 202 50, 63 A	44	-	69	93	70	4
DS 203 50, 63 A					122.5	7
DS 204 50, 63 A					140	8
DS201	43	58	67	85	35	2
DS202C						
DS 271	See drawings					
DDA 800	See drawings					
RD2	44	58	-	85	35	2
RD3	44.2	57.9	57.9	85	58.2	3.5
ELR	See drawings					
Toroidal transformers	See drawings					
Auxiliary elements and accessories						
S 2C-A_	44	-	69	85	17.5	1
S 2C-H11L					8.8	0.5
S 2C-H20L						
S 2C-H02L						
S 2C-S/H 6R						
S 2C-H 6R						
S 2C-UA_	44	-	74	85	17.4	1
F 2C-A_						
S 2C-OVP						
F 2C 125A-SH/S2C-Nt	44	-	70	88	8.8	0.5
Bottom fixing aux. cont.	See drawings					
S 2C-EST	See drawings					
S 2C-BP	44	-	68	85	17.5	1
S 2C-CM	See drawings					
F 2C-ARI	See drawings					
F 2C-CM	See drawings					
F 2C-ARH	See drawings					
F 2C-ARH-T	See drawings					
Aux. elements for SN201	See drawings					
Aux. elements for S280 and S290	44	-	73	90	8.75	0.5
					17.5	1
S800-AUX	See drawings					
S800-RSU-H	See drawings					
S800-RD+S800-RHE	See drawings					

Quick product references

Overall dimensions

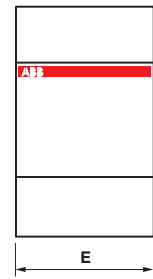
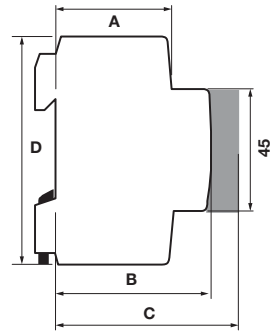

Product (with modular profile)	A [mm]	B [mm]	C [mm]	D [mm]	E [mm]	Modules
Terminal covers	See drawings					
Enclosures	See drawings					
Flush frame	See drawings					
Busbars	See drawings					
Me flange	See drawings					
OH_2A_	See drawings					
Protection and safety						
Type 1 SPD 1 pole	45.5	58	-	85	17.8/35	1/2
Type 1 SPD 2 poles	43.5				70.4	4
Type 1 SPD 2 poles + TS					88	5
Type 1 SPD 3 poles					105	6
Type 1 SPD 3 poles + TS					122.5	7
Type 1 SPD 4 poles					140	8
Type 1 SPD 4 poles + TS					157.5	9
Type 1+2 SPD 1 pole					17.8/35	1/2
E91	-	-	64	85	17.5	1
E91+N					35	2
E92					35	2
E93					52.5	3
E93+N					70	4
E94					70	4
E91h	-	-	64	85	17.5	1
E91h+N					35	2
E92h					35	2
E93h					52.5	3
E93h+N					70	4
E94h					70	4
E931	See drawings					
E931+N	See drawings					
E932	See drawings					
E933	See drawings					
E933+N	See drawings					
E934	See drawings					
E931 125 A	See drawings					
E931+N 125 A	See drawings					
E932 125 A	See drawings					
E933 125 A	See drawings					
E933+N 125 A	See drawings					
E934 125 A	See drawings					
ILTS 1 pole	44	64	??	90	27	1.5
ILTS 2 poles					54	3
ILTS 3 poles					81	4.5
ILTS 4 poles					108	6

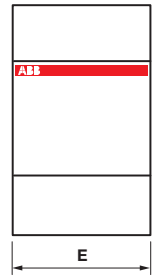
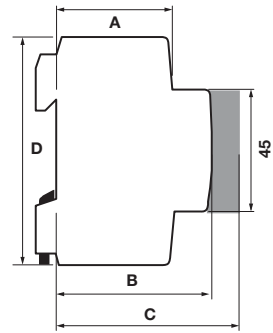

Product (with modular profile)	A [mm]	B [mm]	C [mm]	D [mm]	E [mm]	Modules
ILTS-E 1 pole	44	70	70	90	27	1.5
ILTS-E 2 poles					54	3
ILTS-E 3 poles					81	4.5
ILTS-E 4 poles					108	6
SQZ3	44	58	58	85	52.5	3
RH/RL	44	58	58	85	52.5	3
E 236 US1	44	60	65	87	35	2
E 236 US2						
E 236 US1.1	44	60	60	87	17.5	1
E 236 US2.1						
E 236 US1.1D						
Isoltester-DIG	44	56	61	90	105	6
PM554	See drawings					
CP415	See drawings					
Selvtester-24	44	58	58	85.5	52.5	3
QSD	See drawings					
TI	See drawings					
QSO	See drawings					
ISL-A 115	44	58	65	90	105	6
ISL-A 230						
ISL-A 600						
ISL-C 600						
ISL-A 24-28	44	58	65	85.5	52.5	3
ISL-C 230						
ISL-C 440						
ISL-MOT 1000						
QIT	See drawings					

Command and signalling

E201	44	58	70	85	17.5	1
E202					35	2
E203					52.5	3
E204					70	4
E463	44	58	70	85	44	2.5
E210	43.5	58	67.9	85	9	0.5
E210					18	1
ESB 20	44	58	58	85	17.5	1
ESB 24					35	2
ESB 40					54	3
ESB 63						
EN 20	44	58	58	85	17.5	1
EN 24					35	2
EN 40					54	3
EN 63						

Quick product references

Overall dimensions

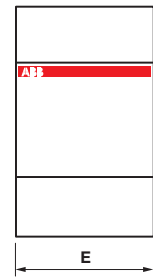
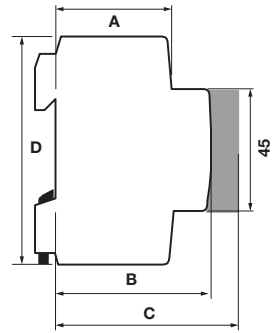

Product (with modular profile)	A [mm]	B [mm]	C [mm]	D [mm]	E [mm]	Modules						
E 259 16-10	43.5	58	62	85	17.5	1						
E 259 16-20												
E 259 16-11												
E 259 16-19												
E 259 16-29												
E 259 16-30	43.5	58	62	85	35.6	2						
E 259 16-40												
E 259 16-39												
E 259 16-49												
E257-C003												
E257-C30	43.5	58	62	85	26.7	1.5						
E257-C20												
E257-C002												
E251							43.5	58	62	85	17.5	1
E252												
E256												
E256.1												
E256.2												
E257-C10	43.5	58	62	85	8.9	0.5						
E250 CM												
E250 CP												
E250 GM												
E257-CM												
E250-H	See drawings											
FLR	See drawings											
E261	43.4	58	58	85	17.5	1						
E261C												
E262												
E266												
E262C												
E266C												
E261SRV												
STD							See drawings					
E 234 1 contact							43.4	58	58	70	17.5	1
E 234 2 contacts										80		
TS 25 C	44	58	58	85	70	4						
TS 40 C					70	4						
TS 63 C					87.5	5						
TM10	44	58	58	85	35	2						
TM15												
TS8...16												
TM30							52.5	3				
TM40												
TS24												

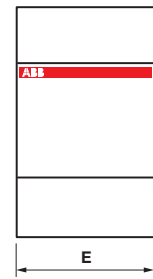
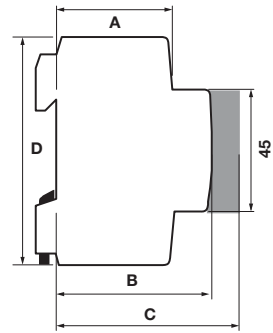

Product (with modular profile)	A [mm]	B [mm]	C [mm]	D [mm]	E [mm]	Modules
SM	44	58	58	85	17.5	1
RM						
TSM					35	2
TSR						
CP-D 12/0.83	44	58	58	91	18	1
CP-D 24/0.42						
CP-D 24/2.5					71	4
CP-D 12/2.1					53	3
CP-D 24/1.3						
CP-D 24/4.2					89.9	5
TM_	See drawings					
M117_	44	60	60	85	44	2.5
M2071						
M1011					53	3
M1363						
MA1-8001	See drawings					
Control and automation						
AT1	44	60	60	88.5	17.8	1
AT1-R						
AT2					35	2
AT2-R						
AT2-7R						
AT3					54	3
AT-R						
AT-7R						
ATP	See drawings					
D	43.8	60	60	90	35	2
D 365					52.5	3
D 365 LAN						
D 365 CE					35	2
D 365 DCF77	See drawings					
D 365 GPS	See drawings					
E 232-230	44	59	59	88	17.5	1
E 232 E			58	90		
E 232 HLM						
TWA-1	43.8	60	60	85	35.8	2
TWA-2						
T1, T1 PLUS	-	-	65	86	17.5	1
THS_	44	60	60	90	35	2
ATT GSM	-	58	58	85	71	4
CL	See drawings					
E 450	-	60	60	85	17.5	1
RAL	44	58	58	85	35	2
LSS1/2	-	58	58	85	87.5	5
E 235	-	58	58	85	17.5	1
LEE	See drawings					

Quick product references

Overall dimensions

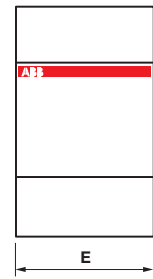
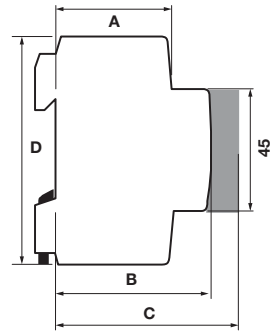

Product (with modular profile)	A [mm]	B [mm]	C [mm]	D [mm]	E [mm]	Modules
Energy efficiency						
Modular analogue measurement instruments	44	58	58	85	52.5	3
Modular digital measurement instruments	44	58	58	85	52.2	3
MCV, MCA	See drawings					
QCV, QCA	See drawings					
DMTME	44	58	58	90	105	6
CUS	44	58	58	90	105	6
CUS 485					52.5	3
TRF M	44	58	58	85.5	52.5	3
TV2	See drawings					
Shunts	See drawings					
E 233	44	58	58	85	17.5	1
HMT	44	58	58	85	35	2
A41	44	65	65	97	70	4
A42						
A43					123	7
A44						
B21					35	2
B23					70	4
B24						
C11				111	17.5	1
C13				122	54	3

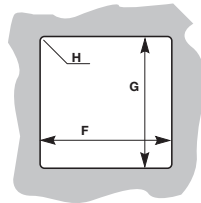
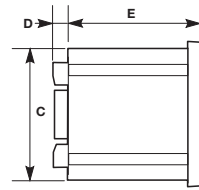
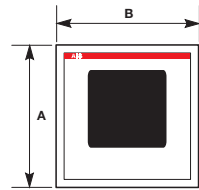

Product (without modular profile)	A [mm]	B [mm]	C [mm]	D [mm]	E [mm]	F [mm]	G [mm]	H
Front panel devices								
SL - 48	48	48	44	7	48	45	45	R3
SL - 72	144	72	-	9	55	67	137	R3
Analogue measurement instruments - 48	48	48	43	6	53	45±0.1	45±0.1	R3
Analogue measurement instruments - 72	72	72	67	6	53	68±0.7	68±0.7	R3
Analogue measurement instruments - 96	96	96	90	6	53	92±0.8	92±0.8	R3
Digital measurement instruments	36	72	32	6	51.5	68±0.8	33±0.8	R3
M2M	96	96	90	16	61	92	92	R3
ANR 96	96	96	90	14	115	92	92	R3
TMD	96	96	90	14	115	92	92	R3
DMTME - 96	96	96	90	13	90	92	92	R3
DMTME - 72	72	72	-	10	90	68	68	R3

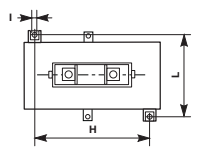
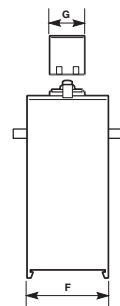
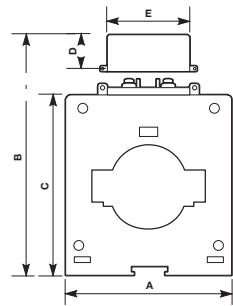

Product (without modular profile)	A [mm]	B [mm]	C [mm]	D [mm]	E [mm]	F [mm]	G [mm]	H [mm]	I [mm]	L [mm]
Measurement current transformers										
CT MAX	see drawings									
CT PRO XT	see drawings									
CTA	see drawings									
CT6	105	121	100	18.5	75	61	21	82	3.7	76.7
CT8	125	142	120	18.5	50	61.5	21	82	3.7	76.7
CT8-V	109	141	119	18.5	50	41	21	-	-	-
CT12 up to 4000 A	180	196	175	18.5	50	68.5	21	156.8	3.7	84
CT12 5000 A, CT12 6000 A	272	290	265	25	50	-	-	-	-	50
CT12-V	109	186	165	18.5	50	41	21	-	-	-
CTO	see drawings									

Quick product references

Overall dimensions

S 200 with bottom-fitting auxiliary contact

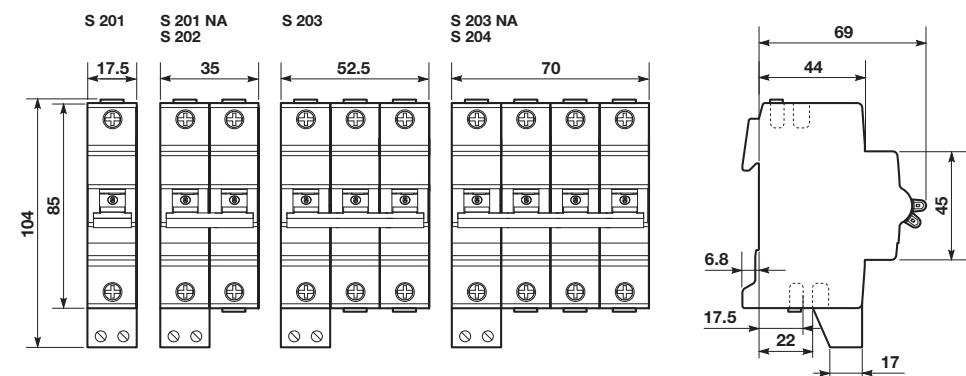

S 700

S 701 with DIN rail adapter

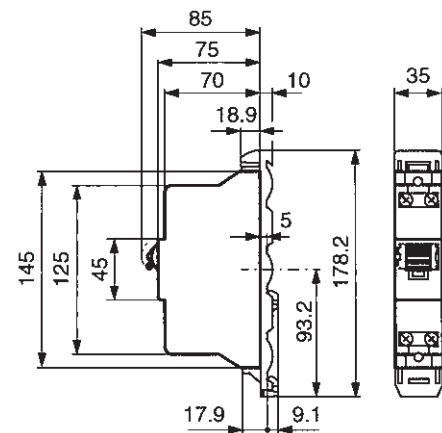

3 x S 701 with busbar adapter

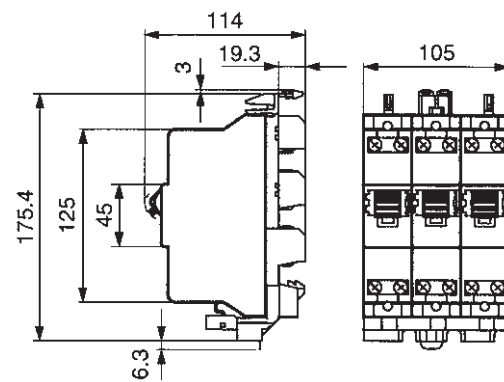

DDA 200

In=25-40 A

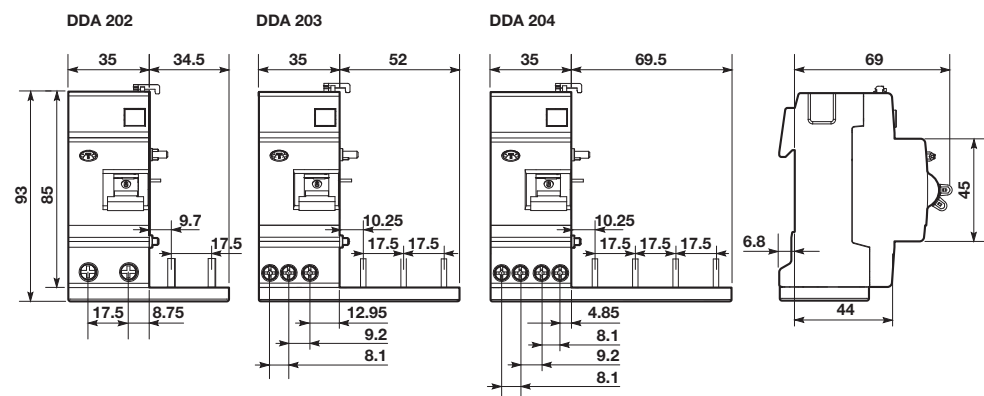

In=63 A

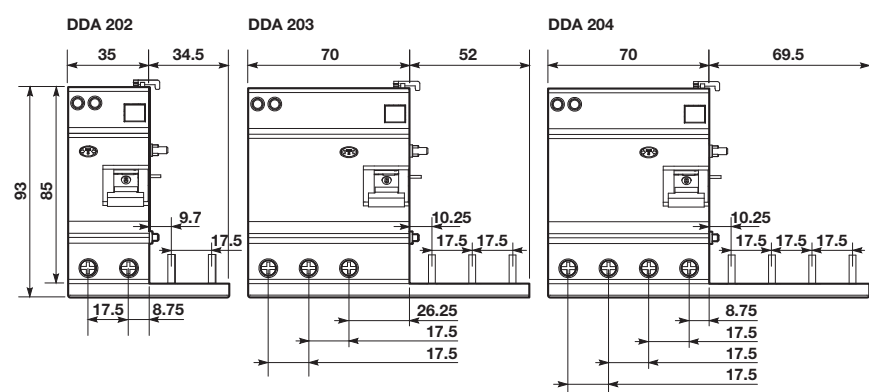

DDA 200 B

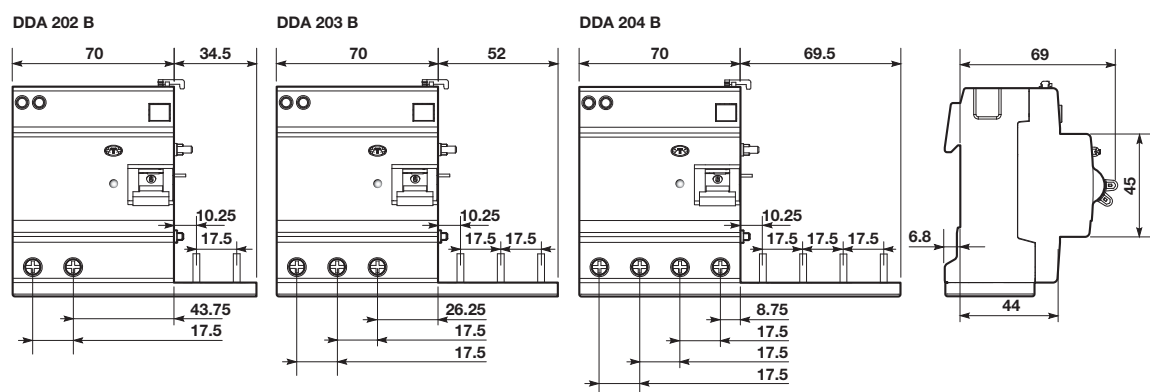

Quick product references

Overall dimensions

DS 271

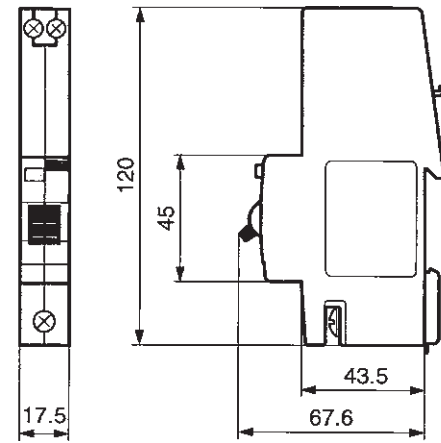

DDA 800 for S800 and DS800 series

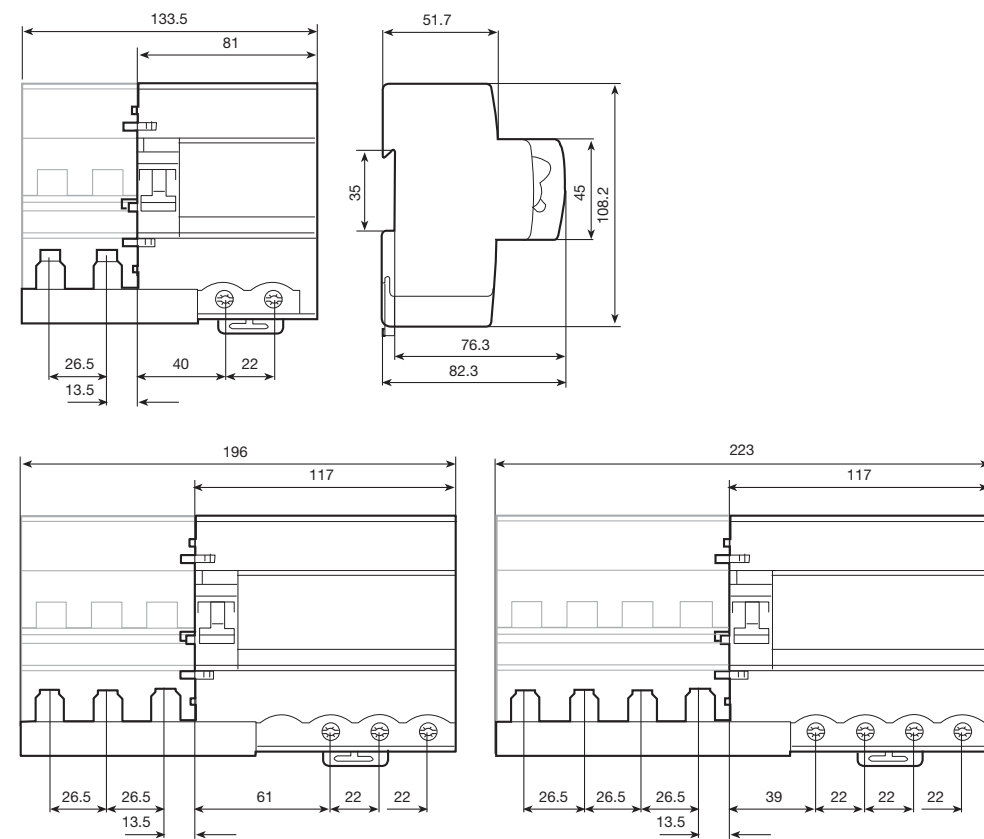

ELR front panel residual current relays

ELR48P

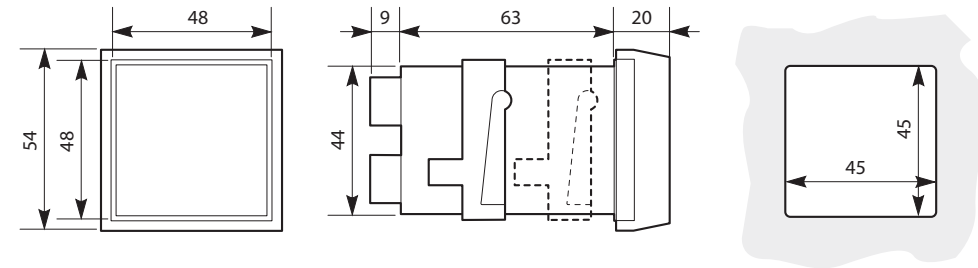

ELR72

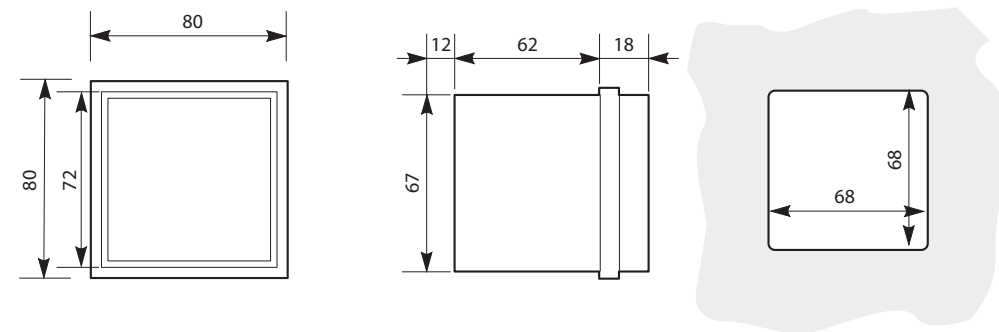

ELR96

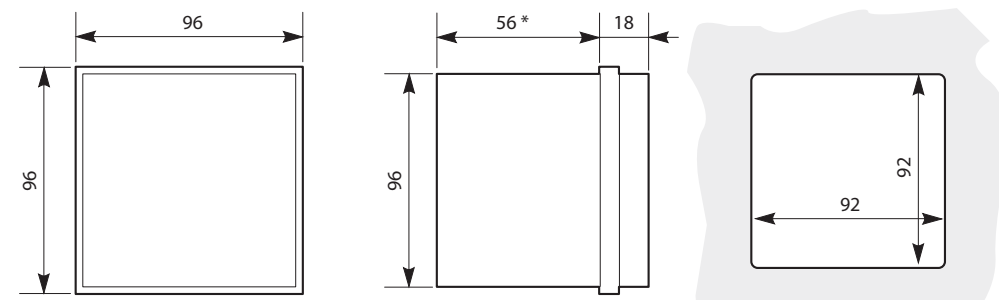

* 86 for ELR96PD

Dimensions in mm

Quick product references

Overall dimensions

Toroidal transformers

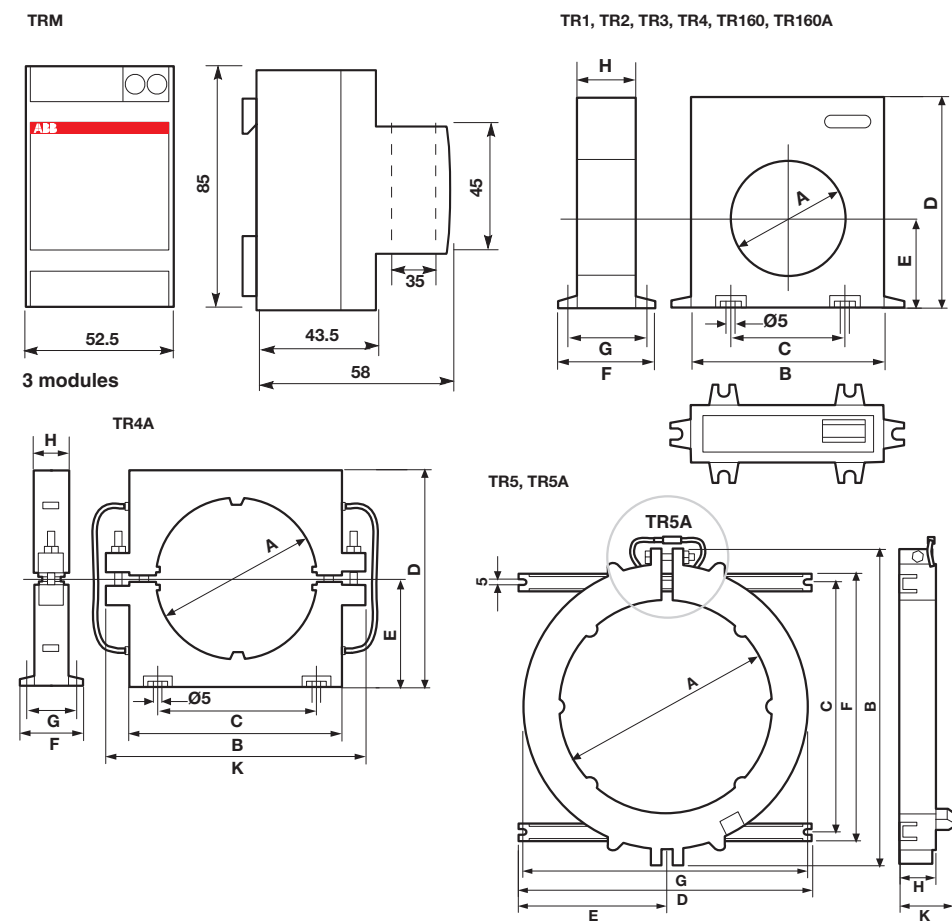

Type	Dimensions (mm)									
	A	B	C	D	E	F	G	H	K	
TR1	35	100	60	110	47	50	43	30	-	
TR2	60	100	60	110	47	50	43	30	-	
TR3	80	150	110	160	70	50	43	30	-	
TR4	110	150	110	160	70	50	43	30	-	
TR4A	110	145	110	150	75	45	38	25	180	
TR160	160	220	156	236	110	64	50	34	-	
TR160A	160	220	156	236	110	64	50	34	-	
TR5	210	310	240	290	145	260	280	36	55	
TR5A	210	310	240	290	145	260	280	36	55	

Bottom-fitting auxiliary contact (with S 200 MCB)

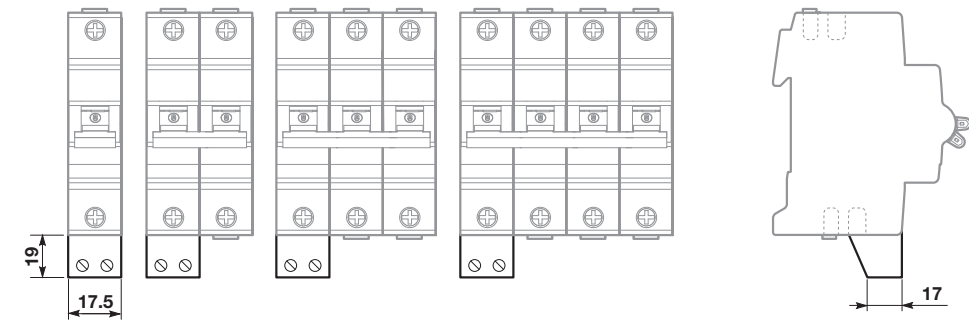

S 2C-EST

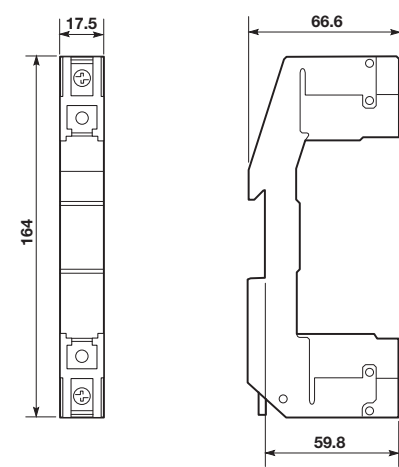

S 2C-CM

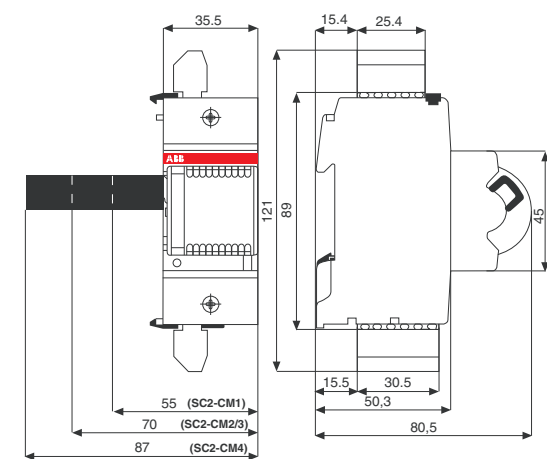

Quick product references

Overall dimensions

F2C-ARI, F2C-CM

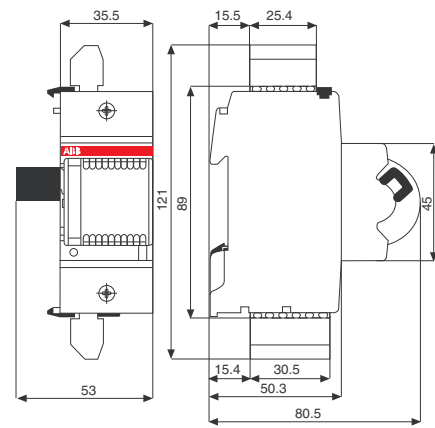

F2C-ARH, F2C-ARH-T

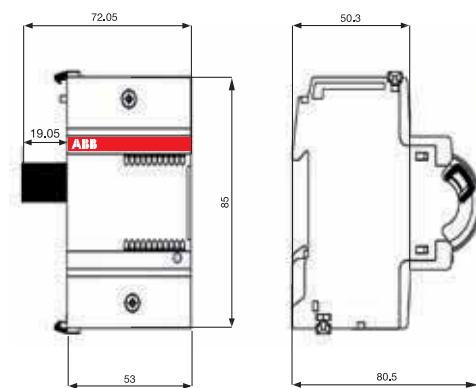

Auxiliary elements for SN 201 series

SN201-S

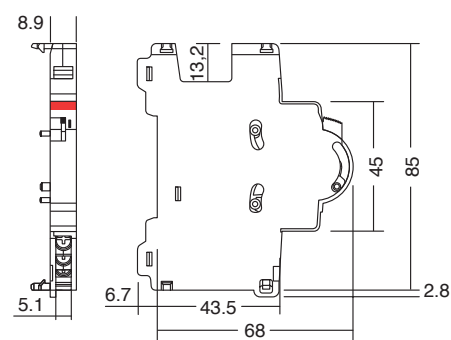

SN201-IH

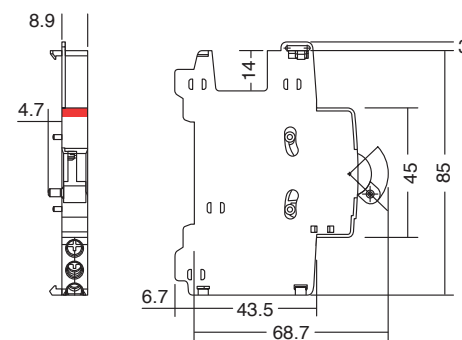

S800-AUX, S800-AUX/ALT

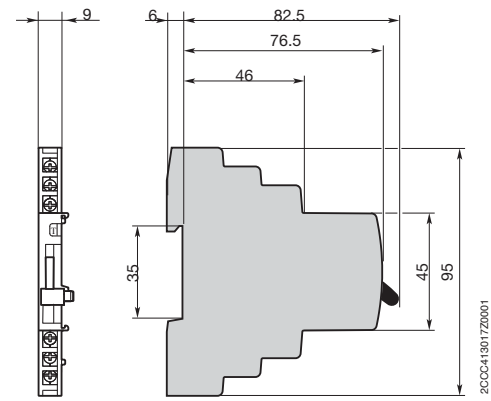

S800-RSU-H, S500-RSU-H

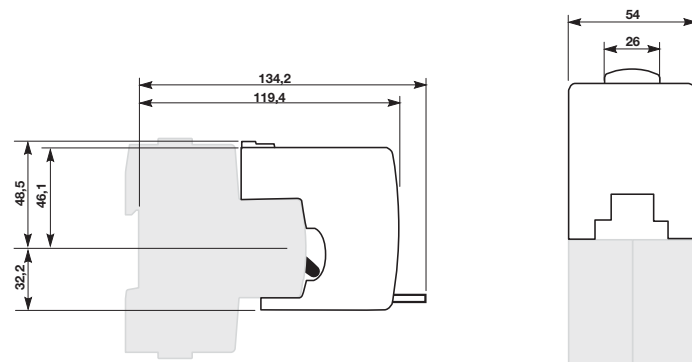

Quick product references

Overall dimensions

S800-RD+S800-RHE, S800-NT, S800-BB250, S800-BBPC120

S800-RD+S800-RHE

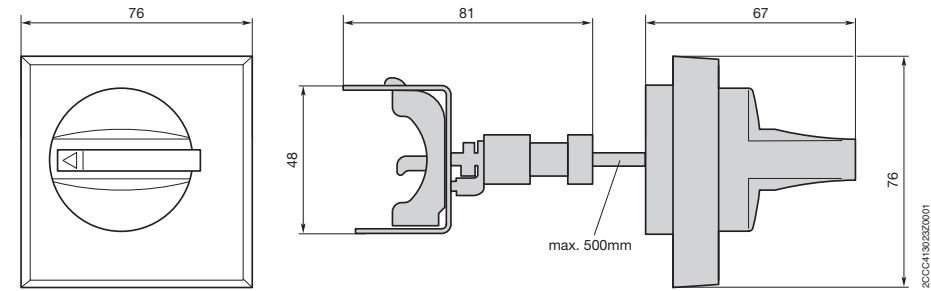

S800-BB250

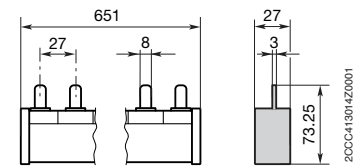

S800-NT

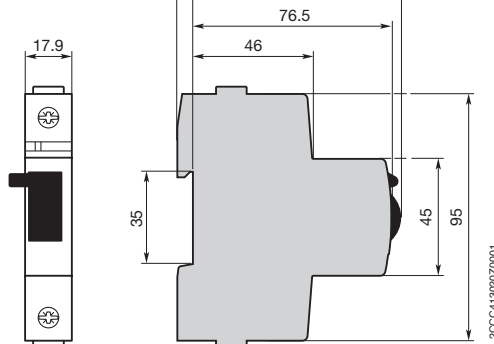

S800-BBPC120

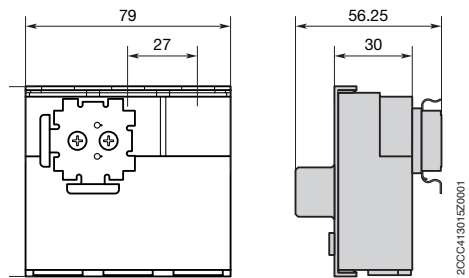

Terminal covers

PCD 2 N

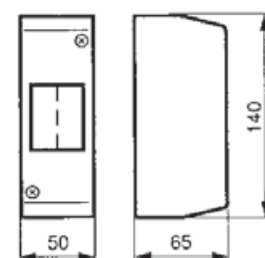

PCD 4 N

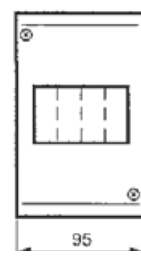

PCD 6 N

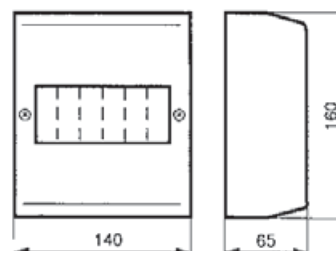

PCD 8 N

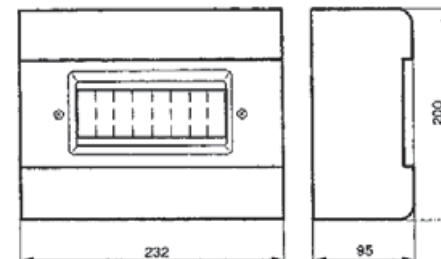

Enclosures of moulded-plastic

N + PE common terminals for QES

SMO 4

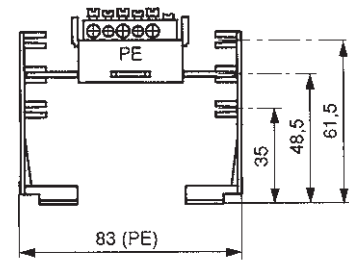

SMO 6

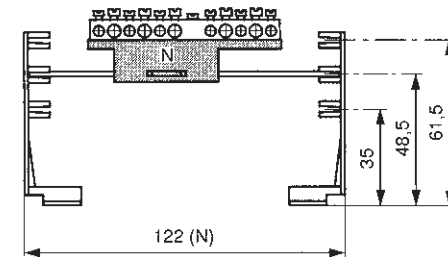
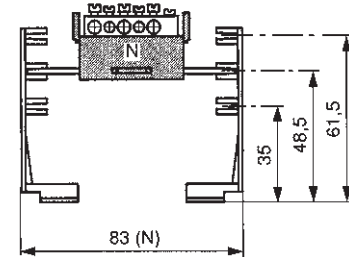
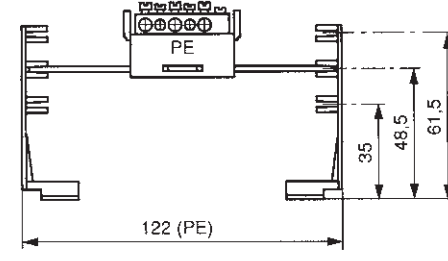

SMO 10

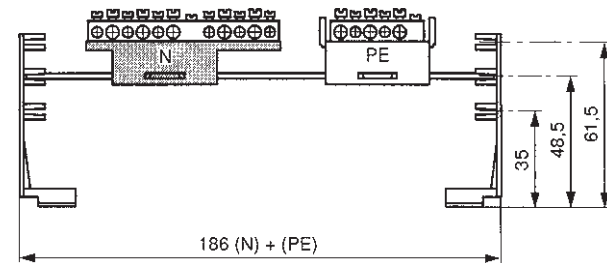

QES 10/3 N

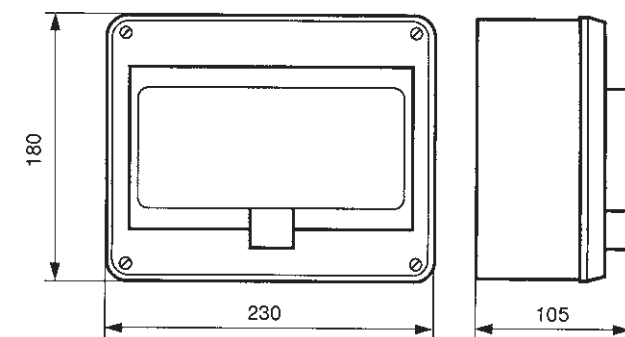

Quick product references

Overall dimensions

Flush frame

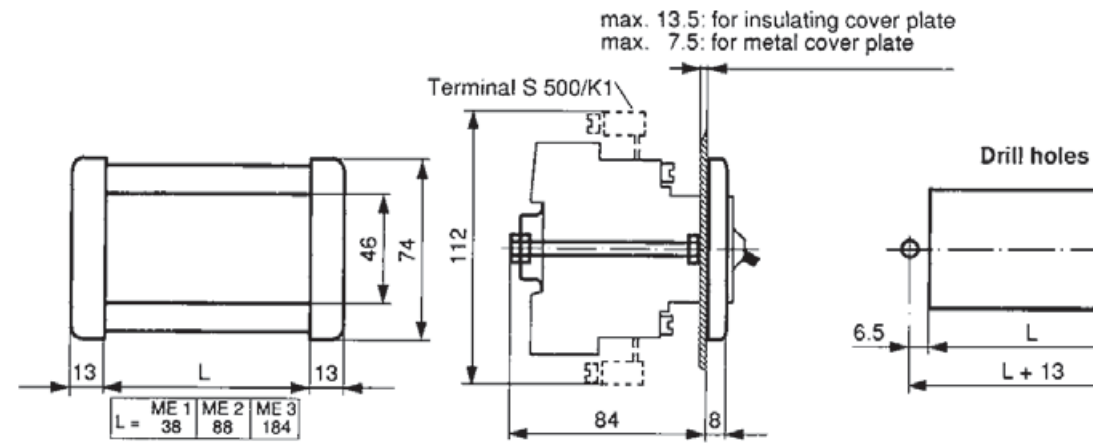

Type	Dim. L	Max. No. of modules (1 module=17.5 mm)
S 500 - ME 1	38 mm	for 2 module
S 500 - ME 2	88 mm	for 5 module
S 500 - ME 3	184 mm	for 10 module

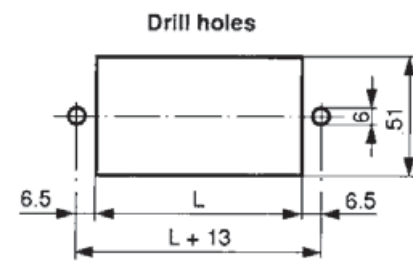

① In the case of DSW 1, the drill holes are vertical

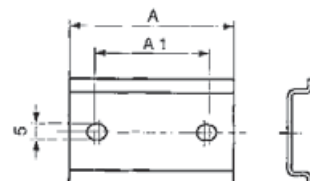

Name	A	A1
DSW	17.5	15
DSW 2	35	20
DSW 3	52.5	37.5
DSW 4	70	55
DSW 6	105	90

Busbars

PS 1/2

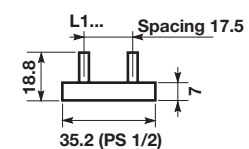

PS 1/6

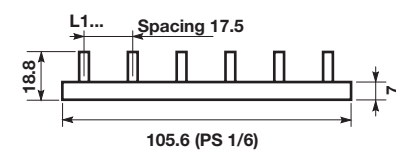

PS 1/9

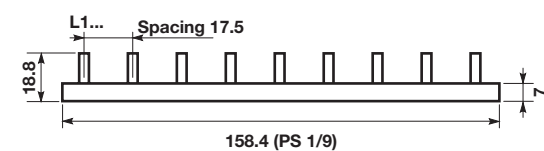

PS 1/12

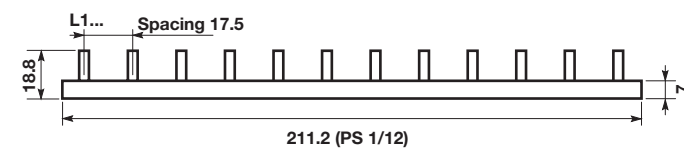

11

PS 3/60

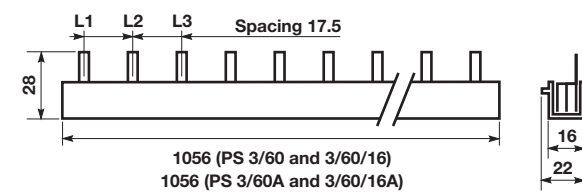

Auxiliary contact bridge HKB

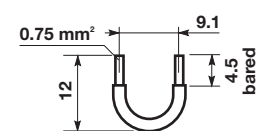

Quick product references

Overall dimensions

PS 3/6

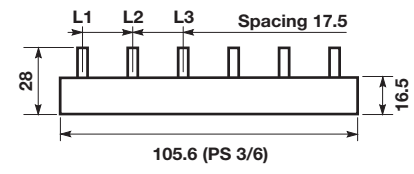

PS 3/9

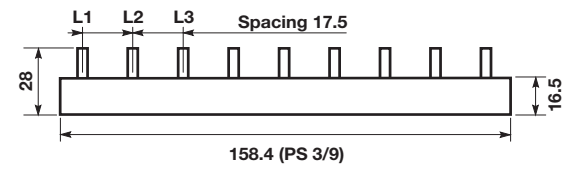

PS 3/12 (2CDL 230 001 R1012)

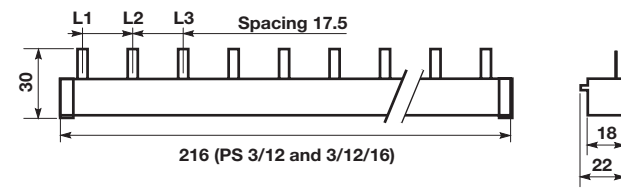

PS 3/12 FI (2CDL 230 002 R1012)

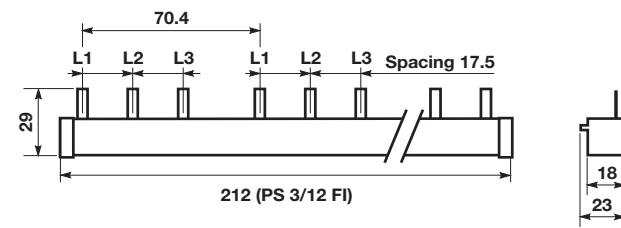

PS 2/12

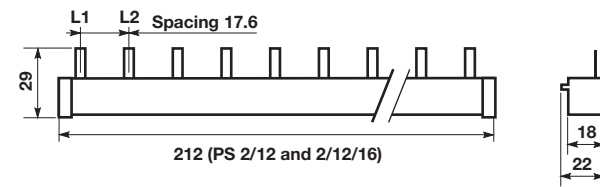

PS 2/58

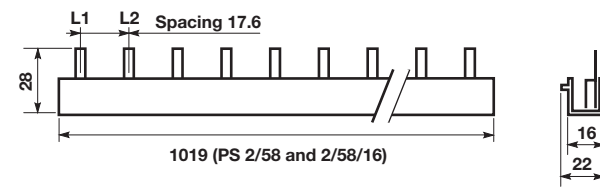

PS 2/48

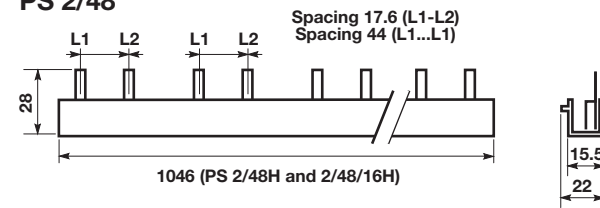

PS 3/39H

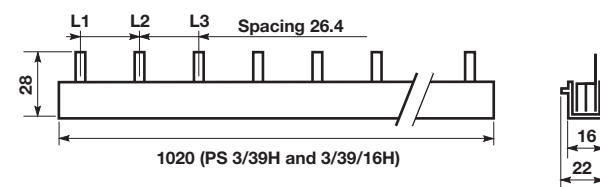

PS 3/48H

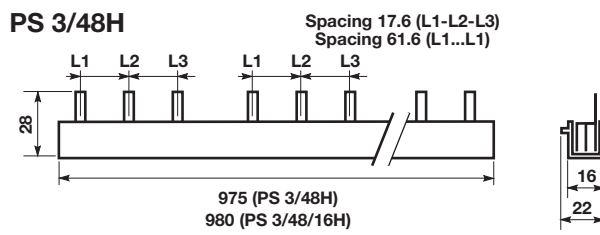

Quick product references

Overall dimensions

PS 3/12 FI H

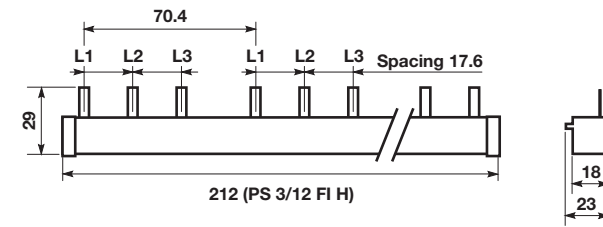

PS 4/12

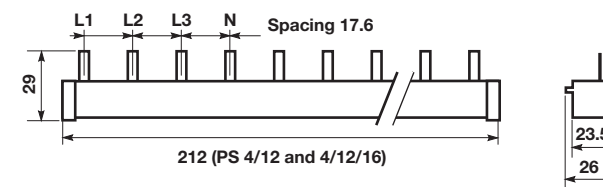

PS 4/60

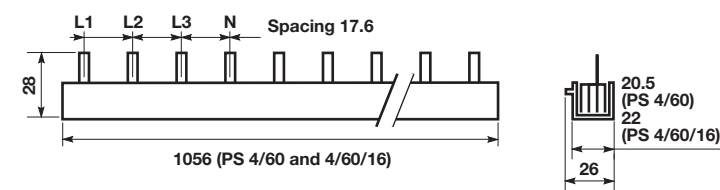

PS 4/58 N

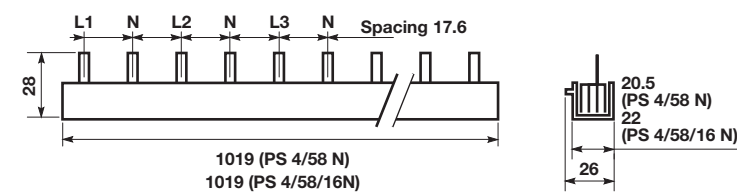

PS 3/12 E 463

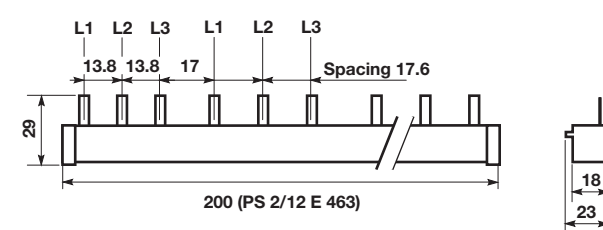

ME flange for rear board mounting

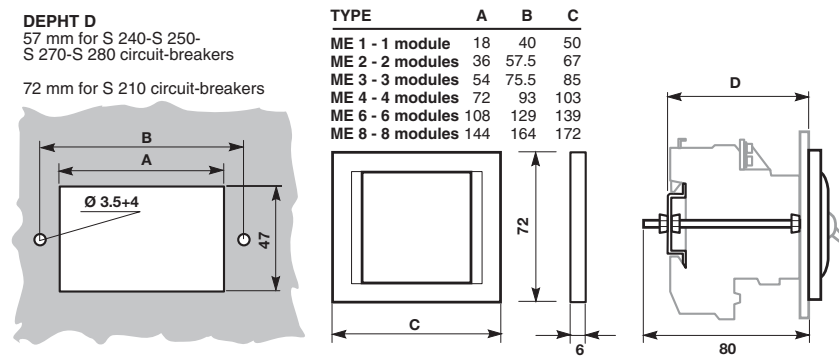

OH_2A_

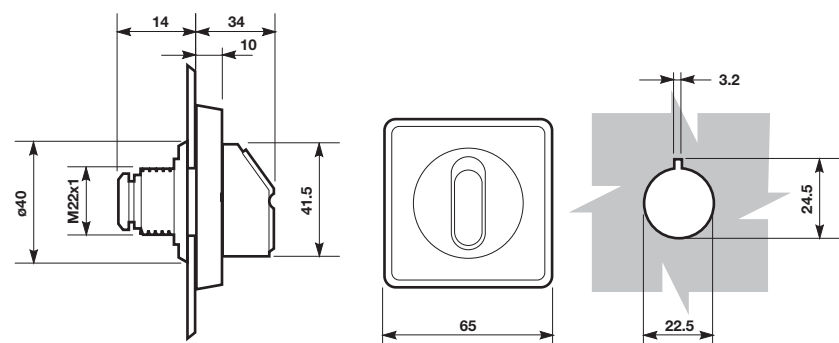

QSD remote signalling panels

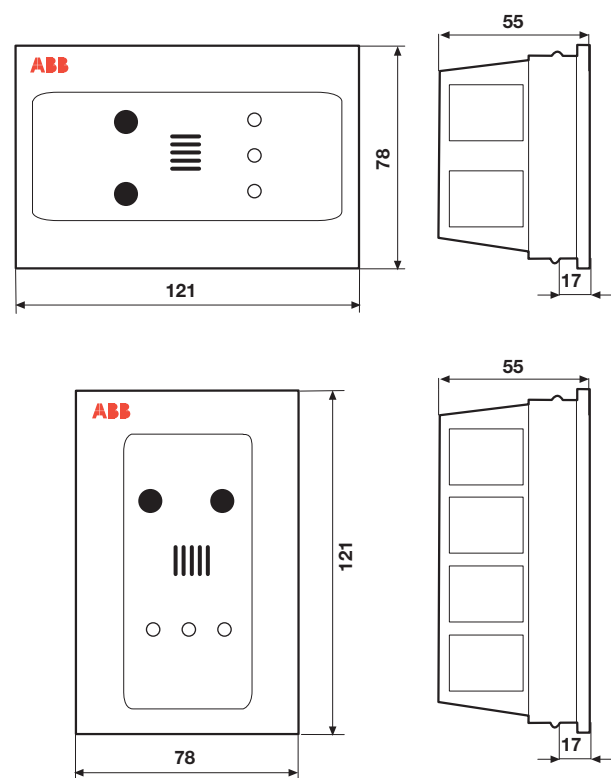

Quick product references

Overall dimensions

QSO electrical switchboard for medical locations

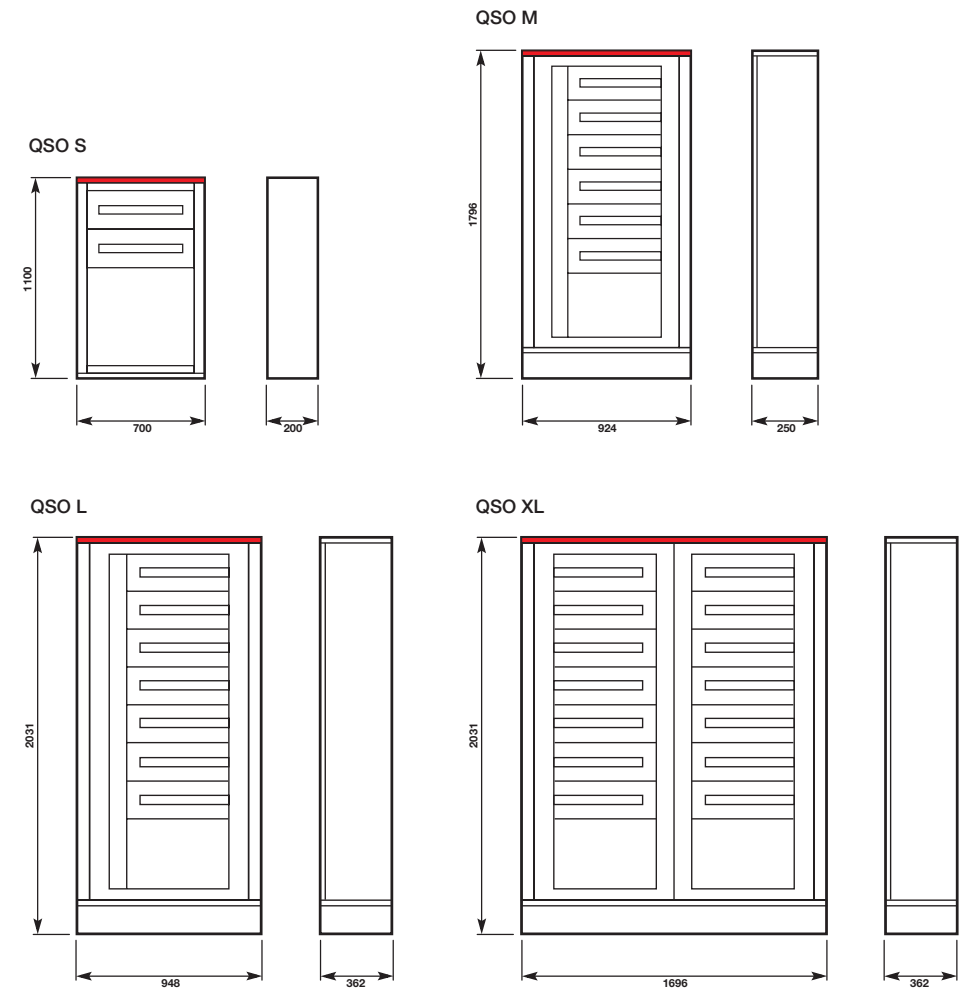

PM554

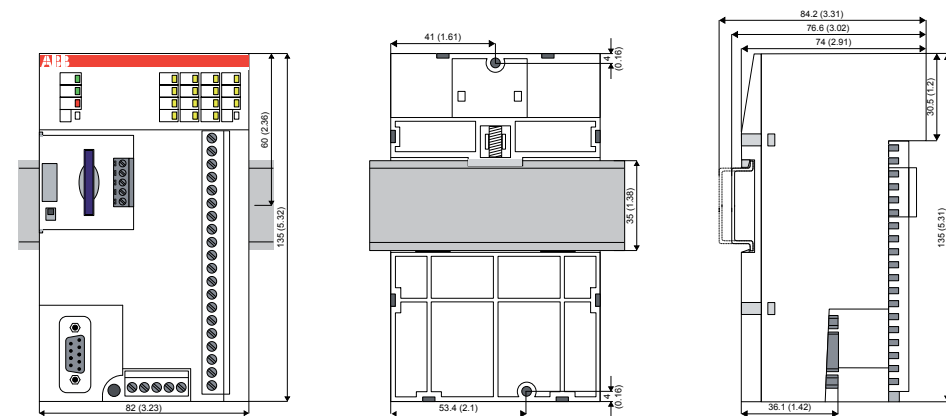

CP415

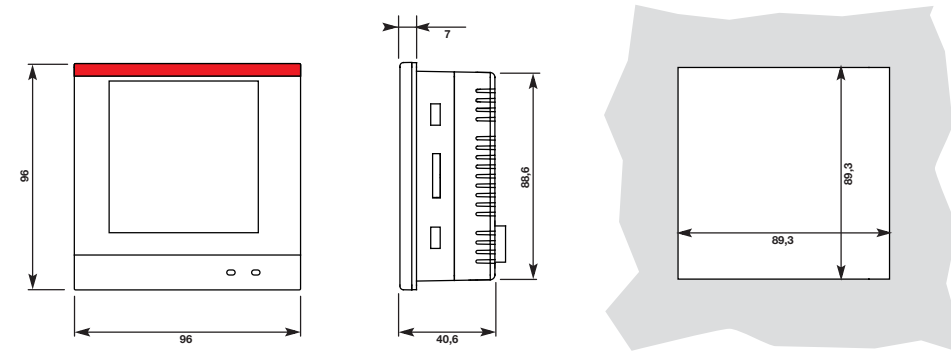

QIT

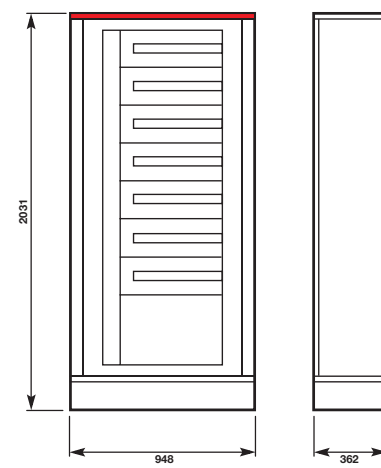

11

TI insulating transformers

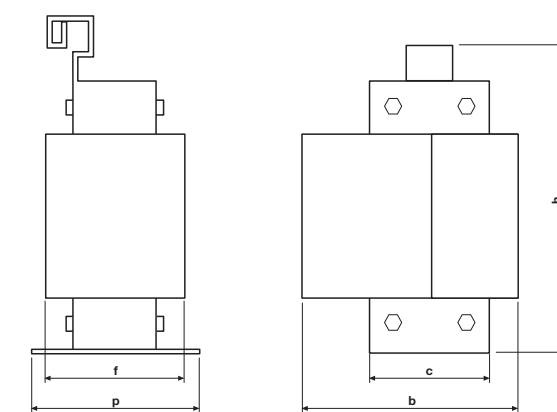

Dimensions	Rated output [KVA]			
	3	5	7,5	10
b [mm]	205	240	240	277
c [mm]	170	170	170	176
f [mm]	115	115	115	173
h [mm]	340	380	380	380
p [mm]	150	150	160	203
Weight [kg]	29,5	44	50,5	73

Quick product references

Overall dimensions

FLR pulse relays

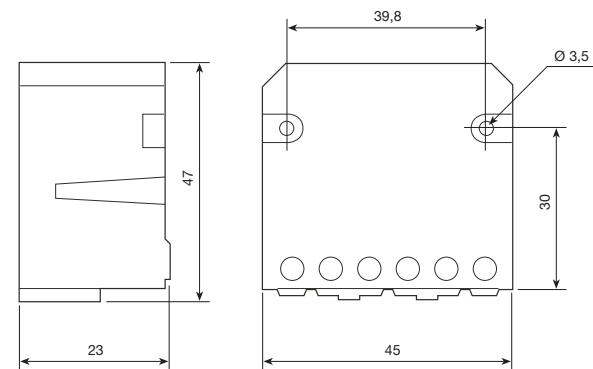

STD dimmers

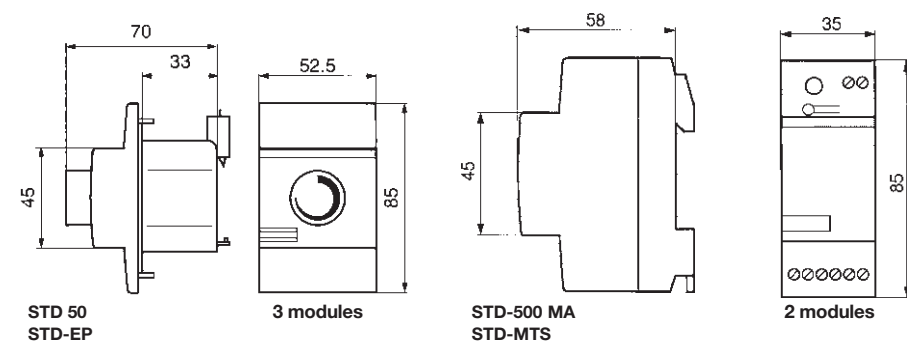

AT electro-mechanical time switches

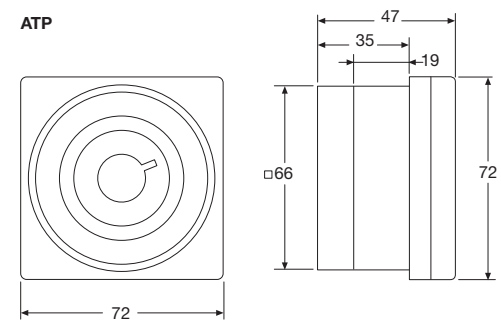

D Line digital time switches

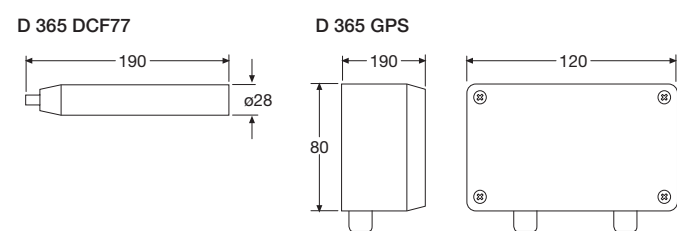

Quick product references

Overall dimensions

T1 POLE

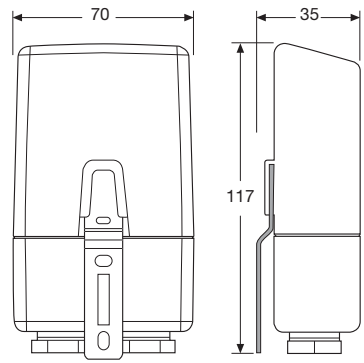

LS-D

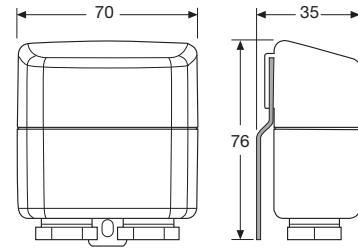

CL logic relays

CL-LDD

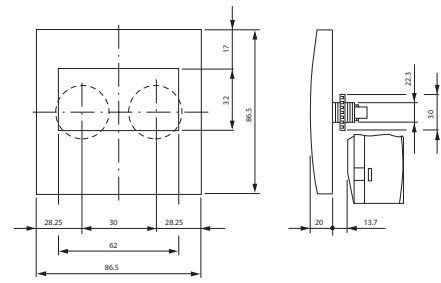

CL-LDD.K + CL-LDC.L.. + (CL-LDR or CL-LDT)

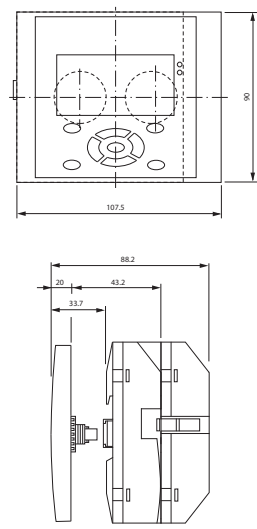

CL-LDR, CL-LDT

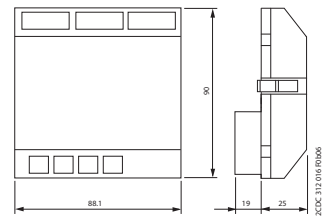

CL-LDC.S..

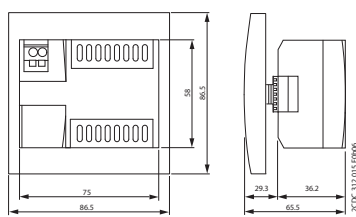

Quick product references

Overall dimensions

LEE 230 power failure signalling lamp

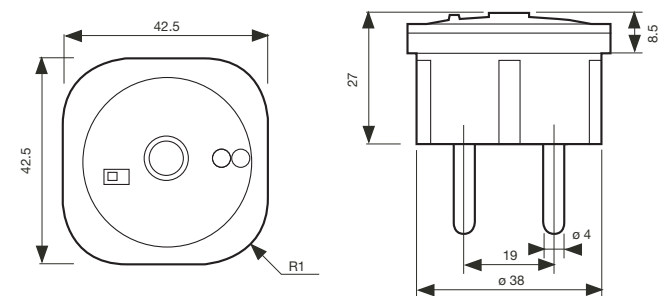

MCV - MCA voltmetric and ammetric switches

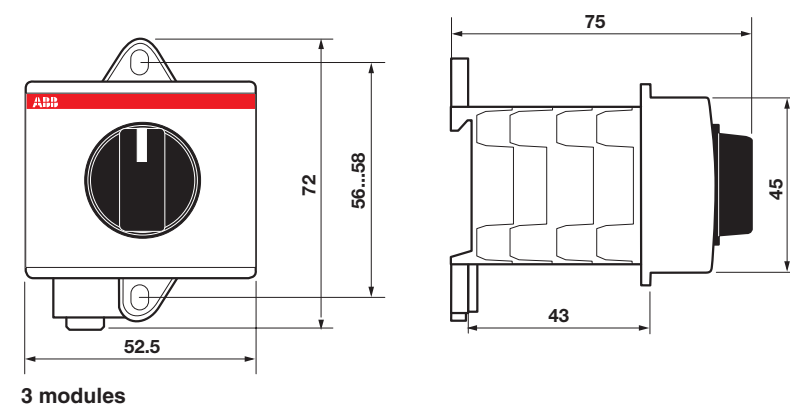

QCV - QCA front panel voltmetric and ammetric switches

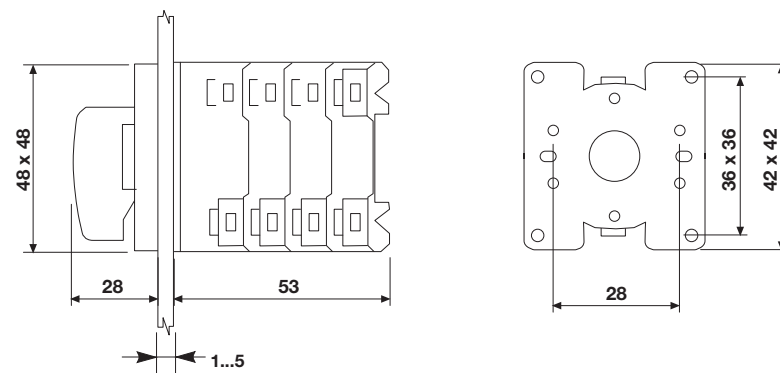

Modular current transformers with through primary

TRF M

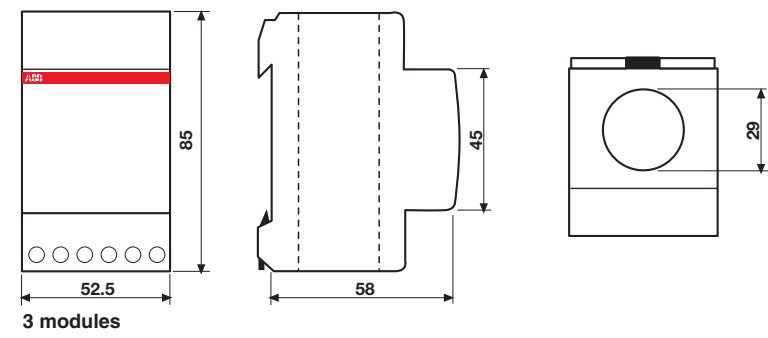

Standard type current transformers.../5 A with wound primary

CTA

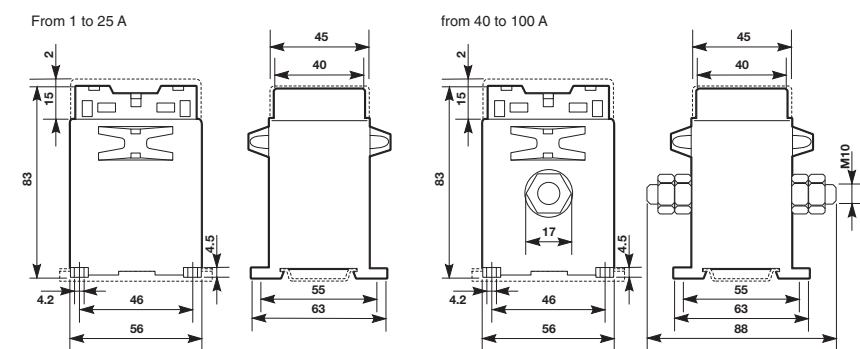

Quick product references

Overall dimensions

Standard type current transformers...5 A with through primary

CT PRO XT

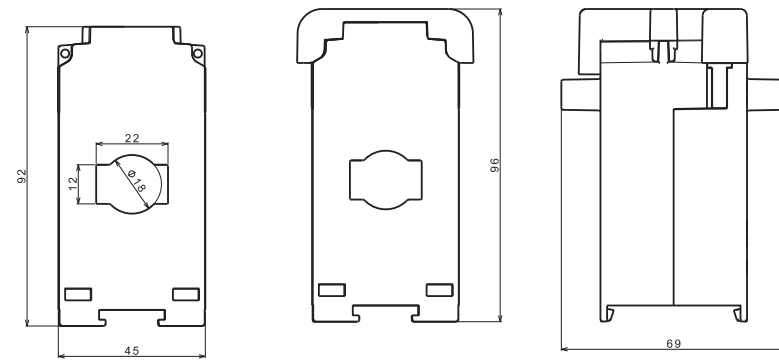

CT MAX

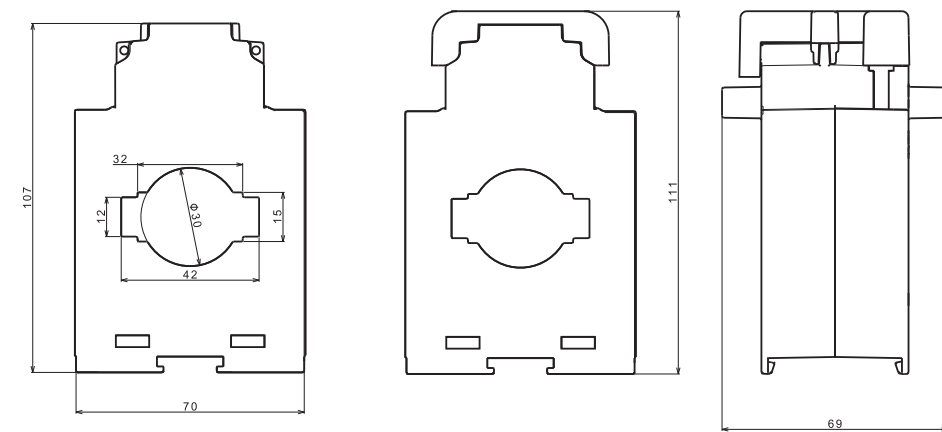

CTO

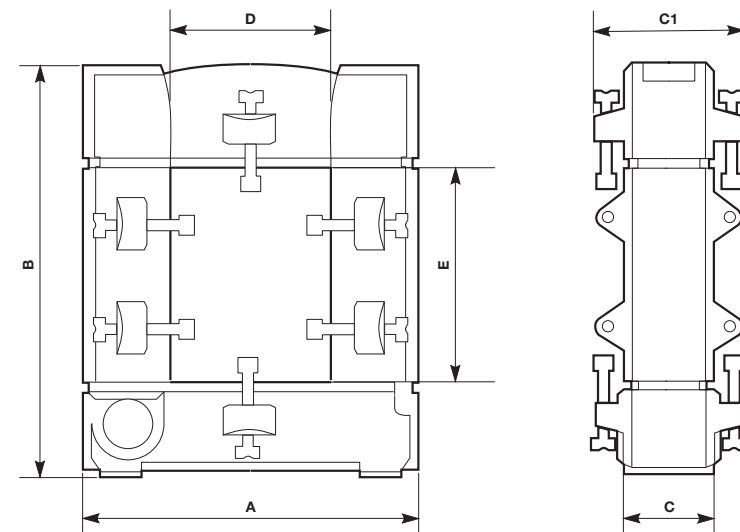

Tipo	A	B	C	C1	D	E
CT30...	93	106	34	58	20	30
CT80...	125	152	34	58	50	80
CT120...	155	198	34	58	80	120

Voltage transformers

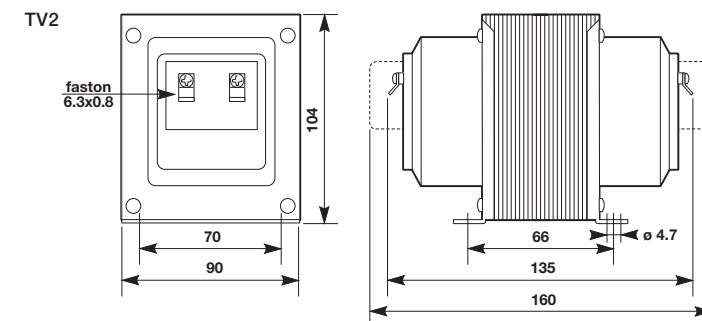

Quick product references

Overall dimensions

Shunts

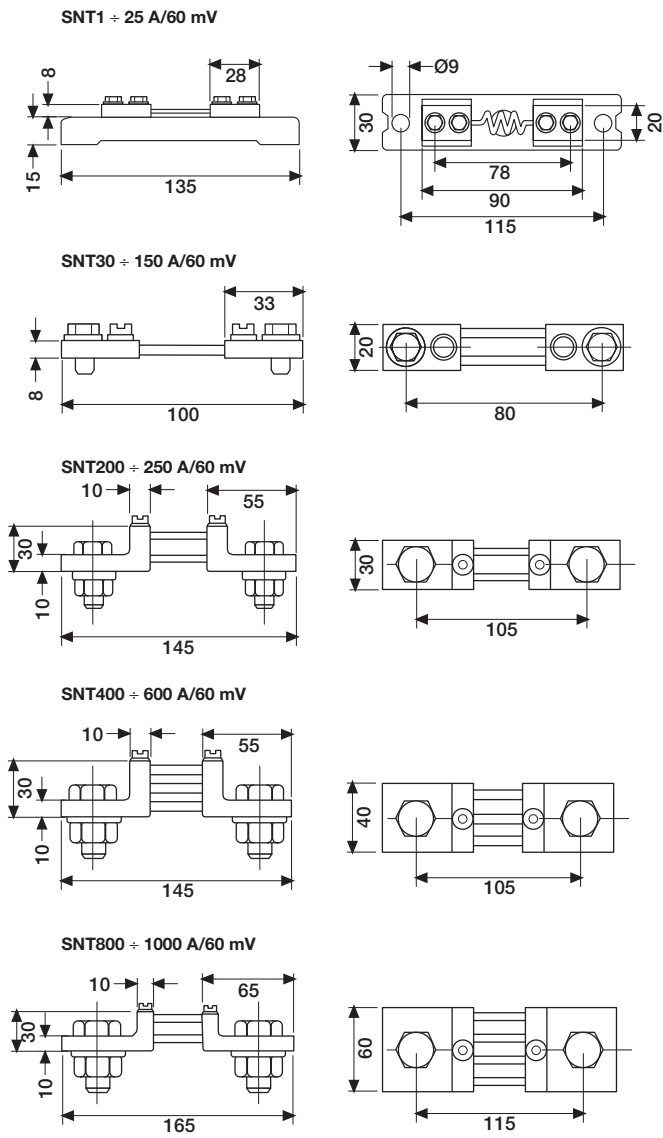

TM-C, TM-S, TM-I

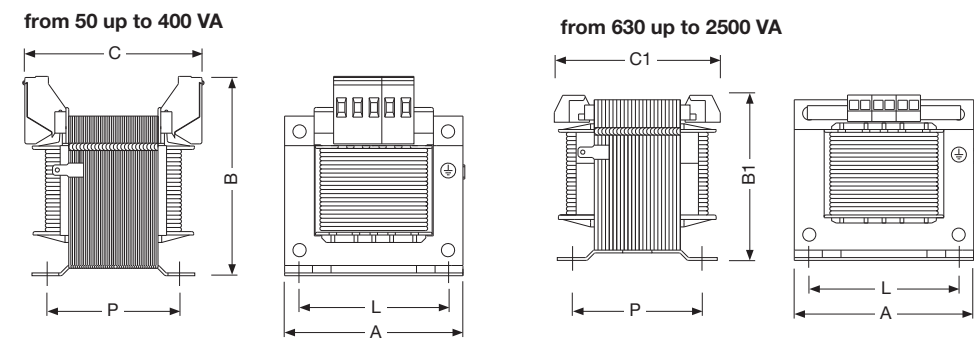

TM-C control transformers

Power (VA)	Picture	Dimensions						Screw	Weight (Kg)	
		A	B	B1	C	C1	P	L		
50	1	76	89	-	69	-	46	56	M4	1.1
100	1	85	95	-	87	-	63	64	M4	2
160	1	97	106	-	89	-	73	84	M5	3
200	1	97	106	-	89	-	73	84	M5	3.2
250	1	97	106	-	105	-	89	84	M5	3.6
320	1	121	122	-	91	-	73	90	M5	4.4
400	1	121	122	-	104	-	85	90	M5	5.5
630	2	151	-	150	-	122	90	122	M6	7.8
1000	2	151	-	150	-	166	133	122	M6	13.2
1600	2	193	-	184	-	163	125	155	M8	21.2
2000	2	193	-	184	-	181	143	155	M8	25.5
2500	2	193	-	184	-	191	153	155	M8	26.8

TM-S safety transformers and TM-I isolating transformers

50	1	76	89	-	69	-	46	56	M4	1.1
100	1	85	95	-	87	-	63	64	M4	2
160	1	97	106	-	89	-	73	84	M5	3
200	1	97	106	-	89	-	73	84	M5	3.2
250	1	97	106	-	105	-	89	84	M5	3.6
320	1	121	122	-	91	-	73	90	M5	4.4
400	1	121	122	-	104	-	85	90	M5	5.5
630	2	151	-	150	-	122	90	122	M6	7.8
1000	2	151	-	150	-	166	133	122	M6	13.2
1600	2	193	-	184	-	163	125	155	M8	21.2
2000	2	193	-	184	-	181	143	155	M8	25.5
2500	2	193	-	184	-	191	153	155	M8	26.8

MA1-8001 DIN rail adapter

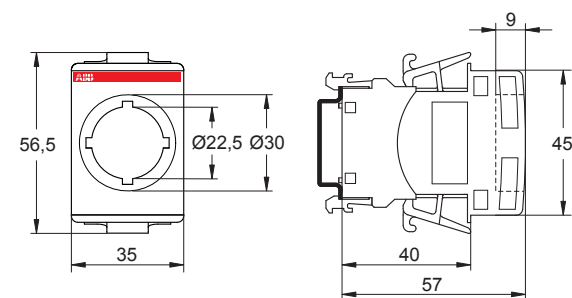









Quick product references

MCBs and RCDs worldwide marks and approvals







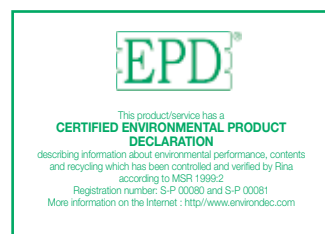

This is the present situation regarding worldwide marks and approvals for ABB System pro M compact range devices.

Although some products already obtained some approvals or certificates, they don't necessarily bear the related marks on the product.

	 AENOR - Spain 	 STB - Belarus 	 BBJ - Poland 	 BSMI - Taiwan 
S 200	■ S 200		■ S 200	
S 200 M	■ S 200 M		■ S 200 M	
S 200 M UC				
S 200 P	■ S 200 P		■ S 200 P	
S 200 S				
S 200 U				
S 200 UP				
S 200 UDC				
S 200 PR				
SU 200 PR				
SN 201				
S 280 80 - 100 A				
S 700				
S 750 DR				
S 800				
S 500-K, S 500UC-K				
F 200	■ F 200	■ F 200		■ F 200 ③
DDA 200				
DS 200		■ DS 200		
DS201		■ DS201		
DS202C		■ DS202C		
DS 271				
DDA 800		■ DDA 800		
SN201-S, SN201-IH				

The F 200 range has obtained the EPD (Environmental Product Declaration), according to ISO 14040.



	 GOST - Russia 	 GOST - Ucraina 	 IMQ - Italy 	 IRAM - Argentina 
S 200	■ S 200		■ S 200	
S 200 M	■ S 200 M		■ S 200 M	
S 200 M UC				
S 200 P	■ S 200 P		■ S 200 P	
S 200 S			● S 200 S	
S 200 U				
S 200 UP				
S 200 UDC				
S 200 PR				
SU 200 PR				
SN 201			■ SN 201	
S 280 80 - 100 A	■ S 280 80 - 100 A		■ S 280 80 - 100 A	
S 750 DR	■ S 750 DR			
S 800	■ S 800			
F 200	■ F 200	■ F 200	■ F 200	■ F 200 ③
DDA 200	■ DDA 200	■ DDA 200	■ DDA 200	
DS 200	■ DS 200	■ DS 200	■ DS 200	
DS201	■ DS201	■ DS201	■ DS201	
DS202C	■ DS202C	■ DS202C	■ DS202C	
DS 271		■ DS 271		
DDA 800		■ DDA 800		
F2C..	■ F2C..			
S 290 accessories	■ S 290 accessories			

Legend:

- Approved
- Waiting for approval
- ① Supplementary protection
- ② Branch circuit protection
- ③ Available for F200 type for overseas markets
- ④ Only S 500-K range
- ⑤ Only DS202C M Type A and APR









The indicated approvals generally cover all available approvals worldwide. To verify the approval status in your country please contact your LSO.









						
CCC - China	CEBEC - Belgium	CERTIF - Portugal	CSA - Canada	DEMKO - Denmark	EZU - Czech Rep.	FIMKO - Finland
						
■ S 200 ■ S 200 M	■ S 200 ■ S 200 M	■ S 200 ■ S 200 M	■ S 200 M ①	■ S 200 ■ S 200 M	■ S 200 ■ S 200 M	■ S 200 ■ S 200 M
■ S 200 P	■ S 200 P	■ S 200 P	■ S 200 P (≤ 25 A) ①	■ S 200 P	■ S 200 P	■ S 200 P
■ S 200 U ■ S 200 UP			■ S 200 U ② ■ S 200 UP ② ■ S 200 UDC ② ■ S 200 PR ① ■ SU 200 PR ②			
■ SN 201 ■ S 280 80 - 100 A						
■ S 800 ■ S 500-K, S 500UC-K ■ F 200 ③	■ F 200	■ F 200				■ F 200
■ DS201	■ DS201					
■ SN201-S, SN201-IH						

						
KEMA - Netherland	LCIE - France	NEMKO - Norway	OVE - Austria	HDB/PSB - Singapore	SABS - South Africa	SEMKO - Sweden
						
■ S 200 ■ S 200 M	■ S 200 ■ S 200 M	■ S 200 ■ S 200 M	■ S 200 ■ S 200 M	■ S 200 ■ S 200 M	■ S 200 ■ S 200 M	■ S 200 ■ S 200 M
■ S 200 P ● S 200 S	■ S 200 P ■ S 200 S	■ S 200 P	■ S 200 P ■ S 200 S			■ S 200 P
■ SN 201	■ S 280 80 - 100 A					
■ F 200	■ F 200 ■ DDA 200 ■ DS 200	■ F 200	■ F 200	■ F 200 ③	■ F 200 ③	
■ DS201	■ DS202C		■ DS201			

Quick product references

MCBs and RCDs worldwide marks and approvals





				
	SEV - Switzerland	SIQ - Slovenia	SIRIM - Malaysia	RCM - Australia
				
S 200	■ S 200	■ S 200	■ S 200	■ S 200
S 200 M	■ S 200 M	■ S 200 M	■ S 200 M	■ S 200 M
S 200 M UC				
S 200 P	■ S 200 P	■ S 200 P		■ S 200 P
S 200 S	● S 200 S			
S 200 U				
S 200 UP				
S 200 UDC				
S 200 PR				
SU 200 PR				
SN 201				■ SN 201
S 280 80 - 100 A				■ S 280 80 - 100 A
S 700				
S 750 DR				
S 800	■ S 800			
S 500-K, S 500UC-K				
F 200	■ F 200		■ F 200 ③	■ F 200 ③
F 204 B				
DDA 200				
DS 200				
DS201	■ DS201			■ DS201
DS202C				■ DS202C
DS 271				■ DS 271
DDA 800				







	RIVER	MARINE	MARINE	MARINE
				
	RRR - Russia	ABS - USA	DNV - Norway	GL - Germany
				
S 200		■ S 200	■ S 200	■ S 200
S 200 M		■ S 200 M	■ S 200 M	■ S 200 M
S 200 MUC				
S 200 P			■ S 200 P	
S 200 S				
S 200 U				
S 200 UP				
S 200 UDC				
S 200 PR				
SU 200 PR				
SN 201				
S 280 80 - 100 A			■ S 280 80-100 A	
S 800			■ S 800	■ S 800
S 500-K, S 500UC-K			■ S 500-K ④	
F 200	■ F 200			
F 204 B				
DDA 200				
DS 200	■ DS 200			
DS201	■ DS201	■ DS201, DS201M		■ DS201, DS201M
DS202C	■ DS202C	■ DS202C M		■ DS202C M
DS 271				
DDA 800				

Legend:

- Approved
- Waiting for approval
- ① Supplementary protection
- ② Branch circuit protection
- ③ Available for F200 type for overseas markets
- ④ Only S 500-K range
- ⑤ Only DS202C M Type A and APR
- ⑥ not available for F200 left neutral



















The indicated approvals generally cover all available approvals worldwide. To verify the approval status in your country please contact your LSO.

	
UL - USA	VDE - Germany
	
<ul style="list-style-type: none"> ■ S 200 ① ■ S 200 M ① ■ S 200 P ① ■ S 200 U ② ■ S 200 UP ② ■ S 200 UDC ② ■ S 200 PR ① ■ SU 200 PR ② ■ S 800 ■ S 500-K, S 500UC-K ■ F 200 ⑥ 	<ul style="list-style-type: none"> ■ S 200 ■ S 200 M ■ S 200 M UC ■ S 200 P ■ S 200 S ■ S 200 PR ■ SU 200 PR ■ S 700 ■ S 750 DR ■ F 200 ■ F 204 B ■ DS 200 ■ DS201 ■ DS202C

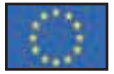









		
LRS - Great Britain	RINA - Italy	RMRS - Russia
		
<ul style="list-style-type: none"> ■ S 200 ■ S 200 M ■ S 200 P ■ S 800 	<ul style="list-style-type: none"> ■ S 200 ■ S 200 M ■ S 200 P ■ S 800 ■ DS202C ⑤ 	<ul style="list-style-type: none"> ■ S 200 ■ S 200 M ■ S 200 P ■ S 800 ■ S 500-K ④











Quick product references

MDRCs worldwide marks and approvals

										
	BSI UK	CCC China	CEBEC Belgium	ENEC Europe	GOST Russia	GOST Ukraine	IMQ Italy	KEMA Netherland	NF France	SEV Swiss
										
OVR					■ OVR T1 and T2					
RD					■ RD	■ RD				
TR-TRM					■ TR-TRM	■ TR-TRM				
E 90		■ E90, E90h ③ E90 PV ④			■ E90, E90h, E90 PV, E90 CC	■ E90, E90h, E90 PV, E90 CC	■ E90, E90h ③		■ E90 ⑤, E90h ⑥	
E 930					■ E 930	■ E 930				
E 200		■ E 200						■ E 200		
SD 200		● SD 200			● SD 200			● SD 200		
SHD 200		● SHD 200			● SHD 200			● SHD 200		
E210		■ E210 ②			■ E210					
ESB		■ ESB								
EN		■ EN								
E 259					■ E 259	■ E 259				
E 250					■ E 250	■ E 250				
E 260					■ E 260	■ E 260				
E 234		■ E 234			■ E 234					
AT					■ AT	■ AT				
D Line					● D					
E 232					■ E 232					
T line					■ T line	■ T line				
THS					■ THS					
RAL					■ RAL	■ RAL				
LSS1/2					■ LSS1/2	■ LSS1/2				
RH/RL					■ RH/RL	■ RH/RL				
SQZ3					■ SQZ3	■ SQZ3				
LEE 230					■ LEE 230	■ LEE 230				
CT / CTA / TRFM					■ CT/CTA/ TRFM	■ CT/CTA/ TRFM				
MCA/MCV					■ MCA/MCV					
HMT					■ HMT					
TM					■ TM		■ TM ⑦			
TS					■ TS					
TS-C				■ TS-C	■ TS-C					
TSM/TSR					■ TSM/TSR	■ TSM/TSR				
SM/RM					■ SM/RM	■ SM/RM				
M1170					■ M1170					
M1173					■ M1173	■ M1173	■ M1173			
M1174			■ M1174		■ M1174	■ M1174			■ M1174	
M1175					■ M1175	■ M1175				
M1176										
M1363	■ M1363									
M1011										■ M1011
M2071										
M1011										
TM-C, TM-I, TM-S				■ TM-C, TM-I, TM-S	■ TM-C, TM-I, TM-S					

- Legend:**
- Approved whole range
 - Waiting for approval
 - ① Except for ESB/EN 20
 - ② For series E219 CCC mark not needed
 - ③ Just no LED versions
 - ④ Dedicated range for chinese market
 - ⑤ Version without neutral
 - ⑥ Dedicated rang with neutral on left
 - ⑦ IMQ available for TM up to 30 VA
 - ⑧ VDE available only on M1175 (standard grey version) and M1175-C (with cover)

				
UL/CSA USA/Canada	UL/CSA USA/Canada	VDE Germany	RCM Australia	IRAM Argentina
				
	● OVR T2	■ OVR T2 40 275		
■ E90	■ E90, E90 PV, E90 CC ■ E 930			
	■ E210 ■ ESB ■ EN	■ E 200 ■ SD 200 ■ SHD 200 ■ E210		
	■ E 234			
		■ E 232		
		■ TS		
		■ M1175 ⊕	● M1176	
				● M2071
	■ TM-C, TM-I, TM-S			

				
BV/F France	GL/D Germany	LRS Great Britain	RINA Italy	RMRS Russia
				
■ E90, E90h, E90 PV		● E90, E90h ⊕	■ E90, E90h ⊕	
■ ESB ⊕ ■ EN ⊕	■ ESB ⊕ ■ EN ⊕			
	■ E 260			

Quick product references

Alphabetical index

Type	Description	Chapter	Page
A	A-series	EQ meters	8 8/18
	ANR	network analyser	8 8/9
	AT	electro-mechanical time switches	7 7/8
	AT2	electro-mechanical time switches	7 7/9
	ATP el	electro-mechanical time switches	7 7/10
	ATT	GSM modules	7 7/27
	Auxiliary elements and accessories	Auxiliary elements and accessories	4 4/8
B	B-series	EQ meters	8 8/28
	Busbars for MCBs and RCDs	Auxiliary elements and accessories	4 4/24
C	C-series	EQ meters	8 8/36
	CL	logic relays, display system	7 7/29
	CMS	Current Measurement System	8 8/82
	CP-D	CP-D primary switch mode power supplies	6 6/70
	CT	measurement current transformers with through primary	8 8/72
	CTA	measurement current transformers with wound primary	8 8/77
	CTO	split core measurement current transformers	8 8/78
	CUS	serial converter	8 8/14

Type	Description	Chapter	Page
D	D Line	digital time switches	7 7/6
	D0	Fuse carrier	5 5/67
	DDA 200	RCD-blocks	3 3/24
	DDA 200 AE	RCD-blocks	3 3/30
	for emergency stop		
	DDA 200	RCD-blocks	3 3/29
	AP-R		
	DDA 200 B	RCD-blocks	3 3/32
	APR		
	DDA 200	RCD-blocks	3 3/31
	selective		
	DDA 200 special version	RCD-blocks	3 3/28
	110 V and 400 V		
	DDA 800	RCD-blocks	3 3/78
	DMTME	multimeters	8 8/12
	DS 200	RCBOs	3 3/66
	DS 200 M	RCBOs	3 3/71
	DS 271	RCBOs	3 3/92
	DS201	RCBOs	3 3/41
	DS201 L	RCBOs	3 3/38
	DS201 M	RCBOs	3 3/48
	DS202C	RCBOs	3 3/56
	DS202C M	RCBOs	3 3/58
	DS800S, DS800N	RCBOs	3 3/84

	Type	Description	Chapter	Page
E	E 200	switches	6	6/13
	E 210	switches, pushbuttons and indicator lights	6	6/22
	E 232	staircase lighting time-delay switches	7	7/12
	E 233	hour counters	8	8/65
	E 234	electronic timers	7	7/16
	E 235	mains disconnection relays	7	7/38
	E 236	undervoltage monitoring relays	5	5/75
	E 250	latching relays	6	6/45
	E 259	installation relays	6	6/41
	E 260	latching relays	6	6/54
	E 450	priority switches	7	7/35
	E 463/3, E 480/3	switches	6	6/16
	E 90	fuse switch disconnectors	5	5/50
	E 90 class CC	class CC fuseholders	5	5/54
	E 90 PV	fuse disconnectors	5	5/53
	E 90h	fuseholders	5	5/52
	E 930	fuse disconnectors	5	5/55
E 9F aM	Cylindrical fuses	5	5/61	
E 9F gG	Cylindrical fuses	5	5/57	
E 9F gPV	Cylindrical Fuses	5	5/65	
ELR	Front panel residual current relays	3	3/97	
EN	contactors	6	6/36	
ESB	installation contactors	6	6/33	
ESB/EN	installation contactors main accessories	6	6/38	
F	F 200	RCCBs	3	3/8
	F 200 AP-R	RCCBs	3	3/15
	(high immunity)			
	F 200 B type	RCCBs	3	3/19
	F 200 for high frequency and rail ways applications	RCCBs	3	3/17
	frequency and rail ways applications			
	F 200 for overseas markets	RCCBs	3	3/10
	overseas markets			
	F 200 left neutral	RCCBs	3	3/11
	neutral			
	F 200 PV	RCCBs	3	3/21
	F400	RCCBs	9	9/17
	F400 K and S	RCCBs	9	9/19
	FLR	latching relays	6	6/52
	FS401	RCBOs	9	9/21
	FS401 K	RCBOs	9	9/23
	FS403	RCBOs	9	9/24
G	G-series	EQ meters	8	8/40

	Type	Description	Chapter	Page
H	HMT	hour counters	8	8/66
I	ISL	industrial insulation monitoring devices	5	5/93
	ISOLTESTER	operating theatre monitoring	5	5/91
	MRM			
L	ISOLTESTER-DIG	insulation monitoring devices	5	5/82
	LEE 230	extractable power failure signalling lamp	7	7/39
M	LSS1/2	load shedding switch	7	7/37
	M2M	network analyser	8	8/5
O	MA1-8001	MA1-8001 DIN rail adapter	6	6/78
	DIN rail adapter			
	MeMo	USB Modular DIN rail device	7	7/40
	Modular sockets	Modular sockets	6	6/74
Q	operating and autoreclosing devices			
	Motor	Auxiliary elements and accessories	4	4/19
	OVR Plus	Surge protective devices	5	
	OVR PV	Surge protective devices	5	5/44
	OVR TC	Surge protective devices	5	5/46
	OVR Type 1	Surge protective devices	5	5/8
	OVR Type 1+2	Surge protective devices	5	5/22
	OVR Type 2	Surge protective devices	5	5/24
	OVR Type 3	Surge protective devices	5	5/40
	QIT	Switchboards for data center protection and supply	5	5/92
R	QSD	remote signalling panel	5	5/85
	QSO	switchboards and components for medical locations	5	5/88
R	RAL	overload relays	7	7/36
	RD2	Residual current relays	3	3/94
	RD3	Residual current relays	3	3/95
	RH/RL	maximum and minimum current/voltage relays	5	5/74

Quick product references

Alphabetical index

Type	Description	Chapter	Page
S	S 200 M series, 10 kA	2	2/38
	S 200 M UC series, 10 kA	2	2/50
	S 200 P series, 15/25 kA	2	2/59
	S 200 PR series, 10 kA	2	2/74
	S 200 S screwless series, 6 kA	2	2/77
	S 200 series, 6 kA	2	2/22
	S 200 U series, 10 kA	2	2/78
	S 200 UDC series, 60 V DC	2	2/95
	S 200 UP series, 10 kA	2	2/86
	S 280 series, 6 kA	2	2/107
	S 280 UC series, AC/DC	2	2/110
	S 400 E	9	9/4
	S 400 M	9	9/7
	S 400 M-UC	9	9/15
	S 700 + H2WR series	2	2/124
	S 700 series	2	2/120
	S 750 DR series	2	2/117
	S500 series	2	2/196
	S500UC series	2	2/199
	S800B series, 16 kA	2	2/173
	S800C series, 25 kA	2	2/165

Type	Description	Chapter	Page
	S800N series, 36 kA	2	2/159
	S800PV series, 5 kA, DC	2	2/187
	S800PV-M photovoltaic switch disconnectors	6	6/17
	S800S series, 50 kA	2	2/134
	S800U series, 50 kA	2	2/182
	SD 200 switch disconnectors	6	6/7
	SELVTESTER insulation monitoring devices for insulated networks at 24 V a.c/d.c.	5	
	SHD 200 switch disconnectors	6	6/10
	SL luminous indicators for panel installation	6	6/29
	SM, RM, TSM, TSR SM, RM, TSM, TSR bells and buzzers	6	6/67
	SN 2001 M series, 10 kA	2	2/105
	SN 201 L series, 4.5 kA	2	2/102
	SN 201 series, 6 kA	2	2/103
	SNT current transformer for d.c. applications	8	8/80
	SQZ3 phase and sequence relay	5	5/73
	STD50 dimmers	6	6/55
	SU 200 PR series, 10 kA	2	2/92
T	T line twilight switches	7	7/18
	THS modular thermostats	7	7/25
	TI switchboards and devices for medical locations	5	5/86
	TM TM bell transformers	6	6/65
	TM-C, TM-S, TM-I TM-C, TM-S, TM-I control, isolating and safety transformers	6	6/62
	TMD temperature control units	8	8/67
	TR toroidal transformers	3	3/98
	TRF M measurement modular current transformers	8	8/79
	TS TS bell transformers	6	6/66
	TS-C TS-C safety isolating transformers for general use	6	6/64
	TV voltage transformers	8	8/81
	TWA twilight switches	7	7/23
U	UNIFIX rapid wiring system Auxiliary elements and accessories	4	4/67
W	WT63 SMCBs	2	2/128

Contact us

ABB SACE a division of ABB S.p.A.
ABB STOTZ-KONTAKT GmbH

In consideration of modifications to Standards and materials, the characteristics and overall dimensions indicated in this catalogue may be considered binding only following confirmation by ABB

Copyright 2014 ABB. All rights reserved.

2CSC400002D0211 - 03/2014 - 8.000 P.z. - CAL

System pro M compact®

Catalogue | 2014

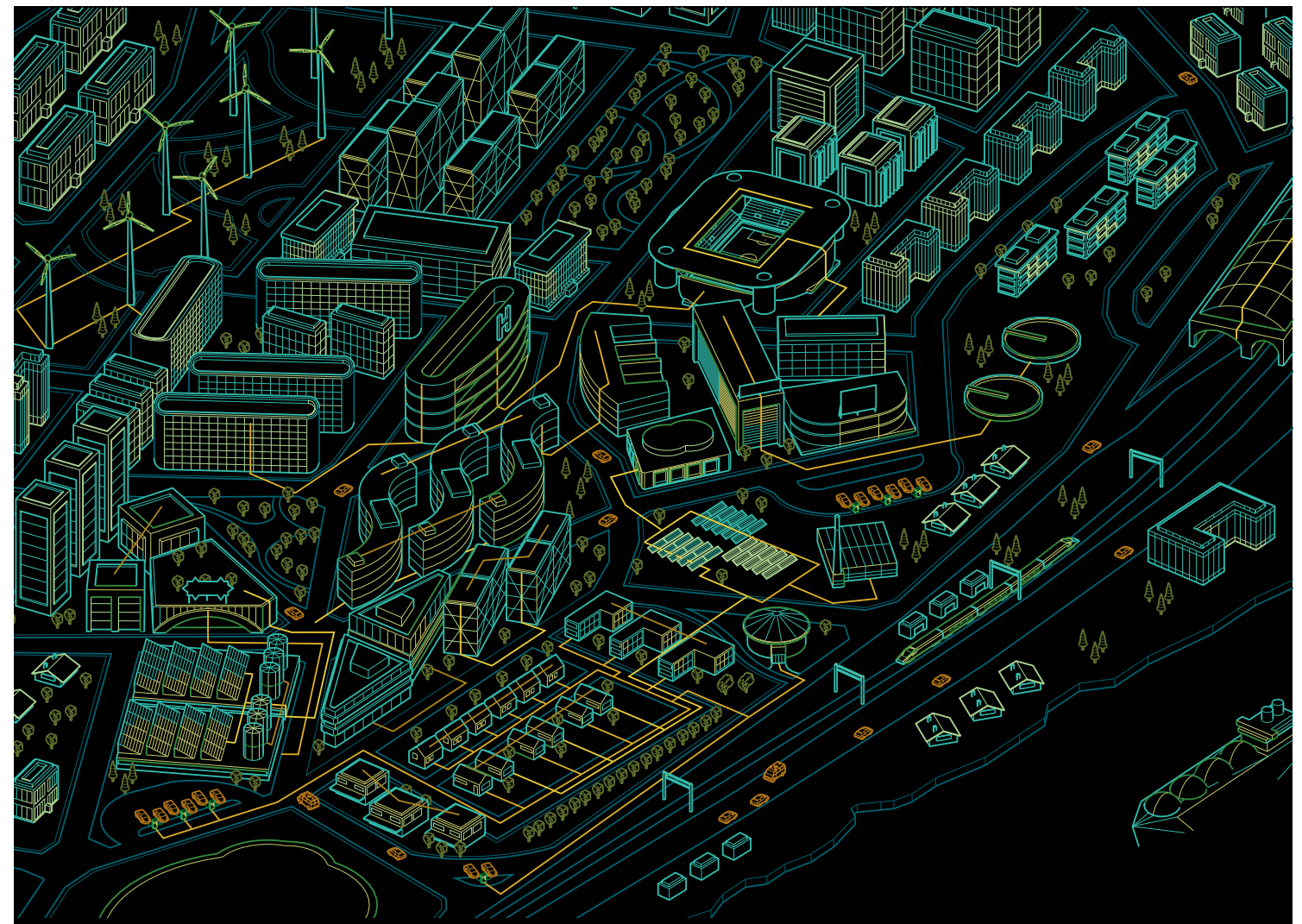

Catalogue - 2014

System pro M compact® DIN Rail components for low voltage installation

X-ON Electronics

Largest Supplier of Electrical and Electronic Components

Click to view similar products for [Mounting Fixings](#) category:

Click to view products by [ABB](#) manufacturer:

Other Similar products are found below :

[007310](#) [007541](#) [6-141-P](#) [620HA038NF09](#) [620HA038NF11](#) [71-074914-006](#) [71-146610-6H](#) [712HA170B23128-N](#) [75-69116-8S](#) [75-69211-3P](#)
[75-69224-28P](#) [75-69224-5S](#) [770-006A109](#) [770-006A109R](#) [770-006A207](#) [770-006A208W1](#) [770-006A209](#) [770-006A306](#) [770-006A703W1](#)
[770-006A704](#) [770-006A704W1](#) [770-006A705](#) [770-006A706](#) [770-006A706W1](#) [770-006A707](#) [770-006A709](#) [770-007A203](#) [770-007A203W1](#)
[770-007A204W1](#) [770-007A207W1](#) [770-007A703](#) [770-007A704W1](#) [770-007A706](#) [770-007A707W1](#) [770-010Y208](#) [770-010Y308](#) [770-](#)
[010Y705](#) [770-010Y706](#) [770-010Y707W1](#) [770-011T201](#) [770-011T203](#) [770-011T701W1](#) [770-011T702](#) [770-011T702W1](#) [770-011T703](#) [770-](#)
[013311](#) [770-013312](#) [770-013709](#) [770-013711](#) [770-013711W1](#)