

LOW VOLTAGE AC DRIVES

ABB machinery drives

ACS380, 0.25 to 22 kW/0.37 to 30 hp





**Reliable performance and ease of
integration for machine builders.
ACS380 machinery drives.**

Table of contents

04–05	The ACS380 machinery drives
06–07	Reliable performance and ease of integration for machine builders
08	Typical industries and applications
09	ACS380 drives software with versatile features
10	EU Ecodesign Regulation
11	Technical data
12	How to select a drive
13	Ordering information
14	Ratings, types and voltages
16	Dimensions
17–19	Construction variants
20	Control panel options and mounting kits
21	Door mounting and daisy chaining
22	Tools for configuration, monitoring and process tuning
23	Flexible connectivity to automation networks
24–25	Safety options
26	I/O option modules
27	Resistor braking
28	EMC – electromagnetic compatibility
29	Filters and chokes
30–31	Cooling, fuses and circuit breakers
33	ACS380 drives are compatible with the wide ABB product offering
34	Choose the right motor for your application
35	Synchronous reluctance motors
36	Drivetune mobile application for wireless access
37	ABB SmartGuide – ACS380
38–39	Our service expertise, your advantage
40–41	ABB Drives Life Cycle Management

The ACS380 machinery drives

Reliable performance and ease of integration

Thanks to its reliable performance and ease of integration, the ACS380 is an all-compatible machinery drive ideal for machine building. All-compatible ABB drives share the same architecture and user interface for ease of use.

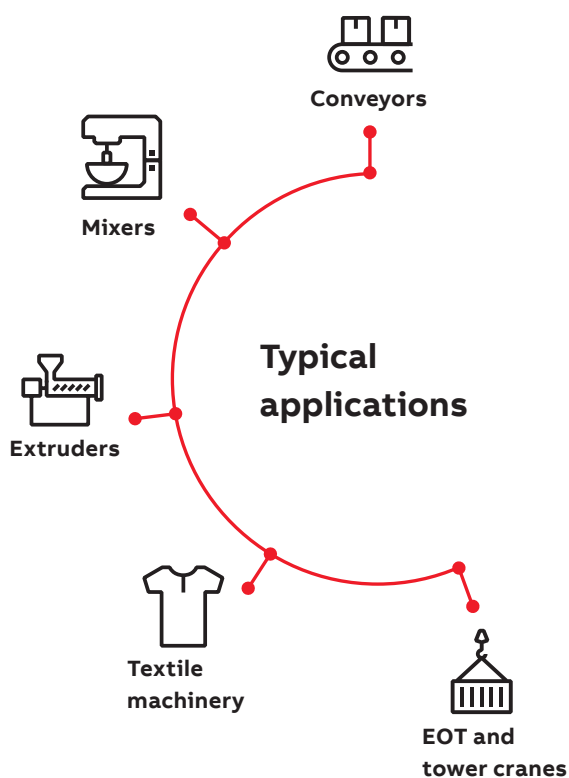

Excellent motor control

The ACS380 machinery drive is a robust and compact drive ideal for machine building. It can control various motor types from 0.25 to 22 kW. Whether the requirement is high starting torque, accurate speed control, stable torque or dynamic response to sudden load variations, the ACS380 drive meets it with or without encoder feedback.

Ease of integration

The ACS380 drive has many advanced features built-in as standard. A selection of variants and options allow the drive to be optimized for various fieldbus communication, I/O and EMC requirements. With the integrated functional safety features, the ACS380 drive can also be part of the machine's safety system via PROFIsafe over PROFINET and safely stop the motor when required. All together, this saves a lot of time and money for machine builders using large numbers of drives per year.

Designed to last 10 years or more

The design lifetime expectancy of the ACS380 drive and its overall components exceeds 10 years in normal operating environments. In some cases, ACS380 drive can last 20 years or more. Design features including coated circuit boards, minimized airflow through the electronics, and up to 50 °C operating temperature without derating make the ACS380 a safe choice for customers expecting high reliability. This is further enhanced by a full load test that is carried out on every single drive during production.



Reliable performance and ease of integration for machine builders

The ACS380 machinery drives are part of ABB's all-compatible drives portfolio. The drives give you consistent performance throughout their whole life cycle. They also offer a wider range of standard and optional features for optimal machine building.

A perfect match for a wide range of machines

ACS380 drives are available in two variants. The standard variant meets the most typical machinery requirements, whereas the configured variant can be optimized for more specific needs.

Excellent motor control

ACS380 drives support various motor types including induction, permanent magnet and synchronous reluctance motors. Motor control performance with 3-phase current measurement meets demanding load profile requirements. In addition, ACS380 controls induction or permanent magnet motors with or without speed feedback from an encoder.

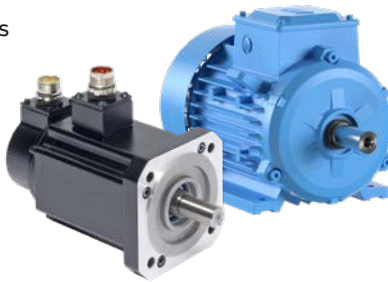

Ease of integration

An extensive selection of fieldbus adapters enables connectivity with all major industrial automation networks. Communication of the ACS380 drive is automatically set at power up for easy access from a PLC to the drive. Additional analog and digital I/O, or speed feedback can be added with option modules when needed.



Built-in functional safety

Safe torque off (STO) is a standard feature in all ACS380 drives. STO or safe stop 1 (SS1-t) can also be controlled via PFOFIsafe with an optional communication module.





Ease of use

The ACS380 drive has an integrated control panel with a display and control keys. The control panel's icon-based menu helps in setting up the drive quickly and effectively. Also, external user panels are available for installation to a cabinet door or for operation via a Bluetooth connection.

All-compatible user interface

ACS380 is part of ABB all-compatible drives portfolio. Other products in this portfolio are ACS480, ACS580 and ACS880 drives. All these drives have the same, easy to use PC tools and similar intuitive multilingual user interface as well as parameter and function structure, making using and learning them fast and easy.



Drive based programmability

Adaptive programming allows customization of the drive software using sequential and function block programming. This is a standard feature of the ACS380 drive requiring no additional downloads or licenses. It may allow the reduction of system costs by replacing the need for a PLC.

Designed to last 10 years or more

The ACS380 drives have improved durability and reliability in harsh conditions, including coated circuit boards and minimized air flow through the electronics. The drives are designed for an ambient temperature of up to 50 °C without derating. Also, the foil coated control panel offers good protection against dust and moisture, and the galvanically isolated fieldbus gives noise immunity.

Typical industries and applications

ACS380 drives improve process performance, increase productivity, reduce external components, and ensure machine and personnel safety



01



02



03







04



05

- 01 Food and beverage
- 02 Material handling
- 03 Textile
- 04 Plastics
- 05 Lumber and wood

Industry	Application	Customer benefits
Food and beverage 	Mixers, conveyors, mills, compressors, blowers, fans, pumps, dryers, ovens, extruders	<ul style="list-style-type: none"> • Precise speed control guarantees food production quality in different conditions • Robust design to maximize machine lifetime • Safe torque off (SIL 3/PL e) function ensures machine and personnel safety • Product flexibility to meet requirements of different food production machines
Material handling 	Conveyors, hoisting, cranes	<ul style="list-style-type: none"> • High starting torque for demanding operation and movements • Soft acceleration and deceleration with S-curve speed ramp, reducing the stress on the mechanical parts • Crane compatible mechanical brake control logic built in, including other crane application features • Integrated brake chopper enabling faster and accurate stop and reversing cycles • Safe torque off (SIL 3) function to prevent unexpected movements (POUS)
Textile 	Conveyors, drum washers, dyeing machines, spinning, pumps	<ul style="list-style-type: none"> • Precise and adjustable speed and torque control for highly accurate stretching management and better quality of the end product • Coated circuit boards, 50 °C ambient without derating and minimized air flow through electronics for reliable operation in harsh environments • Undervoltage control ensures uninterrupted production during power network disturbance
Plastics 	Extruders, molding machines, hoppers, polishers	<ul style="list-style-type: none"> • Accurate speed control to enable a steady extrusion process • Smooth speed profile to prevent plastic film web breakages • The scalable all-compatible platform allows easy process and component optimization with different drive types that share the same user interface and tools
Lumber and wood 	Conveyors, sorting lines, sanding, cutting	<ul style="list-style-type: none"> • High starting torque for demanding operation and movements • Soft acceleration and deceleration with S-curve speed ramp, reducing the stress on the mechanical parts • Mechanical brake control logic built in • Integrated brake chopper enabling faster and accurate stop and reversing cycles • Safe torque off (SIL 3) function to prevent unexpected movements

ACS380 drives software with versatile features

Excellent motor control. Whether the requirement is high starting torque, accurate speed control, stable torque or dynamic response to sudden load variations, ACS380 meets it with or without encoder feedback.

One drive for different motor types. ACS380 perfectly supports induction, permanent magnet and synchronous reluctance motors.

Easy integration to automation. Preconfigured fieldbus protocols enable connectivity with all major industrial automation networks with minimal effort and complexity.

Adaptive programming provides extra flexibility by offering easy alternative for simple programming needs. Download Drive Composer entry for free to start writing your application.

Built-in features for precise movements. Speed or torque reference can easily be adjusted for various needs. Movement range can be controlled with limit switches, and motor stopped in an optimal way with integrated braking chopper and mechanical brake control logic.

Load profile feature collects drive values, such as current and stores them in a log. This enables you to analyze and optimize the application with the help of historical data load.

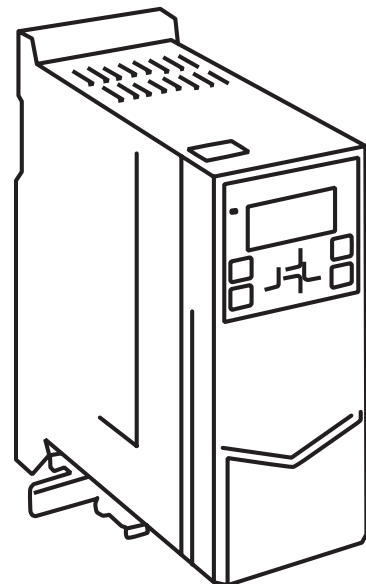

EU Ecodesign Regulation

The EU has agreed upon a new, more demanding regulation (EU) 2019/1781, replacing regulation 640/2009. The new Ecodesign Regulation (EU) 2019/1781 sets the minimum efficiency levels not only for direct-on-line rated low voltage induction motors but now also for variable speed drives with a voltage up to 1000 V. The regulation will be implemented in two steps July 1, 2021 and July 1, 2023.



Variable speed drives

Step 1: July 1, 2021

IE2 efficiency level mandatory for AC drives

- Power range from 0.12 to 1000 kW.
- 3-phase drives with diode rectifier including ABB's micro, machinery, general purpose, industrial and industry-specific drives.
- Drive manufacturers must declare power losses in percentage of the rated apparent output power at 8 different operating points as well as standby losses. The international efficiency, IE level is given at nominal point. Drives fulfilling the requirements will be CE marked.
- All the covered ABB products fulfill the requirements.

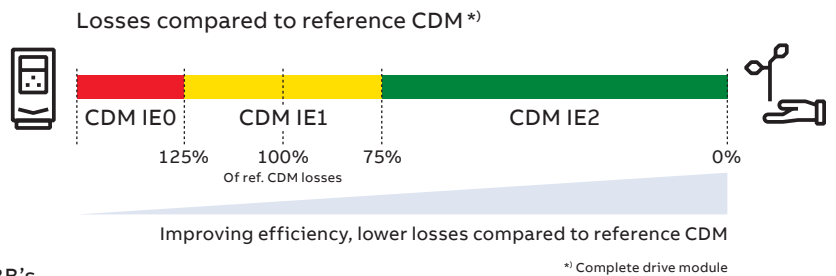

Excluded from the regulation:

- All drives without CE marking
- Following low voltage AC drives: regenerative drives, low-harmonic drives (THD < 10%), multiple AC-output drives and single-phase drives.
- Drive cabinets with already conformity assessed modules
- Medium voltage drives, DC drives and traction drives

Markings on the ABB AC drives

Unique identifier QR code to Ecodesign information

IE class and % loss of rated apparent power 50 Hz, 400 V

IE2 (90;100) 2,3 %

Unique QR codes are located on the rating plate and/or the front side of the drive.

Step 2: July 1, 2023

No changes for drives from July 1, 2021

For more information, see Ecodesign tool: <https://ecodesign.drivesmotors.abb.com/>



Technical data

Mains connection	
Voltage and power range	1-phase, 200 to 240 V, +10%/-15% 0.25 to 3.0 kW (1/3 to 3 HP) 3-phase, 200 to 240 V, +10%/-15% 0.25 to 15 kW (1/3 to 20 HP) 3-phase, 380 to 480 V, +10%/-15% 0.37 to 22 kW (1/2 to 30 HP)
Frequency	50/60 Hz ± 5%
Efficiency class (IEC 61800-9-2)	IE2
Common DC connection	
DC voltage level	-1 and -2 types 270 to 324 V ±10% -4 types 513 to 648 V ±10%
Charging circuit	Internal charging circuit
Motor connection	
Voltage	0 to U_N , 3-phase
Frequency	0 to 599 Hz
Motor control	Scalar control Vector control
Switching frequency	1 to 12 kHz, default 4 kHz
Dynamic braking	Flux braking (moderate or full) Resistor braking (optional)
Motor control performance	
Speed control performance, open loop	
Static accuracy	20% of motor rated slip
Dynamic accuracy	1% seconds with 100% torque step
Speed control performance, closed loop	
Static accuracy	0.1% of motor rated speed
Dynamic accuracy	<1% seconds with 100% torque step
Torque control performance	
Torque step rise time	< 10 ms, rated torque step
Non-linearity	±5% with rated torque
Braking power connection	
Brake chopper	Built-in brake chopper as standard
Brake resistor	External resistor connected to drive
Functional safety	
Built-in safety features	Safe torque off (STO) EN/IEC61800-5-2: IEC61508 ed2: SIL 3, IEC 61511: SIL 3, IEC 62061: SIL CL 3, EN ISO 13849-1: PL e/cat. 3

Environmental limits	
Ambient temperature	
Transportation and storage	-40 to +70 °C (-40 to +158 °F)
Operation	-10 to +50 °C (14 to 122 °F), with derating up to 60 °C (except R0, which has max. temperature of 50 °C)
Cooling method	Air-cooled, dry clean air
Altitude	0 to 4000 m, (0 to 13000 ft) for 400 V units (see allowed power systems in HW manual) 0 to 2000 m, (0 to 6600 ft) for 200 V units derating above 1000 m (3300 ft)
Relative humidity	5 to 95%, no condensation allowed
Degree of protection	IP20 as standard Optional UL type 1 Kit
Contamination levels	No conductive dust allowed
Storage	IEC 60721-3-1, Class 1C2 (chemical gases) Class 1S2 (solid particles)
Transportation	IEC 60721-3-2, Class 2C2 (chemical gases) Class 2S2 (solid particles)
Operation	IEC 60721-3-3, Class 3C2 (chemical gases) Class 3S2 (solid particles)
Product compliance	
CE	
Low Voltage Directive 2014/35/EU 2, EN 61800-5-1: 2007 Machinery Directive 2006/42/EC, EN 61800-5-2: 2007 EMC Directive 2014/30/EU, EN 61800-3: 2004 + A1: 2012 UL, cUL certification – file E211945 TUV Certification for functional safety Quality assurance system ISO 9001 Ecodesign (EU) 2019/1781 Environmental system ISO 14001 Waste electrical and electronic equipment directive (WEEE) 2002/96/EC RoHS directive 2011/65/EU EAC, KC, RCM	

How to select a drive

How you build up your ordering code

Start by identifying your supply voltage
This indicates what rating table to use;
see page 14.

Select the ordering code for the ACS380
machinery drive by choosing either the
standard or the configured variant (page
13). Then choose the desired EMC level on
page 13. If the configured variant is
selected, choose the desired fieldbus
protocol (page 23) by selecting the correct
option code and add the option codes to
the drive's ordering code.

Ordering information

The type designation indicates the specifications and configuration of the drive.
The table shows the primary drive variants.
Sample type code 1: ACS380-04X2-02M4 (Standard variant, not possible to add options as placecode)
Sample type code 2: ACS380-04X2-02M4-4H431-L532 (Configured variant, possible to add options as placecode)

Supply voltage	A	B	C	D	E	F
Product series						
Type and construction						
Rating						
Voltage						
Option code						

EMC codes

Option code	EMC level	Type designation
A	EMC 1000	02M4
B	EMC 1000	02M4
C	EMC 1000	02M4
D	EMC 1000	02M4
E	EMC 1000	02M4

Option codes for configured variant (ACS380-04XX) and MPP code for motor name

Option code	MPP code	Type designation	Description	
F	Fieldbus adapter module	04XX	04XX-01	Profibus-DP
			04XX-02	Profibus-DP
			04XX-03	Profibus-DP
			04XX-04	Profibus-DP
			04XX-05	Profibus-DP
			04XX-06	Profibus-DP
			04XX-07	Profibus-DP
			04XX-08	Profibus-DP
			04XX-09	Profibus-DP
			04XX-10	Profibus-DP
			04XX-11	Profibus-DP
			04XX-12	Profibus-DP
			04XX-13	Profibus-DP
			04XX-14	Profibus-DP
			04XX-15	Profibus-DP
			04XX-16	Profibus-DP
			04XX-17	Profibus-DP
			04XX-18	Profibus-DP
			04XX-19	Profibus-DP
			04XX-20	Profibus-DP
			04XX-21	Profibus-DP
			04XX-22	Profibus-DP
			04XX-23	Profibus-DP
			04XX-24	Profibus-DP
			04XX-25	Profibus-DP
			04XX-26	Profibus-DP
			04XX-27	Profibus-DP
			04XX-28	Profibus-DP
			04XX-29	Profibus-DP
			04XX-30	Profibus-DP
			04XX-31	Profibus-DP
			04XX-32	Profibus-DP
			04XX-33	Profibus-DP
			04XX-34	Profibus-DP
			04XX-35	Profibus-DP
			04XX-36	Profibus-DP
			04XX-37	Profibus-DP
			04XX-38	Profibus-DP
			04XX-39	Profibus-DP
			04XX-40	Profibus-DP
			04XX-41	Profibus-DP
			04XX-42	Profibus-DP
			04XX-43	Profibus-DP
			04XX-44	Profibus-DP
			04XX-45	Profibus-DP
			04XX-46	Profibus-DP
			04XX-47	Profibus-DP
			04XX-48	Profibus-DP
			04XX-49	Profibus-DP
			04XX-50	Profibus-DP
			04XX-51	Profibus-DP
			04XX-52	Profibus-DP
			04XX-53	Profibus-DP
			04XX-54	Profibus-DP
			04XX-55	Profibus-DP
			04XX-56	Profibus-DP
			04XX-57	Profibus-DP
			04XX-58	Profibus-DP
			04XX-59	Profibus-DP
			04XX-60	Profibus-DP
			04XX-61	Profibus-DP
			04XX-62	Profibus-DP
			04XX-63	Profibus-DP
			04XX-64	Profibus-DP
			04XX-65	Profibus-DP
			04XX-66	Profibus-DP
			04XX-67	Profibus-DP
			04XX-68	Profibus-DP
			04XX-69	Profibus-DP
			04XX-70	Profibus-DP
			04XX-71	Profibus-DP
			04XX-72	Profibus-DP
			04XX-73	Profibus-DP
			04XX-74	Profibus-DP
			04XX-75	Profibus-DP
			04XX-76	Profibus-DP
			04XX-77	Profibus-DP
			04XX-78	Profibus-DP
			04XX-79	Profibus-DP
			04XX-80	Profibus-DP
			04XX-81	Profibus-DP
			04XX-82	Profibus-DP
			04XX-83	Profibus-DP
			04XX-84	Profibus-DP
			04XX-85	Profibus-DP
			04XX-86	Profibus-DP
			04XX-87	Profibus-DP
			04XX-88	Profibus-DP
			04XX-89	Profibus-DP
			04XX-90	Profibus-DP
			04XX-91	Profibus-DP
			04XX-92	Profibus-DP
			04XX-93	Profibus-DP
			04XX-94	Profibus-DP
			04XX-95	Profibus-DP
			04XX-96	Profibus-DP
			04XX-97	Profibus-DP
			04XX-98	Profibus-DP
			04XX-99	Profibus-DP
			04XX-100	Profibus-DP

Page 13

Choose other options (on page 26) and
add the option codes to the drive's order
code. Remember to use a "+" mark before
each option code.

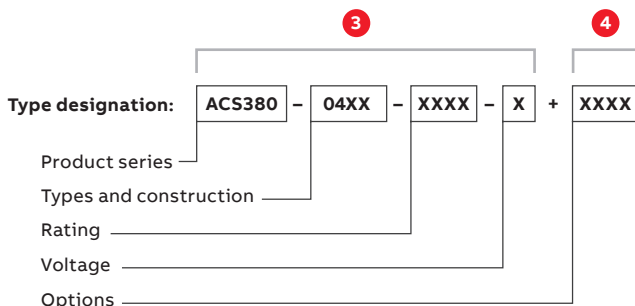

Choose the motor power and
current rating from the ratings
table on page 14.

Ratings, types and voltages

Supply voltage	Power	Max. output current	Max. output current	Max. output current	
230 V, 3-Phase (50 to 60 Hz)	AC380-04xx-04x1-1	40	2.3	0.25	2.3
	AC380-04xx-04x1-2	40	2.3	0.25	2.3
	AC380-04xx-04x1-3	40	2.3	0.25	2.3
	AC380-04xx-04x1-4	40	2.3	0.25	2.3
	AC380-04xx-04x1-5	40	2.3	0.25	2.3
	AC380-04xx-04x1-6	40	2.3	0.25	2.3
	AC380-04xx-04x1-7	40	2.3	0.25	2.3
	AC380-04xx-04x1-8	40	2.3	0.25	2.3
	AC380-04xx-04x1-9	40	2.3	0.25	2.3
	AC380-04xx-04x1-10	40	2.3	0.25	2.3
230 V, 3-Phase (50 to 60 Hz)	AC380-04xx-04x2-1	80	4.6	0.5	4.6
	AC380-04xx-04x2-2	80	4.6	0.5	4.6
	AC380-04xx-04x2-3	80	4.6	0.5	4.6
	AC380-04xx-04x2-4	80	4.6	0.5	4.6
	AC380-04xx-04x2-5	80	4.6	0.5	4.6
	AC380-04xx-04x2-6	80	4.6	0.5	4.6
	AC380-04xx-04x2-7	80	4.6	0.5	4.6
	AC380-04xx-04x2-8	80	4.6	0.5	4.6
	AC380-04xx-04x2-9	80	4.6	0.5	4.6
	AC380-04xx-04x2-10	80	4.6	0.5	4.6

Page 14

I/O option modules

ACS380 drives can be ordered with different I/O configurations. The standard input and output of the drive can be extended by using I/O option modules. A BMD-01 module extends the configured variant's I/O, whereas a BMD-02 module provides both additional I/O and Modbus. In case additional relay outputs are needed, they can be added with a BMD-03 module. A BMD-04 module introduces an external 24 V DC supply to the drive's control circuitry.

The ACS380 drive's open loop performance is sufficient for almost any application, even when accurate control is needed close to zero speed. However, if speed feedback is needed for even more accurate control or for active feed-back, a speed feedback module STAC-01 adds support for TTL and HTL pulse encoders.

Option code	Description	Module
BMD-01	External relay output, 4 NO (24V/250V)	BMD-01
BMD-02	I/O option (I/O extension, CAN and Modbus)	BMD-02
BMD-03	External 24 V DC (24V/250V)	BMD-03
BMD-04	HTL/TTL encoder interface, external 24 V DC (24V/250V)	BMD-04

Input	Output
Digital inputs	Digital outputs
Frequency inputs	Frequency outputs
Counter inputs	Counter outputs
Analog inputs	Analog outputs
Relay outputs	Relay outputs
Digital outputs	Digital outputs
Frequency outputs	Frequency outputs
Analog outputs	Analog outputs

Page 26

Ordering information

The type designation indicates the specifications and configuration of the drive.

The table shows the primary drive variants.

Sample type code 1: ACS380-042S-02A6-4 (Standard variant, not possible to add options as pluscode)

Sample type code 2: ACS380-042C-02A6-4+K475+ L535 (Configured variant, possible to add options as pluscode)

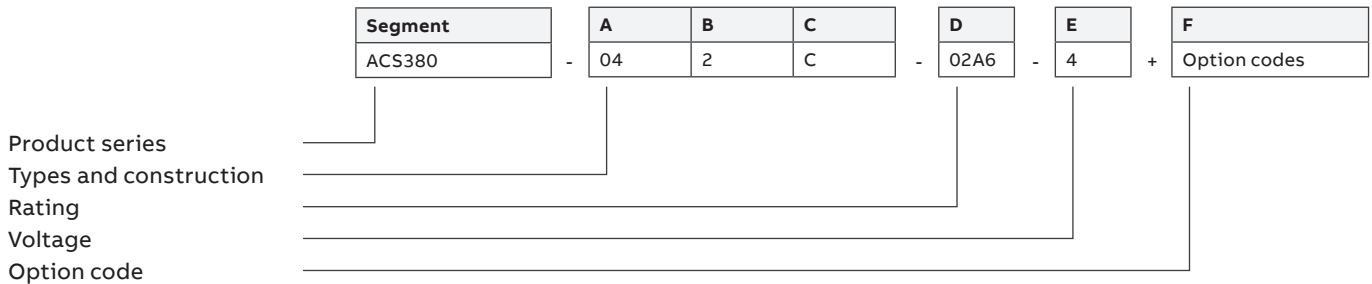

Basic codes		
Segment	Option	Description
A	Construction	04 = Module, IP20
B	EMC filter	0 = C3 (3-phase 400 V) or C4 (1-phase 230 V, 3-phase 230 V) 2 = C2 (3-phase 400 V, 1-phase 230 V)
C	Connectivity	S = Standard variant (I/O and Modbus), C = Configured variant, N = Base variant
D	Current rating	For example, 02A6 refers to a nominal output current of 2.6 A
E	Voltage rating	1 = 1-phase 230 V, 2 = 3-phase 230 V, 4 = 3-phase 400 V

Option codes for configured variant (ACS380-04xC) and MRP codes for loose items							
Segment	Option	Option code	MRP code	Type designation	Description		
F	Fieldbus adapter module	+K451	68469341	FDNA-01	DeviceNet™		
		+K454	68469325	FPBA-01	Profibus-DP		
		+K457	68469376	FCAN-01	CANopen®		
		+K462	3AUA0000094512	FCNA-01	ControlNet™		
		+K469	3AUA0000072069	FECA-01	EtherCAT®		
		+K470	3AUA0000072120	FEPL-02	Ethernet POWERLINK		
		+K490	3AXD50000192786	FEIP-21	EtherNet/IP™		
		+K491	3AXD50000049964	FMBT-21	Modbus/TCP		
		+K492	3AXD50000192779	FPNO-21	PROFINET IO		
		+K495	3AXD50000033816	BCAN-11	CANopen® (screw terminals)		
		I/O		+L511	3AXD50000022162	BREL-01	External relay option (4 x relay) (side option)
				+L515	3AXD50000191635	BIO-01	I/O option module (front option, can be used together with fieldbus)
				+L534	3AXD50000022164	BAPO-01	External 24 V DC (side option)
				+L535	3AXD50000022163	BTAC-02	HTL/TTL encoder interface + External 24 V DC (side option)
+L538	3AXD50000021262			BMIO-01	I/O & Modbus option module (front option)		
Safety functions module		+Q986	3AXD50000112821	FSPS-21	PROFIsafe with PROFINET IO		
Services		+P992			Pre-assembled options (front and side options)		
The product package includes a quick installation and start-up guide in several languages. The option code determines the language variants of the hardware and firmware manuals.	Printed manual languages:	+R700			English		
		+R701			German		
		+R702			Italian		
		+R703			Dutch		
		+R704			Danish		
		+R705			Swedish		
		+R706			Finnish		
		+R707			French		
		+R708			Spanish		
		+R709			Portuguese (Portugal)		
		+R711			Russian		
+R712			Chinese				
+R714			Turkish				
+R713			Polish				

Ratings, types and voltages

1-phase, $U_N = 230$ V (range 200 to 240 V). The power ratings are valid at nominal voltage 230 V (0.25 to 3.0 kW).

Drive type	Frame size	Nominal ratings		Light-duty use		Heavy-duty use		Max. output current I_{MAX} (A)
		I_N (A)	P_N (kW)	I_{Ld} (A)	P_{Ld} (kW)	I_{Hd} (A)	P_{Hd} (kW)	
ACS380-04xx-02A4-1	R0	2.4	0.37	2.3	0.37	1.8	0.25	3.2
ACS380-04xx-03A7-1	R0	3.7	0.55	3.5	0.55	2.4	0.37	4.3
ACS380-04xx-04A8-1	R1	4.8	0.75	4.6	0.75	3.7	0.55	6.7
ACS380-04xx-06A9-1	R1	6.9	1.1	6.6	1.1	4.8	0.75	8.6
ACS380-04xx-07A8-1	R1	7.8	1.5	7.4	1.5	6.9	1.1	12.4
ACS380-04xx-09A8-1	R2	9.8	2.2	9.3	2.2	7.8	1.5	14.0
ACS380-04xx-12A2-1	R2	12.2	3.0	11.6	3.0	9.8	2.2	17.6

3-phase, $U_N = 230$ V (range 200 to 240 V). The power ratings are valid at nominal voltage 230 V (0.25 to 15 kW).

Drive type	Frame size	Nominal ratings		Light-duty use		Heavy-duty use		Max. output current I_{MAX} (A)
		I_N (A)	P_N (kW)	I_{Ld} (A)	P_{Ld} (kW)	I_{Hd} (A)	P_{Hd} (kW)	
ACS380-04xx-02A4-2	R1	2.4	0.37	2.3	0.37	1.8	0.25	3.2
ACS380-04xx-03A7-2	R1	3.7	0.55	3.5	0.55	2.4	0.37	4.3
ACS380-04xx-04A8-2	R1	4.8	0.75	4.6	0.75	3.7	0.55	6.7
ACS380-04xx-06A9-2	R1	6.9	1.1	6.6	1.1	4.8	0.75	8.6
ACS380-04xx-07A8-2	R1	7.8	1.5	7.5	1.5	6.9	1.1	12.4
ACS380-04xx-09A8-2	R1	9.8	2.2	9.3	2.2	7.8	1.5	14.0
ACS380-04xx-12A2-2	R2	12.2	3.0	11.6	3.0	9.8	2.2	17.6
ACS380-04xx-17A5-2	R3	17.5	4.0	16.7	4.0	12.2	3.0	22.0
ACS380-04xx-25A0-2	R3	25.0	5.5	24.2	5.5	17.5	4.0	31.5
ACS380-04xx-032A-2	R4	32.0	7.5	30.8	7.5	25.0	5.5	45.0
ACS380-04xx-048A-2	R4	48.0	11.0	46.2	11.0	32.0	7.5	57.6
ACS380-04xx-055A-2	R4	55.0	15.0	52.8	15.0	48.0	11.0	86.4

3-phase, $U_N = 400$ V (range 380 to 480 V). The power ratings are valid at nominal voltage 400 V (0.37 to 22 kW).

Drive type	Frame size	Nominal ratings		Light-duty use		Heavy-duty use		Max. output current I_{MAX} (A)
		I_N (A)	P_N (kW)	I_{Ld} (A)	P_{Ld} (kW)	I_{Hd} (A)	P_{Hd} (kW)	
ACS380-04xx-01A8-4	R0	1.8	0.55	1.7	0.55	1.2	0.37	2.2
ACS380-04xx-02A6-4	R1	2.6	0.75	2.5	0.75	1.8	0.55	3.2
ACS380-04xx-03A3-4	R1	3.3	1.1	3.1	1.1	2.6	0.75	4.7
ACS380-04xx-04A0-4	R1	4.0	1.5	3.8	1.5	3.3	1.1	5.9
ACS380-04xx-05A6-4	R1	5.6	2.2	5.3	2.2	4.0	1.5	7.2
ACS380-04xx-07A2-4	R1	7.2	3.0	6.8	3.0	5.6	2.2	10.1
ACS380-04xx-09A4-4	R1	9.4	4.0	8.9	4.0	7.2	3.0	13.0
ACS380-04xx-12A6-4	R2	12.6	5.5	12.0	5.5	9.4	4.0	16.9
ACS380-04xx-17A0-4	R3	17.0	7.5	16.2	7.5	12.6	5.5	22.7
ACS380-04xx-25A0-4	R3	25.0	11.0	23.8	11.0	17.0	7.5	30.6
ACS380-04xx-032A-4	R4	32.0	15.0	30.5	15.0	25.0	11.0	45.0
ACS380-04xx-038A-4	R4	38.0	18.5	36.0	18.5	32.0	15.0	57.6
ACS380-04xx-045A-4	R4	45.0	22.0	42.8	22.0	38.0	18.5	68.4
ACS380-04xx-050A-4	R4	50.0	22.0	48.0	22.0	45.0	22.0	81.0

Nominal ratings

I_N	Nominal output current available continuously without overloadability at 50 °C.
P_N	Typical motor power in no-overload use.

Maximum output current

I_{max}	Maximum output current. Available for 2 seconds at start, then as long as allowed by drive temperature.
-----------	---

Heavy-duty use

I_{Hd}	Output current allowing 150% I_{Hd} for 1 minute every 10 minutes at 50 °C.
P_{Hd}	Typical motor power in heavy-duty use.

Light-duty use

I_{Ld}	Output current allowing 110% I_{Ld} for 1 minute every 10 minutes at 50 °C.
P_{Ld}	Typical motor power in light-overload use.

The ratings apply at 50 °C ambient temperatures.

For derating at higher altitudes, temperatures or switching frequencies, see the user's HW manual, document code: 3AXD50000029274.



Dimensions

Dimensions and weights (IP20 / UL open type)

Frame size	H1 (mm)	H2 (mm)	H3 (mm)	W1 (mm)	W2 (mm)	W3 (mm)	D1 (mm)	D2 (mm)	M1 (mm)	M2 (mm)	Weight (kg)
R0	205	223	170	70	86	94	176	191	50	191	1.4
R1	205	223	170	70	86	94	176	191	50	191	1.4
R2	205	223	170	95	111	119	176	191	75	191	2.0
R3	205	223	170	170	186	194	176	191	148	191	3.3
R4	205	240	170	260	276	284	181	196	234	191	5.3

H1 = Mounting surface height (back)
H2 = Height, total
H3 = Enclosure height (front)
W1 = Width without side option
W2 = Width with side option BAPO-01
W3 = Width with side optios BTAC-02, BREL-01

D1 = Depth
D2 = Depth with deeper cover *)
M1 = Mounting hole distance 1
M2 = Mounting hole distance 2

*) Deeper cover (with BIO-01 or FSPS-21) will increase normal depth (D1) by 15 mm

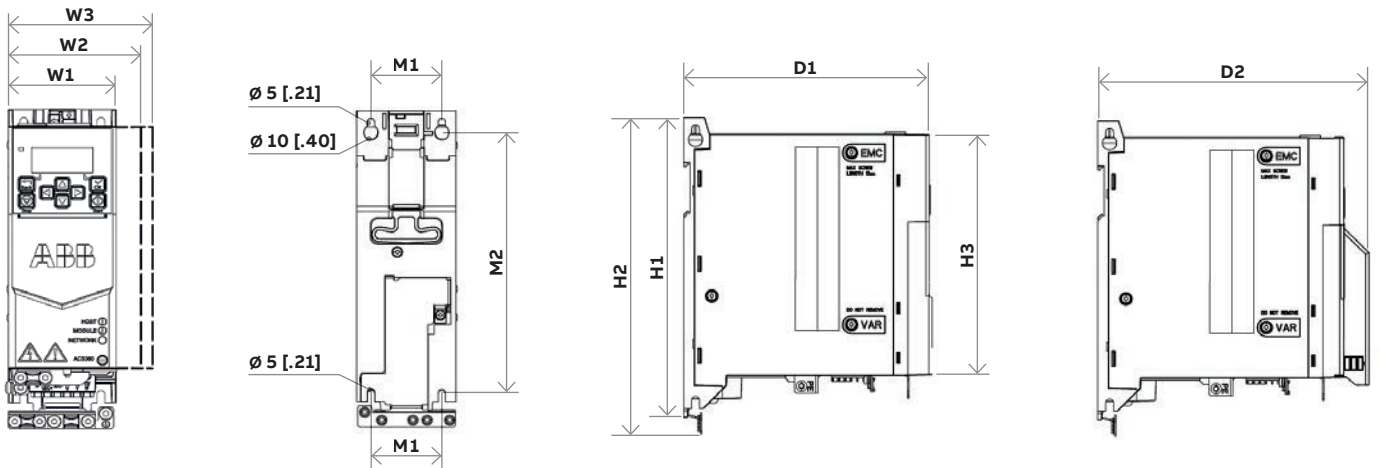

Dimensions and weights (drive with UL type 1 kit)

Frame size	H1 (mm)	H2 (mm)	H3 (mm)	W1 (mm)	W2 (mm)	W3 (mm)	D (mm)	M1 (mm)	M2 (mm)	Weight (kg)
R0	205	285	247	70	86	94	191	50	191	1.8
R1	205	293	247	70	86	94	191	50	191	1.8
R2	205	293	247	95	111	119	191	75	191	2.5
R3	205	329	261	170	186	194	191	148	191	4.0
R4	205	391	312	260	276	284	196	234	191	6.5

H1 = Mounting surface height (back)
H2 = Height with UL Type 1 kit, total
H3 = Height with UL type 1 kit, enclosure (front)
W1 = Width without side option
W2 = Width with side option BAPO-01
W3 = Width with side optios BTAC-02, BREL-01

D = Depth
M1 = Mounting hole distance 1
M2 = Mounting hole distance 2

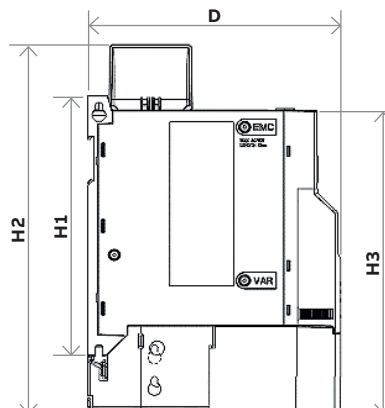

Construction variants

The ACS380 machinery drive comes in several variants ensuring seamless integration into machines and connecting perfectly to automation systems.

Standard variant (ACS380-04xS)

Meets the most typical machinery requirements.

A standard variant (ACS380-04xS) includes BMIO-01 module in the delivery to support Modbus RTU and a wide range of digital and analog I/O. In addition, this construction variant has one side option slot. Options are available as loose items via mpr ordering codes.

The standard variant includes:

- 4 DI + 2 DI/DO + 2 AI + 1 AO + 1 RO + STO
- Embedded Modbus RTU

Default I/O connections of standard variant (ACS380-04xS)

Terminals	Descriptions
Aux. voltage output and digital connections	
+24 V	Aux. voltage output +24 V DC, max. 250 mA
DGND	Aux. voltage output common
DCOM	Digital input common for all
DI 1	Digital input 1: Stop (0)/Start (1)
DI 2	Digital input 2: Forward (0)/Reverse (1)
DI 3	Digital input 3: Speed selection
DI 4	Digital input 4: Speed selection
DIO 1	Digital input function: Ramp set 1 (0)/Ramp set 2 (1)
DIO 2	Digital output function: Ready to run (0)/Not ready (1)
DIO SRC	Signal cable shield (screen)
DIO COM	Digital input common for all
Reference voltage and analog I/O	
AI 1	Output frequency/Speed reference (0...10 V)
AGND	Analog input circuit common
AI 2	Not configured
AGND	Analog input circuit common
AO	Output frequency (0...20 mA)
AGND	Analog output circuit common
SCR	Signal cable shield (screen)
+10 V	Reference voltage
Safe torque off (STO)	
S+	Safe torque-off function. Connected at the factory. The drive starts only when both circuits are closed. Refer to the Safe torque off function in the hardware manual.
SGND	
S 1	
S 2	
Relay output	
RC	No fault [Fault (-1)]
RA	
RB	
EIA-485 Modbus RTU	
B+	Embedded Modbus RTU (EIA-485)
A-	
BGND	
Shield	
Termination	

Default I/O connections of the standard variant

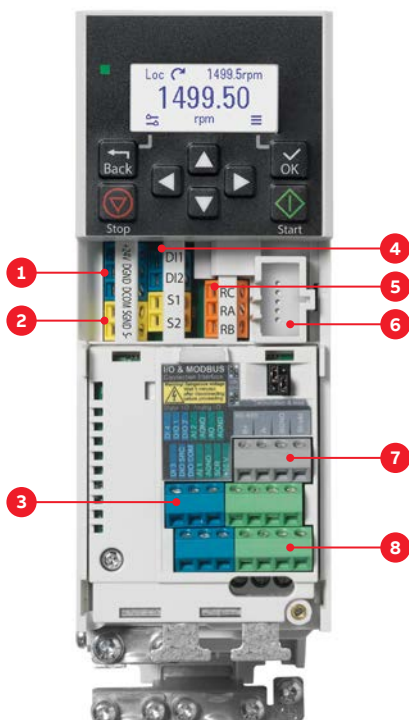

1. Auxiliary voltage outputs
2. Safe torque off connections
3. Digital inputs and outputs
4. Digital inputs
5. Relay output connection
6. Cold configuration connection for CCA-01
7. EIA-485 Modbus RTU
8. Analog inputs and outputs

Construction variants

Configured variant (ACS380-04xC)

Simplified ordering by one single ordering code and possibility for preinstalled options.

A configured variant (ACS380-04xC) can be configured with different options covering digital and analog I/O, fieldbus communication, speed feedback and external 24 V DC supply.

The configured variant includes:

- 2 DI + 1 RO + STO + one preconfigured fieldbus

Options ordered with the pluscode. (See pluscodes, page 13):

- **Fieldbus options**
PROFIBUS, PROFINET/PROFIsafe, EtherNet/IP™, Modbus TCP/IP, EtherCAT®, POWERLINK, DeviceNet™, CanOpen®
- **One of following side options**
 - HTL/TTL encoder & ext. 24 V DC supply (BTAC-02)
 - 4 x relay output module (BREL-01)
 - External 24 V DC supply (BAPO-01)
- **One front I/O option**
can be used together with fieldbus
3 DI + 1 DO + 1 AI + 1 AO (BIO-01)

Default connections of configured variant (ACS380-04xC)

Terminals	Descriptions
Aux. voltage output and digital connections	
+24 V	Aux. voltage output +24 V DC, max. 250 mA
DGND	Aux. voltage output common
DCOM	Digital input common for all
DI 1	Digital input 1: Stop (0)/Start (1)
DI 2	Digital input 2: Forward (0)/Reverse (1)
Safe torque off (STO)	
S+	Safe torque off function. Connected at the factory. The drive starts only when both circuits are closed. Refer to the Safe torque off function in the hardware manual.
SGND	
S 1	
S 2	
Relay output	
RC	Fault (-1)
RA	250 V AC/30 V DC
RB	2 A
Option module connections	
See table on page 17 for available fieldbus connection options and table on page 22 for I/O options.	

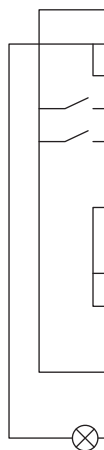

ACS380 configured variant (ACS380-04xC)



Base variant (ACS380-04xN)

Offers maximum flexibility with minimum stock items for varying machine building needs.

Base variant can be ordered with any of the connectivity or I/O option as loose item.

Options:

Fieldbus options

PROFIBUS, PROFINET/PROFIsafe, EtherNet/IP™, Modbus TCP/IP, EtherCAT®, POWERLINK, DeviceNet™, CanOpen®

One of following side options

- HTL/TTL encoder & ext. 24 V DC supply (BTAC-02)
- 4 x relay output module (BREL-01)
- External 24 V DC supply (BAPO-01)

One front I/O option

can be used together with fieldbus
3 DI + 1 DO + 1 AI + 1 AO (BIO-01)

Default connections of base variant (ACS380-04xN)

Terminals	Descriptions
Aux. voltage output and digital connections	
+24 V	Aux. voltage output +24 V DC, max. 250 mA
DGND	Aux. voltage output common
DCOM	Digital input common for all
DI 1	Digital input 1: Stop (0)/Start (1)
DI 2	Digital input 2: Forward (0)/Reverse (1)
Safe torque off (STO)	
S+	Safe torque off function. Connected at the factory. The drive starts only when both circuits are closed. Refer to the Safe torque off function in the hardware manual.
SGND	
S 1	
S 2	
Relay output	
RC	Fault (-1)
RA	250 V AC/30 V DC
RB	2 A
Option module connections	
See table on page 17 for available fieldbus connection options and table on page 22 for I/O options.	

ACS380 base variant (ACS380-04xN)



Control panel options and mounting kits

The ACS380 drive has an integrated control panel with a display and control keys. Also, external control panels are available for installation to a cabinet door or for operation via Bluetooth connection.



Integrated control panel

Almost anyone can set up and commission the machinery drive using the available control panels. The ACS380 comes with the integrated icon-based control panel as standard. You do not need to know any drive parameters as the control panel helps you to set up the essential settings quickly and get the drive into action. In addition, ACS380 supports the assistant control panel (AP-I, AP-S or AP-W).



Assistant control panel, ACS-AP-I *)

The optional Assistant control has a graphical, multilingual display. There is no need to know any drive parameters, as the control panel helps you set up the essential settings quickly and get the drive into action without hassle. The panel can be used with any products in the ABB all-compatible product portfolio.



Bluetooth control panel, ACS-AP-W *)

The optional Bluetooth panel enables connection with the Drivetune mobile app. The app is available for free from Google Play and the Apple App Store. Together with the Drivetune app and the Bluetooth panel, users can, for example, commission and monitor the drive remotely.



Basic control panel, ACS-BP-S

If there is a need to install a basic panel into the cabinet door, the ACS-BP-S is the right choice. The icon-based control panel supports users with basic operation, settings and fault tracking when nothing extra is needed.



Control panel mounting platform, DPMP-01

This mounting platform is for flush mountings. The panel mounting platform does not include the control panel.



Control panel mounting platform, DPMP-02

This mounting platform is for surface mounting. The panel mounting platform does not include the control panel.



Control panel mounting platform, DPMP-04

Enables control panel outdoor mounting thanks to IP66 protection class, UV resistance and IK07 impact protection rating.

Control panel options

Ordering code	Description	Control panel
3AUA0000088311	Industrial assistant control panel *)	ACS-AP-I
3AUA0000064884	Assistant control panel	ACS-AP-S
3AXD0000025965	Assistant control panel with bluetooth interface *)	ACS-AP-W
3AXD50000028828	Basic control panel	ACS-BP-S
3AUA0000108878	Control panel mounting platform (flush mounted)	DPMP-01
3AXD50000009374	Control panel mounting platform (surface mounted)	DPMP-02
3AXD50000217717	Control panel mounting platform (outdoor installation)	DPMP-04

*) Also compatible with the following ABB all-compatible drives: ACS480, ACS580 and ACS880.

Door mounting and daisy chaining

Improve safety and leverage the full potential of the ACS380 control panel options with a door mounting kit and panel bus adapter.



Door mounting fosters easy operation and safety. It enables you to operate the drive without opening the cabinet door, saving time and keeping all the electronics behind the closed door. Up to 32 drives can be connected to one control panel

for even easier and quicker operation. When daisy chaining the drives, you need only one assistant control panel. The rest of the drives can be equipped with panel bus adapters and the last drive with termination plug.

Cabinet door

Control panel mounting platform

The mounting platform for the drive's control panel.

Assistant control panel

The assistant control panel can be selected with ACS380 drives. Also a Bluetooth control panel can be used.



Cabinet, outside

RJ-45 cable for daisy chaining drives

With BSPL-01 Panel bus adapter and panel bus termination plug.

Panel bus adapter is required for each drive and termination plug only for the last drive.

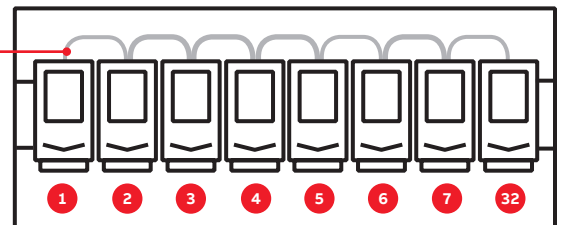

Cabinet, inside

Tools for configuration, monitoring and process tuning

ACS380 has various tools to simplify the commissioning, operation and monitoring of the drive.



Easy configuration for unpowered drives

With the CCA-01 tool, it is possible to configure drive parameters and even download new software from PC to the unpowered ACS380. The power is supplied by a PC USB port.



Connection with cable

Using the BCBL-01 cable, the PC can be connected directly to the RJ-45 panel port on the ACS380 drive.



Drive Composer

The Drive Composer PC tool offers fast and harmonized setup, commissioning and monitoring. Drive Composer entry (a free version of the tool) provides startup and maintenance capabilities and gathers all drive information, such as parameter loggers, faults, and backups into a support diagnostics file.

Drive Composer pro provides additional features such as custom parameter windows, graphical control diagrams of the drive's configuration, and improved monitoring and diagnostics.



Connection to assistant panel

When using the Assistant control panel, the Drive composer tool is connected to the drive using the mini USB connection on the panel.

Ordering code	Description	Type designation
3AXD50000032449	PC cable, USB to RJ45	BCBL-01
3AXD50000019865	Cold configurator adapter, packed kit	CCA-01
3AUA0000108087	Drive Composer pro PC tool (single user license)	DCPT-01
3AUA0000145150	Drive Composer pro PC tool (10 users license)	DCPT-01
3AUA0000145151	Drive Composer pro PC tool (20 users license)	DCPT-01
3AXD50000131976	Panel bus adapter	BSPL-01
3AXD50000128624	Panel bus termination plug	BPLG-01

Free Drive Composer entry available at <https://new.abb.com/drives/software-tools/drive-composer>

Flexible connectivity to automation networks

Fieldbus communication reduces wiring costs compared with traditional hard-wired input/output connections.

The ACS380 configured variant is compatible with a wide range of fieldbus protocols. Fieldbus adapter modules are automatically configured during first power up, thus reducing commissioning time and allowing drive commissioning from the PLC. The ACS380 standard variant comes with built-in Modbus RTU protocol.

Support tools for integration with automation

Support for the fieldbuses is not always enough to get the full functionality and to make integration easy. For this reason, ABB also offers tools for seamless integration to automation systems of various manufacturers.



Universal communication with ABB fieldbus adapters

The machinery drives support the following fieldbus protocols:

Option code	Ordering code	Fieldbus protocol	Adapter module
+K451	68469341	DeviceNet™	FDNA-01
+K454	68469325	PROFIBUS DP, DPV0/DPV1	FPBA-01
+K457	68469376	CANopen®	FCAN-01
+K462	3AUA0000094512	ControlNet™	FCNA-01
+K469	3AUA0000072069	EtherCAT®	FECA-01
+K470	3AUA0000072120	Ethernet POWERLINK	FEPL-02
+K490	3AXD50000192786	Ethernet/IP™	FEIP-21
+K491	3AXD50000049964	Modbus/TCP	FMBT-21
+K492	3AXD50000192779	PROFINET IO	FPNO-21
+K495	3AXD50000033816	CANopen® (screw terminals)	BCAN-11

Safety options

Integrated safety

Integrated safety reduces the need for external safety components, simplifying configuration and reducing installation space. The safety functionality is a built-in feature of the ACS380, with safe torque off (STO) as standard. ACS380 can also be part of PROFIsafe over PROFINET network, where safety PLC is controlling the STO or safe stop 1, time controlled, SS1-t functionality. This connectivity and functionality can be done by using the FSPS-21 option module.

The drives' functional safety is designed in accordance with EN/IEC 61800-5-2 and complies with the requirements of the European Union Machinery Directive (2006/42/EC). The safety functions are certified by TÜV Nord and comply with the highest safety performance level (SIL 3/PL e) for machinery safety. It is possible to install the safety modules also afterwards to the drive.

PROFIsafe safety functions module FSPS-21

The FSPS-21 module has integrated PROFIsafe, safety functions and PROFINET IO connection. The ready-made safety functions make safety configuration in the drive unnecessary. The module supports STO and SS1-t safety functions. It is used together with a safety PLC that supports PROFIsafe over PROFINET communication.

For more information see FSPS-21 PROFIsafe safety functions module web page at new.abb.com/drives/functional-safety



Safe torque off (STO)

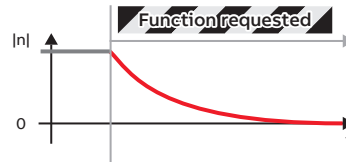

STO is the basic foundation of drive-based functional safety, as it brings a drive safely to no-torque state making the motor coast to stop. Integrated STO-function simplifies the safety circuit as external components are not needed to safely stop the application.

- **STO** is a standard safety function in all ABB drives.
- Typically used for prevention of an unexpected startup
- (EN ISO 14118) of machinery or for an emergency stop, fulfilling stop category 0 (EN 13850 / IEC 60204-1).

Safe stop 1, time controlled (SS1-t)

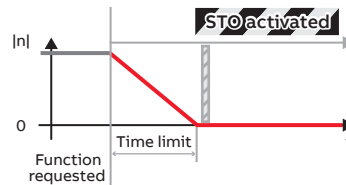

Safe stop 1 stops the motor safely with a controlled ramp stop and stop time monitoring. SS1-t initiates the ramp stop from the drive and activates STO when speed reaches zero. If the drive is not decelerating to zero speed within the time limit, the STO function is activated. SS1-t is typically used in applications where motion must be stopped quickly and safely before switching to a no-torque state.

- **SS1-t** stops the motor safely, using a controlled ramp stop and then activates the STO function.
- **SS1-t** can be used to implement an Emergency stop, fulfilling stop category 1 (EN/IEC 60204-1).



PROFIsafe safety functions module FSPS-21

Option code	Ordering code	Module
+Q986	3AXD50000112821	FSPS-21

Note: This module isn't compatible with other fieldbus option modules for ACS380 and ACS580 drives

Example: SS1-t

Safety function module FSPS-21, functionality cycle

0. Drive running

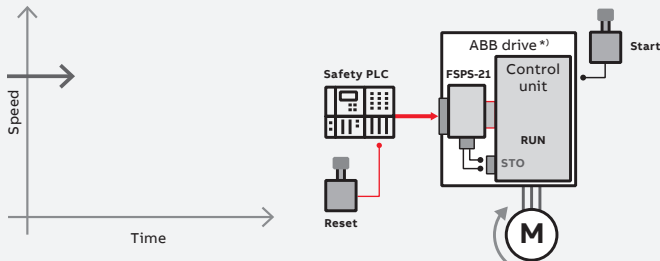

1. Safety PLC – safety function request to the FSPS-21

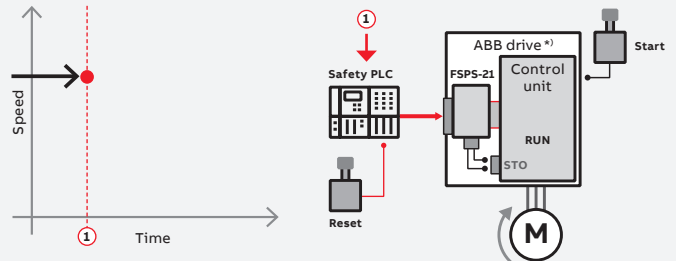

2. SS1-t, safety functions request / start of monitoring

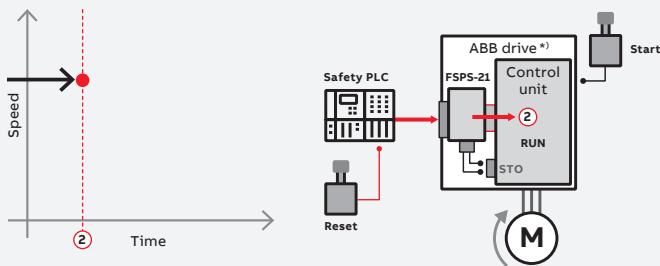

3. Transition and time monitoring of the SS1-t

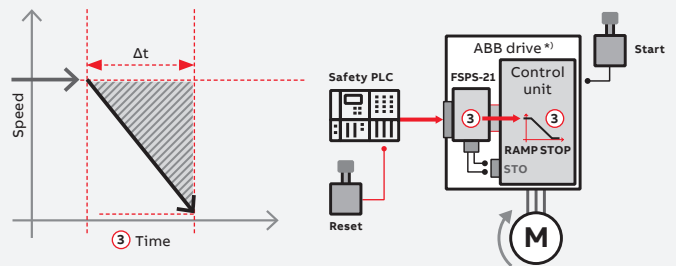

4. Zero speed or SS1-t time limit reached / STO is opened

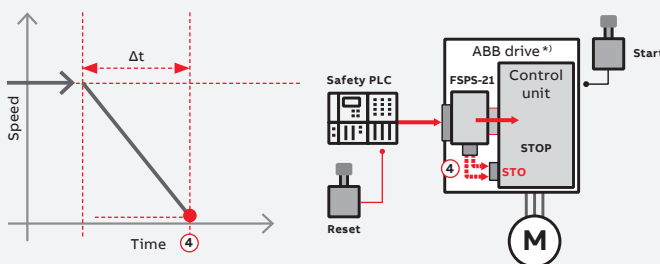

5. Safe state / STO is open

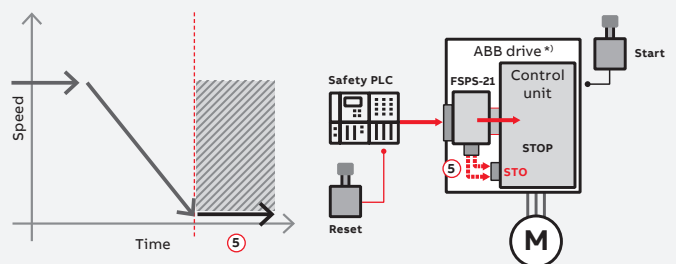

6. Safety function request removed / reset / STO is closed

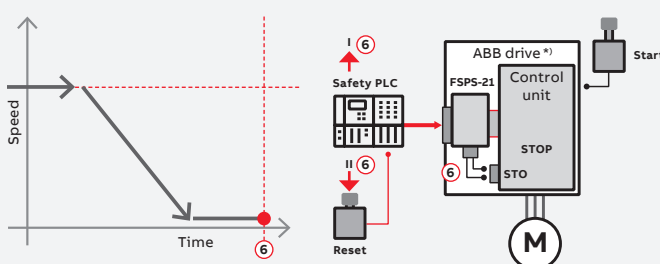

7. Start – return to normal operation

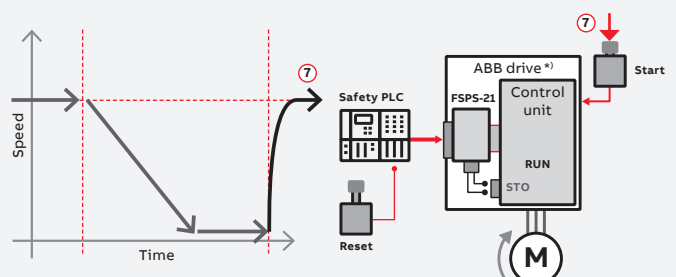

^{*)} The ABB drive can be ACS380, ACS580 or ACS880

I/O option modules



ACS380 drives can be ordered with different I/O configurations. The standard input and output of the drive can be extended by using I/O option modules. A BIO-01 module extends the configured variant's I/O, whereas a BMIO-01 module provides both additional I/O and Modbus. In case additional relay outputs are needed, they can be added with a BREL-01 module. A BAPO-01 module introduces an external 24 V DC supply to the drive's control circuits.

The ACS380 drive's open loop performance is sufficient for almost any application, even when accurate control is needed close to zero speed. However, if speed feedback is needed for even more accurate control or for active loads like hoists, a speed feedback module BTAC-02 adds support for TTL and HTL pulse encoders.

I/O option modules

Option code	Ordering code	Description	Module
+L511	3AXD5000022162	External relay option, 4 x RO (side option)	BREL-01
+L515	3AXD50000191635	I/O option (front option). Can be used together with fieldbus.	BIO-01
+L534	3AXD5000022164	External 24 V DC (side option)	BAPO-01
+L535	3AXD5000022163	HTL/TTL encoder interface + External 24 V DC (side option)	BTAC-02
+L538	3AXD5000021262	I/O & Modbus extension (front option)	BMIO-01

I/O	Base unit (ACS380-04xx)	BMIO-01 (ACS380-04xS)	BIO-01	BREL-01
Inputs				
Digital inputs	2 (DI1, DI2)	4 (DI3, DI4, DIO1, DIO2)	3 (DI3, DI4, DI5)	-
Frequency inputs	-	2 (DI3, DI4)	2 (DI4, DI5)	-
Counter inputs	-	1 (DI3)	1 (DI4)	-
Analog inputs	-	2 (AI1, AI2)	1 (AI1)	-
Outputs				
Relay outputs	1 (RO1)	-	-	4 (RO4, RO5, RO6, RO7)
Digital outputs	-	2 (DIO1, DIO2)	1 (DIO1)	-
Frequency outputs	-	2 (DIO1, DIO2)	1 (DIO1)	-
Analog outputs	-	1 (AO1)	1 (AO1)	-

Note: The number of inputs and outputs depends on the configuration. For example, DIO can be configured as digital input or output.

Resistor braking

Brake chopper

The brake chopper is built in as standard for the ACS380. It not only controls braking, but also supervises system status and detects failures such as brake resistor and resistor cable short-circuits, chopper short-circuit, and calculated resistor over-temperature. See the tables for internal brake chopper specifications for each drive type.

Brake resistor

The brake resistors are separately available for the ACS380. Resistors other than the standard option resistors may be used, provided that the specified resistance value is higher than the minimum resistance and that heat dissipation capacity of the resistor is sufficient for the drive application (see hardware manual). No separate fuses in the brake circuit are required if the conditions for the mains cable, for example, are protected with fuses and no mains cable/fuse overrating occurs.

Drive type	Frame size	Internal brake chopper				Example brake resistor	
		R_{\min} (ohm)	R_{\max} (ohm)	P_{BRcont} (kW)	P_{BRmax} (kW)	Danotherm type	
1-phase 230 V							
ACS380-04xx-02A4-1	R0	32.5	468	0.25	0.38	CBH 360 C T 406 210R, CAR 200 D T 406 210R	
ACS380-04xx-03A7-1	R0	32.5	316	0.37	0.56		
ACS380-04xx-04A8-1	R1	32.5	213	0.55	0.83	CBR-V 330 D T 406 78R UL	
ACS380-04xx-06A9-1	R1	32.5	145	0.75	1.10		
ACS380-04xx-07A8-1	R1	32.5	96.5	1.10	1.70	CBR-V 560 D HT 406 39R UL	
ACS380-04xx-09A8-1	R2	32.5	69.9	1.50	2.30		
ACS380-04xx-12A2-1	R2	19.5	47.1	2.20	3.30		
3-phase 230 V							
ACS380-04xx-02A4-2	R1	39	474	0.25	0.38	CBH 360 C T 406 210R, CAR 200 D T 406 210R	
ACS380-04xx-03A7-2	R1	39	319	0.37	0.56		
ACS380-04xx-04A8-2	R1	39	217	0.55	0.83	CBR-V 330 D T 406 78R UL	
ACS380-04xx-06A9-2	R1	39	145	0.75	1.13		
ACS380-04xx-07A8-2	R1	39	105	1.10	1.65	CBR-V 560 D HT 406 39R UL	
ACS380-04xx-09A8-2	R1	20	71	1.50	2.25		
ACS380-04xx-12A2-2	R2	20	52	2.20	3.30		
ACS380-04xx-17A5-2	R3	16	38	3.00	4.50	CBT-H 560 D HT 406 19R	
ACS380-04xx-25A0-2	R3	16	28	4.00	6.00		
ACS380-04xx-032A-2	R4	3	20	5.50	8.25	CBT-V 760 G H T 282 8R	
ACS380-04xx-048A-2	R4	3	14	7.50	11.25		
ACS380-04xx-055A-2	R4	3	10	11.00	16.50		
3-phase 400 V							
ACS380-04xx-01A8-4	R0	99	933	0.37	0.56	CBH 360 C T 406 210R, CAR 200 D T 406 210R	
ACS380-04xx-02A6-4	R1	99	628	0.55	0.83		
ACS380-04xx-03A3-4	R1	99	428	0.75	1.13	CBR-V 330 D T 406 78R UL	
ACS380-04xx-04A0-4	R1	99	285	1.10	1.65		
ACS380-04xx-05A6-4	R1	99	206	1.50	2.25	CBR-V 560 D HT 406 39R UL	
ACS380-04xx-07A2-4	R1	53	139	2.20	3.30		
ACS380-04xx-09A4-4	R1	53	102	3.00	4.50		
ACS380-04xx-12A6-4	R2	32	76	4.00	6.00	CBR-V 560 D HT 406 39R UL	
ACS380-04xx-17A0-4	R3	32	54	5.50	8.25		
ACS380-04xx-25A0-4	R3	23	39	7.50	11.25	CBT-H 560 D HT 406 19R	
ACS380-04xx-032A-4	R4	6	29	11.00	17.00		
ACS380-04xx-038A-4	R4	6	24	15.00	23.00	CBT-H 760 D HT 406 16R	
ACS380-04xx-045A-4	R4	6	20	18.50	28.00		
ACS380-04xx-050A-4	R4	6	20	22.00	33.00		

R_{\min} = The minimum permitted resistance value of the brake resistor

R_{\max} = The maximum resistance value of the brake resistor that can provide P_{BRcont}

P_{BRcont} = The continuous braking capacity of the drive

P_{BRmax} = The maximum braking capacity of the drive, when the length of the braking pulse is at most 1 minute for each 10 minutes ($P_{BRcont} \times 1.5$). The maximum braking capacity must be more than the desired braking power.

Example brake resistor → Check the allowed braking cycle from the resistor data sheet.

Please see the ACS380 hardware manual for the selection guidelines.

EMC – electromagnetic compatibility

The ACS380 machinery drives are equipped with a built-in filter to reduce high-frequency emissions. Low EMC filters (C3 for 400 V and C4 for 230 V) are denoted by type code ACS380-040X and high EMC filters (C2 for all voltages) by type code ACS380-042X. C1 can be achieved with an external EMC filter.

EMC standards

The EMC product standard (EN 61800-3) covers the specific EMC requirements stated for drives (tested with motor and cable) within the EU. EMC standards such as EN 55011 or EN 61000-6-3/4 are applicable to industrial and domestic equipment and systems including components inside the drive. Drive units complying with the requirements of EN 61800-3 are compliant with comparable categories

in EN 55011 and EN 61000-6-3/4, but not necessarily vice versa. EN 55011 and EN 61000-6-3/4 do not specify cable length or require a motor to be connected as a load. The emission limits are comparable to EMC standards according to the table below.

Domestic environments versus public low voltage networks

The first environment includes domestic premises. It also includes establishments directly connected without an intermediate transformer to a low voltage power supply network that supplies buildings used for domestic purposes. The second environment includes all establishments directly connected to public low voltage power supply networks.

Comparison of EMC standards				
EMC according to EN 61800-3 product standard	EN 61800-3 product standard	EN 55011, product family standard for industrial, scientific and medical (ISM) equipment	EN 61000-6-4, generic emission standard for industrial environments	EN 61000-6-3, generic emission standard for residential, commercial and light-industrial environments
1 st environment, unrestricted distribution	Category C1	Group 1, Class B	Not applicable	Applicable
1 st environment, restricted distribution	Category C2	Group 1, Class A	Applicable	Not applicable
2 nd environment, unrestricted distribution	Category C3	Group 2, Class A	Not applicable	Not applicable
2 nd environment, restricted distribution	Category C4	Not applicable	Not applicable	Not applicable

EMC compliance and maximum motor cable length				
Voltage (Product variant)	Frame size	EMC category (EN 61800-3), max. motor cable length		
		C1	C2	C3
With internal / external filter				
1-phase 230 V (ACS380-04xx-xxxx-1)	R0			
	R1	- / 10 m	10 m / 10 m	10 m / 10 m
	R2	- / -	10 m / -	10 m / -
3-phase 230 V (ACS380-04xx-xxxx-2)	R1			
	R2	- / -	- / 20 m	- / 20 m
	R3			
3-phase 400 V (ACS380-04xx-xxxx-4)	R4			
	R0	- / 30 m	10 m / 30 m	30 m / 30 m
	R1			30 m / 40 m
	R2	- / 40 m	10 m / 40 m	20 m / 40 m
	R3			30 m / 40 m
	R4	- / 30 m	10 m / 30 m	30 m / 30 m

• Internal filter: C2 with ACS380-042x-xxxx-x, C3 with ACS380-040x-xxxx-4

• External filter: Please see page 29 Filters and chokes for the suitable external filter type

Filters and chokes

It is advisable to use a mains choke if the short-circuit capacity of the network at the drive terminals is higher than specified in the table.

Frame size /voltage rating	R0, R1, R2	R3, R4
1-phase 230 V	>5.0 kA	>7.5 kA
3-phase 230 V	>5.0 kA	>7.5 kA
3-phase 380...480 V	>5.0 kA	>10 kA

1-phase $U_N = 230$ V (range 200 to 240 V)

Drive type	Frame size	C1 filter ABB type / Schaffner type	Mains choke Max. ambient temp. 40 °C	du/dt filter Max. ambient temp. 40 °C
ACS380-04xx-02A4-1	R0	RFI-11 / FN21754-6.1-07	CHK-A1	ACS-CHK-B3
ACS380-04xx-03A7-1	R0	RFI12 / FN21754-16.1-07	CHK-B1	ACS-CHK-B3
ACS380-04xx-04A8-1	R1	RFI12 / FN21754-16.1-07	CHK-B1	ACS-CHK-B3
ACS380-04xx-06A9-1	R1	RFI12 / FN21754-16.1-07	CHK-C1	ACS-CHK-C3
ACS380-04xx-07A8-1	R1	RFI12 / FN21754-16.1-07	CHK-C1	ACS-CHK-C3
ACS380-04xx-09A8-1	R2	–	CHK-D1	ACS-CHK-C3
ACS380-04xx-12A2-1	R2	–	CHK-D1	ACS-CHK-C3

3-phase $U_N = 230$ V (range 200 to 240 V)

Drive type	Frame size	C1 filter ABB type / Schaffner type	Mains choke Max. ambient temp. 40 °C	du/dt filter Max. ambient temp. 40 °C
ACS380-04xx-02A4-2	R1	RFI 32 / FN 3258-16-44	CHK-01	–
ACS380-04xx-03A7-2	R1	RFI 32 / FN 3258-16-44	CHK-02	–
ACS380-04xx-04A8-2	R1	RFI 32 / FN 3258-16-44	CHK-03	–
ACS380-04xx-06A9-2	R1	RFI 32 / FN 3258-16-44	CHK-03	–
ACS380-04xx-07A8-2	R1	RFI 32 / FN 3258-16-44	CHK-03	–
ACS380-04xx-09A8-2	R1	RFI 32 / FN 3258-16-44	CHK-04	–
ACS380-04xx-12A2-2	R2	RFI-33 / FN 3258-30-33	CHK-04	–
ACS380-04xx-17A5-2	R3	RFI-33 / FN 3258-30-33	CHK-04	–
ACS380-04xx-25A0-2	R3	RFI-33 / FN 3258-30-33	CHK-06	–
ACS380-04xx-032A-2	R4	RFI-34 / FN3258-100-35	CHK-06	–
ACS380-04xx-048A-2	R4	RFI-34 / FN3258-100-35	CHK-07	–
ACS380-04xx-055A-2	R4	RFI-34 / FN3258-100-35	CHK-07	–

3-phase $U_N = 400$ V (range 380 to 480 V)

Drive type	Frame size	C1 filter ABB type / Schaffner type	Mains choke Max. ambient temp. 40 °C	du/dt filter Max. ambient temp. 40 °C
ACS380-04xx-01A8-4	R0	RFI 32 / FN 3258-16-44	CHK-01	ACS-CHK-B3
ACS380-04xx-02A6-4	R1	RFI 32 / FN 3258-16-44	CHK-01	ACS-CHK-B3
ACS380-04xx-03A3-4	R1	RFI 32 / FN 3258-16-44	CHK-01	ACS-CHK-B3
ACS380-04xx-04A0-4	R1	RFI 32 / FN 3258-16-44	CHK-02	ACS-CHK-C3
ACS380-04xx-05A6-4	R1	RFI 32 / FN 3258-16-44	CHK-02	ACS-CHK-C3
ACS380-04xx-07A2-4	R1	RFI 32 / FN 3258-16-44	CHK-02	NOCH0016-6x
ACS380-04xx-09A4-4	R1	RFI 32 / FN 3258-16-44	CHK-03	NOCH0016-6x
ACS380-04xx-12A6-4	R2	RFI-33 / FN 3258-30-33	CHK-03	NOCH0016-6x
ACS380-04xx-17A0-4	R3	RFI-33 / FN 3258-30-33	CHK-04	NOCH0030-6x
ACS380-04xx-25A0-4	R3	RFI-34 / FN3258-100-35	CHK-04	NOCH0030-6x
ACS380-04xx-032A-4	R4	RFI-34 / FN3258-100-35	CHK-05	NOCH0030-6x
ACS380-04xx-038A-4	R4	RFI-34 / FN3258-100-35	CHK-06	NOCH0070-6x
ACS380-04xx-045A-4	R4	RFI-34 / FN3258-100-35	CHK-06	NOCH0070-6x
ACS380-04xx-050A-4	R4	RFI-34 / FN3258-100-35	CHK-07	NOCH0070-6x

Cooling, fuses and circuit breakers

Cooling

ACS380 drives are fitted with variable-speed cooling air fans. The cooling air must be free from corrosive materials and must not exceed the maximum ambient temperature of 50 °C (60 °C with derating).*)

Fuse and circuit breakers

Standard fuses and circuit breakers can be used with the ACS380 drives. For input fuse or circuit breaker specifications, see the table below. Manual motor protectors can also be used. See ACS380 hardware manual for details.

Cooling air flow and recommended input protection fuses

1-phase $U_N = 230\text{ V}$ (range 200 to 240 V)

Drive type	Frame size	Typical power loss ¹⁾		Air flow (m ³ /h)	Noise		IEC fuses		IEC fuses		UL fuses	
		(W)	BTU/Hr		CFM	(dBA)	(A)	Fuse type	(A)	Fuse type	(A)	Fuse type
ACS380-04xx-02A4-1	R0	33	113	–*)	–	–	10	gG	32	gR	10	UL class T
ACS380-04xx-03A7-1	R0	49	167	–*)	–	–	10	gG	32	gR	10	UL class T
ACS380-04xx-04A8-1	R1	67	229	57	33	63	16	gG	40	gR	20	UL class T
ACS380-04xx-06A9-1	R1	93	317	57	33	63	20	gG	50	gR	20	UL class T
ACS380-04xx-07A8-1	R1	106	362	57	33	63	25	gG	63	gR	25	UL class T
ACS380-04xx-09A8-1	R2	92	314	63	37	59	32	gG	63	gR	25	UL class T
ACS380-04xx-12A2-1	R2	115	392	63	37	59	35	gG	63	gR	35	UL class T

3-phase, $U_N = 230\text{ V}$ (range 200 to 240 V)

ACS380-04xx-02A4-2	R1	39	133	57	33	63	6	gG	25	gR	6	UL class T
ACS380-04xx-03A7-2	R1	57	194	57	33	63	10	gG	32	gR	10	UL class T
ACS380-04xx-04A8-2	R1	72	246	57	33	63	10	gG	32	gR	10	UL class T
ACS380-04xx-06A9-2	R1	111	379	57	33	63	16	gG	40	gR	20	UL class T
ACS380-04xx-07A8-2	R1	105	358	57	33	63	16	gG	40	gR	20	UL class T
ACS380-04xx-09A8-2	R1	140	478	57	33	63	16	gG	40	gR	20	UL class T
ACS380-04xx-12A2-2	R2	149	508	63	37	59	25	gG	50	gR	25	UL class T
ACS380-04xx-17A5-2	R3	265	904	128	75	66	32	gG	63	gR	35	UL class T
ACS380-04xx-25A0-2	R3	398	1358	128	75	66	50	gG	80	gR	40	UL class T
ACS380-04xx-032A-2	R4	350	1194	150	88	69	63	gG	100	gR	60	UL class T
ACS380-04xx-048A-2	R4	561	1914	150	88	69	100	gG	160	gR	100	UL class T
ACS380-04xx-055A-2	R4	676	2307	150	88	69	100	gG	160	gR	100	UL class T

3-phase $U_N = 400\text{ V}$ (range 380 to 480 V)

ACS380-04xx-01A8-4	R0	28	96	–	–	–	4	gG	25	gR	6	UL class T
ACS380-04xx-02A6-4	R1	44	150	57	33	63	6	gG	25	gR	6	UL class T
ACS380-04xx-03A3-4	R1	55	188	57	33	63	6	gG	25	gR	6	UL class T
ACS380-04xx-04A0-4	R1	62	212	57	33	63	10	gG	32	gR	10	UL class T
ACS380-04xx-05A6-4	R1	91	311	57	33	63	10	gG	32	gR	10	UL class T
ACS380-04xx-07A2-4	R1	100	341	57	33	63	16	gG	40	gR	20	UL class T
ACS380-04xx-09A4-4	R1	140	478	57	33	63	16	gG	40	gR	20	UL class T
ACS380-04xx-12A6-4	R2	165	563	63	37	59	25	gG	50	gR	25	UL class T
ACS380-04xx-17A0-4	R3	259	884	128	75	66	32	gG	63	gR	35	UL class T
ACS380-04xx-25A0-4	R3	390	1331	128	75	66	50	gG	80	gR	40	UL class T
ACS380-04xx-032A-4	R4	396	1351	150	88	69	63	gG	100	gR	60	UL class T
ACS380-04xx-038A-4	R4	497	1696	150	88	69	80	gG	125	gR	80	UL class T
ACS380-04xx-045A-4	R4	582	1986	150	88	69	100	gG	160	gR	100	UL class T
ACS380-04xx-050A-4	R4	672	2293	150	88	69	100	gG	160	gR	100	UL class T

¹⁾ Typical drive losses when it operates at 90% of the motor nominal frequency and 100% of the drive nominal output current.

The miniature circuit breakers listed below are tested and approved for use with the ACS380 drives.
Other circuit breakers can also be used with the drive if they provide the same electrical characteristics.

Circuit breakers				
1-phase $U_N = 230\text{ V}$ (range 200 to 240 V)				
Drive type	Frame size	ABB miniature circuit breaker		
		Type	(kA) ¹⁾	
ACS380-04xx-02A4-1	R0	S 201P-B 10 NA		5
ACS380-04xx-03A7-1	R0	S 201P-B 10 NA		5
ACS380-04xx-04A8-1	R1	S 201P-B 16 NA		5
ACS380-04xx-06A9-1	R1	S 201P-B 20 NA		5
ACS380-04xx-07A8-1	R1	S 201P-B 25 NA		5
ACS380-04xx-09A8-1	R2	S 201P-B 25 NA		5
ACS380-04xx-12A2-1	R2	S 201P-B 32 NA		5
3-phase, $U_N = 230\text{ V}$ (range 200 to 240 V)				
ACS380-04xx-02A4-2	R1	S 203P-Z 6 NA		5
ACS380-04xx-03A7-2	R1	S 203P-Z 8 NA		5
ACS380-04xx-04A8-2	R1	S 203P-Z 10 NA		5
ACS380-04xx-06A9-2	R1	S 203P-Z 16 NA		5
ACS380-04xx-07A8-2	R1	S 203P-Z 16 NA		5
ACS380-04xx-09A8-2	R1	S 203P-Z 25 NA		5
ACS380-04xx-12A2-2	R2	S 203P-Z 25 NA		5
ACS380-04xx-17A5-2	R3	S 203P-Z 32 NA		5
ACS380-04xx-25A0-2	R3	S 203P-Z 50 NA		5
ACS380-04xx-032A-2	R4	S 203P-Z 63 NA		5
ACS380-04xx-048A-2	R4	-		-
ACS380-04xx-055A-2	R4	-		-
3-phase $U_N = 380...480\text{ V}$ (380, 400, 415, 440, 460, 480 V)				
ACS380-04xx-01A8-4	R0	S 203P-B 4		5
ACS380-04xx-02A6-4	R1	S 203P-B 6		5
ACS380-04xx-03A3-4	R1	S 203P-B 6		5
ACS380-04xx-04A0-4	R1	S 203P-B 8		5
ACS380-04xx-05A6-4	R1	S 203P-B 10		5
ACS380-04xx-07A2-4	R1	S 203P-B 16		5
ACS380-04xx-09A4-4	R1	S 203P-B 16		5
ACS380-04xx-12A6-4	R2	S 203P-B 25		5
ACS380-04xx-17A0-4	R3	S 203P-B 32		5
ACS380-04xx-25A0-4	R3	S 203P-B 50		5
ACS380-04xx-032A-4	R4	S 203P-B 63		5
ACS380-04xx-038A-4	R4	S 803S-B 80		5
ACS380-04xx-045A-4	R4	S 803-B 100		5
ACS380-04xx-050A-4	R4	S 803-B 100		5

¹⁾ Maximum permitted rated conditional short-circuit current (IEC 61800-5-1) of the electrical power network.



ACS380 drives are compatible with the wide ABB product offering



Programmable Logic Controllers, PLCs

The AC500, AC500-eCo, AC500-S and AC500-XC scalable PLC ranges provide solutions for small, medium and high-end applications. Our AC500 PLC platform offers different performance levels and is the ideal choice for high availability, extreme environments, condition monitoring, motion control or safety solutions.



All-compatible drives portfolio

The all-compatible drives share the same architecture: software platform, tools, user interfaces and options. There is an optimal drive from the smallest water pump to the biggest cement kiln, and everything in between.



AC motors

ABB's low voltage AC motors are designed to save energy, reduce operating costs and minimize unscheduled downtime. General performance motors ensure convenience, while process performance motors provide a broad set of motors for the process industries and heavy-duty applications.



Automation Builder Engineering suite

ABB Automation Builder is the software for machine builders and system integrators wanting to automate their machines and systems in a unified and efficient way. Automation Builder connects the engineering tools for PLC, safety, control panels, SCADA, drives, motion and robots.



Control panels

CP600-eCo, CP600 and CP600-Pro control panels offer a wide range of features and functionalities for maximum operability. ABB control panels are distinguished by their robustness and high usability, providing all the relevant information from production plants and machines at a single touch.



ABB Jokab Safety

ABB Jokab Safety is helping machine builders to create production-friendly and safe work environments for operators. We deliver machine safety solutions for single machines or entire production lines. Our long experience of helping customers making solutions for demanding environments has made us experts in combining production demands with safety demands for production-friendly solutions.

Choose the right motor for your application

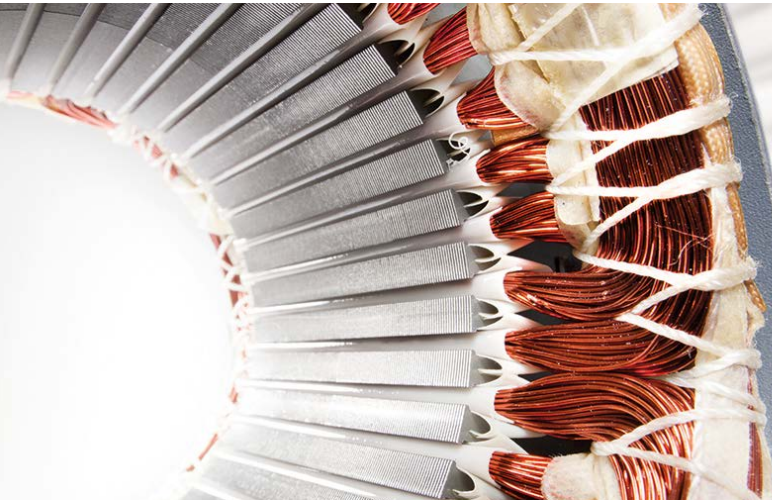

Choose the best motor for your application. A natural match for induction motors, ABB machinery drives can also control high-efficiency motors such as permanent magnet or synchronous reluctance motors for greater efficiency.

Induction motors, the industry workhorse

Pair the ACS380 with an induction motor (IM) for simple and reliable operation in many applications and in a wide range of environments. Further simplifying setup, the machinery drives can be integrated with virtually any type of IM by entering the nameplate motor data only.



Permanent magnet motors for smooth operation

Permanent magnet technology is used for improved motor characteristics in terms of energy efficiency and compactness. This technology is particularly well-suited for low speed control applications, as they eliminate the need to use gear boxes. Even without speed or rotor position sensors, the ACS380 drives control most types of permanent magnet motors.

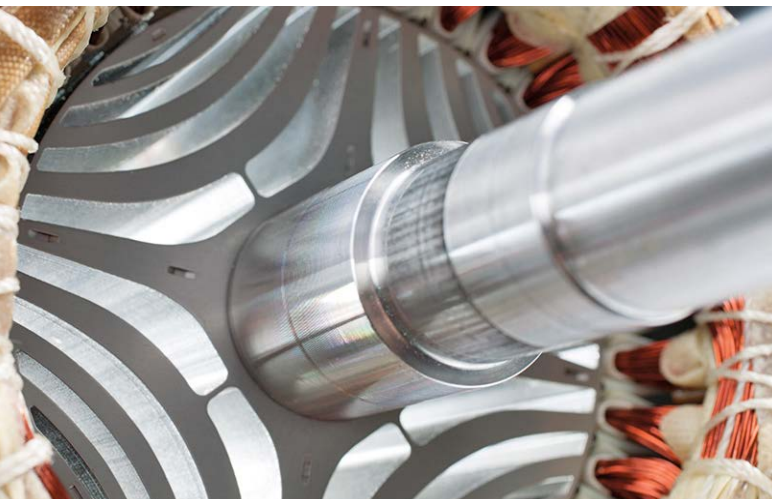

IE5 SynRM for optimized energy efficiency

Combining ABB's machinery drive control technology with our synchronous reluctance motors will give you a motor and a drive package that ensures high energy efficiency, reduces motor temperatures, and provides a significant reduction in motor noise. The key is in the efficiency-optimized rotor design of our SynRM motors.

Synchronous reluctance motors

Ultimate efficiency and reliability to optimize your cost of ownership



Traditional induction motor



IE5 SynRM motor

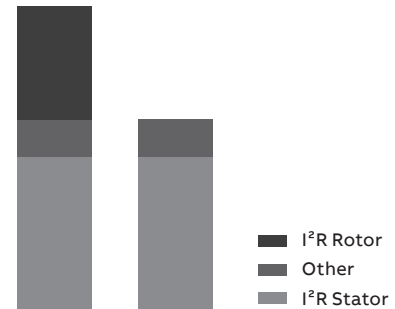

Losses IM vs SynRM

Innovation inside

The idea is simple. Take a conventional, proven stator technology and an innovative rotor design. Then combine them with an ABB machinery drive loaded with software with versatile features. Finally, optimize the whole package for applications such as compressors, conveyors, pumps, extruders, fans and many other variable and constant torque applications.

Magnet-free design

Synchronous reluctance technology combines the performance of a permanent magnet motor with the simplicity and service-friendliness of an induction motor. The new rotor has neither magnets nor windings, and suffers virtually no power losses. And because there are no magnetic forces in the rotor, maintenance is as straightforward as with induction motors.

Superior reliability to minimize the cost of not running

International Efficiency class IE5 synchronous reluctance motors (SynRM) have very low winding temperatures, which increases the reliability and lifetime of the winding. More importantly, a cool synchronous reluctance rotor means significantly lower bearing temperatures – an important factor because bearing failures cause about 70 percent of unplanned motor outages.

Perfect for retrofits

The SynRM package is a perfect solution for motor retrofits. The IE5 SynRM is the same size as an IE3 induction motor, eliminating the need for mechanical modifications. The increased efficiency will, on the other hand, reduce the payback time of the investment.

Full motor control, down to zero speed

Many processes require accurate speed control. SynRM always runs at reference speed with practically no error, without an encoder. Even the best slip compensation systems in an induction motor inverter will never match the precision of SynRM. Sometimes your application may require you to run your motor at slow speeds. If you are using SynRM and your drive cannot provide the necessary torque, it may trip. ABB drives provide full control and torque down to zero speed, even without speed sensors.

For all applications

This is important if you are planning on using the motor with applications other than quadratic torque applications like pumps and fans. Our drives provide full SynRM motor control for constant torque applications such as extruders, conveyors and wire drawing machines.

SynRM technology	Benefit
Higher efficiency IE5	Lowest energy consumption
No rare earth metals	Environmental sustainability
Magnet-free rotor	Easy service
Lower winding and bearing temperatures	Longer life time, extended service intervals
Better controllability	Accurate speed and torque control
Lower noise level	Better working and living environment
Same size with IE3	Perfect for retrofits



Drivetune mobile application for wireless access

User-friendly experience with Bluetooth connectivity.

Drivetune mobile app is a powerful tool for performing basic drive startup and troubleshooting tasks. It is possible to connect with drives and access data available in the Internet at the same time. The wireless Bluetooth

connectivity means that users won't need to enter hazardous or difficult-to-reach work areas to access information necessary to help them commission and tune the drive.



Startup, commission and tune your drive and application with full parameter access

Optimize performance via drive troubleshooting features

Create and share backups and support packages

Keep track of drives installed base

ABB Ability™ Mobile Connect for drives is a module in the Drivetune app. It gives you the access to the technical support for fast problem solving. Mobile Connect makes all the necessary data instantly available to the expert, providing support.

Remote and rapid access to ABB's drive experts can save you and your team considerable time, money and headaches. Check Mobile Connect availability in your country.

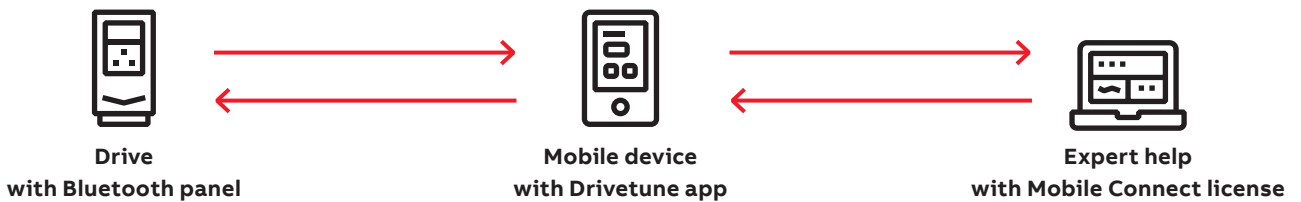

Download Drivetune



Drivetune for commissioning and managing drives

ABB SmartGuide – ACS380

Being one of the handiest ways to get short and clear visual instructions on drive installation, startup and operation.

Mobile friendly digital user guides provide simple and animated step-by-step instructions to assist with wall mounting of drives, electrical installation and drive programming. The content is frequently updated and further developed, making it your comprehensive source of instructions and help.

Scan the QR code and test it yourself!

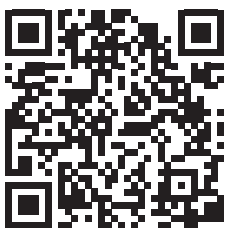
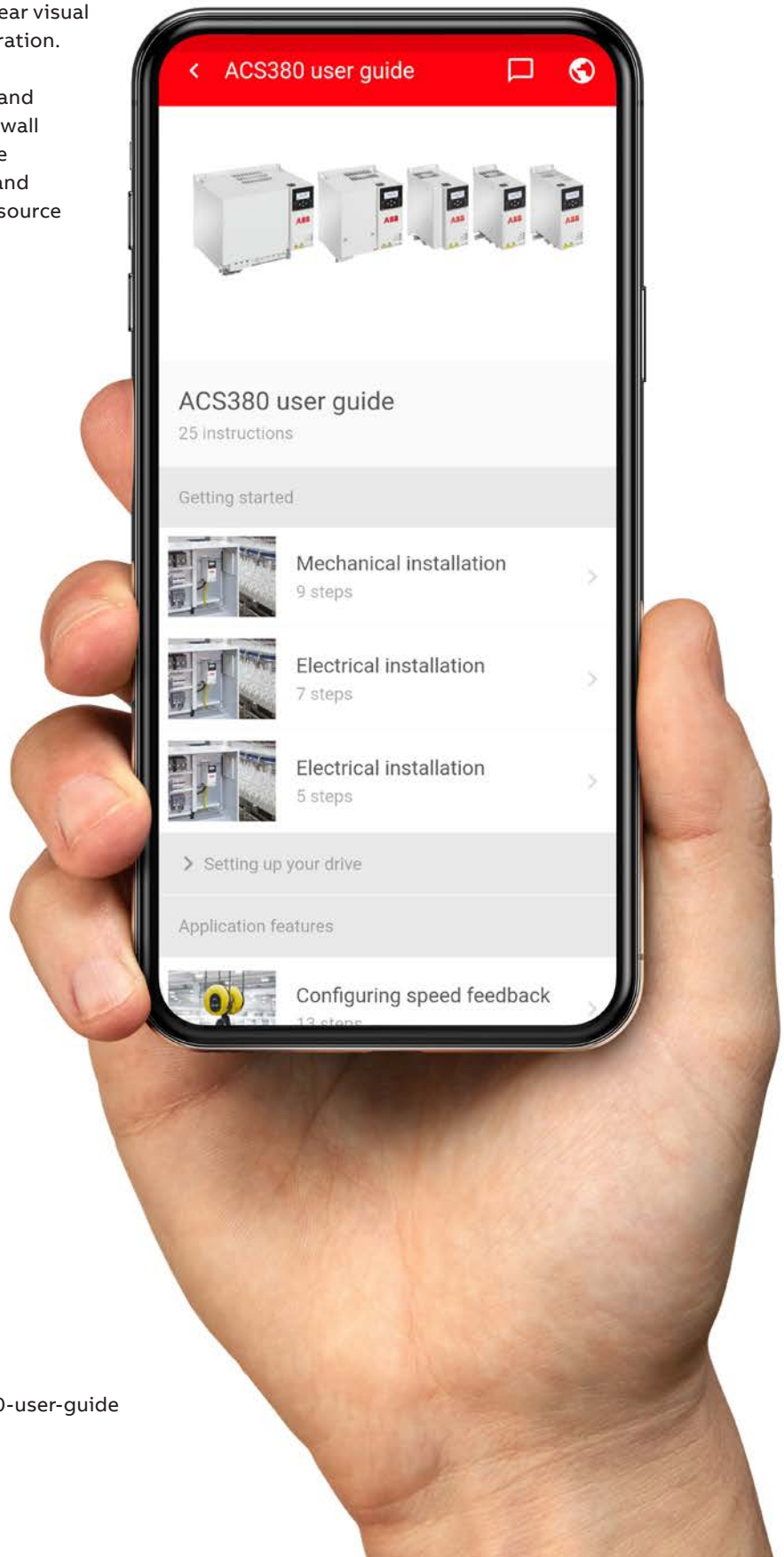

<https://drives-abb.swipeguide.com/guide/acs380-user-guide>
<https://drives-abb.swipeguide.com/>

Our service expertise, your advantage

ABB Motion Services helps customers around the globe by maximizing uptime, extending product life cycle, and enhancing the performance and energy efficiency of electrical motion solutions. We enable innovation and success through digitalization by securely connecting and monitoring your motors and drives, increasing reliability and improving efficiency.

Even before you consider buying a drive or motor, ABB's experts are on hand to provide technical solutions ranging from advisory to modernization and performance improvement services, giving you peace of mind and transparency into your cost of ownership throughout the asset's economical lifetime.

When you've decided on the right product, ABB and its global network of Value Providers can help with installation and commissioning. They are also on hand to support you

throughout the operations and maintenance phases of the products life cycle, providing planned services programs customized to your operations.

With a service offering tailored to your needs, service experts can maximize the uptime and extend the life cycle of your powertrain, while optimizing its performance and maximizing your energy efficiency gains across the entire lifetime of your applications. Service helps keep your applications turning profitably, safely, and reliably.



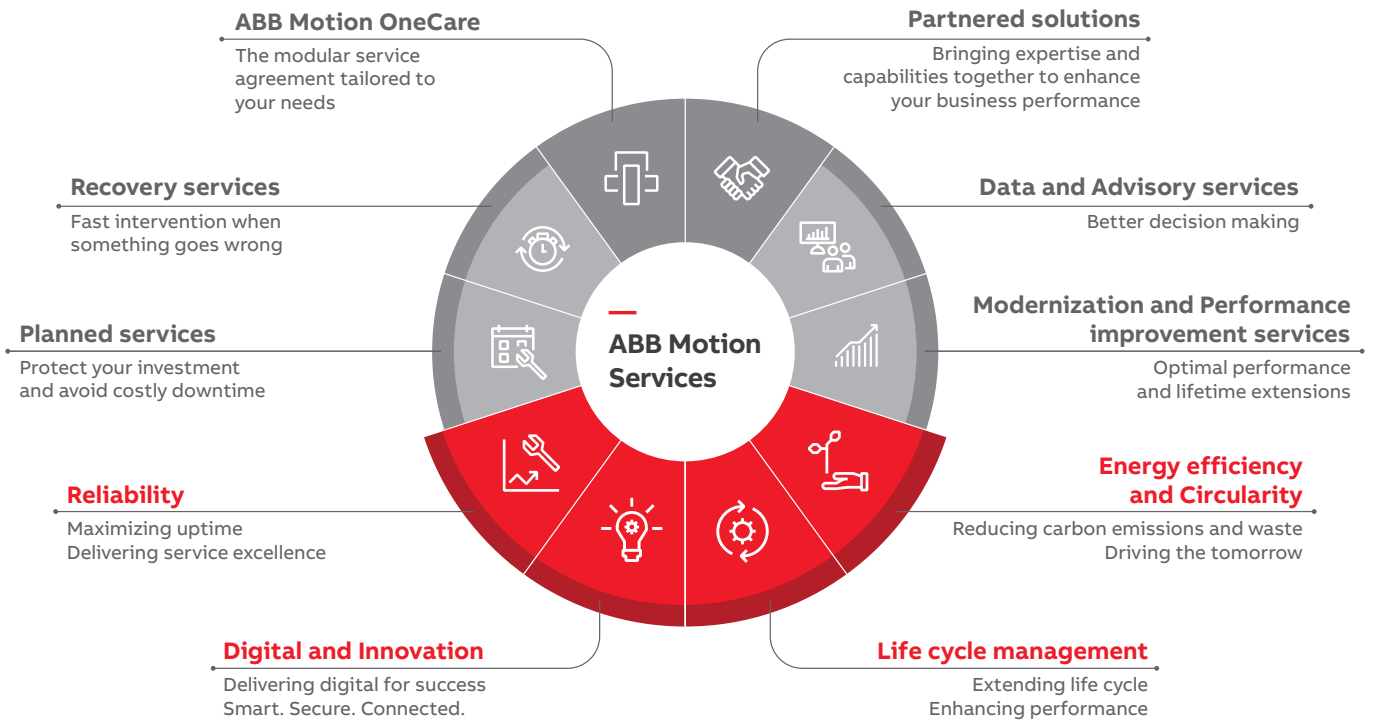

OUR EXPERTISE
YOUR ADVANTAGE



ABB Drives Life Cycle Management

A life time of peak performance

You're in control of every life cycle phase of your drives. At the heart of drive services is a four-phase product life cycle management model. This model defines the services recommended and available throughout drives lifespan.

We notify you every step of the way. Your benefit is clear information about your drives' status and precise services available. It helps you plan service actions ahead of time and make sure that continuous support is always available.

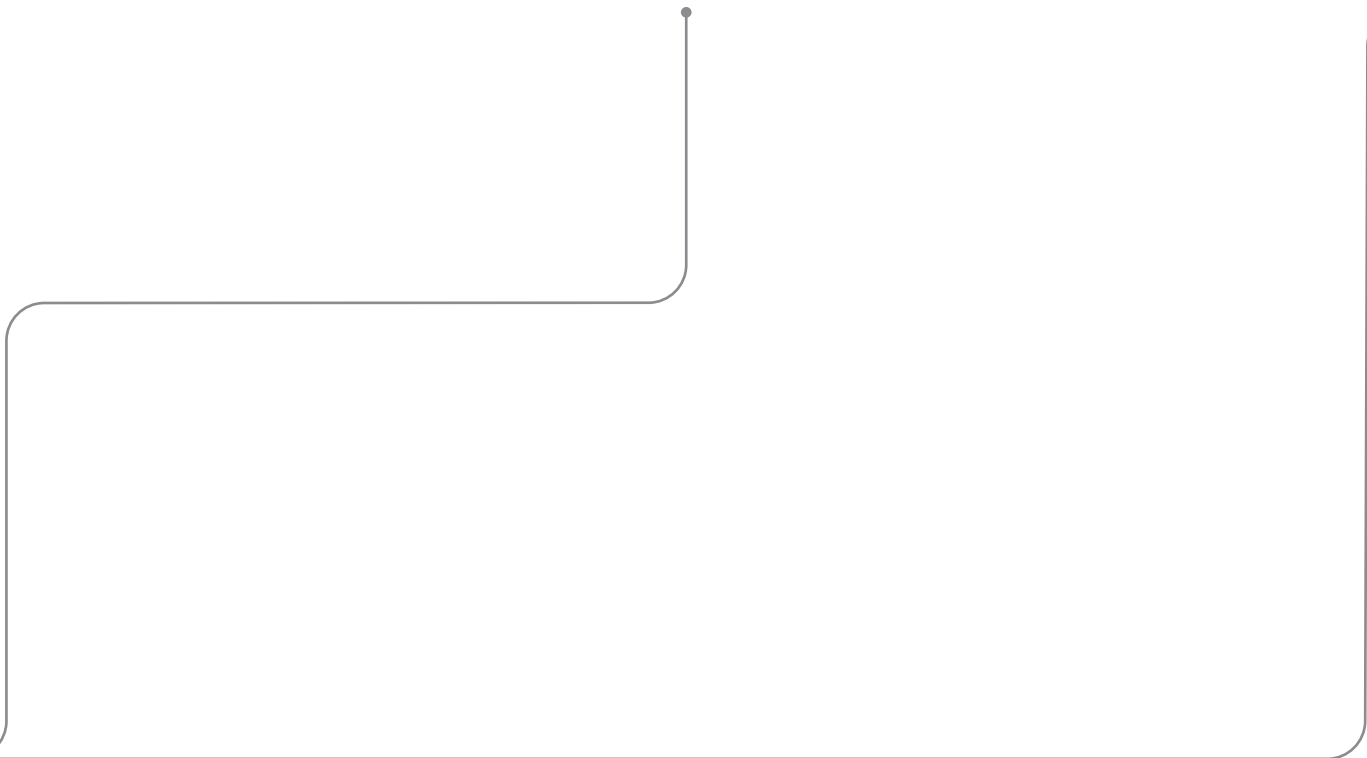
Now it's easy for you to see the exact service and maintenance available for your drives.

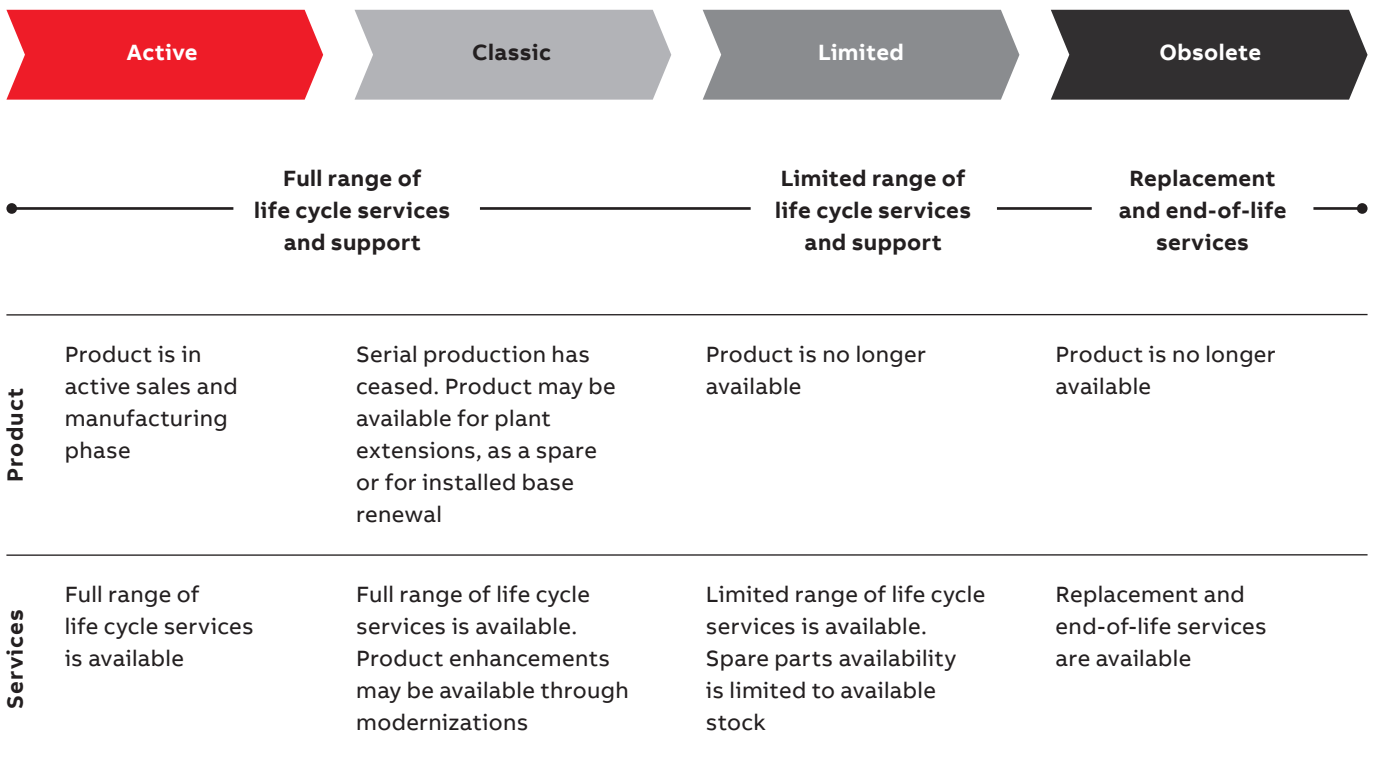

Keeping you informed throughout the life cycle

We notify you every step of the way using life cycle status statements and announcements.

Your benefit is clear information about your drives' status and precise services available. It helps you plan the preferred service actions ahead of time and make sure that continuous support is always available.

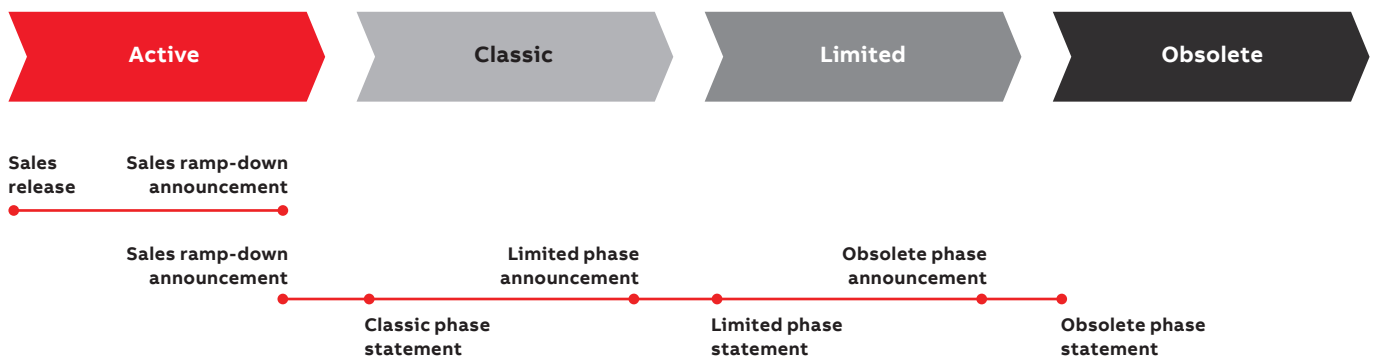

Sales release

Details about product portfolio and release schedule.

Sales ramp down announcement

Last time buy and last deliveries dates, informed well in advance.

Life cycle phase change announcement

Early information about the upcoming life cycle phase change and affects on the service availability. Informed well in advance, minimum six months prior to the change.

Life cycle phase statement

Information about the current life cycle status, product and services availability and recommended actions. Plan for the next life cycle phase transition.



—
For more information, please contact
your local ABB representative or visit

new.abb.com/drives
new.abb.com/drives/drivespartners
new.abb.com/motors-generators

Learn more
from ACS380 website



Online manuals
for the ACS380 drives



X-ON Electronics

Largest Supplier of Electrical and Electronic Components

Click to view similar products for [Motor Drives](#) category:

Click to view products by [ABB](#) manufacturer:

Other Similar products are found below :

[GMA02](#) [R7DBP02L](#) [1300920283](#) [GMA20](#) [R88ACRKN020CRE](#) [R88DUA03LAAC100V30W](#) [R88DUP03LAAC100V30W](#)
[MFECA0050EAM](#) [MFECA0030EAM](#) [1300920078](#) [R88D-GT04H](#) [R88D-KT01H](#) [R7D-BP01H](#) [R88ACR1A005CF](#) [R88D1SN04HECT](#)
[R88D1SN08HECT](#) [R88ACR1A003CFRA](#) [3G3MX2-AB002-E](#) [KLC35BE](#) [R88A-CA1A010B](#) [ST10-IP-EE](#) [ST10-Q-RN](#) [103H7121-0410P](#)
[103H7123-0440P](#) [103H7126-0740P](#) [103H7126-5740P](#) [103H7823-5740P](#) [SMCV6150](#) [U-PKZ0\(480V60HZ\)](#) [ODE-3-120070-1F1A-01](#) [ODE-](#)
[3-240041-3F4B](#) [ODE-3-120070-1F1B-01](#) [132B0107](#) [68581737](#) [68469422](#) [3AUA0000089109](#) [ODE-3-220105-1F4B](#) [1SFA897103R7000](#)
[3AUA0000058190](#) [68581974](#) [68581796](#) [MCD 201-007-T4-CV1](#) [3AXD50000031889](#) [ATS22D17Q](#) [3AXD50000716630](#) [3AUA0000058169](#)
[ATV610U55N4](#) [ATV310H075N4E](#) [3AXD50000047768](#) [3AUA0000058167](#)