

V_{DRM}	=	2500 V
I_{TGQM}	=	1500 A
I_{TSM}	=	10×10^3 A
V_{T0}	=	1.45 V
r_T	=	0.90 mW
V_{Dclink}	=	1400 V

Asymmetric Gate turn-off Thyristor 5SGA 15F2502

Doc. No. 5SYA1214-02 Oct. 06

- Patented free-floating silicon technology
- Low on-state and switching losses
- Annular gate electrode
- Industry standard housing
- Cosmic radiation withstand rating

Blocking

Maximum rated values ¹⁾

Parameter	Symbol	Conditions	min	typ	max	Unit
Repetitive peak off-state voltage	V_{DRM}	$V_{GR} \geq 2$ V			2500	V
Repetitive peak reverse voltage	V_{RRM}				17	V
Permanent DC voltage for 100 FIT failure rate	$V_{DC-link}$	Ambient cosmic radiation at sea level in open air.			1400	V

Characteristic values

Parameter	Symbol	Conditions	min	typ	max	Unit
Repetitive peak off-state current	I_{DRM}	$V_D = V_{DRM}, V_{GR} \geq 2$ V			100	mA
Repetitive peak reverse current	I_{RRM}	$V_R = V_{RRM}, R_{GK} = \infty \Omega$			50	mA

Mechanical data

Maximum rated values ¹⁾

Parameter	Symbol	Conditions	min	typ	max	Unit
Mounting force	F_m		14	15	16	kN

Characteristic values

Parameter	Symbol	Conditions	min	typ	max	Unit
Pole-piece diameter	D_p	± 0.1 mm		47		mm
Housing thickness	H		25.8		26.2	mm
Weight	m				0.6	kg
Surface creepage distance	D_s	Anode to Gate	25			mm
Air strike distance	D_a	Anode to Gate	15			mm

Note 1 Maximum rated values indicate limits beyond which damage to the device may occur

ABB Switzerland Ltd, Semiconductors reserves the right to change specifications without notice.



GTO Data

On-state

Maximum rated values ¹⁾

Parameter	Symbol	Conditions	min	typ	max	Unit
Max. average on-state current	$I_{T(AV)M}$	Half sine wave, $T_C = 85\text{ °C}$			570	A
Max. RMS on-state current	$I_{T(RMS)}$				900	A
Max. peak non-repetitive surge current	I_{TSM}	$t_p = 10\text{ ms}$, $T_{vj} = 125\text{ °C}$, sine wave After Surge: $V_D = V_R = 0\text{ V}$			10×10^3	A
Limiting load integral	I^2t				500×10^3	A ² s
Max. peak non-repetitive surge current	I_{TSM}	$t_p = 1\text{ ms}$, $T_{vj} = 125\text{ °C}$, sine wave After Surge: $V_D = V_R = 0\text{ V}$			20×10^3	A
Limiting load integral	I^2t				200×10^3	A ² s

Characteristic values

Parameter	Symbol	Conditions	min	typ	max	Unit
On-state voltage	V_T	$I_T = 1500\text{ A}$, $T_{vj} = 125\text{ °C}$			2.8	V
Threshold voltage	$V_{(T0)}$	$T_{vj} = 125\text{ °C}$			1.45	V
Slope resistance	r_T	$I_T = 300 \dots 2000\text{ A}$			0.90	mΩ
Holding current	I_H	$T_{vj} = 25\text{ °C}$			50	A

Turn-on switching

Maximum rated values ¹⁾

Parameter	Symbol	Conditions	min	typ	max	Unit
Critical rate of rise of on-state current	di_T/dt_{cr}	$T_{vj} = 125\text{ °C}$, $f = 200\text{ Hz}$ $I_T = 1500\text{ A}$, $I_{GM} = 30\text{ A}$			400	A/μs
Critical rate of rise of on-state current	di_T/dt_{cr}	$di_G/dt = 20\text{ A/μs}$, $f = 1\text{ Hz}$			600	A/μs
Min. on-time	t_{on}	$V_D = 0.5 V_{DRM}$, $T_{vj} = 125\text{ °C}$ $I_T = 1500\text{ A}$, $di/dt = 100\text{ A/μs}$, $I_{GM} = 30\text{ A}$, $di_G/dt = 20\text{ A/μs}$, $C_S = 3\text{ μF}$, $R_S = 5\text{ Ω}$	80			μs

Characteristic values

Parameter	Symbol	Conditions	min	typ	max	Unit
Turn-on delay time	t_d	$V_D = 0.5 V_{DRM}$, $T_{vj} = 125\text{ °C}$ $I_T = 1500\text{ A}$, $di/dt = 100\text{ A/μs}$,			2	μs
Rise time	t_r	$I_{GM} = 30\text{ A}$, $di_G/dt = 20\text{ A/μs}$,			4	μs
Turn-on energy per pulse	E_{on}	$C_S = 3\text{ μF}$, $R_S = 5\text{ Ω}$			0.5	J

Turn-off switching

Maximum rated values ¹⁾

Parameter	Symbol	Conditions	min	typ	max	Unit
Max. controllable turn-off current	I_{TGQM}	$V_{DM} \leq V_{DRM}$, $di_{GQ}/dt = 30\text{ A/μs}$, $C_S = 3\text{ μF}$, $L_S \leq 0.3\text{ μH}$			1500	A
Min. off-time	t_{off}	$V_D = 0.5 V_{DRM}$, $T_{vj} = 125\text{ °C}$ $V_{DM} \leq V_{DRM}$, $di_{GQ}/dt = 30\text{ A/μs}$, $I_{TGQ} = I_{TGQM}$, $R_S = 5\text{ Ω}$, $C_S = 3\text{ μF}$, $L_S = 0.3\text{ μH}$	80			μs

Characteristic values

Parameter	Symbol	Conditions	min	typ	max	Unit
Storage time	t_s	$V_D = 0.5 V_{DRM}$, $T_{vj} = 125\text{ °C}$			15	μs
Fall time	t_f	$V_{DM} \leq V_{DRM}$, $di_{GQ}/dt = 30\text{ A/μs}$,			2	μs
Turn-on energy per pulse	E_{off}	$I_{TGQ} = I_{TGQM}$, $R_S = 5\text{ Ω}$, $C_S = 3\text{ μF}$, $L_S = 0.3\text{ μH}$			2	J
Peak turn-off gate current	I_{GQM}				480	A

Gate

Maximum rated values ¹⁾

Parameter	Symbol	Conditions	min	typ	max	Unit
Repetitive peak reverse voltage	V_{GRM}				17	V
Repetitive peak reverse current	I_{GRM}	$V_{GR} = V_{GRM}$			20	mA

Characteristic values

Parameter	Symbol	Conditions	min	typ	max	Unit
Gate trigger voltage	V_{GT}	$T_{vj} = 25^{\circ}\text{C}$,		1.5		V
Gate trigger current	I_{GT}	$V_D = 24\text{ V}$, $R_A = 0.1\ \Omega$		1.5		A

Thermal

Maximum rated values ¹⁾

Parameter	Symbol	Conditions	min	typ	max	Unit
Junction operating temperature	T_{vj}		0		125	$^{\circ}\text{C}$
Storage temperature range	T_{stg}		0		125	$^{\circ}\text{C}$

Characteristic values

Parameter	Symbol	Conditions	min	typ	max	Unit
Thermal resistance junction to case	$R_{th(j-c)}$	Double side cooled			27	K/kW
	$R_{th(j-c)A}$	Anode side cooled			49	K/kW
	$R_{th(j-c)C}$	Cathode side cooled			60	K/kW
Thermal resistance case to heatsink (Double side cooled)	$R_{th(c-h)}$	Single side cooled			16	K/kW
	$R_{th(c-h)}$	Double side cooled			8	K/kW

Analytical function for transient thermal impedance:

$$Z_{th(j-c)}(t) = \sum_{i=1}^n R_i (1 - e^{-t/\tau_i})$$

i	1	2	3	4
R_i (K/kW)	14.570	5.051	7.285	0.097
τ_i (s)	0.4610	0.0950	0.0120	0.0010

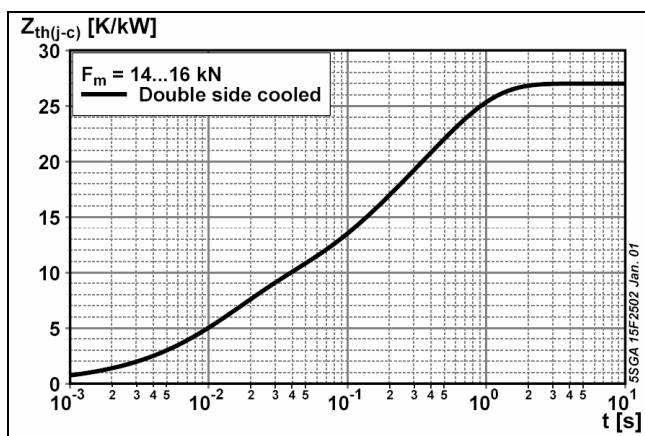

Fig. 1 Transient thermal impedance, junction to case

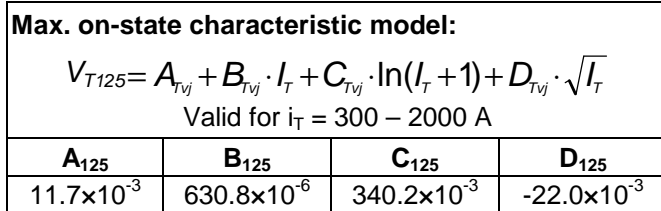
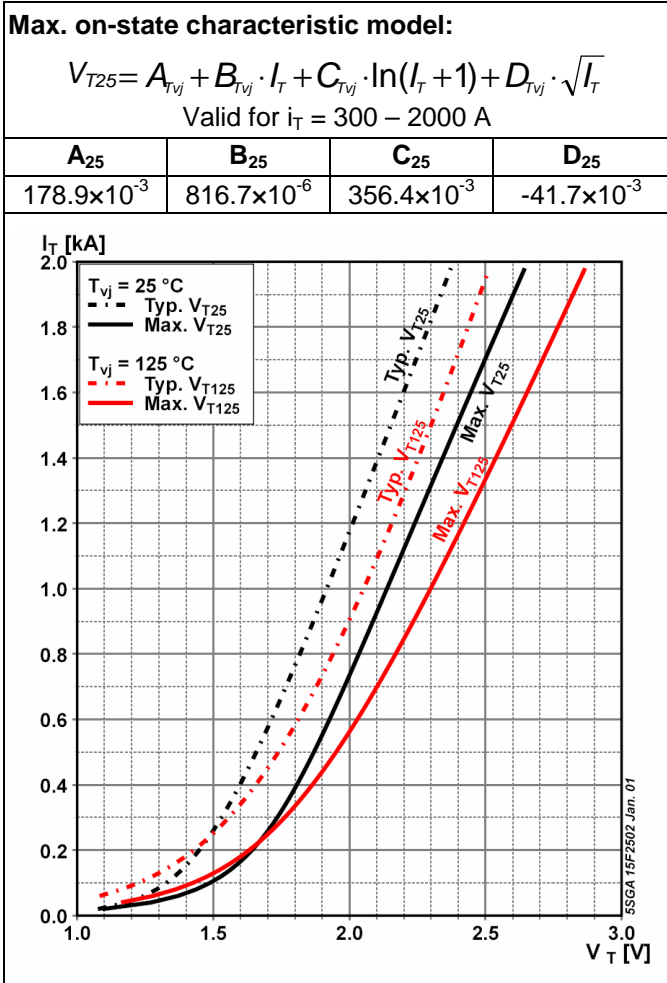

Fig. 2 On-state characteristics

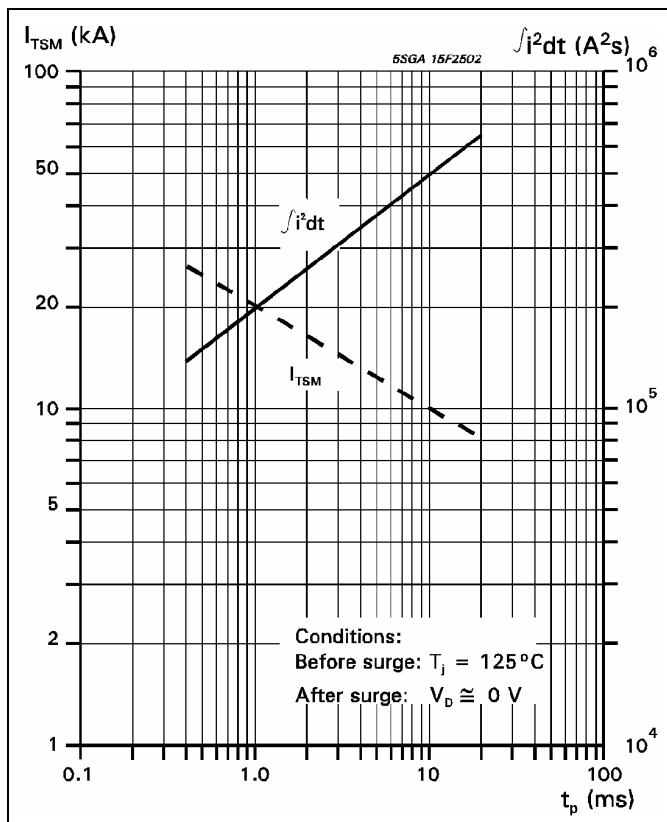

Fig. 3 Surge current and fusing integral vs. pulse width

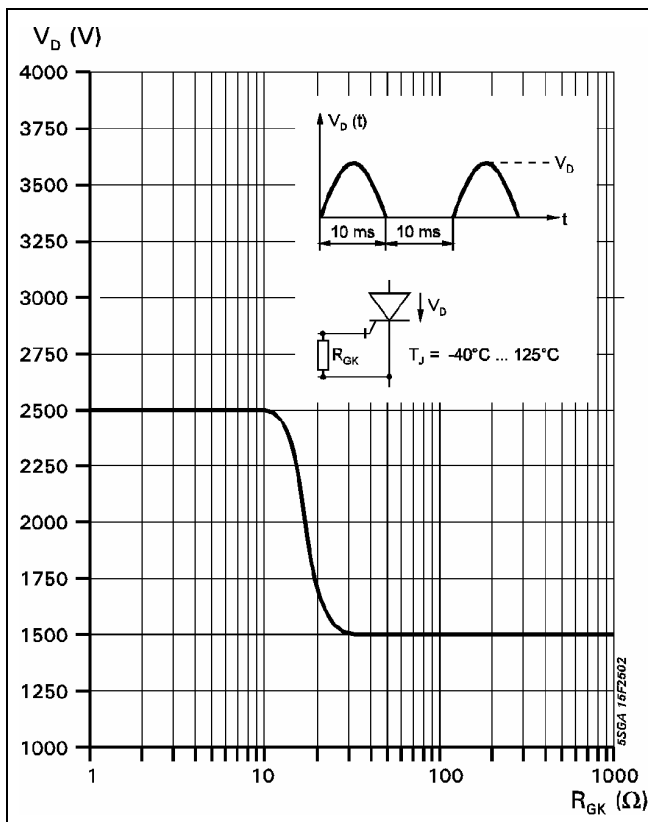

Fig. 4 Forward blocking voltage vs. gate-cathode resistance

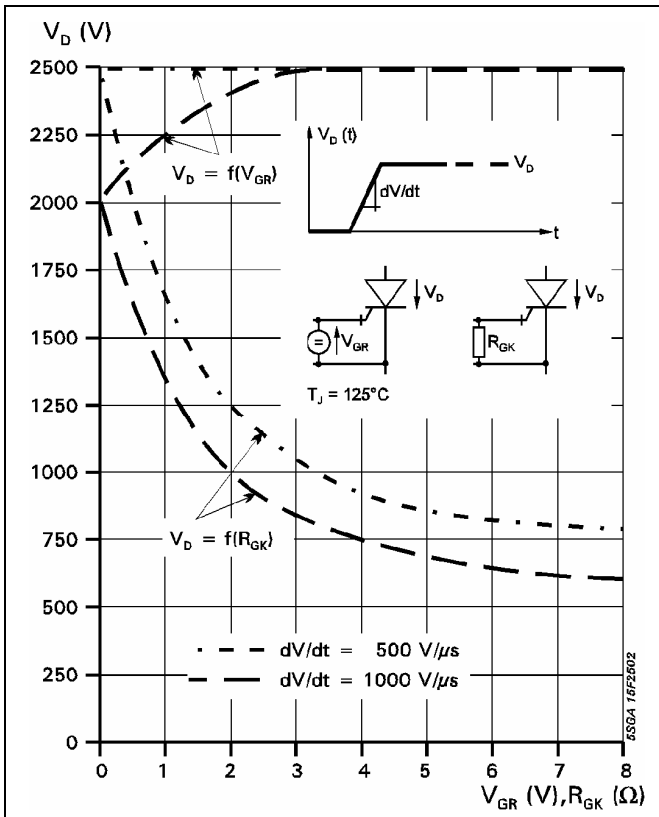

Fig. 5 Static dv/dt capability; forward blocking voltage vs. neg. gate voltage or gate cathode resistance

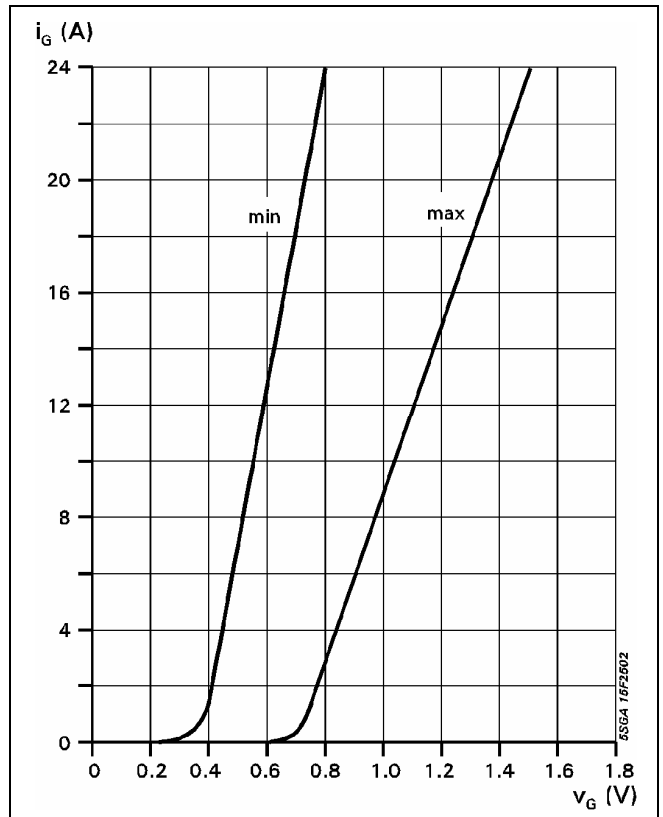

Fig. 6 Forward gate current vs. forward gate voltage

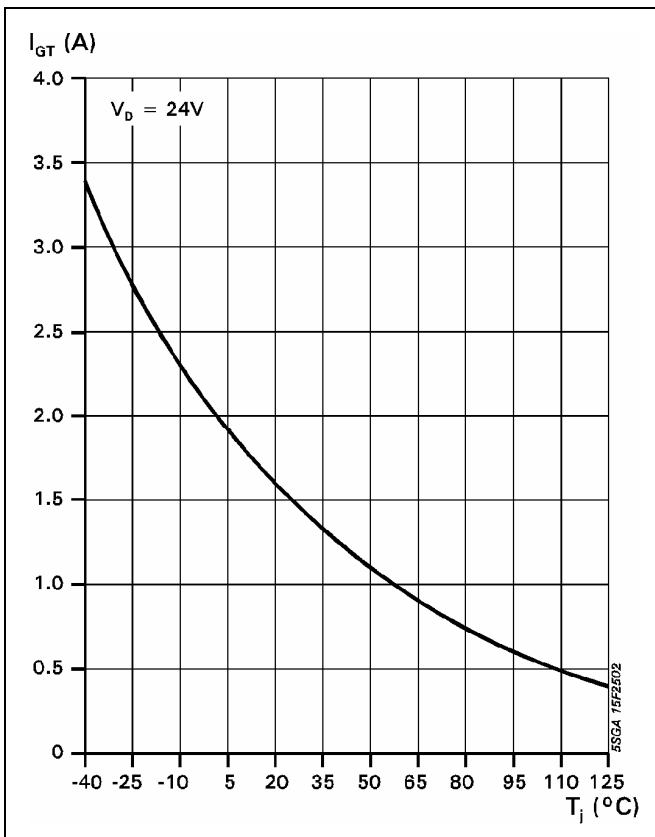

Fig. 7 Gate trigger current vs. junction temperature

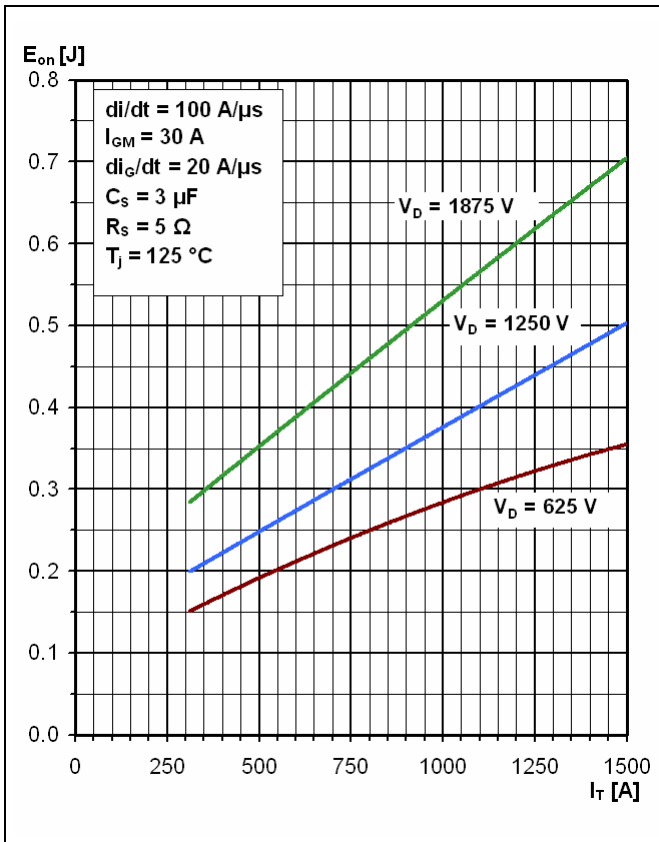

Fig. 8 Turn-on energy per pulse vs. on-state current and turn-on voltage

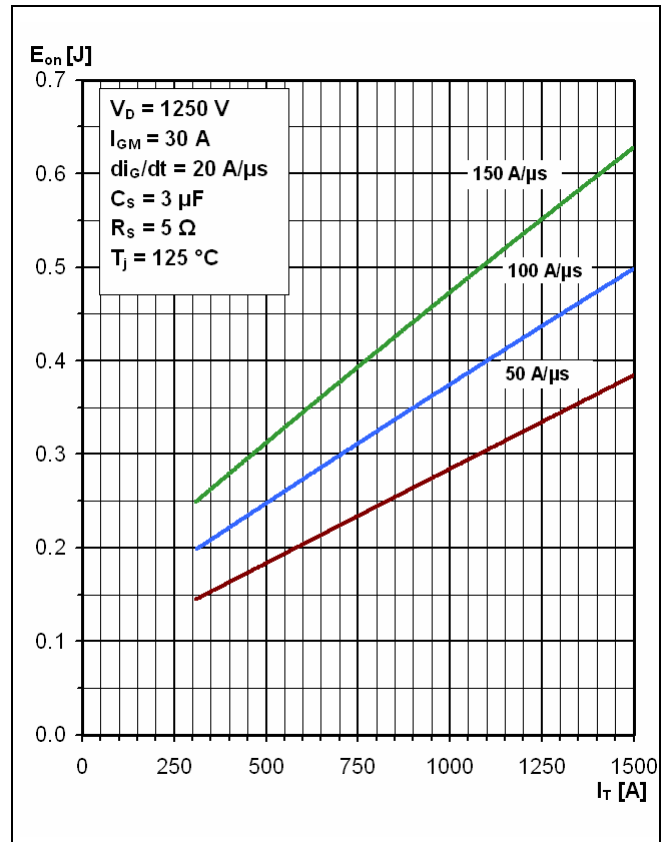

Fig. 9 Turn-on energy per pulse vs. on-state current and current rise rate

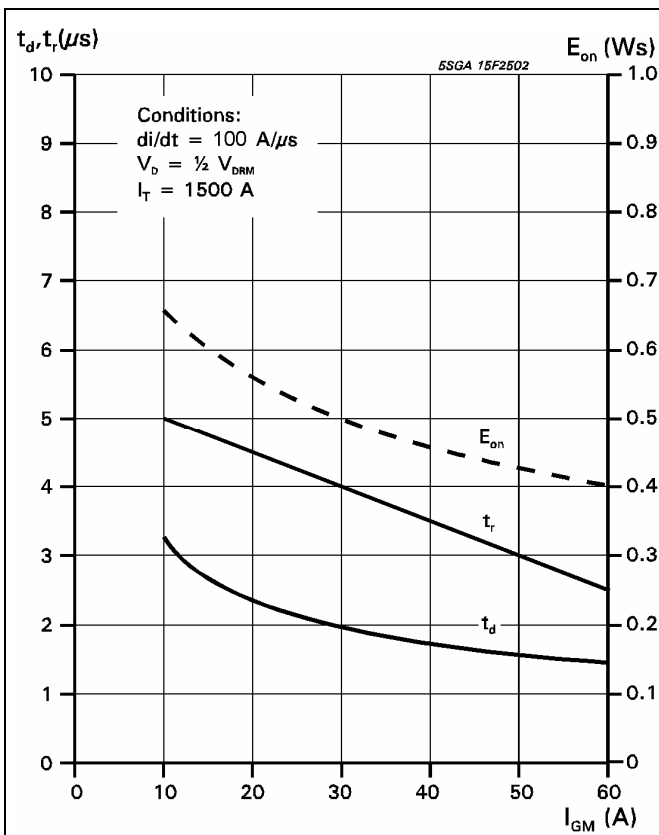

Fig. 10 Turn-on energy per pulse vs. on-state current and turn-on voltage

Common Test conditions:

- di_G/dt = 20 A/μs
- C_S = 3 μF
- R_S = 5 Ω
- T_J = 125 °C

Definition of Turn-on energy:

$$E_{on} = \int_0^{20\text{ms}} V_D \cdot I_T dt \quad (t = 0, I_G = 0.1 \cdot I_{GM})$$

Definition of Turn-off energy:

$$E_{off} = \int_0^{40\text{ms}} V_D \cdot I_T dt \quad (t = 0, I_T = 0.9 \cdot I_{TQ})$$

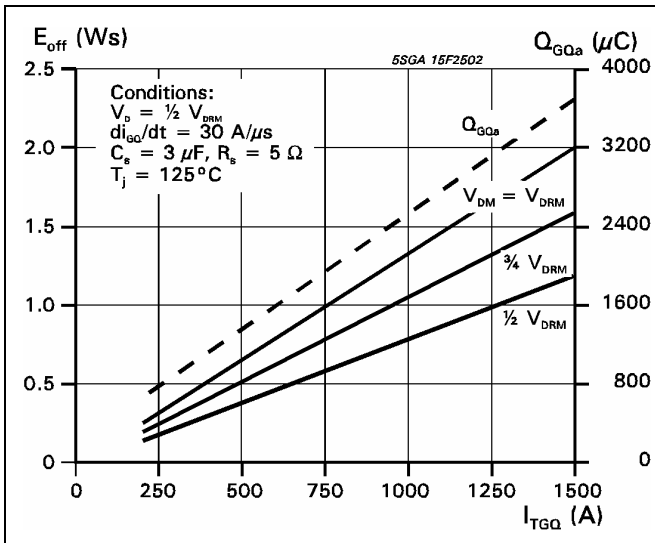

Fig. 11 Turn-off energy per pulse vs. turn-off current and peak turn-off voltage, extracted gate charge vs. turn-off current

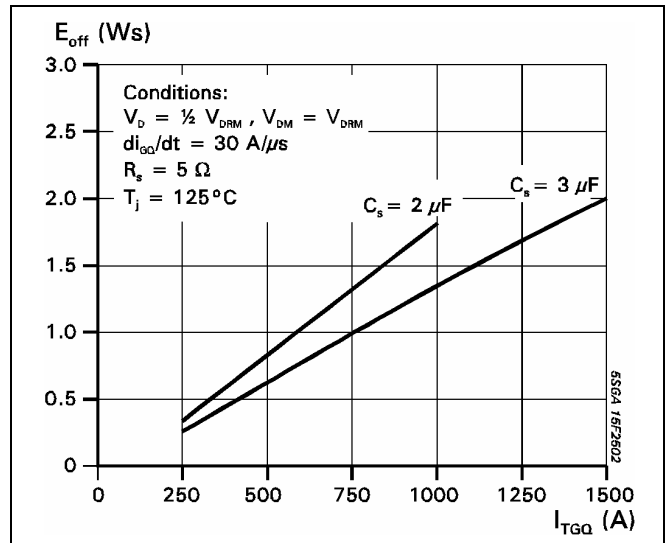

Fig. 12 Turn-off energy per pulse vs. turn-off current and snubber capacitance

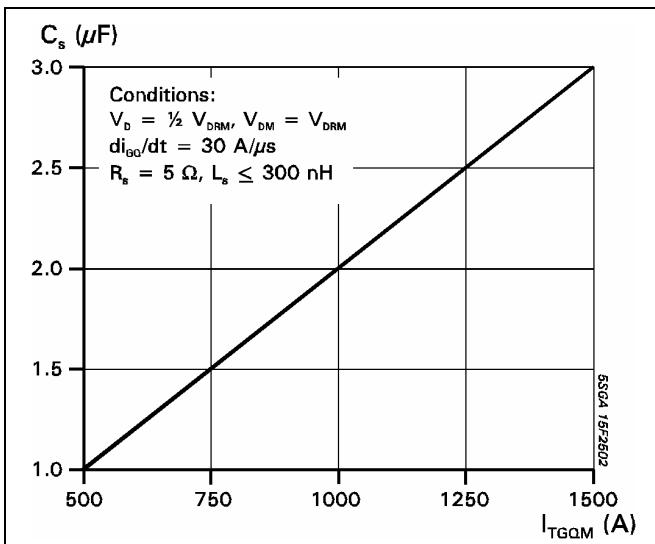

Fig. 13 Required snubber capacitor vs. max allowable turn-off current

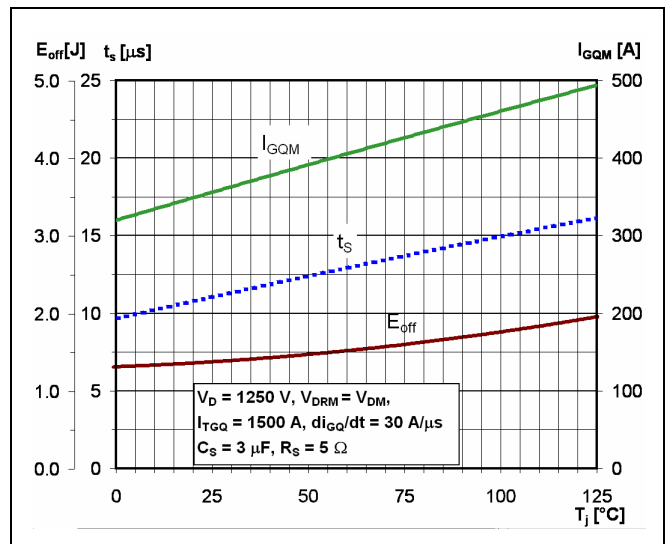

Fig. 14 Turn-off energy per pulse, storage time and peak turn-off gate current vs. junction temperature

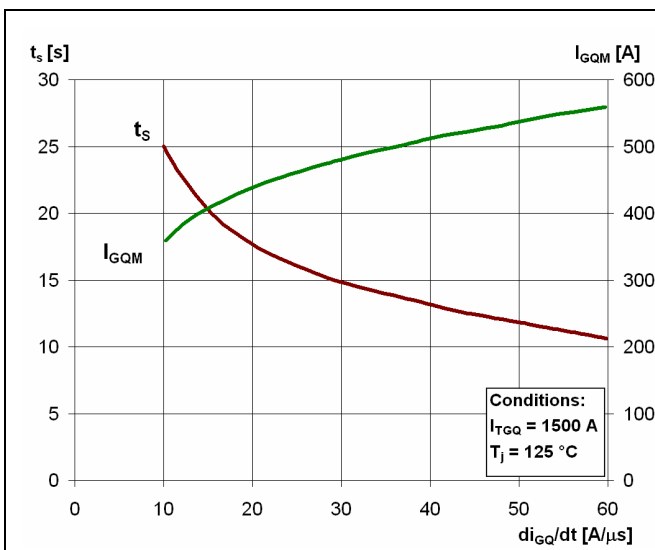

Fig. 15 Storage time and peak turn-off gate current vs. neg. gate current rise rate

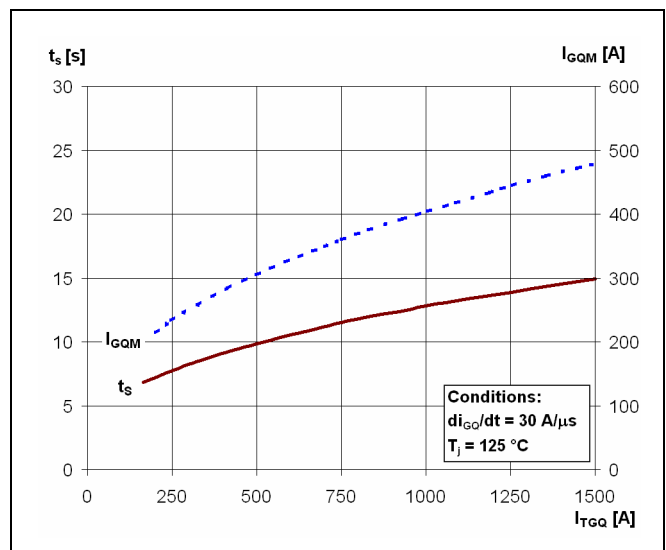

Fig. 16 Storage time and peak turn-off gate current vs. neg. gate current rise rate

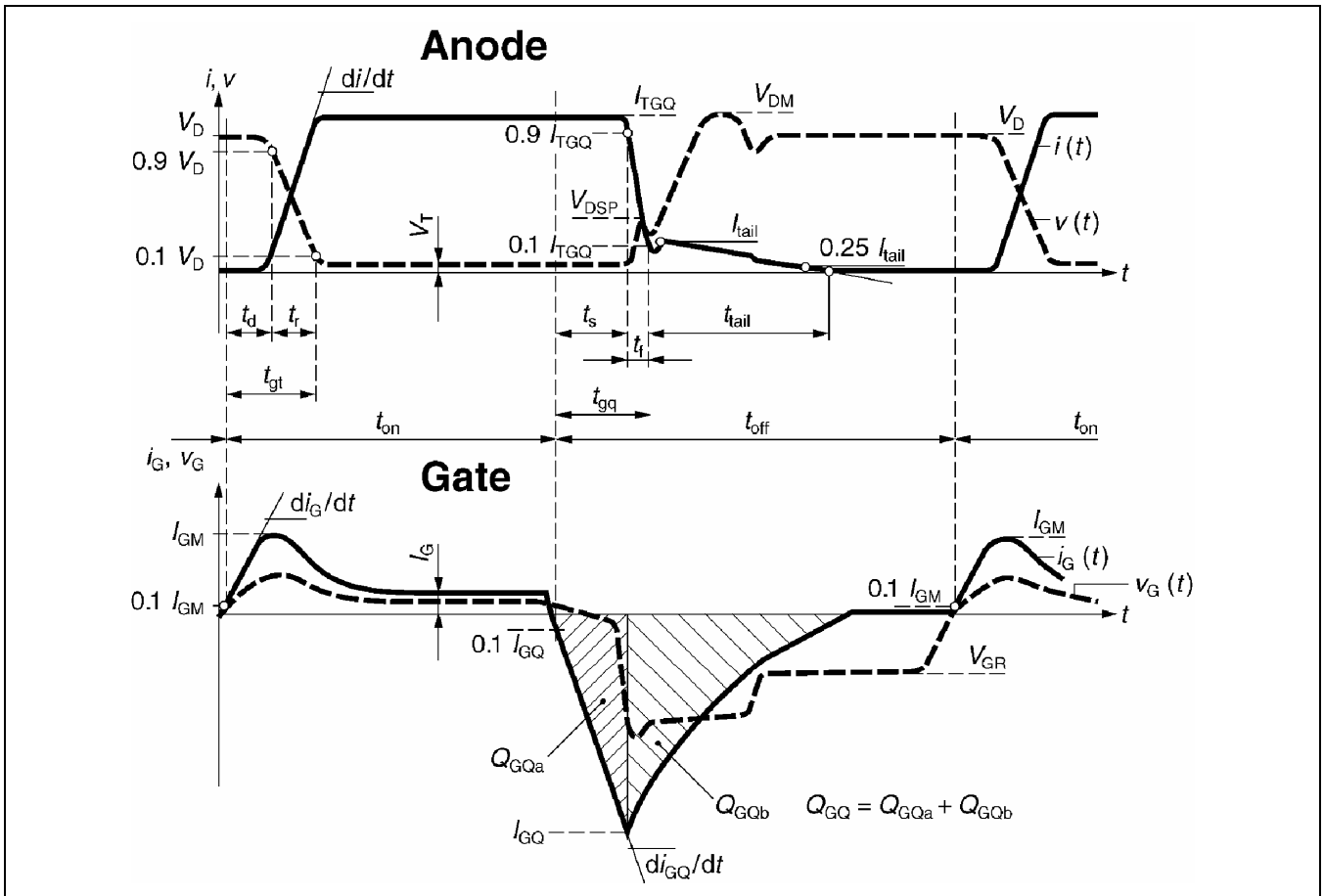

Fig. 17 General current and voltage waveforms with GTO-specific symbols

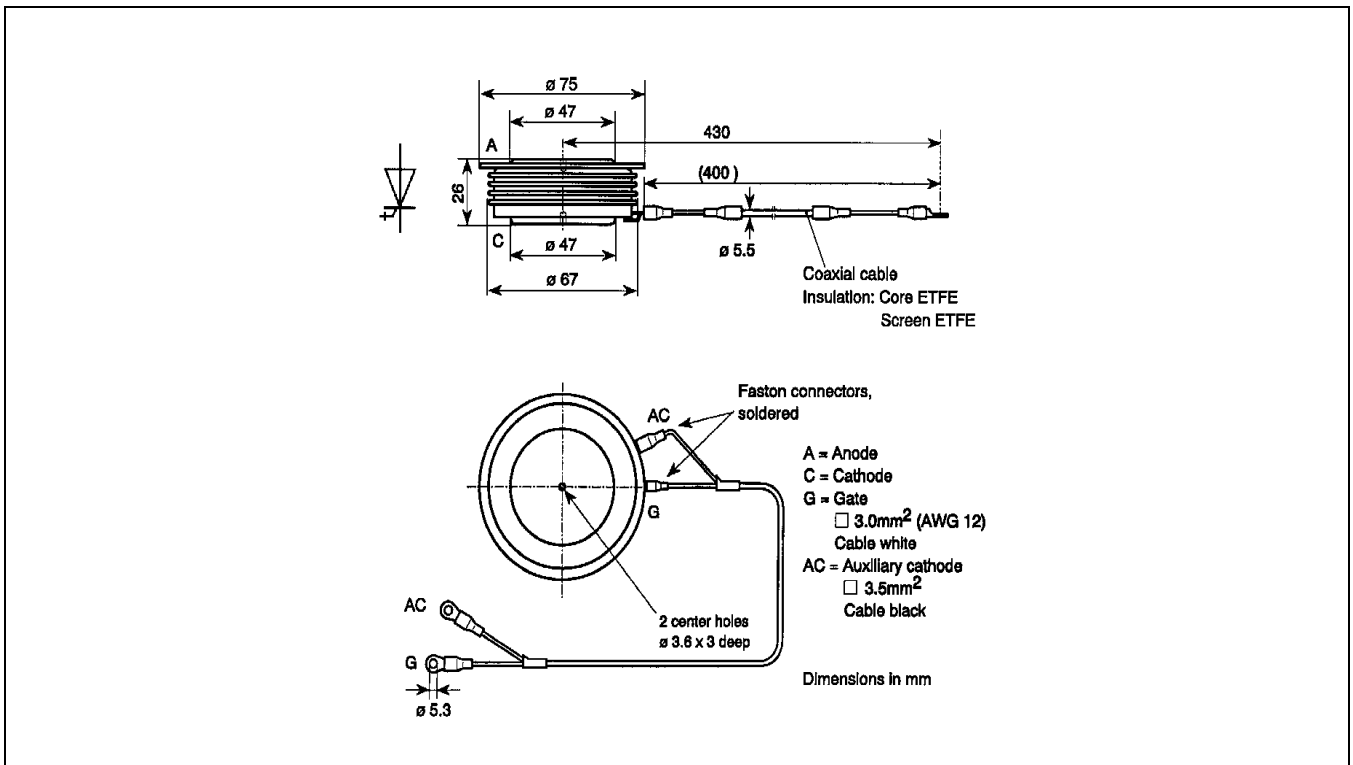

Fig. 18 Outline drawing; all dimensions are in millimeters and represent nominal values unless stated otherwise

Reverse avalanche capability

In operation with an antiparallel freewheeling diode, the GTO reverse voltage V_R may exceed the rate value V_{RRM} due to stray inductance and diode turn-on voltage spike at high di/dt . The GTO is then driven into reverse avalanche. This condition is not dangerous for the GTO provided avalanche time and current are below 10 μ s and 1000 A respectively. However, gate voltage must remain negative during this time. Recommendation : $V_{GR} = 10... 15$ V.

Related documents:

5SYA 2036	Recommendations regarding mechanical clamping of Press Pack High Power Semiconductors
5SYA 2046	Cosmic Ray
5SZK 9104	Specification of enviromental class for pressure contact GTO, STORAGE available on request, please contact factory
5SZK 9105	Specification of enviromental class for pressure contact GTO, TRANSPORTATION available on request, please contact factory

Please refer to <http://www.abb.com/semiconductors> for current version of documents.

ABB Switzerland Ltd, Semiconductors reserves the right to change specifications without notice.



ABB Switzerland Ltd
Semiconductors
Fabrikstrasse 3
CH-5600 Lenzburg, Switzerland

Telephone +41 (0)58 586 1419
Fax +41 (0)58 586 1306
Email abbsem@ch.abb.com
Internet www.abb.com/semiconductors

X-ON Electronics

Largest Supplier of Electrical and Electronic Components

Click to view similar products for [SCRs category](#):

Click to view products by [ABB manufacturer](#):

Other Similar products are found below :

[NTE5428](#) [T1500N16TOF VT](#) [T660N22TOF](#) [T720N18TOF](#) [T880N14TOF](#) [T880N16TOF](#) [TT162N16KOF-A](#) [TT162N16KOF-K](#)
[TT330N16AOF](#) [VS-22RIA20](#) [VS-2N685](#) [057219R](#) [T1190N16TOF VT](#) [T1220N22TOF VT](#) [T201N70TOH](#) [T700N22TOF](#) [TT250N12KOF-K](#)
[VS-110RKI40](#) [NTE5427](#) [NTE5442](#) [T2160N28TOF VT](#) [TT251N16KOF-K](#) [VS-22RIA100](#) [VS-16RIA40](#) [TD250N16KOF-A](#) [VS-ST110S16P0](#)
[T930N36TOF VT](#) [T2160N24TOF VT](#) [T1190N18TOF VT](#) [T1590N28TOF VT](#) [2N1776A](#) [T590N14TOF](#) [NTE5375](#) [NTE5460](#) [NTE5481](#)
[NTE5504](#) [NTE5512](#) [NTE5514](#) [NTE5518](#) [NTE5519](#) [NTE5529](#) [NTE5553](#) [NTE5555](#) [NTE5557](#) [NTE5567](#) [NTE5570](#) [NTE5572](#) [NTE5574](#)
[NTE5576](#) [NTE5579](#)