

$V_{DRM}$	=	4500 V
$I_{TGQM}$	=	4000 A
$I_{TSM}$	=	$25 \times 10^3$ A
$V_{T0}$	=	1.2 V
$r_T$	=	0.65 mW
$V_{Dclink}$	=	2800 V

# Asymmetric Gate turn-off Thyristor 5SGF 40L4502

Doc. No. 5SYA1209-04 Feb. 05

- Patented free-floating silicon technology
- Low on-state and switching losses
- Annular gate electrode
- Industry standard housing
- Cosmic radiation withstand rating

## Blocking

*Maximum rated values <sup>1)</sup>*

Parameter	Symbol	Conditions	min	typ	max	Unit
Repetitive peak off-state voltage	$V_{DRM}$	$V_{GR} \geq 2$ V			4500	V
Repetitive peak reverse voltage	$V_{RRM}$				17	V
Permanent DC voltage for 100 FIT failure rate	$V_{Dclink}$	Ambient cosmic radiation at sea level in open air.			2800	V

*Characteristic values*

Parameter	Symbol	Conditions	min	typ	max	Unit
Repetitive peak off-state current	$I_{DRM}$	$V_D = V_{DRM}, V_{GR} \geq 2$ V			100	mA
Repetitive peak reverse current	$I_{RRM}$	$V_R = V_{RRM}, R_{GK} = \infty \Omega$			50	mA

## Mechanical data

*Maximum rated values <sup>1)</sup>*

Parameter	Symbol	Conditions	min	typ	max	Unit
Mounting force	$F_m$		36	40	44	kN

*Characteristic values*

Parameter	Symbol	Conditions	min	typ	max	Unit
Pole-piece diameter	$D_p$	$\pm 0.1$ mm		75		mm
Housing thickness	H		26.0		26.5	mm
Weight	m				1.5	kg
Surface creepage distance	$D_s$	Anode to Gate	33			mm
Air strike distance	$D_a$	Anode to Gate	14			mm

1) Maximum rated values indicate limits beyond which damage to the device may occur

ABB Switzerland Ltd, Semiconductors reserves the right to change specifications without notice.



## GTO Data

### On-state

Maximum rated values <sup>1)</sup>

Parameter	Symbol	Conditions	min	typ	max	Unit
Max. average on-state current	$I_{T(AV)M}$	Half sine wave, $T_C = 85^\circ\text{C}$			1180	A
Max. RMS on-state current	$I_{T(RMS)}$				1850	A
Max. peak non-repetitive surge current	$I_{TSM}$	$t_p = 10\text{ ms}$ , $T_{vj} = 125^\circ\text{C}$ , sine wave After Surge: $V_D = V_R = 0\text{ V}$			$25 \times 10^3$	A
Limiting load integral	$I^2t$				$3.1 \times 10^6$	$\text{A}^2\text{s}$
Max. peak non-repetitive surge current	$I_{TSM}$	$t_p = 1\text{ ms}$ , $T_{vj} = 125^\circ\text{C}$ , sine wave After Surge: $V_D = V_R = 0\text{ V}$			$40 \times 10^3$	A
Limiting load integral	$I^2t$				$800 \times 10^3$	$\text{A}^2\text{s}$

Characteristic values

Parameter	Symbol	Conditions	min	typ	max	Unit
On-state voltage	$V_T$	$I_T = 4000\text{ A}$ , $T_{vj} = 125^\circ\text{C}$			3.8	V
Threshold voltage	$V_{(T0)}$	$T_{vj} = 125^\circ\text{C}$ $I_T = 400 \dots 5000\text{ A}$			1.2	V
Slope resistance	$r_T$				0.65	$\text{m}\Omega$
Holding current	$I_H$	$T_{vj} = 25^\circ\text{C}$			100	A

### Turn-on switching

Maximum rated values <sup>1)</sup>

Parameter	Symbol	Conditions	min	typ	max	Unit
Critical rate of rise of on-state current	$di_T/dt_{cr}$	$T_{vj} = 125^\circ\text{C}$ , $f = 200\text{ Hz}$ $I_T = 4000\text{ A}$ , $I_{GM} = 50\text{ A}$ , $di_G/dt = 40\text{ A}/\mu\text{s}$ , $f = 1\text{ Hz}$			500	$\text{A}/\mu\text{s}$
Critical rate of rise of on-state current	$di_T/dt_{cr}$				1000	$\text{A}/\mu\text{s}$
Min. on-time	$t_{on}$		100			$\mu\text{s}$

Characteristic values

Parameter	Symbol	Conditions	min	typ	max	Unit
Turn-on delay time	$t_d$	$V_D = 0.5 V_{DRM}$ , $T_{vj} = 125^\circ\text{C}$ $I_T = 4000\text{ A}$ , $di/dt = 300\text{ A}/\mu\text{s}$ , $I_{GM} = 50\text{ A}$ , $di_G/dt = 40\text{ A}/\mu\text{s}$ , $C_S = 6\text{ }\mu\text{F}$ , $R_S = 5\text{ }\Omega$			2.5	$\mu\text{s}$
Rise time	$t_r$				5	$\mu\text{s}$
Turn-on energy per pulse	$E_{on}$				3	J

### Turn-off switching

Maximum rated values <sup>1)</sup>

Parameter	Symbol	Conditions	min	typ	max	Unit
Max. controllable turn-off current	$I_{TGQM}$	$V_{DM} \leq V_{DRM}$ , $di_{GQ}/dt = 40\text{ A}/\mu\text{s}$ , $C_S = 6\text{ }\mu\text{F}$ , $L_S \leq 0.2\text{ }\mu\text{H}$			4000	A
Min. off-time	$t_{off}$		100			$\mu\text{s}$

Characteristic values

Parameter	Symbol	Conditions	min	typ	max	Unit
Storage time	$t_s$	$V_D = 0.5 V_{DRM}$ , $T_{vj} = 125^\circ\text{C}$ $V_{DM} \leq V_{DRM}$ , $di_{GQ}/dt = 40\text{ A}/\mu\text{s}$ , $I_{TGQ} = I_{TGQM}$ , $R_S = 5\text{ }\Omega$ , $C_S = 6\text{ }\mu\text{F}$ , $L_S = 0.2\text{ }\mu\text{H}$			25	$\mu\text{s}$
Fall time	$t_f$				3	$\mu\text{s}$
Turn-on energy per pulse	$E_{off}$				10	J
Peak turn-off gate current	$I_{GQM}$				1100	A

## Gate

Maximum rated values <sup>1)</sup>

Parameter	Symbol	Conditions	min	typ	max	Unit
Repetitive peak reverse voltage	V <sub>GRM</sub>				17	V
Repetitive peak reverse current	I <sub>GRM</sub>	V <sub>GR</sub> = V <sub>GRM</sub>			20	mA

Characteristic values

Parameter	Symbol	Conditions	min	typ	max	Unit
Gate trigger voltage	V <sub>GT</sub>	T <sub>vj</sub> = 25°C,		1.2		V
Gate trigger current	I <sub>GT</sub>	V <sub>D</sub> = 24 V, R <sub>A</sub> = 0.1 Ω		4		A

## Thermal

Maximum rated values <sup>1)</sup>

Parameter	Symbol	Conditions	min	typ	max	Unit
Junction operating temperature	T <sub>vj</sub>		-40		125	°C
Storage temperature range	T <sub>stg</sub>		-40		125	°C

Characteristic values

Parameter	Symbol	Conditions	min	typ	max	Unit
Thermal resistance junction to case	R <sub>th(jc)</sub>	Double side cooled			11	K/kW
	R <sub>th(jc)A</sub>	Anode side cooled			20	K/kW
	R <sub>th(jc)C</sub>	Cathode side cooled			25	K/kW
Thermal resistance case to heatsink (Double side cooled)	R <sub>th(ch)</sub>	Single side cooled			6	K/kW
	R <sub>th(ch)</sub>	Double side cooled			3	K/kW

Analytical function for transient thermal impedance:

$$Z_{thJC}(t) = \sum_{i=1}^n R_i(1 - e^{-t/\tau_i})$$

i	1	2	3	4
R <sub>i</sub> (K/kW)	7.766	1.728	1.064	0.450
τ <sub>i</sub> (s)	0.5764	0.1258	0.0128	0.0031

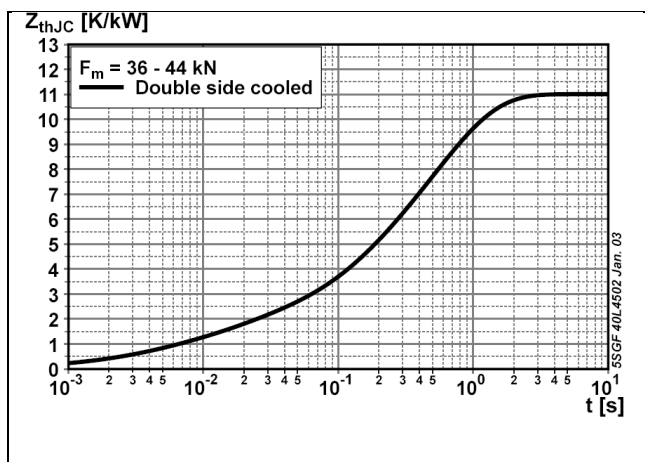

Fig. 1 Transient thermal impedance, junction to case.

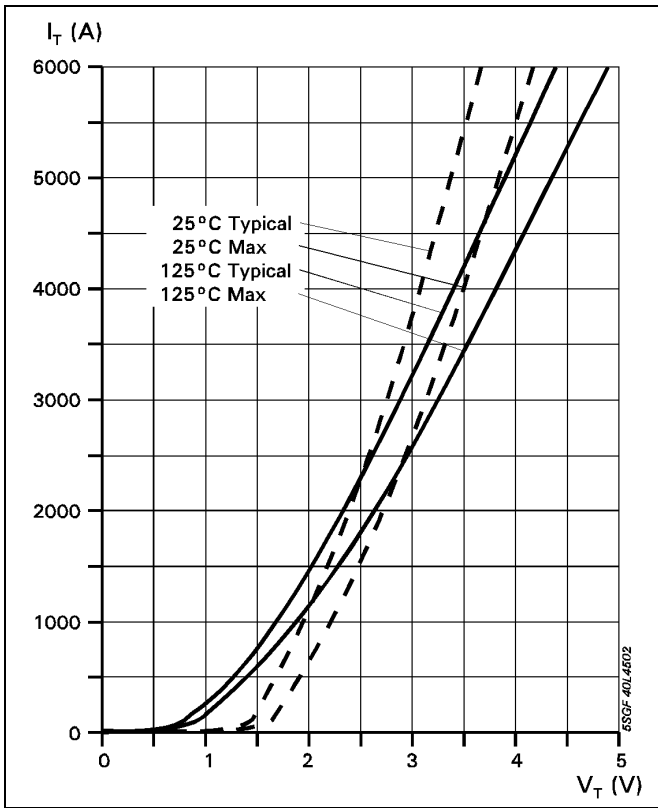

Fig. 2 On-state characteristics.

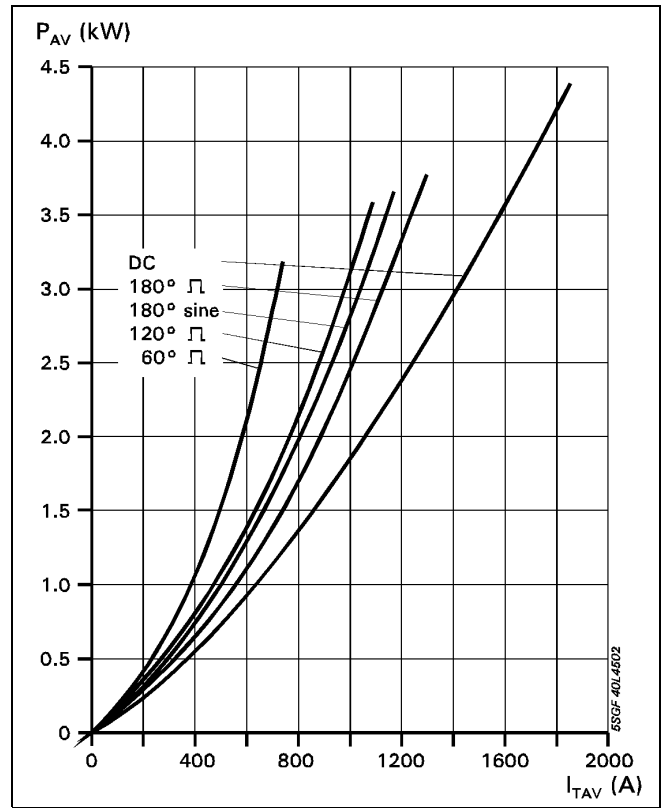

Fig. 3 Average on-state power dissipation vs. average on-state current.

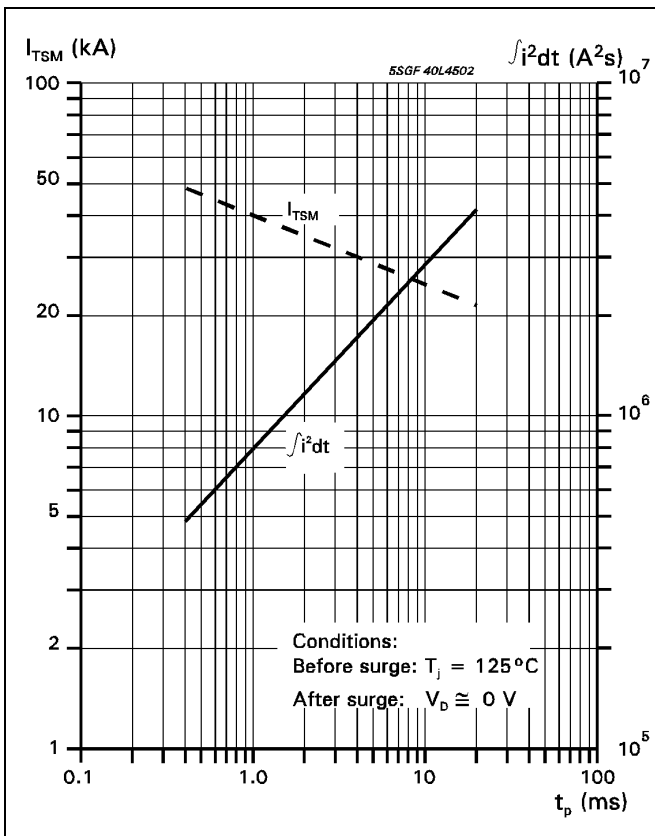

Fig. 4 Surge current and fusing integral vs. pulse width.

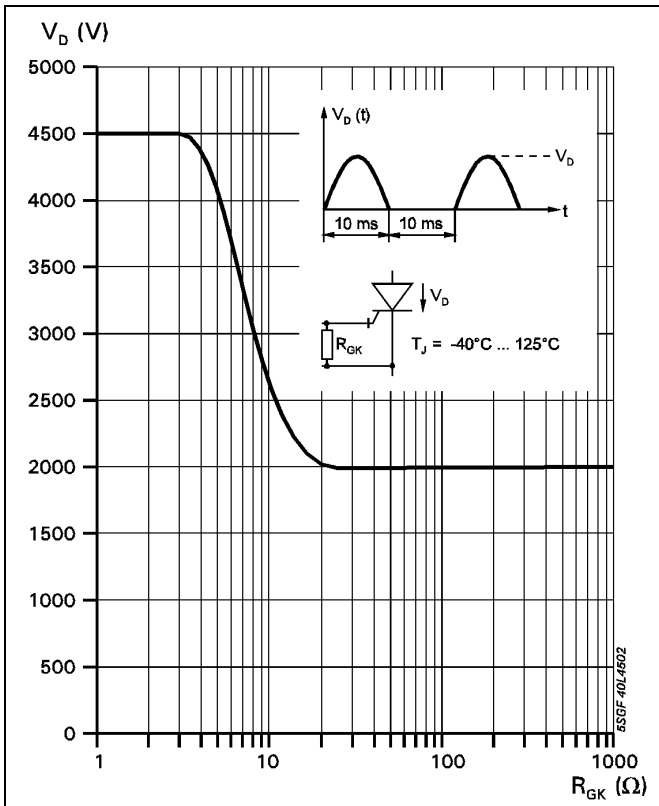

Fig. 5 Forward blocking voltage vs. gate-cathode resistance.

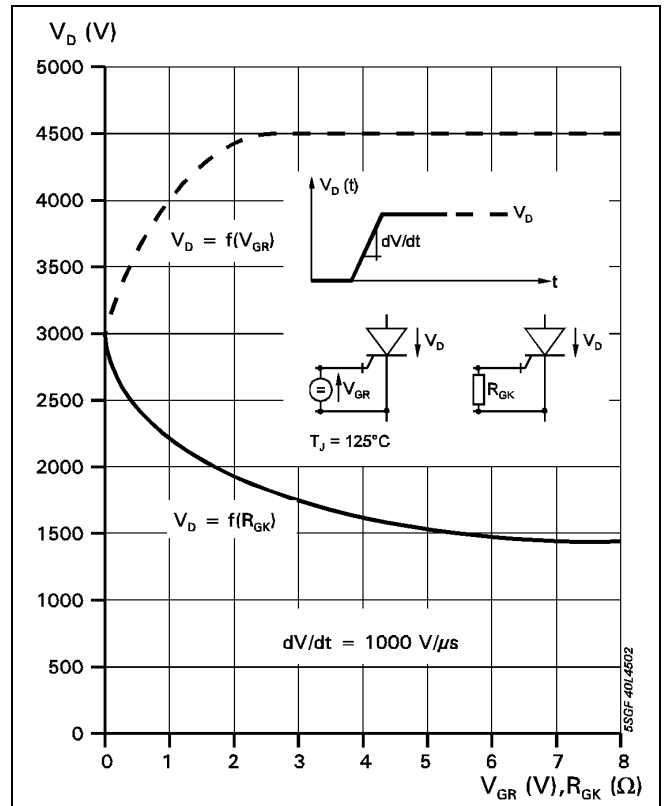

Fig. 6 Static dv/dt capability: Forward blocking voltage vs. neg. gate voltage or gate cathode resistance.

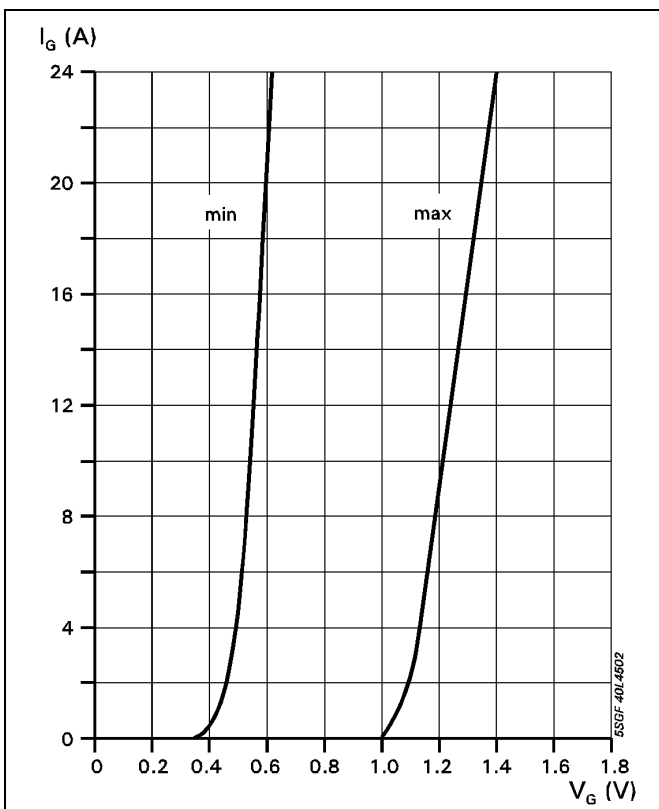

Fig. 7 Forward gate current vs. forward gate voltage.

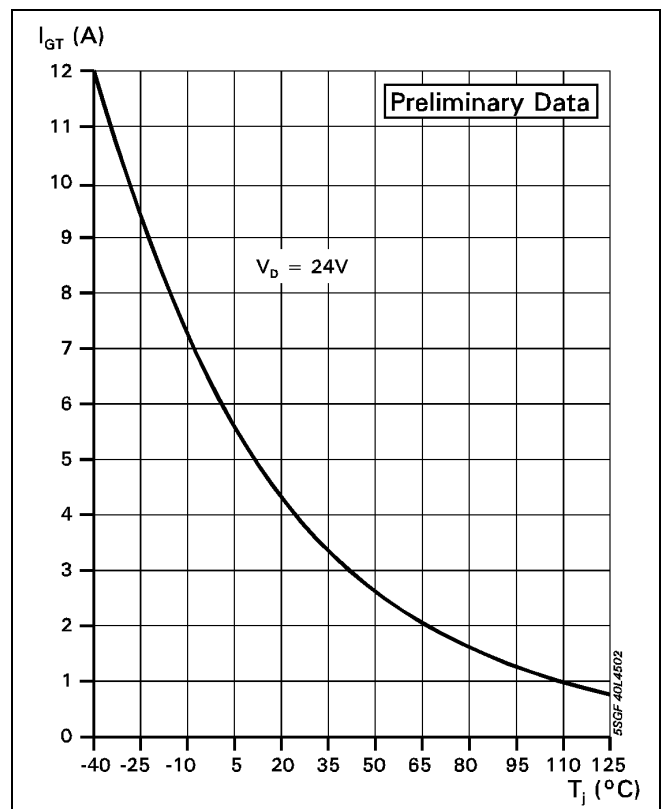
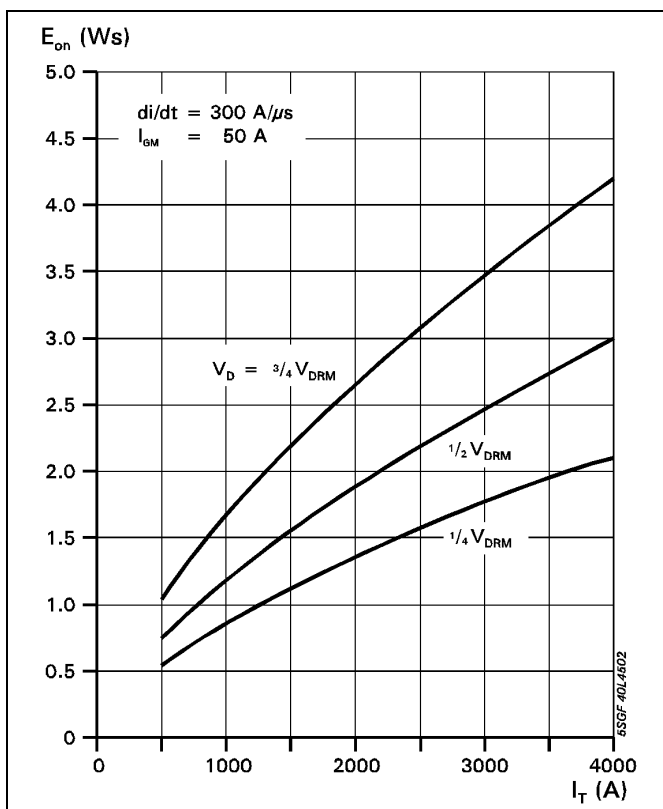
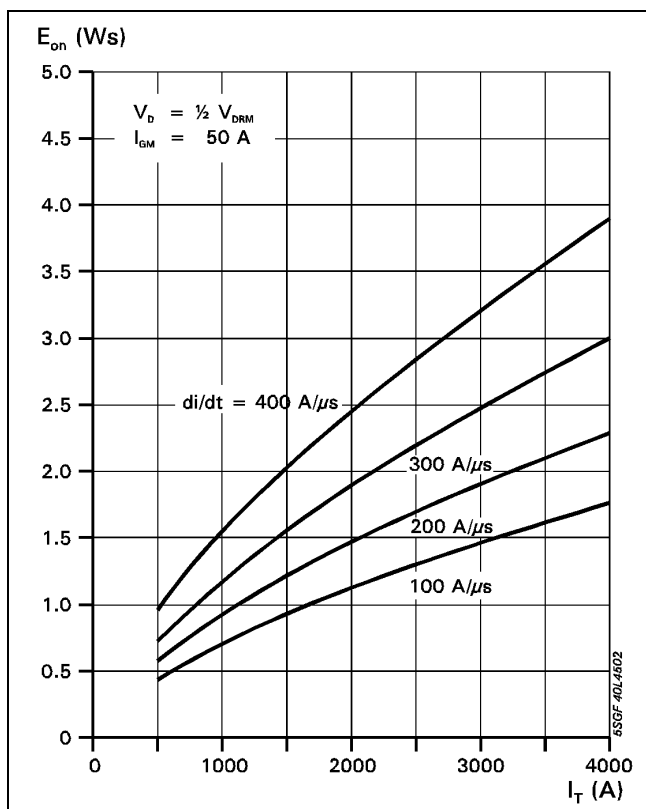

Fig. 8 Gate trigger current vs. junction temperature



**Fig. 9** Turn-on energy per pulse vs. on-state current and turn-on voltage.



**Fig. 10** Turn-on energy per pulse vs. on-state current and current rise rate

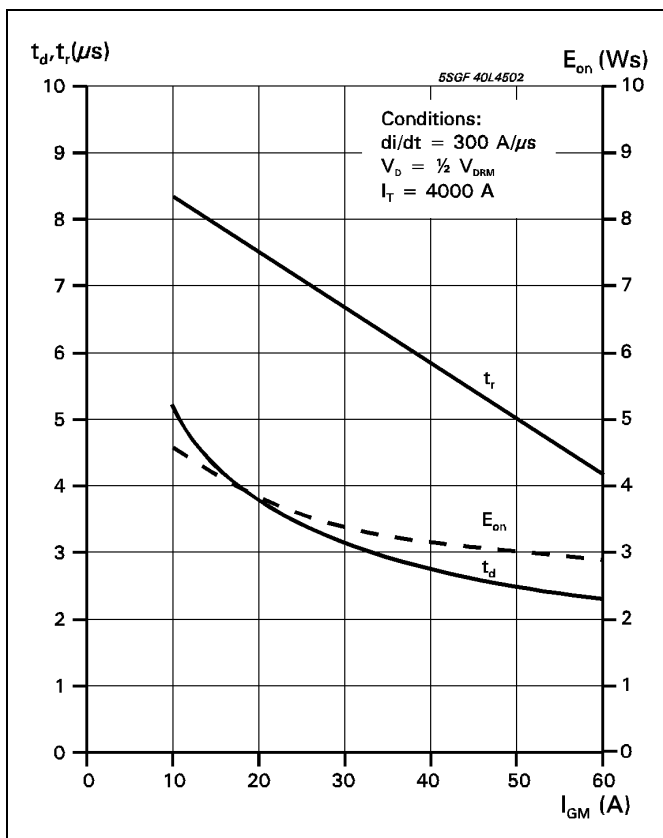

**Fig. 11** Turn-on energy per pulse vs. on-state current and turn-on voltage.

Common Test conditions for figures 9, 10 and 11:

- $di_G/dt = 40 \text{ A}/\mu\text{s}$
- $C_S = 6 \mu\text{F}$
- $R_S = 5 \Omega$
- $T_j = 125 \text{ }^\circ\text{C}$

Definition of Turn-on energy:

$$E_{on} = \int_0^{20 \text{ ms}} V_D \cdot I_T dt \quad (t = 0, I_G = 0.1 \cdot I_{GM})$$

Common Test conditions for figures 12, 13 and 15:

Definition of Turn-off energy:

$$E_{off} = \int_0^{40 \text{ ms}} V_D \cdot I_T dt \quad (t = 0, I_T = 0.9 \cdot I_{TQ})$$

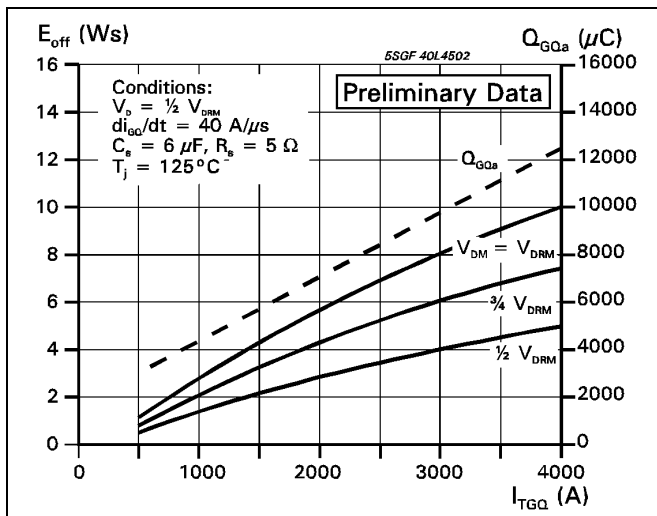

**Fig. 12** Turn-off energy per pulse vs. turn-off current and peak turn-off voltage. Extracted gate charge vs. turn-off current.

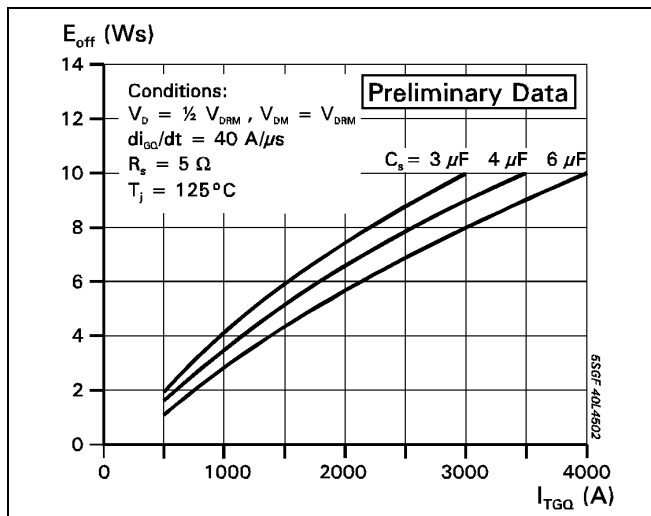

**Fig. 13** Turn-off energy per pulse vs. turn-off current and snubber capacitance.

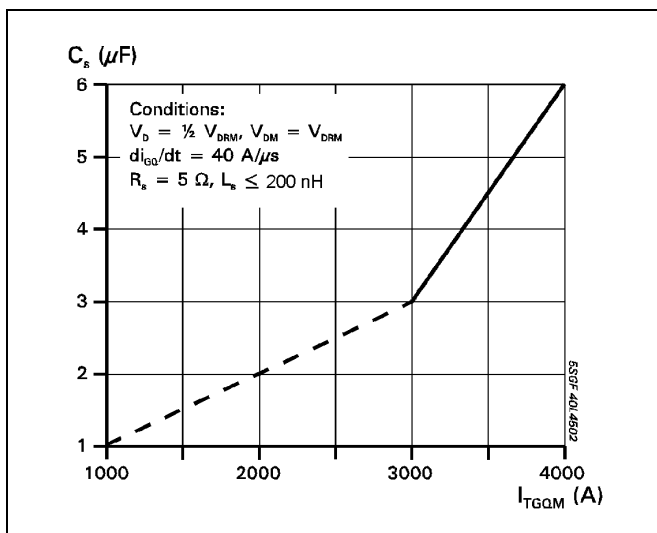

**Fig. 14** Required snubber capacitor vs. max allowable turn-off current.

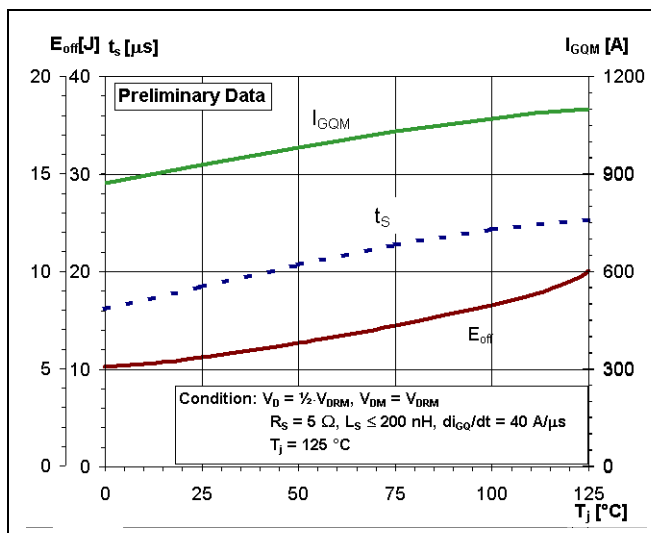

**Fig. 15** Turn-off energy per pulse, storage time and peak turn-off gate current vs. junction temperature.

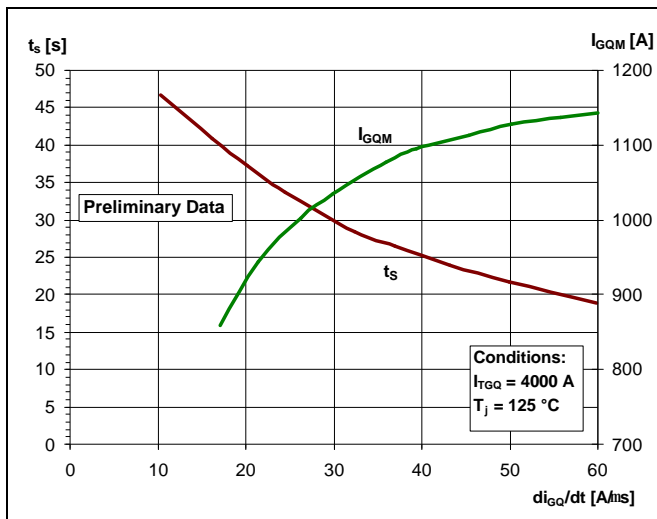

**Fig. 16** Storage time and peak turn-off gate current vs. neg. gate current rise rate.

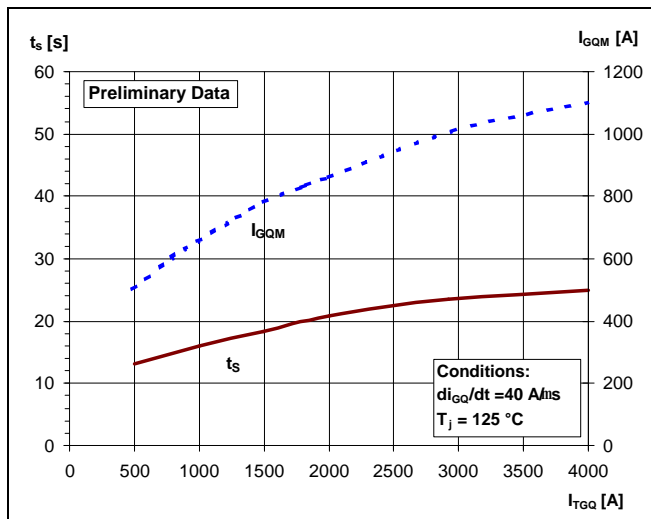

**Fig. 17** Storage time and peak turn-off gate current vs. turn-off current.

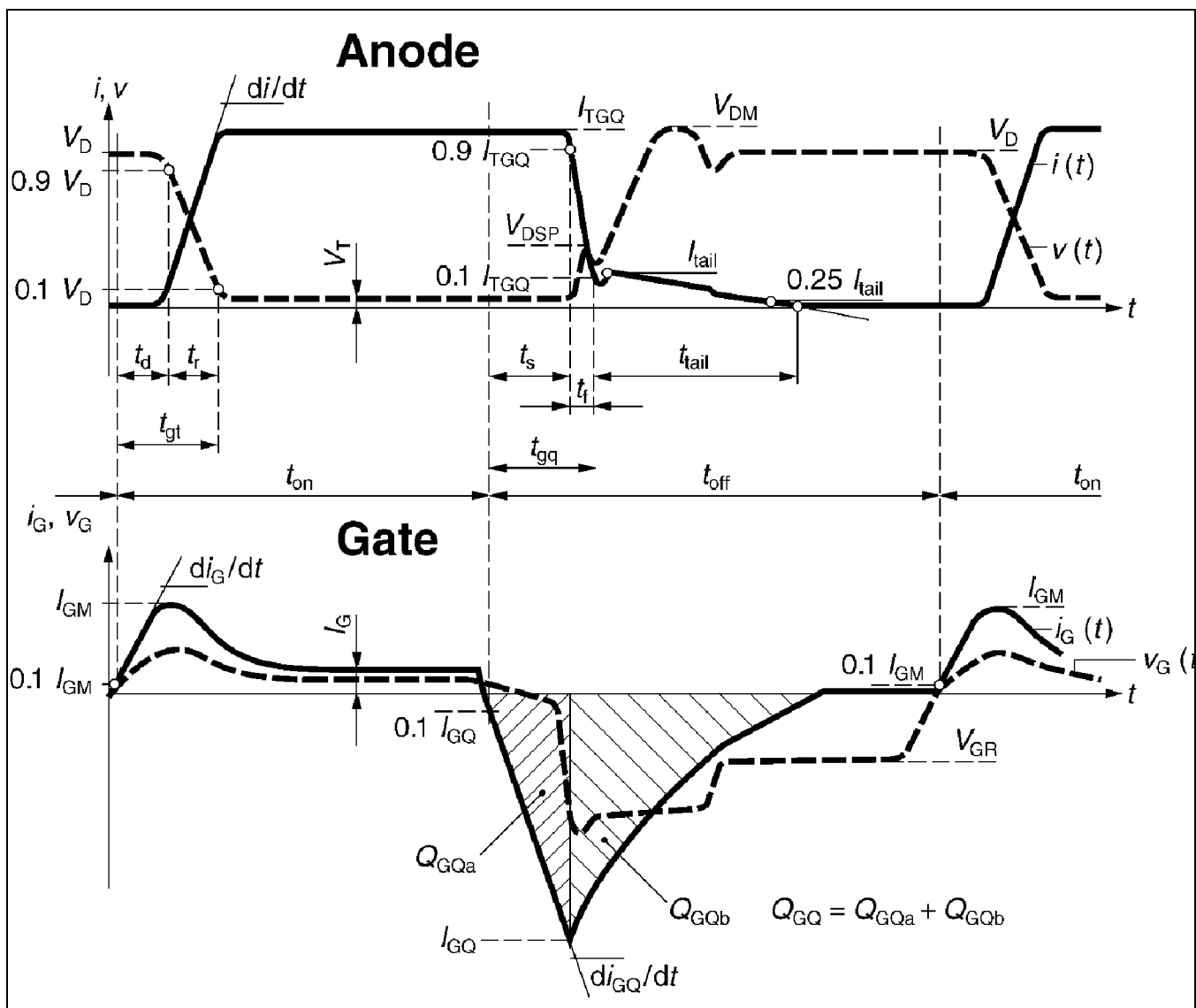
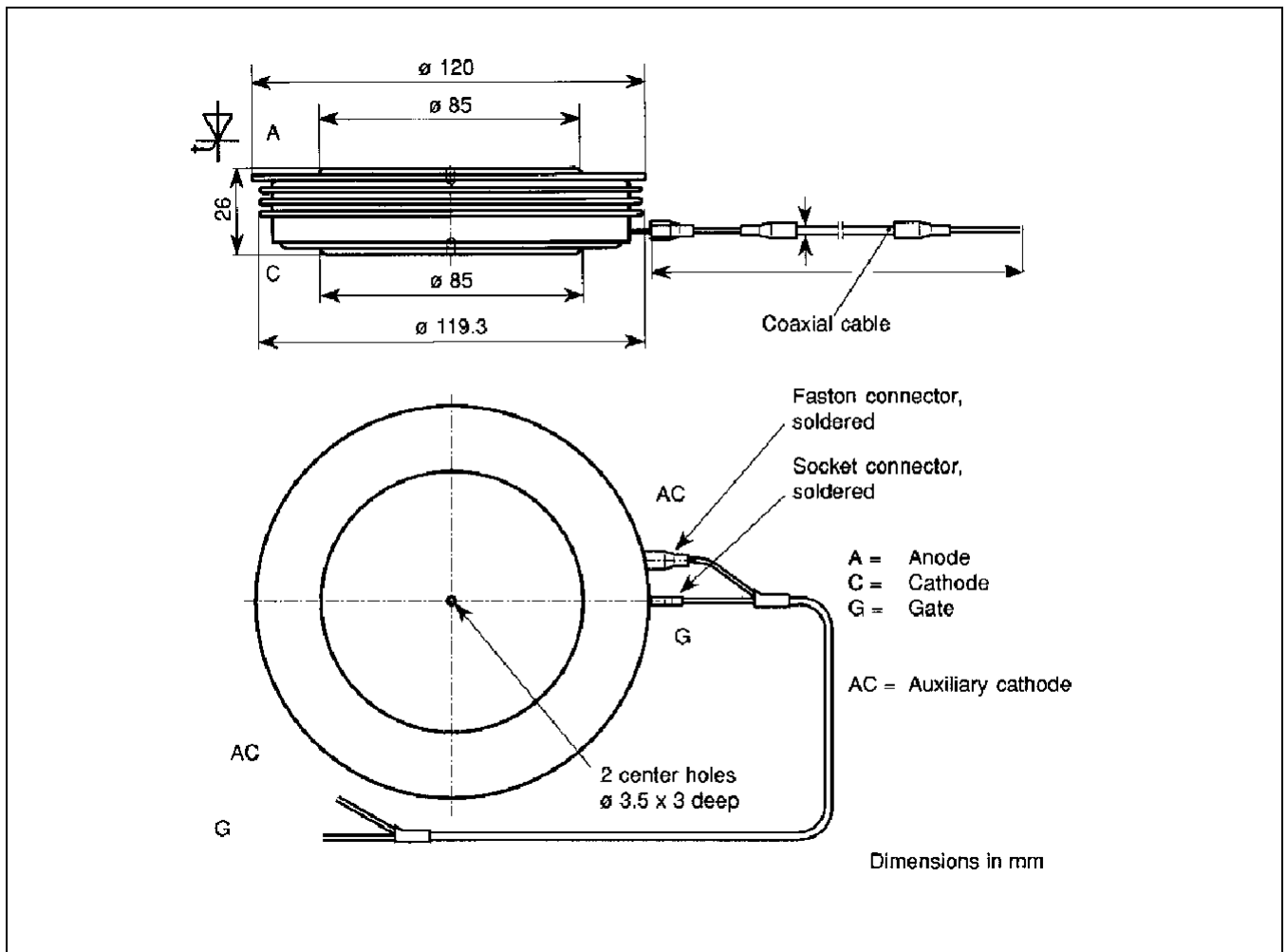

Fig. 18 General current and voltage waveforms with GTO-specific symbols.





**Fig. 19** Outline drawing. All dimensions are in millimeters and represent nominal values unless stated otherwise.

The 5SGF 40L4502 is a 91 mm buffered layer GTO with exceptionally low dynamic and static losses designed to retro-fit all former 4 kA GTOs of the same voltage. It offers optimal trade-off between on-state and switching losses and is encapsulated in an industry-standard press pack housing 120 mm wide and 26 mm thick.

**ABB Switzerland Ltd, Semiconductors reserves the right to change specifications without notice.**



**ABB Switzerland Ltd**  
**Semiconductors**  
Fabrikstrasse 3  
CH-5600 Lenzburg, Switzerland

Telephone +41 (0)58 586 1419  
Fax +41 (0)58 586 1306  
Email [abbsem@ch.abb.com](mailto:abbsem@ch.abb.com)  
Internet [www.abb.com/semiconductors](http://www.abb.com/semiconductors)

## X-ON Electronics

Largest Supplier of Electrical and Electronic Components

*Click to view similar products for [SCRs category](#):*

*Click to view products by [ABB manufacturer](#):*

Other Similar products are found below :

[NTE5428](#) [T1500N16TOF VT](#) [T660N22TOF](#) [T720N18TOF](#) [T880N14TOF](#) [T880N16TOF](#) [TT162N16KOF-A](#) [TT162N16KOF-K](#)  
[TT330N16AOF](#) [VS-22RIA20](#) [VS-2N685](#) [057219R](#) [T1190N16TOF VT](#) [T1220N22TOF VT](#) [T201N70TOH](#) [T700N22TOF](#) [TT250N12KOF-K](#)  
[VS-110RKI40](#) [NTE5427](#) [NTE5442](#) [T2160N28TOF VT](#) [TT251N16KOF-K](#) [VS-22RIA100](#) [VS-16RIA40](#) [TD250N16KOF-A](#) [VS-ST110S16P0](#)  
[T930N36TOF VT](#) [T2160N24TOF VT](#) [T1190N18TOF VT](#) [T1590N28TOF VT](#) [2N1776A](#) [T590N14TOF](#) [NTE5375](#) [NTE5460](#) [NTE5481](#)  
[NTE5504](#) [NTE5512](#) [NTE5514](#) [NTE5518](#) [NTE5519](#) [NTE5529](#) [NTE5553](#) [NTE5555](#) [NTE5557](#) [NTE5567](#) [NTE5570](#) [NTE5572](#) [NTE5574](#)  
[NTE5576](#) [NTE5579](#)