

Reliability evaluation of IGCT based on demanding long-term application



In the last 20 years, IGCTs (Integrated Gate Commutated Thyristors) have been designed-in high power applications like motor drives, rail-interties, STATCOM, breakers and other demanding applications requiring the highest reliability. Over 250,000 IGCTs are in heavy duty field operation with excellent reliability.

IGCT design

The IGCT is an integration of a high-power semiconductor switch and a powerful gate unit (see Figure 1). The main components of the gate path are indicated in Figure 2. Its high reliability benefitted significantly from the experiences of GTO drives. Control of the IGCT is managed optically by the command signal and allows for control of the successful switching events by the status feedback signal (see Figure 1). Only a single voltage supply to the gate-unit is needed.

The power semiconductor is packaged in a hermetically sealed ceramic housing, using the free-floating press pack packaging technology. This packaging technology ensures the highest reliability.

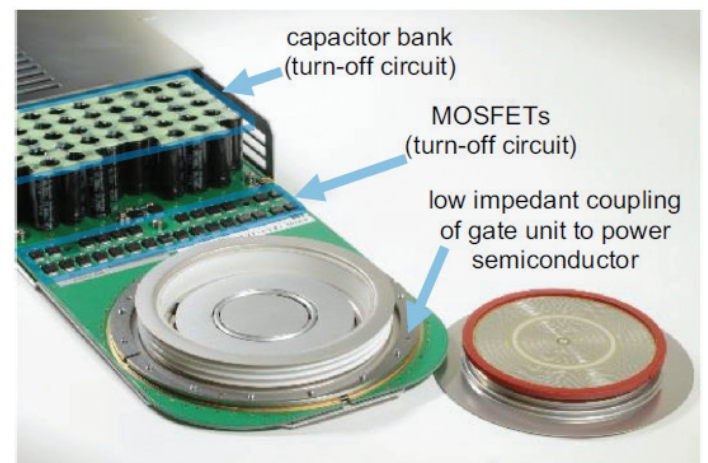

02 IGCT (5 kA turn-off capability, 4.5 kV max. blocking voltage).

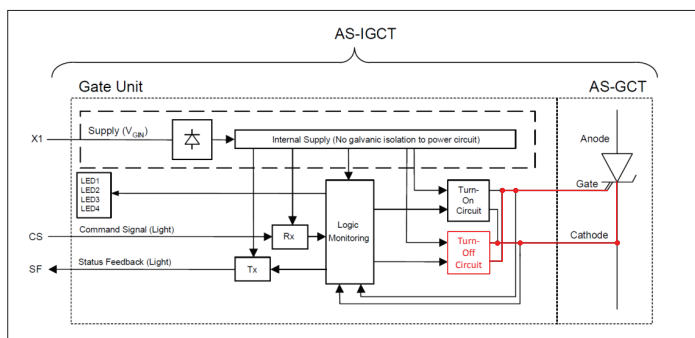

01 Block diagram of an IGCT. The turn-off channel is indicated in red [5].

Quality monitoring testing

The IGCT turn-off capability has improved significantly over the past 20 years. ABB's Quality Monitoring Program, shown in Figure 3, highlights progress of the turn-off capability.

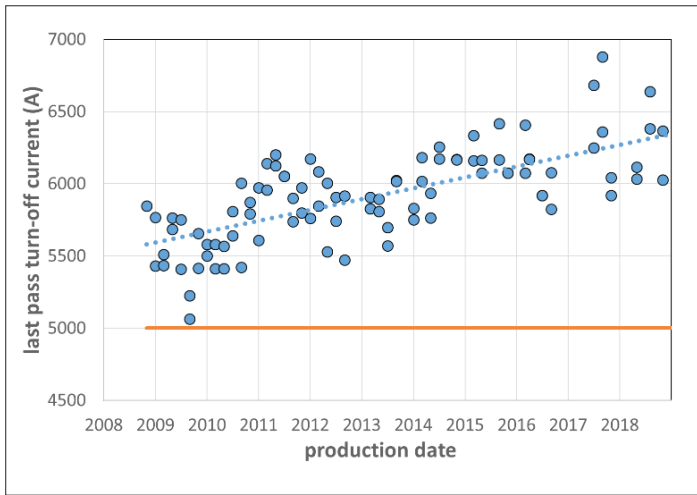

03 The specified turn-off capability (5SHY 55L4520 orange line). Last pass turn-off at $V_{oc}=2.8$ kV, 125 °C.

Reliability assessment and failure analysis

ABB works closely with end customers to collect and access field reliability. Figure 4 shows collected data. The field failure rate in FIT was calculated according to Eq. (1).

$$\text{Field failure rate} = (r \cdot 10^9) / (N \cdot T) \quad (1)$$

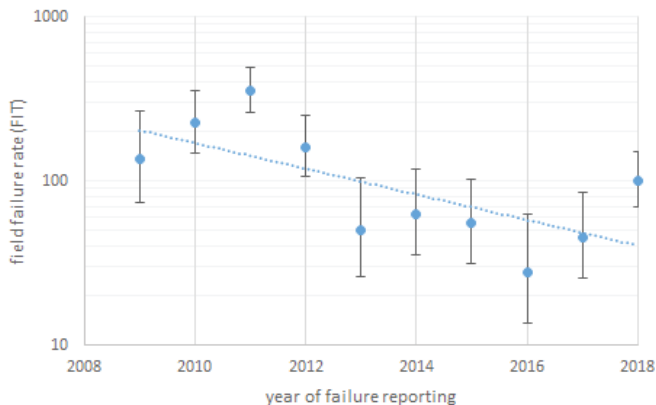

04 Field failure rate for a 91mm diameter IGCT with 4.5 kV blocking voltage in FIT.

As shown in Figure 4, the FIT rate has significantly reduced, especially since 2010.

The IGCT failure patterns are analyzed and categorized into different types, see Figure 5.

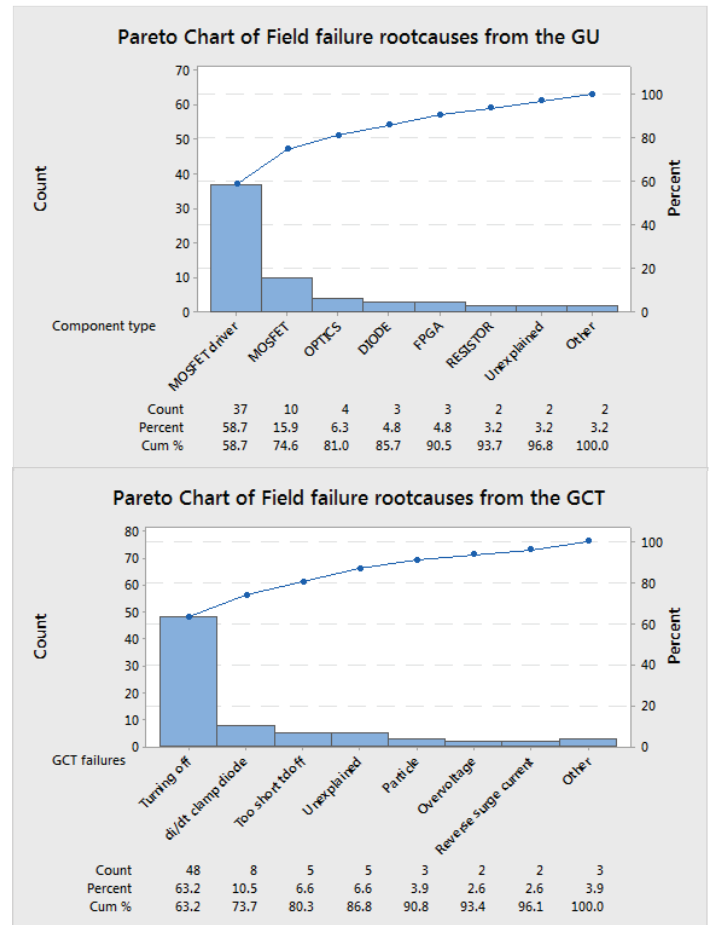

05 Pareto charts of the failure cause of returned field failed IGCTs. Upper chart shows gate unit failures, while bottom chart shows power semiconductor failures.

Lifetime estimation

Detailed analyzes have been conducted on devices returned after 15 years in operation as below.

For the construction of the Gotthard railway tunnel in Switzerland, a lift was installed to pull up the excavated gravel for 850 m (see Figure 6). The junction temperature T_{vj} during accelerating of the lift is shown in Figure 7.

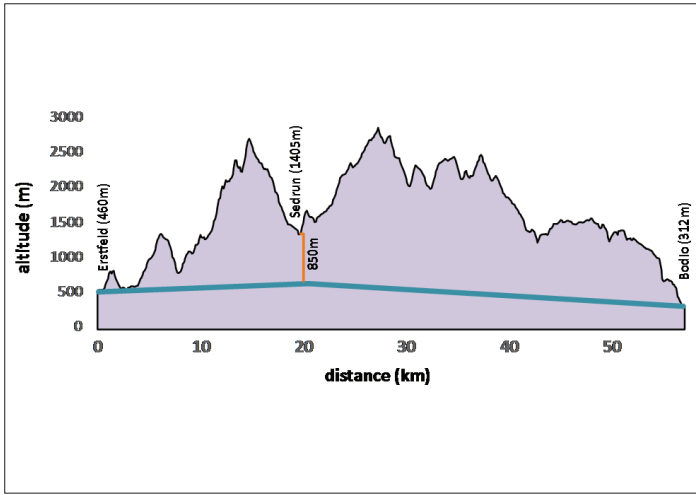

06 Sketch of the 57 km long Gotthard railway tunnel with the lift in Sedrun, Switzerland.

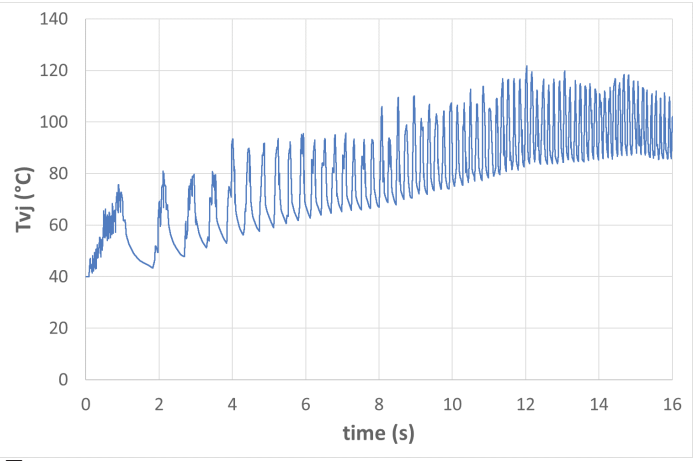

07 Calculated virtual junction temperature of the IGCTs during the acceleration phase of the lift cage in upwards direction.

After finishing the tunnel construction, the MV drive was dismantled and the IGCTs were sent back to the semiconductor fab for analysis of wear out.

The device from the Gotthard application does not show any degradation of the cathode metallization (see Figure 8). As a comparison, it was shown in the qualification, during the load cycling tests, that even devices with a degradation of the cathode segment metal height to 75 percent are still passing the device test specifications.

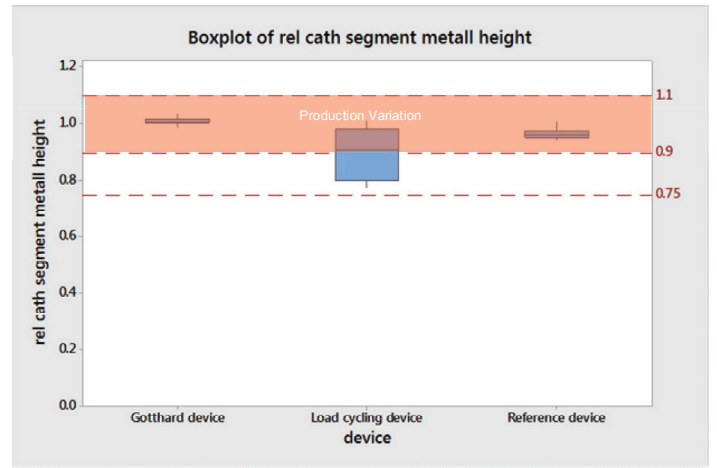

08 Histogram of the cathode segment metallization height of a load cycling tested device (140 kcycles $dT_{vj} = 80$ K). The typical production variation is indicated in light red.

Summary

The high current capability with low losses and excellent reliability make IGCT particularly suited for MV drives. Furthermore, IGCT, with its high surge current capability and long term SCFM capability, offers high potential for T&D applications.

Authors

Evgeny Tsyplakov, Makan Chen, Thomas Stiasny, Christian Winter, Olivier Quittard, Florian Weber, Jörg Berner, ABB Switzerland Ltd.

X-ON Electronics

Largest Supplier of Electrical and Electronic Components

Click to view similar products for [SCRs](#) category:

Click to view products by [ABB](#) manufacturer:

Other Similar products are found below :

[NTE5428](#) [T1500N16TOF VT](#) [T660N22TOF](#) [T720N18TOF](#) [T880N14TOF](#) [T880N16TOF](#) [TT162N16KOF-A](#) [TT162N16KOF-K](#)
[TT330N16AOF](#) [VS-22RIA20](#) [VS-2N685](#) [057219R](#) [T1190N16TOF VT](#) [T1220N22TOF VT](#) [T201N70TOH](#) [T700N22TOF](#) [TT250N12KOF-K](#)
[VS-110RKI40](#) [NTE5427](#) [NTE5442](#) [T2160N28TOF VT](#) [TT251N16KOF-K](#) [VS-22RIA100](#) [VS-16RIA40](#) [TD250N16KOF-A](#) [VS-ST110S16P0](#)
[T930N36TOF VT](#) [T2160N24TOF VT](#) [T1190N18TOF VT](#) [T1590N28TOF VT](#) [2N1776A](#) [T590N14TOF](#) [NTE5375](#) [NTE5460](#) [NTE5481](#)
[NTE5504](#) [NTE5512](#) [NTE5514](#) [NTE5518](#) [NTE5519](#) [NTE5529](#) [NTE5553](#) [NTE5555](#) [NTE5557](#) [NTE5567](#) [NTE5570](#) [NTE5572](#) [NTE5574](#)
[NTE5576](#) [NTE5579](#)