

# 5SNA 1000N330300

## HiPak IGBT Module

$$V_{CE} = 3300 \text{ V}$$

$$I_C = 1000 \text{ A}$$

Ultra low-loss, rugged SPT+ chip-set  
 Smooth switching SPT+ chip-set for good EMC  
 AISiC base-plate for high power cycling capability  
 AlN substrate for low thermal resistance  
 Improved high reliability package  
 Recognized under UL1557, File E196689



### Maximum rated values <sup>1)</sup>

Parameter	Symbol	Conditions	min	max	Unit
Collector-emitter voltage	$V_{CES}$	$V_{GE} = 0 \text{ V}$ , $T_{vj} \geq 25 \text{ }^\circ\text{C}$		3300	V
DC collector current	$I_C$	$T_C = 100 \text{ }^\circ\text{C}$ , $T_{vj} = 150 \text{ }^\circ\text{C}$		1000	A
Peak collector current	$I_{CM}$	$t_p = 1 \text{ ms}$		2000	A
Gate-emitter voltage	$V_{GES}$		-20	20	V
Total power dissipation	$P_{tot}$	$T_C = 25 \text{ }^\circ\text{C}$ , $T_{vj} = 150 \text{ }^\circ\text{C}$		9800	W
DC forward current	$I_F$			1000	A
Peak forward current	$I_{FRM}$	$t_p = 1 \text{ ms}$		2000	A
Surge current	$I_{FSM}$	$V_R = 0 \text{ V}$ , $T_{vj} = 150 \text{ }^\circ\text{C}$ , $t_p = 10 \text{ ms}$ , half-sinewave		9000	A
IGBT short circuit SOA	$t_{psc}$	$V_{CC} = 2500 \text{ V}$ , $V_{CEM \text{ CHIP}} \leq 3300 \text{ V}$ $V_{GE} \leq 15 \text{ V}$ , $T_{vj} \leq 150 \text{ }^\circ\text{C}$		10	$\mu\text{s}$
Isolation voltage	$V_{ISOL}$	1 min, $f = 50 \text{ Hz}$		6000	V
Junction temperature	$T_{vj}$			175	$^\circ\text{C}$
Junction operating temperature	$T_{vj(op)}$		-50	150	$^\circ\text{C}$
Case temperature	$T_C$		-50	150	$^\circ\text{C}$
Storage temperature	$T_{stg}$		-50	125	$^\circ\text{C}$
Mounting torques <sup>2)</sup>	$M_s$	Base-heatsink, M6 screws	4	6	Nm
	$M_{t1}$	Main terminals, M8 screws	8	10	
	$M_{t2}$	Auxiliary terminals, M4 screws	2	3	

<sup>1)</sup> Maximum rated values indicate limits beyond which damage to the device may occur per IEC 60747

<sup>2)</sup> for detailed mounting instructions refer to Document No. 5SYA 2039

**IGBT characteristic values <sup>3)</sup>**

Parameter	Symbol	Conditions	min	typ	max	Unit
Collector (-emitter) breakdown voltage	$V_{(BR)CES}$	$V_{GE} = 0 \text{ V}$ , $I_C = 10 \text{ mA}$ , $T_{vj} = 25 \text{ °C}$	3300			V
Collector-emitter <sup>4)</sup> saturation voltage	$V_{CE \text{ sat}}$	$I_C = 1000 \text{ A}$ , $V_{GE} = 15 \text{ V}$	$T_{vj} = 25 \text{ °C}$	2.5	2.9	V
			$T_{vj} = 125 \text{ °C}$	3.1	3.4	V
			$T_{vj} = 150 \text{ °C}$	3.25		V
Collector cut-off current	$I_{CES}$	$V_{CE} = 3300 \text{ V}$ , $V_{GE} = 0 \text{ V}$	$T_{vj} = 25 \text{ °C}$	0.04	0.67	mA
			$T_{vj} = 125 \text{ °C}$	13.5	27	mA
			$T_{vj} = 150 \text{ °C}$	67		mA
Gate leakage current	$I_{GES}$	$V_{CE} = 0 \text{ V}$ , $V_{GE} = \pm 20 \text{ V}$ , $T_{vj} = 125 \text{ °C}$	-500		500	nA
Gate-emitter threshold voltage	$V_{GE(TO)}$	$I_C = 160 \text{ mA}$ , $V_{CE} = V_{GE}$ , $T_{vj} = 25 \text{ °C}$	5		7	V
Gate charge	$Q_{ge}$	$I_C = 1000 \text{ A}$ , $V_{CE} = 1800 \text{ V}$ , $V_{GE} = -15 \text{ V} \dots 15 \text{ V}$		7.33		$\mu\text{C}$
Input capacitance	$C_{ies}$	$V_{CE} = 25 \text{ V}$ , $V_{GE} = 0 \text{ V}$ , $f = 1 \text{ MHz}$ , $T_{vj} = 25 \text{ °C}$		101		nF
Output capacitance	$C_{oes}$			8.4		nF
Reverse transfer capacitance	$C_{res}$			2.57		nF
Turn-on delay time	$t_{d(on)}$	$V_{CC} = 1800 \text{ V}$ , $I_C = 1000 \text{ A}$ , $R_G = 1.5 \text{ }\Omega$ , $C_{GE} = 220 \text{ nF}$ , $V_{GE} = \pm 15 \text{ V}$ , $L_\sigma = 100 \text{ nH}$ , inductive load	$T_{vj} = 25 \text{ °C}$	560		ns
			$T_{vj} = 125 \text{ °C}$	530		ns
			$T_{vj} = 150 \text{ °C}$	530		ns
Rise time	$t_r$	$V_{CC} = 1800 \text{ V}$ , $I_C = 1000 \text{ A}$ , $R_G = 1.5 \text{ }\Omega$ , $C_{GE} = 220 \text{ nF}$ , $V_{GE} = \pm 15 \text{ V}$ , $L_\sigma = 100 \text{ nH}$ , inductive load	$T_{vj} = 25 \text{ °C}$	240		ns
			$T_{vj} = 125 \text{ °C}$	255		ns
			$T_{vj} = 150 \text{ °C}$	260		ns
Turn-off delay time	$t_{d(off)}$	$V_{CC} = 1800 \text{ V}$ , $I_C = 1000 \text{ A}$ , $R_G = 2.2 \text{ }\Omega$ , $C_{GE} = 220 \text{ nF}$ , $V_{GE} = \pm 15 \text{ V}$ , $L_\sigma = 100 \text{ nH}$ , inductive load	$T_{vj} = 25 \text{ °C}$	1465		ns
			$T_{vj} = 125 \text{ °C}$	1640		ns
			$T_{vj} = 150 \text{ °C}$	1700		ns
Fall time	$t_f$	$V_{CC} = 1800 \text{ V}$ , $I_C = 1000 \text{ A}$ , $R_G = 2.2 \text{ }\Omega$ , $C_{GE} = 220 \text{ nF}$ , $V_{GE} = \pm 15 \text{ V}$ , $L_\sigma = 100 \text{ nH}$ , inductive load	$T_{vj} = 25 \text{ °C}$	315		ns
			$T_{vj} = 125 \text{ °C}$	385		ns
			$T_{vj} = 150 \text{ °C}$	400		ns
Turn-on switching energy	$E_{on}$	$V_{CC} = 1800 \text{ V}$ , $I_C = 1000 \text{ A}$ , $R_G = 1.5 \text{ }\Omega$ , $C_{GE} = 220 \text{ nF}$ , $V_{GE} = \pm 15 \text{ V}$ , $L_\sigma = 100 \text{ nH}$ , inductive load	$T_{vj} = 25 \text{ °C}$	1250		mJ
			$T_{vj} = 125 \text{ °C}$	1640		mJ
			$T_{vj} = 150 \text{ °C}$	1800		mJ
Turn-off switching energy	$E_{off}$	$V_{CC} = 1800 \text{ V}$ , $I_C = 1000 \text{ A}$ , $R_G = 2.2 \text{ }\Omega$ , $C_{GE} = 220 \text{ nF}$ , $V_{GE} = \pm 15 \text{ V}$ , $L_\sigma = 100 \text{ nH}$ , inductive load	$T_{vj} = 25 \text{ °C}$	1240		mJ
			$T_{vj} = 125 \text{ °C}$	1730		mJ
			$T_{vj} = 150 \text{ °C}$	1870		mJ
Short circuit current	$I_{sc}$	$t_{psc} \leq 10 \text{ }\mu\text{s}$ , $V_{GE} = 15 \text{ V}$ , $V_{CC} = 2500 \text{ V}$ , $V_{CEM \text{ CHIP}} \leq 3300 \text{ V}$	$T_{vj} = 150 \text{ °C}$	4270		A

<sup>3)</sup> Characteristic values according to IEC 60747 - 9

<sup>4)</sup> Collector-emitter saturation voltage is given at chip level

## Diode characteristic values <sup>5)</sup>

Parameter	Symbol	Conditions	min	typ	max	Unit	
Forward voltage <sup>6)</sup>	$V_F$	$I_F = 1000 \text{ A}$	$T_{vj} = 25 \text{ }^\circ\text{C}$	2.05	2.5	V	
			$T_{vj} = 125 \text{ }^\circ\text{C}$		2.25	2.6	V
			$T_{vj} = 150 \text{ }^\circ\text{C}$		2.20		V
Reverse recovery current	$I_{rr}$		$T_{vj} = 25 \text{ }^\circ\text{C}$		1010	A	
			$T_{vj} = 125 \text{ }^\circ\text{C}$		1180	A	
			$T_{vj} = 150 \text{ }^\circ\text{C}$		1230	A	
Recovered charge	$Q_{rr}$	$V_{CC} = 1800 \text{ V},$ $I_F = 1000 \text{ A},$ $V_{GE} = \pm 15 \text{ V},$ $R_G = 1.5 \text{ } \Omega, C_{GE} = 220 \text{ nF},$ $di/dt = 4 \text{ kA}/\mu\text{s}$ $L_\sigma = 100 \text{ nH},$ inductive load	$T_{vj} = 25 \text{ }^\circ\text{C}$		630	$\mu\text{C}$	
			$T_{vj} = 125 \text{ }^\circ\text{C}$		1020	$\mu\text{C}$	
			$T_{vj} = 150 \text{ }^\circ\text{C}$		1180	$\mu\text{C}$	
Reverse recovery time	$t_{rr}$		$T_{vj} = 25 \text{ }^\circ\text{C}$		1125	ns	
			$T_{vj} = 125 \text{ }^\circ\text{C}$		1440	ns	
			$T_{vj} = 150 \text{ }^\circ\text{C}$		1630	ns	
Reverse recovery energy	$E_{rec}$		$T_{vj} = 25 \text{ }^\circ\text{C}$		700	mJ	
			$T_{vj} = 125 \text{ }^\circ\text{C}$		1210	mJ	
			$T_{vj} = 150 \text{ }^\circ\text{C}$		1420	mJ	

<sup>5)</sup> Characteristic values according to IEC 60747 - 2

<sup>6)</sup> Forward voltage is given at chip level

## Package properties <sup>7)</sup>

Parameter	Symbol	Conditions	min	typ	max	Unit
IGBT thermal resistance junction to case	$R_{th(j-c)IGBT}$				0.013	K/W
Diode thermal resistance junction to case	$R_{th(j-c)DIODE}$				0.025	K/W
IGBT thermal resistance <sup>2)</sup> case to heatsink	$R_{th(c-s)IGBT}$	IGBT per switch, $\lambda$ grease = 1W/m x K		0.012		K/W
Diode thermal resistance <sup>2)</sup> case to heatsink	$R_{th(c-s)DIODE}$	Diode per switch, $\lambda$ grease = 1W/m x K		0.024		K/W
Comparative tracking index	CTI		600			
Module stray inductance	$L_{\sigma CE}$			12		nH
Resistance, terminal-chip	$R_{CC'+EE'}$		$T_C = 25 \text{ }^\circ\text{C}$		0.083	m $\Omega$
			$T_C = 125 \text{ }^\circ\text{C}$		0.113	
			$T_C = 150 \text{ }^\circ\text{C}$		0.120	

<sup>2)</sup> for detailed mounting instructions refer to Document No. 5SYA 2039

## Mechanical properties <sup>7)</sup>

Parameter	Symbol	Conditions	min	typ	max	Unit
Dimensions	L x W x H	Typical		130 x 140 x 38		mm
Clearance distance in air	$d_a$	according to IEC 60664-1 and EN 50124-1	Term. to base:	19		mm
			Term. to term:	19		
Surface creepage distance	$d_s$	according to IEC 60664-1 and EN 50124-1	Term. to base:	28.2		mm
			Term. to term:	28.2		
Mass	m			820		g

<sup>7)</sup> Package and mechanical properties according to IEC 60747 - 15

## Electrical configuration

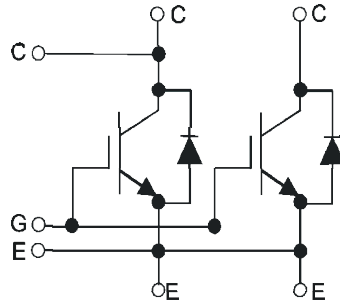

## Outline drawing <sup>2)</sup>

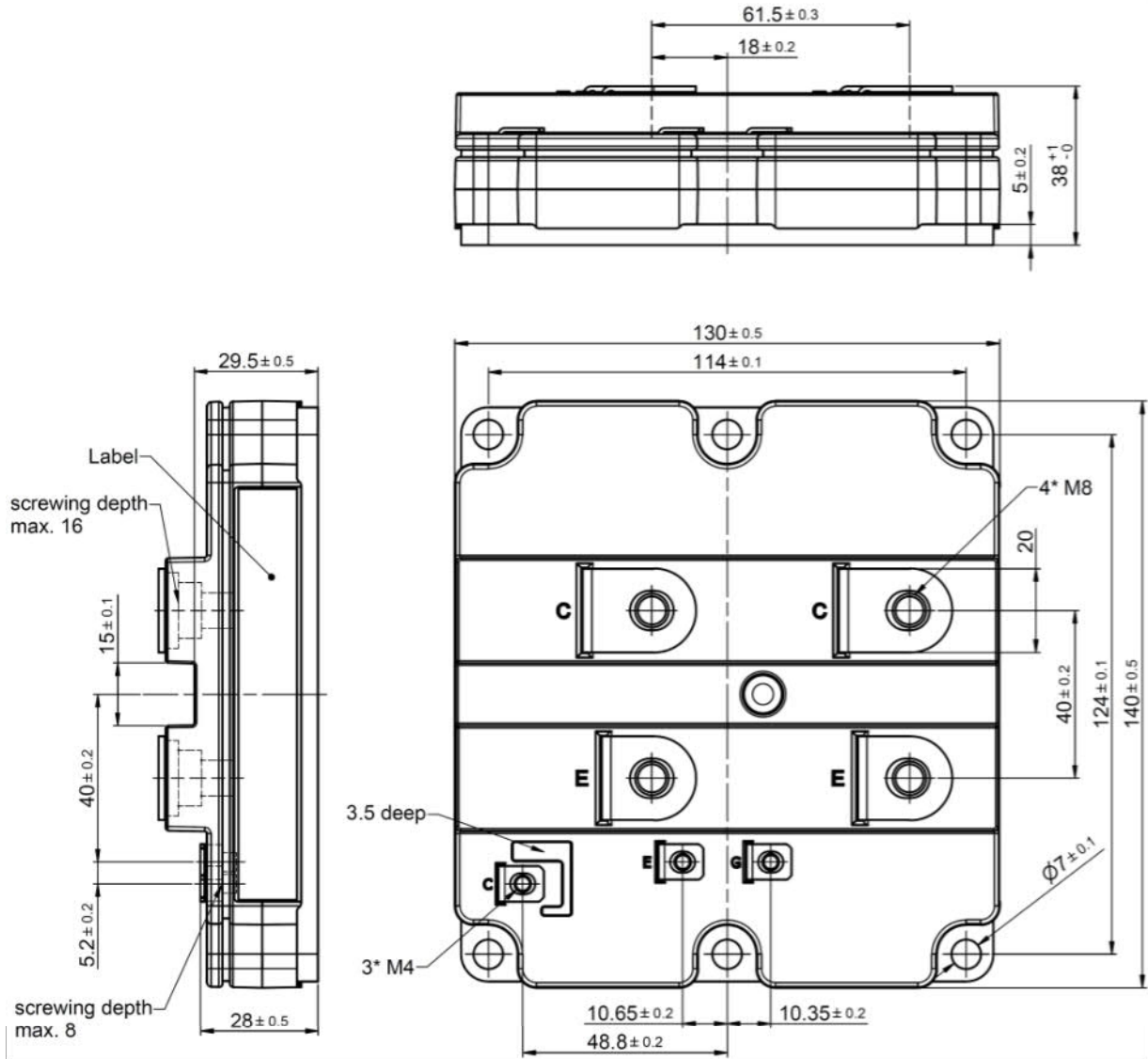

Note: all dimensions are shown in millimeters  
<sup>2)</sup> For detailed mounting instructions refer to Document No. 5SYA 2039

This is an electrostatic sensitive device, please observe the international standard IEC 60747-1, chap. IX.  
 This product has been designed and qualified for Industrial Level.

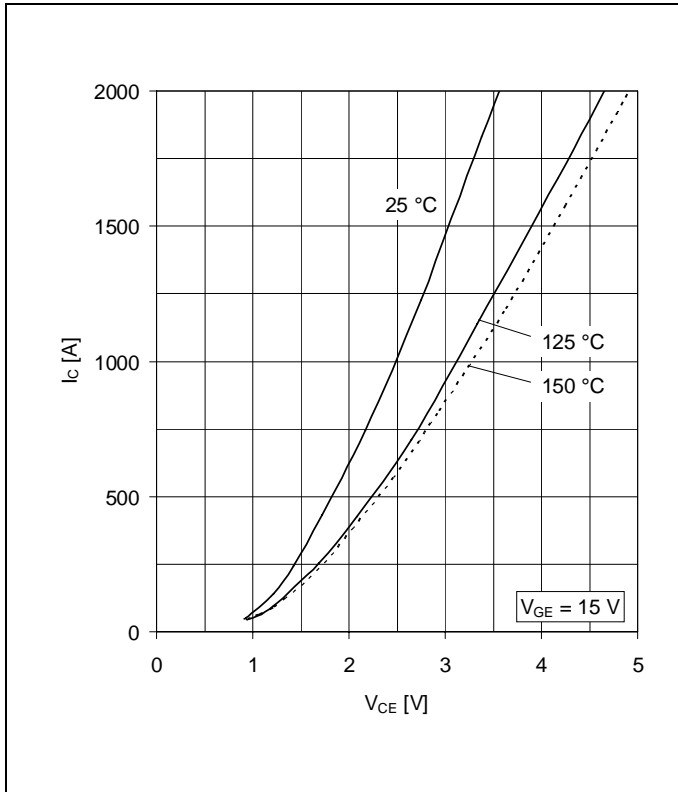

Fig. 1 Typical on-state characteristics, chip level

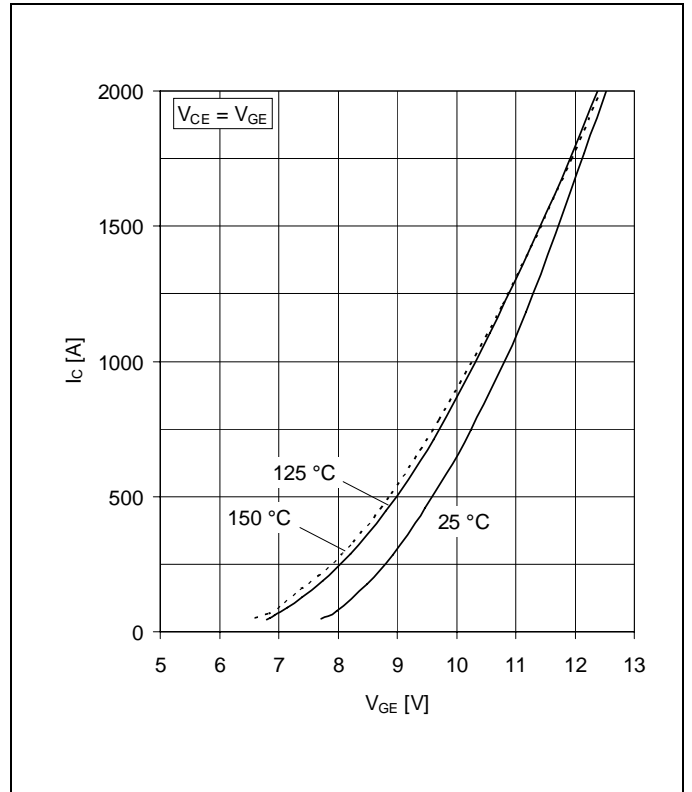

Fig. 2 Typical transfer characteristics, chip level

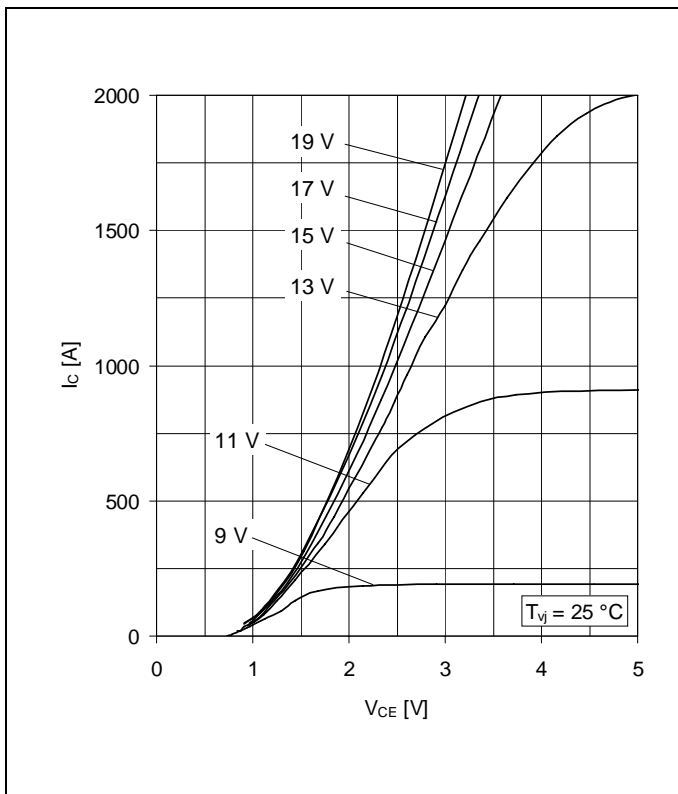

Fig. 3 Typical output characteristics, chip level

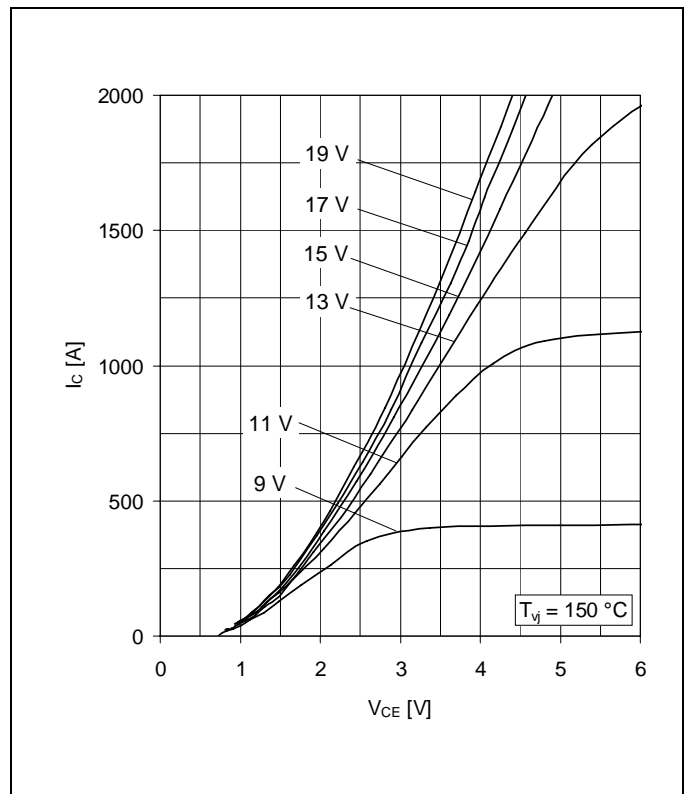

Fig. 4 Typical output characteristics, chip level

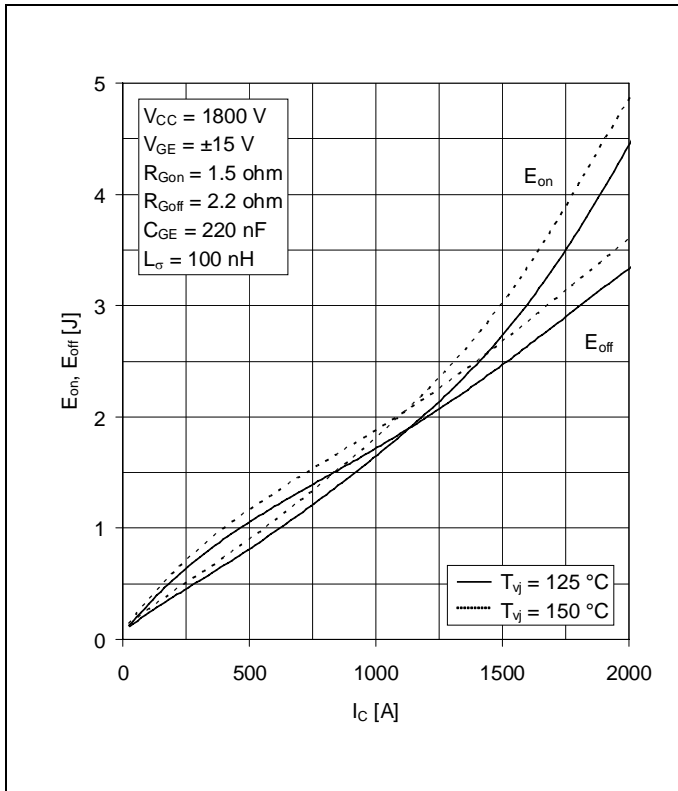

Fig. 5 Typical switching energies per pulse vs. collector current

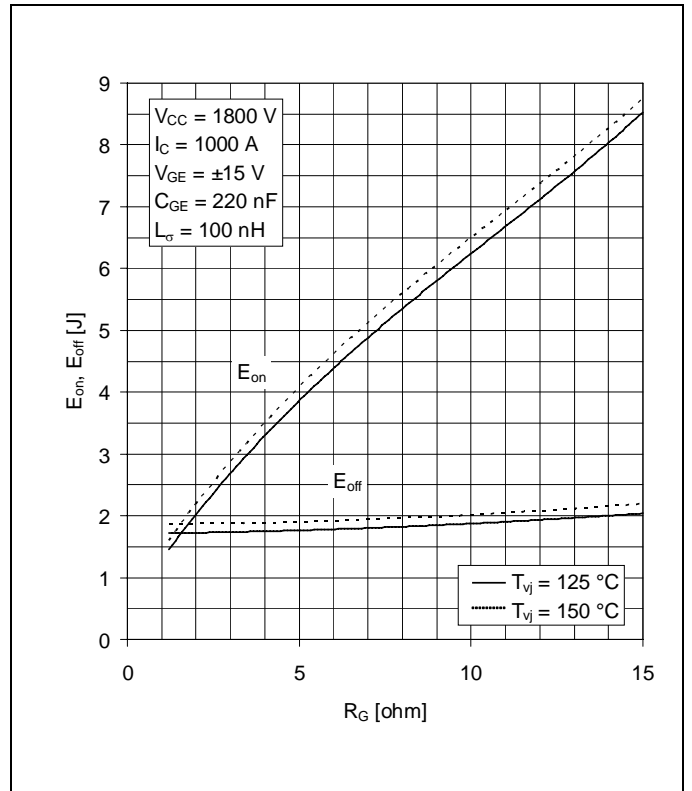

Fig. 6 Typical switching energies per pulse vs. gate resistor

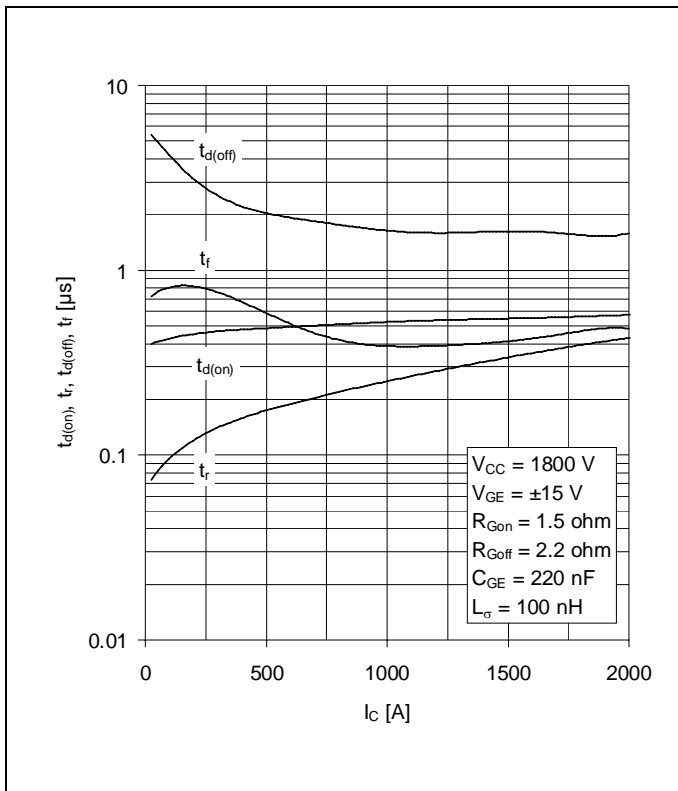

Fig. 7 Typical switching times vs. collector current

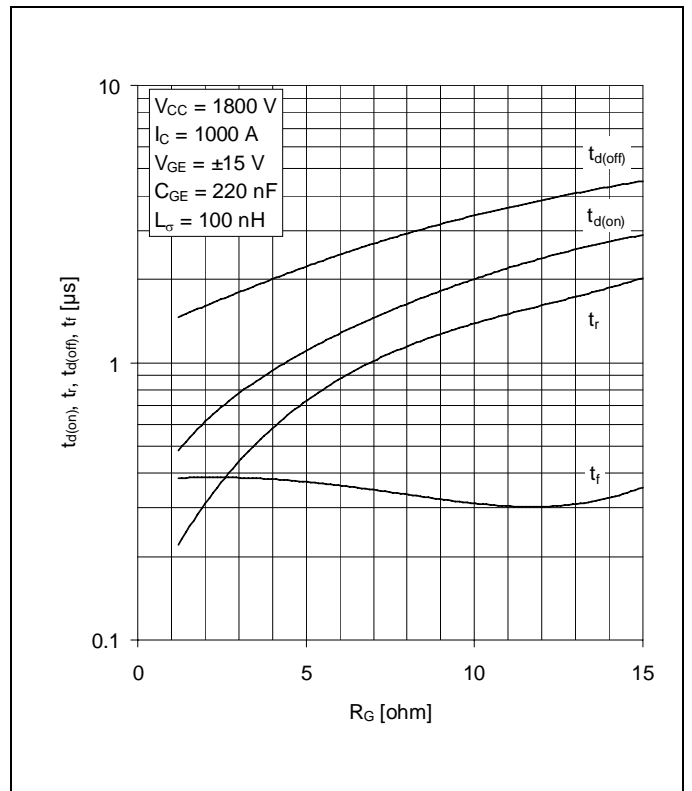

Fig. 8 Typical switching times vs. gate resistor

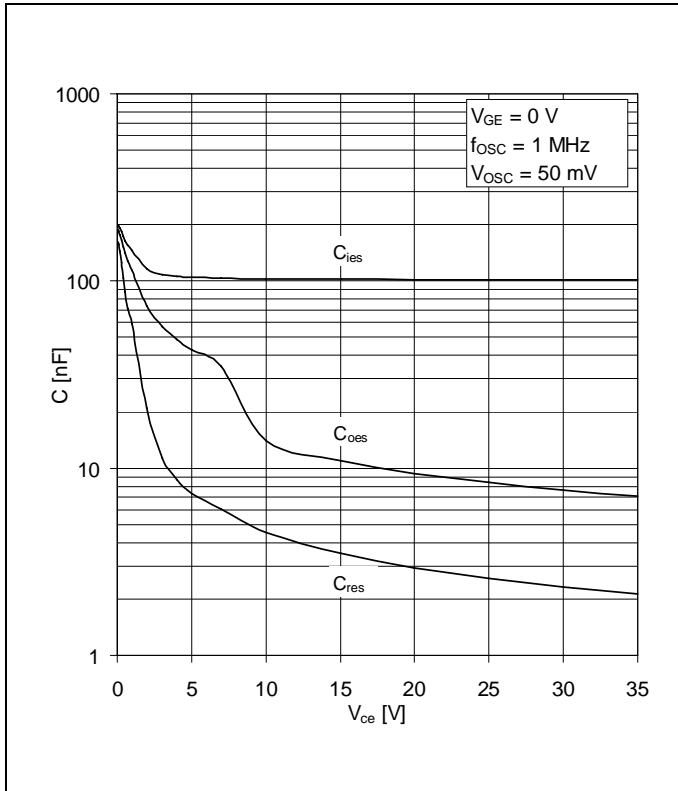

Fig. 9 Typical capacitances vs. collector-emitter voltage

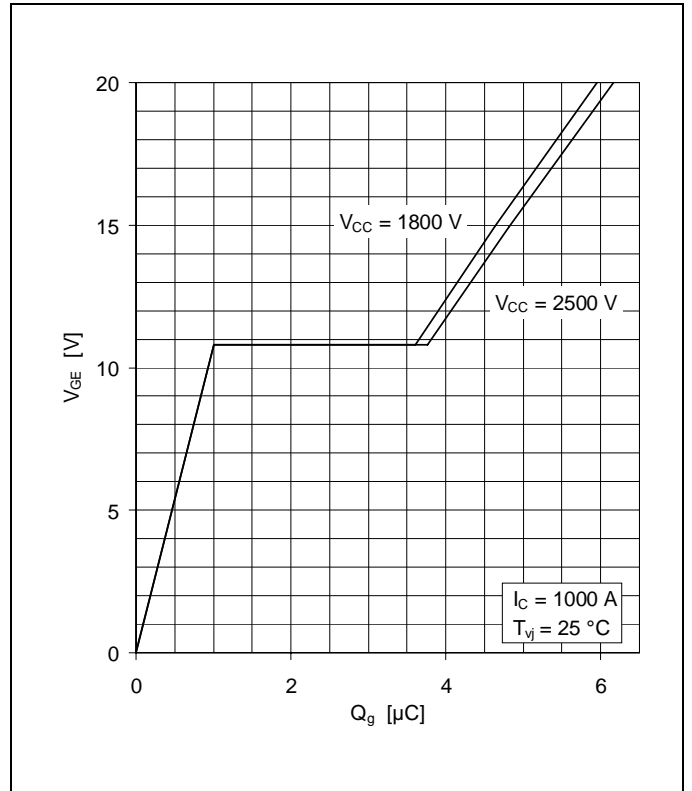

Fig. 10 Typical gate charge characteristics

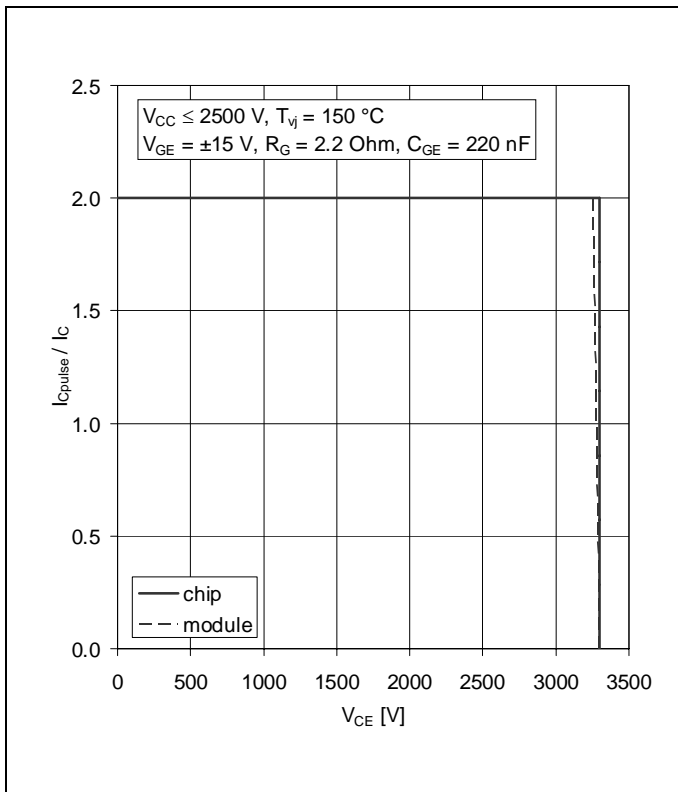

Fig. 11 Turn-off safe operating area (RBSOA)

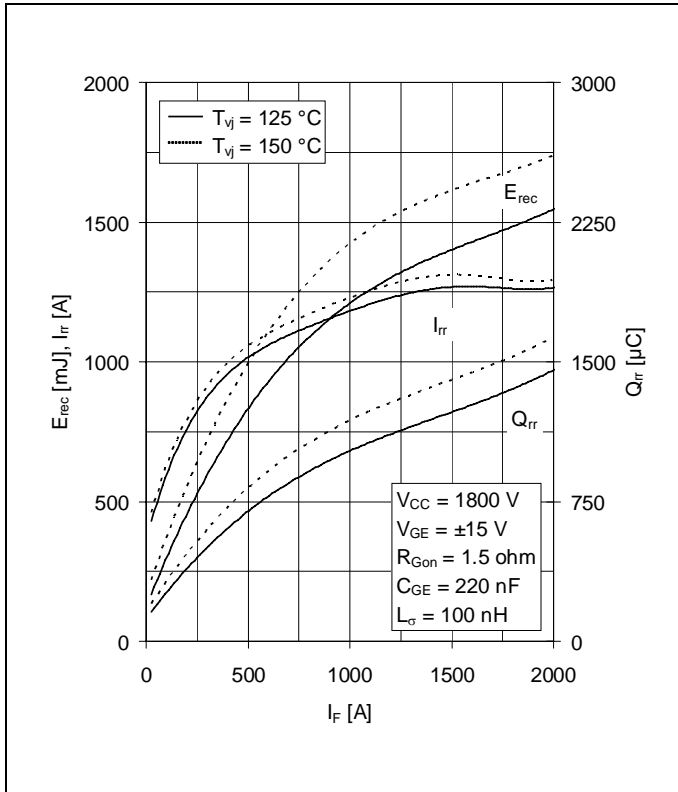

Fig. 12 Typical reverse recovery characteristics vs. forward current

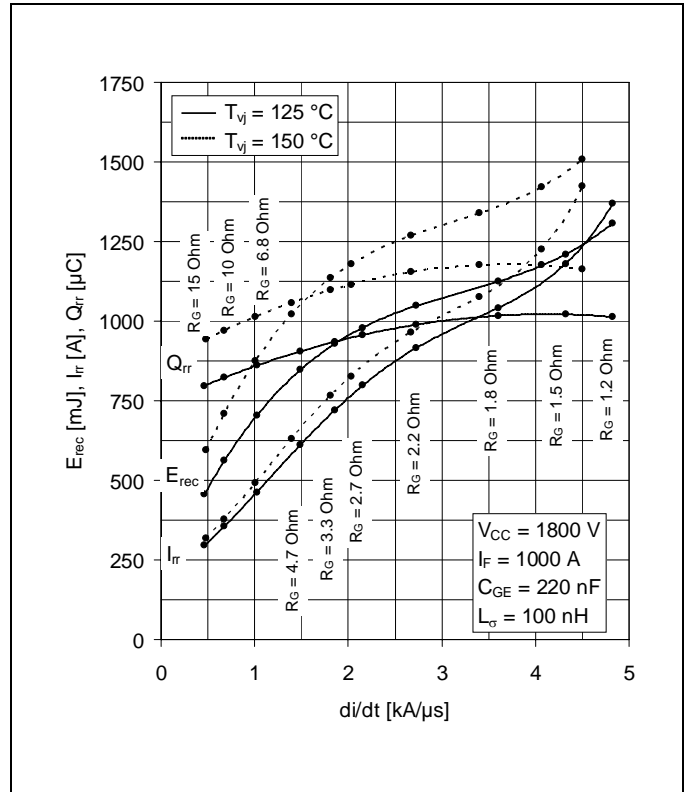

Fig. 13 Typical reverse recovery characteristics vs. di/dt

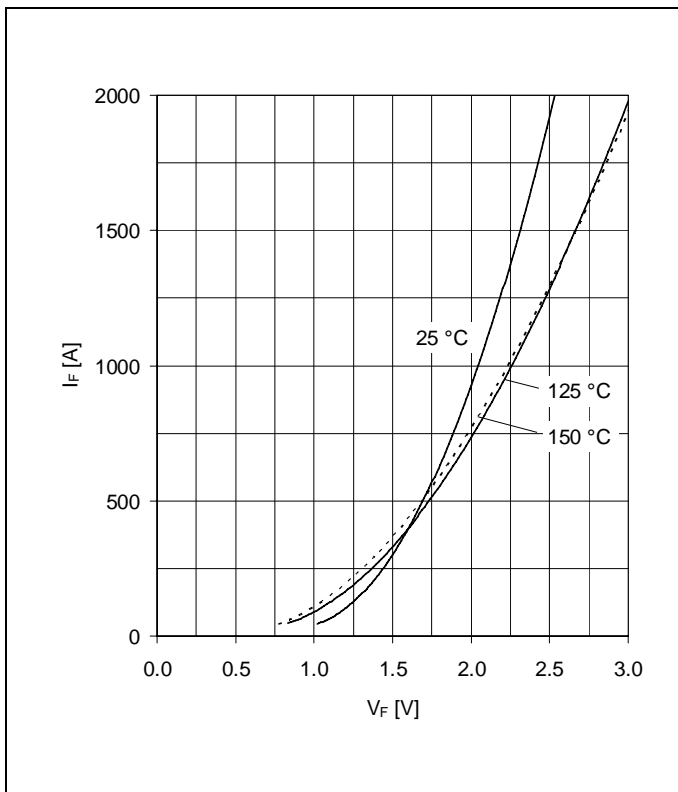

Fig. 14 Typical diode forward characteristics chip level

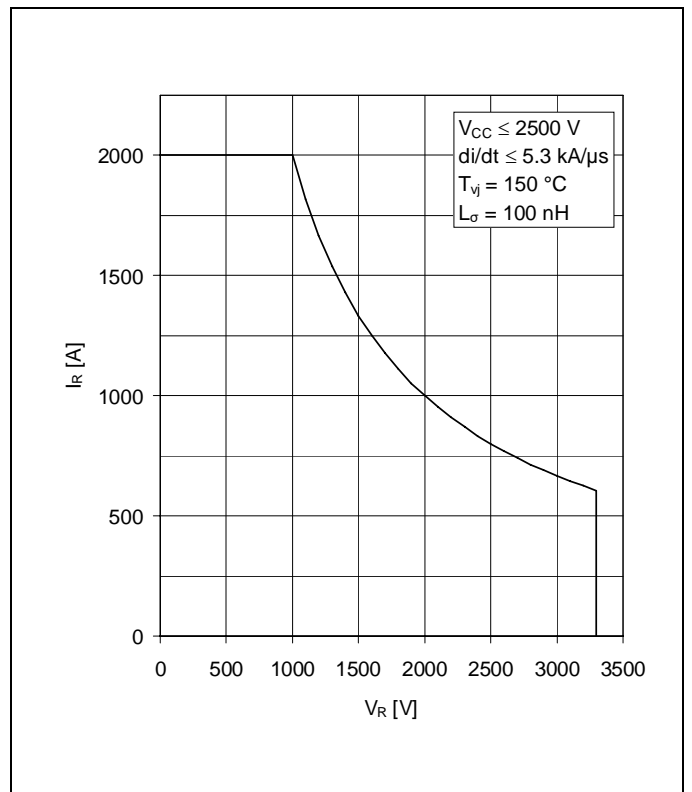

Fig. 15 Safe operating area diode (SOA)



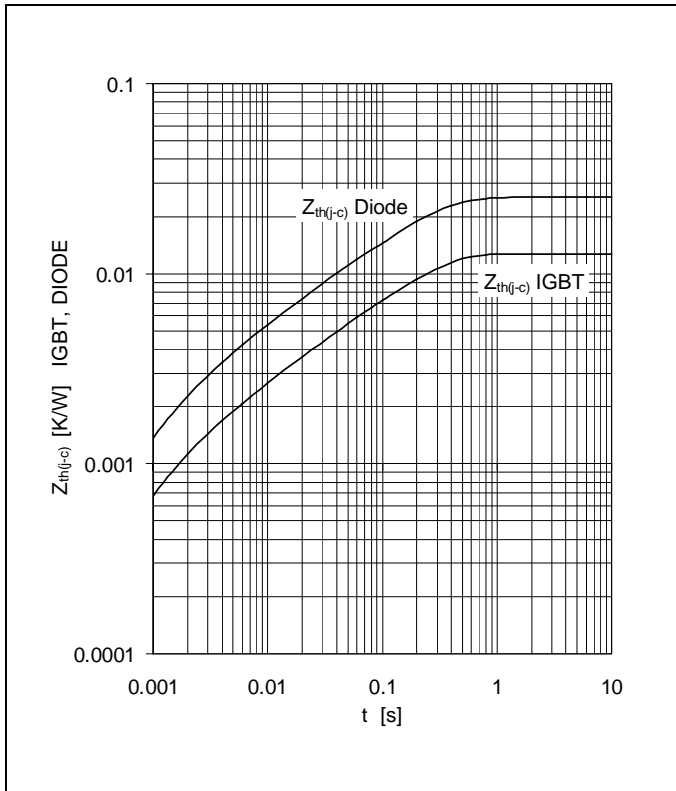

Fig. 16 Thermal impedance vs. time

Analytical function for transient thermal impedance:

$$Z_{th(j-c)}(t) = \sum_{i=1}^n R_i (1 - e^{-t/\tau_i})$$

i	1	2	3	4	5
Ri(K/kW)	8.78	2.06	0.961	0.948	
$\tau_i$ (ms)	207.4	30.1	7.55	1.57	
DIODE					
Ri(K/kW)	17.1	4.28	1.92	1.92	
$\tau_i$ (ms)	203.6	30.1	7.53	1.57	

**Related documents:**

- 5SYA 2042 Failure rates of HiPak modules due to cosmic rays
- 5SYA 2043 Load - cycle capability of HiPaks
- 5SYA 2045 Thermal runaway during blocking
- 5SYA 2053 Applying IGBT
- 5SYA 2058 Surge currents for IGBT diodes
- 5SYA 2093 Thermal design of IGBT modules
- 5SYA 2098 Paralleling of IGBT modules
- 5SZK 9111 Specification of environmental class for HiPak Storage
- 5SZK 9112 Specification of environmental class for HiPak Transportation
- 5SZK 9113 Specification of environmental class for HiPak Operation (Industry)
- 5SZK 9120 Specification of environmental class for HiPak

ABB Power Grids Switzerland Ltd, Semiconductors  
 A Hitachi ABB Joint Venture  
 Fabrikstrasse 3  
 CH-5600 Lenzburg  
 Switzerland  
[www.hitachiabb-powergrids.com/semiconductors](http://www.hitachiabb-powergrids.com/semiconductors)

We reserve all rights in this document and in the subject matter and illustrations contained therein. Any reproduction, disclosure to third parties or utilization of its contents - in whole or in parts - is forbidden without prior written consent. Copyright 2020 Hitachi Powergrids. All rights reserved.

## X-ON Electronics

Largest Supplier of Electrical and Electronic Components

*Click to view similar products for [IGBT Modules category](#):*

*Click to view products by [ABB manufacturer](#):*

Other Similar products are found below :

[F3L400R07ME4\\_B22](#) [F4-50R07W2H3\\_B51](#) [FB15R06W1E3](#) [FB20R06W1E3\\_B11](#) [FD1000R33HE3-K](#) [FD400R12KE3](#) [FD400R33KF2C-K](#)  
[FD401R17KF6C\\_B2](#) [FD-DF80R12W1H3\\_B52](#) [FF200R06YE3](#) [FF450R12ME4P](#) [FF600R12IP4V](#) [FP06R12W1T4\\_B3](#) [FP10R06W1E3\\_B11](#)  
[FP15R12W2T4](#) [FP20R06W1E3](#) [FP75R07N2E4\\_B11](#) [FS10R12YE3](#) [FS150R07PE4](#) [FS150R12PT4](#) [FS20R06W1E3\\_B11](#) [FS50R07N2E4\\_B11](#)  
[FZ1000R33HE3](#) [FZ1800R17KF4](#) [DD250S65K3](#) [DF1000R17IE4](#) [DF1000R17IE4D\\_B2](#) [DF1400R12IP4D](#) [DF200R12PT4\\_B6](#)  
[DF400R07PE4R\\_B6](#) [BSM75GB120DN2\\_E3223c-Se](#) [F3L300R12ME4\\_B22](#) [F3L75R07W2E3\\_B11](#) [F4-50R12KS4\\_B11](#) [FD1400R12IP4D](#)  
[FD200R12PT4\\_B6](#) [FD800R33KF2C-K](#) [FF150R12ME3G](#) [FF300R17KE3\\_S4](#) [FF300R17ME4\\_B11](#) [FF401R17KF6C\\_B2](#) [FF650R17IE4D\\_B2](#)  
[FF900R12IP4D](#) [FF900R12IP4DV](#) [FP30R06W1E3\\_B11](#) [FP50R07N2E4\\_B11](#) [FS100R07PE4](#) [FS150R07N3E4\\_B11](#) [FS150R17N3E4](#)  
[FS150R17PE4](#)