

# Infinity S™ Power System

Compact, Dual Voltage, Rack Mounted Power System



## Overview

The GE Infinity S™ DC energy system is a compact power plant that supports dual voltage (+24V/-48V) operation through the use of a comprehensive range of advanced rectifiers and DC-DC converters. Primary voltage is supported by rectifiers and battery reserve, while secondary voltage is supported by DC-DC converter modules. Primary voltage can be -48V or +24V.

The Infinity S Power System has primary voltage capacity for +24V and -48V power up to 800A; secondary voltage capacity is up to 120A per expansion module.

## Shelf / Bay Options

Infinity S systems features mounting rails for field install applications and may be equipped in a 7 ft 23" relay rack; or a half height rack for mounting on battery stands. The distribution module is 4U tall and accommodates up to 26 single voltage or selectable voltage bullet breaker positions. Universal shelves are 1U tall with four slots that accept any Infinity series rectifier or converter interchangeably in any power slot. This allows the available slots to be filled with the mix of power modules desired. The only restriction is whether AC power

- Dual Voltage power system with ultimate flexibility
- -48V up to 600A (32KW) or +24V up to 800A (22KW)
- Secondary voltage up to 120A
- High availability wireless telecom applications
- Telecom service providers
- Efficiency approaching 97%

is applied to the shelf. This gives extreme flexibility in the provisioning of power modules within the system.

## Infinity Rectifier and Converter Family

The Infinity S offers DC rectifiers and converters for +24V to -48V applications. Rectifiers and converters are color coded to quickly identify both the voltage and whether it is a rectifier or converter (orange for +24V and blue for -48V).

Rectifier and Converter Options:

- NE100AC24ATEZ Rectifier, 100A/24V Output
- NE050AC48ATEZ Rectifier, 50A/48V Output
- NE075DC24 Converter, 75A/24V Output
- NE030DC48 Converter, 30A/48V Output

## Pulsar Plus Controller

The Infinity S utilizes the industry leading Pulsar Plus controller with Ethernet and SNMP communications to deliver extensive monitoring and control features with remote access.

## Benefits

### Reliability

- Distributed fault tolerance
- Proven field performance
- Controller continuity

### Intelligence

- Industry leading controller features
- Ethernet interface for remote access
- Centralized network management

### Investment Protection

- Module Compatibility
- Secondary Voltage flexibility +24V / -48V
- Flexible Upgrade Options

### On Time Delivery

- Standard building blocks
- 4 - 6 week availability
- 24/7 technical support

### Total Efficiency

The GE Total Efficiency™ (TE) architecture reduces energy loss and lowers cooling costs by 50-70%. TE products will prioritize sustainable energy sources like solar, wind, water and fuel cells over traditional utility grid or diesel generator sources – and they will intelligently respond to smart grid information to reduce consumption during peak demand periods. Active Rectifier Management (ARM) and Battery Charging Optimization (BCO) features increase efficiency on current and legacy power infrastructures. The Total Efficiency architecture addresses issues end-to-end based on our proven experience and expertise in batteries, power distribution, DC energy systems, AC-DC power supplies, and DC-DC board mounted power to deliver a solution that is more safe, reliable and energy efficient than competitive alternatives.



# Infinity Rectifiers and Converters



- **Compact** – 1RU form factor providing high power density (24 W/in<sup>3</sup>)
- **Dual Voltage compatibility** – the unique connector pin designation allows the rectifier to be used in a “universal” power shelf, alongside rectifiers or DC-DC converters with different output voltages.
- **Plug and Play** – installation of the rectifier in a shelf connected to a compatible system controller initializes all set up parameters automatically. No adjustments are needed.
- **Extended service life** – parallel operation with automatic load sharing ensures that parallel units are not unduly stressed even when a unit fails or is removed.
- **Monitoring / control** – the built in microprocessor controls and monitors all critical rectifier functions and communicates with the system controller using the built in Galaxy Protocol serial interface.
- **Fail safe performance** – hot insertion capabilities allow for converter replacement without system shutdown; soft start and inrush current protection prevent nuisance tripping of upstream breakers.

## Applications

- Telecommunications networks
- Digital subscriber line (DSL)
- Indoor/outdoor wireless
- Routers/switches
- Fiber in the loop
- Transmission
- Data networks
- PBX

## Key Features

- Extended temperature range
- Redundant fan cooling
- Front panel LED indicators
- 1U height, hi power density
- 220/110V AC input
- Digital load sharing
- Hot pluggable
- RoHS compliant

## Specifications

Input	NE100AC24ATEZ	NE050AC48ATEZ	NE030DC48	NE075DC24
Voltage Range	95-275Vac	95-275Vac	21-30Vdc	42-60Vdc
Input Current	15-12A @ 100-120Vac 15A @ 200-240Vac	15-12A @ 100-120Vac 15A @ 200-240Vac	63A @ 27Vdc 81A @ 21Vdc	41A @ 54.5Vdc 54a @ 42Vdc
Input Frequency	45 – 66Hz	45 – 66Hz	-	-
Power Factor	0.98 at>50% load	0.98 at>50% load	-	-
Efficiency	> 95% (Peak 95.6%)	> 96% (Peak 96.9%)	-	-
Total Harmonic Distortion	<5% @loads over 50%	<5% @loads over 50%	-	-
Output				
Voltage Adjust Range	21-29Vdc	42-58Vdc	46-57Vdc	23-28Vdc
Voltage Nominal	27.25V	54.5V	52.0V	27.2V
Regulation (with controller)	±0.5%	±0.5%	±0.5%	±0.5%
Ripple	100mVrms	100mVrms	100mVrms	100mVrms
Output Current				
- High-Line	100A @27.25V	50A @54.5V	30A @52.0V	75A @27.2V
- Low-Line	44A @27.25V	22A @54.5V	-	-
Heat Dissipation @ max out	174W / 594 BTU/hr	158W / 539 BTU/hr	154W / 525 BTU/hr	202W / 689 BTU/hr

Environmental	
Operating Temperature	-40°C to +75°C (-40 to 167°F)
Storage Temperature	-40°C to +85°C (-40 to 185°F)
Humidity	< 95% non-condensing
Altitude	4000M (for altitudes above 2000M, peak operating temperature de-rates 0.656° C /100M; 4000M peak temperature rating is 62° C)
Mechanical	
Length (inch/mm)	13.85 / 351.8
Width (inch/mm)	5.23 / 133
Height (inch/mm)	1.63 / 42
Weight (lb/Kg)	5.05 / 2.2
Safety and Standards Compliance	
NEBs Level 3	Evaluated by independent NRTL test lab to Telcordia GR63, Issue 3 & GR 1089, Issue 5
Safety	CE mark to Low Voltage Directive 2006/95/EC and EMC Directive 2004/108/E (Rectifiers only) UL 60950-1, 2nd Ed. Recognized CSA C22.2 No. 60950-1-03 Certified
RoHS	Compliant to RoHS EU Directive 2002/95/EC; RoHS 6/6
EMC	European Directive 2004/108/EC; EN55022, Class A; EN55024; FCC, Class A; GR1089-CORE, Issue 5
ESD	EN61000-4-2, Level 4

**Outline Drawing**

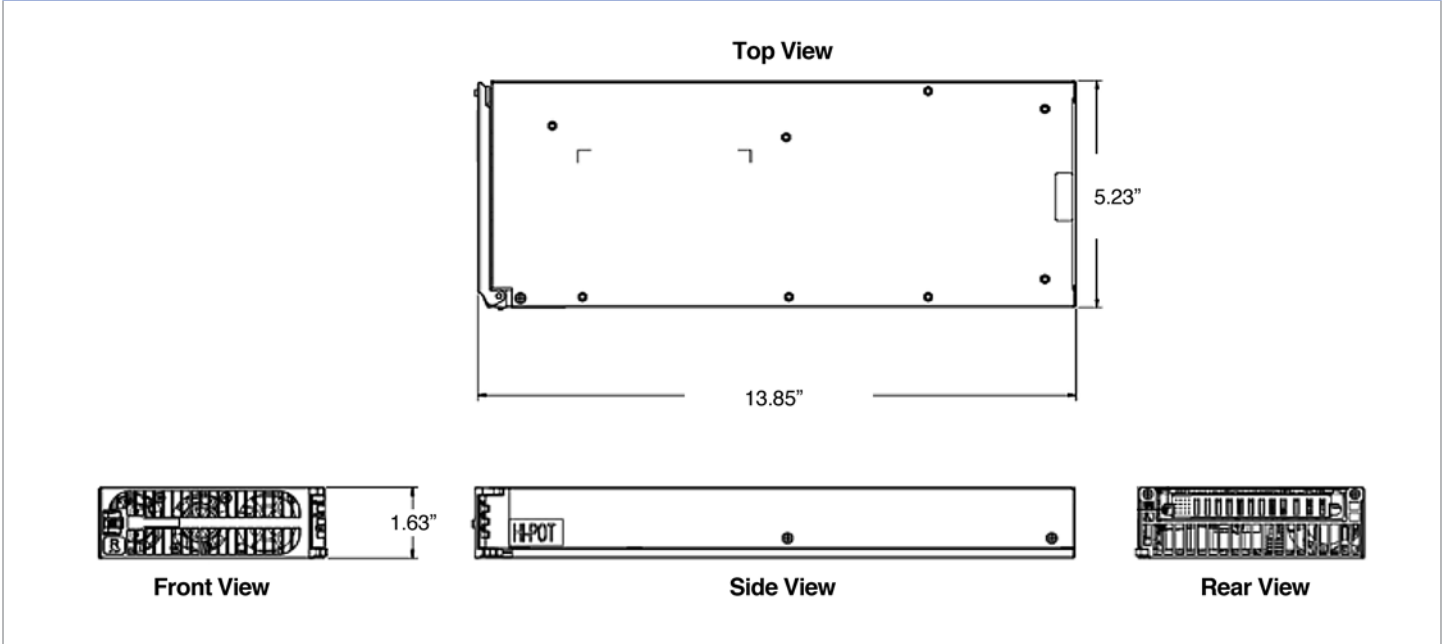

## Pulsar Plus Controller



The Pulsar Plus family of controllers provides system monitoring and control features for Infinity, CP, and other power systems. These controllers monitor and control system components including rectifiers, converters, and distribution modules via a multi-drop RS485 digital communications bus. System status, parameters, settings, and alarm thresholds can be viewed and configured from the controller's front panel display. Assignment and configuration of alarm inputs and output relays can be performed from a laptop computer connected to a local RS-232 or Ethernet port, or by remote access is through a network connection to the

World Wide Web (internet) or your enterprise network (intranet). An optional modem is also available.

This controller utilizes standard network management protocols allowing for advanced network supervision. The GE Galaxy Manager™ software is the centralized visibility and control component of a comprehensive power management system designed to meet engineering, operations and maintenance needs. The Galaxy Manager client-server architecture enables remote access to system controllers across the power network.

### Applications

- Telecommunications networks
- Digital subscriber line (DSL)
- Indoor/outdoor wireless
- Routers/switches
- Fiber in the loop
- Transmission
- Data networks
- PBX

### Key Features

#### Remote Access and Features

- Integrated 10/100Base-T Ethernet Network
  - TCP/IP
  - SNMP V2c for management
  - SMTP for email
  - Telnet for command line interface
  - DHCP for plug-n-play
  - FTP for rapid backup and upgrades
  - HTTP for standard web pages and browsers
  - Compatible with Galaxy Manager and other management packages
  - Shielded RJ-45 interface referenced to chassis ground
- Password protected security levels: User, Super-User, Administrator for all access
- Ground-referenced RS232 system port
- ANSI T1.317 command-line interface
- Modem access support
  - Remote via external modem
  - Callback security
- EasyView2, Windows-based GUI software for local terminal or Modem access

#### Standard System Features

- Monitor and control of more than 40 connected devices
  - Robust RS485 system bus
- Standard and user defined alarms
  - Alarm test
  - Assignable alarm severity: Critical, Major, Minor, Warning, and record-only
  - 10 alarm relays (7 user assigned)
- Rectifier management features
  - Automatic rectifier restart
  - Active Rectifier Management ARM (energy efficiency)
  - Remote rectifier (on/off)
  - Reserve Operation
  - Automatic rectifier sequence control
  - N + X redundancy check
- Multiple Low Voltage Load and Low Voltage Battery Disconnect thresholds
- Configuration, statistics, and history
  - All stored in non-volatile memory
  - Remote/local backup and restore of configuration data
- Industry standard defaults
  - Customer specific configurations available
- Remote/ local software upgrade
- Basic, busy hour, and trend statistics
- Detailed event history
- User defined events and derived channels

#### Standard Battery Management Features

- Float/boost mode control
  - Manual boost
  - Manual timed boost locally, T1.317, and remotely initiated
  - Auto boost terminated by time or current
- Battery discharge testing
  - Manual (local/remote)
  - Periodic
  - Plant Battery Test (PBT) input driven
  - Configurable threshold or 20% algorithm
  - Graphical discharge data
  - Rectifiers on-line during test
- Slope thermal compensation
  - High temperature
  - Low temperature
  - Step temperature
  - STC Enable/Disable, low temperature Enable/Disable
  - Configurable mV/°C slopes
- State of charge indication
- High temperature disconnect setting
- Reserve-time prediction
- Recharge current limit
- Emergency Power-Off input

**Integrated Monitoring Inputs/Outputs**

- System plant voltage (accuracy ±0.5%, resolution 0.01V)
- One system shunt (accuracy ± 0.5% full scale, resolution 1A)
  - Battery or load
  - Mounted in the return side of DC bus
- Up to 15 binary inputs
  - Six inputs close/open to battery
  - 9 input close/open to return
  - User assignable
- Up to 7 Form-C output alarms (60VDC @ .5A)
  - User assignable
- 1-Wire™ bus devices
  - Up to 16 temperature probes (QS873)
  - Up to 6 mid-string monitors (ES771)

General	
Operating Voltage	±24 Vdc, ±48 Vdc (Range: ±18 to ±60 Vdc)
Input Power	Less than 7W
Operating Temperature Range	-40°C to +75°C (-40°F to 167°F)
Operating Relative Humidity	0 - 95% (non-condensing)
Storage Temperature Range	-40°C to +85°C (-40°F to 185°F)
Physical Specifications	Sizes vary by packaging option
Display	8-line by 40-character with alarm context sensitive backlit LCD

**Galaxy Manager Compatible**

- Centralized web server and database with multiple user access to live or managed data with drill down to problem details
- Monitor and control of more than 40 connected devices
- Management information from polling or alarms received from alarm traps from multiple sites are available on one screen via the inter/intranet
- Trend user selected data over time
- Automatic or manual report generation
- Standard engineering tools like reserve time calculators and cable voltage drop analyzer

Safety and Standards Compliance	
NEBs	Evaluated by independent NRTL test lab to Telcordia GR63, Issue 3 and GR1089-CORE, Issue 5
Safety	CSA C22.2 No. 60950-1-03 Certified for Canada and U.S.; UL60950-1 1st Ed.
RoHS	Compliant to RoHS EU Directive 2002/95/EC RoHS 5/6
EMC	European Directive 2004/108/EC; EN55022, Class A, EN55024; FCC, Class A; GR1089-CORE, Issue 5

Agency Certifications	
NEBs Level 3	Evaluated by independent NRTL test lab to Telcordia GR63, Issue 3 and GR1089-CORE, Issue 5
EMC	European Directive 2004/108/EC; EN55022, (CISPR22) Class A, EN55024 (CISPR24)
Safety	Underwriters Laboratories (UL) Listed per Subject Letter 1801: Power Distribution Center for Communications Equipment, and cUL Certified (CSA 22.2 950): Safety of Information Technology Equipment

# Infinity S System



Infinity S may be configured as a +24V or -48V single voltage power system or as a dual voltage power system that supports rectifiers and converters. The primary voltage is supported by +24V or -48V rectifiers and battery reserve, while secondary voltage is supported by DC-DC converters. Infinity-S includes dedicated 24V, 48V and return buses. The primary voltage capacity is 800A at 24V and 600A at 48V. Secondary (-48V) voltage capacity is up to 120A. The system includes low voltage battery disconnect option for the primary voltage. A low voltage load disconnect option can be used for load shedding to maintain critical loads.

## Applications

- Wireless Telecom networks
- Indoor/outdoor wireless
- Transmission
- Data networks
- ECO Priority Source

## Key Features

- Dual Voltage Flexibility
- Redundant fan cooling
- Front panel LED indicators
- 1U height, hi power density
- 220/110 V AC input
- Digital load sharing
- Hot pluggable
- RoHS compliant

## Specifications

Input	Min	Typ	Max	
Voltage Range				
- High-Line	175Vac	220Vac	275Vac	
- Low-Line	85Vac	110Vac	140Vac	Only available in 24V Rectifiers
Frequency	45Hz	60Hz	66Hz	
Power Factor	98%	99.5%		
Total Harmonic Distortion			5%	
<b>Primary Output</b>				
Nominal Voltage	24Vdc		-48Vdc	
Output Current	1,200A		800A	
Vo Setpoint (factory)	27.2Vdc±1%		-54.5Vdc±1%	
Vo Range	+21Vdc to +29Vdc		-42Vdc to -58Vdc	
Regulation	±0.5%			
<b>Secondary Output</b>				
Nominal Voltage	-48Vdc		+24Vdc	
Output Current	120A		300A	
Vo Setpoint (factory)	-54.5Vdc±1%		27.25Vdc±1%	
Vo Range	-42Vdc to -58Vdc		+21Vdc to +29Vdc	
Regulation	±0.5%			
<b>Mechanical</b>				
	<b>System Only</b>		<b>Frame Mounted System</b>	
Height (in. /mm)	21.25 / 540 (Base system with 4 power shelves and 2 distributions)		84 / 2134	
Width (in. /mm)	23 / 584.2		26 / 660.4	
Depth (in. /mm)	21 / 533		21 / 533	
Weight (lb / Kg)	108 / 49 (Base system with 4 power shelves and 2 distributions)		292 / 132	

Environmental	
Operating Temperature	-40°C to +75°C (-40°F to 167 °F)
Storage Temperature	-40°C to +85°C (-40°F to 185 °F)
Relative Humidity	95% max, non-condensing
Altitude	4000M (for altitudes above 2000M, peak operating temperature de-rates 0.656° C /100M; 4000M peak temperature rating is 62° C)
Safety and Standards Compliance	
NEBs	Evaluated by independent NRTL test lab to Telcordia GR63, Issue 3 and GR1089-CORE, Issue 5
Safety	CSA C22.2 No. 60950-1-03 Certified for Canada and U.S.; UL60950-1 1st Ed.
RoHS	Compliant to RoHS EU Directive 2002/95/EC RoHS 5/6
EMC	European Directive 2004/108/EC; EN55022, Class A; EN55024; FCC, Class A; GR1089-CORE, Issue 5
Agency Certifications	
CSA	CSA C22.2 No 60950-1-03 and UL 60950-1 1st Ed
EMI/EMC	European Directive 2004/108/EC; EN55022 (CISPR22) Class A; EN55024 (CISPR24)
NEBS LEVEL 3	GR1089-CORE, Issue 5

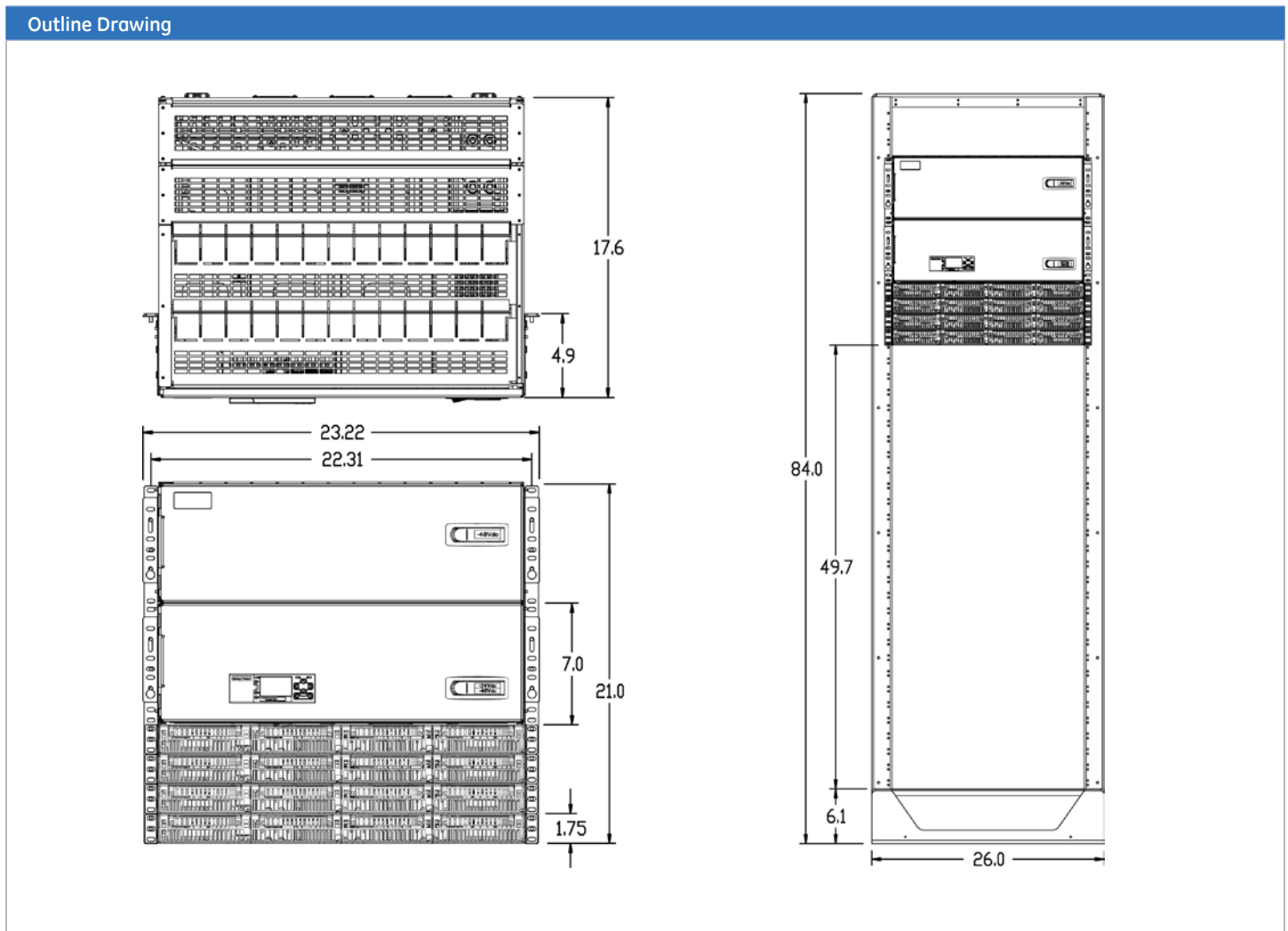

# Ordering Information – Infinity S Power System

## Ordering Guide

Infinity S may be configured as a +24V or -48V single voltage power system or as a “dual voltage” power system that supports rectifiers and converters. The primary voltage is supported by +24V or -48V rectifiers and battery reserve, while secondary voltage is supported by DC-DC converters. The primary voltage capacity is 800A at 24V and 600A at 48V. Secondary voltage capacity is up to 120A.

Infinity S systems may be equipped in a 7ft framework, a half height (42”) frame for mounting on battery stands, or supplied frameless for field install applications.



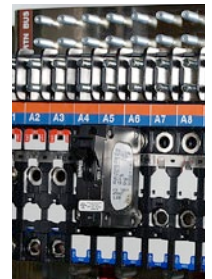

## Features

- Infinity Series Rectifiers for +24V and -48V applications.
- Dual Voltage Bus architecture for easy growth and voltage migration
- DC-DC Converter support for dual voltage systems
- DC Distribution for both voltages, with Selectable Voltage panel availability
- Temperature hardened harsh environments. (-40°C to +75°C)
- Compact size: Base System with 1 power shelf occupies 5 RU (8.75 in) of 23” rack space (18” depth)
- Frame options – Factory installed in 7ft or 42” tall, 23” wide frame or field installed in user supplied frame
- Battery connections, LVBD and LVLD options.
- Plug-N-Play Pulsar Plus controller with Web based interface for local and remote (LAN) access.
- Distribution options include 3A-250A bullet style circuit breakers, and GMT fuses



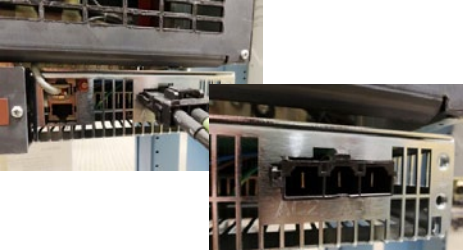
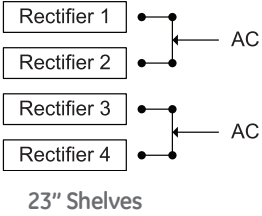

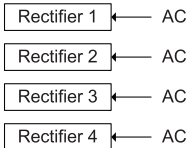
# AC Input Types

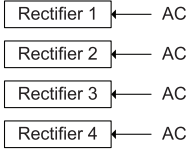
Type	Description	Schematic
AC1	Dual Feed, Molex Mini-fit Sr	
		 <p>23" Shelves</p>
AC3	Individual Feed, IEC-320 C19 Receptacles	
		
AC5	Individual Feed, Terminal Strip Rear cover is equipped with a 1" conduit knockout	
		

## DC Output Types -48V Single Voltage

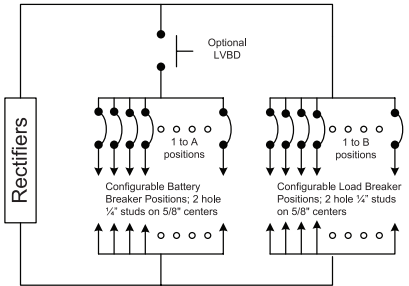
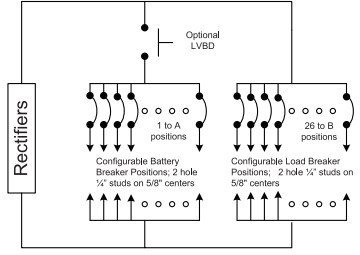
Type	Description	Schematic
DC1E	Single External Bullet Breaker Distribution Panel 26 Positions for 23" configuration Ratings: 600A output (600A discharge), 250A max breaker (65°C Ambient)	 <p>A+B = 26 Positions total for 23" System; Each position configurable for Battery or Load</p>
DC2E	Dual External Bullet Breaker Distribution Panel 52 Positions for 23" configuration Ratings: 600A output (800A discharge), 250A max breaker (65°C Ambient)	 <p>A+B = 52 Positions total for 23" System; Each position configurable for Battery or Load; Second distribution panel 26 Positions dedicated to Load Breakers only</p>





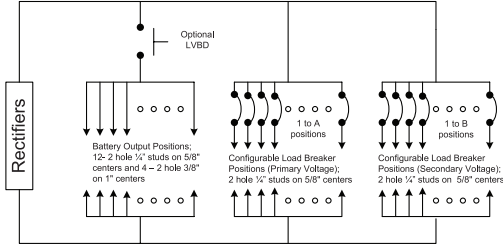
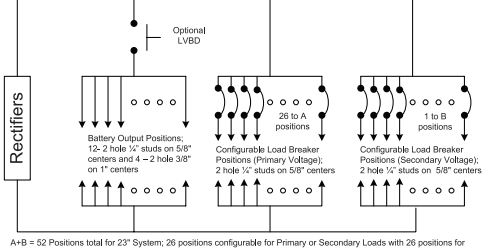

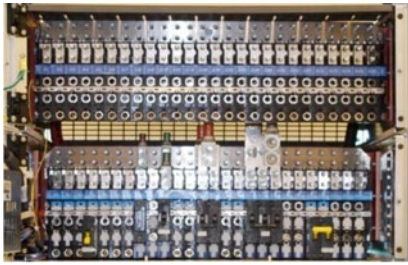
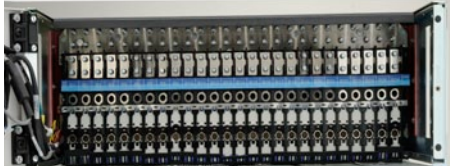
# DC Output Types For Dual Voltage Systems



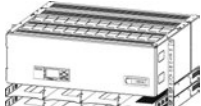
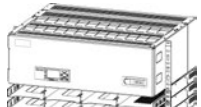

Type	Description	Schematic
DC1E	Single External Dual Voltage Bullet Breaker Distribution Panel 26 Positions for 23" configuration Ratings: 800A primary voltage output (800A discharge) and up to 300A secondary voltage output, 250A max breaker (65°C Ambient)	 <p>A+B = 26 Positions total for 23" System; Each position configurable for Primary or Secondary Loads; Dedicated Battery Bus</p>
DC2E	Dual External Dual Voltage Bullet Breaker Distribution Panel 52 Positions for 23" configuration Ratings: 800A primary voltage output (800A discharge) and up to 300A secondary voltage output, 250A max breaker (65°C Ambient)	 <p>A+B = 52 Positions total for 23" System; 26 positions configurable for Primary or Secondary Loads with 26 positions for Primary Loads only; Dedicated Battery Bus</p>



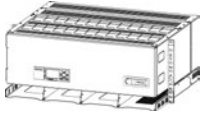

## Step 1: Select the Base Power System

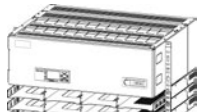
Single Voltage System -48V							
Output Rating	Description	AC Input	LVD	Frame	Ordering Code	Model	Photo
200A	200A Infinity S Power system equipped with 4 rectifier positions and 26 distribution positions selectable between -48V Load and Battery	Dual Molex	No		CC109163696	NES48 -23 -AC1 -PS4 -DC1E	
		Individual C19	No		CC109163663	NES48 -23 -AC3 -PS4 -DC1E	
		Ind. Term Block	No		150029007	NES48 -23 -AC5 -PS4 -DC1E	
		Dual Molex	LVBD		CC109160438	NES48 -23 -AC1 -PS4 -DC1E -LVBD	
		Individual C19	LVBD		CC109167904	NES48 -23 -AC3 -PS4 -DC1E -LVBD	
		Ind. Term Block	LVBD		150029001	NES48 -23 -AC5 -PS4 -DC1E -LVBD	
400A	400A Infinity S Power system equipped with 8 rectifier positions and 26 distribution positions selectable between -48V Load and Battery	Dual Molex	No		CC109163705	NES48 -23 -AC1 -PS8 -DC1E	
		Individual C19	No		CC109163671	NES48 -23 -AC3 -PS8 -DC1E	
		Ind. Term Block	No		150029008	NES48 -23 -AC5 -PS8 -DC1E	
		Dual Molex	LVBD		CC109165998	NES48 -23 -AC1 -PS8 -DC1E -LVBD	
		Individual C19	LVBD		CC109165981	NES48 -23 -AC3 -PS8 -DC1E -LVBD	
		Ind. Term Block	LVBD		150029002	NES48 -23 -AC5 -PS8 -DC1E -LVBD	
600A	600A Infinity S Power system equipped with 12 rectifier positions and 26 distribution positions selectable between -48V Load and Battery	Dual Molex	No		CC109163713	NES48 -23 -AC1 -PS12 -DC1E	
		Individual C19	No		CC109163688	NES48 -23 -AC3 -PS12 -DC1E	
		Ind. Term Block	No		150029009	NES48 -23 -AC5 -PS12 -DC1E	
		Dual Molex	LVBD		CC109167920	NES48 -23 -AC1 -PS12 -DC1E -LVBD	
		Individual C19	LVBD		CC109167912	NES48 -23 -AC3 -PS12 -DC1E -LVBD	
		Ind. Term Block	LVBD		150029003	NES48 -23 -AC5 -PS12 -DC1E -LVBD	
600A	600A Infinity S Power system equipped with 12 rectifier positions and 52 total distribution positions, 26 of which selectable between -48V Load and Battery	Dual Molex	No		CC109171286	NES48 -23 -AC1 -PS12 -DC2E	
		Individual C19	No		CC109171261	NES48 -23 -AC3 -PS12 -DC2E	
		Ind. Term Block	No		150029011	NES48 -23 -AC5 -PS12 -DC2E	
		Dual Molex	LVBD		CC109171278	NES48 -23 -AC1 -PS12 -DC2E -LVBD	
		Individual C19	LVBD		CC109171253	NES48 -23 -AC3 -PS12 -DC2E -LVBD	
		Ind. Term Block	LVBD		150029006	NES48 -23 -AC5 -PS12 -DC2E -LVBD	
600A	600A Infinity S Power system equipped with 16 rectifier positions and 26 distribution positions selectable between -48V Load and Battery	Ind. Term Block	No		150029010	NES48 -23 -AC5 -PS16 -DC1E	
		Ind. Term Block	LVBD		150029004	NES48 -23 -AC5 -PS16 -DC1E -LVBD	
800A	800A Infinity S Power system equipped with 4 rectifier positions and 52 total distribution positions, 26 of which selectable between -48V Load and Battery	Ind. Term Block	No		150029012	NES48 -23 -AC5 -PS16 -DC2E	
		Ind. Term Block	LVBD		150029006	NES48 -23 -AC5 -PS16 -DC2E -LVBD	

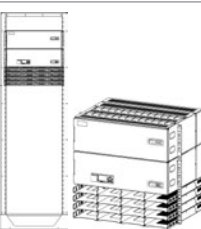



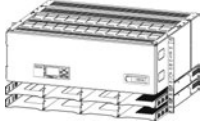

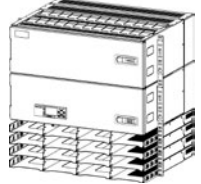
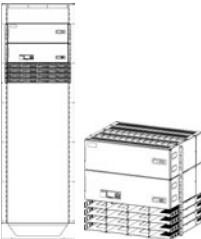

## Step 1: Select the Base Power System (cont.)



Dual Voltage Infinity S Power Systems, -48V Primary with +24V Secondary							
Output Rating	Description	AC Input	LVD	Frame	Ordering Code	Model	Photo
400A	400A Infinity S Power system equipped with 8 universal positions and 26 distribution positions selectable between -48V Load and +24V Converter load	Dual Molex	No		150022649	NES4824-23-AC1-PS8-DC1E	
		Individual C19	No		150022653	NES4824-23-AC3-PS8-DC1E	
		Dual Molex	LVBD		150022648	NES4824-23-AC1-PS8-DC1E-LVBD	
		Individual C19	LVBD		150022652	NES4824-23-AC3-PS8-DC1E-LVBD	
400A	400A Infinity S Power system equipped with 8 universal positions and 52 total distribution positions, 26 dedicated to -48V and 26 of which selectable between -48V Load and 24V Converter Load	Dual Molex	LVBD		150024038	NES4824-23-AC1-PS8-DC2E-LVBD	
		Individual C19	LVBD		150024039	NES4824-23-AC3-PS8-DC2E-LVBD	
800A	800A Infinity S Power system equipped with 16 universal positions and 26 distribution positions selectable between -48V Load and +24V Converter load	Dual Molex	No		150022651	NES4824-23-AC1-PS16-DC1E	
		Individual C19	No		150022655	NES4824-23-AC3-PS16-DC1E	
		Dual Molex	LVBD		150022650	NES4824-23-AC1-PS16-DC1E-LVBD	
		Individual C19	LVBD		150022654	NES4824-23-AC3-PS16-DC1E-LVBD	
800A	800A Infinity S Power system equipped with 16 universal positions and 52 total distribution positions, 26 dedicated to -48V and 26 of which selectable between -48V Load and 24V Converter Load	Dual Molex	No		CC109172508	NES4824-23-AC1-PS16-DC2E	
		Individual C19	No		150022657	NES4824-23-AC3-PS16-DC2E	
		Ind. Term Block	No		150027199	NES4824-23-AC5-PS16-DC2E	
		Dual Molex	LVBD		CC109170643	NES4824-23-AC1-PS16-DC2E-LVBD	
		Individual C19	LVBD		150022656	NES4824-23-AC3-PS16-DC2E-LVBD	
		Ind. Term Block	No	84" Zone 4	150027200	NES4824-23-AC5-PS16-DC2E-7FTR	

## Step 1: Select the Base Power System (cont.)

Dual Voltage Infinity S Power Systems, +24V Primary with -48V Secondary							
Output Rating	Description	AC Input	LVD	Frame	Ordering Code	Model	Photo
800A	800A Infinity S Power system equipped with 8 universal positions and 26 distribution positions selectable between +24V Load and -48V Converter load	Dual Molex	No		CC109172524	NES2448-23-AC1-PS8-DC1E	
		Individual C19	No		150022660	NES2448-23-AC3-PS8-DC1E	
		Dual Molex	LVBD		CC109172516	NES2448-23-AC1-PS8-DC1E-LVBD	
		Individual C19	LVBD		150022659	NES2448-23-AC3-PS8-DC1E-LVBD	
1000A	1000A Infinity S Power system equipped with 16 universal positions and 26 distribution positions selectable between +24V Load and -48V Converter load	Dual Molex	No		CC109163135	NES2448-23-AC1-PS16-DC1E	
		Individual C19	No		150022662	NES2448-23-AC3-PS16-DC1E	
		Dual Molex	LVBD		CC109160818	NES2448-23-AC1-PS16-DC1E-LVBD	
		Individual C19	LVBD		150022661	NES2448-23-AC3-PS16-DC1E-LVBD	
1000A	1000A Infinity S Power system equipped with 16 universal positions and 52 total distribution positions, 26 dedicated to +24V and 26 of which selectable between +24V Load and -48V Converter Load	Dual Molex	No		CC109172540	NES2448-23-AC1-PS16-DC2E	
		Individual C19	No		150022664	NES2448-23-AC3-PS16-DC2E	
		Ind. Term Block	No		150027197	NES2448-23-AC5-PS16-DC2E	
		Dual Molex	LVBD		CC109172532	NES2448-23-AC1-PS16-DC2E-LVBD	
		Individual C19	LVBD		150022663	NES2448-23-AC3-PS16-DC2E-LVBD	
		Ind. Term Block	No	84" Zone 4	150027198	NES2448-23-AC5-PS16-DC2E-7FTR	

## Step 2: Select Rectifiers and Converters

Rectifiers			
	Ordering Code	Model	Photo
	CC109160834	95 - 145Vac input, 24V, 44A Output, 175 - 275Vac input, 24V, 100A output; 145 - 175 linear output increase from 44A to 100A	
100A		NE100AC24ATEZ	
	150027075	95 - 145Vac input, 24V, 44A Output, 175 - 275Vac input, 24V, 100A output; 145 - 175 linear output increase from 44A to 100A 100 - 310 VDC input from Solar resource with full power above 250VDC.	
100A		NE100ECO24ATEZ	
	CC109158878	95 - 145Vac input, 48V, 22A Output, 175 - 275Vac input, 48V, 50A output; 145 - 175 linear output increase from 22A to 50A	
50A		NE050AC48ATEZ	
	150027074	95 - 145Vac input, 48V, 22A Output, 175 - 275Vac input, 48V, 50A output; 145 - 175 linear output increase from 22A to 50A 100 - 310 VDC input from Solar resource with full power above 250VDC.	
50A		NE050ECO48ATEZ	

Converters			
	Ordering Code	Model	Photo
	CC109112471	21-29 Vdc input, 48V, 30A output	
30A		NE030DC48	
	CC109142881	42-58 Vdc input, 24V, 75A output	
75A		NE075DC24	

### Step 3: Select AC Cord

Example: 208/240VAC for a NES48-AC1-PS4-DC1E-LVBD shelf using 50A rectifiers would use a 848710711 AC 8 gauge which provides 2 AC cords; enough to power 4 rectifiers. Customer should provide one 40A protecting circuit breaker per two rectifiers. For AC3 cable sets, it is recommended that a 20A circuit breaker is used per rectifier. Note: If PS# of your shelf model number is not listed in table, choose the next higher number. AC cords are 10 feet long and unterminated on the end. See optional accessories for twist lock connectors.

Ordering Code	AC Type	Gauge	Shelf Termination	Order # of Cords			Cord Type	Length	User Termination	120 Vac	208/240 Vac
				Shelf	Dual	Indiv.					
CC848801977	AC1	8	Molex	1	x		Sleeved	3'	Unterminated	x	x
CC848830522			Molex	1	x		Sleeved	4'	Unterminated		
848710711			Molex	1	x		Sleeved	10'	Unterminated		
CC848906586			Molex	2	x		SO	10'	Unterminated		
CC848773515		10	Molex	2	x		SO	15'	Unterminated		
CC848847368	AC3	12	IEC - No Plug	4		x	SO	8'	Unterminated	x	x
CC848850792		12	IEC 5-15P	4		x	SO	8'	5-15P	x	
CC848850801		12	IEC 5-20P	4		x	SO	8'	5-20P	x	
CC848850826		12	IEC 6-15P	4		x	SO	8'	6-15P		x
CC848850834		12	IEC 6-20P	4		x	SO	8'	6-20P		x
CC848850842		12	IEC L6-20P	4		x	SO	8'	L6-20P		x
CC848850850		12	IEC L6-30P	4		x	SO	8'	L6-30P		x

### Step 4: Select Alarm Cables

Alarm Cables		
Ordering Code	Model	Photo
CC848865980	15ft Auxiliary input alarm cable for Pulsar Plus Controller	
CC848817651	50ft Auxiliary input alarm cable for Pulsar Plus Controller	
CC848817668	150ft Auxiliary input alarm cable for Pulsar Plus Controller	
CC109157442	15ft alarm cable for Pulsar Plus Controller	
CC848817635	50ft alarm cable for Pulsar Plus Controller	
CC848817643	150ft alarm cable for Pulsar Plus Controller	





## Step 5: Select Distribution Components

Note: Infinity S systems all support plug-in (bullet style) breakers or fuse modules. Larger breakers can be 2 or even 3 poles. The multi-pole breakers MUST be used with the appropriate multi-pole adapter to parallel the poles for proper operation.



Bullet Style Load Circuit Breakers				
Ordering Code	Amperage	CB Positions (Poles)	Min Wire Gauge	Photo
407998137	3	1	10	
407998145	5	1	10	
407998152	10	1	10	
407998160	15	1	10	
407998178	16	1	10	
407998186	20	1	10	
407998194	25	1	10	
407998202	30	1	10	
408213486	40	1	8	
407998210	45	1	8	
407998228	50	1	6	
407998236	60	1	6	
407998244	70	1	2	
407998251	80	1	2	
407998269	90	1	2	
407998277	100	1	2	
CC848808551	100	2	2	
408185353	125	2	2	
408185346	150	2	1/0	
408564941	200	3	2/0	
408573975	225	3	4/0	
408535752	250	3	4/0	
CC848756916	2-pole Adapter bus for 100-150A breakers (order 2 per 2 pole breaker to accommodate load and return lugs)			
850021775	2-pole Adapter bus for 100-150A breakers; used for 3/8" on 1" lugs (order 2 per 2 pole breaker to accommodate load and return lugs)			
CC848756924	3-pole Adapter bus for 200-250A breakers (order 2 per 3 pole breaker to accommodate load and return lugs)			
850021955	3-pole Adapter bus for 200-250A breakers; centered connection (order 2 per 3 pole breaker to accommodate load and return lugs)			

## Step 5: Select Distribution Components (cont.)

Bullet Battery Circuit Breakers (Yellow Handle) (Alarms on Mid-trip and in Off position)				
Ordering Code	Amperage	Ordering Code	Amperage	Photo
CC408612758	30	CC408574387	70	
CC408612766	40	CC408574395	100 (2-pole)	
CC408612774	45	CC408574404	125 (2-pole)	
CC408574370	50	CC408574412	150 (2-pole)	
408560123	60	CC408574420	200 (2-pole)	
CC109106548	100A battery bullet bus strap (substitute for battery breaker)			

Bullet Style Fuse Holder and TPS Fuses				
Ordering Code	Amperage	WP-92461 List	Min Wire Gauge	Photo
406700567	3	100	10	
406700583	5	101	10	
406700591	6	102	10	
406700609	10	103	10	
406700617	15	104	10	
406700625	20	105	10	
406700633	25	106	10	
406700641	30	107	10	
406700658	40	108	10	
406700674	50	109	8	
406700682	60	110	6	
406700690	70	111	6	
402328926	0.18 Alarm Fuse			
408548944	Bullet Fuse Holder, TFD-101-011-09 (Alarms on Blown Fuse or Fuse Head Removal)			
CC408617410	Bullet Fuse Holder, TFD-101-011-10 (Alarms on Blown Fuse Only)			

## Step 5: Select Distribution Components (cont.)

Bullet Style GMT Fuse Holder and GMT Fuses				
Ordering Code	Amperage	WP-92461 List	Min Wire Gauge	Photo
405006222	0.25A			
3150439	0.5A			
405673146	1.33A			
405181983	2A			
406976985	3A			
406159061	5A			
405725433	7.5A			
406159236	10A			
407845197	12A			
406473959	15A			
CC109103157	6-pos GMT Bullet Fuse Holder (Requires 2 bullet positions)			
408515823	Fuse Puller			
402099436	Dummy Fuse			

Terminal Lugs for Bullet Style Breakers and TPS Fuses (1/4" bolt on 5/8" centers)				
Ordering Code	STR Wire GA (Class B)	Flex Wire GA (Class I)	WP-91412 List	Photo
406021626	8	8	75	
405347519	6	6	3	
405347576	4	4	5	
405348202	2	-	54	
405347683	-	2	8	

Terminal Lugs for Battery and Large Breakers (3/8" bolt on 1" centers)				
Ordering Code	STR Wire GA (Class B)	Flex Wire GA (Class I)	WP-91412 List	Photo
406338665	2	-	-	
405348228	1/0	-	-	
405348236	2/0	1/0	-	
406021725	-	2/0	-	
405348251	4/0	-	-	
405347923	-	4/0	-	

## Step 6: Select Battery Monitoring

Ordering Code	Description	Photo
CC109142980	QS873A Thermal Probe (A)	
CC848817024	10 ft wire set (B: thermal probe to controller)	
CC109157434	20 ft wire set (B:thermal probe to controller)	
CC848822560	1 ft wire set (C: thermal probe to thermal probe)	
848719803	5 ft wire set (C: thermal probe to thermal probe)	
CC848822321	10 ft wire set (C: thermal probe to thermal probe)	
850027334	20 ft wire set (C: thermal probe to thermal probe)	
108958422	ES771A Battery Voltage Monitor Card	
CC848791517	2-1/2 ft wire set (D: ES771A to thermal probe)	
CC848797290	6 ft wire set (D: ES771A to thermal probe)	
848719829	10 ft wire set (D: ES771A to thermal probe)	
CC848791500	4 ft wire set (G: ES771A to ES771A or controller)	
848652947	10 ft wire set (G: ES771A to ES771A or controller)	
555052-1	In-Line Coupler (for extending item G above)	

Temperature/Voltage probes are needed for battery monitoring. They are connected to each battery or battery string to provide slope thermal compensation, temperature alarms and voltage imbalance alarms.

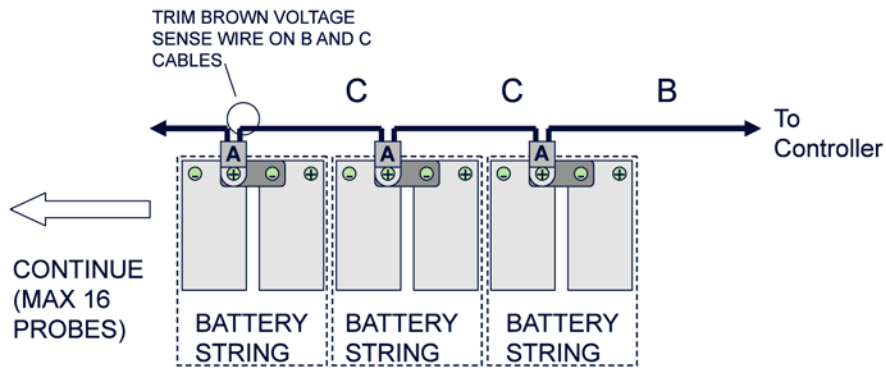

Temperature Measurement

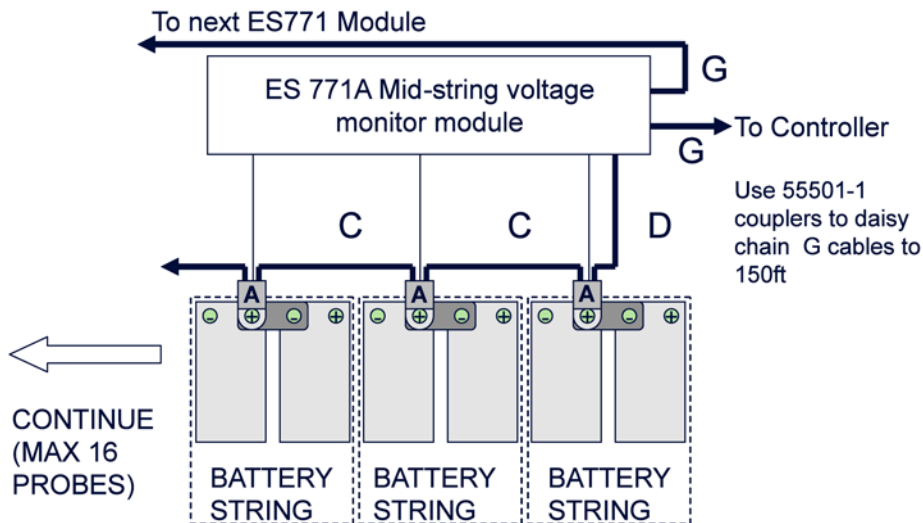

Temperature and Voltage Measurement

## Shelf Specifications

Mechanical	
Height	4RU main cabinet plus 1RU per power shelf – Base system 5RU (8.75 inches / 222mm)
Width (with mounting ears)	23 inches (584mm)
Depth	18 inches (457mm), 21 inches (533mm) for systems equipped with AC5 input
Weight (without rectifiers)	Approximately 42lbs (19kg) – Base system with 1 rectifier shelf
Environmental	
NEBs	Evaluated by independent NRTL test lab to Telcordia GR63, Issue 3 and GR1089-CORE, Issue 5
Safety	CSA C22.2 No. 60950-1-03 Certified for Canada and U.S.; UL60950-1 1st Ed.
RoHS	Compliant to RoHS EU Directive 2002/95/EC RoHS 5/6
EMC	European Directive 2004/108/EC; EN55022, Class A; EN55024; FCC, Class A; GR1089-CORE, Issue 5
Agency Certifications	
UL	CSA C22.2 No 60950-1-03 and UL 60950-1 1st Ed
EMI/EMC	European Directive 2004/108/EC; EN55022 (CISPR22) Class A; EN55024 (CISPR24)
NEBS LEVEL 3	GR1089-CORE, Issue 5

## Additional Information

### Product Documentation

- H5692448: Ordering Guide. A copy of the appropriate installation manuals below ship with each system.
- CC848815325: H5692448 Installation Guide
- CC848815341: Advanced Features User Guide for the Pulsar Plus Controller, 167-792-183

## Management Visibility

Galaxy Manager™ software is the centralized visibility and control component of a comprehensive power management system designed to meet engineering, operations and maintenance needs. The Galaxy Manager client-server architecture enables remote access to system controllers across the power network.

- Dashboard display with one-click access to management information database
- Trend analysis
- Scheduled or on demand reports
- Fault, configuration, asset, and performance management

## Training

GE offers on-site and classroom training options based on certification curriculum. Technical training can be tailored to individual customer needs. Training enables customers and partners to more effectively manage and support the power infrastructure. We have built our training program on practical learning objectives that are relevant to specific technologies or infrastructure design objectives.

## Service & Support

GE field service and support personnel are trusted advisors to our customers – always available to answer questions and help with any project, large or small. Our certified professional services team consists of experts in every aspect of power conversion with the resources and experience to handle large turnkey projects along with custom approaches to complex challenges. Proven systems engineering and installation best practices are designed to safely deliver results that exceed our customers' expectations.

## Warranty

GE is committed to providing quality products and solutions. We have developed a comprehensive warranty that protects you and provides a simple way to get your products repaired or replaced as soon as possible.

For full warranty terms and conditions please go to [www.ge.com/powerelectronics](http://www.ge.com/powerelectronics).



## Contact Us

For more information, call us toll free at **+1 877 546 3243**, or +1 972 244 9288 and visit us on the web at [www.ge.com/powerelectronics](http://www.ge.com/powerelectronics)

## X-ON Electronics

Largest Supplier of Electrical and Electronic Components

*Click to view similar products for [AC Power Leads](#) category:*

*Click to view products by [ABB](#) manufacturer:*

Other Similar products are found below :

[62500-1774](#) [1300000023](#) [312033-01](#) [YP-61+YC12](#) [P28818-M2](#) [YP21A+YC13](#) [FTP-629Y603](#) [1702002600](#) [1700001947](#) [J2014004L001-CC](#)  
[SHELF](#) [IL13-EU1-H05-3100-300-S](#) [P28976-M45](#) [BB-3271V86](#) [W-97277](#) [W-97278](#) [W-97279](#) [W-97204](#) [W-97895](#) [W-98437](#) [W-98452](#) [W-](#)  
[98453](#) [MWOC-PCA-3-3-2](#) [P29844-M5](#) [P29844-M10](#) [CP152](#) [CP154](#) [W-99245](#) [W-99246](#) [W-99249](#) [W-99251](#) [W-99252](#) [W-99253](#) [W-99254](#)  
[W-99257](#) [W-99260](#) [W-99262](#) [W-99265](#) [W-99267](#) [W-99269](#) [W-99270](#) [W-99272](#) [W-99280](#) [W-99282](#) [S144720002](#) [S002020062](#)  
[S007220315](#) [S007220344](#) [S007220303](#) [S007220307](#) [P28818-M6](#)