

CLP0448 Open Frame Power Supply

90 - 265Vac Input; 48/54Vdc Output; 450W Output Power

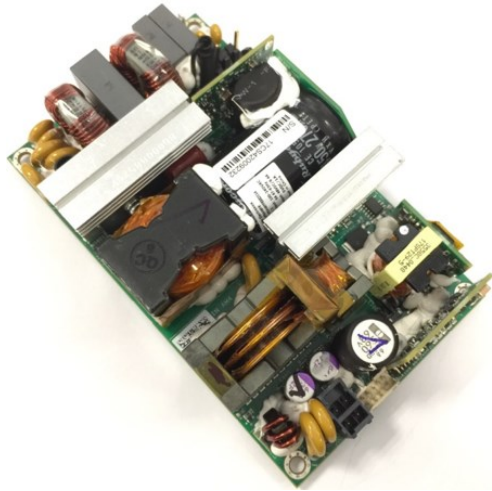

In a small 3 x 5-inch footprint, the 48/52Vdc single-output CLP0448 open frame power supply delivers greater than 90 percent typical power efficiency and full load output at 50°C and 1m/s airflow.

Description

In a small 3 x 5 inch footprint, the 48/52Vdc single-output CLP0448 open frame power supply delivers greater than 90 percent typical power efficiency and full load output at 50 °C and 1m/s airflow. Protection features include output overcurrent (OCP), overvoltage (OVP), and overtemperature (OTP). Applications Include: Industrial Equipment | Telecommunications Equipment

Features

- Compact size 76.2 mm x 127 mm x 35 mm (3 in x 5 in x 1.38 in) with density of 21.4 W/in³
- Universal AC Input Range (90 - 265VAC)
- Output voltage of 48V/54V (adjustable $\pm 3\%$ around nominal values)
- Standby output of 5V @ 1A
- Standby input power consumption <0.5W
- Maximum output current of 9.4A @ 48Vout (450W)
- High efficiency (>92% at Full Load, 230VAC in)
- Full load capability at 50 °C and 1m/s airflow with derating at higher temperatures or lower airflows
- Capable of ≥ 340 W out in sealed enclosure applications, with enclosure ambient at 55 °C
- Output overcurrent protection (non-latching)
- Overtemperature protection
- Output overvoltage protection
- Minimum of 11ms of holdup time at 450W out
- Parallelable with output current sharing
- Active power factor corrected input
- Conducted EMI - meets CISPR22 (EN55022) and FCC Class B requirements
- Isolation levels meet POE Standards (IEEE 602.3af)
- UL and cUL approved to UL/CSA62368-1, TUV (EN62368-1), CE Mark (for LVD) and CB Report available
- Compliant to RoHS Directive 2011/65/EU and amended Directive (EU) 2015/863
- Compliant to REACH Directive (EC) No 1907/2006
- ISO** 9001 and ISO 14001 certified manufacturing facilities

See footnotes on page 4

Technical Specifications

Absolute Maximum Ratings

Stresses over the absolute maximum ratings can cause permanent damage to the device. These are absolute stress ratings only. Functional operation of the device is not implied at these or any other conditions over those given in the operations sections of the data sheet. Exposure to absolute maximum ratings for extended periods can adversely affect the device reliability.

Parameter	Device	Min	Max	Unit
Input Voltage - Continuous Operation	All	90	265	Vac
For up to 10 seconds operation	All	90	275	Vac
Operating Ambient Temperature (see Thermal Considerations section)	All	-40	85	°C
Storage Temperature	All	-40	85	°C
Humidity (non-condensing)	All	5	95	%
Altitude	All		5000	m
Isolation Voltage—Input to output	All		3000	Vac
Input to safety ground	All		1500	Vac
Outputs to safety ground	All		2250	Vac

Electrical Specifications

Parameter	Device	Min	Typ	Max	Unit
Operating Input Voltage	All	90	115/230	265	Vac
Input Source Frequency	All	47	50/60	63	Hz
Input Current ($V_{IN} = 90\text{Vac}$)	All			7A	A_{RMS}
Input Power Factor (230Vac, Full Load)	All	0.95			
Inrush Transient Current ($V_{IN} = 265\text{Vac}$, $T_{amb} = 25^{\circ}\text{C}$)	All			60	A Peak
Leakage Current to earth ground ($V_{IN} = 265\text{Vac}$)	All			3.5	mA
Output Voltage Setpoint	All		48/54		Vdc
Output Voltage Tolerance (due to set point, temperature variations, load and line regulation)	All	-2		2	%
Output Voltage Adjustment Range	48V out version 54V out version	46 51	48 54	51 57	Vdc Vdc
Output Remote Sense Range	All			1	Vdc
Output Load Regulation	All			1	%Vout
Output Line Regulation	All			0.5	%Vout
Output Ripple and Noise – measured with 0.1 μF ceramic capacitor and 470 μF polymer capacitor in parallel. ¹ Peak-to-peak (20MHz Bandwidth)	All			500	mV p-p
Dynamic Load Response – 50% to 100% load transient, 1A/ μs slew rate					
Output voltage deviation	All			5%	%
Settling Time	All			500	μs
Output Current	48V out version 54V out version	0 0		9.4 8.3	A _{dc} A _{dc}
Output Current Limit Inception	All	110		145	% $I_{O,max}$
Maximum Output Capacitance	All			5000	μF
Standby Output Voltage	All		5		Vdc
Standby Output Current	All			1	A _{dc}

-continued on next page-

See footnotes on page 4

Technical Specifications (continued)

Electrical Specifications con't.

Parameter	Device	Min	Typ	Max	Unit
Efficiency $V_{IN} = 230V_{ac}$ —20% load	All	87.5			%
50% load	All	92.0			%
100% load	All	88.0			%
Efficiency: $V_{IN} = 115V_{ac}$ —20% load	All	87.0			%
50% load	All	90.0			%
100% load	All	87.0			%
Holdup Time ¹ — $V_{IN} = 115V_{ac}$, 450W load	All	11			ms
$V_{IN} = 230V_{ac}$, 450W load	All	11			
Input Power Consumption in Standby Mode (main output off, 0.2W load on standby output) AC Input Nominal 115/230VAC	All			0.5	W

Note: For cold starts $\leq -20^{\circ}C$, unit will meet all specification after a 20minute warm up period with minimum 50% loading.

General Specifications

Parameter	Device	Symbol	Typ	Unit
Calculated Reliability based on Telcordia SR-332 Issue 2: Method 1 Case 3 ($V_{IN}=230V_{ac}$, $I_o = 18.75A$, $T_A = 40^{\circ}C$, airflow 200LFM, 90% confidence)	All	MTBF	>750,000	Hours
Weight	All		388 13.7	g oz.

Feature Specifications

Parameter	Device	Min	Typ	Max	Unit
On/Off Signal Interface – signal referenced to GND					
Logic Low (Power Supply ON)					
Input Low Current	All			7	mA
Input Low Voltage	All			1	V
Logic High (Power Supply OFF)					
Input High Current	All			600	μA
Input Voltage	All	2.5		5.5	V
Delay from ON/OFF being enabled to start of output voltage rise	All			200	ms
Output Voltage Rise Time (from 10 to 90% of final value)	All		20		ms
Delay from Input being applied to all outputs being in regulation	All			800	Ms
Output Overvoltage Protection	48V out version	55.2		64	Vdc
	54V out version	59		64	Vdc
Input Undervoltage lockout²					
Turn-on Threshold (100% load)	All		87.5		Vac
Turn-off Threshold (100% load)	All		79		Vac
DC OK – open collector, High when output available					
Sink Current	All			4	mA
Maximum Collector Voltage	All			12	V

See footnotes on page 4

Technical Specifications (continued)

Safety Specifications

Parameter	Device	Specification
Dielectric Withstand Voltage (between input and output)	All	Minimum of 4,250Vdc for 1 minute
Insulation Resistance (between input and output)	All	Minimum of 5 MΩ
Safety Standards	All	Class 1, IEC62368 EN62368, with the following deviations: Nemko, UL 62368 (Recognized Component), cUL (Canadian Approval by UL)

Environmental Specifications

Parameter	Device	Specification
Conducted Emissions	All	CISPR32 (EN55032) Class B with 3dB margin
Radiated Emissions ³	All	CISPR32 (EN55032) to comply with system enclosure
ESD	All	IEC 61000-4-2, Level 3
Radiated Susceptibility ⁴	All	IEC 61000-4-3, Level 3
Electrical Fast Transient Common Mode	All	IEC 61000-4-4, Level 3
Surge Immunity (note-overshoot or undershoot may be observed during an event > 5% for 20 us application dependent)	All	IEC 61000-4-5, Level 4
Conducted RF Immunity	All	IEC 61000-4-6, Level 3
Input Voltage Dips	All	Output stays within regulation for either ½ cycle interruption or 25% dip from nominal line for 1 second
Input Harmonics	All	IEC61000-3-2
Shock and Vibration	All	Per IPC-9592B, Class II

Footnotes

*UL is a registered trademark of Underwriters Laboratories, Inc.

†CSA is a registered trademark of Canadian Standards Association.

‡VDE is a registered trademark of Verband Deutscher Elektrotechniker e.V.

**ISO is a registered trademark of the International Organization of Standard

¹ Holdup time may be lower at cold temperatures

² Undervoltage lockout threshold may vary with output load current level – decreasing as load goes lower

³ Shall meet when tested in a suitable enclosure

⁴ Shall meet when tested in a suitable enclosure

Technical Specifications (continued)

Characteristic Curves (CLP0448)

The following figures provide typical characteristics for the CLP0448 power supply.

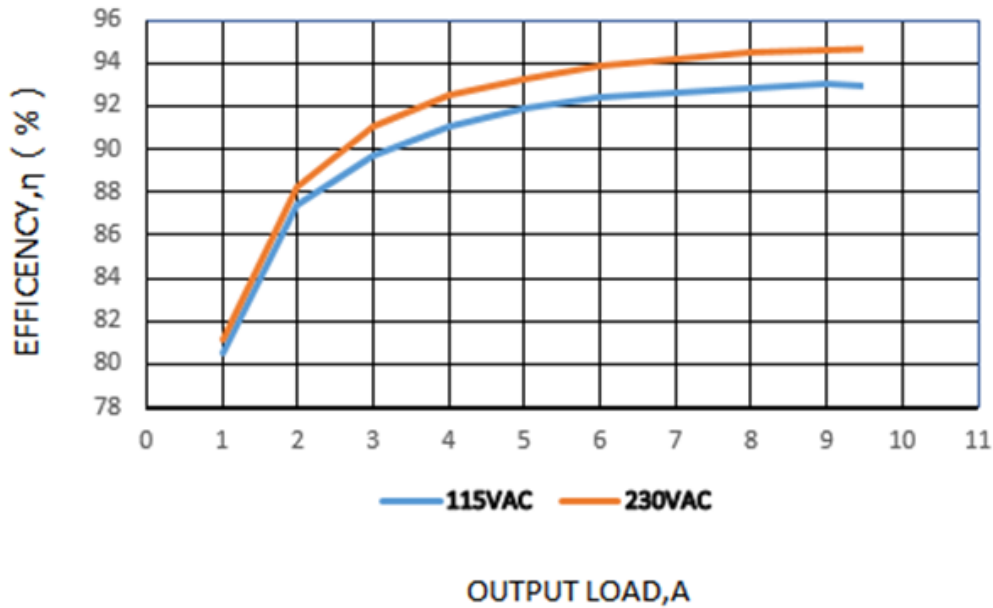

Figure 1: Power Supply Efficiency Versus Output Current

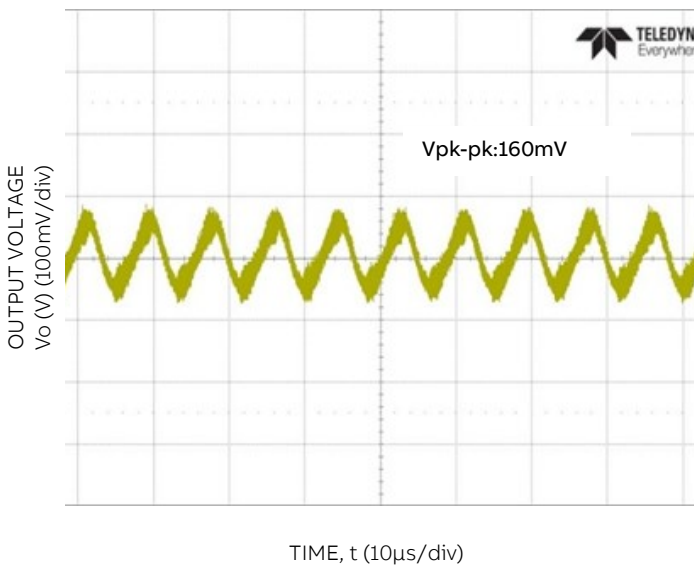

Figure 2. Typical output ripple and noise ($V_{IN} = 230Vac$, 100% load)

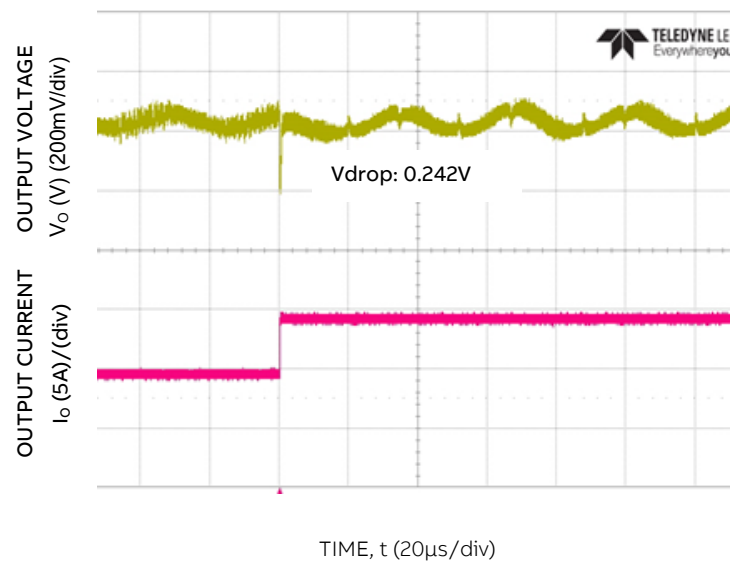

Figure 3. Transient Response to Dynamic Load Change from 50% to 100% at $V_{IN} = 230Vac$

Technical Specifications (continued)

Characteristic Curves con't. (CLP0412)

The following figures provide typical characteristics for the CLP0448 power supply.

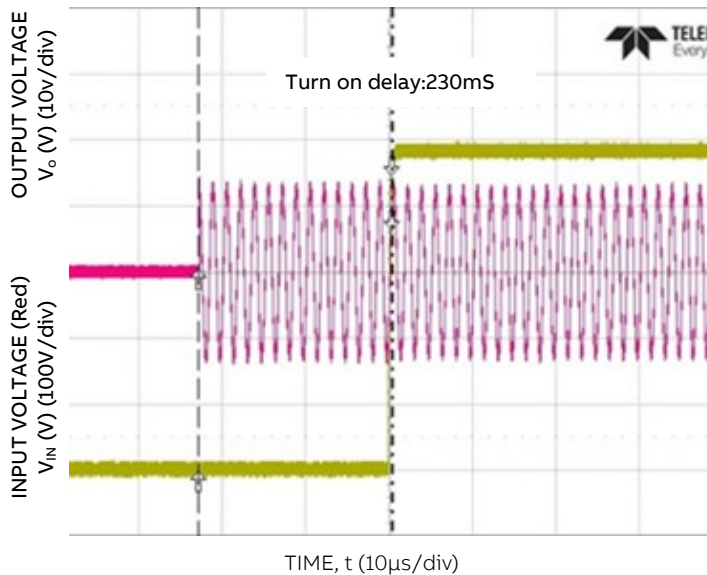

Figure 4. Typical Start-up ($V_{IN} = 90\text{Vac}$, Full Load)

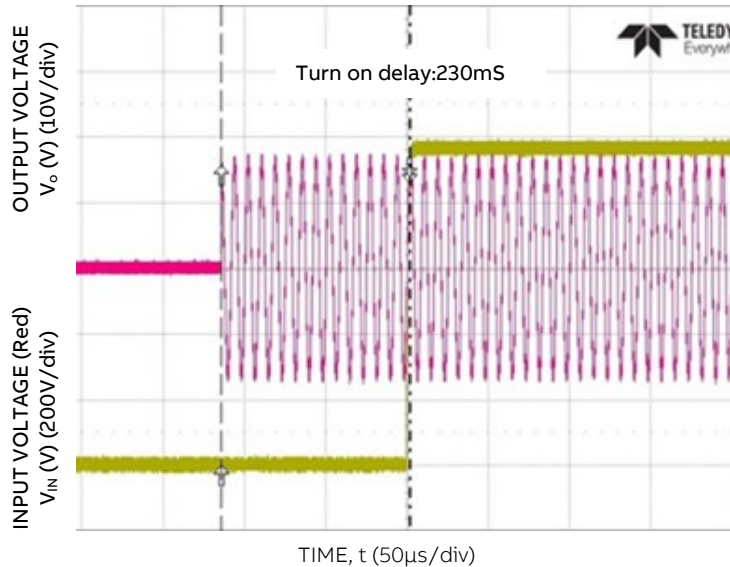

Figure 5. Typical Start-up ($V_{IN} = 230\text{V}$, Full Load)

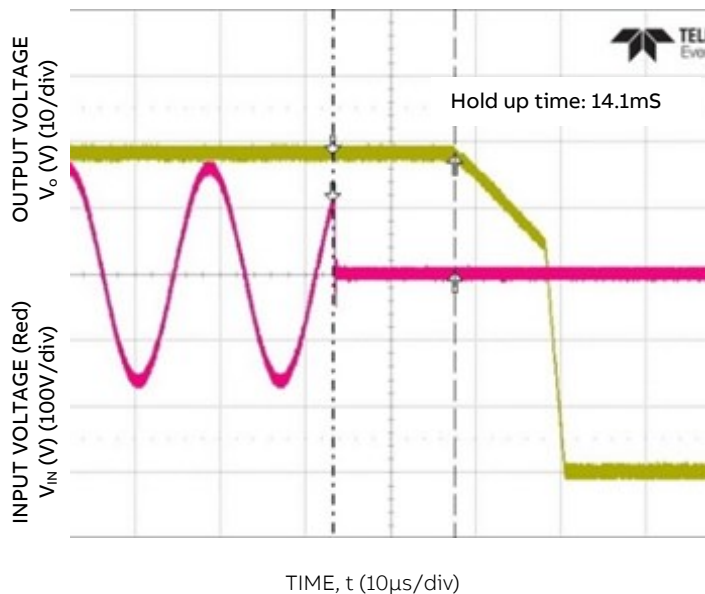

Figure 6. Typical Hold-up Waveforms ($V_{IN} = 115\text{Vac}$, 100% Load)

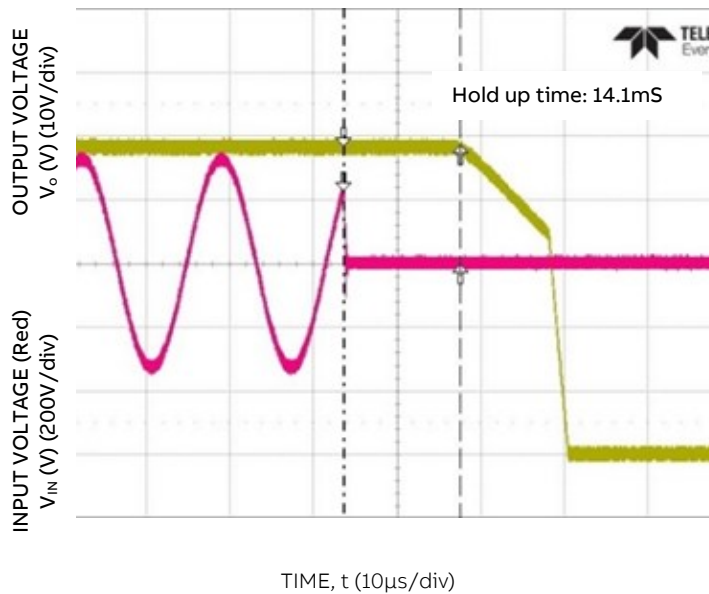
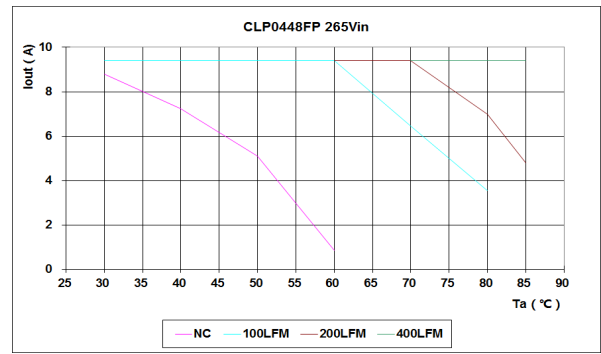
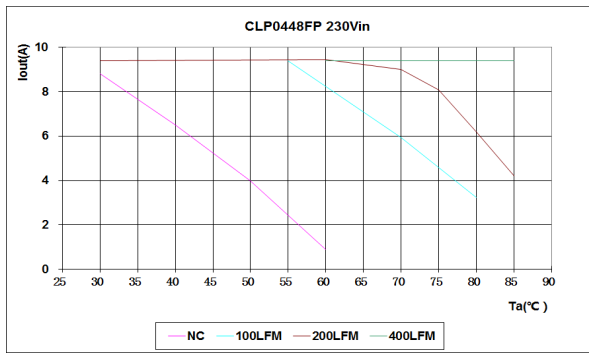
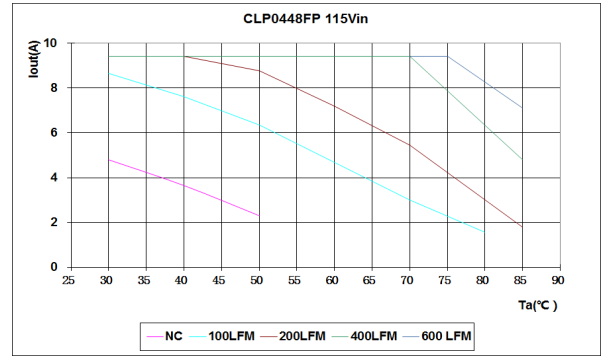
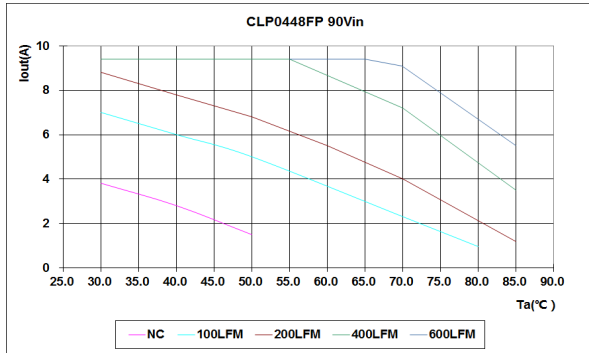

Figure 7. Typical Hold-up Waveforms ($V_{IN} = 230\text{V}$, 100% Load)

Technical Specifications (continued)

Z01 Derating Curves (Airflow Application)



Z02 Derating Curves (Airflow Application)

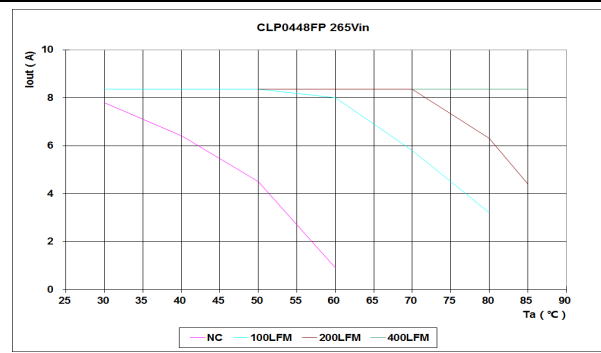
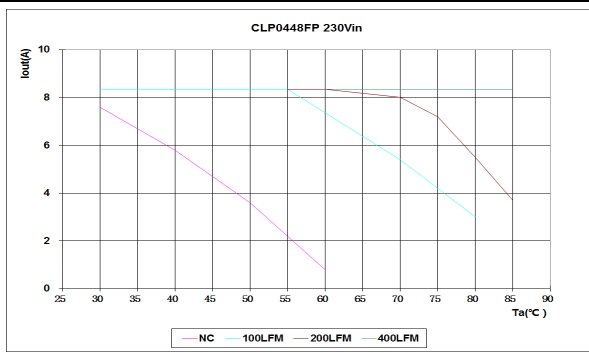
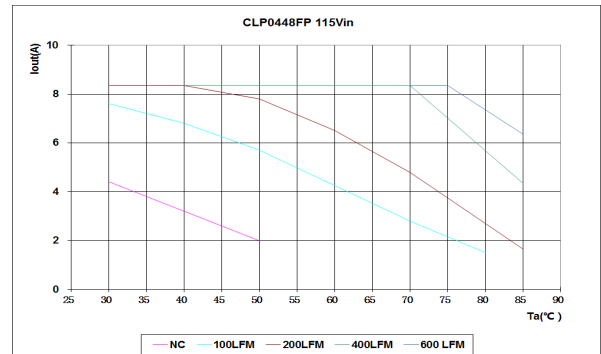
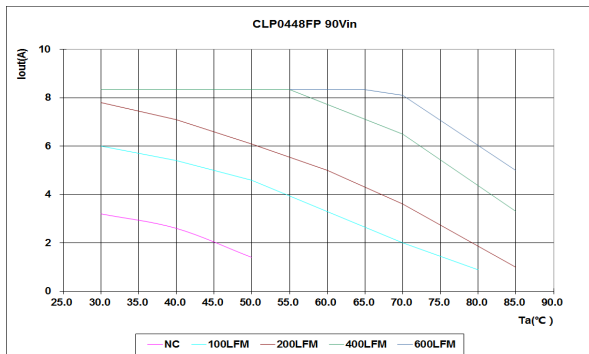

Technical Specifications (continued)

Z01 Derating Curves (Enclosure Application)

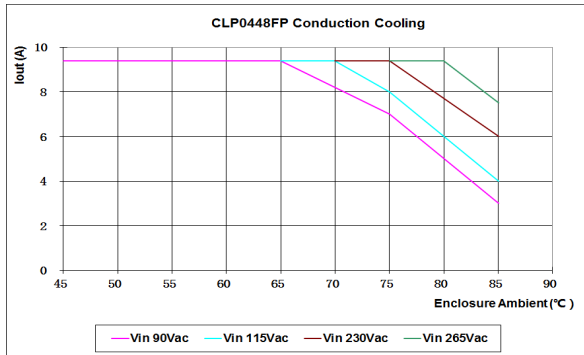

Z02 Derating Curves (Enclosure Application)

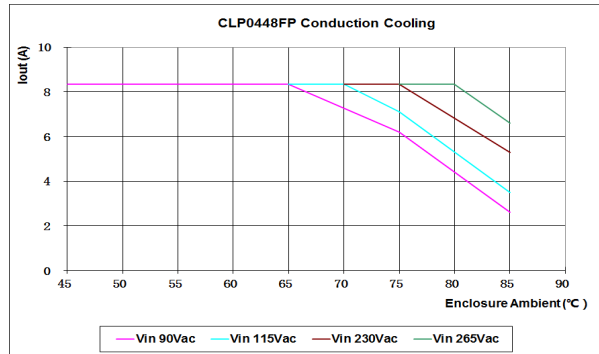

NOTE: The load is not inside the enclosure when doing above application power derating curves test.

Technical Specifications (continued)

Safety Considerations

The CLP0448 power supply is intended for inclusion in other equipment and the installer must ensure that it is in compliance with all the requirements of the end application. This product is only for inclusion by professional installers within other equipment and must not be operated as a stand-alone product. The power supply meets Class 1, IEC62368-1, EN62368-1, with the applicable national deviations which approved by TUV and UL (Recognized Component) C-UL (Canadian Approval by UL).

Feature Descriptions

Standby Power Supply

A standby output of 5V in the CLP0448 power supply comes on when input in the operating range is applied. 5V standby power is not isolated with main output.

Remote On/Off

The CLP0448 power supply features a TTL-compatible On/Off control input. The power supply turns ON when the On/Off input goes low, and turns OFF when the input goes high. Note that if the On/Off pin is left unconnected, the power supply main output will turn ON when AC input is present.

Output Voltage Adjustment

The output voltage can be adjusted between 47V and 53V using a potentiometer on the power supply.

Remote Sense

The power supply has both positive and negative remote sense connections that can be connected to the positive and negative rails of the main output near the load. The power supply operates even without the remote sense connections being made. Do not use this function when in units parallel working mode.

Overcurrent Protection

To provide protection in a fault condition (output overload), the power supply is equipped with internal current-limiting circuitry and can endure current limiting continuously. At the point of current-limit inception, the unit enters hiccup mode. The power supply operates normally once the output current is brought back into its specified range.

Overvoltage Protection

Overvoltage protection is a feature of the CLP0448 power supply that protects both the load and the power supply from an output overvoltage condition. When an overvoltage occurs, the power supply shuts down and latches off until the overvoltage condition is removed. It is necessary to recycle the input to restart the power supply when this protection is activated.

Overtemperature Protection

For additional protection in a fault condition the CLP0448 is equipped with a thermal shutdown circuit which detects excessive internal temperatures and shuts the unit down. Once the power supply goes into overtemperature shutdown, it will cool before attempting to restart. The overtemperature protection circuit will typically kick in when the unit is operated at 450W output with an ambient temperature of 66°C and 1m/s (200LFM) airflow at 180Vac. In a sealed enclosure OTP will depend on enclosure design and cooling.

Input Undervoltage Lockout

At input voltages below the input under-voltage lockout limit, power supply operation is disabled. The power supply will begin to operate at an input voltage above the under-voltage lockout turn-on threshold.

DC OK

The CLP0448 provides a DC OK signal that indicates when the output has come up and is in regulation. This is an open-collector type signal that goes high when the output is available and within regulation. DC_OK refers to 5V_ return; DC_OK signal is independent of the other when parallel is working.

Power Good LED

A green LED on board the power supply illuminates when the main output voltage is above 45V.

Paralleling with Active Output Current Sharing (option)

The CLP0448 is capable of being employed in a paralleling scheme, following are some design attributes that need to be carefully considered prior to attempting a parallel operation with multiple CLP0448's. With the following design criteria the CLP0448 will load share at an accuracy of +/-5%, when the total current draw is at levels above 20% of max overall loading.

- Current share signals of each power supply to be connected.
- An external Oring function needs to be employed at the Vout (+) signal. An oring diode or a MOSFET & controller scheme can be used.
- The 5V Standby Return SHOULD NEVER be connected with the VOUT-(RETURN). 5V stby returns will need to be connected together, the 5V stby Vout(+) leg remain separate. The 5V stby output is not designed to be paralleled; if there is a desire for these to be paralleled for load sharing, then other considerations need to be included as well. Contact your local sales rep for FAE involvement.
- In the parallel scheme the remote sense function needs to be unused and remote sense signals left floating.

Technical Specifications

Assembling

Please use metal screw to mount the unit and make sure 4 mounting holes connected to Earth well.

In Applications where the power supply is enclosed, special attention to clearances between the supply and the enclosure should be a min. 3.5mm on all sides for improved safety. For additional protection a layer of Kapton tape, 3 mil in thickness covering the whole surface under the supply is recommend. If a cover is used a 3 mil Kapton Tape covering the whole cover is also recommend. Please contact your local ABB FAE if further information is need.

Thermal Considerations

The power supply can be operated in a variety of thermal environments; however sufficient cooling should be provided to ensure reliable operation.

Considerations include ambient temperature, airflow, power supply dissipation and the need for increased reliability. A reduction in the operating temperature of the power supply will result in increased reliability. The power supply can be capable of delivering full output power of 450W at an ambient temperature of at least 50°C and 1m/s (200LFM) of airflow. The output power can be derated at higher output temperatures and lower airflow, but can at least deliver 300W at 70°C and 1m/s (200LFM) of airflow.

In addition, in conduction-cooled applications with a suitable enclosure, the power supply can be capable of delivering 340W when the enclosure ambient temperature is 55°C, with operation at 90VAC in.

Operation in a Sealed Enclosure

The CLP0448 power supply can also be operated in a sealed enclosure or in an environment where cooling is primarily via conduction. Figure 10 shows an arrangement where thermally conductive pads are used to transfer heat from the top and bottom of the power supply into the enclosure. Under such conditions, the power supply is capable of reduced power operation as shown on page 7 (Derating Curves/Enclosure Application).

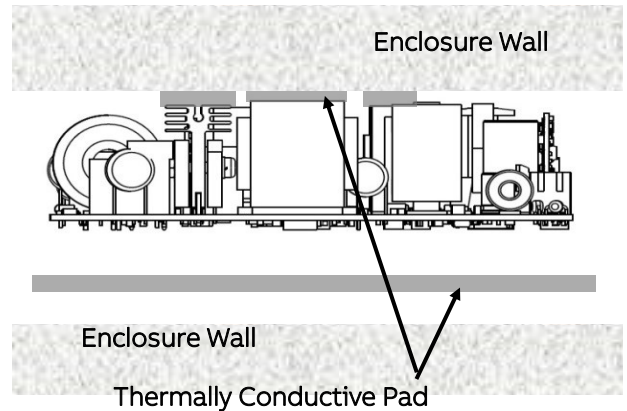
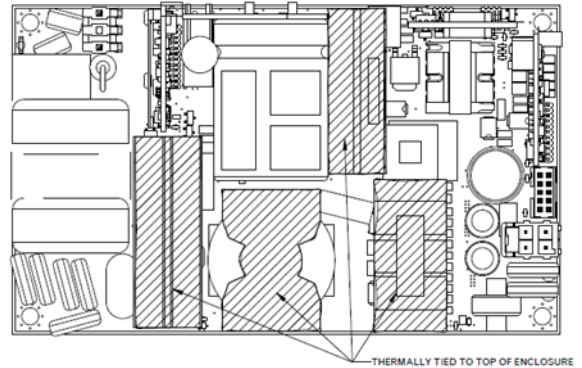

Fig. 10. Example arrangement of the CLP0448 for sealed enclosure applications.

Thermal conductivity should be 3.0 W/m-K for thermal pad application and 1kV+ isolation, example:

Thermal gap pad:

http://www.bergquistcompany.com/pdfs/dataSheets/PDS_GP_HC3_0714%20v7.pdf

Thermal gap pad:

<https://www.lairdtech.com/products/tputty-502>

Technical Specifications (continued)

Mechanical Outline (CLP0448)

TOP VIEW

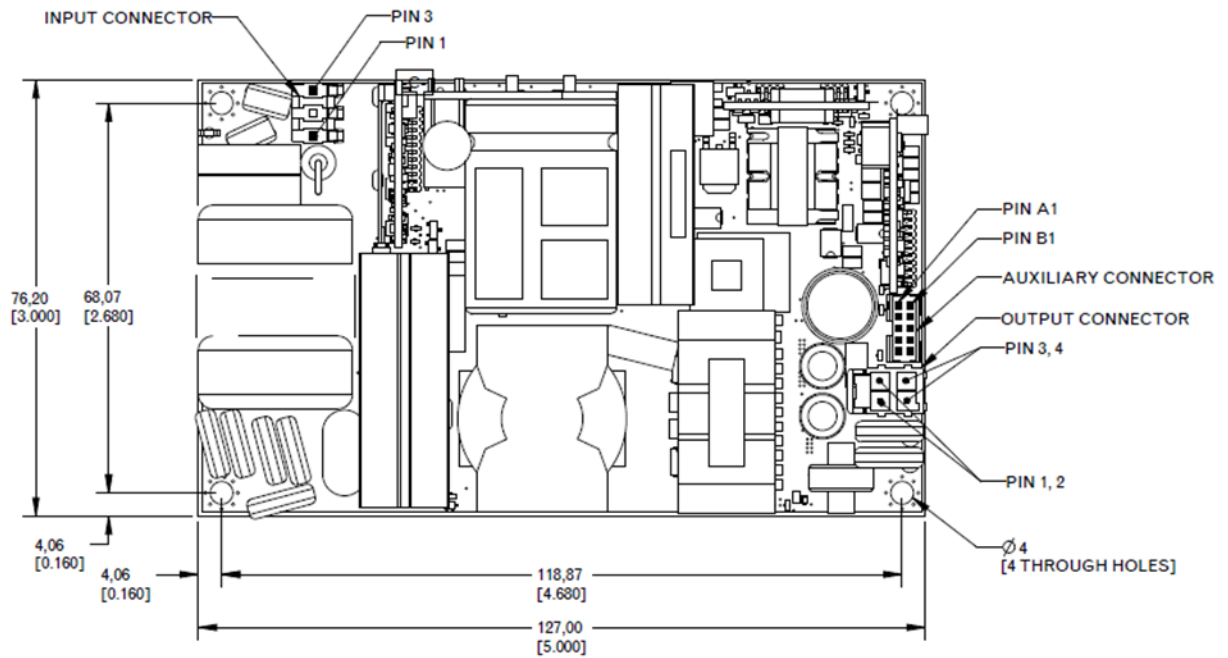

SIDE VIEW

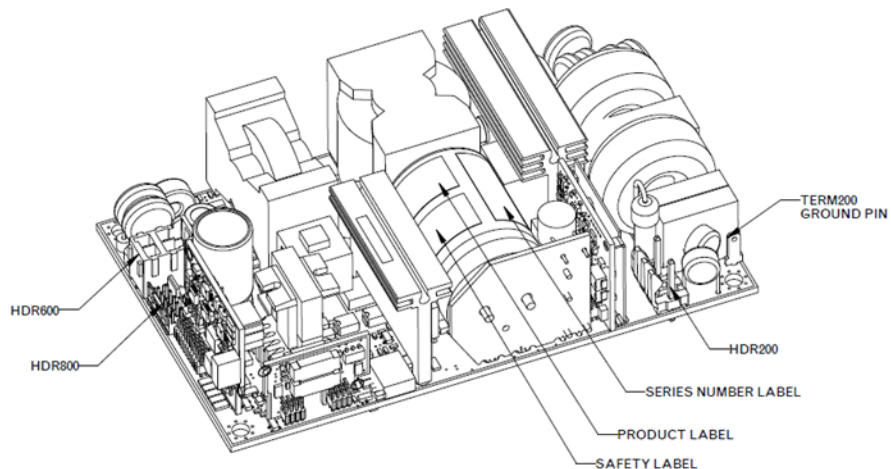
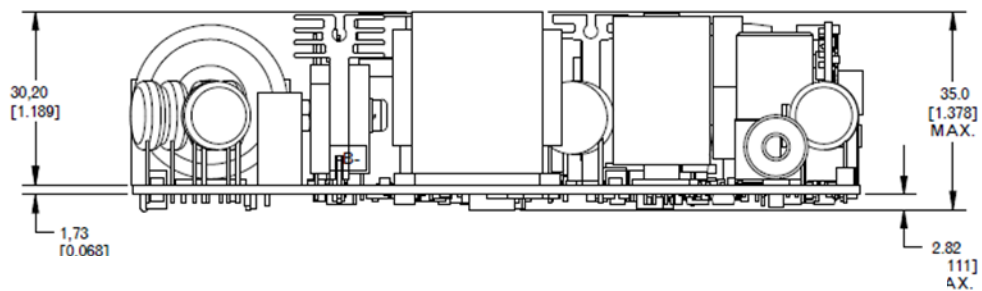

Technical Specifications (continued)

Metal Cover Accessory (optional)

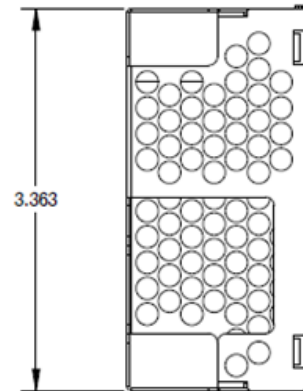
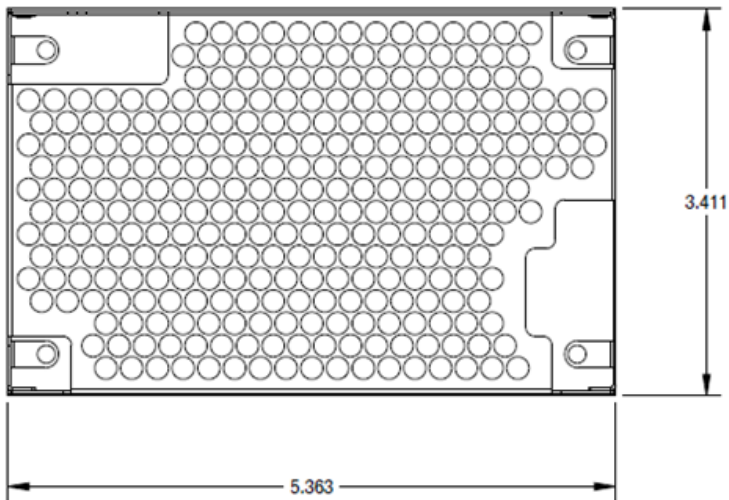
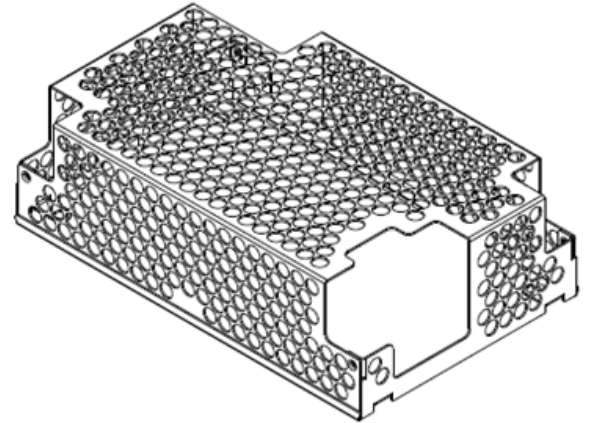
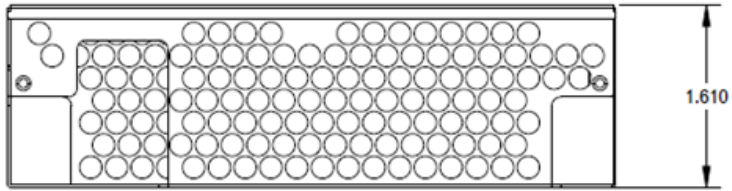

Technical Specifications (continued)

Connector Information

Connector	Connector on Power Supply	Mating Connector
AC Input Connector (HDR200)	Molex 41671-3473 or equivalent	Molex 09-50-8031 or equivalent
DC Output Connector (HDR600)	Molex 172298-1204 or equivalent	Molex 1722581104 or equivalent
Auxiliary Connector (HDR800)	FCI 98414-G04-10ULF or equivalent	FCI 90311-010LF or equivalent
Ground Pin (TERM200)	TE P/N: 63756-1	TE 110 series receptacles (e.g., 63093-1 18~14AWG) or equivalent

Pinout Information

AC Input Connector		DC Output Connector		Auxiliary Connector	
Pin 1	Line, VIN (+)	Pins 1 and 2	VOUT +	Pin A1 - SV Standby	Pin B1 - PARALLEL
Pin 2	NC (removed)	Pins 3 and 4	VOUT - (return)	Pin A2 - SV Standby	Pin B2 - SV Standby Return
Pin 3	Neutral, VIN (-)			Pin A3 - NC	Pin B3 - SV Standby Return
				Pin A4 - REMOTE SENSE +	Pin B4 - DC_OK
				Pin A5 - REMOTE SENSE -	Pin B5 - ON/OFF

Ordering Information

Device Code	Input Voltage Range	Output Voltage	Output Current	On/Off Control	Standby Supply	Temperature Range
CLP0448FPX XXZ01A	90-265Vac	48Vdc	9.4A	Negative Logic	5V @ 1A	-40 to 85°C
CLP0448FPX XXZ02A	90-265Vac	54Vdc	8.3A	Negative Logic	5V @ 1A	-40 to 85°C
CLP04XXCVR XXZ01A					Metal Cover Accessory	

Summary of Changes

Version No.	Changes in document
1.4	Change in environmental compliance standards
	Change in Safety Considerations
	EN55022 updated to EN55032



ABB

601 Shiloh Rd.
Plano, TX USA

[Go.ABB/Industrial](#)

We reserve the right to make technical changes or modify the contents of this document without prior notice. With regard to purchase orders, the agreed particulars shall prevail. ABB does not accept any responsibility whatsoever for potential errors or possible lack of information in this document.

We reserve all rights in this document and in the subject matter and illustrations contained therein. Any reproduction, disclosure to third parties or utilization of its contents – in whole or in parts – is forbidden without prior written consent of ABB.

Copyright© 2020 ABB
All rights reserved

X-ON Electronics

Largest Supplier of Electrical and Electronic Components

Click to view similar products for [Switching Power Supplies](#) category:

Click to view products by [ABB](#) manufacturer:

Other Similar products are found below :

[70841011](#) [73-551-0005](#) [73-551-0048](#) [PS3E-B12F](#) [PS3E-E12F](#) [AAD600S-4-OP](#) [R22095](#) [KD0204](#) [9021](#) [LDIN100150](#) [LPM000-BBAR-01](#)
[LPX17S-C](#) [EVS57-10R6/R](#) [FP80](#) [FRV7000G](#) [22929](#) [PS3E-F12F](#) [CQM1IA121](#) [40370121900](#) [VI-PU22-EXX](#) [40370121910](#) [LDIN5075](#)
[LPM615-CHAS](#) [LPX140-C](#) [09-160CFG](#) [70841025](#) [VPX3000-CBL-DC](#) [LPM000-BBAR-05](#) [LPM000-BBAR-08](#) [LPM124-OUTA1-48](#)
[LPM000-BBAR-07](#) [LPM109-OUTA1-10](#) [LPM616-CHAS](#) [08-30466-1055G](#) [08-30466-2175G](#) [08-30466-2125G](#) [DMB-EWG](#) [TVQF-1219-](#)
[18S](#) [6504-226-2101](#) [CQM1IPS01](#) [SP-300-5](#) [CQM1-IPS02](#) [VI-MUL-ES](#) [22829](#) [08-30466-0065G](#) [VI-RU031-EWWX](#) [08-30466-0028G](#) [VI-](#)
[LUL-EU](#) [EP3000AC48INZ](#) [VP-C2104853](#)