

Cable Clamps and Clips

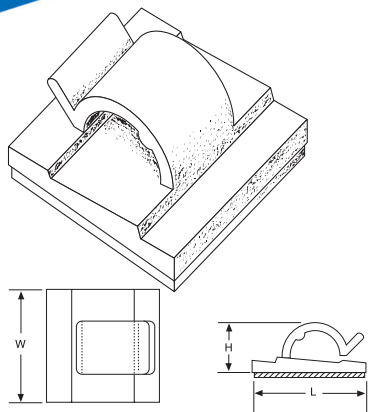

Versatile adhesive clips keep cable paths organized

- Diverse cable clamps for bundle diameters from 0.160 in. to 0.620 in.
- Mounted on a rubber-based closed cell foam adhesive
- Flexible center tang for removal or addition of cables



Cat. No.	Material	Height H		Length L		Width W		Maximum Bundle		Mounting Method	Std. Pkg.
		(in.)	(mm)	(in.)	(mm)	(in.)	(mm)	(in.)	(mm)		
Round Adhesive Clips											
RANY-160-9-D	Nylon	0.250	6.35	0.630	16.0	0.580	14.73	0.160	4.06	Rubber-based adhesive	500
RANY-280-9-D		0.410	10.41	1.000	25.40	1.000	25.40	0.280	7.11		
RANY-530-9-D		0.620	15.75					0.530	13.46		
RANY-620-9-D		0.560	14.22	1.250	31.75	1.120	28.45	0.620	15.75		

Natural nylon colour.

Adhesive for use in temperatures ranging from 0°C to 66°C (32°F to 150°F).

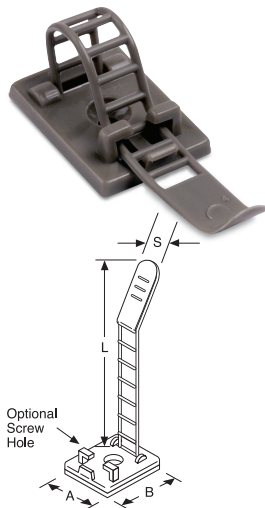

Release and refasten with ease — in three adjustable sizes!

- Three sizes for bundles from 0.118 in. to 0.984 in.
- Ladder-style fastener is easily released and refastened
- Supplied on a rubber-based closed cell foam adhesive
- Optional screw hole for #4 or #5 flat head screw



Cat. No.	Material	Height A		Length B		Width S		Maximum Bundle		Applied Wire Range		Screw Hole Diameter		Std. Pkg.
		(in.)	(mm)	(in.)	(mm)	(in.)	(mm)	(in.)	(mm)	(in.)	(mm)	(in.)	(mm)	
Adjustable Cable Clamps														
ULNY-013-8-C	Grey Nylon	0.709	18.00	0.984	24.99	0.314	7.98	2.340	59.44	0.118 - 0.500	3.0 - 12.7	0.110	2.79	100
ULNY-013-9-C	Natural Nylon													
ULNY-018-8-C	Grey Nylon	0.827	21.00	1.180	29.97	0.472	11.99	3.120	79.25	0.197 - 0.827	5.0 - 21.0			
ULNY-023-8-C		0.984	24.99	1.380	35.05	0.551	14.00	3.370	79.25	0.275 - 0.984	7.0 - 25.0	0.135	3.43	

Adhesive for use in temperatures ranging from 0°C to 66°C (32°F to 150°F).

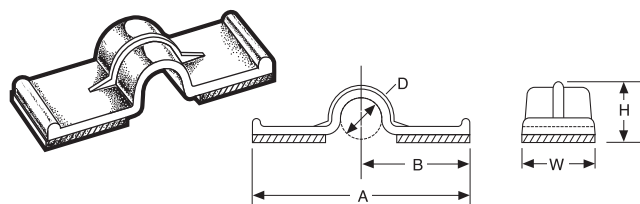

Choose from four sizes to accommodate bundles up to 1/2 in.

- Clips are provided on a rubber-based closed cell foam adhesive
- Stocked in natural nylon 6/6 colour. Contact your T&B Sales Representative for availability in special materials

Std. Pkg. Cat. No.	Bulk Pkg. Cat. No.	Material	D Diameter		A		B		H		W		Std. Pkg.	Bulk Pkg.
			(in.)	(mm)	(in.)	(mm)	(in.)	(mm)	(in.)	(mm)	(in.)	(mm)		
Press Clips														
PCNY-125-9-C	PCNY-125-9-D	Nylon	0.13	3.30	0.76	19.30	0.38	9.65	0.21	5.33	0.38	9.65	100	500
PCNY-250-9-C	PCNY-250-9-D		0.25	6.35	1.38	35.05	0.69	17.53	0.32	8.13	0.50	12.70		
PCNY-375-9-C	PCNY-375-9-D		0.38	9.65	1.47	37.34	0.74	18.80	0.44	11.176	0.63	16.00		
PCNY-500-9-C	PCNY-500-9-D		0.50	12.70	1.59	40.39	0.80	20.32	0.59	15.00	0.75	19.05		

For use in temperatures ranging from 0°C to 66°C (32°F to 150°F).

Cable Clamps and Clips

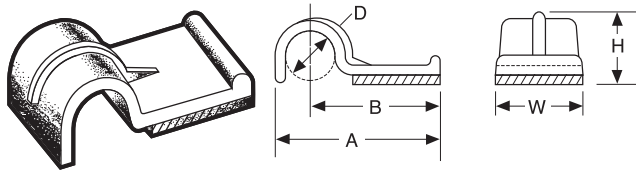

Eliminate the dangers of loose cables with these clips

- 4 sizes to accommodate bundles up to 1/2 in.
- Clips are provided on a rubber-based closed cell foam adhesive
- Stocked in natural nylon 6/6 colour. Contact your T&B Sales Representative for availability in special materials

Std. Pkg. Cat. No.	Bulk Pkg. Cat. No.	Material	D Diameter		A		B		H		W		Std. Pkg.	Bulk Pkg.
			(in.)	(mm)	(in.)	(mm)	(in.)	(mm)	(in.)	(mm)	(in.)	(mm)		
Half Press Clips														
HCNY-125-9-C	HCNY-125-9-M	Nylon	0.13	3.30	0.49	12.45	0.38	9.65	0.18	4.57	0.38	9.65	100	1,000
HCNY-250-9-C	HCNY-250-9-M		0.25	6.35	0.87	22.10	0.69	17.53	0.33	8.38	0.50	12.70		
HCNY-375-9-C	HCNY-375-9-M		0.38	9.65	0.98	25.90	0.75	19.05	0.42	10.67	0.63	16.00		
HCNY-500-9-C	HCNY-500-9-M		0.50	12.70	1.11	28.20	0.82	20.83	0.56	14.22	0.75	19.05		

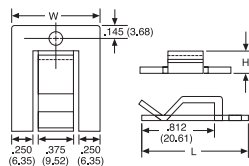
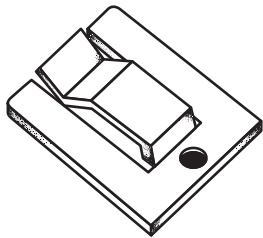

Flat design provides an attractive, yet discreet look

- Flat ribbon cable clamp with mounting hole for #8 screw
- Stocked in natural nylon 6/6 colour
- Flexible center tang enables easy removal and replacement of desired cable

Cat. No.	Material	Height H		Length L		Width W		Mounting Method	Std. Pkg.
		(in.)	(mm)	(in.)	(mm)	(in.)	(mm)		
Flat Cable Screw Clip									
FSNY-812-9-C	Nylon	0.25	6.35	1.19	30.23	1.00	25.40	#8 Screw	100

For use in temperatures ranging from 0°C to 66°C (32°F to 150°F).

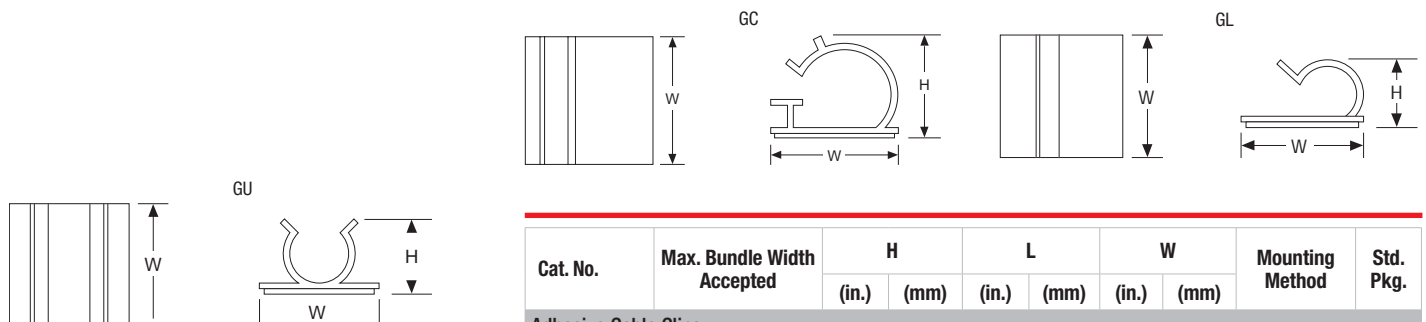

Cat. No.	Max. Bundle Width Accepted	H		L		W		Mounting Method	Std. Pkg.
		(in.)	(mm)	(in.)	(mm)	(in.)	(mm)		
Adhesive Cable Clips									
RANY-160-9-D	0.25	0.39	9.91	0.75	19.05	0.75	19.05	Adhesive	25
RANY-280-9-D	0.50	0.63	16.00	1.00	25.40	1.00	25.40		
RANY-530-9-D	0.25	0.76	19.30						
RANY-620-9-D	0.50			0.75	19.05	0.75	19.05		
RANY-620-9-D	0.25	0.47	11.94						
RANY-620-9-D	0.50								

Cable Clamps and Clips

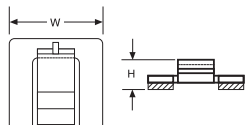
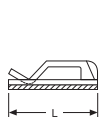

Low-profile clip for single or multiple layers of flat ribbon cable

- Supplied on a rubber-based closed cell foam adhesive
- Flexible center tongue for removal or addition of cables
- Stocked in natural nylon 6/6 colour

Std. Pkg. Cat. No.	Bulk Pkg. Cat. No.	Material	Height H		Length L		Width W		Mounting Method (in.)	Std. Pkg.	Bulk Pkg.
			(in.)	(mm)	(in.)	(mm)	(in.)	(mm)			
Flat Adhesive Clips											
FANY-812-9-C	FANY-812-9-D	Nylon	0.28	7.11	1.00	25.40	1.00	25.40	Adhesive	100	500

Natural nylon colour.

For use in temperatures ranging from 0°C to 66°C (32°F to 150°F).

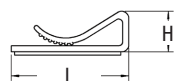
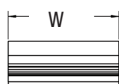

Adhesive eliminates need for tools when mounting clips

- Low-profile clip for single or multiple layers of flat ribbon cable
- "Single-Cut" on a rubber-based closed cell foam adhesive
- Grey PVC
- UL Flammability 94 V-0 (clip)

Std. Pkg. Cat. No.	Bulk Pkg. Cat. No.	Material	Height H		Length L		Width W		Mounting Method (in.)	Std. Pkg.	Bulk Pkg.
			(in.)	(mm)	(in.)	(mm)	(in.)	(mm)			
Flat PVC Clips											
FRPV-1000-8-C	FRPV-1000-8-D	Grey PVC	0.42	10.67	1.06	26.92	1.00	25.40	Adhesive	100	500

For use in temperatures ranging from 0°C to 66°C (32°F to 150°F).

Ideal for assembly applications

- 16 sizes for bundle diameters to 2.38 in.
- Removable and reusable. Twist by hand or with pliers to remove
- Stocked in weatherable Nylon. 100 pieces per package
- Request samples for testing to your application. Tested to 250 psi

Black.

For use in temperatures ranging from -40°C to 85°C (-40°F to 185°F).

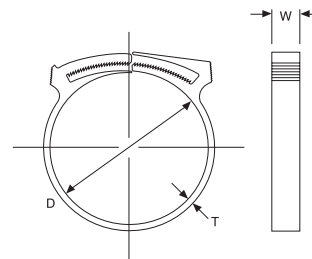
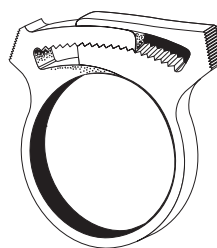

Cat. No.	D Nominal Diameter		D1 Closed Diameter		T Thickness		W Width		Std. Pkg.
	(in.)	(mm)	(in.)	(mm)	(in.)	(mm)	(in.)	(mm)	
Adjustable Cable Clamps									
GGNY-344-0-C	0.41	10.41	0.34	8.64	0.7	1.78	0.22	5.59	100
GGNY-406-0-C	0.47	11.94	0.41	10.41					
GGNY-750-0-C	0.88	22.35	0.75	19.05					
GGNY-875-0-C	1.00	25.40	0.88	22.35					

Cat. No.	D Nominal Diameter		D1 Closed Diameter		T Thickness		W Width		Std. Pkg.
	(in.)	(mm)	(in.)	(mm)	(in.)	(mm)	(in.)	(mm)	
Adjustable Cable Clamps									
GGNY-953-0-C	0.95	24.13	0.41	10.41	0.7	1.78	0.31	7.87	100
GGNY-1031-0-C	1.81	45.97	1.03	26.16					
GGNY-1250-0-C	1.44	36.58	1.25	31.75					
GGNY-1406-0-C	1.63	41.40	1.41	35.81			0.36	9.14	
GGNY-1687-0-C	1.91	48.51	1.34	34.04					
GGNY-1875-0-C	2.13	54.10	1.88	47.75					

Cable Clamps and Clips

Choose the diameter you need to clamp a specific-sized cable

- Fully radiused inside edges with size markings in inches and millimeters for easy identification
- Stocked in natural and black nylon 6/6
- Plain edge cable clamps are designed to perform to NAS-1397P
- 18 diameters and 2 widths with mounting holes for #8 and #10 screws
- Replace "-M" or "-D" with "-C" for 100 pack

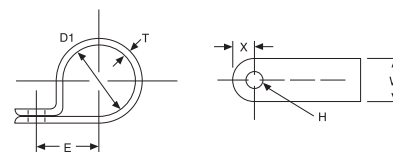

White Cat. No.	Black Cat. No.	H Mounting Hole Size	D1 Closed Dia.		E		T Thickness		W Width		X		Std. Pkg.
			(in.)	(mm)	(in.)	(mm)	(in.)	(mm)	(in.)	(mm)	(in.)	(mm)	
Half Press Clips													
N4NY-002-9-M	N4NY-002-0-M	#8	0.13	3.18	0.34	8.71	0.05	1.27	0.38	9.53			1,000
N4NY-003-9-M	N4NY-003-0-M		0.19	4.475	0.38	9.60							
N4NY-004-9-M	N4NY-004-0-M		0.25	6.35	0.42	10.70							
N4NY-005-9-M	N4NY-005-0-M		0.31	7.92	0.44	11.20							
N4NY-006-9-M	N4NY-006-0-M		0.38	9.53	0.46	11.79							
N4NY-007-9-M	N4NY-007-0-M		0.44	11.10	0.50	12.70							
N4NY-008-9-M	N4NY-008-0-M		0.50	12.70	0.53	13.46							
N4NY-002B-9-M	N4NY-002B-0-M		0.13	3.18	0.34	8.71							
N4NY-003B-9-M	N4NY-003B-0-M	0.19	4.475	0.38	9.60								
N4NY-004B-9-M	N4NY-004B-0-M	0.25	6.35	0.42	10.70								
N4NY-005B-9-M	N4NY-005B-0-M	0.31	7.92	0.44	11.20								
N4NY-006B-9-M	N4NY-006B-0-M	0.38	9.53	0.46	11.79								
N4NY-007B-9-M	N4NY-007B-0-M	0.44	11.10	0.50	12.70								
N4NY-008B-9-M	N4NY-008B-0-M	0.50	12.70	0.53	13.46								
N6NY-004C-9-M	N6NY-004C-0-M	#10	0.25	6.35	0.44	11.10	0.06	1.52	0.50	12.70	0.22	5.54	
N6NY-005C-9-M	N6NY-005C-0-M		0.31	7.92	0.47	12.04							
N6NY-006C-9-M	N6NY-006C-0-M		0.38	9.53	0.50	12.70							
N6NY-007C-9-M	N6NY-007C-0-M		0.44	11.10	0.53	13.54							
N6NY-008C-9-M	N6NY-008C-0-M		0.50	12.70	0.55	14.05							
N6NY-009-9-M	N6NY-009-0-M		0.56	14.27	0.60	15.32							
N6NY-010-9-M	N6NY-010-0-M		0.63	15.88	0.63	15.88							
N6NY-011-9-M	N6NY-011-0-M		0.69	17.45	0.67	16.89							
N6NY-012-9-M	N6NY-012-0-M		0.75	19.05	0.70	17.75							
N6NY-013-9-M	N6NY-013-0-M		0.81	20.62	0.77	19.43							
N6NY-014-9-M	N6NY-014-0-M		0.88	22.23	0.80	20.19							
N6NY-016-9-M	N6NY-016-0-M		1.00	25.40	0.83	21.00							
N6NY-018-9-D	N6NY-018-0-D	1.13	28.58	0.94	23.88								
N6NY-019-9-D	N6NY-019-0-D	1.19	30.15	0.96	24.46								
N6NY-020-9-D	N6NY-020-0-D	1.25	31.75	0.98	24.90								
N6NY-022-9-D	N6NY-022-0-D	1.38	34.93	1.05	26.54								
N6NY-024-9-D	N6NY-024-0-D	1.50	38.10	1.11	28.30								
													1,000

X-ON Electronics

Largest Supplier of Electrical and Electronic Components

Click to view similar products for [Wire Identification category](#):

Click to view products by [ABB manufacturer](#):

Other Similar products are found below :

[CU6337-000](#) [CU6342-000](#) [FCA-410-12](#) [11631010](#) [1-1768037-1](#) [1-1768037-2](#) [1-1768050-0](#) [PXLK-VI](#) [Q62184-1](#) [A64304-000](#) [QMT221](#)
[HK032WE1NF038B](#) [1330-0519-10](#) [1395199-1](#) [1395200-1](#) [1395202-1](#) [DMVF050WE-300S6](#) [D-SCE-1K-2.4-50-4-CS7834](#) [1538738-1](#)
[E90935-000](#) [EC1238-000](#) [EC1465-000](#) [EC1855-000](#) [EC1859-000](#) [EC1863-000](#) [EC5415-000](#) [EC7277-000](#) [EC7352-000](#) [EC7603-000](#)
[EC7707-000](#) [EC7735-000](#) [EC7768-000](#) [EC7828-000](#) [EC7854-000](#) [EC7952-000](#) [EC8128-000](#) [1768037-8](#) [1768041-7](#) [NC-127191-10-9](#)
[HS048WE2NF038B](#) [C03232-000](#) [HTCM-SCE-14-4H-9](#) [HTMS-3/16-9](#) [HT-SCE-1/4-2.0-4](#) [HT-SCE-3/16-2.0-4](#) [HTTMS-1/2-1.50-9](#) [HTTMS-](#)
[CM-1/2-4H-9](#) [HX-SCE-19.0-50-9](#) [HX-SCE-6.4-50-4](#) [C25254-000](#)