

80A GigaDlynx™: Non-Isolated DC-DC Power Modules

4.5Vdc –14Vdc input; 0.5Vdc to 2.0Vdc output; 80A Output Current



RoHS Compliant

Applications

- Networking equipment
- Telecommunications equipment
- Servers and storage applications
- Distributed power architectures
- Intermediate bus voltage applications
- Industrial equipment

Features

- Compliant to RoHS Directive 2011/65/EU and amended Directive (EU) 2015/863.
- Compliant to REACH Directive (EC) No 1907/2006
- Compatible in a Pb-free or SnPb reflow environment (Z versions)
- Compliant to IPC-9592 (September 2008), Category 2, Class II
- Wide Input voltage range (4.5Vdc-14Vdc)
- Output voltage programmable from 0.6Vdc to 2.0Vdc via external resistor. Digitally adjustable down to 0.5Vdc output.
- Digital interface through the PMBus™ # protocol
- Digital Tunable Loop™ to optimize dynamic output voltage response
- Remote On/Off
- Digital Sequencing
- Power Good signal
- Fixed switching frequency with capability for external synchronization
- Ability to sink and source current
- Output overcurrent protection (non-latching)
- Over temperature protection
- Cost efficient open frame design
- Small size: 33.02mm x 22.86mm x 12.7mm [1.3" x 0.9" x 0.5"]
- Wide operating temperature range [-40°C to 85°C]
- ANSI/UL* 62368-1 and CAN/CSA† C22.2 No. 62368-1 Recognized, DIN VDE‡ 0868-1/A11:2017 (EN62368-1:2014/A11:2017)
- ISO** 9001 and ISO 14001 certified manufacturing facilities

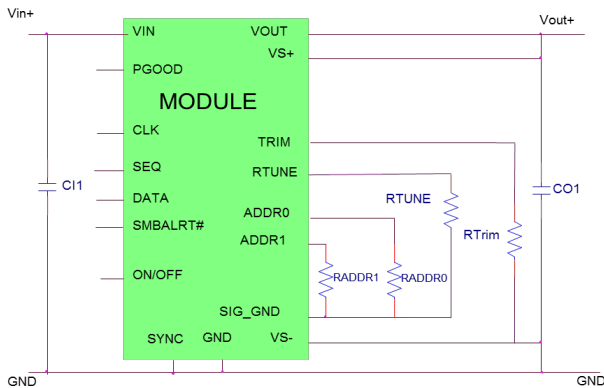

Description

The 80A Digital GigaDlynx™ power modules are non-isolated dc-dc converters that deliver up to 80A of output current. These modules operate over a wide range of input voltage (V_{IN} =4.5Vdc - 14Vdc) and provide a precisely regulated output voltage from 0.6Vdc to 2Vdc, programmable via an external resistor and/or PMBus control. Features include a digital interface using the PMBus protocol, remote On/Off, adjustable output voltage, over current, over voltage and over temperature protection. The PMBus interface supports many commands to both control and monitor the module. The module also includes the Digital Tunable Loop™ feature that allows the user to optimize the dynamic response of the converter with reduced amounts of output capacitance leading to savings on cost and PWB area.

* UL is a registered trademark of Underwriters Laboratories, Inc.
 † CSA is a registered trademark of Canadian Standards Association.
 ‡ VDE is a trademark of Verband Deutscher Elektrotechniker e.V.
 ** ISO is a registered trademark of the International Organization of Standards
 # The PMBus name and logo are registered trademarks of the System Management Interface Forum (SMIF)



80A GigaDLynx™: Non-Isolated DC-DC Power Modules

4.5Vdc –14Vdc input; 0.6Vdc to 2.0Vdc output; 80A Output Current

Absolute Maximum Ratings

Stresses in excess of the absolute maximum ratings can cause permanent damage to the device. These are absolute stress ratings only, functional operation of the device is not implied at these or any other conditions in excess of those given in the operations sections of the technical requirements. Exposure to absolute maximum ratings for extended periods can adversely affect the device reliability.

Parameter	Device	Symbol	Min	Max	Unit
Input Voltage Continuous	All	V_{IN}	-0.3	15	V
SEQ, ADDR0, ADDR1, RTUNE, VTRACK				2.0	V
VS+	All			3.0	V
ON/OFF				15	V
SYNC, CLK, DATA, SMBALERT#, PGOOD	All			5.5	V
Operating Ambient Temperature (see Thermal Considerations section)	All	T_A	-40	85	°C
Storage Temperature	All	T_{stg}	-55	125	°C

Electrical Specifications

Unless otherwise indicated, specifications apply over all operating input voltage, resistive load, and temperature conditions.

Parameter	Device	Symbol	Min	Typ	Max	Unit
Operating Input Voltage	All	V_{IN}	4.5	—	14	Vdc
Maximum Input Current ($V_{IN}=4.5V$ to $14V$, $I_o=I_{o,max}$)	All	$I_{IN,max}$			46	A _{dc}
Input No Load Current ($V_{IN} = 12Vdc$, $I_o = 0$, module enabled)	$V_{O,set} = 0.6 Vdc$	$I_{IN,No load}$		145		mA
	$V_{O,set} = 2.0Vdc$	$I_{IN1No load}$		190		mA
Input Stand-by Current ($V_{IN} = 12Vdc$, module disabled)	All	$I_{IN,stand-by}$		45		mA
Inrush Transient	All	I^2t		1		A ² s
Input Noise on nominal output ($V_{IN}=V_{IN, nom}$ and $I_O=I_O, min$ to I_O,max , $C_{in} = 6 \times 22\mu F + 1 \times 470\mu F$) Peak-to-Peak (Full Bandwidth)	All				500	mV _{pp}
Input Reflected Ripple Current, peak-to-peak (5Hz to 20MHz, $1\mu H$ source impedance; $V_{IN} = 0$ to $14V$, $I_o=I_{o,max}$; See Test Configurations)	All			40		mA _{p-p}
Input Ripple Rejection (120Hz)	All			-55		dB
Output Voltage Set-point (with 0.1% tolerance for external resistor used to set output voltage)	0 to 70°C	$V_{O,set}$	-0.5		+0.5	% $V_{O,set}$
	-40 to +85°C		-0.8		+0.8	
Voltage Regulation ¹						
Line Regulation	($V_{IN}=V_{IN, min}$ to $V_{IN, max}$)			3		mV
Load ($I_o=I_{o, min}$ to $I_{o, max}$) Regulation	All			3		mV

¹ Worst case Line and load regulation data, all temperatures, from design verification testing as per IPC9592.

80A GigaDLynx™: Non-Isolated DC-DC Power Modules

4.5Vdc –14Vdc input; 0.6Vdc to 2.0Vdc output; 80A Output Current

Electrical Specifications (continued)

Parameter	Device	Symbol	Min	Typ	Max	Unit
Adjustment Range (selected by an external resistor) (Some output voltages may not be possible depending on the input voltage – see Feature Descriptions Section)	All	V_{OUT}	0.6		2.0	Vdc
PMBus Adjustable Output Voltage Range	All	$V_{O,adj}$	0.5	-	2.0	Vdc
PMBus Output Voltage Adjustment Step Size	All			0.233		% $V_{O,set}$
Remote Sense Range	All				0.4	Vdc
Output Ripple and Noise on nominal output ($V_{IN}=V_{IN,nom}$ and $I_O=I_{O,min}$ to $I_{O,max}$ $C_O = 6 \times 47\mu F + 4 \times 0.1\mu F$, $C_{in} = 6 \times 22\mu F + 1 \times 470\mu F$) Peak-to-Peak (Full bandwidth) RMS (Full bandwidth)	All				30 12	mV_{pk-pk} mV_{rms}
External Capacitance						
Minimum output capacitance (ESR $\geq 3 \text{ m}\Omega$)	All	$C_{O,min}$	470	—	—	μF
Maximum output capacitance (ESR $\geq 3 \text{ m}\Omega$)	All	$C_{O,max}$	—	—	16000	μF
Output Current (in either sink or source mode)	All	I_o	0		80	Adc
Output Current Limit Inception (Hiccup Mode) (current limit does not operate in sink mode)	All	$I_{o,lim}$		91		Adc
Output Short-Circuit Current ($V_O \leq 260\text{mV}$) (Hiccup Mode)	All	$I_{o,s/c}$		14.6		Arms
Efficiency $V_{IN} = 12\text{Vdc}$, $T_A = 25^\circ\text{C}$ $I_O = I_{O,max}$, $V_O = V_{O,set}$	$V_{O,set} = 0.6\text{Vdc}$ $V_{O,set} = 0.8\text{Vdc}$ $V_{O,set} = 1.0\text{Vdc}$ $V_{O,set} = 1.2\text{Vdc}$ $V_{O,set} = 1.5\text{Vdc}$ $V_{O,set} = 2.0\text{Vdc}$	η η η η η η		82.4 85.7 88.1 89.6 91.2 92.8		% % % % % %
Switching Frequency	All	f_{sw}	-	400	-	kHz
Frequency Synchronization	All					
Synchronization Frequency Range	All		-10		+10	%
High-Level Input Voltage	All	$V_{IH,SYNC}$	2.0			V
Low-Level Input Voltage	All	$V_{IL,SYNC}$			0.4	V
Minimum Pulse Width, SYNC	All	t_{SYNC}	50			ns

General Specifications

Parameter	Device	Min	Typ	Max	Unit
Calculated MTBF ($I_O = 0.8I_{O,max}$, $T_A = 40^\circ\text{C}$) Telecordia Issue 3 Method 1 Case 3	All		39,165,215		Hours
Weight		—	22.5(0.793)	—	g (oz.)

80A GigaDLynx™: Non-Isolated DC-DC Power Modules

4.5Vdc –14Vdc input; 0.6Vdc to 2.0Vdc output; 80A Output Current

Feature Specifications

Unless otherwise indicated, specifications apply over all operating input voltage, resistive load, and temperature conditions. See Feature Descriptions for additional information.

Parameter	Device	Symbol	Min	Typ	Max	Unit
On/Off Signal Interface ($V_{IN}=V_{IN, min}$ to $V_{IN, max}$; open collector or equivalent, Signal referenced to GND) Device Code with no suffix - Negative Logic (See Ordering Information) (On/OFF pin is open collector/drain logic input with external pull-up resistor; signal referenced to GND) Logic High (Module OFF)						
Input High Current	All	I_{IH}	—	—	1	mA
Input High Voltage	All	V_{IH}	2	—	$V_{IN, max}$	Vdc
Logic Low (Module ON)						
Input low Current	All	I_{IL}	—	—	10	μA
Input Low Voltage	All	V_{IL}	-0.2	—	0.4	Vdc
Device Code with suffix “4” - Positive Logic (See Ordering Information) (On/OFF pin is open collector/drain logic input with external pull-up resistor; signal referenced to GND) Logic High (Module ON)						
Input High Current	All	I_{IH}	—	—	10	μA
Input High Voltage	All	V_{IH}	2	—	$V_{IN, max}$	Vdc
Logic Low (Module OFF)						
Input low Current	All	I_{IL}	—	—	300	μA
Input Low Voltage	All	V_{IL}	-0.2	—	0.4	Vdc
Turn-On Delay and Rise Times ($V_{IN}=V_{IN, nom}$, $I_o=I_{o, max}$, V_o to within ±1% of steady state) Case 1: On/Off input is enabled and then input power is applied (delay from instant at which $V_{IN} = V_{IN, min}$ until $V_o = 10\%$ of $V_{o, set}$) Case 2: Input power is applied for at least one second and then the On/Off input is enabled (delay from instant at which $V_{on/Off}$ is enabled until $V_o = 10\%$ of $V_{o, set}$) Output voltage Rise time (time for V_o to rise from 10% of $V_{o, set}$ to 90% of $V_{o, set}$)						
Case 1	All	T_{delay}	—	5.0	—	ms
Case 2	All	T_{delay}	—	500	—	μs
Output voltage Rise time	All	T_{rise}	—	2.0	—	msec
Output voltage overshoot ($T_A = 25^\circ\text{C}$ $V_{IN}= V_{IN, min}$ to $V_{IN, max}$, $I_o = I_{o, min}$ to $I_{o, max}$) With or without maximum external capacitance		Output			3.0	% $V_{o, set}$
Over Temperature Protection (See Thermal Considerations section)	$V_{in} \leq 6.5V$	T_{ref}		105		°C
	$V_{in} > 6.5V$			125		
PMBus Over Temperature Warning Threshold*	$V_{in} \leq 6.5V$	T_{WARN}		95		°C
	$V_{in} > 6.5V$			115		
Tracking Accuracy ($V_{IN, min}$ to $V_{IN, max}$; $I_{o, min}$ to $I_{o, max}$ $V_{SEQ} < V_o$) (Power-Up: 0.5V/ms) (Power-Down: 0.5V/ms)	All	$V_{SEQ} - V_o$			100	mV
	All	$V_{SEQ} - V_o$			100	mV
Input Undervoltage Lockout Turn-on Threshold Turn-off Threshold Hysteresis	All				4.5	Vdc
	All		4.1			Vdc
	All			0.25		Vdc
PMBus Adjustable Input Under Voltage Lockout Thresholds Resolution of Adjustable Input Under Voltage Threshold	All		4.5		14	Vdc
	All				10	mV

* Over temperature Warning – Warning may not activate before alarm and unit may shut down before warning.

80A GigaDLynx™: Non-Isolated DC-DC Power Modules

4.5Vdc –14Vdc input; 0.6Vdc to 2.0Vdc output; 80A Output Current

Feature Specifications (cont.)

Parameter	Device	Symbol	Min	Typ	Max	Units
PGOOD (Power Good)						
Signal Interface, $V_{supply} \leq 5VDC$						
Overvoltage threshold for PGOOD ON	All			108		% $V_{O, set}$
Overvoltage threshold for PGOOD OFF	All			110		% $V_{O, set}$
Undervoltage threshold for PGOOD ON	All			92		% $V_{O, set}$
Undervoltage threshold for PGOOD OFF	All			90		% $V_{O, set}$
Sink/source current capability into PGOOD pin	All				2	mA

* Over temperature Warning – Warning may not activate before alarm and unit may shut down before warning.

80A GigaDlynx™: Non-Isolated DC-DC Power Modules

4.5Vdc –14Vdc input; 0.6Vdc to 2.0Vdc output; 80A Output Current

Digital Interface Specifications

Unless otherwise indicated, specifications apply over all operating input voltage, resistive load, and temperature conditions. See Feature Descriptions for additional information.

Parameter	Conditions	Symbol	Min	Typ	Max	Unit
PMBus Signal Interface Characteristics						
Input High Voltage (CLK, DATA)		V_{IH}	2.0			V
Input Low Voltage (CLK, DATA)		V_{IL}			0.8	V
Output current – low (CLK, DATA, SMBALERT#)		I_{OL}			2	mA
PMBus Operating frequency range	Slave Mode	F_{PMB}	10	400	500	kHz
Data hold time		$t_{HD:DAT}$	300			ns
Data setup time		$t_{SU:DAT}$	100			ns
Clock low time-out		$t_{TIMEOUT}$		25	35	ms
Clock low period		t_{LOW}	1.3			μ s
Clock high period		t_{HIGH}	0.6			μ s
Clock or data fall time		t_F			300	ns
Clock or data rise time		t_R			300	ns
Internal Pull-up resistors on DATA, CLK and SMBALRT pins				50K		Ω
Measurement System Characteristics						
Read delay time		t_{DLY}	153	192	231	μ s
Output current measurement range		I_{RNG}	0		100	A
Output current measurement resolution		I_{RES}		197		mA
Output current measurement gain accuracy	0°C to 85°C	I_{ACC}			± 5	% of $I_{O,max}$
	-40°C to +85°C		-3		+7	A
Output current measurement offset		I_{OFST}		0.2		A
V_{OUT} measurement range		V_{OUT}	0.5		2.0	V
V_{OUT} measurement resolution		$V_{OUT(res)}$		0.7		mV
V_{OUT} measurement accuracy		$V_{OUT(gain)}$		± 1		%
V_{OUT} measurement offset		$V_{OUT(ofst)}$	-5		5	mV
V_{IN} measurement range		$V_{IN(rng)}$	0		14	V
V_{IN} measurement resolution		$V_{IN(res)}$		7.0		mV
V_{IN} measurement accuracy		V_{IN}		± 1		%

80A GigaDlynx™: Non-Isolated DC-DC Power Modules

4.5Vdc –14Vdc input; 0.6Vdc to 2.0Vdc output; 80A Output Current

Characteristic Curves

The following figures provide typical characteristics for the 80A Digital GigaDlynx™ at 0.6Vo and 25°C.

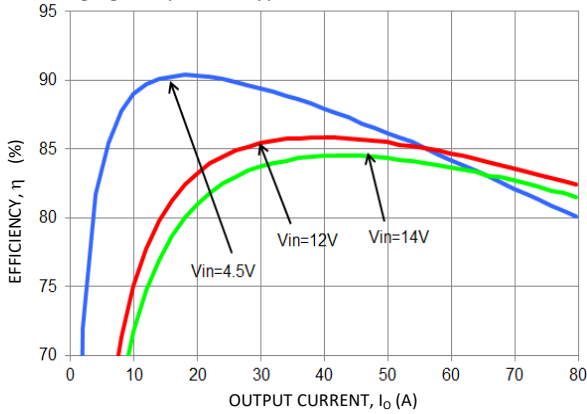

Figure 1. Converter Efficiency versus Output Current.

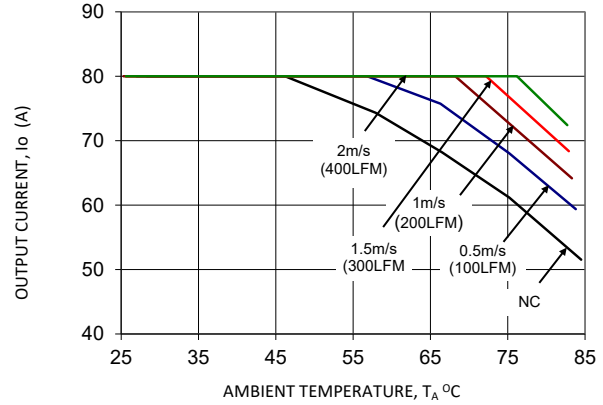

Figure 2. Derating Output Current versus Ambient Temperature and Airflow.

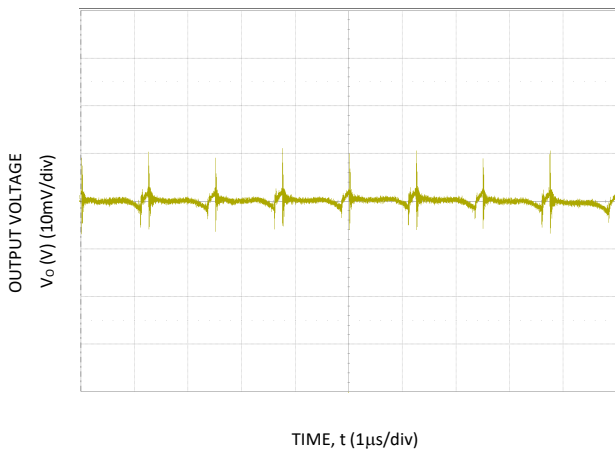

Figure 3. Typical output ripple and noise ($C_o = 6 \times 47\mu\text{F}$ ceramic, $V_{IN} = 12\text{V}$, $I_o = I_{o,max}$).

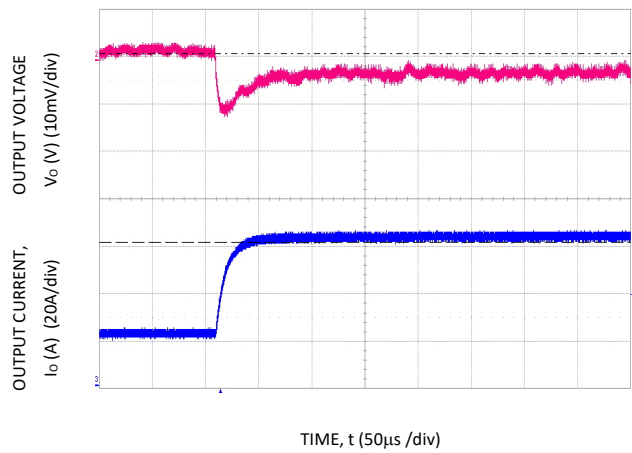

Figure 4. Transient Response to Dynamic Load Change from 25% to 75% at 12Vin, $C_o = 36 \times 47\mu\text{F} + 14 \times 1000\mu\text{F}$, $R_{TUNE} = 4.22\text{k}\Omega$

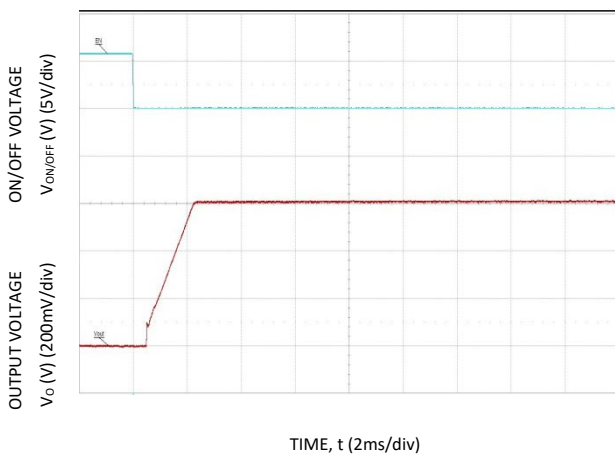

Figure 5. Typical Start-up Using On/Off Voltage ($I_o = I_{o,max}$).

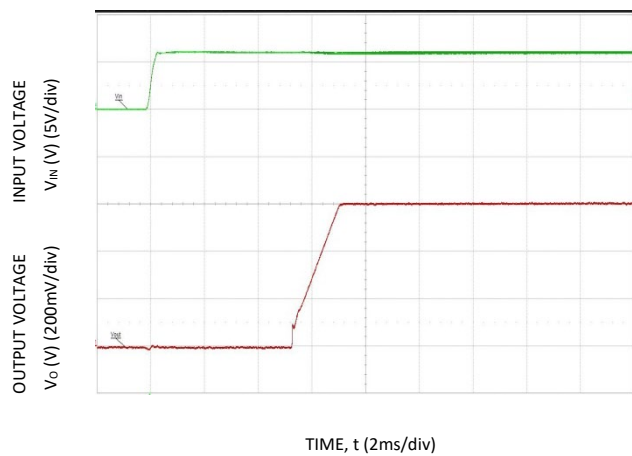

Figure 6. Typical Start-up Using Input Voltage ($V_{IN} = 12\text{V}$, $I_o = I_{o,max}$).

80A GigaDLynx™: Non-Isolated DC-DC Power Modules

4.5Vdc –14Vdc input; 0.6Vdc to 2.0Vdc output; 80A Output Current

Characteristic Curves

The following figures provide typical characteristics for the 80A GigaDLynx™ at 1.0Vo and 25°C

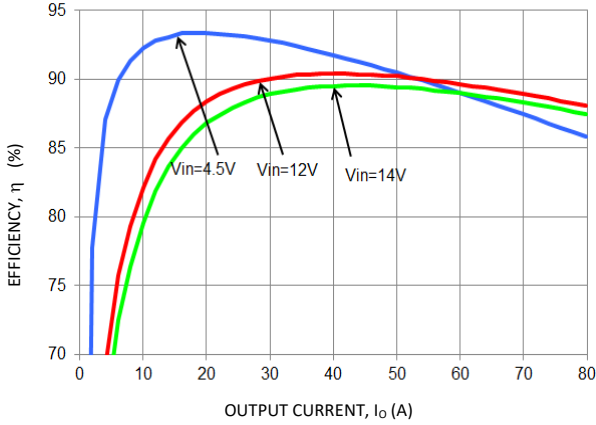

Figure 7. Converter Efficiency versus Output Current.

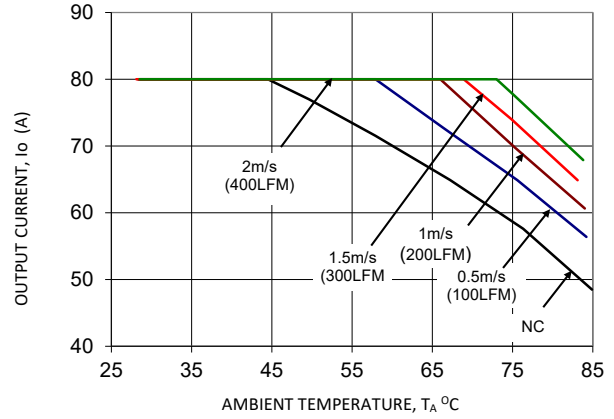

Figure 8. Derating Output Current versus Ambient Temperature and Airflow.

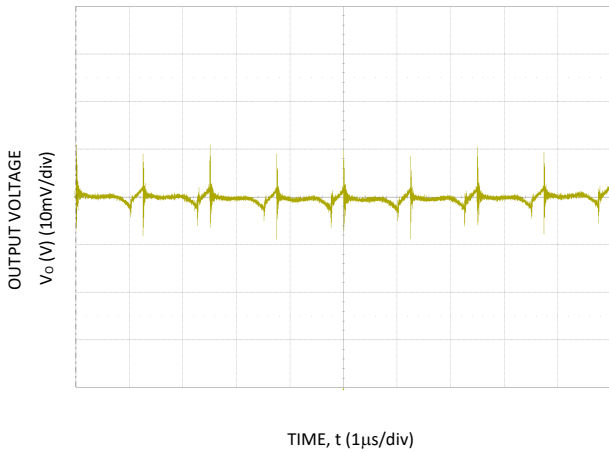

Figure 9. Typical output ripple and noise ($C_o = 6 \times 47\mu\text{F}$ Ceramic, $V_{in} = 12\text{V}$, $I_o = I_{o,max}$).

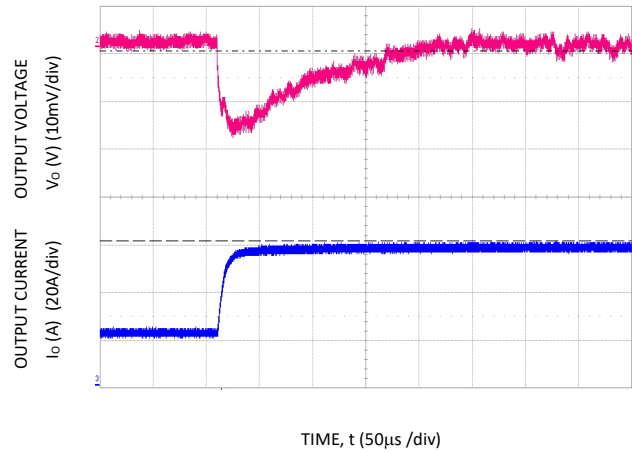

Figure 10. Transient Response to Dynamic Load Change from 25% to 75% at 12Vin, $C_o = 30 \times 47\mu\text{F} + 11 \times 1000\mu\text{F}$, $R_{TUNE} = 3.74\text{k}\Omega$

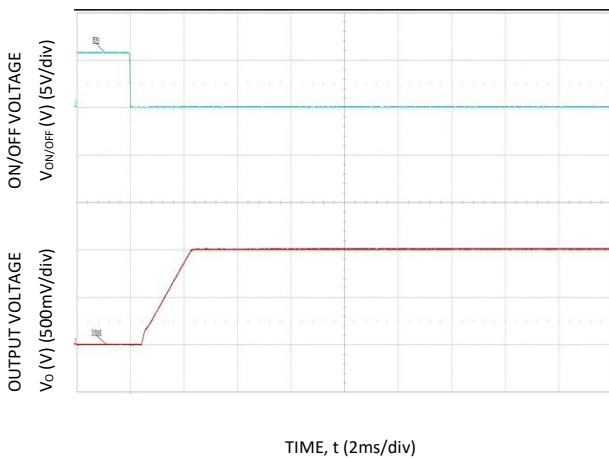

Figure 11. Typical Start-up Using On/Off Voltage ($I_o = I_{o,max}$).

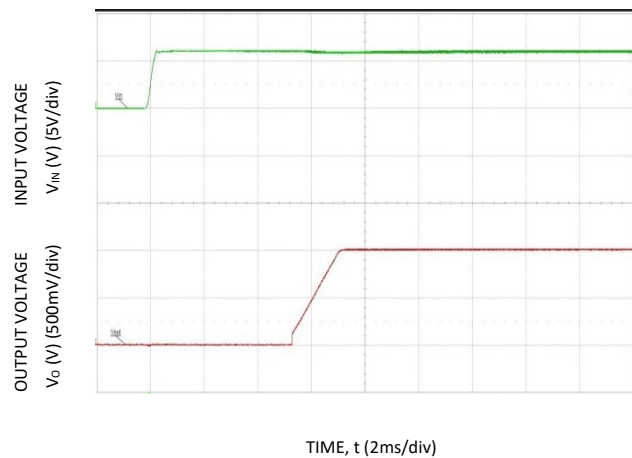

Figure 12. Typical Start-up Using Input Voltage ($V_{in} = 12\text{V}$, $I_o = I_{o,max}$).

80A GigaDlynx™: Non-Isolated DC-DC Power Modules

4.5Vdc –14Vdc input; 0.6Vdc to 2.0Vdc output; 80A Output Current

Characteristic Curves

The following figures provide typical characteristics for the 80A Digital GigaDlynx™ at 1.2Vo and 25°C.

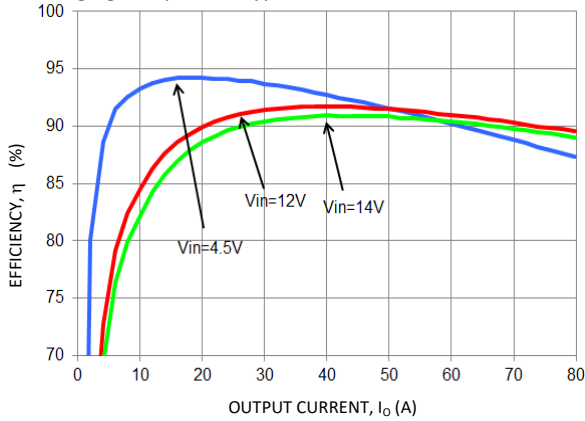

Figure 13. Converter Efficiency versus Output Current.

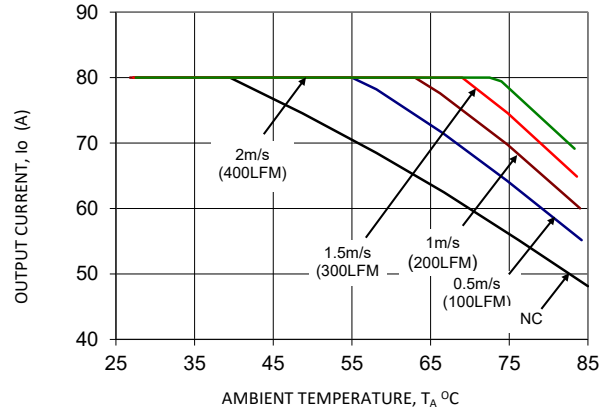

Figure 14. Derating Output Current versus Ambient Temperature and Airflow.

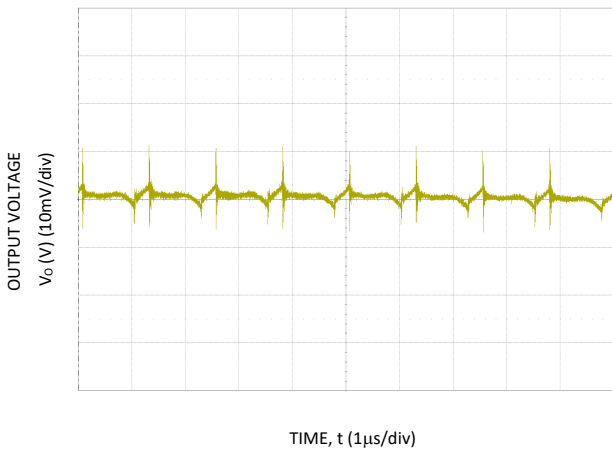

Figure 15. Typical output ripple and noise ($C_o=6x47\mu F$ ceramic, $V_{IN} = 12V$, $I_o = I_{o,max}$).

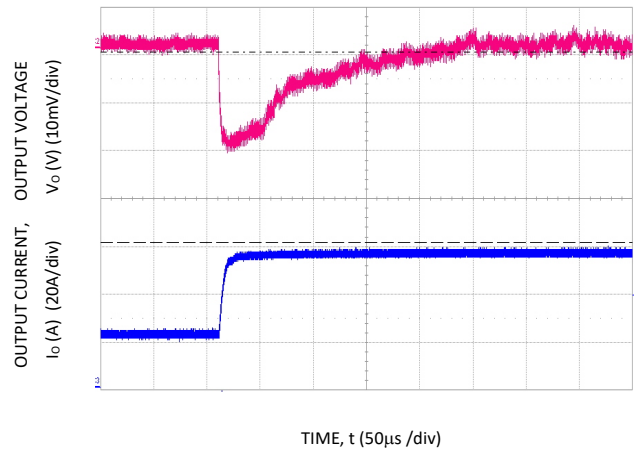

Figure 16. Transient Response to Dynamic Load Change from 25% to 75% at 12Vin, $C_o= 26x 47\mu F + 9x 1000\mu F$, $R_{TUNE} = 3.24k\Omega$

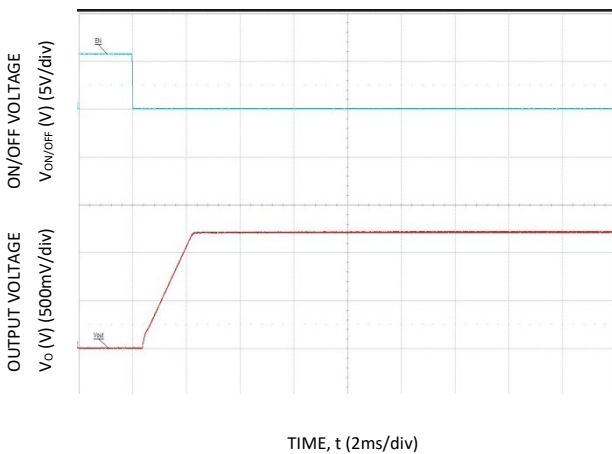

Figure 17. Typical Start-up Using On/Off Voltage ($I_o = I_{o,max}$).

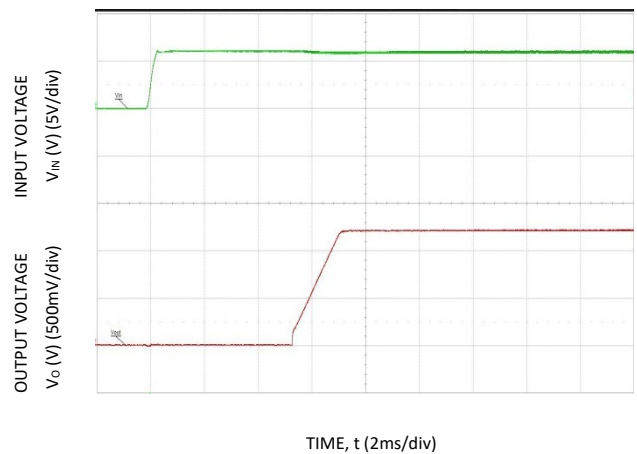

Figure 18. Typical Start-up Using Input Voltage ($V_{IN} = 12V$, $I_o = I_{o,max}$).

80A GigaDlynx™: Non-Isolated DC-DC Power Modules

4.5Vdc –14Vdc input; 0.6Vdc to 2.0Vdc output; 80A Output Current

Characteristic Curves

The following figures provide typical characteristics for the 80A Digital GigaDlynx™ at 1.5Vo and 25°C.

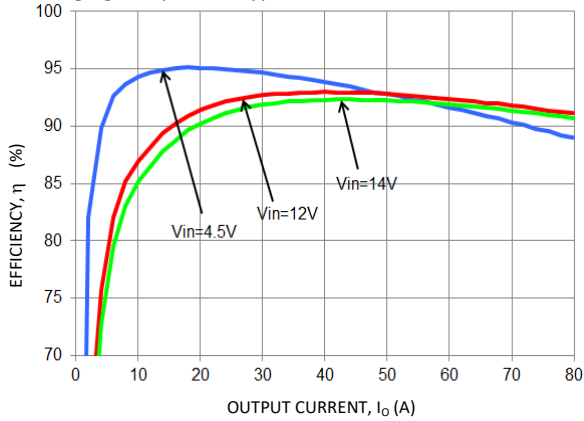

Figure 19. Converter Efficiency versus Output Current.

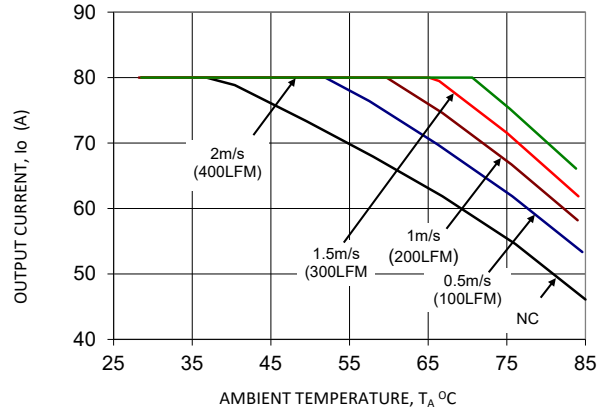

Figure 20. Derating Output Current versus Ambient Temperature and Airflow.

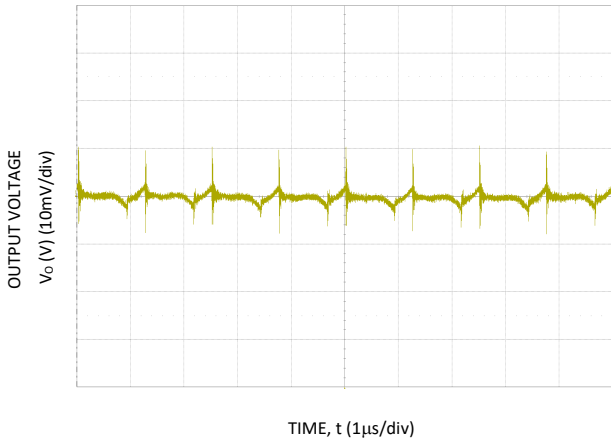

Figure 21. Typical output ripple and noise ($C_o = 6 \times 47\mu\text{F}$ ceramic, $V_{IN} = 12\text{V}$, $I_o = I_{o,max}$).

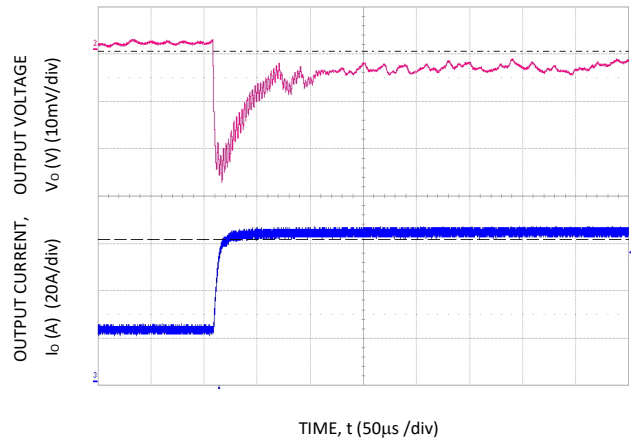

Figure 22. Transient Response to Dynamic Load Change from 25% to 75% at 12Vin, $C_o = 25 \times 47\mu\text{F} + 8 \times 1000\mu\text{F}$, $R_{TUNE} = 6.81\text{k}\Omega$

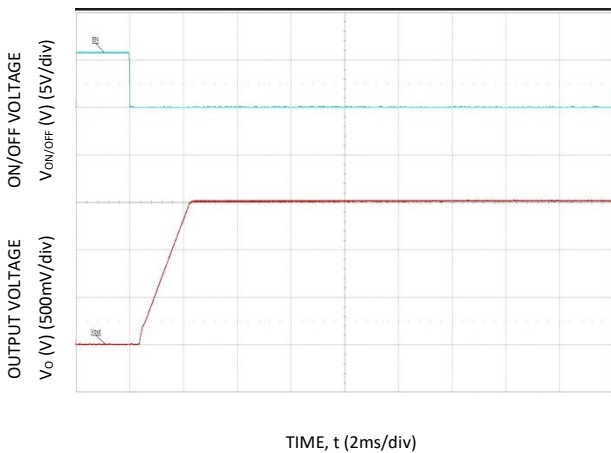

Figure 23. Typical Start-up Using On/Off Voltage ($I_o = I_{o,max}$).

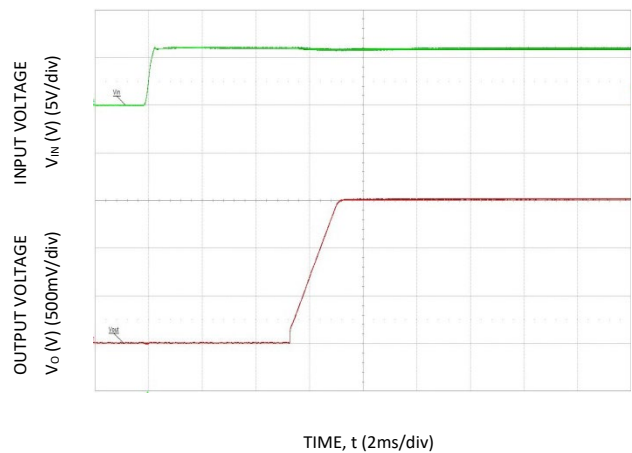

Figure 24. Typical Start-up Using Input Voltage ($V_{IN} = 12\text{V}$, $I_o = I_{o,max}$).

80A GigaDlynx™: Non-Isolated DC-DC Power Modules

4.5Vdc –14Vdc input; 0.6Vdc to 2.0Vdc output; 80A Output Current

Characteristic Curves

The following figures provide typical characteristics for the 80A Digital GigaDlynx™ at 2.0Vo and 25°C.

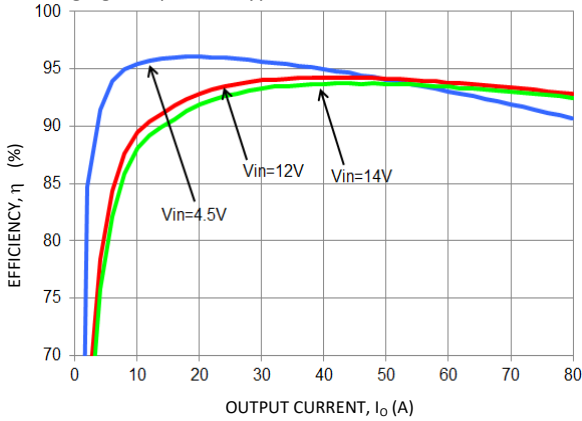

Figure 25. Converter Efficiency versus Output Current.

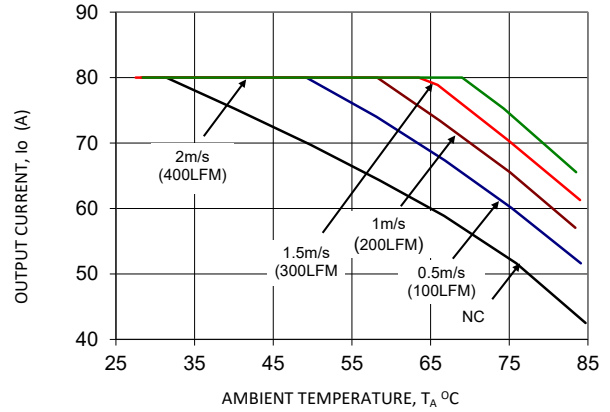

Figure 26. Derating Output Current versus Ambient Temperature and Airflow.

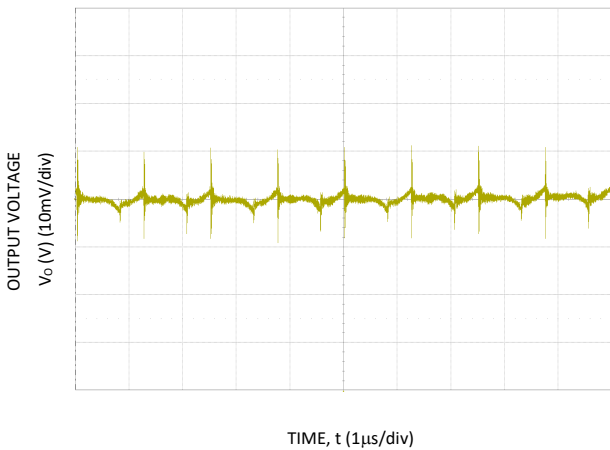

Figure 27. Typical output ripple and noise ($C_o = 6 \times 47\mu\text{F}$ ceramic, $V_{IN} = 12\text{V}$, $I_o = I_{o,max}$).

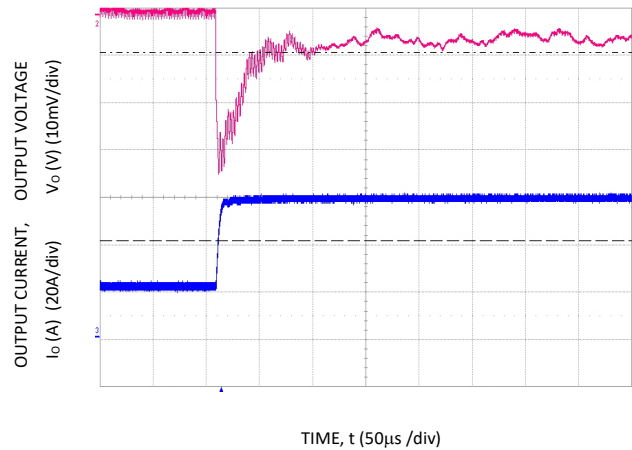

Figure 28. Transient Response to Dynamic Load Change from 25% to 75% at 12Vin, $C_o = 20 \times 47\mu\text{F} + 7 \times 1000\mu\text{F}$, $R_{TUNE} = 6.04\text{K}\Omega$

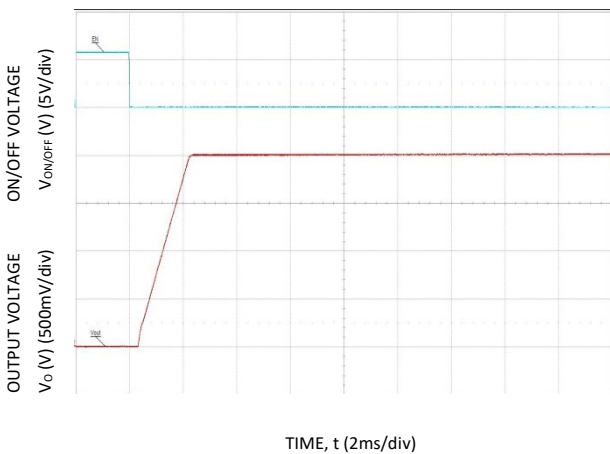

Figure 29. Typical Start-up Using On/Off Voltage ($I_o = I_{o,max}$).

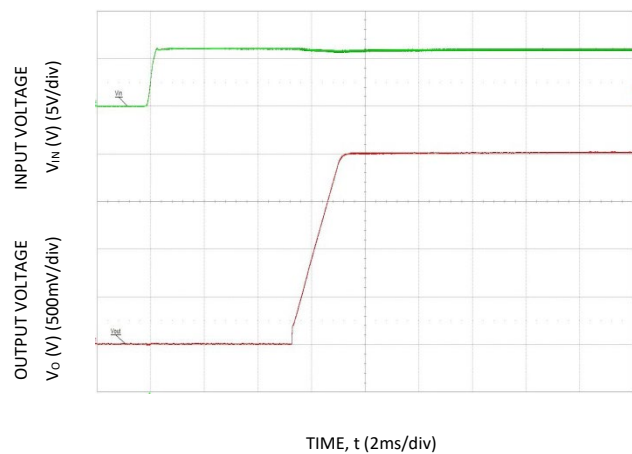

Figure 30. Typical Start-up Using Input Voltage ($V_{IN} = 12\text{V}$, $I_o = I_{o,max}$).

80A GigaDLynx™: Non-Isolated DC-DC Power Modules

4.5Vdc –14Vdc input; 0.6Vdc to 2.0Vdc output; 80A Output Current

Design Considerations

Input Filtering

The 80A GigaDLynx™ module must be powered from a low-impedance source. An inductive source can affect the stability of the module. An input capacitance must be placed directly adjacent to the input pins of the module, to minimize input ripple voltage and ensure module stability.

To minimize input voltage ripple, ceramic capacitors are recommended at the input of the module. Figure 31 shows the input ripple voltage for various output voltages at 80A of load current with 6x22 μF + 3x0.1 μF + 1x470 μF OSCON electrolytic capacitor at an input of 12V.

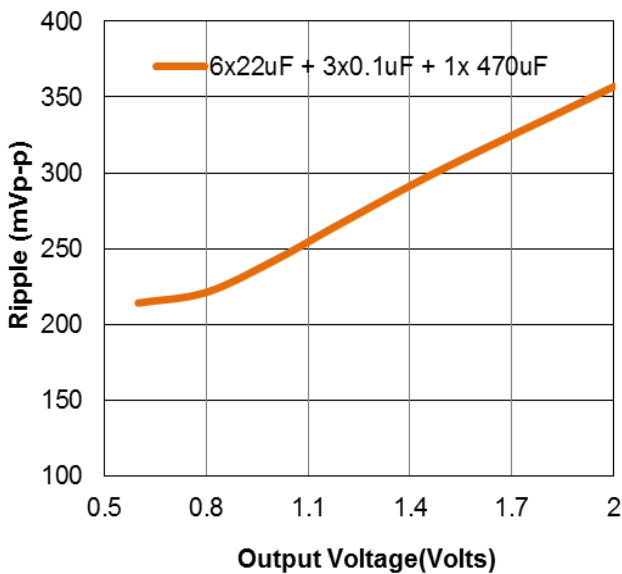

Figure 31. Input ripple voltage for various output voltages with (3 x 0.1μF + 6 x 22 μF) ceramic + 1 x 470μF OSCON electrolytic capacitor at the input (80A load). Input voltage is 12V.

Output Filtering

These modules are designed for low output ripple voltage and will meet the maximum output ripple specification with minimum of 6x47μF ceramic capacitors at the output of the module. However, additional output filtering may be required by the system designer for a number of reasons. First, there may be a need to further reduce the output ripple and noise of the module. Second, the dynamic response characteristics may need to be customized to a particular load step change.

To reduce the output ripple and improve the dynamic response to a step load change, additional capacitance at the output can be used. Low ESR polymer and ceramic capacitors are recommended to improve the dynamic response of the module.

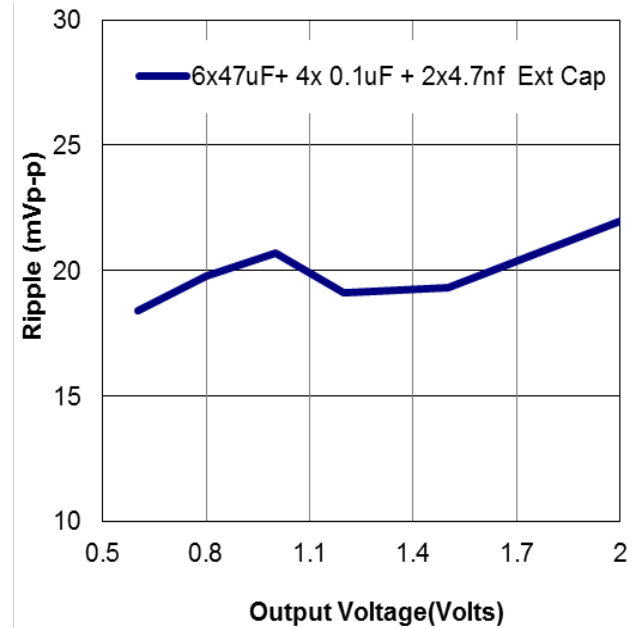

Figure 32. Output ripple voltage for various output voltages with external 6 x 47μF + 4 x 0.1 μF + 2 x 4.7nF ceramic capacitors at the output (80A load). Input voltage is 12V.

Safety Considerations

For safety agency approval the power module must be installed in compliance with the spacing and separation requirements of the end-use safety agency standards, i.e., UL ANSI/UL* 62368-1 and CAN/CSA+ C22.2 No. 62368-1 Recognized, DIN VDE 0868-1/A11:2017 (EN62368-1:2014/A11:2017).

For the converter output to be considered meeting the Requirements of safety extra-low voltage (SELV) or ES1, the input must meet SELV/ES1 requirements. The power module has extra-low voltage (ELV) outputs when all inputs are ELV.

For input voltages greater than 7V, single external 40A 465 Series Fast Acting Littelfuse fuse on the ungrounded input pin is recommended. For input voltages less than 7V, two 30A 678 Series Bel Fast Acting Fuses in parallel is recommended.

80A GigaDLynx™: Non-Isolated DC-DC Power Modules

4.5Vdc –14Vdc input; 0.6Vdc to 2.0Vdc output; 80A Output Current

Analog Feature Descriptions

Remote On/Off

The GigaDLynx 80A module can be turned ON and OFF either by using the ON/OFF pin (Analog interface) or through the PMBus interface (Digital). The module can be configured in a number of ways through the PMBus interface to react to the ON/OFF input:

- Module ON/OFF is controlled only through the analog interface (digital interface ON/OFF commands are ignored)
- Module ON/OFF is controlled only through the PMBus interface (analog interface is ignored)
- Module ON/OFF is controlled by either the analog or digital interface

The default state of the module (as shipped from the factory) is to be controlled by the analog interface only. If the digital interface is to be enabled, or the module is to be controlled only through the digital interface, this change must be made through the PMBus. These changes can be made and written to non-volatile memory on the module so that it is remembered for subsequent use.

Analog On/Off

The 80A GigaDLynx™ power modules feature an On/Off pin for remote On/Off operation. With the Negative Logic On/Off option, (see Ordering Information), the module turns OFF during logic High and ON during logic Low. The On/Off signal should be always referenced to ground. Leaving the On/Off pin disconnected will turn the module ON when input voltage is present. With the positive logic on/off option, the module turns ON during logic high and OFF during logic low.

Digital On/Off

Please see the Digital Feature Descriptions section.

Monotonic Start-up and Shutdown

The module has monotonic start-up and shutdown behavior on the output voltage for any rated input voltage, output voltage and current, and operating temperature.

Startup considerations at Low Temperature.

GDT080 is able to handle specified full-load start-up for ambient temperatures above or equal to -10°C. Below -10°C ambient temperature, the load has to be limited to 75% of specified full-load.

Startup into Pre-biased Output

The module can start into a pre-biased output as long as the pre-bias voltage is 0.5V less than the set output voltage.

Analog Output Voltage Programming

The output voltage of the module is programmable to any voltage from 0.6 to 2.0 Vdc by connecting a resistor between the Trim and VS- pins of the module as shown in Fig 33.

Without an external resistor between the Trim and VS- pins, the output of the module will be 0.6 Vdc. The value of the trim resistor, R_{TRIM} for a desired output voltage, should be selected as per the following equation:

$$R_{TRIM} = \frac{V_{ref}}{(V_{out} - V_{ref})} \times 2k\Omega$$

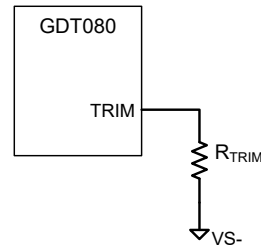

Figure 33. Circuit configuration for programming output voltage using an external resistor.

R_{TRIM} is the external resistor in $k\Omega$

V_{out} is the desired output voltage.

$V_{ref} = 0.6V$

Table 1 provides R_{trim} values required for some common output voltages.

Table 1

$V_{O, set}$ (V)	R_{TRIM} (K Ω)
0.6	Open
0.8	6.0
1.0	3.0
1.2	2.0
1.5	1.33
2.0	0.866

Digital Output Voltage Adjustment

Please see the Digital Feature Descriptions section.

Remote Sense

The power module has a differential Remote Sense feature to minimize the effects of distribution losses by regulating the voltage between the sense pins (VS+ and VS-). The voltage drop between the sense pins and the VOUT and GND pins of the module should not exceed 0.4V.

Output Voltage Sequencing

The power module includes a sequencing feature, EZ-SEQUENCE that enables users to implement various types of output voltage sequencing in their applications. This is accomplished via an additional sequencing pin. This pin is disabled as a factory default setting, **if using this feature it should be enabled using the MFR_FEATURES_CONTROL (E7h) command.** When not using the sequencing feature, leave it unconnected and leave the default setting unchanged.

The voltage applied to the SEQ pin should be scaled down by the same ratio as used to scale the output voltage down to

80A GigaDLynx™: Non-Isolated DC-DC Power Modules

4.5Vdc –14Vdc input; 0.6Vdc to 2.0Vdc output; 80A Output Current

the reference voltage of the module. This is accomplished by an external resistive divider connected across the sequencing voltage before it is fed to the SEQ pin as shown in Fig 34. In addition, a small capacitor (suggested value 100pF) should be connected across the lower resistor R1.

For all DLynx modules, the minimum recommended delay between the ON/OFF signal and the sequencing signal is 10ms to ensure that the module output is ramped up according to the sequencing signal. This ensures that the module soft-start routine is completed before the sequencing signal is allowed to ramp up.

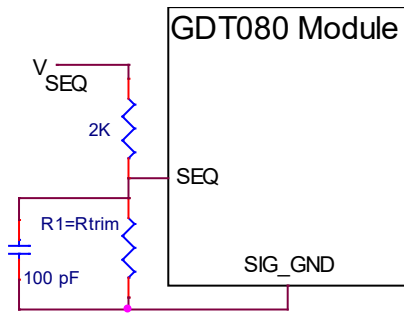

Figure 34. Circuit showing connection of the sequencing signal to the SEQ pin.

When the scaled down sequencing voltage is applied to the SEQ pin, the output voltage tracks this voltage until the output reaches the set-point voltage. The final value of the sequencing voltage must be set higher than the set-point voltage of the module. The output voltage follows the sequencing voltage on a one-to-one basis. By connecting multiple modules together, multiple modules can track their output voltages to the voltage applied on the SEQ pin.

The module’s output can track the SEQ pin signal with slopes of up to 0.5V/msec during power-up or power-down.

To initiate simultaneous shutdown of the modules, the SEQ pin voltage is lowered in a controlled manner. The output voltage of the modules tracks the voltages below their set-point voltages on a one-to-one basis. A valid input voltage must be maintained until the tracking and output voltages reach ground potential.

Digital Compensator

The GDT080 module uses digital control to regulate the output voltage. As with all POL modules, external capacitors are usually added to the output of the module for two reasons: to reduce output ripple and noise (see Figure 32 for example data) and to reduce output voltage deviations from the steady-state value in the presence of dynamic load current changes. Adding external capacitance however affects the voltage control loop of the module, typically causing the loop to slow down with sluggish response. Larger values of external capacitance could also cause the module to become unstable. In the GDT080, using a feature called the Digital Tunable Loop™, the digital compensation can be adjusted externally to optimize transient response and also ensure stability for a wide range of external capacitance, as well as

with different types of output capacitance. This is done by allowing the user to select among several pre-tuned compensation choices to select the one most suited to the transient response needs of the load. Figure 35 shows how the resistor RTune is connected between the RTUNE and GND pins to select the appropriate pre-tuned compensation.

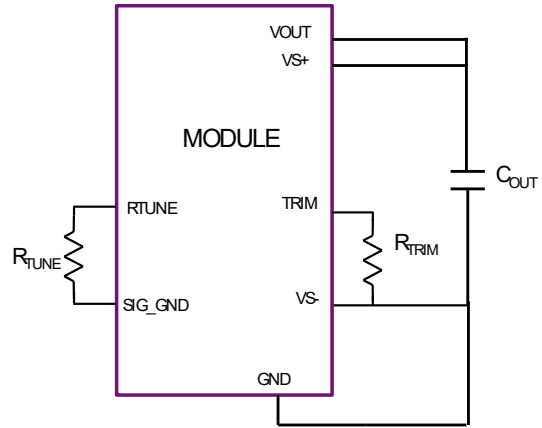

Figure 35. Circuit diagram showing connection of RTUNE to tune the control loop of the module.

Recommended values of RTUNE for different output capacitor combinations are given in Table 2. The GDT080 pre-tuned compensation can be divided into four different banks (COMP0, COMP1, COMP2 and COMP3) that are available to the user to compensate the control loop for various values and combinations of output capacitance and to obtain reliable and stable performance under different conditions. Each bank consists of seven different sets of compensation coefficients pre-calculated for different values of output capacitance. The four banks are set up as follows:

- COMP0: Recommended for the case where all of the output capacitance is composed of only ceramic capacitors. The range of external output capacitance is from the required minimum value of 470µF to a maximum of 7500µF.
- COMP1: For the most commonly used mix of ceramic and polymer type capacitors that have higher output capacitance in a smaller size and for output voltages between 0.6V to 1.2V. The range of output capacitance is from 470µF to a maximum of 15,692µF. This is the combination of output capacitance and compensation that can achieve the best transient response at lowest cost and smallest size. For example, with the maximum output capacitance of 15,692µF, and selecting RTUNE = 4.22kΩ, transient deviation can be as low as 15mV, for a 50% load step (0 to 40A).
- COMP2: Same range and types of capacitance as COMP1, but for an output voltage range from 1.2V to 2V.
- COMP3: Suitable also for a mix of ceramic and higher ESR polymers or electrolytic capacitors such as OSCON.

80A GigaDLynx™: Non-Isolated DC-DC Power Modules

4.5Vdc –14Vdc input; 0.6Vdc to 2.0Vdc output; 80A Output Current

Selecting R_{TUNE} according to Table 2 will ensure stable operation of the module with sufficient stability margin as well as yield optimal transient response.

Table 2. Recommended R_{TUNE} Compensation

Output Capacitance Type	Number of Output Capacitors**	Total Output Capacitance (μ F)**	Compensation Bank	R_{TUNE} resistor (k Ω)
Ceramic	18 x 47 μ	846	Comp 0	0
Ceramic	18 x 47 μ + 9 x 100 μ	1746	Comp 0	0.392
Ceramic	18 x 47 μ + 16 x 100 μ	2446	Comp 0	0.576
Ceramic	18 x 47 μ + 22 x 100 μ	3046	Comp 0	0.787
Ceramic	18 x 47 μ + 40 x 100 μ	4846	Comp 0	1
Ceramic	18 x 47 μ + 52 x 100 μ	6046	Comp 0	1.24
Ceramic	18 x 47 μ + 83 x 100 μ	9146	Comp 0	1.5
Ceramic + Polymer	16 x 47 μ + 2 x 1000 μ	2752	Comp 1	1.78
Ceramic + Polymer	16 x 47 μ + 3 x 1000 μ	3752	Comp 1	2.1
Ceramic + Polymer	16 x 47 μ + 5 x 1000 μ	5752	Comp 1	2.43
Ceramic + Polymer	16 x 47 μ + 7 x 1000 μ	7752	Comp 1	2.8
Ceramic + Polymer	16 x 47 μ + 9 x 1000 μ	9752	Comp 1	3.24
Ceramic + Polymer	18 x 47 μ + 12 x 1000 μ	12,486	Comp 1	3.74
Ceramic + Polymer	18 x 47 μ + 14 x 1000 μ	14,846	Comp 1	4.22
Ceramic + Polymer	16 x 47 μ + 2 x 1000 μ	2752	Comp 2	4.75
Ceramic + Polymer	16 x 47 μ + 3 x 1000 μ	3752	Comp 2	5.36
Ceramic + Polymer	16 x 47 μ + 5 x 1000 μ	5752	Comp 2	6.04
Ceramic + Polymer	16 x 47 μ + 7 x 1000 μ	7752	Comp 2	6.81
Ceramic + Polymer	16 x 47 μ + 9 x 1000 μ	9752	Comp 2	7.68
Ceramic + Polymer	18 x 47 μ + 12 x 1000 μ	12,846	Comp 2	8.66
Ceramic + Polymer	18 x 47 μ + 14 x 1000 μ	14,846	Comp 2	9.53
Ceramic + Electrolytic	16 x 47 μ + 4 x 470 μ	2632	Comp 3	10.5
Ceramic + Electrolytic	16 x 47 μ + 7 x 470 μ	4042	Comp 3	11.8
Ceramic + Electrolytic	16 x 47 μ + 9 x 470 μ	4982	Comp 3	13
Ceramic + Electrolytic	18 x 47 μ + 14 x 470 μ	7246	Comp 3	14.3
Ceramic + Electrolytic	18 x 47 μ + 20 x 470 μ	10,246	Comp 3	15.8
Ceramic + Electrolytic	18 x 47 μ + 24 x 470 μ	12,126	Comp 3	17.4
Ceramic + Electrolytic	18 x 47 μ + 30 x 470 μ	14,946	Comp 3	19.1

** Total output capacitance includes the capacitance inside the module of value 8 x 47 μ F (3m Ω ESR).

Note: The capacitors used in the digital compensation Loop tables are 47 μ F/3 m Ω ESR ceramic, 100 μ F/3.2m Ω ceramic, 1000 μ F/6m Ω ESR polymer capacitor and 470 μ F/9m Ω ESR Polymer capacitor.

In applications with tight output voltage limits in the presence of dynamic current loading, additional output capacitance will be required. Table 3 lists recommended values of R_{TUNE} in order to meet 2% output voltage deviation limits for some common output voltages in the presence of a 40A to 80A step change (50% of full load), with an input voltage of 12V.

Please contact your GE technical representative to obtain more details of this feature as well as for guidelines on how to select the right value of external R_{TUNE} to tune the module for best transient performance and stable operation for other output capacitance values. Simulation models are also available via the GE Power Module Wizard to predict stability characteristics and transient response.

80A GigaDLynx™: Non-Isolated DC-DC Power Modules

4.5Vdc –14Vdc input; 0.6Vdc to 2.0Vdc output; 80A Output Current

Table 3. Recommended values of R_{TUNE} to obtain transient deviation of 2% of V_{out} for a 40A step load with $V_{in}=12V$.

V_o	2V	1.2V	0.6V
C_o	14x47uF + 5x1000uF polymer	28x47uF + 9x1000uF polymer	36x47uF + 14x1000uF polymer
R_{TUNE} (k Ω)	9.53	3.24	4.22
ΔV (mV)	32	19.8	12

Power Module Wizard

GE offers a free web based easy to use tool that helps users simulate the Tunable Loop performance of the GDT080. Go to <http://ge.transim.com/pmd/Home> and sign up for a free account and use the module selector tool. The tool also offers downloadable Simplis/Simatrix models that can be used to assess transient performance, module stability, etc.

80A GigaDLynx™: Non-Isolated DC-DC Power Modules

4.5Vdc –14Vdc input; 0.6Vdc to 2.0Vdc output; 80A Output Current

Digital Output Voltage Margining

Please see the Digital Feature Descriptions section.

Overcurrent Protection (OCP)

To provide protection in a fault (output overload) condition, the unit has internal current-limiting circuitry on the output and can endure current limiting continuously. The module overcurrent response is non-latching shutdown with automatic recovery. The Overcurrent Protection response time is programmable via the PMBus through manufacturer-specific commands. The unit operates normally once the output current is brought back into its specified range.

Load Transient Considerations

The GDT080 module can achieve 100% load transient above -10°C ambient temperature. Below -10°C ambient temperature, the load transient is limited to a maximum of 75% of specified full load current.

Digital Sequencing

The module supports digital sequencing operation. Both ratiometric and simultaneous sequencing are supported.

Overtemperature Protection

To provide protection in a fault condition, the unit has a thermal shutdown circuit. The unit will shut down if the overtemperature threshold of 125°C (typ) is exceeded at the thermal reference point T_{ref} . Once the unit goes into thermal shutdown it will wait to cool before attempting to restart. The overtemperature threshold is dependent on input voltage, with the 125°C value applicable for input voltages > 6.5V and is changed to 105°C for input voltages ≤ 6.5V.

Digital Temperature Status via PMBus

Please see the Digital Feature Descriptions section.

Digitally Adjustable Output Over and Under Voltage Protection

Please see the Digital Feature Descriptions section.

Input Undervoltage Lockout

At input voltages below the input undervoltage lockout limit, module operation is disabled. The module will begin to operate at an input voltage above the undervoltage lockout turn-on threshold.

Digitally Adjustable Input Undervoltage Lockout

Please see the Digital Feature Descriptions section.

Digitally Adjustable Power Good Thresholds

Please see the Digital Feature Descriptions section.

Power Good

The module provides a Power Good (PGOOD) signal that goes high to indicate output voltage being within a specified range. The signal is implemented as push-pull circuit with an internal pull-up resistor of 20K to 3.3V. The PGOOD signal is de-

asserted to a low state if any condition such as overtemperature, overcurrent or loss of regulation occurs that would result in the output voltage going outside the specified thresholds. The default PGOOD thresholds are ± 15%.

The PGOOD terminal should be connected through a pullup resistor (suggested value 100KΩ) to a source of 5VDC or lower.

Synchronization

The module switching frequency can be synchronized to an external signal within the specified range. Synchronization is done by applying the external signal to the SYNC pin of the module as shown in Fig. 36, with the converter being synchronized by the rising edge of the external signal. The Electrical Specifications table specifies the requirements of the external SYNC signal. **If using this feature it should be enabled using the MFR_FEATURES_CONTROL (E7h) command.** If the SYNC pin is not used, leave the default setting unchanged and the module runs at the default switching frequency.

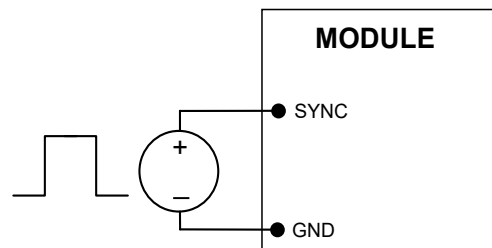

Figure 36. External source connections to synchronize switching frequency of the module.

Measuring Output Current, Output Voltage and Input Voltage

Please see the Digital Feature Descriptions section.

80A GigaDlynx™: Non-Isolated DC-DC Power Modules

4.5Vdc –14Vdc input; 0.6Vdc to 2.0Vdc output; 80A Output Current

Digital Feature Descriptions

PMBus Interface Capability

The 80A Digital GigaDlynx™ power modules have a PMBus interface that supports both communication and control. The modules supports a subset of version 1.1 of the PMBus specification (see Table 6 for a list of the specific commands supported). Most module parameters can be programmed using PMBus and stored as defaults for later use.

All communication over the module PMBus interface will work with or without Packet Error Checking (PEC) . The module generates the correct PEC byte for all transactions, and checks the PEC byte if sent by the master.

The module also supports the SMBALERT# response protocol whereby the module alerts the bus master if it wants to talk. For more information on the SMBus alert response protocol, see the System Management Bus (SMBus) specification.

The module has non-volatile memory that is used to store configuration settings. Not all settings programmed into the device are automatically saved into this non-volatile memory, only those specifically identified as capable of being stored are saved (see Table 6 for which command parameters can be saved in non-volatile storage).

PMBus Data Format

For commands that set thresholds, voltages or report such quantities, the module supports the “Linear” data format among the three data formats supported by PMBus. The Linear Data Format is a two byte value with an 11-bit, two’s complement mantissa and a 5-bit, two’s complement exponent. The format of the two data bytes is shown below:

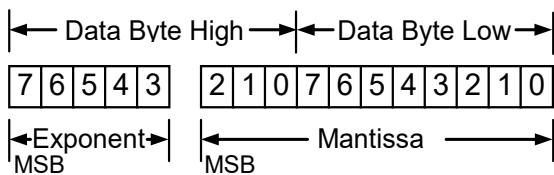

The value is of the number is then given by

$$\text{Value} = \text{Mantissa} \times 2^{\text{Exponent}}$$

PMBus Addressing

The power module is addressed through the PMBus using a device address. The module supports 128 possible addresses (0 to 127 in decimal) which can be set using resistors connected from the ADDR0 and ADDR1 pins to SIG_GND. Note that some of these addresses (0, 1, 2, 3, 4, 5, 6, 7, 8, 9, 10, 11, 12, 40, 44, 45, 55 in decimal) are reserved according to the SMBus specification and may not be useable. The address is set in the form of two octal (0 to 7) digits, with each pin setting one digit. The ADDR1 pin sets the high order digit and ADDR0 sets the low order digit. The resistor values suggested for each digit are shown in Table 4 (E96 series resistors are recommended). Note that if either address resistor value is

outside the range specified in Table 4, the module will respond to address 127.

Table 4

PMBus Address Table								
ADDR0 Resistor Values	ADDR1 Resistor Values							
	0	680	1.2K	1.8K	2.7K	3.9K	4.7K	5.6K
0	64	16	32	48	64	80	96	112
680	1	17	33	49	65	81	97	113
1.2K	2	18	34	50	66	82	98	114
1.8K	3	19	35	51	67	83	99	115
2.7K	4	20	36	52	68	84	100	116
3.9K	5	21	37	53	69	85	101	117
4.7K	6	22	38	54	70	86	102	118
5.6K	7	23	39	55	71	87	103	119
6.8K	8	24	40	56	72	88	104	120
8.2K	9	25	41	57	73	89	105	121
10K	10	26	42	58	74	90	106	122
12K	11	27	43	59	75	91	107	123
15K	12	28	44	60	76	92	108	124
18K	13	29	45	61	77	93	109	125
22K	14	30	46	62	78	94	110	126
27K	15	31	47	63	79	95	111	127

Both 100kHz and 400kHz bus speeds are supported by the module. Connection for the PMBus interface should follow the High Power DC specifications given in section 3.1.3 in the SMBus specification V2.0 for the 400kHz bus speed or the Low Power DC specifications in section 3.1.2.

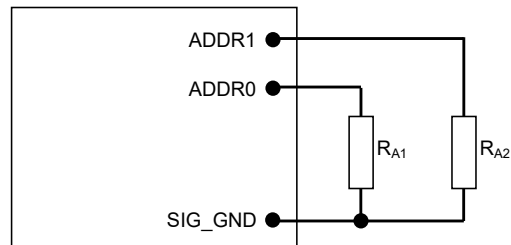

Figure 37. Circuit showing connection of resistors used to set the PMBus address of the module.

PMBus Enabled On/Off

The output of the module can be turned on and off via the PMBus interface. The OPERATION command is used to actually turn the module on and off via the PMBus, while the ON_OFF_CONFIG command configures the combination of analog ON/OFF pin input and PMBus commands needed to turn the module on and off. Bit [7] in the OPERATION command data byte enables the module, with the following functions:

80A GigaDlynx™: Non-Isolated DC-DC Power Modules

4.5Vdc –14Vdc input; 0.6Vdc to 2.0Vdc output; 80A Output Current

- 0 : Output is disabled
- 1 : Output is enabled

This module uses the lower five bits of the ON_OFF_CONFIG data byte to set various ON/OFF options as follows:

Bit Position	4	3	2	1	0
Access	r/w	r/w	r/w	r/w	r
Function	PU	CMD	CPR	POL	CPA
Default Value	1	0	1	1	0

PU: Sets the default to either operate any time input power is present or for the ON/OFF to be controlled by the analog ON/OFF input and the PMBus OPERATION command. This bit is used together with the CP, CMD and ON bits to determine startup.

Bit Value	Action
0	Module powers up any time power is present regardless of state of the analog ON/OFF pin
1	Module does not power up until commanded by the analog ON/OFF pin and the OPERATION command as programmed in bits [2:0] of the ON_OFF_CONFIG register.

CMD: The CMD bit controls how the device responds to the OPERATION command.

Bit Value	Action
0	Module ignores the ON bit in the OPERATION command
1	Module responds to the ON bit in the OPERATION command

CPR: Sets the response of the analog ON/OFF pin. This bit is used together with the CMD, PU and ON bits to determine startup.

Bit Value	Action
0	Module ignores the analog ON/OFF pin, i.e. ON/OFF is only controlled through the PMBUS via the OPERATION command
1	Module requires the analog ON/OFF pin to be asserted to start the unit

PMBus Adjustable Soft Start Rise Time

The soft start rise time of module output is adjustable in the module via PMBus. The TON_RISE command can set the rise time in ms, and allows choosing soft start times between 200µs and 14ms.

Output Voltage Adjustment Using the PMBus

The VOUT_SCALE_MONITOR parameter is important for a number of PMBus commands related to output voltage trimming, margining, over/under voltage protection and the PGOOD thresholds. The output voltage of the module is determined by the value of the R_{Trim} resistor connected between TRIM pin and analog ground VS-, as specified earlier in the data sheet. The information on the output voltage

divider ratio is conveyed to the module through the VOUT_SCALE_MONITOR parameter. The read-out of output voltage also depends on VOUT_SCALE_MONITOR. If the correct VOUT_SCALE_MONITOR is not used, the output voltage read-out will be wrong. The VOUT_SCALE_MONITOR parameter is defined by the ratio of internal reference of the controller to the nominal output voltage selected by R_{Trim} resistor.

$$VOUT_SCALE_MONITOR = \frac{0.6V}{\text{Nominal Output Voltage}}$$

For example, for a nominal output voltage of 1.2V, the VOUT_SCALE_MONITOR is equal to 0.5. Table 5 below defines values of VOUT_SCALE_MONITOR to the various nominal output voltages.

Table 5

V _{O, set} (V)	VOUT_SCALE_MONITOR
0.6	1
0.8	0.75
1.0	0.6
1.2	0.5
1.5	0.4
2.0	0.3

When PMBus commands are used to trim or margin the output voltage, the value of V_{REF} is what is changed inside the module, which in turn changes the regulated output voltage of the module.

The nominal output voltage of the module is adjustable with a minimum step size of 1.406mV over a ± 25% range from nominal using the VOUT_TRIM command over the PMBus.

Output Voltage Margining Using the PMBus

Output voltage of the module can also be margined via PMBus commands. The command VOUT_MARGIN_HIGH sets the margin high voltage, while the command VOUT_MARGIN_LOW sets the margin low voltage. Both the VOUT_MARGIN_HIGH and VOUT_MARGIN_LOW commands use the "Linear" mode. Two bytes are used for data. The actual margin output voltage is determined by the resistor on the TRIM, which as explained earlier is taken into consideration by VOUT_SCALE_MONITOR command. The module then sets the output voltage to the margin high or low voltage levels using the OPERATION command. Bits [7:4] are used to enable margining as follows:

- 1001: Vout set to VOUT_MARGIN_LOW (Ignore Fault)
- 1010: Vout set to VOUT_MARGIN_HIGH (Ignore Fault)

Temperature Status via PMBus

The module provides information related to temperature of the module through standardized PMBus commands. Commands READ_TEMPERATURE1, READ_TEMPERATURE_2 are mapped to module temperature and internal temperature of the PWM controller, respectively. The temperature readings are returned in °C and are two bytes.

80A GigaDLynx™: Non-Isolated DC-DC Power Modules

4.5Vdc –14Vdc input; 0.6Vdc to 2.0Vdc output; 80A Output Current

PMBus Adjustable Output Over and Under Voltage Protection

The module has output over and under voltage protection capability. The PMBus command VOUT_OV_FAULT_LIMIT is used to set the output over voltage threshold. The default value is configured to be 115% of the commanded output. The command VOUT_UV_FAULT_LIMIT sets the threshold that detects an output under voltage fault. The default values are 85% of the commanded output voltage. Both commands use two data bytes formatted in the Linear format.

PMBus Adjustable Input Undervoltage Lockout

The module allows adjustment of the input under voltage lockout and hysteresis. The command VIN_ON allows setting the input voltage turn on threshold, while the VIN_OFF command sets the input voltage turn off threshold. For both the VIN_ON and VIN_OFF commands, possible values are 4.5V to 14V. Both VIN_ON and VIN_OFF commands use the “Linear” format with two data bytes.

Measurement of Output Current, Output Voltage, Input Voltage and output power

The module can measure key module parameters such as output current, output voltage and input voltage and provide this information through the PMBus interface.

Measuring Output Current Using the PMBus

The module measures output current by using the inductor winding resistance as a current sense element. The inductor winding resistance is then multiplied by the current gain factor that will be used to scale the measured voltage into a current reading. This gain factor is the argument of the IOUT_CAL_GAIN command, and consists of two bytes in the Linear data format. During manufacture, each module is calibrated by measuring and storing the current gain factor into non-volatile storage.

The current measurement accuracy is also improved by each module being calibrated during manufacture with the offset in the current reading. The IOUT_CAL_OFFSET command is used to store and read the current offset. The READ_IOUT command provides tmodule average output current information. This command only supports positive output current, i.e. current sourced from the module. If the converter is sinking current a reading of 0 is provided. The READ_IOUT command returns two bytes of data in the Linear data format.

Measuring Output Voltage Using the PMBus

The module provides output voltage information using the READ_VOUT command. The command returns two bytes of data in Linear format

Measuring Input Voltage Using the PMBus

The module provides input voltage information using the READ_VIN command. The command returns two bytes of data in the Linear format.

Reading the Status of the Module using the PMBus

The module supports a number of status information commands implemented in PMBus. A 1 in the bit position indicates the fault that is flagged.

STATUS_BYTE : Returns one byte of information with a summary of the most critical device faults.

Bit Position	Flag	Default Value
7	X	0
6	OFF	0
5	VOUT Overvoltage	0
4	IOUT Overcurrent	0
3	VIN Undervoltage	0
2	Temperature	0
1	CML (Comm. Memory Fault)	0
0	None of the above	0

STATUS_WORD : Returns two bytes of information with a summary of the module’s fault/warning conditions.

Low Byte

Bit Position	Flag	Default Value
7	X	0
6	OFF	0
5	VOUT Overvoltage	0
4	IOUT Overcurrent	0
3	VIN Undervoltage	0
2	Temperature	0
1	CML (Comm. Memory Fault)	0
0	None of the above	0

High Byte

Bit Position	Flag	Default Value
7	VOUT fault or warning	0
6	IOUT fault	0
5	VIN Fault	0
4	X	0
3	PowerGOOD	0
2	Fan Fault	0
1	Shortcircuit	0
0	X	0

STATUS_VOUT : Returns one byte of information relating to the status of the module’s output voltage related faults.

Bit Position	Flag	Default Value
7	VOUT OV Fault	0
6	X	0
5	X	0
4	VOUT UV Fault	0
3	X	0
2	X	0
1	X	0
0	X	0

80A GigaDLynx™: Non-Isolated DC-DC Power Modules

4.5Vdc –14Vdc input; 0.6Vdc to 2.0Vdc output; 80A Output Current

STATUS_IOUT : Returns one byte of information relating to the status of the module’s output voltage related faults.

Bit Position	Flag	Default Value
7	IOUT OC Fault	0
6	X	0
5	X	0
4	X	0
3	X	0
2	X	0
1	X	0
0	X	0

STATUS_INPUT : Returns one byte of information relating to the status of the module’s output voltage related faults.

Bit Position	Flag	Default Value
7	VIN_OV_FAULT	0
6	X	0
5	X	0
4	VIN_UV_FAULT	0
3	X	0
2	X	0
1	X	0
0	X	0

STATUS_TEMPERATURE : Returns one byte of information relating to the status of the module’s temperature related faults.

Bit Position	Flag	Default Value
7	OT Fault	0
6	OT Warning	0
5	X	0
4	X	0
3	X	0
2	X	0
1	X	0
0	X	0

STATUS_CML : Returns one byte of information relating to the status of the module’s communication related faults.

Bit Position	Flag	Default Value
7	Invalid/Unsupported Command	0
6	Invalid/Unsupported data	0
5	Packet Error Check Failed	0
4	Memory Fault	0
3	X	0
2	X	0
1	X	0
0	X	0

MFR_VIN_MIN : Returns minimum input voltage as two data bytes of information in Linear format (upper five bits are exponent – fixed at -2, and lower 11 bits are mantissa in two’s complement format – fixed at 12)

MFR_VOUT_MIN : Returns minimum output voltage as two data bytes of information in Linear format (upper five bits are exponent – fixed at -10, and lower 11 bits are mantissa in two’s complement format – fixed at 614)

MFR_SPECIFIC_00 : Returns information related to the type of module and revision number. Bits [7:2] in the Low Byte indicate the module type (xxxxxx corresponds to the PLX002 series of module), while bits [7:3] indicate the revision number of the module.

Low Byte

Bit Position	Flag	Default Value
7:2	Module Name	xxxxxx
1:0	Reserved	10

High Byte

Bit Position	Flag	Default Value
7:3	Module Revision Number	None
2:0	Reserved	000

Writing to OTP (One Time Programmable) Memory

The GDT080 EEPROM memory can be completely written in entirety, for example, using STORE_DEFAULT_ALL command, only four times. During the situation of partial rewrites, for example, when trying to store only four commands using STORE_DEFAULT_CODE command four times in succession, numerous writes are possible within the confines of available memory.

80A GigaDlynx™: Non-Isolated DC-DC Power Modules

4.5Vdc –14Vdc input; 0.6Vdc to 2.0Vdc output; 80A Output Current

Summary of Supported PMBus Commands

Please refer to the PMBus 1.2 specification for more details of these commands.

Table 6

Hex Code	Command	Brief Description	Non-Volatile Memory Storage																																													
01	OPERATION	Turn Module on or off. Also used to margin the output voltage <table border="1"> <thead> <tr> <th>Format</th> <th colspan="8">Unsigned Binary</th> </tr> </thead> <tbody> <tr> <th>Bit Position</th> <td>7</td><td>6</td><td>5</td><td>4</td><td>3</td><td>2</td><td>1</td><td>0</td> </tr> <tr> <th>Access</th> <td>r/w</td><td>r</td><td>r/w</td><td>r/w</td><td>r/w</td><td>r/w</td><td>r</td><td>r</td> </tr> <tr> <th>Function</th> <td>On</td><td>X</td><td colspan="4">Margin</td><td>X</td><td>X</td> </tr> <tr> <th>Default Value</th> <td>0</td><td>0</td><td>0</td><td>0</td><td>0</td><td>0</td><td>X</td><td>X</td> </tr> </tbody> </table>	Format	Unsigned Binary								Bit Position	7	6	5	4	3	2	1	0	Access	r/w	r	r/w	r/w	r/w	r/w	r	r	Function	On	X	Margin				X	X	Default Value	0	0	0	0	0	0	X	X	
Format	Unsigned Binary																																															
Bit Position	7	6	5	4	3	2	1	0																																								
Access	r/w	r	r/w	r/w	r/w	r/w	r	r																																								
Function	On	X	Margin				X	X																																								
Default Value	0	0	0	0	0	0	X	X																																								
02	ON_OFF_CONFIG	Configures the ON/OFF functionality as a combination of analog ON/OFF pin and PMBus commands <table border="1"> <thead> <tr> <th>Format</th> <th colspan="8">Unsigned Binary</th> </tr> </thead> <tbody> <tr> <th>Bit Position</th> <td>7</td><td>6</td><td>5</td><td>4</td><td>3</td><td>2</td><td>1</td><td>0</td> </tr> <tr> <th>Access</th> <td>r</td><td>r</td><td>r</td><td>r/w</td><td>r/w</td><td>r/w</td><td>r/w</td><td>r</td> </tr> <tr> <th>Function</th> <td>X</td><td>X</td><td>X</td><td>pu</td><td>cmd</td><td>cpr</td><td>pol</td><td>cpa</td> </tr> <tr> <th>Default Value</th> <td>0</td><td>0</td><td>0</td><td>1</td><td>0</td><td>1</td><td>1</td><td>1</td> </tr> </tbody> </table>	Format	Unsigned Binary								Bit Position	7	6	5	4	3	2	1	0	Access	r	r	r	r/w	r/w	r/w	r/w	r	Function	X	X	X	pu	cmd	cpr	pol	cpa	Default Value	0	0	0	1	0	1	1	1	YES
Format	Unsigned Binary																																															
Bit Position	7	6	5	4	3	2	1	0																																								
Access	r	r	r	r/w	r/w	r/w	r/w	r																																								
Function	X	X	X	pu	cmd	cpr	pol	cpa																																								
Default Value	0	0	0	1	0	1	1	1																																								
03	CLEAR_FAULTS	Clear any fault bits that may have been set, also releases the SMBALERT# signal if the device has been asserting it.																																														
10	WRITE_PROTECT	Used to control writing to the module via PMBus. Copies the current register setting in the module whose command code matches the value in the data byte into non-volatile memory (EEPROM) on the module <table border="1"> <thead> <tr> <th>Format</th> <th colspan="8">Unsigned Binary</th> </tr> </thead> <tbody> <tr> <th>Bit Position</th> <td>7</td><td>6</td><td>5</td><td>4</td><td>3</td><td>2</td><td>1</td><td>0</td> </tr> <tr> <th>Access</th> <td>r/w</td><td>r/w</td><td>r/w</td><td>x</td><td>x</td><td>x</td><td>x</td><td>x</td> </tr> <tr> <th>Function</th> <td>bit7</td><td>bit6</td><td>bit5</td><td>X</td><td>X</td><td>X</td><td>X</td><td>X</td> </tr> <tr> <th>Default Value</th> <td>0</td><td>0</td><td>0</td><td>X</td><td>X</td><td>X</td><td>X</td><td>X</td> </tr> </tbody> </table> <p>Bit5: 0 – Enables all writes as permitted in bit6 or bit7 1 – Disables all writes except the WRITE_PROTECT, OPERATION and ON_OFF_CONFIG (bit 6 and bit7 must be 0) Bit 6: 0 – Enables all writes as permitted in bit5 or bit7 1 – Disables all writes except for the WRITE_PROTECT and OPERATION commands (bit5 and bit7 must be 0) Bit7: 0 – Enables all writes as permitted in bit5 or bit6 1 – Disables all writes except for the WRITE_PROTECT command (bit5 and bit6 must be 0)</p>	Format	Unsigned Binary								Bit Position	7	6	5	4	3	2	1	0	Access	r/w	r/w	r/w	x	x	x	x	x	Function	bit7	bit6	bit5	X	X	X	X	X	Default Value	0	0	0	X	X	X	X	X	YES
Format	Unsigned Binary																																															
Bit Position	7	6	5	4	3	2	1	0																																								
Access	r/w	r/w	r/w	x	x	x	x	x																																								
Function	bit7	bit6	bit5	X	X	X	X	X																																								
Default Value	0	0	0	X	X	X	X	X																																								
11	STORE_DEFAULT_ALL	Copies all current register settings in the module into non-volatile memory (EEPROM) on the module. Takes about 50ms for the command to execute.*																																														
12	RESTORE_DEFAULT_ALL	Restores all current register settings in the module from values in the module non-volatile memory (EEPROM)																																														
13	STORE_DEFAULT_CODE	Copies the current register setting in the module whose command code matches the value in the data byte into non-volatile memory (EEPROM) on the module <table border="1"> <thead> <tr> <th>Bit Position</th> <td>7</td><td>6</td><td>5</td><td>4</td><td>3</td><td>2</td><td>1</td><td>0</td> </tr> </thead> <tbody> <tr> <th>Access</th> <td>w</td><td>w</td><td>w</td><td>w</td><td>w</td><td>w</td><td>w</td><td>w</td> </tr> <tr> <th>Function</th> <td colspan="8">Command code</td> </tr> </tbody> </table>	Bit Position	7	6	5	4	3	2	1	0	Access	w	w	w	w	w	w	w	w	Function	Command code																										
Bit Position	7	6	5	4	3	2	1	0																																								
Access	w	w	w	w	w	w	w	w																																								
Function	Command code																																															
14	RESTORE_DEFAULT_CODE	Restores the current register setting in the module whose command code matches the value in the data byte from the value in the module non-volatile memory (EEPROM) <table border="1"> <thead> <tr> <th>Bit Position</th> <td>7</td><td>6</td><td>5</td><td>4</td><td>3</td><td>2</td><td>1</td><td>0</td> </tr> </thead> <tbody> <tr> <th>Access</th> <td>w</td><td>w</td><td>w</td><td>w</td><td>w</td><td>w</td><td>w</td><td>w</td> </tr> <tr> <th>Function</th> <td colspan="8">Command code</td> </tr> </tbody> </table>	Bit Position	7	6	5	4	3	2	1	0	Access	w	w	w	w	w	w	w	w	Function	Command code																										
Bit Position	7	6	5	4	3	2	1	0																																								
Access	w	w	w	w	w	w	w	w																																								
Function	Command code																																															
20	VOUT_MODE	The module has MODE set to Linear and Exponent set to -13. These values cannot be changed <table border="1"> <thead> <tr> <th>Bit Position</th> <td>7</td><td>6</td><td>5</td><td>4</td><td>3</td><td>2</td><td>1</td><td>0</td> </tr> </thead> <tbody> <tr> <th>Access</th> <td>r</td><td>r</td><td>r</td><td>r</td><td>r</td><td>r</td><td>r</td><td>r</td> </tr> <tr> <th>Function</th> <td colspan="4">Mode</td><td colspan="4">Exponent</td> </tr> <tr> <th>Default Value</th> <td>0</td><td>0</td><td>0</td><td>1</td><td>0</td><td>0</td><td>1</td><td>1</td> </tr> </tbody> </table>	Bit Position	7	6	5	4	3	2	1	0	Access	r	r	r	r	r	r	r	r	Function	Mode				Exponent				Default Value	0	0	0	1	0	0	1	1										
Bit Position	7	6	5	4	3	2	1	0																																								
Access	r	r	r	r	r	r	r	r																																								
Function	Mode				Exponent																																											
Default Value	0	0	0	1	0	0	1	1																																								

***NOTE: The EEPROM memory can be completely written in entirety (for example, using STORE_DEFAULT_ALL command) only four times. During the situation of partial rewrites, numerous writes are available within the confines of the available memory (for example, using STORE_DEFAULT_CODE command).**

80A GigaDlynx™: Non-Isolated DC-DC Power Modules

4.5Vdc –14Vdc input; 0.6Vdc to 2.0Vdc output; 80A Output Current

Table 6 (continued)

Hex Code	Command	Brief Description	Non-Volatile Memory Storage	
22	VOUT_TRIM	Apply a fixed offset voltage to the output voltage command value. Exponent is fixed at -13.	YES	
		Format		Linear, two's complement binary
		Bit Position		7 6 5 4 3 2 1 0
		Access		r/w r/w r/w r/w r/w r/w r/w r/w
		Function		High Byte
		Default Value		0 0 0 0 0 0 0 0
		Bit Position		7 6 5 4 3 2 1 0
		Access		r/w r/w r/w r/w r/w r/w r/w r/w
		Function		Low Byte
		Default Value		0 0 0 0 0 0 0 0
25	VOUT_MARGIN_HIGH	Sets the target voltage for margining the output high. Exponent is fixed at -13.	YES	
		Format		Linear, two's complement binary
		Bit Position		7 6 5 4 3 2 1 0
		Access		r r/w r/w r/w r/w r/w r/w r/w
		Function		High Byte
		Default Value		0 0 0 1 0 1 0 1
		Bit Position		7 6 5 4 3 2 1 0
		Access		r/w r/w r/w r/w r/w r/w r/w r/w
		Function		Low Byte
		Default Value		0 0 0 1 1 1 1 1
26	VOUT_MARGIN_LOW	Sets the target voltage for margining the output low. Exponent is fixed at -13	YES	
		Format		Linear, two's complement binary
		Bit Position		7 6 5 4 3 2 1 0
		Access		r r/w r/w r/w r/w r/w r/w r/w
		Function		High Byte
		Default Value		0 0 0 1 0 0 0 1
		Bit Position		7 6 5 4 3 2 1 0
		Access		r/w r/w r/w r/w r/w r/w r/w r/w
		Function		Low Byte
		Default Value		0 1 0 0 1 0 0 0
2A	VOUT_SCALE_MONITOR	Sets the scaling of the output voltage – equal to the ratio of internal reference Vref to the Output voltage. The internal reference is fixed at 0.6V. The output voltage read back gets scaled by the value of this parameter.	YES	
		Format		Linear, two's complement binary
		Bit Position		7 6 5 4 3 2 1 0
		Access		r/w r/w r/w r/w r/w r/w r/w r/w
		Function		Exponent* Mantissa
		Default Value		1 0 1 1 1 0 1 0
		Bit Position		7 6 5 4 3 2 1 0
		Access		r/w r/w r/w r/w r/w r/w r/w r/w
		Function		Mantissa
		Default Value		0 0 0 0 0 0 0 0
*For VOUT_SCALE_MONITOR values:				
1. between 0.1 and 0.5 use exponent of -11				
2. Between 0.5 and 1.0 use exponent of -10				
3. >1.0 use exponent of -9				
35	VIN_ON	Sets the value of input voltage at which the module turns on. Exponent is fixed at -6	YES	
		Format		Linear, two's complement binary
		Bit Position		7 6 5 4 3 2 1 0
		Access		r r r r r r r r
		Function		Exponent Mantissa
		Default Value		1 1 0 0 1 0 1 0
		Bit Position		7 6 5 4 3 2 1 0
		Access		r r/w r/w r/w r/w r/w r/w r/w
		Function		Mantissa
		Default Value		0 0 1 1 0 0 1 1

80A GigaDLynx™: Non-Isolated DC-DC Power Modules

4.5Vdc –14Vdc input; 0.6Vdc to 2.0Vdc output; 80A Output Current

Table 6 (continued)

Hex Code	Command	Brief Description	Non-Volatile Memory Storage	
36	VIN_OFF	Sets the value of input voltage at which the module turns off. Exponent is fixed at -6	YES	
		Format		Linear, two's complement binary
		Bit Position		7 6 5 4 3 2 1 0
		Access		r r r r r r r r
		Function		Exponent Mantissa
		Default Value		1 1 0 0 1 0 1 0
		Bit Position		7 6 5 4 3 2 1 0
		Access		r r/w r/w r/w r/w r/w r/w r/w
		Function		Mantissa
		Default Value		0 0 0 1 0 0 1 1
38	IOUT_CAL_GAIN	Returns the value of the gain correction term used to correct the measured output current	YES	
		Format		Linear, two's complement binary
		Bit Position		7 6 5 4 3 2 1 0
		Access		r r r r r r r r/w
		Function		Exponent Mantissa
		Default Value		V: Variable based on factory calibration
		Bit Position		7 6 5 4 3 2 1 0
		Access		r/w r/w r/w r/w r/w r/w r/w r/w
		Function		Mantissa
		Default Value		V: Variable based on factory calibration
39	IOUT_CAL_OFFSET	Returns the value of the offset correction term used to correct the measured output current	YES	
		Format		Linear, two's complement binary
		Bit Position		7 6 5 4 3 2 1 0
		Access		r r r r r r/w r r
		Function		Exponent Mantissa
		Default Value		V: Variable based on factory calibration
		Bit Position		7 6 5 4 3 2 1 0
		Access		r r r/w r/w r/w r/w r/w r/w
		Function		Mantissa
		Default Value		V: Variable based on factory calibration
40	VOUT_OV_FAULT_LIMIT	Sets the voltage level for an output overvoltage fault. Exponent is fixed at -13.	YES	
		Format		Linear, two's complement binary
		Bit Position		7 6 5 4 3 2 1 0
		Access		r r/w r/w r/w r/w r/w r/w r/w
		Function		High Byte
		Default Value		0 0 0 1 0 1 1 0
		Bit Position		7 6 5 4 3 2 1 0
		Access		r/w r/w r/w r/w r/w r/w r/w r/w
		Function		Low Byte
		Default Value		0 1 1 0 0 1 1 0
41	VOUT_OV_FAULT_RESPONSE	Instructs the module on the action to take in response to an output overvoltage fault	YES	
		Format		Unsigned Binary
		Bit Position		7 6 5 4 3 2 1 0
		Access		r/w r/w r/w r/w r/w r r r
		Function		RSP [1] RSP [0] RS[2] RS[1] RS[0] X X X
		Default Value		1 0 1 1 1 0 0 0

80A GigaDlynx™: Non-Isolated DC-DC Power Modules

4.5Vdc –14Vdc input; 0.6Vdc to 2.0Vdc output; 80A Output Current

Table 6 (continued)

Hex Code	Command	Brief Description	Non-Volatile Memory Storage																																																																																	
42	VOUT_OV_WARN_LIMIT	<p>Sets the value of output voltage at which the module generates warning for over-voltage. Exponent is fixed at -13</p> <table border="1"> <tr> <td>Format</td> <td colspan="8">Linear, two's complement binary</td> </tr> <tr> <td>Bit Position</td> <td>7</td><td>6</td><td>5</td><td>4</td><td>3</td><td>2</td><td>1</td><td>0</td> </tr> <tr> <td>Access</td> <td>r</td><td>r</td><td>r</td><td>r</td><td>r</td><td>r</td><td>r</td><td>r</td> </tr> <tr> <td>Function</td> <td colspan="4">Exponent</td> <td colspan="4">Mantissa</td> </tr> <tr> <td>Default Value</td> <td>0</td><td>0</td><td>0</td><td>1</td><td>0</td><td>1</td><td>0</td><td>1</td> </tr> <tr> <td>Bit Position</td> <td>7</td><td>6</td><td>5</td><td>4</td><td>3</td><td>2</td><td>1</td><td>0</td> </tr> <tr> <td>Access</td> <td>r</td><td>r/w</td><td>r/w</td><td>r/w</td><td>r/w</td><td>r/w</td><td>r/w</td><td>r/w</td> </tr> <tr> <td>Function</td> <td colspan="8">Mantissa</td> </tr> <tr> <td>Default Value</td> <td>0</td><td>0</td><td>1</td><td>0</td><td>0</td><td>0</td><td>0</td><td>1</td> </tr> </table>	Format	Linear, two's complement binary								Bit Position	7	6	5	4	3	2	1	0	Access	r	r	r	r	r	r	r	r	Function	Exponent				Mantissa				Default Value	0	0	0	1	0	1	0	1	Bit Position	7	6	5	4	3	2	1	0	Access	r	r/w	r/w	r/w	r/w	r/w	r/w	r/w	Function	Mantissa								Default Value	0	0	1	0	0	0	0	1	YES
Format	Linear, two's complement binary																																																																																			
Bit Position	7	6	5	4	3	2	1	0																																																																												
Access	r	r	r	r	r	r	r	r																																																																												
Function	Exponent				Mantissa																																																																															
Default Value	0	0	0	1	0	1	0	1																																																																												
Bit Position	7	6	5	4	3	2	1	0																																																																												
Access	r	r/w	r/w	r/w	r/w	r/w	r/w	r/w																																																																												
Function	Mantissa																																																																																			
Default Value	0	0	1	0	0	0	0	1																																																																												
43	VOUT_UV_WARN_LIMIT	<p>Sets the value of output voltage at which the module generates warning for under-voltage. Exponent is fixed at -13</p> <table border="1"> <tr> <td>Format</td> <td colspan="8">Linear, two's complement binary</td> </tr> <tr> <td>Bit Position</td> <td>7</td><td>6</td><td>5</td><td>4</td><td>3</td><td>2</td><td>1</td><td>0</td> </tr> <tr> <td>Access</td> <td>r</td><td>r</td><td>r</td><td>r</td><td>r</td><td>r</td><td>r</td><td>r/w</td> </tr> <tr> <td>Function</td> <td colspan="4">Exponent</td> <td colspan="4">Mantissa</td> </tr> <tr> <td>Default Value</td> <td>0</td><td>0</td><td>0</td><td>1</td><td>0</td><td>0</td><td>0</td><td>1</td> </tr> <tr> <td>Bit Position</td> <td>7</td><td>6</td><td>5</td><td>4</td><td>3</td><td>2</td><td>1</td><td>0</td> </tr> <tr> <td>Access</td> <td>r/w</td><td>r/w</td><td>r/w</td><td>r/w</td><td>r/w</td><td>r/w</td><td>r/w</td><td>r/w</td> </tr> <tr> <td>Function</td> <td colspan="8">Mantissa</td> </tr> <tr> <td>Default Value</td> <td>0</td><td>1</td><td>0</td><td>0</td><td>1</td><td>0</td><td>0</td><td>0</td> </tr> </table>	Format	Linear, two's complement binary								Bit Position	7	6	5	4	3	2	1	0	Access	r	r	r	r	r	r	r	r/w	Function	Exponent				Mantissa				Default Value	0	0	0	1	0	0	0	1	Bit Position	7	6	5	4	3	2	1	0	Access	r/w	r/w	r/w	r/w	r/w	r/w	r/w	r/w	Function	Mantissa								Default Value	0	1	0	0	1	0	0	0	YES
Format	Linear, two's complement binary																																																																																			
Bit Position	7	6	5	4	3	2	1	0																																																																												
Access	r	r	r	r	r	r	r	r/w																																																																												
Function	Exponent				Mantissa																																																																															
Default Value	0	0	0	1	0	0	0	1																																																																												
Bit Position	7	6	5	4	3	2	1	0																																																																												
Access	r/w	r/w	r/w	r/w	r/w	r/w	r/w	r/w																																																																												
Function	Mantissa																																																																																			
Default Value	0	1	0	0	1	0	0	0																																																																												
44	VOUT_UV_FAULT_LIMIT	<p>Sets the voltage level for an output undervoltage fault. Exponent is fixed at -13.</p> <table border="1"> <tr> <td>Format</td> <td colspan="8">Linear, two's complement binary</td> </tr> <tr> <td>Bit Position</td> <td>7</td><td>6</td><td>5</td><td>4</td><td>3</td><td>2</td><td>1</td><td>0</td> </tr> <tr> <td>Access</td> <td>r</td><td>r</td><td>r</td><td>r</td><td>r</td><td>r/w</td><td>r</td><td>r</td> </tr> <tr> <td>Function</td> <td colspan="4">Exponent</td> <td colspan="4">Mantissa</td> </tr> <tr> <td>Default Value</td> <td>0</td><td>0</td><td>0</td><td>1</td><td>0</td><td>0</td><td>0</td><td>0</td> </tr> <tr> <td>Bit Position</td> <td>7</td><td>6</td><td>5</td><td>4</td><td>3</td><td>2</td><td>1</td><td>0</td> </tr> <tr> <td>Access</td> <td>r</td><td>r</td><td>r/w</td><td>r/w</td><td>r/w</td><td>r/w</td><td>r/w</td><td>r/w</td> </tr> <tr> <td>Function</td> <td colspan="8">Mantissa</td> </tr> <tr> <td>Default Value</td> <td>0</td><td>1</td><td>0</td><td>1</td><td>0</td><td>0</td><td>0</td><td>0</td> </tr> </table>	Format	Linear, two's complement binary								Bit Position	7	6	5	4	3	2	1	0	Access	r	r	r	r	r	r/w	r	r	Function	Exponent				Mantissa				Default Value	0	0	0	1	0	0	0	0	Bit Position	7	6	5	4	3	2	1	0	Access	r	r	r/w	r/w	r/w	r/w	r/w	r/w	Function	Mantissa								Default Value	0	1	0	1	0	0	0	0	YES
Format	Linear, two's complement binary																																																																																			
Bit Position	7	6	5	4	3	2	1	0																																																																												
Access	r	r	r	r	r	r/w	r	r																																																																												
Function	Exponent				Mantissa																																																																															
Default Value	0	0	0	1	0	0	0	0																																																																												
Bit Position	7	6	5	4	3	2	1	0																																																																												
Access	r	r	r/w	r/w	r/w	r/w	r/w	r/w																																																																												
Function	Mantissa																																																																																			
Default Value	0	1	0	1	0	0	0	0																																																																												
45	VOUT_UV_FAULT_RESPONSE	<p>Instructs the module on the action to take in response to an output undervoltage fault</p> <table border="1"> <tr> <td>Format</td> <td colspan="8">Unsigned Binary</td> </tr> <tr> <td>Bit Position</td> <td>7</td><td>6</td><td>5</td><td>4</td><td>3</td><td>2</td><td>1</td><td>0</td> </tr> <tr> <td>Access</td> <td>r/w</td><td>r/w</td><td>r/w</td><td>r/w</td><td>r/w</td><td>r</td><td>r</td><td>r</td> </tr> <tr> <td>Function</td> <td>RSP [1]</td><td>RSP [0]</td><td>RS[2]</td><td>RS[1]</td><td>RS[0]</td><td>X</td><td>X</td><td>X</td> </tr> <tr> <td>Default Value</td> <td>1</td><td>0</td><td>1</td><td>1</td><td>1</td><td>0</td><td>0</td><td>0</td> </tr> </table>	Format	Unsigned Binary								Bit Position	7	6	5	4	3	2	1	0	Access	r/w	r/w	r/w	r/w	r/w	r	r	r	Function	RSP [1]	RSP [0]	RS[2]	RS[1]	RS[0]	X	X	X	Default Value	1	0	1	1	1	0	0	0	YES																																				
Format	Unsigned Binary																																																																																			
Bit Position	7	6	5	4	3	2	1	0																																																																												
Access	r/w	r/w	r/w	r/w	r/w	r	r	r																																																																												
Function	RSP [1]	RSP [0]	RS[2]	RS[1]	RS[0]	X	X	X																																																																												
Default Value	1	0	1	1	1	0	0	0																																																																												
46	IOUT_OC_FAULT_LIMIT	<p>Sets the current level for an output overcurrent fault (cannot be changed)</p> <table border="1"> <tr> <td>Format</td> <td colspan="8">Linear, two's complement binary</td> </tr> <tr> <td>Bit Position</td> <td>7</td><td>6</td><td>5</td><td>4</td><td>3</td><td>2</td><td>1</td><td>0</td> </tr> <tr> <td>Access</td> <td>r</td><td>r</td><td>r</td><td>r</td><td>r</td><td>r/w</td><td>r</td><td>r</td> </tr> <tr> <td>Function</td> <td colspan="4">Exponent</td> <td colspan="4">Mantissa</td> </tr> <tr> <td>Default Value</td> <td>1</td><td>1</td><td>1</td><td>0</td><td>0</td><td>0</td><td>1</td><td>1</td> </tr> <tr> <td>Bit Position</td> <td>7</td><td>6</td><td>5</td><td>4</td><td>3</td><td>2</td><td>1</td><td>0</td> </tr> <tr> <td>Access</td> <td>r</td><td>r</td><td>r/w</td><td>r/w</td><td>r/w</td><td>r/w</td><td>r/w</td><td>r/w</td> </tr> <tr> <td>Function</td> <td colspan="8">Mantissa</td> </tr> <tr> <td>Default Value</td> <td>0</td><td>0</td><td>0</td><td>0</td><td>1</td><td>1</td><td>1</td><td>1</td> </tr> </table>	Format	Linear, two's complement binary								Bit Position	7	6	5	4	3	2	1	0	Access	r	r	r	r	r	r/w	r	r	Function	Exponent				Mantissa				Default Value	1	1	1	0	0	0	1	1	Bit Position	7	6	5	4	3	2	1	0	Access	r	r	r/w	r/w	r/w	r/w	r/w	r/w	Function	Mantissa								Default Value	0	0	0	0	1	1	1	1	YES
Format	Linear, two's complement binary																																																																																			
Bit Position	7	6	5	4	3	2	1	0																																																																												
Access	r	r	r	r	r	r/w	r	r																																																																												
Function	Exponent				Mantissa																																																																															
Default Value	1	1	1	0	0	0	1	1																																																																												
Bit Position	7	6	5	4	3	2	1	0																																																																												
Access	r	r	r/w	r/w	r/w	r/w	r/w	r/w																																																																												
Function	Mantissa																																																																																			
Default Value	0	0	0	0	1	1	1	1																																																																												

80A GigaDLynx™: Non-Isolated DC-DC Power Modules

4.5Vdc –14Vdc input; 0.6Vdc to 2.0Vdc output; 80A Output Current

4A	IOUT_OC_WARN_LIMIT	Sets the value of current level at which the module generates warning for overcurrent.							YES		
		Format	Linear, two's complement binary								
		Bit Position	7	6	5	4	3	2		1	0
		Access	r	r	r	r	r	r		r	r/w
		Function	Exponent				Mantissa				
		Default Value	1	1	1	0	0	0		1	0
		Bit Position	7	6	5	4	3	2		1	0
		Access	r/w	r/w	r/w	r/w	r/w	r/w		r/w	r/w
		Function	Mantissa								
		Default Value	1	1	1	1	1	1		1	1

80A GigaDlynx™: Non-Isolated DC-DC Power Modules

4.5Vdc –14Vdc input; 0.6Vdc to 2.0Vdc output; 80A Output Current

Table 6 (continued)

Hex Code	Command	Brief Description	Non-Volatile Memory Storage																																																																																				
4F	OT_FAULT_LIMIT	<p>Sets the temperature level above which over-temperature fault occurs.</p> <table border="1"> <tr> <td>Format</td> <td colspan="9">Linear, two's complement binary</td> </tr> <tr> <td>Bit Position</td> <td>7</td><td>6</td><td>5</td><td>4</td><td>3</td><td>2</td><td>1</td><td>0</td> </tr> <tr> <td>Access</td> <td>r</td><td>r</td><td>r</td><td>r</td><td>r</td><td>r/w</td><td>r</td><td>r</td> </tr> <tr> <td>Function</td> <td colspan="5">Exponent</td> <td colspan="4">Mantissa</td> </tr> <tr> <td>Default Value</td> <td>1</td><td>1</td><td>1</td><td>0</td><td>1</td><td>0</td><td>1</td><td>1</td> </tr> <tr> <td>Bit Position</td> <td>7</td><td>6</td><td>5</td><td>4</td><td>3</td><td>2</td><td>1</td><td>0</td> </tr> <tr> <td>Access</td> <td>r</td><td>r</td><td>r/w</td><td>r/w</td><td>r/w</td><td>r/w</td><td>r/w</td><td>r/w</td> </tr> <tr> <td>Function</td> <td colspan="9">Mantissa</td> </tr> <tr> <td>Default Value</td> <td>1</td><td>1</td><td>1</td><td>0</td><td>0</td><td>1</td><td>1</td><td>1</td> </tr> </table>	Format	Linear, two's complement binary									Bit Position	7	6	5	4	3	2	1	0	Access	r	r	r	r	r	r/w	r	r	Function	Exponent					Mantissa				Default Value	1	1	1	0	1	0	1	1	Bit Position	7	6	5	4	3	2	1	0	Access	r	r	r/w	r/w	r/w	r/w	r/w	r/w	Function	Mantissa									Default Value	1	1	1	0	0	1	1	1	YES
Format	Linear, two's complement binary																																																																																						
Bit Position	7	6	5	4	3	2	1	0																																																																															
Access	r	r	r	r	r	r/w	r	r																																																																															
Function	Exponent					Mantissa																																																																																	
Default Value	1	1	1	0	1	0	1	1																																																																															
Bit Position	7	6	5	4	3	2	1	0																																																																															
Access	r	r	r/w	r/w	r/w	r/w	r/w	r/w																																																																															
Function	Mantissa																																																																																						
Default Value	1	1	1	0	0	1	1	1																																																																															
50	OT_FAULT_RESPONSE	<p>Configures the over temperature fault response</p> <table border="1"> <tr> <td>Format</td> <td colspan="9">Unsigned Binary</td> </tr> <tr> <td>Bit Position</td> <td>7</td><td>6</td><td>5</td><td>4</td><td>3</td><td>2</td><td>1</td><td>0</td> </tr> <tr> <td>Access</td> <td>r/w</td><td>r/w</td><td>r/w</td><td>r/w</td><td>r/w</td><td>r</td><td>r</td><td>r</td> </tr> <tr> <td>Function</td> <td>RSP [1]</td><td>RSP [0]</td><td>RS[2]</td><td>RS[1]</td><td>RS[0]</td><td>X</td><td>X</td><td>X</td> </tr> <tr> <td>Default Value</td> <td>1</td><td>0</td><td>1</td><td>1</td><td>1</td><td>0</td><td>0</td><td>0</td> </tr> </table>	Format	Unsigned Binary									Bit Position	7	6	5	4	3	2	1	0	Access	r/w	r/w	r/w	r/w	r/w	r	r	r	Function	RSP [1]	RSP [0]	RS[2]	RS[1]	RS[0]	X	X	X	Default Value	1	0	1	1	1	0	0	0	YES																																						
Format	Unsigned Binary																																																																																						
Bit Position	7	6	5	4	3	2	1	0																																																																															
Access	r/w	r/w	r/w	r/w	r/w	r	r	r																																																																															
Function	RSP [1]	RSP [0]	RS[2]	RS[1]	RS[0]	X	X	X																																																																															
Default Value	1	0	1	1	1	0	0	0																																																																															
51	OT_WARN_LIMIT	<p>Sets the over temperature warning level in °C</p> <table border="1"> <tr> <td>Format</td> <td colspan="9">Linear, two's complement binary</td> </tr> <tr> <td>Bit Position</td> <td>7</td><td>6</td><td>5</td><td>4</td><td>3</td><td>2</td><td>1</td><td>0</td> </tr> <tr> <td>Access</td> <td>r</td><td>r</td><td>r</td><td>r</td><td>r</td><td>r</td><td>r</td><td>r</td> </tr> <tr> <td>Function</td> <td colspan="5">Exponent</td> <td colspan="4">Mantissa</td> </tr> <tr> <td>Default Value</td> <td>1</td><td>1</td><td>1</td><td>0</td><td>1</td><td>0</td><td>1</td><td>1</td> </tr> <tr> <td>Bit Position</td> <td>7</td><td>6</td><td>5</td><td>4</td><td>3</td><td>2</td><td>1</td><td>0</td> </tr> <tr> <td>Access</td> <td>r</td><td>r/w</td><td>r/w</td><td>r/w</td><td>r/w</td><td>r/w</td><td>r/w</td><td>r/w</td> </tr> <tr> <td>Function</td> <td colspan="9">Mantissa</td> </tr> <tr> <td>Default Value</td> <td>1</td><td>0</td><td>0</td><td>1</td><td>0</td><td>1</td><td>1</td><td>0</td> </tr> </table>	Format	Linear, two's complement binary									Bit Position	7	6	5	4	3	2	1	0	Access	r	r	r	r	r	r	r	r	Function	Exponent					Mantissa				Default Value	1	1	1	0	1	0	1	1	Bit Position	7	6	5	4	3	2	1	0	Access	r	r/w	r/w	r/w	r/w	r/w	r/w	r/w	Function	Mantissa									Default Value	1	0	0	1	0	1	1	0	YES
Format	Linear, two's complement binary																																																																																						
Bit Position	7	6	5	4	3	2	1	0																																																																															
Access	r	r	r	r	r	r	r	r																																																																															
Function	Exponent					Mantissa																																																																																	
Default Value	1	1	1	0	1	0	1	1																																																																															
Bit Position	7	6	5	4	3	2	1	0																																																																															
Access	r	r/w	r/w	r/w	r/w	r/w	r/w	r/w																																																																															
Function	Mantissa																																																																																						
Default Value	1	0	0	1	0	1	1	0																																																																															
056	VIN_OV_FAULT_RESPONSE	<p>Configures the VIN overvoltage fault response.</p> <table border="1"> <tr> <td>Format</td> <td colspan="9">Unsigned Binary</td> </tr> <tr> <td>Bit Position</td> <td>7</td><td>6</td><td>5</td><td>4</td><td>3</td><td>2</td><td>1</td><td>0</td> </tr> <tr> <td>Access</td> <td>r/w</td><td>r/w</td><td>r/w</td><td>r/w</td><td>r/w</td><td>r</td><td>r</td><td>r</td> </tr> <tr> <td>Function</td> <td>RSP [1]</td><td>RSP [0]</td><td>RS[2]</td><td>RS[1]</td><td>RS[0]</td><td>X</td><td>X</td><td>X</td> </tr> <tr> <td>Default Value</td> <td>1</td><td>0</td><td>0</td><td>0</td><td>0</td><td>0</td><td>0</td><td>0</td> </tr> </table>	Format	Unsigned Binary									Bit Position	7	6	5	4	3	2	1	0	Access	r/w	r/w	r/w	r/w	r/w	r	r	r	Function	RSP [1]	RSP [0]	RS[2]	RS[1]	RS[0]	X	X	X	Default Value	1	0	0	0	0	0	0	0	YES																																						
Format	Unsigned Binary																																																																																						
Bit Position	7	6	5	4	3	2	1	0																																																																															
Access	r/w	r/w	r/w	r/w	r/w	r	r	r																																																																															
Function	RSP [1]	RSP [0]	RS[2]	RS[1]	RS[0]	X	X	X																																																																															
Default Value	1	0	0	0	0	0	0	0																																																																															
57	VIN_OV_WARN_LIMIT	<p>Sets the value of the input voltage that causes input voltage low warning. Exponent fixed at -6</p> <table border="1"> <tr> <td>Format</td> <td colspan="9">Linear, two's complement binary</td> </tr> <tr> <td>Bit Position</td> <td>7</td><td>6</td><td>5</td><td>4</td><td>3</td><td>2</td><td>1</td><td>0</td> </tr> <tr> <td>Access</td> <td>r</td><td>r</td><td>r</td><td>r</td><td>r</td><td>r</td><td>r</td><td>r</td> </tr> <tr> <td>Function</td> <td colspan="5">Exponent</td> <td colspan="4">Mantissa</td> </tr> <tr> <td>Default Value</td> <td>1</td><td>1</td><td>0</td><td>1</td><td>0</td><td>0</td><td>1</td><td>1</td> </tr> <tr> <td>Bit Position</td> <td>7</td><td>6</td><td>5</td><td>4</td><td>3</td><td>2</td><td>1</td><td>0</td> </tr> <tr> <td>Access</td> <td>r</td><td>r/w</td><td>r/w</td><td>r/w</td><td>r/w</td><td>r/w</td><td>r/w</td><td>r/w</td> </tr> <tr> <td>Function</td> <td colspan="9">Mantissa</td> </tr> <tr> <td>Default Value</td> <td>1</td><td>0</td><td>0</td><td>1</td><td>0</td><td>0</td><td>1</td><td>1</td> </tr> </table>	Format	Linear, two's complement binary									Bit Position	7	6	5	4	3	2	1	0	Access	r	r	r	r	r	r	r	r	Function	Exponent					Mantissa				Default Value	1	1	0	1	0	0	1	1	Bit Position	7	6	5	4	3	2	1	0	Access	r	r/w	r/w	r/w	r/w	r/w	r/w	r/w	Function	Mantissa									Default Value	1	0	0	1	0	0	1	1	YES
Format	Linear, two's complement binary																																																																																						
Bit Position	7	6	5	4	3	2	1	0																																																																															
Access	r	r	r	r	r	r	r	r																																																																															
Function	Exponent					Mantissa																																																																																	
Default Value	1	1	0	1	0	0	1	1																																																																															
Bit Position	7	6	5	4	3	2	1	0																																																																															
Access	r	r/w	r/w	r/w	r/w	r/w	r/w	r/w																																																																															
Function	Mantissa																																																																																						
Default Value	1	0	0	1	0	0	1	1																																																																															

80A GigaDlynx™: Non-Isolated DC-DC Power Modules

4.5Vdc –14Vdc input; 0.6Vdc to 2.0Vdc output; 80A Output Current

Table 6 (continued)

Hex Code	Command	Brief Description	Non-Volatile Memory Storage																																																																																	
58	VIN_UV_WARN_LIMIT	<p>Sets the value of the input voltage that causes input voltage low warning. Exponent fixed at -6</p> <table border="1"> <tr> <td>Format</td> <td colspan="8">Linear, two's complement binary</td> </tr> <tr> <td>Bit Position</td> <td>7</td><td>6</td><td>5</td><td>4</td><td>3</td><td>2</td><td>1</td><td>0</td> </tr> <tr> <td>Access</td> <td>r</td><td>r</td><td>r</td><td>r</td><td>r</td><td>r</td><td>r</td><td>r</td> </tr> <tr> <td>Function</td> <td colspan="4">Exponent</td> <td colspan="4">Mantissa</td> </tr> <tr> <td>Default Value</td> <td>1</td><td>1</td><td>0</td><td>0</td><td>1</td><td>0</td><td>1</td><td>0</td> </tr> <tr> <td>Bit Position</td> <td>7</td><td>6</td><td>5</td><td>4</td><td>3</td><td>2</td><td>1</td><td>0</td> </tr> <tr> <td>Access</td> <td>r</td><td>r/w</td><td>r/w</td><td>r/w</td><td>r/w</td><td>r/w</td><td>r/w</td><td>r/w</td> </tr> <tr> <td>Function</td> <td colspan="8">Mantissa</td> </tr> <tr> <td>Default Value</td> <td>0</td><td>1</td><td>0</td><td>0</td><td>0</td><td>0</td><td>0</td><td>0</td> </tr> </table>	Format	Linear, two's complement binary								Bit Position	7	6	5	4	3	2	1	0	Access	r	r	r	r	r	r	r	r	Function	Exponent				Mantissa				Default Value	1	1	0	0	1	0	1	0	Bit Position	7	6	5	4	3	2	1	0	Access	r	r/w	r/w	r/w	r/w	r/w	r/w	r/w	Function	Mantissa								Default Value	0	1	0	0	0	0	0	0	YES
Format	Linear, two's complement binary																																																																																			
Bit Position	7	6	5	4	3	2	1	0																																																																												
Access	r	r	r	r	r	r	r	r																																																																												
Function	Exponent				Mantissa																																																																															
Default Value	1	1	0	0	1	0	1	0																																																																												
Bit Position	7	6	5	4	3	2	1	0																																																																												
Access	r	r/w	r/w	r/w	r/w	r/w	r/w	r/w																																																																												
Function	Mantissa																																																																																			
Default Value	0	1	0	0	0	0	0	0																																																																												
59	VIN_UV_FAULT_LIMIT	<p>Sets the value of the input voltage that causes an input undervoltage fault. Exponent fixed at -6.</p> <table border="1"> <tr> <td>Format</td> <td colspan="8">Linear, two's complement binary</td> </tr> <tr> <td>Bit Position</td> <td>7</td><td>6</td><td>5</td><td>4</td><td>3</td><td>2</td><td>1</td><td>0</td> </tr> <tr> <td>Access</td> <td>r</td><td>r</td><td>r</td><td>r</td><td>r</td><td>r</td><td>r</td><td>r</td> </tr> <tr> <td>Function</td> <td colspan="4">Exponent</td> <td colspan="4">Mantissa</td> </tr> <tr> <td>Default Value</td> <td>1</td><td>1</td><td>0</td><td>0</td><td>1</td><td>0</td><td>1</td><td>0</td> </tr> <tr> <td>Bit Position</td> <td>7</td><td>6</td><td>5</td><td>4</td><td>3</td><td>2</td><td>1</td><td>0</td> </tr> <tr> <td>Access</td> <td>r</td><td>r/w</td><td>r/w</td><td>r/w</td><td>r/w</td><td>r/w</td><td>r/w</td><td>r/w</td> </tr> <tr> <td>Function</td> <td colspan="8">Mantissa</td> </tr> <tr> <td>Default Value</td> <td>0</td><td>0</td><td>0</td><td>0</td><td>1</td><td>1</td><td>0</td><td>1</td> </tr> </table>	Format	Linear, two's complement binary								Bit Position	7	6	5	4	3	2	1	0	Access	r	r	r	r	r	r	r	r	Function	Exponent				Mantissa				Default Value	1	1	0	0	1	0	1	0	Bit Position	7	6	5	4	3	2	1	0	Access	r	r/w	r/w	r/w	r/w	r/w	r/w	r/w	Function	Mantissa								Default Value	0	0	0	0	1	1	0	1	YES
Format	Linear, two's complement binary																																																																																			
Bit Position	7	6	5	4	3	2	1	0																																																																												
Access	r	r	r	r	r	r	r	r																																																																												
Function	Exponent				Mantissa																																																																															
Default Value	1	1	0	0	1	0	1	0																																																																												
Bit Position	7	6	5	4	3	2	1	0																																																																												
Access	r	r/w	r/w	r/w	r/w	r/w	r/w	r/w																																																																												
Function	Mantissa																																																																																			
Default Value	0	0	0	0	1	1	0	1																																																																												
5A	VIN_UV_FAULT_RESPONSE	<p>Instructs the module on what action to take in response to an input undervoltage fault.</p> <table border="1"> <tr> <td>Format</td> <td colspan="8">Unsigned Binary</td> </tr> <tr> <td>Bit Position</td> <td>7</td><td>6</td><td>5</td><td>4</td><td>3</td><td>2</td><td>1</td><td>0</td> </tr> <tr> <td>Access</td> <td>r/w</td><td>r/w</td><td>r/w</td><td>r/w</td><td>r/w</td><td>r</td><td>r</td><td>r</td> </tr> <tr> <td>Function</td> <td>RSP [1]</td><td>RSP [0]</td><td>RS[2]</td><td>RS[1]</td><td>RS[0]</td><td>X</td><td>X</td><td>X</td> </tr> <tr> <td>Default Value</td> <td>1</td><td>0</td><td>1</td><td>1</td><td>1</td><td>0</td><td>0</td><td>0</td> </tr> </table>	Format	Unsigned Binary								Bit Position	7	6	5	4	3	2	1	0	Access	r/w	r/w	r/w	r/w	r/w	r	r	r	Function	RSP [1]	RSP [0]	RS[2]	RS[1]	RS[0]	X	X	X	Default Value	1	0	1	1	1	0	0	0	YES																																				
Format	Unsigned Binary																																																																																			
Bit Position	7	6	5	4	3	2	1	0																																																																												
Access	r/w	r/w	r/w	r/w	r/w	r	r	r																																																																												
Function	RSP [1]	RSP [0]	RS[2]	RS[1]	RS[0]	X	X	X																																																																												
Default Value	1	0	1	1	1	0	0	0																																																																												
5E	POWER_GOOD_ON	<p>Sets the output voltage level at which the PGOOD pin is asserted high. Exponent is fixed at -13.</p> <table border="1"> <tr> <td>Format</td> <td colspan="8">Linear, two's complement binary</td> </tr> <tr> <td>Bit Position</td> <td>7</td><td>6</td><td>5</td><td>4</td><td>3</td><td>2</td><td>1</td><td>0</td> </tr> <tr> <td>Access</td> <td>r</td><td>r/w</td><td>r/w</td><td>r/w</td><td>r/w</td><td>r/w</td><td>r/w</td><td>r/w</td> </tr> <tr> <td>Function</td> <td colspan="8">High Byte</td> </tr> <tr> <td>Default Value</td> <td>0</td><td>0</td><td>0</td><td>1</td><td>0</td><td>0</td><td>1</td><td>0</td> </tr> <tr> <td>Bit Position</td> <td>7</td><td>6</td><td>5</td><td>4</td><td>3</td><td>2</td><td>1</td><td>0</td> </tr> <tr> <td>Access</td> <td>r/w</td><td>r/w</td><td>r/w</td><td>r/w</td><td>r/w</td><td>r/w</td><td>r/w</td><td>r/w</td> </tr> <tr> <td>Function</td> <td colspan="8">Low Byte</td> </tr> <tr> <td>Default Value</td> <td>0</td><td>0</td><td>1</td><td>1</td><td>1</td><td>1</td><td>1</td><td>1</td> </tr> </table>	Format	Linear, two's complement binary								Bit Position	7	6	5	4	3	2	1	0	Access	r	r/w	r/w	r/w	r/w	r/w	r/w	r/w	Function	High Byte								Default Value	0	0	0	1	0	0	1	0	Bit Position	7	6	5	4	3	2	1	0	Access	r/w	r/w	r/w	r/w	r/w	r/w	r/w	r/w	Function	Low Byte								Default Value	0	0	1	1	1	1	1	1	YES
Format	Linear, two's complement binary																																																																																			
Bit Position	7	6	5	4	3	2	1	0																																																																												
Access	r	r/w	r/w	r/w	r/w	r/w	r/w	r/w																																																																												
Function	High Byte																																																																																			
Default Value	0	0	0	1	0	0	1	0																																																																												
Bit Position	7	6	5	4	3	2	1	0																																																																												
Access	r/w	r/w	r/w	r/w	r/w	r/w	r/w	r/w																																																																												
Function	Low Byte																																																																																			
Default Value	0	0	1	1	1	1	1	1																																																																												
5F	POWER_GOOD_OFF	<p>Sets the output voltage level at which the PGOOD pin is de-asserted low. Exponent is fixed at -13.</p> <table border="1"> <tr> <td>Format</td> <td colspan="8">Linear, two's complement binary</td> </tr> <tr> <td>Bit Position</td> <td>7</td><td>6</td><td>5</td><td>4</td><td>3</td><td>2</td><td>1</td><td>0</td> </tr> <tr> <td>Access</td> <td>r</td><td>r/w</td><td>r/w</td><td>r/w</td><td>r/w</td><td>r/w</td><td>r/w</td><td>r/w</td> </tr> <tr> <td>Function</td> <td colspan="8">High Byte</td> </tr> <tr> <td>Default Value</td> <td>0</td><td>0</td><td>0</td><td>1</td><td>0</td><td>0</td><td>0</td><td>1</td> </tr> <tr> <td>Bit Position</td> <td>7</td><td>6</td><td>5</td><td>4</td><td>3</td><td>2</td><td>1</td><td>0</td> </tr> <tr> <td>Access</td> <td>r/w</td><td>r/w</td><td>r/w</td><td>r/w</td><td>r/w</td><td>r/w</td><td>r/w</td><td>r/w</td> </tr> <tr> <td>Function</td> <td colspan="8">Low Byte</td> </tr> <tr> <td>Default Value</td> <td>0</td><td>1</td><td>0</td><td>0</td><td>1</td><td>0</td><td>0</td><td>0</td> </tr> </table>	Format	Linear, two's complement binary								Bit Position	7	6	5	4	3	2	1	0	Access	r	r/w	r/w	r/w	r/w	r/w	r/w	r/w	Function	High Byte								Default Value	0	0	0	1	0	0	0	1	Bit Position	7	6	5	4	3	2	1	0	Access	r/w	r/w	r/w	r/w	r/w	r/w	r/w	r/w	Function	Low Byte								Default Value	0	1	0	0	1	0	0	0	YES
Format	Linear, two's complement binary																																																																																			
Bit Position	7	6	5	4	3	2	1	0																																																																												
Access	r	r/w	r/w	r/w	r/w	r/w	r/w	r/w																																																																												
Function	High Byte																																																																																			
Default Value	0	0	0	1	0	0	0	1																																																																												
Bit Position	7	6	5	4	3	2	1	0																																																																												
Access	r/w	r/w	r/w	r/w	r/w	r/w	r/w	r/w																																																																												
Function	Low Byte																																																																																			
Default Value	0	1	0	0	1	0	0	0																																																																												

80A GigaDlynx™: Non-Isolated DC-DC Power Modules

4.5Vdc –14Vdc input; 0.6Vdc to 2.0Vdc output; 80A Output Current

Table 6 (continued)

Hex Code	Command	Brief Description	Non-Volatile Memory Storage	
60	TON_DELAY	Sets the delay time in ms of the output voltage during startup.	YES	
		Format		Linear, two's complement binary
		Bit Position		7 6 5 4 3 2 1 0
		Access		r r r r r r r r/w
		Function		Exponent Mantissa
		Default Value		1 1 1 1 1 0 0 0
		Bit Position		7 6 5 4 3 2 1 0
		Access		r/w r/w r/w r/w r/w r/w r/w r/w
		Function		Mantissa
Default Value	0 0 0 0 0 0 0 0			
61	TON_RISE	Sets the rise time in ms of the output voltage during startup	YES	
		Format		Linear, two's complement binary
		Bit Position		7 6 5 4 3 2 1 0
		Access		r r R r r r r r/w
		Function		Exponent Mantissa
		Default Value		1 0 1 1 1 0 1 1
		Bit Position		7 6 5 4 3 2 1 0
		Access		r/w r/w r/w r/w r/w r/w r/w r/w
		Function		Mantissa
Default Value	1 1 1 1 1 1 1 1			
64	TOFF_DELAY	Sets the delay time in ms of the output voltage during turn-off	YES	
		Format		Linear, two's complement binary
		Bit Position		7 6 5 4 3 2 1 0
		Access		r r R r r r r r/w
		Function		Exponent Mantissa
		Default Value		1 1 1 1 1 0 0 0
		Bit Position		7 6 5 4 3 2 1 0
		Access		r/w r/w r/w r/w r/w r/w r/w r/w
		Function		Mantissa
Default Value	0 0 0 0 0 0 0 0			
65	TOFF_FALL	Sets the fall time in ms of the output voltage during turn-off	YES	
		Format		Linear, two's complement binary
		Bit Position		7 6 5 4 3 2 1 0
		Access		r r R r r r r r/w
		Function		Exponent Mantissa
		Default Value		1 0 1 1 1 0 1 1
		Bit Position		7 6 5 4 3 2 1 0
		Access		r/w r/w r/w r/w r/w r/w r/w r/w
		Function		Mantissa
Default Value	1 1 1 1 1 1 1 1			
78	STATUS_BYTE	Returns one byte of information with a summary of the most critical module faults	NO	
		Format		Unsigned Binary
		Bit Position		7 6 5 4 3 2 1 0
		Access		r r R r r r r r
		Flag		X OFF VOUT_OV IOUT_OC VIN_UV TEMP CML OTHER
Default Value	0 0 0 0 0 0 0 0			
79	STATUS_WORD	Returns two bytes of information with a summary of the module's fault/warning conditions	NO	
		Format		Unsigned binary
		Bit Position		7 6 5 4 3 2 1 0
		Access		r r R r r r r r
		Flag		VOUT IOUT_OC X X PGOOD X X X
		Default Value		0 0 0 0 0 0 0 0
		Bit Position		7 6 5 4 3 2 1 0
		Access		r r R r r r r r
		Flag		X OFF VOUT_OV IOUT_OC VIN_UV TEMP CML OTHER
Default Value	0 0 0 0 0 0 0 0			

80A GigaDlynx™: Non-Isolated DC-DC Power Modules

4.5Vdc –14Vdc input; 0.6Vdc to 2.0Vdc output; 80A Output Current

Table 6 (continued)

Hex Code	Command	Brief Description	Non-Volatile Memory Storage																																																																																	
7A	STATUS_VOUT	<p>Returns one byte of information with the status of the module’s output voltage related faults</p> <table border="1"> <tr> <td>Format</td> <td colspan="8">Unsigned Binary</td> </tr> <tr> <td>Bit Position</td> <td>7</td> <td>6</td> <td>5</td> <td>4</td> <td>3</td> <td>2</td> <td>1</td> <td>0</td> </tr> <tr> <td>Access</td> <td>r</td> <td>r</td> <td>r</td> <td>r</td> <td>r</td> <td>r</td> <td>r</td> <td>r</td> </tr> <tr> <td>Flag</td> <td>VOUT_OV</td> <td>X</td> <td>X</td> <td>VOUT_UV</td> <td>X</td> <td>X</td> <td>X</td> <td>X</td> </tr> <tr> <td>Default Value</td> <td>0</td> <td>0</td> <td>0</td> <td>0</td> <td>0</td> <td>0</td> <td>0</td> <td>0</td> </tr> </table>	Format	Unsigned Binary								Bit Position	7	6	5	4	3	2	1	0	Access	r	r	r	r	r	r	r	r	Flag	VOUT_OV	X	X	VOUT_UV	X	X	X	X	Default Value	0	0	0	0	0	0	0	0	NO																																				
Format	Unsigned Binary																																																																																			
Bit Position	7	6	5	4	3	2	1	0																																																																												
Access	r	r	r	r	r	r	r	r																																																																												
Flag	VOUT_OV	X	X	VOUT_UV	X	X	X	X																																																																												
Default Value	0	0	0	0	0	0	0	0																																																																												
7B	STATUS_IOUT	<p>Returns one byte of information with the status of the module’s output current related faults</p> <table border="1"> <tr> <td>Format</td> <td colspan="8">Unsigned Binary</td> </tr> <tr> <td>Bit Position</td> <td>7</td> <td>6</td> <td>5</td> <td>4</td> <td>3</td> <td>2</td> <td>1</td> <td>0</td> </tr> <tr> <td>Access</td> <td>r</td> <td>r</td> <td>r</td> <td>r</td> <td>r</td> <td>r</td> <td>r</td> <td>r</td> </tr> <tr> <td>Flag</td> <td>IOUT_OC</td> <td>X</td> <td>X</td> <td>X</td> <td>IOUT_OC_WARN</td> <td>X</td> <td>X</td> <td>X</td> </tr> <tr> <td>Default Value</td> <td>0</td> <td>0</td> <td>0</td> <td>0</td> <td>0</td> <td>0</td> <td>0</td> <td>0</td> </tr> </table>	Format	Unsigned Binary								Bit Position	7	6	5	4	3	2	1	0	Access	r	r	r	r	r	r	r	r	Flag	IOUT_OC	X	X	X	IOUT_OC_WARN	X	X	X	Default Value	0	0	0	0	0	0	0	0	NO																																				
Format	Unsigned Binary																																																																																			
Bit Position	7	6	5	4	3	2	1	0																																																																												
Access	r	r	r	r	r	r	r	r																																																																												
Flag	IOUT_OC	X	X	X	IOUT_OC_WARN	X	X	X																																																																												
Default Value	0	0	0	0	0	0	0	0																																																																												
7C	STATUS_INPUT	<p>Returns one byte of information with the status of the module’s input related faults</p> <table border="1"> <tr> <td>Format</td> <td colspan="8">Unsigned Binary</td> </tr> <tr> <td>Bit Position</td> <td>7</td> <td>6</td> <td>5</td> <td>4</td> <td>3</td> <td>2</td> <td>1</td> <td>0</td> </tr> <tr> <td>Access</td> <td>r</td> <td>r</td> <td>r</td> <td>r</td> <td>r</td> <td>r</td> <td>r</td> <td>r</td> </tr> <tr> <td>Flag</td> <td>VIN_OV_FAULT</td> <td>VIN_OV_WARNI NG</td> <td>VIN_UV_WARNI NG</td> <td>VIN_UV_FAULT</td> <td>X</td> <td>X</td> <td>X</td> <td>X</td> </tr> <tr> <td>Default Value</td> <td>0</td> <td>0</td> <td>0</td> <td>0</td> <td>0</td> <td>0</td> <td>0</td> <td>0</td> </tr> </table>	Format	Unsigned Binary								Bit Position	7	6	5	4	3	2	1	0	Access	r	r	r	r	r	r	r	r	Flag	VIN_OV_FAULT	VIN_OV_WARNI NG	VIN_UV_WARNI NG	VIN_UV_FAULT	X	X	X	X	Default Value	0	0	0	0	0	0	0	0	NO																																				
Format	Unsigned Binary																																																																																			
Bit Position	7	6	5	4	3	2	1	0																																																																												
Access	r	r	r	r	r	r	r	r																																																																												
Flag	VIN_OV_FAULT	VIN_OV_WARNI NG	VIN_UV_WARNI NG	VIN_UV_FAULT	X	X	X	X																																																																												
Default Value	0	0	0	0	0	0	0	0																																																																												
7D	STATUS_TEMPERATURE	<p>Returns one byte of information with the status of the module’s temperature related faults</p> <table border="1"> <tr> <td>Format</td> <td colspan="8">Unsigned Binary</td> </tr> <tr> <td>Bit Position</td> <td>7</td> <td>6</td> <td>5</td> <td>4</td> <td>3</td> <td>2</td> <td>1</td> <td>0</td> </tr> <tr> <td>Access</td> <td>r</td> <td>r</td> <td>r</td> <td>r</td> <td>r</td> <td>r</td> <td>r</td> <td>r</td> </tr> <tr> <td>Flag</td> <td>OT_FAULT</td> <td>OT_WARN</td> <td>X</td> <td>X</td> <td>X</td> <td>X</td> <td>X</td> <td>X</td> </tr> <tr> <td>Default Value</td> <td>0</td> <td>0</td> <td>0</td> <td>0</td> <td>0</td> <td>0</td> <td>0</td> <td>0</td> </tr> </table>	Format	Unsigned Binary								Bit Position	7	6	5	4	3	2	1	0	Access	r	r	r	r	r	r	r	r	Flag	OT_FAULT	OT_WARN	X	X	X	X	X	X	Default Value	0	0	0	0	0	0	0	0																																					
Format	Unsigned Binary																																																																																			
Bit Position	7	6	5	4	3	2	1	0																																																																												
Access	r	r	r	r	r	r	r	r																																																																												
Flag	OT_FAULT	OT_WARN	X	X	X	X	X	X																																																																												
Default Value	0	0	0	0	0	0	0	0																																																																												
7E	STATUS_CML	<p>Returns one byte of information with the status of the module’s communication related faults</p> <table border="1"> <tr> <td>Format</td> <td colspan="8">Unsigned Binary</td> </tr> <tr> <td>Bit Position</td> <td>7</td> <td>6</td> <td>5</td> <td>4</td> <td>3</td> <td>2</td> <td>1</td> <td>0</td> </tr> <tr> <td>Access</td> <td>r</td> <td>r</td> <td>r</td> <td>r</td> <td>r</td> <td>r</td> <td>r</td> <td>r</td> </tr> <tr> <td>Flag</td> <td>Invalid Command</td> <td>Invalid Data</td> <td>PEC Fail</td> <td>X</td> <td>X</td> <td>X</td> <td>Other Comm Fault</td> <td>X</td> </tr> <tr> <td>Default Value</td> <td>0</td> <td>0</td> <td>0</td> <td>0</td> <td>0</td> <td>0</td> <td>0</td> <td>0</td> </tr> </table>	Format	Unsigned Binary								Bit Position	7	6	5	4	3	2	1	0	Access	r	r	r	r	r	r	r	r	Flag	Invalid Command	Invalid Data	PEC Fail	X	X	X	Other Comm Fault	X	Default Value	0	0	0	0	0	0	0	0																																					
Format	Unsigned Binary																																																																																			
Bit Position	7	6	5	4	3	2	1	0																																																																												
Access	r	r	r	r	r	r	r	r																																																																												
Flag	Invalid Command	Invalid Data	PEC Fail	X	X	X	Other Comm Fault	X																																																																												
Default Value	0	0	0	0	0	0	0	0																																																																												
88	READ_VIN	<p>Returns the value of the input voltage applied to the module. Exponent is fixed at -6</p> <table border="1"> <tr> <td>Format</td> <td colspan="8">Linear, two’s complement binary</td> </tr> <tr> <td>Bit Position</td> <td>7</td> <td>6</td> <td>5</td> <td>4</td> <td>3</td> <td>2</td> <td>1</td> <td>0</td> </tr> <tr> <td>Access</td> <td>r</td> <td>r</td> <td>r</td> <td>r</td> <td>r</td> <td>r</td> <td>r</td> <td>r</td> </tr> <tr> <td>Function</td> <td colspan="4">Exponent</td> <td colspan="4">Mantissa</td> </tr> <tr> <td>Default Value</td> <td>1</td> <td>1</td> <td>0</td> <td>1</td> <td>0</td> <td>V</td> <td>V</td> <td>V</td> </tr> <tr> <td>Bit Position</td> <td>7</td> <td>6</td> <td>5</td> <td>4</td> <td>3</td> <td>2</td> <td>1</td> <td>0</td> </tr> <tr> <td>Access</td> <td>r</td> <td>r</td> <td>r</td> <td>r</td> <td>r</td> <td>r</td> <td>r</td> <td>r</td> </tr> <tr> <td>Function</td> <td colspan="8">Mantissa</td> </tr> <tr> <td>Default Value</td> <td>V</td> <td>V</td> <td>V</td> <td>V</td> <td>V</td> <td>V</td> <td>V</td> <td>V</td> </tr> </table>	Format	Linear, two’s complement binary								Bit Position	7	6	5	4	3	2	1	0	Access	r	r	r	r	r	r	r	r	Function	Exponent				Mantissa				Default Value	1	1	0	1	0	V	V	V	Bit Position	7	6	5	4	3	2	1	0	Access	r	r	r	r	r	r	r	r	Function	Mantissa								Default Value	V	V	V	V	V	V	V	V	
Format	Linear, two’s complement binary																																																																																			
Bit Position	7	6	5	4	3	2	1	0																																																																												
Access	r	r	r	r	r	r	r	r																																																																												
Function	Exponent				Mantissa																																																																															
Default Value	1	1	0	1	0	V	V	V																																																																												
Bit Position	7	6	5	4	3	2	1	0																																																																												
Access	r	r	r	r	r	r	r	r																																																																												
Function	Mantissa																																																																																			
Default Value	V	V	V	V	V	V	V	V																																																																												
8B	READ_VOUT	<p>Returns the value of the output voltage of the module. Exponent is fixed at -13</p> <table border="1"> <tr> <td>Format</td> <td colspan="8">Linear, two’s complement binary</td> </tr> <tr> <td>Bit Position</td> <td>7</td> <td>6</td> <td>5</td> <td>4</td> <td>3</td> <td>2</td> <td>1</td> <td>0</td> </tr> <tr> <td>Access</td> <td>r</td> <td>r</td> <td>r</td> <td>r</td> <td>r</td> <td>r</td> <td>r</td> <td>r</td> </tr> <tr> <td>Function</td> <td colspan="8">Mantissa</td> </tr> <tr> <td>Default Value</td> <td>V</td> <td>V</td> <td>V</td> <td>V</td> <td>V</td> <td>V</td> <td>V</td> <td>V</td> </tr> <tr> <td>Bit Position</td> <td>7</td> <td>6</td> <td>5</td> <td>4</td> <td>3</td> <td>2</td> <td>1</td> <td>0</td> </tr> <tr> <td>Access</td> <td>r</td> <td>r</td> <td>r</td> <td>r</td> <td>r</td> <td>r</td> <td>r</td> <td>R</td> </tr> <tr> <td>Function</td> <td colspan="8">Mantissa</td> </tr> <tr> <td>Default Value</td> <td>V</td> <td>V</td> <td>V</td> <td>V</td> <td>V</td> <td>V</td> <td>V</td> <td>V</td> </tr> </table>	Format	Linear, two’s complement binary								Bit Position	7	6	5	4	3	2	1	0	Access	r	r	r	r	r	r	r	r	Function	Mantissa								Default Value	V	V	V	V	V	V	V	V	Bit Position	7	6	5	4	3	2	1	0	Access	r	r	r	r	r	r	r	R	Function	Mantissa								Default Value	V	V	V	V	V	V	V	V	
Format	Linear, two’s complement binary																																																																																			
Bit Position	7	6	5	4	3	2	1	0																																																																												
Access	r	r	r	r	r	r	r	r																																																																												
Function	Mantissa																																																																																			
Default Value	V	V	V	V	V	V	V	V																																																																												
Bit Position	7	6	5	4	3	2	1	0																																																																												
Access	r	r	r	r	r	r	r	R																																																																												
Function	Mantissa																																																																																			
Default Value	V	V	V	V	V	V	V	V																																																																												

80A GigaDlynx™: Non-Isolated DC-DC Power Modules

4.5Vdc –14Vdc input; 0.6Vdc to 2.0Vdc output; 80A Output Current

Table 6 (continued)

Hex Code	Command	Brief Description	Non-Volatile Memory Storage	
8C	READ_IOUT	Returns the value of the output current of the module		
		Format		Linear, two's complement binary
		Bit Position		7 6 5 4 3 2 1 0
		Access		r r r r r r r r
		Function		Exponent Mantissa
		Default Value		1 1 1 0 0 V V V
		Bit Position		7 6 5 4 3 2 1 0
		Access		r r r r r r r R
		Function		Mantissa
Default Value	V V V V V V V V			
8D	READ_TEMPERATURE_1	Returns the module inductor temperature in °C		
		Format		Linear, two's complement binary
		Bit Position		7 6 5 4 3 2 1 0
		Access		r r r r r r r r
		Function		Exponent Mantissa
		Default Value		1 1 1 0 1 V V V
		Bit Position		7 6 5 4 3 2 1 0
		Access		r r r r r r r r
		Function		Mantissa
Default Value	V V V V V V V V			
8E	READ_TEMPERATURE_2	Returns the module PWM controller temperature in °C		
		Format		Linear, two's complement binary
		Bit Position		7 6 5 4 3 2 1 0
		Access		r r r r r r r r
		Function		Exponent Mantissa
		Default Value		1 1 1 0 1 V V V
		Bit Position		7 6 5 4 3 2 1 0
		Access		r r r r r r r r
		Function		Mantissa
Default Value	V V V V V V V V			
95	READ_FREQUENCY	Returns the switching Frequency of the converter. The Frequency is in Kilohertz and is read only, consisting of two bytes.		
		Format		Linear, two's complement binary
		Bit Position		7 6 5 4 3 2 1 0
		Access		r r r r r r r r
		Function		Exponent Mantissa
		Default Value		0 0 0 0 0 0 0 1
		Bit Position		7 6 5 4 3 2 1 0
		Access		r r r r r r r r
		Function		Mantissa
Default Value	1 0 0 1 0 0 0 0			
98	PMBUS_REVISION	Returns one byte indicating the module is compliant to PMBus Spec. 1.1 (read only)	YES	
		Format		Unsigned Binary
		Bit Position		7 6 5 4 3 2 1 0
		Default Value		0 0 1 0 0 0 1 0
A0	MFR_VIN_MIN	Returns the minimum input voltage the module is specified to operate at (read only)	YES	
		Format		Linear, two's complement binary
		Bit Position		7 6 5 4 3 2 1 0
		Access		r r r r r r r r
		Function		Exponent Mantissa
		Default Value		1 1 0 0 0 0 1 0
		Bit Position		7 6 5 4 3 2 1 0
		Access		r r r r r r r r
		Function		Mantissa
Default Value	0 1 1 0 0 1 1 0			

80A GigaDLynx™: Non-Isolated DC-DC Power Modules

4.5Vdc –14Vdc input; 0.6Vdc to 2.0Vdc output; 80A Output Current

Table 6 (continued)

Hex Code	Command	Brief Description	Non-Volatile Memory Storage	
A4	MFR_VOUT_MIN	Returns the minimum output voltage possible from the module (read only)	YES	
		Format		Linear, two's complement binary
		Bit Position		7 6 5 4 3 2 1 0
		Access		r r r r r r r r
		Function		Mantissa
		Default Value		1 0 1 0 0 0 1 1
		Bit Position		7 6 5 4 3 2 1 0
		Access		r r r r r r r r
		Function		Mantissa
Default Value	1 1 0 1 0 1 1 0			
D0	MFR_SPECIFIC_00	Returns module name information (read only)	YES	
		Format		Unsigned Binary
		Bit Position		7 6 5 4 3 2 1 0
		Access		r r r r r r r r
		Function		Reserved
		Default Value		0 0 0 0 0 0 0 0
		Bit Position		7 6 5 4 3 2 1 0
		Access		r r r r r r r r
		Function		Module Name Reserved
Default Value	0 0 1 0 1 0 0 0			
D1	MFR_SPECIFIC_01	Returns module information (read only)	YES	
		Format		Unsigned Binary
		Bit Position		7 6 5 4 3 2 1 0
		Access		r r r r r r r r
		Function		Module Name
		Default Value		0 1 0 1 0 0 1 0
		Bit Position		7 6 5 4 3 2 1 0
		Access		r r r r r r r r
		Function		Module Name
		Default Value		0 0 1 1 1 1 0 0
		Bit Position		7 6 5 4 3 2 1 0
		Access		r r r r r r r r
		Function		Module Name
		Default Value		0 0 0 0 0 1 1 0
		Bit Position		7 6 5 4 3 2 1 0
		Access		r r r r r r r r
		Function		Module Name
		Default Value		0 0 1 1 0 0 1 0
		Bit Position		7 6 5 4 3 2 1 0
		Access		r r r r r r r r
		Function		Module Name
		Default Value		0 0 1 1 0 0 0 0
		Bit Position		7 6 5 4 3 2 1 0
		Access		r r r r r r r r
		Function		Module Name
		Default Value		0 0 0 1 0 0 0 0
		Bit Position		7 6 5 4 3 2 1 0
		Access		r r r r r r r r
		Function		Module Name
		Default Value		0 0 0 0 0 1 1 0
		Bit Position		7 6 5 4 3 2 1 0
		Access		r r r r r r r r

80A GigaDlynx™: Non-Isolated DC-DC Power Modules

4.5Vdc –14Vdc input; 0.6Vdc to 2.0Vdc output; 80A Output Current

Table 6 (continued)

Hex Code	Command	Brief Description	Non-Volatile Memory Storage																																																																																	
DB	MFR_VOUT_MARGIN_HIGH	<p>Returns the target voltage for margining the output high. Exponent is fixed at -13.</p> <table border="1"> <tr> <td>Format</td> <td colspan="8">Linear, two's complement binary</td> </tr> <tr> <td>Bit Position</td> <td>7</td><td>6</td><td>5</td><td>4</td><td>3</td><td>2</td><td>1</td><td>0</td> </tr> <tr> <td>Access</td> <td>r</td><td>r</td><td>r</td><td>r</td><td>r</td><td>r</td><td>r</td><td>r</td> </tr> <tr> <td>Function</td> <td colspan="4">Exponent</td> <td colspan="4">Mantissa</td> </tr> <tr> <td>Default Value</td> <td>V</td><td>V</td><td>V</td><td>V</td><td>V</td><td>V</td><td>V</td><td>V</td> </tr> <tr> <td>Bit Position</td> <td>7</td><td>6</td><td>5</td><td>4</td><td>3</td><td>2</td><td>1</td><td>0</td> </tr> <tr> <td>Access</td> <td>r</td><td>r</td><td>r</td><td>r</td><td>r</td><td>r</td><td>r</td><td>R</td> </tr> <tr> <td>Function</td> <td colspan="8">Mantissa</td> </tr> <tr> <td>Default Value</td> <td>V</td><td>V</td><td>V</td><td>V</td><td>V</td><td>V</td><td>V</td><td>V</td> </tr> </table>	Format	Linear, two's complement binary								Bit Position	7	6	5	4	3	2	1	0	Access	r	r	r	r	r	r	r	r	Function	Exponent				Mantissa				Default Value	V	V	V	V	V	V	V	V	Bit Position	7	6	5	4	3	2	1	0	Access	r	r	r	r	r	r	r	R	Function	Mantissa								Default Value	V	V	V	V	V	V	V	V	YES
Format	Linear, two's complement binary																																																																																			
Bit Position	7	6	5	4	3	2	1	0																																																																												
Access	r	r	r	r	r	r	r	r																																																																												
Function	Exponent				Mantissa																																																																															
Default Value	V	V	V	V	V	V	V	V																																																																												
Bit Position	7	6	5	4	3	2	1	0																																																																												
Access	r	r	r	r	r	r	r	R																																																																												
Function	Mantissa																																																																																			
Default Value	V	V	V	V	V	V	V	V																																																																												
DC	MFR_VOUT_MARGIN_LOW	<p>Returns the target voltage for margining the output low. Exponent is fixed at -13</p> <table border="1"> <tr> <td>Format</td> <td colspan="8">Linear, two's complement binary</td> </tr> <tr> <td>Bit Position</td> <td>7</td><td>6</td><td>5</td><td>4</td><td>3</td><td>2</td><td>1</td><td>0</td> </tr> <tr> <td>Access</td> <td>r</td><td>r</td><td>r</td><td>r</td><td>r</td><td>r</td><td>r</td><td>r</td> </tr> <tr> <td>Function</td> <td colspan="8">Mantissa</td> </tr> <tr> <td>Default Value</td> <td>V</td><td>V</td><td>V</td><td>V</td><td>V</td><td>V</td><td>V</td><td>V</td> </tr> <tr> <td>Bit Position</td> <td>7</td><td>6</td><td>5</td><td>4</td><td>3</td><td>2</td><td>1</td><td>0</td> </tr> <tr> <td>Access</td> <td>r</td><td>r</td><td>r</td><td>r</td><td>r</td><td>r</td><td>r</td><td>r</td> </tr> <tr> <td>Function</td> <td colspan="8">Mantissa</td> </tr> <tr> <td>Default Value</td> <td>V</td><td>V</td><td>V</td><td>V</td><td>V</td><td>V</td><td>V</td><td>V</td> </tr> </table>	Format	Linear, two's complement binary								Bit Position	7	6	5	4	3	2	1	0	Access	r	r	r	r	r	r	r	r	Function	Mantissa								Default Value	V	V	V	V	V	V	V	V	Bit Position	7	6	5	4	3	2	1	0	Access	r	r	r	r	r	r	r	r	Function	Mantissa								Default Value	V	V	V	V	V	V	V	V	YES
Format	Linear, two's complement binary																																																																																			
Bit Position	7	6	5	4	3	2	1	0																																																																												
Access	r	r	r	r	r	r	r	r																																																																												
Function	Mantissa																																																																																			
Default Value	V	V	V	V	V	V	V	V																																																																												
Bit Position	7	6	5	4	3	2	1	0																																																																												
Access	r	r	r	r	r	r	r	r																																																																												
Function	Mantissa																																																																																			
Default Value	V	V	V	V	V	V	V	V																																																																												
DD	MFR_RTUNE_INDEX	<p>Returns the index derived from the resistor strapped to the RTUNE pin of the module.</p> <table border="1"> <tr> <td>Format</td> <td colspan="8">Unsigned Binary</td> </tr> <tr> <td>Bit Position</td> <td>7</td><td>6</td><td>5</td><td>4</td><td>3</td><td>2</td><td>1</td><td>0</td> </tr> <tr> <td>Access</td> <td>r</td><td>r</td><td>r</td><td>r</td><td>r</td><td>r</td><td>r</td><td>r</td> </tr> <tr> <td>Function</td> <td colspan="8">Reserved</td> </tr> <tr> <td>Default Value</td> <td>V</td><td>V</td><td>V</td><td>V</td><td>V</td><td>V</td><td>V</td><td>V</td> </tr> </table>	Format	Unsigned Binary								Bit Position	7	6	5	4	3	2	1	0	Access	r	r	r	r	r	r	r	r	Function	Reserved								Default Value	V	V	V	V	V	V	V	V	YES																																				
Format	Unsigned Binary																																																																																			
Bit Position	7	6	5	4	3	2	1	0																																																																												
Access	r	r	r	r	r	r	r	r																																																																												
Function	Reserved																																																																																			
Default Value	V	V	V	V	V	V	V	V																																																																												
DF	MFR_WRITE_PROTECT	<p>Gets or sets the write protection status of various PMBus commands. When a bit is set, the corresponding PMBus command is write protected and can only be read.</p> <table border="1"> <tr> <td>Format</td> <td colspan="8">Unsigned Binary</td> </tr> <tr> <td>Bit Position</td> <td>7</td><td>6</td><td>5</td><td>4</td><td>3</td><td>2</td><td>1</td><td>0</td> </tr> <tr> <td>Access</td> <td>r</td><td>r</td><td>r</td><td>r</td><td>r</td><td>r</td><td>r</td><td>r</td> </tr> <tr> <td>Function</td> <td colspan="8">Reserved</td> </tr> <tr> <td>Default Value</td> <td>0</td><td>0</td><td>0</td><td>0</td><td>0</td><td>0</td><td>0</td><td>1</td> </tr> <tr> <td>Bit Position</td> <td>15</td><td>14</td><td>13</td><td>12</td><td>11</td><td>10</td><td>9</td><td>8</td> </tr> <tr> <td>Access</td> <td>r</td><td>r</td><td>r</td><td>r</td><td>r</td><td>r</td><td>r</td><td>r</td> </tr> <tr> <td>Function</td> <td colspan="8">See Description Below</td> </tr> <tr> <td>Default Value</td> <td>1</td><td>1</td><td>1</td><td>1</td><td>1</td><td>1</td><td>1</td><td>1</td> </tr> </table> <p>Bit 0: ON_OFF_CONFIG Bit 1: IOUT_CAL command comprising both IOUT_CAL_GAIN and IOUT_CAL_OFFSET Bit 2: IOUT_OC_FAULT_LIMIT Bit 3: IOUT_OC_FAULT_RESPONSE Bit 4: OT_FAULT_LIMIT Bit 5: OT_FAULT_RESPONSE Bit 6: TOFF_MAX_WARN_LIMIT Bit 7: MFR_EXT_TEMP_CAL_OFFSET Bit 8: MFR_PHASE_CONTROL Bit 9: MFR_SPECIFIC_01</p>	Format	Unsigned Binary								Bit Position	7	6	5	4	3	2	1	0	Access	r	r	r	r	r	r	r	r	Function	Reserved								Default Value	0	0	0	0	0	0	0	1	Bit Position	15	14	13	12	11	10	9	8	Access	r	r	r	r	r	r	r	r	Function	See Description Below								Default Value	1	1	1	1	1	1	1	1	YES
Format	Unsigned Binary																																																																																			
Bit Position	7	6	5	4	3	2	1	0																																																																												
Access	r	r	r	r	r	r	r	r																																																																												
Function	Reserved																																																																																			
Default Value	0	0	0	0	0	0	0	1																																																																												
Bit Position	15	14	13	12	11	10	9	8																																																																												
Access	r	r	r	r	r	r	r	r																																																																												
Function	See Description Below																																																																																			
Default Value	1	1	1	1	1	1	1	1																																																																												
E0	MFR_VOUT_OFF	<p>Gets or sets the target output voltage when switching off the device, in volts. Setting a non-zero value here will enable shut-down into pre-bias.</p> <table border="1"> <tr> <td>Format</td> <td colspan="8">Linear, two's complement binary</td> </tr> <tr> <td>Bit Position</td> <td>7</td><td>6</td><td>5</td><td>4</td><td>3</td><td>2</td><td>1</td><td>0</td> </tr> <tr> <td>Access</td> <td>r</td><td>r</td><td>r</td><td>r</td><td>r</td><td>r</td><td>r/w</td><td>r</td> </tr> <tr> <td>Function</td> <td colspan="4">Exponent</td> <td colspan="4">Mantissa</td> </tr> <tr> <td>Default Value</td> <td>1</td><td>1</td><td>0</td><td>0</td><td>0</td><td>0</td><td>0</td><td>V</td> </tr> <tr> <td>Bit Position</td> <td>7</td><td>6</td><td>5</td><td>4</td><td>3</td><td>2</td><td>1</td><td>0</td> </tr> <tr> <td>Access</td> <td>r</td><td>r</td><td>r</td><td>r/w</td><td>r/w</td><td>r/w</td><td>r/w</td><td>r/w</td> </tr> <tr> <td>Function</td> <td colspan="8">Mantissa</td> </tr> <tr> <td>Default Value</td> <td>V</td><td>V</td><td>V</td><td>V</td><td>V</td><td>V</td><td>V</td><td>V</td> </tr> </table>	Format	Linear, two's complement binary								Bit Position	7	6	5	4	3	2	1	0	Access	r	r	r	r	r	r	r/w	r	Function	Exponent				Mantissa				Default Value	1	1	0	0	0	0	0	V	Bit Position	7	6	5	4	3	2	1	0	Access	r	r	r	r/w	r/w	r/w	r/w	r/w	Function	Mantissa								Default Value	V	V	V	V	V	V	V	V	YES
Format	Linear, two's complement binary																																																																																			
Bit Position	7	6	5	4	3	2	1	0																																																																												
Access	r	r	r	r	r	r	r/w	r																																																																												
Function	Exponent				Mantissa																																																																															
Default Value	1	1	0	0	0	0	0	V																																																																												
Bit Position	7	6	5	4	3	2	1	0																																																																												
Access	r	r	r	r/w	r/w	r/w	r/w	r/w																																																																												
Function	Mantissa																																																																																			
Default Value	V	V	V	V	V	V	V	V																																																																												

80A GigaDLynx™: Non-Isolated DC-DC Power Modules

4.5Vdc –14Vdc input; 0.6Vdc to 2.0Vdc output; 80A Output Current

Table 6 (continued)

Hex Code	Command	Brief Description	Non-Volatile Memory Storage	
E7	MFR_FEATURES_CONTROL	Allows user to enable/disable VTRACK and SYNC feature of the module.	YES	
		Format		Unsigned Binary
		Bit Position		7 6 5 4 3 2 1 0
		Access		r r r r r/w r/w r/w r/w
		Function		Reserved
		Default Value		0 0 0 0 0 0 0 0
		Bit Position		15 14 13 12 11 10 9 8
		Access		r r r r r r r r
		Function		See Description Below
		Default Value		0 0 0 0 0 0 0 0
Bit 0: VTRACK ENABLE, 0 = Disabled; 1 = Enabled Bit 1: SYNC ENABLE, 0 = Disabled; 1 = Enabled Bit 2: SYNC IN/OUT, 0 = Sync signal input; 1 = Sync Signal Output Bit 3: SYNC Edge, 0 = Rising Edge				

Digital Power Insight (DPI)

GE offers a software tool that set helps users evaluate and simulate the PMBus performance of the GDT080 modules without the need to write software.

The software can be downloaded for free at <http://go.ge-energy.com/DigitalPowerInsight.html>. A GE USB to I2C adapter and associated cable set are required for proper functioning of the software suite. For first time users, the GE DPI Evaluation Kit can be purchased from leading distributors at a nominal price and can be used across the entire range of GE Digital POL Module.

80A GigaDLynx™: Non-Isolated DC-DC Power Modules

4.5Vdc –14Vdc input; 0.6Vdc to 2.0Vdc output; 80A Output Current

Thermal Considerations

Power modules operate in a variety of thermal environments; however, sufficient cooling should always be provided to help ensure reliable operation.

Considerations include ambient temperature, airflow, module power dissipation, and the need for increased reliability. A reduction in the operating temperature of the module will result in an increase in reliability. The thermal data presented here is based on physical measurements taken in a wind tunnel. The test set-up is shown in Figure 38. The preferred airflow direction for the module is shown in Figure 39.

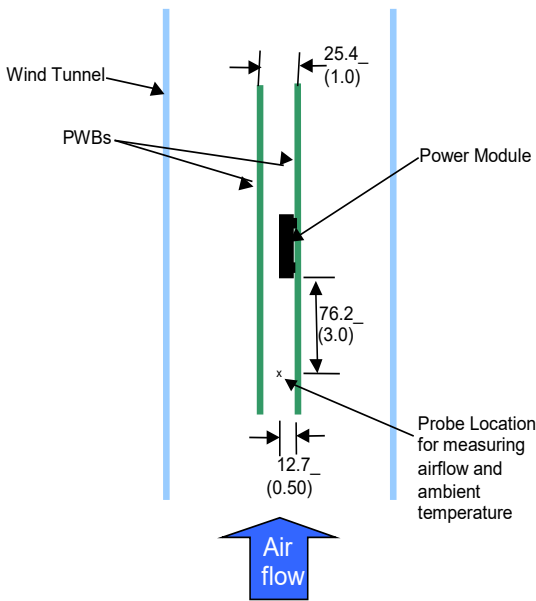

Figure 38. Thermal Test Setup.

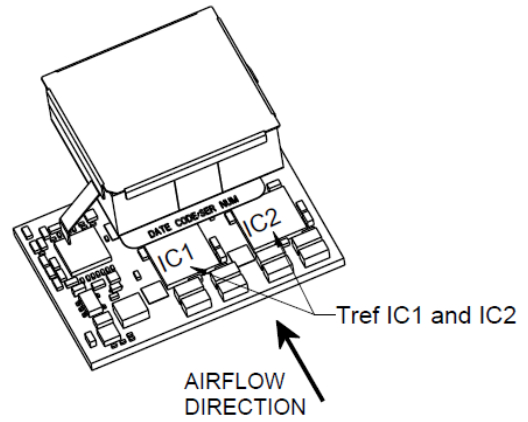

Figure 39. Preferred airflow direction and location of hot-spot of the module (Tref).

The thermal reference points, T_{ref} used in the specifications are also shown in Figure 39. For reliable operation the temperatures at these points should not exceed 120°C. The output power of the module should not exceed the rated power of the module ($V_{o,set} \times I_{o,max}$).

Please refer to the Application Note “Thermal Characterization Process For Open-Frame Board-Mounted Power Modules” for a detailed discussion of thermal aspects including maximum device temperatures.

80A GigaDLynx™: Non-Isolated DC-DC Power Modules

4.5Vdc –14Vdc input; 0.6Vdc to 2.0Vdc output; 80A Output Current

Example Application Circuit

Requirements:

- Vin:** 12V
- Vout:** 1.2V
- Iout:** 80A max., worst case load transient is from 20A to 60A
- ΔVout:** 1.5% of Vout (18mV) for worst case load transient
- Vin, ripple:** 2% of Vin (220mV p-p)

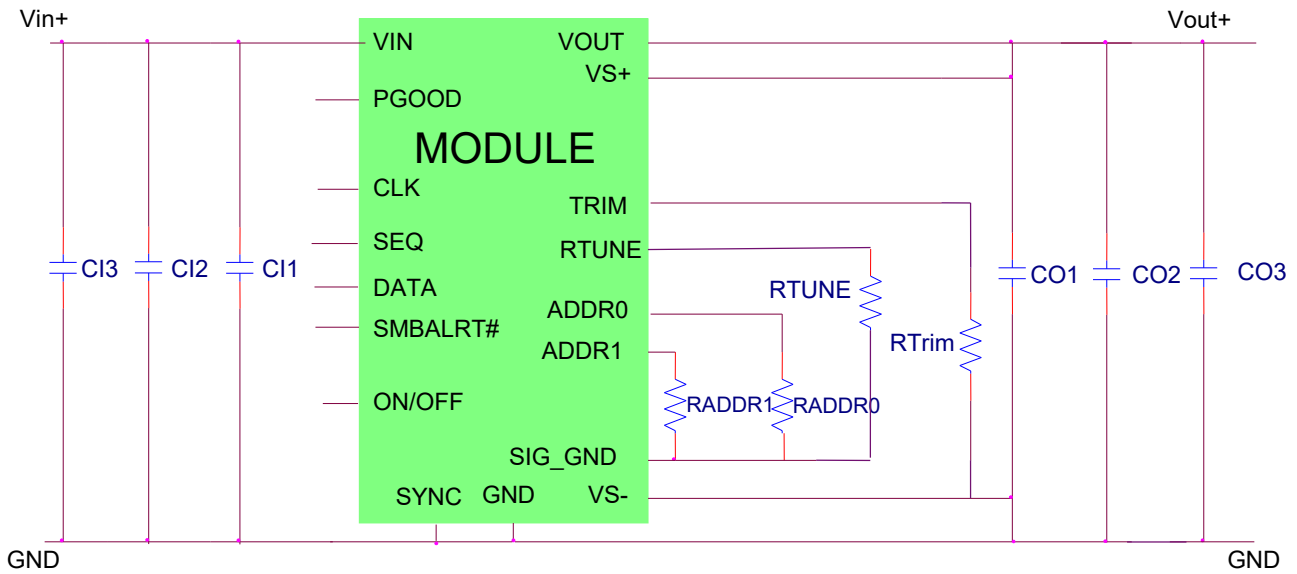

- C11 Decoupling cap - 1x0.1μF/16V ceramic capacitor (e.g. Murata LLA215R71A224MA14)
- C12 6x22μF/16V ceramic capacitor (e.g. Murata GRM32ER61C226KE20)
- C13 470μF/16V bulk electrolytic
- CO1 Decoupling cap - 1x0.047μF/16V ceramic capacitor (e.g. Murata LLA215R71A224MA14)
- CO2 6 x 47μF/6.3V ceramic capacitor (e.g. Murata GRM31CR60J476ME19)
- CO3 5 x 1000μF/2.5V Polymer (e.g. Sanyo Poscap)
- RTune 4.22kohms SMT resistor (can be 1206, 0805 or 0603 size)
- RTrim 2kΩ SMT resistor (can be 1206, 0805 or 0603 size, recommended tolerance of 0.1%)

80A GigaDLynx™: Non-Isolated DC-DC Power Modules

4.5Vdc –14Vdc input; 0.6Vdc to 2.0Vdc output; 80A Output Current

Mechanical Outline

Dimensions are in millimeters and (inches).

Tolerances: x.x mm ± 0.5 mm (x.xx in. ± 0.02 in.) [unless otherwise indicated]

x.xx mm ± 0.25 mm (x.xxx in ± 0.010 in.)

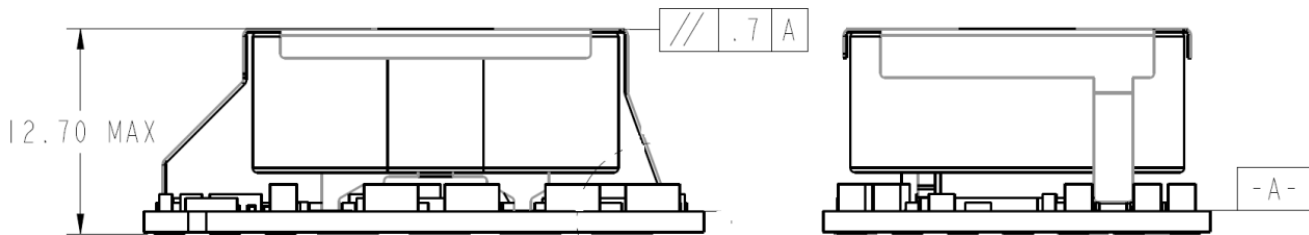
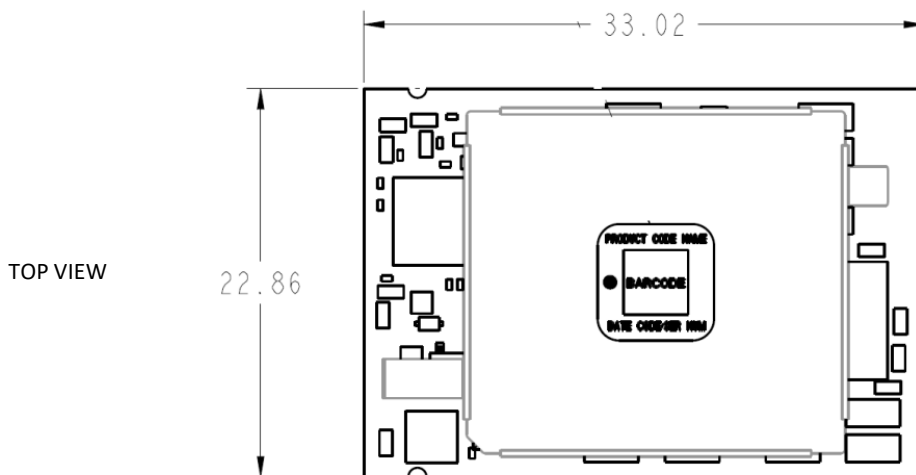

SIDE VIEWS

80A GigaDlynx™: Non-Isolated DC-DC Power Modules

4.5Vdc –14Vdc input; 0.6Vdc to 2.0Vdc output; 80A Output Current

Recommended Pad Layout

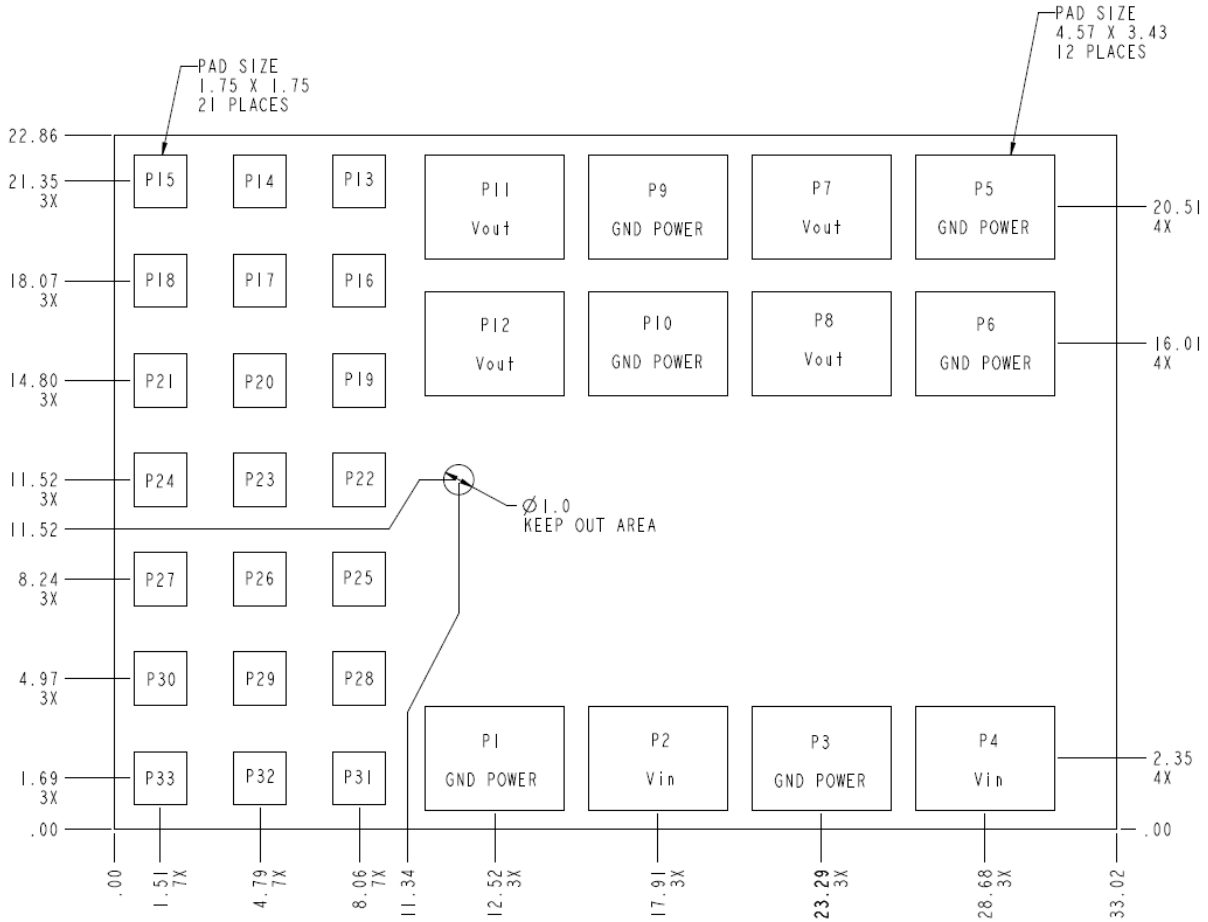

Pinout Details

PIN	FUNCTION	PIN	FUNCTION	PIN	FUNCTION
1	GND	15	SEQ	29	SMBALERT#
2	VIN	16	VS+	30	NC
3	GND	17	SIG_GND	31	NC
4	VIN	18	NC	32	NC
5	GND	19	PGOOD	33	NC
6	GND	20	ADDR0		
7	VOUT	21	NC		
8	VOUT	22	SYNC		
9	GND	23	ADDR1		
10	GND	24	RTUNE		
11	VOUT	25	ON/OFF		
12	VOUT	26	CLK		
13	VS-	27	NC		
14	TRIM	28	DATA		

80A GigaDlynx™: Non-Isolated DC-DC Power Modules

4.5Vdc –14Vdc input; 0.6Vdc to 2.0Vdc output; 80A Output Current

Packaging Details

The 80A GigaDlynx™ 80A modules are supplied in tape & reel as standard. Modules are shipped in quantities of 80 modules per reel. All Dimensions are in millimeters and (in inches).

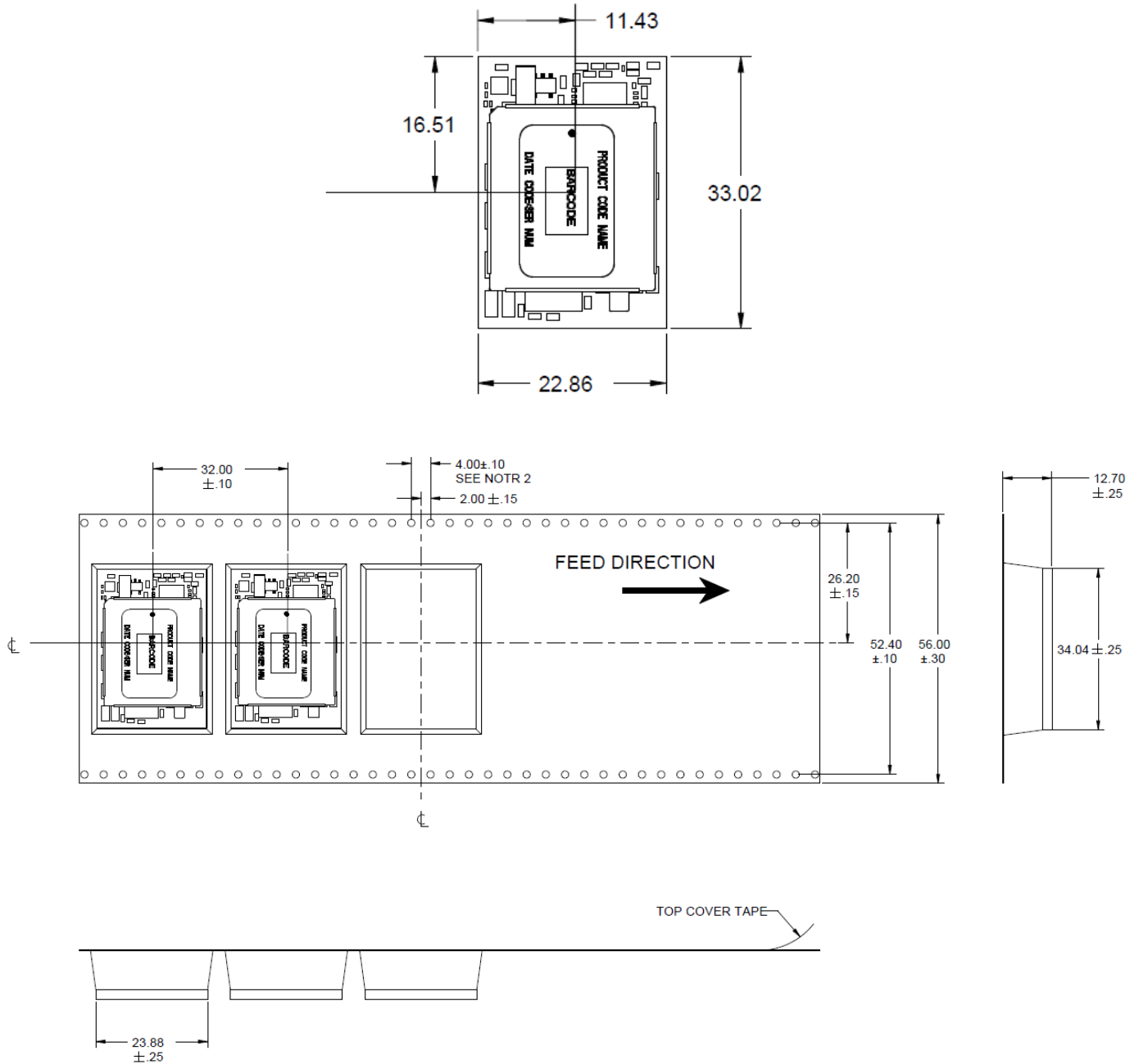

- Reel Dimensions :
- Outside Dimensions : 330.2 mm (13.00)
 - Inside Dimensions : 177.8 mm (7.00")
 - Tape Width: 56.00 mm (2.205")

Surface Mount Information

80A GigaDLynx™: Non-Isolated DC-DC Power Modules

4.5Vdc –14Vdc input; 0.6Vdc to 2.0Vdc output; 80A Output Current

Pick and Place

The 80A GigaDLynx™ modules use an open frame construction and are designed for a fully automated assembly process. The modules are fitted with a label designed to provide a large surface area for pick and place operations. The label meets all the requirements for surface mount processing, as well as safety standards, and is able to withstand reflow temperatures of up to 300°C. The label also carries product information such as product code, serial number and the location of manufacture.

Nozzle Recommendations

The module weight has been kept to a minimum by using open frame construction. Variables such as nozzle size, tip style, vacuum pressure and placement speed should be considered to optimize this process. The minimum recommended inside nozzle diameter for reliable operation is 10mm. The maximum nozzle outer diameter, which will safely fit within the allowable component spacing, is 17 mm.

Bottom Side / First Side Assembly

This module is not recommended for assembly on the bottom side of a customer board. If such an assembly is attempted, components may fall off the module during the second reflow process.

Lead Free Soldering

The modules are lead-free (Pb-free) and RoHS compliant and fully compatible in a Pb-free soldering process. Failure to observe the instructions below may result in the failure of or cause damage to the modules and can adversely affect long-term reliability.

Pb-free Reflow Profile

Power Systems will comply with J-STD-020 Rev. C (Moisture/Reflow Sensitivity Classification for Nonhermetic Solid State Surface Mount Devices) for both Pb-free solder profiles and MSL classification procedures. This standard provides a recommended forced-air-convection reflow profile based on the volume and thickness of the package (table 4-2). The suggested Pb-free solder paste is Sn/Ag/Cu (SAC). The recommended linear reflow profile using Sn/Ag/Cu solder is shown in Fig. 40. Soldering outside of the recommended profile requires testing to verify results and performance.

Ordering Information

Please contact your GE Sales Representative for pricing, availability and optional features.

Table 7. Device Codes

Device Code	Input Voltage Range	Output Voltage	Output Current	On/Off Logic	Sequencing	Comcodes
GDT080A0X3-SRZ	4.5 – 14Vdc	0.6 – 2.0 Vdc	80A	Negative	Yes	150037110
GDT080A0X43-SRZ	4.5 – 14Vdc	0.6 – 2.0 Vdc	80A	Positive	Yes	150044134

-Z refers to RoHS compliant parts

MSL Rating

The 80A GigaDLynx™ modules have a MSL rating of 3.

Storage and Handling

The recommended storage environment and handling procedures for moisture-sensitive surface mount packages is detailed in J-STD-033 Rev. A (Handling, Packing, Shipping and Use of Moisture/Reflow Sensitive Surface Mount Devices). Moisture barrier bags (MBB) with desiccant are required for MSL ratings of 2 or greater. These sealed packages should not be broken until time of use. Once the original package is broken, the floor life of the product at conditions of ≤ 30°C and 60% relative humidity varies according to the MSL rating (see J-STD-033A). The shelf life for dry packed SMT packages will be a minimum of 12 months from the bag seal date, when stored at the following conditions: < 40° C, < 90% relative humidity.

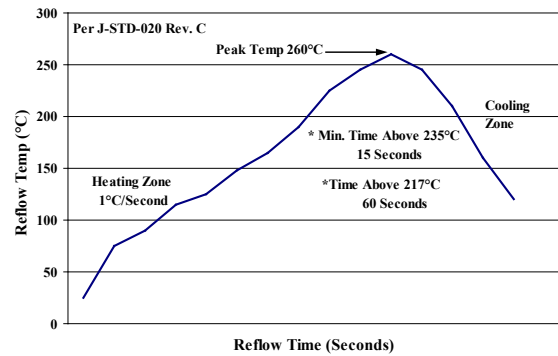

Figure 40. Recommended linear reflow profile using Sn/Ag/Cu solder.

Post Solder Cleaning and Drying Considerations

Post solder cleaning is usually the final circuit-board assembly process prior to electrical board testing. The result of inadequate cleaning and drying can affect both the reliability of a power module and the testability of the finished circuit-board assembly. For guidance on appropriate soldering, cleaning and drying procedures, refer to *Board Mounted Power Modules: Soldering and Cleaning Application Note (AN04-001)*.

80A GigaDLynx™: Non-Isolated DC-DC Power Modules

4.5Vdc –14Vdc input; 0.6Vdc to 2.0Vdc output; 80A Output Current

Table 8. Coding Scheme

Package Identifier	Family	Sequencing Option	Output current	Output voltage	On/Off logic	Remote Sense	Options		ROHS Compliance
G	D	T	080A0	X		3	-SR	-H	Z
P=Pico U=Micro M=Mega G=Giga	D=Dlynx Digital V = DLynx Analog.	T=with EZ Sequence X=without sequencing	80A	X = programmable output	4 = positive No entry = negative	3 = Remote Sense	S = Surface Mount R = Tape & Reel	Extra Ground Pins	Z = ROHS6

ABB Power Electronics Inc.'s digital non-isolated DC-DC products may be covered by one or more of the following patents licensed from Bel Power Solutions, Inc.: US20040246754, US2004090219A1, US2004093533A1, US2004123164A1, US2004123167A1, US2004178780A1, US2004179382A1, US20050200344, US20050223252, US2005289373A1, US20060061214, US2006015616A1, US20060174145, US20070226526, US20070234095, US20070240000, US20080052551, US20080072080, US20080186006, US6741099, US6788036, US6936999, US6949916, US7000125, US7049798, US7068021, US7080265, US7249267, US7266709, US7315156, US7372682, US7373527, US7394445, US7456617, US7459892, US7493504, US7526660.

Outside the US Bel Power Solutions, Inc. licensed technology is protected by patents: AU3287379AA, AU3287437AA, AU3290643AA, AU3291357AA, CN10371856C, CN10452610C, CN10458656C, CN10459360C, CN10465848C, CN11069332A, CN11124619A, CN11346682A, CN1685299A, CN1685459A, CN1685582A, CN1685583A, CN1698023A, CN1802619A, EP1561156A1, EP1561268A2, EP1576710A1, EP1576711A1, EP1604254A4, EP1604264A4, EP1714369A2, EP1745536A4, EP1769382A4, EP1899789A2, EP1984801A2, W004044718A1, W004045042A3, W004045042C1, W004062061A1, W004062062A1, W004070780A3, W004084390A3, W004084391A3, W005079227A3, W005081771A3, W006019569A3, W02007001584A3, W02007094935A3

Contact Us

For more information, call us at

USA/Canada:

+1 888 546 3243, or +1 972 244 9288

Asia-Pacific:

+86-21-53899666

Europe, Middle-East and Africa:

+49.89.878067-280

[Go.ABB/Industrial](#)



GE Critical Power reserves the right to make changes to the product(s) or information contained herein without notice, and no liability is assumed as a result of their use or application. No rights under any patent accompany the sale of any such product(s) or information.

X-ON Electronics

Largest Supplier of Electrical and Electronic Components

Click to view similar products for [Non-Isolated DC/DC Converters](#) category:

Click to view products by [ABB](#) manufacturer:

Other Similar products are found below :

[PSR152.5-7IR](#) [APTH003A0X-SRZ](#) [SPM1004-3V3C](#) [R-785.0-05](#) [10E24-P15-10PPM](#) [1E24-P4-25PPM-SHV-5KV](#) [CA-17205-L4](#)
[PROPOWER-3.3V](#) [MYGTM01210BZN](#) [JRCS016A0S4-HZ](#) [3V12-N0.8](#) [6AA24-P30-I5-M](#) [BM2P101X-Z](#) [ROF-78E12-0.5SMD-R](#)
[RPMA5.0-8.0/OF](#) [RPX-4.0-CT](#) [PTV03010WAD](#) [PTV05020WAH](#) [PTV12010LAH](#) [PTV12020WAD](#) [R-7212D](#) [R-7212P](#) [R-78AA5.0-](#)
[1.0SMD](#) [30A24-N15-E](#) [10A12-P4-M](#) [10C24-N250-I5](#) [10C24-P125](#) [10C24-P250-I5](#) [6A24-P20-I10-F-M-25PPM](#) [1A24-P30-F-M-C](#) [TSR 1-](#)
[24150SM](#) [1/2AA24-N30-I10](#) [1C24-N125](#) [12C24-N250](#) [V7806-1500](#) [PTV12020LAH](#) [PTV05010WAH](#) [PTN04050CAZT](#) [PTH12020WAD](#)
[PTH12020LAS](#) [PTH05T210WAH](#) [PTH05030WAZ](#) [V7803-2000R](#) [AXA005A0XZ](#) [NSR020A0X43Z](#) [TPS82677SIPR](#) [OKR-T/30-W12-C](#)
[NID30S24-15](#) [NID30S48-24](#) [LXDC2HL25A-053](#)