

MPR0854FP series front-end

Input: 100-120/200-240V_{AC}; Output: 54V_{DC} @ 800W; 12V_{DC} @ 0.8A

RoHS Compliant

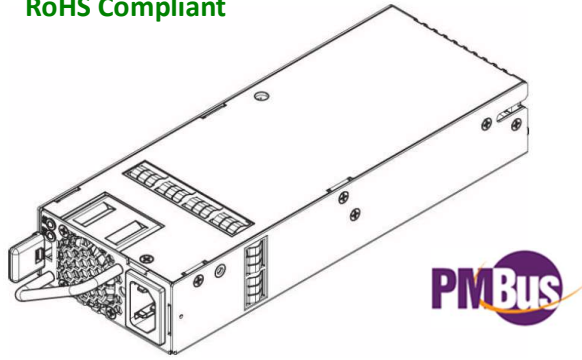

Applications

- 48V_{DC} distributed power architectures
- Datacom and Telecom applications
- Mid to high-end Servers
- Enterprise Networking
- Network Attached Storage
- Telecom Access Nodes
- Routers/Switches
- ATE Equipment

Description

The MPR0854FP series of front ends provide efficient isolated power from world-wide commercial AC mains. Offered in the industry standard compact 1U form factor, these front ends provide comprehensive solutions for systems connected to commercial ac mains.

This high-density front end can be ordered either as a front-to-back or back-to-front airflow product. It is designed for minimal space utilization and is highly expandable for future growth. The industry standard PMBus compliant I²C communications bus offers a full range of control and monitoring capabilities.

Features

- Output voltage set to 54V_{DC}
- Universal input with PFC
- No power de-rating at low line input range
- 2 front panel LEDs: LED1-input
LED2 - [output, fault, over temp]
- Remote ON/OFF control of the 54V_{DC} output
- Remote sense on the 54V_{DC} output
- Meets Power-Over-Ethernet (IEEE802.3af)
- No minimum load requirements
- Droop load sharing
- Hot Plug-able
- Efficiency: typically 92.5% @ 50% load
and 90.0% @ 20% load
- 12V_{DC} for backup power
- Auto recoverable OC & OT protection
- Radiated emissions hardened enclosure
- Operating temperature: -10 - 70°C (de-rated above 50°C)
- Digital status & control: PMBus™ compliant serial bus
- EN/IEC/UL60950-1 2nd edition; UL, CSA and VDE
- EMI: class A FCC docket 20780 part 15, EN55022
- Meets EN6100 immunity and transient standards
- Shock & vibration: IEC-68-2

* UL is a registered trademark of Underwriters Laboratories, Inc.

† CSA is a registered trademark of Canadian Standards Association.

‡ VDE is a trademark of Verband Deutscher Elektrotechniker e.V.

§ Intended for integration into end-user equipment. All the required procedures for CE marking of end-user equipment should be followed. (The CE mark is placed on selected products.)

** ISO is a registered trademark of the International Organization of Standards.

+ PMBus name and logo are registered trademarks of the System Management Interface Forum (SMIF)

MPR0854FP series rectifier

Input: 100-120/200-240V_{AC}; Output: 54V_{DC} @ 800W; 12V_{DC} @ 0.8A

Absolute Maximum Ratings

Stresses in excess of the absolute maximum ratings can cause permanent damage to the device. These are absolute stress ratings only, functional operation of the device is not implied at these or any other conditions in excess of those given in the operations sections of the Technical Requirement. Exposure to absolute maximum ratings for extended periods can adversely affect the device reliability.

Parameter	Symbol	Min	Max	Unit
Input Voltage: Continuous	V _{IN}	0	264	V _{AC}
Operating Ambient Temperature	T _A	-10	70 ¹	°C
Storage Temperature	T _{stg}	-40	85	°C
I/O Isolation voltage to Frame (100% factory Hi-Pot tested)			1500	V _{AC}

Electrical Specifications

Unless otherwise indicated, specifications apply over all operating input voltage, load, and temperature conditions.

INPUT					
Parameter	Symbol	Min	Typ	Max	Unit
Operational Range	V _{IN}	90	110/230	264	V _{AC}
Frequency Range	F _{IN}	47	50/60	63	Hz
Main Output Turn_OFF	V _{IN}	68		75	V _{AC}
Main Output Turn_ON	V _{IN}	76		84	V _{AC}
Maximum Input Current (V _{OUT} = 54V _{DC} , I _{OUT} =14.8A)	V _{IN} = 100V _{AC}	I _{IN}		9.2	A _{AC}
	V _{IN} = 200V _{AC}			4.6	
Cold Start Inrush Current (Excluding x-caps, 25°C) duration	I _{IN}			30	A _{PEAK} cycle
				½	
Efficiency (T _{AMB} =25°C, V _{OUT} = 54V _{DC} , I _O = 14.8A) input	η	100 - 240			V _{IN}
		100% load	88		
		75% load	87		
		50% load	84		
		20% load	77		
Power Factor (V _{in} =90 - 264V _{AC} , I _{OUT} = 14.8A)	PF	0.8	0.99		
Holdup time (V _{IN} = 90V _{AC} , T _{AMB} 25°C, V _{OUT} = 54V _{DC} , I _{OUT} = 14.8A)	T	10			ms
Power Fail Warning (AC_OK_L) Assertion delay ² Start of assertion ³	T	10			ms
		5			ms
Level of voltage decay	V _{DC}	43			V _{DC}
Leakage Current (V _{IN} = 264V _{AC} , F _{IN} = 60Hz)	I _{IN}			3.5	mA
Isolation Input/Output Input/Frame Main output or main_rtn/Frame 3.3V _{STDBY} or 12V /main output	V _{AC}	3000			V _{AC}
		1500			V _{AC}
	V _{DC}	2121			V _{DC}
		2121			V _{DC}

¹ Derated above 50°C at 2.5%/°C

² PFW does not trigger for power interruptions lasting less than 10ms (½ cycle)

³ The signal shall assert at least 5ms prior to decaying of the output voltage below 43V_{DC}

MPR0854FP series rectifier

Input: 100-120/200-240V_{AC}; Output: 54V_{DC} @ 800W; 12V_{DC} @ 0.8A

54V _{DC} MAIN OUTPUT					
Parameter	Symbol	Min	Typ	Max	Unit
Output Power	W	0	-	800	W
Regulation Set point (V _{IN} = 100V _{AC} , T _{AMB} 25°C, I _{OUT} = 7.4A) Temperature drift Overall regulation (line, load, temperature) Maximum remote sense voltage drop	V _{OUT}	53.95	54.00	54.05	V _{DC}
				0.01	%/°C
		-5		+5	%
				0.5	V _{DC}
Ripple and noise ⁴ (meets IEEE802.3af for POE) f < 500kHz f = 500 – 150kHz f = 150kHz – 500kHz f = 500kHz – 1MHz	V _{OUT}			600	mV _{P-P}
				200	
				150	
				100	
Turn-ON or turn-OFF overshoot				+0	%
Turn-ON delay to within regulation	T			3	sec
Remote ON/OFF delay time			40		ms
Turn-ON monotonic rise time (10 – 90% of V _{OUT})			150		ms
Transient response 25% step [10%-35%, 100% - 75%] (di/dt – 1A/μs, recovery to within 2% of nominal in 500μs)	V _{OUT}	-5		+5	%V _{OUT}
Oversvoltage protection, latched (recovery by cycling OFF/ON via hardware or software)		57.5		60	V _{DC}
Output current	I _{OUT}	0		14.8	A _{DC}
Current limit, Foldback		16		20	A _{DC}
Droop current share (linear from no-load to full-load) Permissible load difference between power supplies	Output voltage at 0 load		55.62		V _{DC}
	Output voltage at 14,8A load		52.38		
					3

12V _{DC} Back-bias OUTPUT					
Parameter	Symbol	Min	Typ	Max	Unit
Set point	V _{OUT}		12		V _{DC}
Overall regulation (load, temperature, aging) with	V _{OUT}	8.5		13	V
Ripple and noise			0.29	0.65	V _{rms}
Output current	I _{OUT}	0		0.5	A _{DC}
Isolation Output/Frame		100			V _{DC}

General Specifications

Parameter	Min	Typ	Max	Units	Notes
Reliability		300,000 100,000		hrs	Full load, 25°C per Bellcore RPP Full load, 50°C per Bellcore RPP
Service Life		10		Yrs	Full load, excluding fans
Weight		1.09 (2.4)	1.4(3.1)	Kgs (Lbs)	

Feature Specifications

Unless otherwise indicated, specifications apply over all operating input voltage, resistive load, and temperature conditions. All signals are referenced to Signal_Return unless otherwise noted. See Feature Descriptions for additional information. (I_{OL} < 5mA, I_{OH} < 20μA)

Parameter	Symbol	Min	Typ	Max	Unit
MODULE_ENABLE_L [short pin controlling presence of the 54V _{DC} output]					
54V output OFF	V _i	0.7V _{DD}	—	5	V _{DC}
54V output ON	V _i	0	—	0.8	V _{DC}

⁴ Measured across a 10μf electrolytic and a 0.1μf ceramic capacitors in parallel. 20MHz bandwidth

MPR0854FP series rectifier

Input: 100-120/200-240V_{AC}; Output: 54V_{DC} @ 800W; 12V_{DC} @ 0.8A

Feature specifications (continued)					
Parameter	Symbol	Min	Typ	Max	Unit
AC_OK_L [PFW] (Needs to be pulled HI via an external resistor)					
Logic HI (Input out-of-normal range)	V _{OH}	0.7V _{DD}	—	5	V _{DC}
Logic LO (Input within normal range)	V _{OL}	0	—	0.4	V _{DC}
DC_OK_L (Needs to be pulled HI via an external resistor)					
Logic HI	V _{OH}	0.7V _{DD}	—	5	V _{DC}
Output voltage is not within limits Level shift for out of limits (V _{OUT} transitioning low)		47		51	V _{DC}
Logic LO	V _{OL}	0	—	0.4	V _{DC}
Output voltage is within limits Level shift for within limits (V _{OUT} transitioning high)		51		52	V _{DC}
TEMP_OK_L (Needs to be pulled HI via an external resistor)					
Logic HI (temperature is too high)	V _{OH}	0.7V _{DD}	—	5	V _{DC}
Logic LO (temperature within normal range)	V _{OL}	0	—	0.4	V _{DC}
Delayed shutdown after Logic HI transition	T _{delay}	150			ms
PS_Present_L (Needs to be pulled HI via an external resistor)					
Logic LO	V _{IL}	0	—	0.1	V _{DC}
Module_Enable_L					
Logic LO (normally connected to Signal_Return in the system)	V _{IL}	0	—	0.1	V _{DC}
I²C address signals A0, A1, A2 (internally pulled HI)					
Logic LO	V _{IL}	0	—	0.1	V _{DC}
I²C Clock and Data Lines (internally pulled up to 3.3V _{DC} via 1.2k Ω)					
Logic HI	V _{OH}	0.7V _{DD}	—	3.3	V _{DC}
Logic LO (Data line sync by the power supply)	V _{OL}	0	—	0.4	V _{DC}
Logic LO (interpreted by the power supply)	V _{OL}	0	—	0.8	V _{DC}

Digital Interface Specifications

Parameter	Conditions	Symbol	Min	Typ	Max	Unit
PMBus Signal Interface Characteristics						
Input Logic High Voltage (CLK, DATA)		V _{IH}	2.1		3.6	V _{DC}
Input Logic Low Voltage (CLK, DATA)		V _{IL}	0		0.8	V _{DC}
Input high sourced current (CLK, DATA)		I _{IH}	0		10	μ A
Output Low sink Voltage (CLK, DATA)	I _{OUT} =3.5mA	V _{OL}			0.4	V _{DC}
Output Low sink current (CLK, DATA)		I _{OL}	3.5			mA
Output High open drain leakage current (CLK, DATA)	V _{OUT} =3.6V	I _{OH}	0		10	μ A
PMBus Operating frequency range	Slave Mode	F _{PMB}	10		400	kHz
Measurement System Characteristics (all measurement tolerances are typical estimations under normal operating conditions)						
Clock stretching		t _{STRETCH}			25	ms
I _{OUT} measurement range	Linear	I _{RNG}	0		25	A _{DC}
I _{OUT} measurement accuracy 25°C		I _{ACC}	-3		+3	%
V _{OUT} measurement range	Linear	V _{OUT(rng)}	0		75	V _{DC}
V _{OUT} measurement accuracy		V _{OUT(acc)}	-2		+2	%
Temp measurement range	Linear	Temp _(rng)	0		120	°C

MPR0854FP series rectifier

Input: 100-120/200-240V_{AC}; Output: 54V_{DC} @ 800W; 12V_{DC} @ 0.8A

Temp measurement accuracy ⁵		Temp _(acc)	-5		+5	%
Digital Interface Specifications (continued)						
Parameter	Conditions	Symbol	Min	Typ	Max	Unit
Fan Speed measurement range	Linear		0		30k	RPM
Fan Speed measurement accuracy			-2		2	%

Environmental Specifications

Parameter	Min	Typ	Max	Units	Notes
Ambient Temperature	0		50	°C	
Storage Temperature	-40		85	°C	
Operating Altitude			1524/5000	m/ft	
Non-operating Altitude			15240/50k	m / ft	
Power Derating with Altitude			2.0	°C/301 m °C/1000 ft	
Acoustic noise			55	dbA	25°C and Full load
OT (TEMP_OK_L) Warning Protection Recovery hysteresis	150			ms	Prior to shutdown
		110 ⁶		°C	Default: Auto-recoverable
		5		°C	
Humidity Operating Storage	5		95	%	Relative humidity, non-condensing
	5		95		
Vibration			0.2	G	IEC 68-2-6, 5-500Hz
Shock			10	G	IEC 68-2-27, 10ms intervals 3 shocks per axis

EMC Compliance

Parameter	Criteria	Standard	Level	Test
AC input	Conducted emissions	FCC and CISPR (EN55022A, VCCI-2)	A +6dB	0.15 – 30MHz
Radiated emissions		EN55022	A +6dB	30 – 10000MHz
Harmonic current	Emissions	EN-61000-3-2	Table 1	
Voltage	Fluctuations & Flicker	En-61000-3-3		
AC Input immunity	Voltage dips	EN61000-4-11	A	-30%, 10ms
			B	-60%, 100ms
			B	-100%, 5sec
	Voltage surge	EN61000-4-5	A	2kV, 1.2/50µs, common mode
			A	1kV, 1.2/50µs, differential mode
Fast transients	EN61000-4-4	B	±0.5kV on data lines, ±1kV on power lines, 5kHz rate	
Enclosure immunity	Conducted RF fields	EN61000-4-6	A	130dBµV, 0.15-80MHz, 80% AM

⁵ Temperature accuracy reduces non-linearly with decreasing temperature

⁶ Designed such that device junction thresholds do not exceed 110°C under normal operating conditions

MPR0854FP series rectifier

Input: 100-120/200-240V_{AC}; Output: 54V_{DC} @ 800W; 12V_{DC} @ 0.8A

	Radiated RF fields	EN61000-4-3	A	3V/m, 80-1000MHz, 80% AM
		ENV 50140	A	
	ESD	EN61000-4-2	B	±4kV contact, ±8kV air

Characteristic Curves

The following figures provide typical characteristics at 25°C.

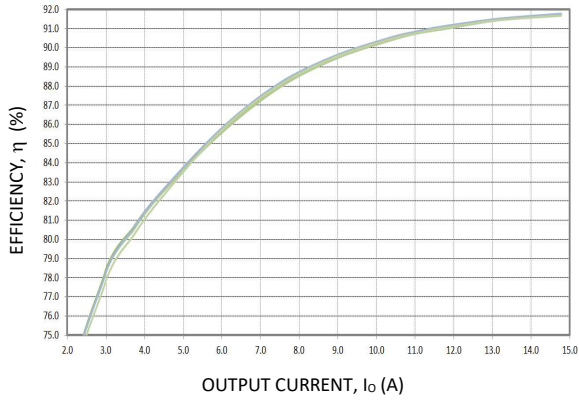

Figure 1. Efficiency V_{IN} : 240V, Freq: 60Hz.

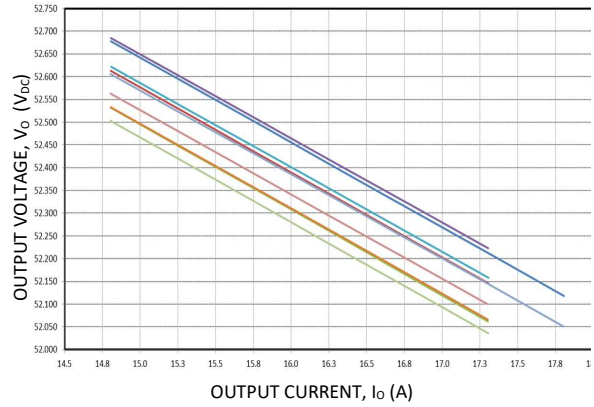

Figure 2. Output current limit profile (0° - 50°C)

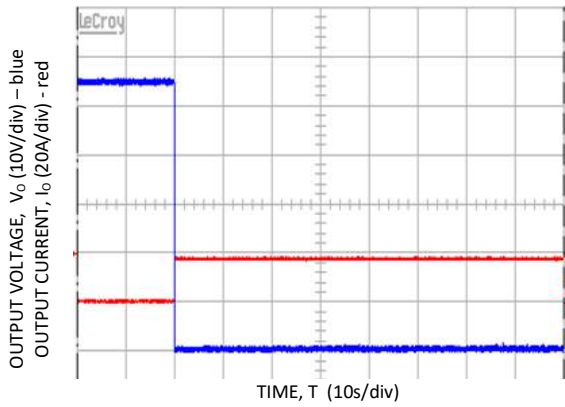

Figure 3. Short circuit Performance

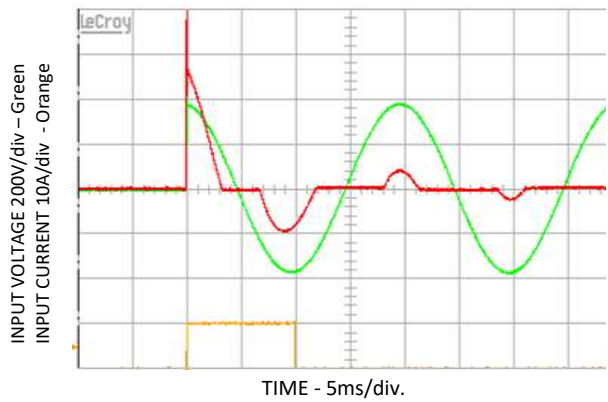

Figure 4. Inrush performance

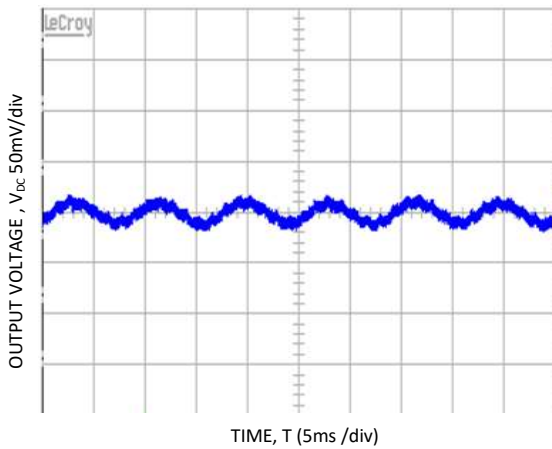

Figure 5. 54V_{DC} output PARD, full load, V_{IN} = 230V_{AC}.

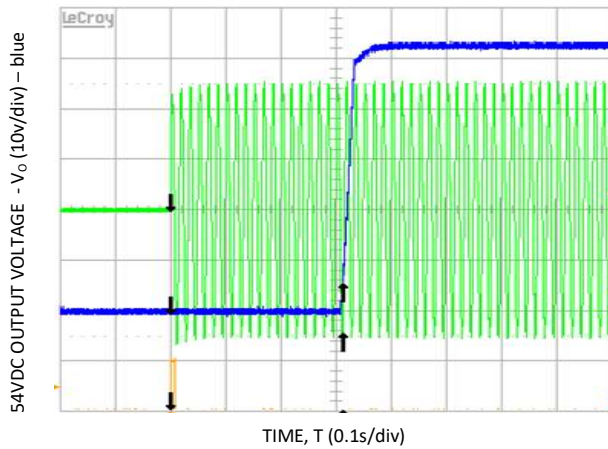

Figure 6. Start up V_{IN} 176 V_{AC}

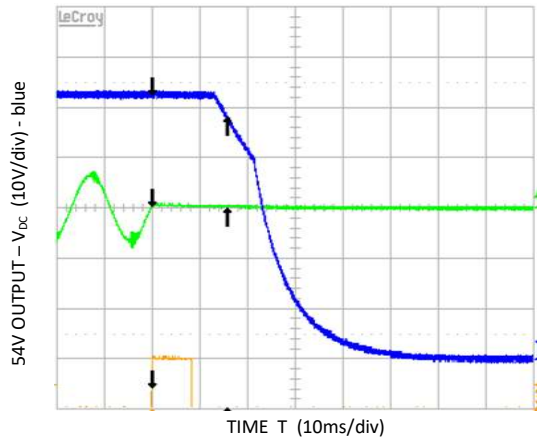

Figure 7. Holdup $V_{IN} = 90V_{AC}$

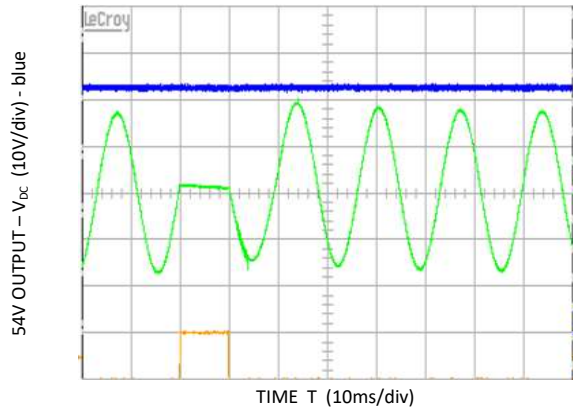

Figure 8. 1/2 cycle ride-through $V_{IN} = 240 V_{AC}$

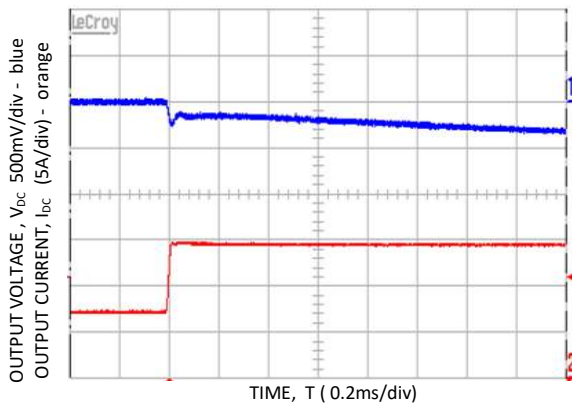

Figure 9. 54V Transient response 50% load step (50 – 100%) .

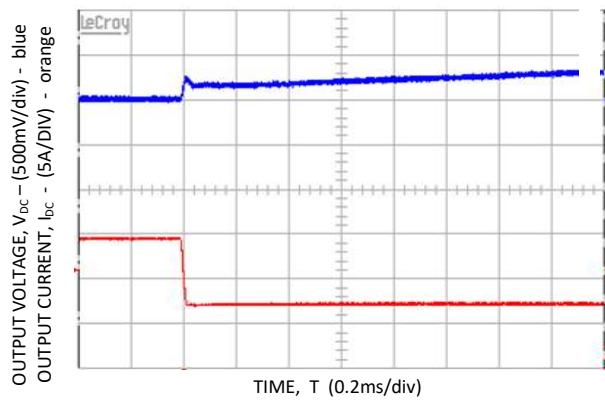

Figure 10. 54V Transient response 50% load step (100 – 50%)

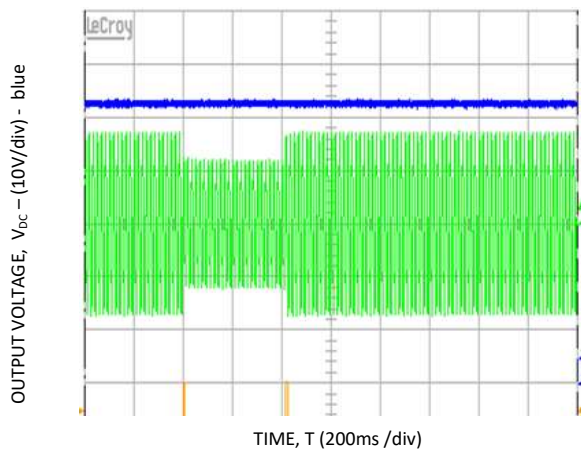

Figure 11. 30% dip ride-through $V_{IN} = 240 V_{AC}$

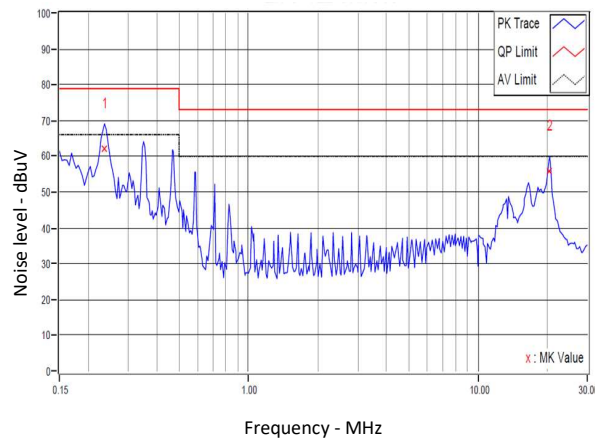

Figure 12. Conducted Emissions

MPR0854FP series rectifier

Input: 100-120/200-240V_{AC}; Output: 54V_{DC} @ 800W; 12V_{DC} @ 0.8A

Control and Status

Analog controls: Details of analog controls are provided in this Technical Requirement under Signal Definitions.

Separate isolated grounds: The +54V_{DC} output is referenced to its own Output Return. The +12V_{DC} and +3.3V_{DC} are referenced to Signal return.

POE isolation: The main 54V_{DC} output is fully isolated from the rest of the power supply, complying with the POE isolation requirements of IEEE802.3af.

Control Signals

Module_Enable_L: This is a short signal pin that controls the presence of the 54V_{DC} main output. This pin should be connected to 'signal return' on the system side of the output connector. The purpose of this pin is to ensure that the output turns ON after engagement of the power blades and turns OFF prior to disengagement of the power blades.

Status signals

AC_OK_L: A TTL compatible status signal representing whether the input voltage is within the anticipated range. This signal needs to be pulled HI externally through a resistor. This signal asserts LO at least 5ms prior to the 54V_{DC} output voltage decaying below 43V_{DC}. The signal shall not assert for a minimum of 10ms after loss of AC power

DC_OK_L: A TTL compatible status signal representing whether the output voltage is present. This signal needs to be pulled HI externally through a resistor.

TEMP_OK_L: A TTL compatible status signal representing whether an over temperature exists. This signal needs to be pulled HI externally through a resistor.

If an over temperature should occur, this signal would pull LO for approximately 10 seconds prior to shutting down the power supply. The unit would restart if internal temperatures recover within normal operational levels. At that time the signal reverts back to its open collector (HI) state.

PS_PRESENT_L: This pin is connected to 'Signal_Return' within the power supply. Its intent is to indicate to the system that a power supply is present. This signal may need to be pulled HI externally through a resistor.

Serial Bus Communications

The I²C interface facilitates the monitoring and control of various operating parameters within the unit and transmits these on demand over an industry standard I²C Serial bus.

All signals are referenced to 'Signal_Return'.

Device addressing: The microcontroller (MCU) and the EEPROM have the following addresses:

Device	Address	Address Bit Assignments (Most to Least Significant)							
MCU	0xBx	1	0	1	1	A2	A1	A0	R/W
Broadcast	0x00	0	0	0	0	0	0	0	0

Address lines (A2, A1, A0): These signal pins allow up to eight (8) modules to be addressed on a single I²C bus. The pins are pulled HI internal to the power supply. For a logic LO these delaypins should be connected to 'Output Return'

Serial Clock (SCL): The clock pulses on this line are generated by the host that initiates communications across the I²C Serial bus. This signal is internally pulled-up to 3.3V via a 1.2kΩ resistor.

Serial Data (SDA): This line is a bi-directional data line. This signal is internally pulled-up to 3.3V via a 1.2kΩ resistor.

Digital Feature Descriptions

PMBus™ compliance: The power supply is fully compliant to the Power Management Bus (PMBus™) rev1.2 requirements.

Master/Slave: The 'host controller' is always the MASTER. Power supplies are always SLAVES. SLAVES cannot initiate communications or toggle the Clock. SLAVES also must respond expeditiously at the command of the MASTER as required by the clock pulses generated by the MASTER.

Clock stretching: The 'slave' μController inside the power supply may initiate clock stretching if it is busy and it desires to delay the initiation of any further communications. During the clock stretch the 'slave' may keep the clock LO until it is ready to receive further instructions from the host controller. The maximum clock stretch interval is 25ms.

The host controller needs to recognize this clock stretching, and refrain from issuing the next clock signal, until the clock line is released, or it needs to delay the next clock pulse beyond the clock stretch interval of the power supply.

Note that clock stretching can only be performed after completion of transmission of the 9th ACK bit, the exception being the START command.

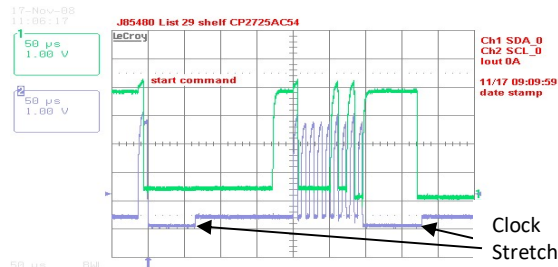

Figure 1. Example waveforms showing clock stretching.

I²C Bus Lock-Up detection: The device will abort any transaction and drop off the bus if it detects the bus being held low for more than 35ms.

MPR0854FP series rectifier

Input: 100-120/200-240V_{AC}; Output: 54V_{DC} @ 800W; 12V_{DC} @ 0.8A

Communications speed: Both 100kHz and 400kHz clock rates are supported. The power supplies default to the 100kHz clock rate. The minimum clock speed specified by SMBus is 10 kHz.

Packet Error Checking (PEC): Although the power supply will respond to commands with or without the trailing PEC, it is highly recommended that PEC be used in all communications. The integrity of communications is compromised if packet error correction is not employed. There are many functional features, including turning OFF the main output, that should require validation to ensure that the correct command is executed.

PEC is a CRC-8 error-checking byte, based on the polynomial $C(x) = x^8 + x^2 + x + 1$, in compliance with PMBus™ requirements. The calculation is based in all message bytes, including the originating write address and command bytes preceding read instructions. The PEC is appended to the

Global broadcast: This is a powerful command because it can instruct all power supplies to respond simultaneously in one command. But it does have a serious disadvantage. Only a single power supply needs to pull down the ninth *acknowledge* bit. To be certain that each power supply responded to the global instruction, a *READ* instruction should be executed to each power supply to verify that the command properly executed. The GLOBAL BROADCAST command should only be executed for write instructions to slave devices.

Read back delay: The power supply needs at least 2 seconds to configure the status registers into their final state. For example, a 200 millisecond delay may be required prior to reading back status information after a clear_faults has been issued to clear the status registers.

PMBus™ Commands

Standard instruction: Up to two bytes of data may follow an instruction depending on the required data content. Analog data is always transmitted as LSB followed by MSB. PEC is optional and includes the address and data fields.

1	8	1	8	1
S	Slave address	Wr	A	Command Code

8	1	8	1	8	1	1
Low data byte	A	High data byte	A	PEC	A	P

Master to Slave Slave to Master

SMBUS annotations; S – Start, Wr – Write, Sr – re-Start, Rd – Read,

A – Acknowledge, NA – not-acknowledged, P – Stop

Standard READ: Up to two bytes of data may follow a READ request depending on the required data content. Analog data is always transmitted as LSB followed by MSB. PEC is mandatory and includes the address and data fields. PEC is optional and includes the address and data fields.

1	7	1	1	8	1
S	Slave address	Wr	A	Command Code	A

1	7	1	1	8	1
Sr	Slave Address	Rd	A	LSB	A

8	1	8	1	1
MSB	A	PEC	No-ack	P

Block instruction: When writing or reading more than two bytes of data at a time BLOCK instructions for WRITE and READ commands must be used instead of the Standard Instructions.

Block write format:

1	7	1	1	8	1
S	Slave address	Wr	A	Command Code	A

8	1	8	1	8	1
Byte count = N	A	Data 1	A	Data 2	A

8	1	8	1	8	1	1
.....	A	Data 48	A	PEC	A	P

Block read format:

1	7	1	1	8	1
S	Slave address	Wr	A	Command Code	A

1	7	1	1
Sr	Slave Address	Rd	A

8	1	8	1	8	1
Byte count = N	A	Data 1	A	Data 2	A

8	1	8	1	8	1	1
.....	A	Data 48	A	PEC	NoAck	P

Linear Data Format The definition is identical to Part II of the PMBus Specification. All standard PMBus values, with the exception of output voltage related functions, are represented by the linear format described below. Output voltage functions are represented by a 16 bit mantissa. Output voltage has a E=9 constant exponent.

The Linear Data Format is a two byte value with an 11-bit, two’s complement mantissa and a 5-bit, two’s complement exponent or scaling factor, its format is shown below.

Data Byte High						Data Byte Low										
Bit	7	6	5	4	3	2	1	0	7	6	5	4	3	2	1	0
	Exponent (E)					Mantissa (M)										

MPR0854FP series rectifier

Input: 100-120/200-240V_{AC}; Output: 54V_{DC} @ 800W; 12V_{DC} @ 0.8A

The relationship between the Mantissa, Exponent, and Actual Value (V) is given by the following equation:

$$V = M * 2^E$$

Where:

V is the value

M is the 11-bit, two's complement mantissa

E is the 5-bit, two's complement exponent

PMBus™ Command set:

Command	Hex Code	Data Byte	Default State
Operation	0x01	1	
ON_OFF_config	0x02	1	0x09, output ON
Clear_faults	0x03	0	
Write_protect	0x10	1	0x80
Store_default_all	0x11	0	
Restore_default_all	0x12	0	
Capability	0x19	1	0x30, 400kHz
Vout_mode	0x20	1	0x17, N=9
Fan_command_1	0x3B	2	In RPM (linear format)
Vout_OV_fault_limit	0x40	2	
Vout_OV_fault_response	0x41	1	0x00, hardware triggered
Vout_OV_warn_limit	0x42	2	
Vout_UV_warn_limit	0x43	2	
Vout_UV_fault_limit	0x44	2	
Vout_UV_fault_response	0x45	1	0x00, hardware triggered
lout_OC_warn_limit	0x4A	2	
OT_fault_limit	0x4F	2	
OT_fault_response	0x50	1	0XC0
OT_warn_limit	0x51	2	
UT_warn_limit	0x52	2	
UT_fault_response	0x54	1	0x00
Status_byte	0x78	1	
Status_word	0x79	2	
Status_Vout	0x7A	1	
Status_lout	0x7B	1	
Status_input	0x7C	1	
Status_temperature	0x7D	1	
Status_CML	0x7E	1	
Status_other	0x7F	1	
Status_mfr_specific	0x80	1	
Status_fan_1_2	0x81	1	
Read_Vout	0x8B	2	
Read_lout	0x8C	2	
Read_temperature	0x8D	2	
Read_fan_speed_1	0x90	2	
Read_Pout	0x96	2	
PMBus revision	0x98	1	
Mfr_ID	0x99	5	FRU_ID
Mfr_model	0x9A	15	
Mfr_revision	0x9B	4	
Mfr_location	0x9C	4	

Mfr_date	0x9D	6	
Mfr_serial	0x9E	15	

Command	Hex Code	Data Byte	Default State
Mfr_Vin_min	0xA0	2	
Mfr_Vin_max	0xA1	2	
Mfr_lin_max	0xA2	2	
Mfr_Pin_max	0xA3	2	
Mfr_Vout_min	0xA4	2	
Mfr_Vout_max	0xA5	2	
Mfr_lout_max	0xA6	2	
Mfr_Pout_max	0xA7	2	
Mfr_Tambient_max	0xA8	2	
Mfr_Tambient_min	0xA9	2	
User_data_00	0xB0	48	User memory space
User_data_01	0xB1	48	User memory space
FRW_revision	D0	1	

Status Register Bit Allocation:

Register	Hex Code	Data Byte	Function
Status_Byte	78	7	Busy
		6	DC_OFF
		5	Output OV Fault detected
		4	Output OC Fault detected
		3	Input UV Fault detected
		2	Temp Fault/warning detected
		1	CML (communication fault) detected
		0	None of Below
Status_word (includes Status_byte)	79	7	OV Fault/Warning detected
		6	OC Fault/Warning detected
		5	Input Fault/Warning detected
		4	Mfr_specific register change detected
		3	DC_OFF
		2	Fan Fault or Warning detected
		1	Other fault
		0	Unknown
Status_Vout	7A	7	Vout OV Fault
		6	Vout OV Warning
		5	Vout UV Warning
		4	Vout UV Fault
		3	N/A
		2	N/A
		1	N/A
0	N/A		
Status_lout	7B	7	IOUT OC Fault
		6	N/A
		5	IOUT OC Warning
		4	N/A
		3	N/A
		2	N/A
1	N/A		

MPR0854FP series rectifier

Input: 100-120/200-240V_{AC}; Output: 54V_{DC} @ 800W; 12V_{DC} @ 0.8A

		0	N/A
--	--	---	-----

Register	Hex Code	Data Byte	Function
Status_input	7C	7	Vin OV Fault
		6	Vin OV Warning
		5	Vin UV Warning
		4	Vin UV Fault
		3	N/A
		2	N/A
		1	N/A
		0	N/A
Status_temperature	7D	7	OT Fault
		6	OT Warning
		5	N/A
		4	N/A
		3	N/A
		2	N/A
		1	N/A
		0	N/A
Status_cml	7E	7	Invalid/Unsupported Command
		6	Invalid/Unsupported Data
		5	Packet Error Check Failed
		4	Memory Fault Detected
		3	Processor Fault Detected
		2	Reserved
		1	Other Communications Fault
		0	Other Memory or Logic Fault
Status_mfr_specific	80	7	IDC-OK
		6	OVSH#
		5	INT#
		4	FAULT#
		3	OT#
		2	DC_OK
		1	AC_OK
		0	LINE#
Status_fan_1_2	81	7	Fan_1_fault
		6	N/A
		5	N/A
		4	N/A
		3	Fan 1 Speed Overridden
		2	N/A
		1	N/A
		0	N/A

Command Descriptions

Operation (0x01) : By default the Power supply is turned **ON** at power up as long as *Power ON/OFF* signal pin is active HI. The Operation command is used to turn the Power Supply ON or OFF via the PMBus. The data byte below follows the OPERATION command.

FUNCTION	DATA BYTE
Unit ON	80
Unit OFF	00

MPR0854FP series rectifier

Input: 100-120/200-240V_{AC}; Output: 54V_{DC} @ 800W; 12V_{DC} @ 0.8A

To **RESET** the power supply cycle the power supply OFF, wait at least 2 seconds, and then turn back ON. All alarms and shutdowns are cleared during a restart.

Clear_faults (0x03): This command clears all STATUS and FAULT registers.

If a fault still persists after the issuance of the clear_faults command the specific registers indicating the fault are reset again.

WRITE_PROTECT register (0x10): Used to control writing to the PMBus device. The intent of this command is to provide protection against accidental changes. All supported command parameters may have their parameters read, regardless of the write_protect settings. The contents of this register can be stored to non-volatile memory using the Store_default_code command. The default setting of this register is disable_all_writes except write_protect 0x80h.

FUNCTION	DATA BYTE
Enable all writes	00
Disable all writes except write_protect	80
Disable all writes except write_protect and OPERATION	40

Vout_OV_warn_limit (0x42): OV_warning is extremely useful because it gives the system controller a heads up that the output voltage is drifting out of regulation and the power supply is close to shutting down. Pre-emptive action may be taken before the power supply would shut down and potentially disable the system.

Vout_OV_fault_response (0x41): The power supply can be programmed to latch at a level set by Vout_OV_fault_limit by changing the response to 0x40.

Vout_UV_fault_response (0x45): The power supply can be programmed to latch at a level set by Vout_UV_fault_limit by changing the response to 0x40.

OT_fault_response (0x50): The power supply can be programmed to either resume operation (0xC0) or latch (0x40) at a level set by OT_fault_limit.

Restart after a latch off: Either of four restart possibilities are available. The hardware pin **Remote ON/OFF** may be turned OFF and then ON. The unit may be commanded to restart via i2c through the *Operation* command by first turning OFF then turning ON. The third way to restart is to remove and reinsert the unit. The fourth way is to turn OFF and then turn ON ac power to the unit. The fifth way is by changing firmware from **latch off to restart**. Each of these commands must keep the

power supply in the OFF state for at least 2 seconds, with the exception of changing to **restart**.

A power system that is comprised of a number of power supplies could have difficulty restarting after a shutdown event because of the non-synchronized behavior of the individual power supplies. Implementing the latch-off mechanism permits a synchronized restart that guarantees the simultaneous restart of the entire system.

A synchronous restart can be implemented by;

1. Issuing a GLOBAL OFF and then ON command to all power supplies,
2. Toggling Off and then ON the **Remote ON/OFF** signal
3. Removing and reapplying input commercial power to the entire system.

The power supplies should be turned OFF for at least 20 – 30 seconds in order to discharge all internal bias supplies and reset the soft start circuitry of the individual power supplies.

Auto_restart: Auto-restart is the default configuration for recovering from over-current and over-temperature shutdowns.

An overvoltage shutdown is followed by three attempted restarts, each restart delayed 1 second, within a 1 minute window. If within the 1 minute window three attempted restarts failed, the unit will latch OFF. If less than 3 shutdowns occur within the 1 minute window then the count for latch OFF resets and the 1 minute window starts all over again.

Status_word (0x79): returns two bytes of information. The upper byte bit functionality is tabulated in the Status_word section. The lower byte bit functionality is identical to Status_byte.

Invalid commands or data: The power supply notifies the MASTER if a non-supported command has been sent or invalid data has been received. Notification is implemented by setting the appropriate STATUS and ALARM registers.

LEDs

Two LEDs are located on the front faceplate. The AC_OK LED provides visual indication of the INPUT signal function. When the LED is ON GREEN the power supply input is within normal design limits.

The second LED is the DC_OK LED. When solid GREEN there are no faults and DC output is present. When blinking GREEN there is an apparent engagement problem with the output connector.

Alarm Table

Test Condition	LED Indicator		Monitoring Signals		
	LED1 AC_OK	LED2 DC_OK	DC_OK_L	AC_OK_L	TEMP_OK_L

MPR0854FP series rectifier

Input: 100-120/200-240V_{AC}; Output: 54V_{DC} @ 800W; 12V_{DC} @ 0.8A

1	Normal Operation	Green	Green	Low	Low	Low
2	Low or NO INPUT	Off	Off	High	High	High
3	OVP	Green	Off	High	Low	Low
4	Over Current	Green	Off	High	Low	Low
6	Fault Over Temp	Green	Off	High	Low	High
7	Engagement problem	Green	Blink	High	High	High

MPR0854FP series rectifier

Input: 100-120/200-240V_{AC}; Output: 54V_{DC} @ 800W; 12V_{DC} @ 0.8A

Outline Drawing

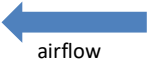
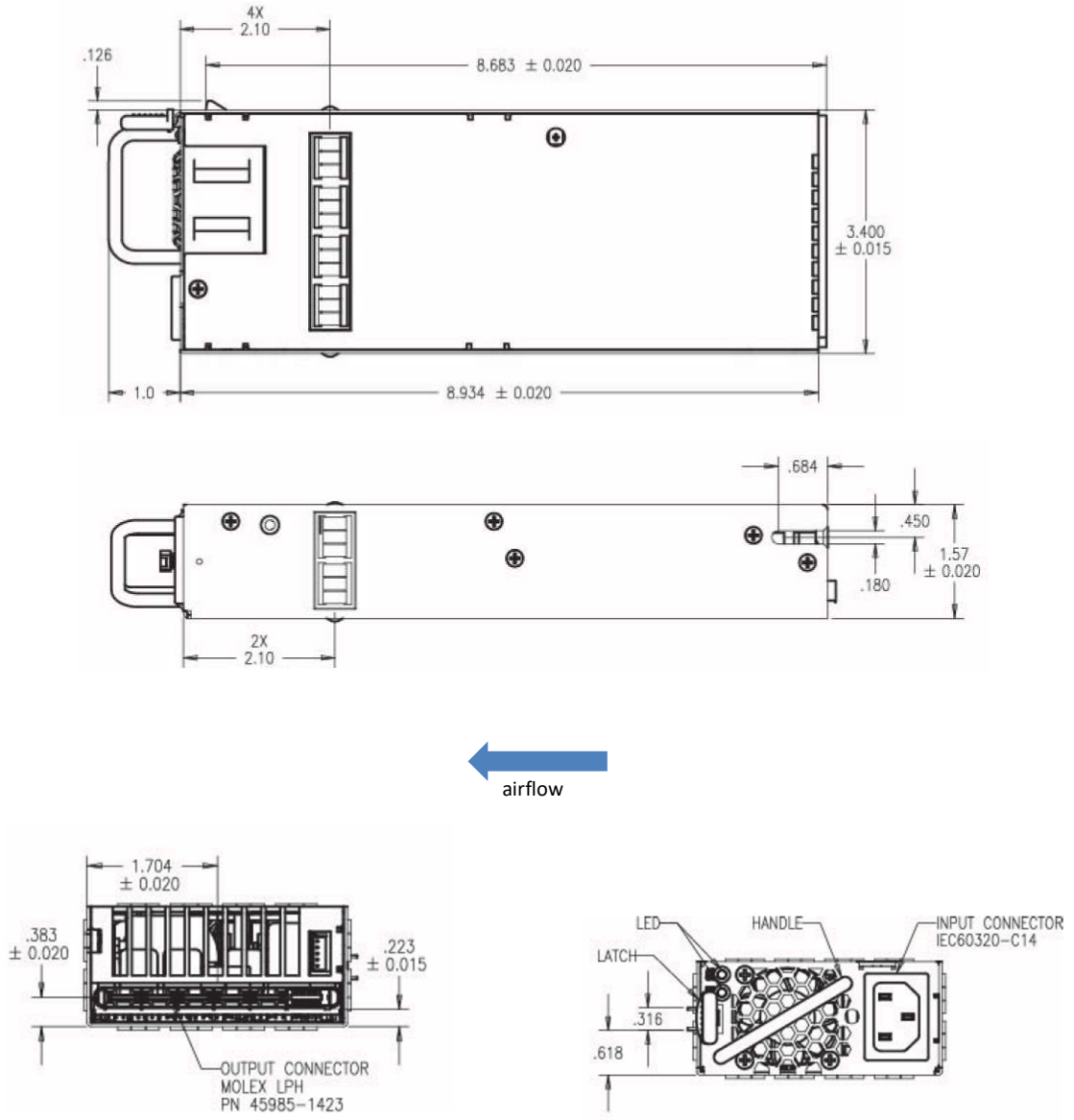

MPR0854FP series rectifier

Input: 100-120/200-240V_{AC}; Output: 54V_{DC} @ 800W; 12V_{DC} @ 0.8A

Connector Pin Assignments

Input Mating Connector: IEC320, C13 type

Output Connector: Molex P/N: LPH 45985-1423
Mating connector: Molex PN # 45984-1422

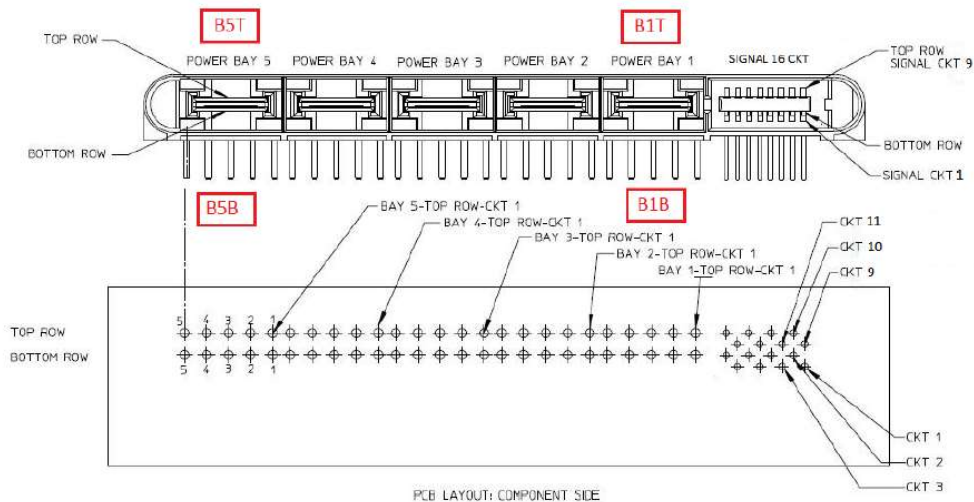

Power Circuits			
Bay	Function	Bay	Function
B1T	+12V Fan Power	B1B	Signal_Return
B2T	Chassis Ground	B2B	Chassis Ground
B3T	Isolation Barrier	B3B	Isolation Barrier
B4T	+54V Output	B4B	Output_Return
B5T	+54V Output	B5B	Output_Return

Signal Circuits			
Pin	Function	Pin	Function
1	n/a	9	n/a
2	A0	10	3.3V ⁷
3	TEMP_OK_L	11	A2
4	A1	12	SDA
5	AC_OK_L	13	Signal_Return
6	Signal_Return	14	SCL
7	DC_OK_L	15	Signal_Return
8	PS_PRESENT_L	16	MODULE_ENABLE_L

Note: Signal pins are shorter than power blades in order to ensure that they achieve the last-to-make, first-to-break feature for hot plug

⁷ The 3.3V output is for internal use only. This signal pin is to be used only for monitoring purposes.

MPR0854FP series rectifier

Input: 100-120/200-240V_{AC}; Output: 54V_{DC} @ 800W; 12V_{DC} @ 0.8A

Ordering Information

Please contact your GE Sales Representative for pricing, availability and optional features.

PRODUCT	DESCRIPTION	PART NUMBER
800W Rectifier	+54V _{OUT} , +12V _{DC} , PMBus interface, RoHS 6 of 6, airflow rear-to-front	MPR0854FPXXXZ01A

Contact Us

For more information, call us at

USA/Canada:

+1 877 546 3243, or +1 972 244 9288

Asia-Pacific:

+86.021.54279977*808

Europe, Middle-East and Africa:

+49.89.878067-280

<http://www.geindustrial.com/products/critical-power>



GE Critical Power reserves the right to make changes to the product(s) or information contained herein without notice, and no liability is assumed as a result of their use or application. No rights under any patent accompany the sale of any such product(s) or information.

X-ON Electronics

Largest Supplier of Electrical and Electronic Components

Click to view similar products for [Rack Mount Power Supplies](#) category:

Click to view products by [ABB](#) manufacturer:

Other Similar products are found below :

[G08-M02](#) [HFE2500BP](#) [PET1300-12-054NAE](#) [HFE1600BP](#) [RKP-1UT](#) [73-311-0001](#) [73-317-0148](#) [73-495-0233](#) [750-1016](#) [SFP450-S101G](#)
[FUP550SNRPS](#) [VRA.00335.0](#) [VRA.00334.0](#) [VRA.00333.0](#) [HFE1600-KIT](#) [CP841A_3C3R_S](#) [CC109146503](#) [RKP-1UI](#) [PFE1100-12-054ND](#)
[FND300-1012G](#) [73-951-0001T](#) [73-954-0001C](#) [DS550DC-3](#) [RCP-2000-24](#) [TSR10](#) [TET2000-12-086NA](#) [PET2000-12-074RA](#) [RCP-MU](#) [605-](#)
[10144-2AC](#) [6609006-5](#) [D1U54P-W-1200-12-HC4PC](#) [DS650DC-3](#) [LCM300W-T-4](#) [LCM600N-T-4-A](#) [FNP600-48G](#) [FNR-3-48G](#) [FNR-5-12G](#)
[SPSPFE3-05G](#) [TET3200-12-069RA](#) [IEC-A-1](#) [DHP-1UT-A](#) [DRP-3200-24](#) [RCP-1000-12](#) [RCP-1000-12-C](#) [RCP-1000-24](#) [RCP-1000-24-C](#)
[RCP-1000-48](#) [RCP-1000-48-C](#) [RCP-1600-12](#) [RCP-1600-48](#)