



Breakers and Switches

Rotary cam switches

OC 10...25 Amperes
Versatility made simple

Rotary cam switches

OC10...25

Product overview, features

Features	4
----------	---

Technical data

Rotary cam switches OC, 10...25 Amperes	11
---	----

Ordering information, standard cam switches, the most common applications

ON-OFF switches	14
Change-over switches	17
Bypass switches	20
Multistep switches	21
Motor control switches: Ventilation, reversing, star-delta, pole-change, pumpstart, stop and start switches	28
Voltmeter switches	30
Ammeter switches	31
Volt-ammeter switches	31
Binarycode switches	32

Ordering information, accessories

Handles	34
Plates	38
Protective rear cover, nut spanner tool, adaptor ring, spare key	39

Order code configuration, standard cam switches

Options for Standard cam switch configuration	40
Standard cam switch configuration	41

Type designation

Rotary cam switches OC10...25, standard and customized	57
--	----

Dimension drawings

Rotary cam switches OC10 and handles	61
Rotary cam switches OC25 and handles	64
Lockable handles, OC25	69
Gang drive handles, OC25	71
Front plates, OC10...25	72

Order form

ABB customized cam switch	73
---------------------------	----

Index

List of products with page number in alphabetical order	75
---	----

Versatility made simple

OC10...25 Amperes



CamWeb2 – Best configuration tool It's powerful, it's fast, it's user-friendly

Configuration tool CamWeb2 is designed to allow customers to custom-configure cam switches according to their needs.

High performance cam switches

- New patent-pending contact design guarantees consistent opening times between moving and fixed contacts. This results in higher current performances and a longer life span.
- Gold-plated contacts are available, for reliable low voltage switching
- High quality, flame-resistant materials

- Laser-printed text for life-long visibility, even in harsh environments
- Configurable switch body offers horizontal or vertical access to terminals

Designed for safety

- Finger-proof tunnel terminals with IP20 protection eliminate the risk of touching live parts without adding any protective covers. This ensures safe operation, protecting people and equipment.
- Versatile selection of high protection degree handles. The standard handle is IP66. There are also handles available with increased protection up to IP67. See pages 6...9 for more details.



Versatile mounting options

Door Mounting available in 2 versions

- Screw Mounting: multiple fixing points with screws.
- Snap-on Mounting: quick and easy installation which can reduce labor time by up to 5 times.

Base Mounting versions are equipped with features that allow screw or DIN rail mounting.

ABB's complete offering

ABB offers a wide variety of switches, breakers, control gear, wiring accessories, DIN-rail components and much more

- ▶ A wide range of LV products available from one supplier



Customized cam switches

Design your own cam switch with CamWeb2



CamWeb2 – Best configuration tool It's powerful, it's fast, it's user-friendly

Configuration tool CamWeb2 is designed to allow customers to custom-configure cam switches according their needs.

- Configuration of non-standard switches
- No need to do specifications manually
- Browser application, no installed software needed
- With a broad selection of accessories and contact configurations in CamWeb2, there is always a switch suitable for your application

▶ Custom-made cam switches designed specifically for you

How to use it?

- 1 Go to <https://camweb2.com> and login
- 2 Select ampere, poles and handle type
- 3 Select angle system and design front plate
- 4 Specify contacts
- 5 Make jumper connection
- 6 Save and Send
- 7 Information output

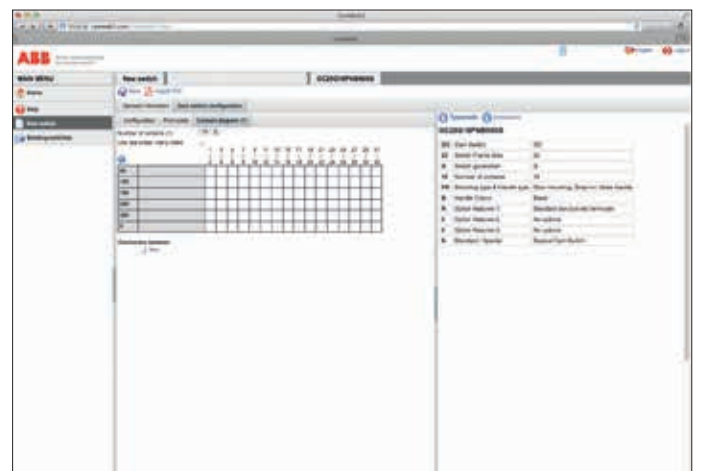

Standard and customized cam switches OC

Versatile handle selection

Suitable Standard handle types according to the ordering code configuration tables. Special handles, gang drive and additional lettering plate selection configurable with Cam-Web2.

Nose handles (_N or _M)

Nose handles have a degree of protection IP66. Door mounted versions can be snap-on or screw mounted. Snap-on mounted switches are suitable for 22.5 mm door drilling and screw mounted switches have a two (OC10) or four (OC25) hole mounting pattern. For base mounting, the handle can be fixed directly on the switch or on the enclosure door via shaft.

The standard front plate sizes are 32x32 mm for OC10 and 51x51 mm for OC25. Nose handles are available in black or gray color.



Extended nose handle (_E or _F)

Extended nose handles are available only for OC25 switches and are available in black or gray color. The handle has IP66 protection.

Extended nose handles can be snap-on or screw mounted. For base mounting, the handle can be fixed directly on the switch or on the enclosure door via shaft. Snap-on mounted switches are suitable for 22.5 mm door drilling and screw mounted switches are mounted with a four hole pattern. The standard front plate size is 51x51 mm.



Nose handle, round front ring (PX)

The round front ring replaces the square escutcheon plate with legend. These types of handles are used in applications where position indication or engraving is not needed on the switch.

Round front ring handles are available in black and gray colors and have a degree of protection IP66. The ring diameters are 32 mm for OC10 and 39 mm for OC25. These handles are snap-on mounted, which are for use with 22.5 mm door drilling.



Key operated switches (K_)

The switches are operated with a key instead of a handle. The degree of protection is IP54. Key operation is available with 60° spacing, starting at 0° and onwards. They are also available with 90° spacings, starting at 0° and onwards. It is possible to identify the positions for key removal in CamWeb2 or standard key-operated switches have the possibility to remove the key in all positions. Key operated switches are available only with snap-on mounting, which is for use in a 22.5 mm mounting hole. The standard front plate sizes are 32x32 mm for OC10 and 51x51 mm for OC25.



Key operated switches, round front ring (KX)

The switches are operated with a key instead of a handle and the round front ring replaces the square escutcheon plate with legend. These types of handles are used in applications where position indication or engraving is not needed on the switch. There are round front rings in black and gray color, with a diameter of 30 mm (OC10) and 39 mm (OC25). The degree of protection is IP54.



Standard and customized cam switches OC

Versatile handle selection

Modular switch handle with front cover (MN)

This handle is available only for base-mounted OC25 switches and the handle is mounted directly to the switch. It is light gray and the degree of protection is IP20. The handle can be used with standard 45 mm door or cover cutouts and is suitable for 35 mm dinrail mounting. If 6 contacts or less are used, the switch depth is consistent with other standard 45 mm components, such as miniature circuit breakers.

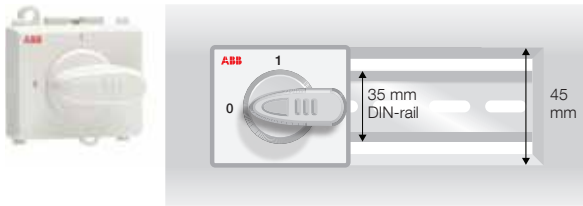

Padlockable nose handle (_1)

Padlockable nose handles are available for OC25 switches and replace the standard nose handle. They can be snap-on (22.5 mm hole) or screw mounted (four hole pattern) and are suitable for use with door or base mounted versions. The handles are available in black, gray or red-yellow. If the red-yellow version is selected, the handle will be red and the legend plate will be yellow. They can be used with up to 2 padlocks. Padlocking is possible every 45° and the padlockable positions can be specified in CamWeb2. The degree of protection is IP66.



Extended padlockable nose handle (_2)

Extended padlockable nose handles are available for OC25 switches and replace the standard nose handle. They can be snap-on (22.5 mm hole) or screw mounted (four hole pattern) and are suitable for use with door or base mounted versions. The handles are available in black, gray or red-yellow. If the red-yellow version is selected, the handle will be red and the legend plate will be yellow. They can be used with up to 3 padlocks. Padlocking is possible every 45° and the padlockable positions can be specified in CamWeb2. The standard legend plate size with this option is 66x66 mm and the degree of protection is IP66.



Round padlockable handle (_3)

Round padlockable handles are available for OC25 switches and replace the standard nose handle. They can be snap-on (22.5 mm hole) or screw mounted (four hole pattern) and are suitable for use with door or base mounted versions. These handles are available for use with On-Off switches and allow the switch to be padlocked in the OFF position.

The handles are available in black, gray or red-yellow. They can be used with up to 3 padlocks. The degree of protection is IP67.



Key interlocked nose handle (QN)

Key interlocked handles are available on the OC25 with screw mounting and require an additional clearance hole for the lock. The operation of the cam switch is interlocked with a cylinder lock that is available to be located to the right or below the switch handle. The key can be removed in the lockable positions, which can be configured with 30° or 45° spacings in CamWeb2. The standard legend plate size with this option is 51x51 mm and the degree of protection is IP65.



Key interlocked extended nose handle (QM)

Key interlocked handles are available on the OC25 with screw mounting and require an additional clearance hole for the lock. The operation of the cam switch is interlocked with a cylinder lock that is available to be located to the right or below the switch handle. The key can be removed in the lockable positions, which can be configured with 30° or 45° spacings in CamWeb2. The standard legend plate size with this option is 66x66 mm and the degree of protection is IP65.



Standard and customized cam switches OC

Versatile handle selection

Double or triple gang drive

These options are available for OC25 and allow a larger number of contacts to be used: up to 2x24 contacts for double (tandem) and up to 3x24 contacts for triple gang drive.

Double or triple gang drive switches include an extended nose handle or have the option of an extended padlockable nose handle. The switches can be screw mounted on door or base mounted. For base mounting, the handle is fixed directly on the switch. The front plate size is 66X66 mm and the degree of protection is IP66.



Spring return

The spring return movement is available with 30° spacing between momentary and maintained positions.

Gold contacts (_ G _)

Available for all OC switches. Gold contacts are recommended for low energy applications, especially for circuits with 12 Vdc and 10 mA or less.

Front Plate Options

The standard front plates are 32x32 mm for OC10 and 51x51 mm for OC25. Larger front plates (66X66 mm) are available for OC25 switches (_2). It is also possible to include an additional front plate at the top of the OC10 and OC25 switches in order to identify a switch name. The text that should be included on the additional front plates can be specified in CamWeb2.

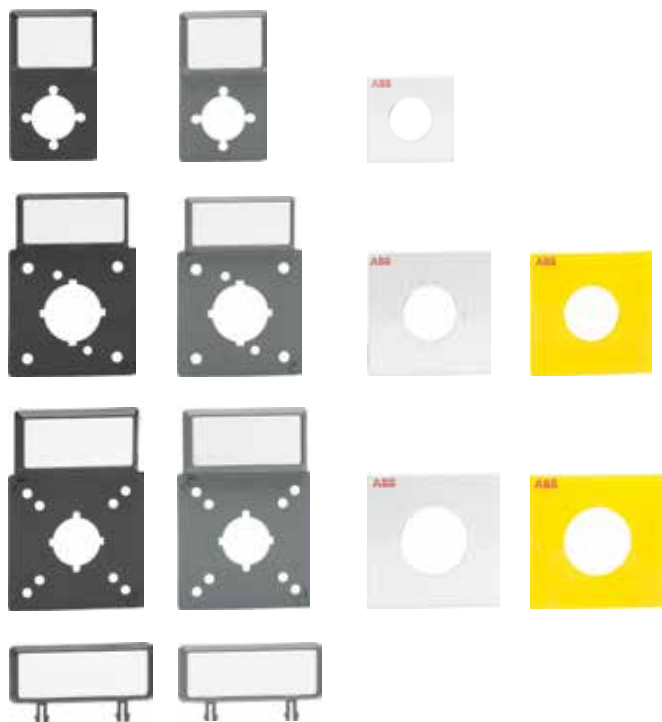



Standard and customized cam switches OC

How to read contact diagrams

Symbol key

 Contact closed

 Contact closed without interruption between switch positions

 Contact closed with interruption between switch position

 Early make, late break contact

 Spring return

Example

Switch with 3 positions and 2 contacts. Spring return option between "START" and "1".

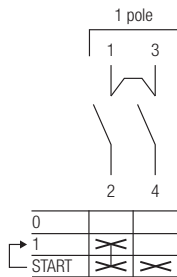
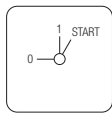

There is a jumper installed between terminals 1 and 3

No contacts are closed in the position "0"

Contact 1-2 is closed in position "1"

Contact 1-2 remains closed when moving switch to "START" position. Contact 3-4 also closes when switch is in "START" position.

The switch will automatically spring return from "START" to "1".

Certifications list

- IEC 60947-3, EN 60947-3
- IEC 60947-1
- IEC 60947-4-1
- IEC 60947-5-1, EN 60947-3
- CQC (CCC): China Quality Certification
- CE
- UL 60947-1
- UL 60947-4-1
- CSA C22.2 no. 60947-1-13
- CSA C22.2 no. 60947-4-1-14

Technical data

Rotary cam switches OC 10...25 Amperes

Ratings according to IEC60947-3

				OC10	OC25
Rated insulation voltage	U_i	Pollution degree 3	V	500	690
Rated impulse withstand voltage	U_{imp}		kV	2.5	4
Rated thermal current	I_{th}		A	10	25
Rated conditional short circuit current	I_p (r.m.s.)		kA	1 ¹⁾	7 ¹⁾
Max back-up fuse link			A	10	25
Rated short time withstand current	r.m.s. -value I_{pw}	1s	A	120	300
		3s	A	70	173
Conditional short circuit current	I_q	500 V	kA	3	-
		690 V	kA	-	7
Rated operational current	AC-21A 1 and 3-phase	400 V	A	10	25
		Up to 500V	A	10	20
	AC-22A 1 and 3-phase	500..690 V	A	-	20
	AC-23A 3-phase	230 V	A	7.6	15
		400 V	A	6.5	15
		500 V	A	-	8.1
		690 V	A	-	5.9
	AC-23A 1-phase	230 V	A	7.2	8.7
		400 V	A	6.1	8.3
	AC-3 3-phase	230 V	A	7.6	12
		400 V	A	4.9	12
		500 V	A	-	6.8
		690 V	A	-	4.9
	AC-3 1-phase	230 V	A	5.3	7.2
400 V		A	4.2	7.2	
AC-4 3-phase	380..440 V	A	1.4	7.7	
	660..690 V	A	-	3.8	
Rated operational current, DC-21A	1-contact in series	48 V	A	10	25
Time constant 0...1ms	1-contact in series	110 V	A	0.7	1.5
	1-contact in series	220 V	A	0.3	0.5
	2-contact in series	60 V	A	10	20
	3-contact in series	110 V	A	10	20
	5-contact in series	220 V	A	10	20
	9-contact in series	440 V	A	10	20
	10-contact in series	600 V	A	-	16
Rated operational current, DC-22A	1-contact in series	24 V	A	6	10
	1-contact in series	30 V	A	3	4.5
	1-contact in series	40 V	A	3	4.5
	2-contact in series	60 V	A	3	4.5
	3-contact in series	110 V	A	3	4.5
	5-contact in series	220 V	A	3	4.5
Rated operational current, DC-13	1 contact in series	48 V	A	-	3
	1 contact in series	110 V	A	-	0.8
	1 contact in series	220 V	A	-	0.4
Rated operational current, according to IEC60947-5-1	AC-15	220...240 V	A	2.5	5.5
		380...440 V	A	1.5	3.5

¹⁾ 400 V

Technical data

Rotary cam switches OC 10...25 Amperes

Ratings according to IEC60947-3

				OC10	OC25
Rated operational power ¹⁾	AC-23A 3-phase	230 V	kW	1.8	2.6
		400 V	kW	3	7.5
		500 V	kW	-	4.8
		690 V	kW	-	4.8
	AC-23A 1-phase	230 V	kW	0.8	0.9
		400 V	kW	1.1	1.5
	AC-3 3-phase	230 V	kW	1.8	2.2
		400 V	kW	2.2	5.5
		500 V	kW	-	4
		690 V	kW	-	4
	AC-3 1-phase	230 V	kW	0.6	0.8
		400 V	kW	0.8	1.3
AC-4 3-phase	380...440 V	kW	0.55	4	
	660...690 V	kW	-	3	
Power loss per contact - at rated I_{th}	Standard contacts		W	≤ 0.6	≤ 1.8
Contact resistance	Standard contacts		Ohms	≤ 0.004	≤ 0.003
Power loss per contact - at rated I_{th}	Gold contacts		W	0.4	≤ 1.8
Contact resistance	Gold contacts		Ohms	≤ 0.006	≤ 0.003
Minimum switching capacity	Gold contacts		mA	5	5
	Gold contacts		V AC/DC	5	5
Terminals	Max cable cross section, solid/ stranded ³⁾		mm ²	0.5...1.5	1.5...4
Mechanical endurance ⁵⁾	8 Contacts and less		Number	500 000	500 000
	9 to 14 Contacts		of	300 000	300 000
	15-24 Contacts		operations	100 000	100 000
Temperature	Storing and operational ²⁾ temperature		°C	-40...+80	-40...+85

²⁾ At 40°C, derating 0%. Current peaks up to 60°C, derating 0%. For higher temperatures, see derating curve below.

³⁾ Use copper wire only.

⁴⁾ These values are given for guidance and may vary acc. to the motor manufacturer.

⁵⁾ The mechanical endurance ratings are dependent on the switching angles and the number of contacts. The ratings shown represent the minimum values achieved. Higher ratings may be available upon request.

Derating for ambient temperature

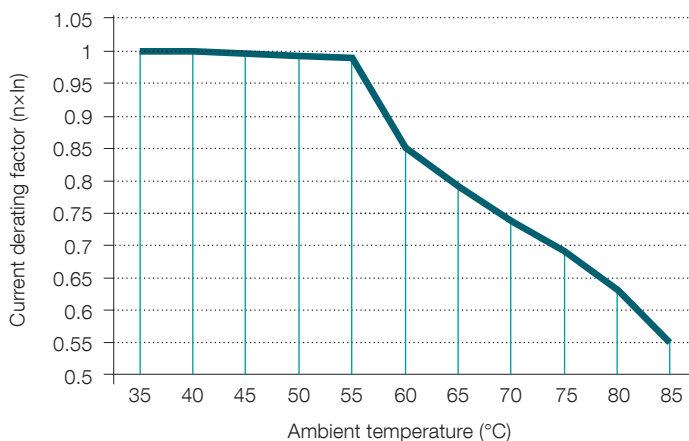

Technical data

Rotary cam switches OC 10...25 Amperes

Ratings according to UL 60947-4-1

Standards UL 60947-1, UL 60947-4-1, CSA C22.2 no. 60947-1-13, CSA C22.2 no. 60947-4-1-14.

Model designation		OC10	OC25	
Maximum general use ratings:				
Pilot duty, V ac		V ac	A300	A600
General rating, A		A	10	25
Voltage rating, 50/60 Hz, V ac		V ac	300	600
Single phase horsepower ratings				
Voltage, V ac, 50/60 Hz	120 V	HP	0.33	0.75
		FLA	7.2	13.8
	240 V	HP	1	2
		FLA	8.0	12.0
	480 V	HP	-	3
		FLA	-	8.5
	600 V	HP	-	3
		FLA	-	6.8
Three phase horsepower ratings				
Voltage, V ac, 50/60 Hz	120 V	HP	1	2
		FLA	8.4	13.6
	240 V	HP	1.0	3
		FLA	4.2	9.6
	480 V	HP	-	5
		FLA	-	7.6
	600 V	HP	-	7.5
		FLA	-	9.0
Short circuit ratings, manual motor controllers				
Short circuit ratings			1 kA rms, 300 Vac	5 kA rms, 600 Vac
Maximum fuse size (Fuse class)			30 A (RK5)	35 A (RK5)
Cabling				
Wire range		AWG	14**	14-10**

** Solid or stranded copper conductors only.

The standard for Industrial Control Equipment UL 508 has been harmonized with the relevant product standards of the IEC standard for Low-Voltage Switchgear and Controlgear IEC 60947.

Ordering information

Rotary cam switches, standard

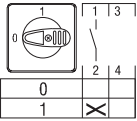

OC_A1

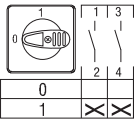

OC_A2

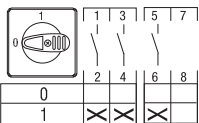

OC_A3

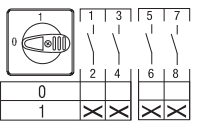

OC_A4

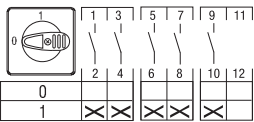

OC_A5

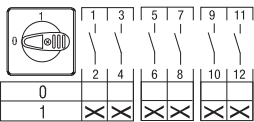

OC_A6

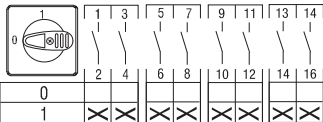

OC_A8

ON - OFF switches

The handle and front plate with position indication are included according to the table below.

Key operated cam switches: the key can be removed in both positions, includes two keys.

The round front ring: to be used in situations when position indications are on the door of the enclosure.

Function	Number of poles/ contacts	Rated thermal current I_{th} [A]	Type	Order number	Weight/ unit [kg]
O-position: 9 o'clock, step angle 90°, door mounted					
Snap-on mounted black nose handle, black front frame and silver front plate					
0 - 1	1 / 1	10	OC10G01PNBN00NA1	1SCA126421R1001	0.034
0 - 1	2 / 2	10	OC10G02PNBN00NA2	1SCA126423R1001	0.036
0 - 1	3 / 3	10	OC10G03PNBN00NA3	1SCA126426R1001	0.043
0 - 1	4 / 4	10	OC10G04PNBN00NA4	1SCA126427R1001	0.045
0 - 1	5 / 5	10	OC10G05PNBN00NA5	1SCA126428R1001	0.052
0 - 1	6 / 6	10	OC10G06PNBN00NA6	1SCA126429R1001	0.054
0 OFF- 1 ON	1 / 1	10	OC10G01PNBN00NB1	1SCA134986R1001	0.034
0 OFF- 1 ON	2 / 2	10	OC10G02PNBN00NB2	1SCA134993R1001	0.036
0 OFF- 1 ON	3 / 3	10	OC10G03PNBN00NB3	1SCA134996R1001	0.043
0 OFF- 1 ON	4 / 4	10	OC10G04PNBN00NB4	1SCA135000R1001	0.045
0 OFF- 1 ON	5 / 5	10	OC10G05PNBN00NB5	1SCA135003R1001	0.052
0 OFF- 1 ON	6 / 6	10	OC10G06PNBN00NB6	1SCA135005R1001	0.054
0 - 1	1 / 1	25	OC25G01PNBN00NA1	1SCA126433R1001	0.081
0 - 1	2 / 2	25	OC25G02PNBN00NA2	1SCA126440R1001	0.086
0 - 1	3 / 3	25	OC25G03PNBN00NA3	1SCA126448R1001	0.102
0 - 1	4 / 4	25	OC25G04PNBN00NA4	1SCA126452R1001	0.108
0 - 1	5 / 5	25	OC25G05PNBN00NA5	1SCA126456R1001	0.124
0 - 1	6 / 6	25	OC25G06PNBN00NA6	1SCA126459R1001	0.129
0 - 1	8 / 8	25	OC25G08PNBN00NA8	1SCA126461R1001	0.153
0 OFF- 1 ON	1 / 1	25	OC25G01PNBN00NB1	1SCA134987R1001	0.081
0 OFF- 1 ON	2 / 2	25	OC25G02PNBN00NB2	1SCA134994R1001	0.086
0 OFF- 1 ON	3 / 3	25	OC25G03PNBN00NB3	1SCA134998R1001	0.102
0 OFF- 1 ON	4 / 4	25	OC25G04PNBN00NB4	1SCA135001R1001	0.108
0 OFF- 1 ON	5 / 5	25	OC25G05PNBN00NB5	1SCA135004R1001	0.124
0 OFF- 1 ON	6 / 6	25	OC25G06PNBN00NB6	1SCA135006R1001	0.129
0 OFF- 1 ON	8 / 8	25	OC25G08PNBN00NB8	1SCA135007R1001	0.153

For more options of standard cam switches, see Order code configuration, pages 40...56.

Ordering information

Rotary cam switches, standard

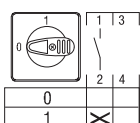

OC_A1

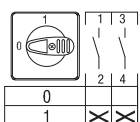

OC_A2

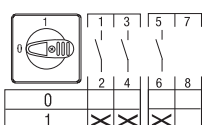

OC_A3

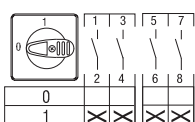

OC_A4

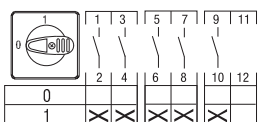

OC_A5

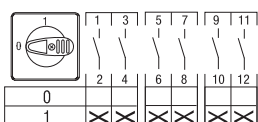

OC_A6

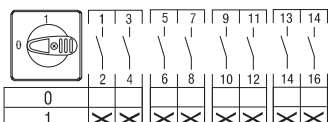

OC_A8

ON - OFF switches

The handle and front plate with position indication are included according to the table below.
Key operated cam switches: the key can be removed in both positions, includes two keys.
The round front ring: to be used in situations when position indications are on the door of the enclosure.

Function	Number of poles/contacts	Rated thermal current I_{th} [A]	Type	Order number	Weight/unit [kg]
O-position: 9 o'clock, step angle 90°, door mounted					
Screw mounted black nose handle, black front frame and silver front plate					
0 - 1	1 / 1	25	OC25G01RNBNO0NA1	1SCA126436R1001	0.152
0 - 1	2 / 2	25	OC25G02RNBNO0NA2	1SCA126442R1001	0.157
0 - 1	3 / 3	25	OC25G03RNBNO0NA3	1SCA126451R1001	0.174
0 - 1	4 / 4	25	OC25G04RNBNO0NA4	1SCA126455R1001	0.179
0 OFF- 1 ON	1 / 1	25	OC25G01RNBNO0NB1	1SCA134988R1001	0.152
0 OFF- 1 ON	2 / 2	25	OC25G02RNBNO0NB2	1SCA134995R1001	0.157
0 OFF- 1 ON	3 / 3	25	OC25G03RNBNO0NB3	1SCA134999R1001	0.174
0 OFF- 1 ON	4 / 4	25	OC25G04RNBNO0NB4	1SCA135002R1001	0.179
Snap-on mounted key operated, black front frame and silver front plate					
0 - 1	1 / 1	10	OC10G01KNBNO0NA1	1SCA126420R1001	0.049
0 - 1	3 / 3	10	OC10G03KNBNO0NA3	1SCA126425R1001	0.058
0 - 1	1 / 1	25	OC25G01KNBNO0NA1	1SCA126430R1001	0.100
0 - 1	3 / 3	25	OC25G03KNBNO0NA3	1SCA126444R1001	0.122
0 OFF- 1 ON	1 / 1	25	OC25G01KNBNO0NB1	1SCA134989R1001	0.100
0 OFF- 1 ON	3 / 3	25	OC25G03KNBNO0NB3	1SCA134997R1001	0.122
Snap-on mounted black nose handle with round black front ring, no engraving					
0 - 1	1 / 1	25	OC25G01PXBN00NA1	1SCA126435R1001	0.075
0 - 1	2 / 2	25	OC25G02PXBN00NA2	1SCA126441R1001	0.080
0 - 1	3 / 3	25	OC25G03PXBN00NA3	1SCA126450R1001	0.097
0 - 1	4 / 4	25	OC25G04PXBN00NA4	1SCA126454R1001	0.102
Snap-on mounted key operated, round front ring, no engraving					
0 - 1	1 / 1	25	OC25G01KXBN00NA1	1SCA126431R1001	0.094
0 - 1	2 / 2	25	OC25G02KXBN00NA2	1SCA126437R1001	0.099
0 - 1	3 / 3	25	OC25G03KXBN00NA3	1SCA126446R1001	0.116
O-position: 9 o'clock, step angle 90°, DIN-rail base mounted					
Modular type, grey handle					
0 - 1	1 / 1	25	OC25G01MNGNO0NA1	1SCA126432R1001	0.084
0 - 1	2 / 2	25	OC25G02MNGNO0NA2	1SCA126439R1001	0.089
0 - 1	3 / 3	25	OC25G03MNGNO0NA3	1SCA126447R1001	0.095
0 - 1	6 / 6	25	OC25G06MNGNO0NA6	1SCA126458R1001	0.112

For more options of standard cam switches, see Order code configuration, pages 40...56.

Ordering information

Rotary cam switches, standard

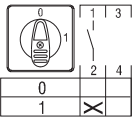

OC_A01

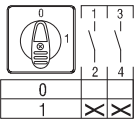

OC_A02

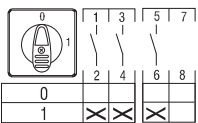

OC_A03

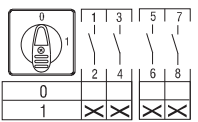

OC_A04

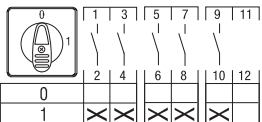

OC_A05

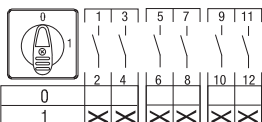

OC_A06

ON - OFF switches

The handle and front plate with position indication are included according to the table below, with simultaneous contacts. Key operated cam switches: the key can be removed in both positions, includes two keys.

Function	Number of poles/contacts	Rated thermal current I_{th} [A]	Type	Order number	Weight/unit [kg]
O-position: 12 o'clock, step angle 90°, door mounted					
Snap-on mounted black nose handle, black front frame and silver front plate					
0 - 1	1 / 1	10	OC10G01PNBN00NA01	1SCA126467R1001	0.034
0 - 1	2 / 2	10	OC10G02PNBN00NA02	1SCA126468R1001	0.036
0 - 1	3 / 3	10	OC10G03PNBN00NA03	1SCA126470R1001	0.043
0 - 1	4 / 4	10	OC10G04PNBN00NA04	1SCA126471R1001	0.045
0 - 1	5 / 5	10	OC10G05PNBN00NA05	1SCA126472R1001	0.052
0 - 1	6 / 6	10	OC10G06PNBN00NA06	1SCA126473R1001	0.054
0 OFF- 1 ON	1 / 1	10	OC10G01PNBN00NB01	1SCA135569R1001	0.034
0 OFF- 1 ON	2 / 2	10	OC10G02PNBN00NB02	1SCA135578R1001	0.036
0 OFF- 1 ON	3 / 3	10	OC10G03PNBN00NB03	1SCA135582R1001	0.043
0 OFF- 1 ON	4 / 4	10	OC10G04PNBN00NB04	1SCA135585R1001	0.045
0 OFF- 1 ON	5 / 5	10	OC10G05PNBN00NB05	1SCA135588R1001	0.052
0 OFF- 1 ON	6 / 6	10	OC10G06PNBN00NB06	1SCA135590R1001	0.054
0 - 1	1 / 1	25	OC25G01PNBN00NA01	1SCA126476R1001	0.081
0 - 1	2 / 2	25	OC25G02PNBN00NA02	1SCA126478R1001	0.086
0 - 1	3 / 3	25	OC25G03PNBN00NA03	1SCA126481R1001	0.102
0 - 1	4 / 4	25	OC25G04PNBN00NA04	1SCA126482R1001	0.108
0 - 1	5 / 5	25	OC25G05PNBN00NA05	1SCA126483R1001	0.124
0 - 1	6 / 6	25	OC25G06PNBN00NA06	1SCA126485R1001	0.129
0 OFF- 1 ON	1 / 1	25	OC25G01PNBN00NB01	1SCA135572R1001	0.081
0 OFF- 1 ON	2 / 2	25	OC25G02PNBN00NB02	1SCA135580R1001	0.086
0 OFF- 1 ON	3 / 3	25	OC25G03PNBN00NB03	1SCA135583R1001	0.102
0 OFF- 1 ON	4 / 4	25	OC25G04PNBN00NB04	1SCA135587R1001	0.108
0 OFF- 1 ON	5 / 5	25	OC25G05PNBN00NB05	1SCA135589R1001	0.124
0 OFF- 1 ON	6 / 6	25	OC25G06PNBN00NB06	1SCA135591R1001	0.129
Screw mounted black nose handle, black front frame and silver front plate					
0 OFF- 1 ON	1 / 1	10	OC10G01RNBN00NB01	1SCA135571R1001	0.034
0 OFF- 1 ON	2 / 2	10	OC10G02RNBN00NB02	1SCA135579R1001	0.036
0 OFF- 1 ON	4 / 4	10	OC10G04RNBN00NB04	1SCA135586R1001	0.045
0 OFF- 1 ON	1 / 1	25	OC25G01RNBN00NB01	1SCA135575R1001	0.152
0 OFF- 1 ON	2 / 2	25	OC25G02RNBN00NB02	1SCA135581R1001	0.157
0 OFF- 1 ON	3 / 3	25	OC25G03RNBN00NB03	1SCA135584R1001	0.174
Snap-on mounted key operated, black front frame and silver front plate					
0 - 1	1 / 1	10	OC10G01KNBN00NA01	1SCA126466R1001	0.049
0 - 1	3 / 3	10	OC10G03KNBN00NA03	1SCA126469R1001	0.058
0 - 1	1 / 1	25	OC25G01KNBN00NA01	1SCA126474R1001	0.100
0 - 1	3 / 3	25	OC25G03KNBN00NA03	1SCA126479R1001	0.122
O-position: 12 o'clock, step angle 90°, DIN-rail base mounted					
Modular type, grey handle					
0 - 1	1 / 1	25	OC25G01MNGN00NA01	1SCA126475R1001	0.084
0 - 1	2 / 2	25	OC25G02MNGN00NA02	1SCA126477R1001	0.089
0 - 1	3 / 3	25	OC25G03MNGN00NA03	1SCA126480R1001	0.095
0 - 1	6 / 6	25	OC25G06MNGN00NA06	1SCA126484R1001	0.112

For more options of standard cam switches, see Order code configuration, pages 40...56.

Ordering information

Rotary cam switches, standard

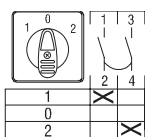

OC_U1

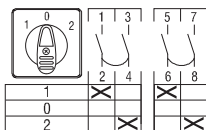

OC_U2

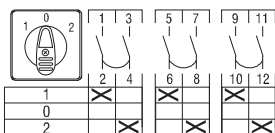

OC_U3

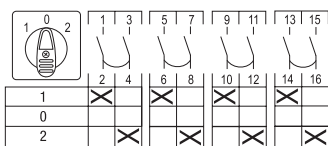

OC_U4

Change-over switches

The handle and front plate with position indication are included according to the table below. Key operated cam switches: the key can be removed in all positions, includes two keys. The round front ring: to be used in situations when position indications are on the door of the enclosure.

Function	Number of poles/contacts	Rated thermal current I_{th} [A]	Type	Order number	Weight/unit [kg]
With 0-position, step angle 60°, door mounted					
Snap-on mounted black nose handle, black front frame and silver front plate					
1 - 0 - 2	1 / 2	10	OC10G02PNBN00NU1	1SCA126487R1001	0.036
1 - 0 - 2	2 / 4	10	OC10G04PNBN00NU2	1SCA126488R1001	0.045
1 - 0 - 2	3 / 6	10	OC10G06PNBN00NU3	1SCA126490R1001	0.055
1 - 0 - 2	4 / 8	10	OC10G08PNBN00NU4	1SCA126491R1001	0.065
1 - 0 - 2	1 / 2	25	OC25G02PNBN00NU1	1SCA126494R1001	0.086
1 - 0 - 2	2 / 4	25	OC25G04PNBN00NU2	1SCA126498R1001	0.108
1 - 0 - 2	3 / 6	25	OC25G06PNBN00NU3	1SCA126503R1001	0.130
1 - 0 - 2	4 / 8	25	OC25G08PNBN00NU4	1SCA126506R1001	0.155
Screw mounted black nose handle, black front frame and silver front plate					
1 - 0 - 2	1 / 2	25	OC25G02RNB00NU1	1SCA126496R1001	0.158
1 - 0 - 2	2 / 4	25	OC25G04RNB00NU2	1SCA126500R1001	0.180
1 - 0 - 2	3 / 6	25	OC25G06RNB00NU3	1SCA126505R1001	0.202
1 - 0 - 2	4 / 8	25	OC25G08RNB00NU4	1SCA126508R1001	0.227
Snap-on mounted key operated, black front frame and silver front plate					
1 - 0 - 2	1 / 2	10	OC10G02KNBN00NU1	1SCA126486R1001	0.051
1 - 0 - 2	3 / 6	10	OC10G06KNBN00NU3	1SCA126489R1001	0.070
1 - 0 - 2	1 / 2	25	OC25G02KNBN00NU1	1SCA126492R1001	0.105
1 - 0 - 2	3 / 6	25	OC25G06KNBN00NU3	1SCA126501R1001	0.149
Snap-on mounted black nose handle with round black front ring, no engraving					
1 - 0 - 2	1 / 2	25	OC25G02PXB00NU1	1SCA126495R1001	0.081
1 - 0 - 2	2 / 4	25	OC25G04PXB00NU2	1SCA126499R1001	0.103
1 - 0 - 2	3 / 6	25	OC25G06PXB00NU3	1SCA126504R1001	0.125
1 - 0 - 2	4 / 8	25	OC25G08PXB00NU4	1SCA126507R1001	0.149
With 0-position, step angle 60°, DIN-rail base mounted					
Modular type, grey handle					
1 - 0 - 2	1 / 2	25	OC25G02MNGN00NU1	1SCA126493R1001	0.090
1 - 0 - 2	2 / 4	25	OC25G04MNGN00NU2	1SCA126497R1001	0.101
1 - 0 - 2	3 / 6	25	OC25G06MNGN00NU3	1SCA126502R1001	0.113

For more options of standard cam switches, see Order code configuration, pages 40...56.

Ordering information

Rotary cam switches, standard

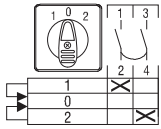

OC_URR1

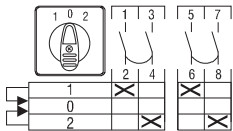

OC_URR2

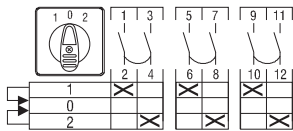

OC_URR3

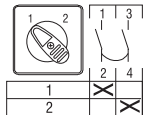

OC_WS1

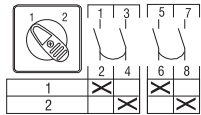

OC_WS2

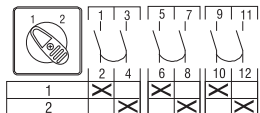

OC_WS3

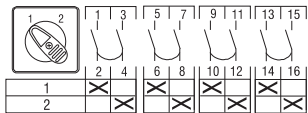

OC_WS4

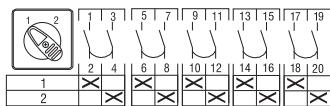

OC_WS5

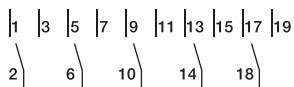

Connection diagram (OC_WS_)

Change-over switches

The handle and front plate with position indication are included according to the table below. The round front ring: to be used in situations when position indications are on the door of the enclosure.

Function	Number of poles/contacts	Rated thermal current I_{th} [A]	Type	Order number	Weight/unit [kg]
With 0-position, with two sided spring return, step angle 30°, door mounted					
Snap-on mounted black nose handle, black front frame and silver front plate					
$1_R - 0 - 2_R$	1 / 2	10	OC10G02PNBN00NURR1	1SCA126509R1001	0.036
$1_R - 0 - 2_R$	3 / 6	10	OC10G06PNBN00NURR3	1SCA126510R1001	0.054
$1_R - 0 - 2_R$	1 / 2	25	OC25G02PNBN00NURR1	1SCA126512R1001	0.086
$1_R - 0 - 2_R$	2 / 4	25	OC25G04PNBN00NURR2	1SCA126513R1001	0.108
$1_R - 0 - 2_R$	3 / 6	25	OC25G06PNBN00NURR3	1SCA126516R1001	0.130
Screw mounted black nose handle, black front frame and silver front plate					
$1_R - 0 - 2_R$	2 / 4	25	OC25G04RNBN00NURR2	1SCA126515R1001	0.180
Snap-on mounted black nose handle with round black front ring, no engraving					
$1_R - 0 - 2_R$	2 / 4	25	OC25G04PXB00NURR2	1SCA126514R1001	0.103
With 0-position, with two sided spring return, step angle 30°, DIN-rail base mounted					
Modular type, grey handle					
$1_R - 0 - 2_R$	1 / 2	25	OC25G02MNGN00NURR1	1SCA126511R1001	0.090
Without 0-position, step angle 60°, door mounted					
Snap-on mounted black nose handle, black front frame and silver front plate					
1 - 2	1 / 2	10	OC10G02PNBN00NWS1	1SCA126517R1001	0.036
1 - 2	2 / 4	10	OC10G04PNBN00NWS2	1SCA126518R1001	0.045
1 - 2	3 / 6	10	OC10G06PNBN00NWS3	1SCA126519R1001	0.055
1 - 2	4 / 8	10	OC10G08PNBN00NWS4	1SCA126520R1001	0.065
1 - 2	1 / 2	25	OC25G02PNBN00NWS1	1SCA126522R1001	0.086
1 - 2	2 / 4	25	OC25G04PNBN00NWS2	1SCA126526R1001	0.108
1 - 2	3 / 6	25	OC25G06PNBN00NWS3	1SCA126530R1001	0.130
1 - 2	4 / 8	25	OC25G08PNBN00NWS4	1SCA126533R1001	0.155
1 - 2	5 / 10	25	OC25G10PNBN00NWS5	1SCA126536R1001	0.177
Screw mounted black nose handle, black front frame and silver front plate					
1 - 2	1 / 2	25	OC25G02RNBN00NWS1	1SCA126524R1001	0.158
1 - 2	2 / 4	25	OC25G04RNBN00NWS2	1SCA126528R1001	0.180
1 - 2	3 / 6	25	OC25G06RNBN00NWS3	1SCA126532R1001	0.202
1 - 2	4 / 8	25	OC25G08RNBN00NWS4	1SCA126535R1001	0.227
Snap-on mounted black nose handle with round black front ring, no engraving					
1 - 2	1 / 2	25	OC25G02PXB00NWS1	1SCA126523R1001	0.081
1 - 2	2 / 4	25	OC25G04PXB00NWS2	1SCA126527R1001	0.103
1 - 2	3 / 6	25	OC25G06PXB00NWS3	1SCA126531R1001	0.125
1 - 2	4 / 8	25	OC25G08PXB00NWS4	1SCA126534R1001	0.149
Without 0-position, step angle 60°, DIN-rail base mounted					
Modular type, grey handle					
1 - 2	1 / 2	25	OC25G02MNGN00NWS1	1SCA126521R1001	0.090
1 - 2	2 / 4	25	OC25G04MNGN00NWS2	1SCA126525R1001	0.101
1 - 2	3 / 6	25	OC25G06MNGN00NWS3	1SCA126529R1001	0.113

For more options of standard cam switches, see Order code configuration, pages 40...56.

Ordering information

Rotary cam switches, standard

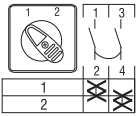

OC_WC1

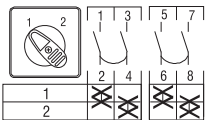

OC_WC2

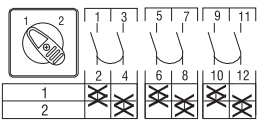

OC_WC3

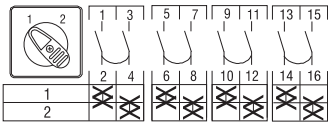

OC_WC4

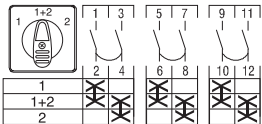

OC_UC3

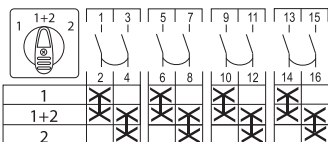

OC_UC4

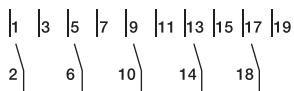

Connection diagram
(OC_WC_, OC_UC_)

Change-over switches

The handle and front plate with position indication are included according to the table below.
The round front ring: to be used in situations when position indications are on the door of the enclosure.

Function	Number of poles/ contacts	Rated thermal current I_m [A]	Type	Order number	Weight/ unit [kg]
With overlapping contacts, step angle 60°, door mounted					
Snap-on mounted black nose handle, black front frame and silver front plate					
1 - 2	1 / 2	10	OC10G02PNBN00NWC1	1SCA126537R1001	0.036
1 - 2	2 / 4	10	OC10G04PNBN00NWC2	1SCA126538R1001	0.045
1 - 2	3 / 6	10	OC10G06PNBN00NWC3	1SCA126539R1001	0.055
1 - 2	4 / 8	10	OC10G08PNBN00NWC4	1SCA126540R1001	0.065
1 - 2	1 / 2	25	OC25G02PNBN00NWC1	1SCA126541R1001	0.086
1 - 2	2 / 4	25	OC25G04PNBN00NWC2	1SCA126542R1001	0.108
1 - 2	3 / 6	25	OC25G06PNBN00NWC3	1SCA126543R1001	0.130
1 - 2	4 / 8	25	OC25G08PNBN00NWC4	1SCA126544R1001	0.155
With common center position and with overlapping contacts, step angle 60°, door mounted					
Snap-on mounted black nose handle, black front frame and silver front plate					
1 - (1 + 2) - 2	3 / 6	25	OC25G06PNBN00NUC3	1SCA126545R1001	0.130
1 - (1 + 2) - 2	4 / 8	25	OC25G08PNBN00NUC4	1SCA126546R1001	0.155

For more options of standard cam switches, see Order code configuration, pages 40...56.

Ordering information

Rotary cam switches, standard

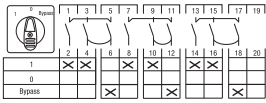

OC_WS36

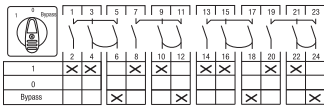

OC_WS48

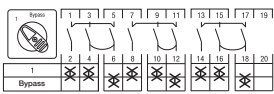

OC_PW36

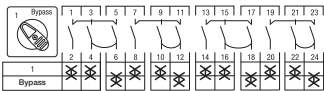

OC_PW48

Bypass switches

The handle and front plate with position indication are included according to the table below.

Function	Number of poles/ contacts	Rated thermal current I_{th} [A]	Type	Order number	Weight/unit [kg]
With 0-position, step angle 60°, without overlapping, 3 and 4- pole network, door mounted					
Snap-on mounted black nose handle, black front frame and silver front plate					
1 - 0 - Bypass	3;6 / 9	25	OC25G09PNBN00NWS36	1SCA126547R1001	0.172
1 - 0 - Bypass	4;8 / 12	25	OC25G12PNBN00NWS48	1SCA126548R1001	0.200
Without 0-position, step angle 60°, with overlapping, 3 and 4- pole network, door mounted					
Snap-on mounted black nose handle, black front frame and silver front plate					
1 - Bypass	3;6 / 9	25	OC25G09PNBN00NPW36	1SCA126549R1001	0.172
1 - Bypass	4;8 / 12	25	OC25G12PNBN00NPW48	1SCA126550R1001	0.200

For more options of standard cam switches, see Order code configuration, pages 40...56.

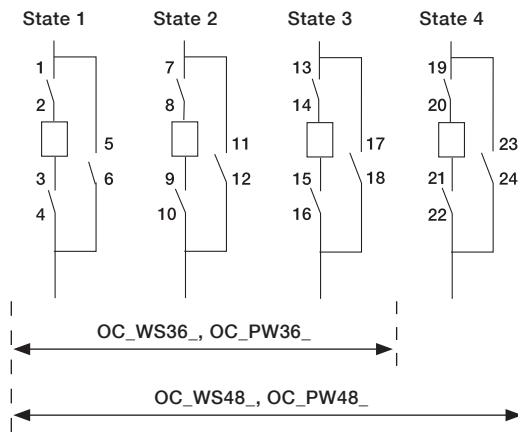

Ordering information

Rotary cam switches, standard

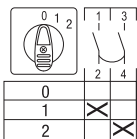

OC_S021

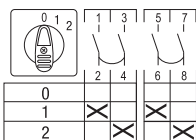

OC_S022

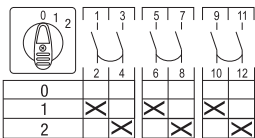

OC_S023

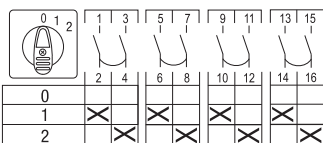

OC_S024

Multistep switches

The handle and front plate with position indication are included according to the table below.
The round front ring: to be used in situations when position indications are on the door of the enclosure. Step angle 30°.

Function	Number of poles/contacts	Rated thermal current I_n [A]	Type	Order number	Weight/unit [kg]
2- step, with 0-position, door mounted					
Snap-on mounted black nose handle, black front frame and silver front plate					
0 - 1 - 2	1 / 2	10	OC10G02PNBN00NSO21	1SCA126551R1001	0.036
0 - 1 - 2	2 / 4	10	OC10G04PNBN00NSO22	1SCA126552R1001	0.045
0 - 1 - 2	3 / 6	10	OC10G06PNBN00NSO23	1SCA126553R1001	0.055
0 - 1 - 2	4 / 8	10	OC10G08PNBN00NSO24	1SCA126554R1001	0.065
0 - 1 - 2	1 / 2	25	OC25G02PNBN00NSO21	1SCA126556R1001	0.087
0 - 1 - 2	2 / 4	25	OC25G04PNBN00NSO22	1SCA126559R1001	0.109
0 - 1 - 2	3 / 6	25	OC25G06PNBN00NSO23	1SCA126562R1001	0.131
0 - 1 - 2	4 / 8	25	OC25G08PNBN00NSO24	1SCA126563R1001	0.155
Screw mounted black nose handle, black front frame and silver front plate					
0 - 1 - 2	1 / 2	25	OC25G02RNB00NSO21	1SCA126558R1001	0.158
0 - 1 - 2	2 / 4	25	OC25G04RNB00NSO22	1SCA126561R1001	0.180
Snap-on mounted black nose handle with round black front ring, no engraving					
0 - 1 - 2	1 / 2	25	OC25G02PXBN00NSO21	1SCA126557R1001	0.081
0 - 1 - 2	2 / 4	25	OC25G04PXBN00NSO22	1SCA126560R1001	0.103
2- step, with 0-position, DIN-rail base mounted					
Modular type, grey handle					
0 - 1 - 2	1 / 2	25	OC25G02MNGN00NSO21	1SCA126555R1001	0.090

For more options of standard cam switches, see Order code configuration, pages 40...56.

Ordering information

Rotary cam switches, standard

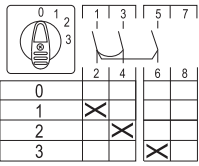

OC_SO31

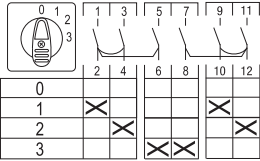

OC_SO32

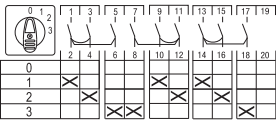

OC_SO33

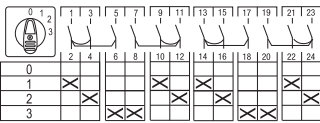

OC_SO34

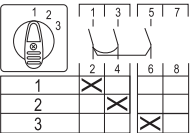

OC_ST31

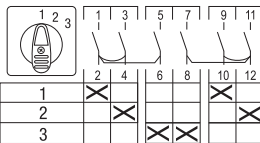

OC_ST32

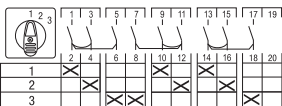

OC_ST33

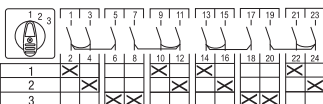

OC_ST34

Multistep switches

The handle and front plate with position indication are included according to the table below. The round front ring: to be used in situations when position indications are on the door of the enclosure. Step angle 30°.

Function	Number of poles/contacts	Rated thermal current I _{th} [A]	Type	Order number	Weight/unit [kg]
3- step, with 0-position, door mounted					
Snap-on mounted black nose handle, black front frame and silver front plate					
0 - 1 - 2 - 3	1 / 3	10	OC10G03PNBN00NSO31	1SCA126564R1001	0.043
0 - 1 - 2 - 3	2 / 6	10	OC10G06PNBN00NSO32	1SCA126565R1001	0.055
0 - 1 - 2 - 3	3 / 9	10	OC10G09PNBN00NSO33	1SCA126566R1001	0.073
0 - 1 - 2 - 3	4 / 12	10	OC10G12PNBN00NSO34	1SCA126567R1001	0.084
0 - 1 - 2 - 3	1 / 3	25	OC25G03PNBN00NSO31	1SCA126569R1001	0.103
0 - 1 - 2 - 3	2 / 6	25	OC25G06PNBN00NSO32	1SCA126572R1001	0.131
0 - 1 - 2 - 3	3 / 9	25	OC25G09PNBN00NSO33	1SCA126573R1001	0.172
0 - 1 - 2 - 3	4 / 12	25	OC25G12PNBN00NSO34	1SCA126574R1001	0.200
Screw mounted black nose handle, black front frame and silver front plate					
0 - 1 - 2 - 3	1 / 3	25	OC25G03RNB00NSO31	1SCA126571R1001	0.175
Snap-on mounted black nose handle with round black front ring, no engraving					
0 - 1 - 2 - 3	1 / 3	25	OC25G03PXB00NSO31	1SCA126570R1001	0.098
3- step, with 0-position, DIN-rail base mounted					
Modular type, grey handle					
0 - 1 - 2 - 3	1 / 3	25	OC25G03MNGN00NSO31	1SCA126568R1001	0.096
3- step, without 0-position, door mounted					
Snap-on mounted black nose handle, black front frame and silver front plate					
1 - 2 - 3	1 / 3	10	OC10G03PNBN00NST31	1SCA126575R1001	0.043
1 - 2 - 3	2 / 6	10	OC10G06PNBN00NST32	1SCA126576R1001	0.055
1 - 2 - 3	3 / 9	10	OC10G09PNBN00NST33	1SCA126577R1001	0.073
1 - 2 - 3	4 / 12	10	OC10G12PNBN00NST34	1SCA126578R1001	0.084
1 - 2 - 3	1 / 3	25	OC25G03PNBN00NST31	1SCA126580R1001	0.103
1 - 2 - 3	2 / 6	25	OC25G06PNBN00NST32	1SCA126583R1001	0.131
1 - 2 - 3	3 / 9	25	OC25G09PNBN00NST33	1SCA126584R1001	0.172
1 - 2 - 3	4 / 12	25	OC25G12PNBN00NST34	1SCA126585R1001	0.200
Screw mounted black nose handle, black front frame and silver front plate					
1 - 2 - 3	1 / 3	25	OC25G03RNB00NST31	1SCA126582R1001	0.175
Snap-on mounted black nose handle with round black front ring, no engraving					
1 - 2 - 3	1 / 3	25	OC25G03PXB00NST31	1SCA126581R1001	0.098
3- step, without 0-position, DIN-rail base mounted					
Modular type, grey handle					
1 - 2 - 3	1 / 3	25	OC25G03MNGN00NST31	1SCA126579R1001	0.096

For more options of standard cam switches, see Order code configuration, pages 40...56.

Ordering information

Rotary cam switches, standard

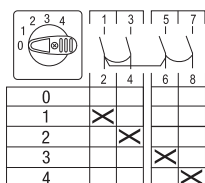

OC_S041

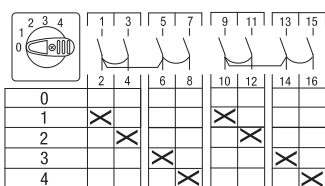

OC_S042

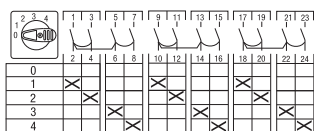

OC_S043

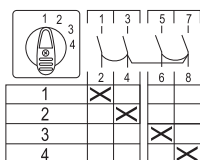

OC_ST41

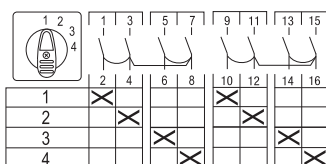

OC_ST42

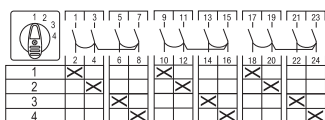

OC_ST43

Multistep switches

The handle and front plate with position indication are included according to the table below. The round front ring: to be used in situations when position indications are on the door of the enclosure. Step angle 30°

Function	Number of poles/contacts	Rated thermal current I_n [A]	Type	Order number	Weight/unit [kg]
4- step, with 0-position, door mounted					
Snap-on mounted black nose handle, black front frame and silver front plate					
0-1-2-3-4	1 / 4	10	OC10G04PNBN00NSO41	1SCA126586R1001	0.045
0-1-2-3-4	2 / 8	10	OC10G08PNBN00NSO42	1SCA126587R1001	0.065
0-1-2-3-4	3 / 12	10	OC10G12PNBN00NSO43	1SCA126588R1001	0.084
0-1-2-3-4	1 / 4	25	OC25G04PNBN00NSO41	1SCA126589R1001	0.109
0-1-2-3-4	2 / 8	25	OC25G08PNBN00NSO42	1SCA126590R1001	0.155
0-1-2-3-4	3 / 12	25	OC25G12PNBN00NSO43	1SCA126591R1001	0.201
4- step, without 0-position, door mounted					
Snap-on mounted black nose handle, black front frame and silver front plate					
1-2-3-4	1 / 4	10	OC10G04PNBN00NST41	1SCA126592R1001	0.045
1-2-3-4	2 / 8	10	OC10G08PNBN00NST42	1SCA126593R1001	0.065
1-2-3-4	3 / 12	10	OC10G12PNBN00NST43	1SCA126594R1001	0.084
1-2-3-4	1 / 4	25	OC25G04PNBN00NST41	1SCA126595R1001	0.109
1-2-3-4	2 / 8	25	OC25G08PNBN00NST42	1SCA126598R1001	0.155
1-2-3-4	3 / 12	25	OC25G12PNBN00NST43	1SCA126599R1001	0.201
Screw mounted black nose handle, black front frame and silver front plate					
1-2-3-4	1 / 4	25	OC25G04RNBN00NST41	1SCA126597R1001	0.180
Snap-on mounted black nose handle with round black front ring, no engraving					
1-2-3-4	1 / 4	25	OC25G04PXBN00NST41	1SCA126596R1001	0.103

For more options of standard cam switches, see Order code configuration, pages 40...56.

Ordering information

Rotary cam switches, standard

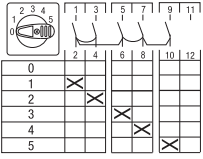

OC_S051

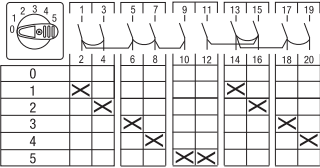

OC_S052

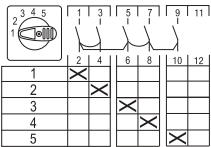

OC_ST51

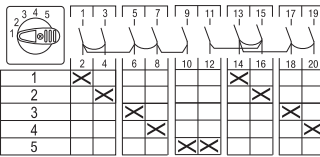

OC_ST52

Multistep switches

The handle and front plate with position indication are included according to the table below. The round front ring: to be used in situations when position indications are on the door of the enclosure. Step angle 30°

Function	Number of poles/contacts	Rated thermal current I _n [A]	Type	Order number	Weight/unit [kg]
5- step, with 0-position, door mounted					
Snap-on mounted black nose handle, black front frame and silver front plate					
0-1-2-3-4-5	1 / 5	10	OC10G05PNBN00NSO51	1SCA126600R1001	0.053
0-1-2-3-4-5	2 / 10	10	OC10G10PNBN00NSO52	1SCA126601R1001	0.075
0-1-2-3-4-5	1 / 5	25	OC25G05PNBN00NSO51	1SCA126602R1001	0.126
0-1-2-3-4-5	2 / 10	25	OC25G10PNBN00NSO52	1SCA126603R1001	0.178
5- step, without 0-position, door mounted					
Snap-on mounted black nose handle, black front frame and silver front plate					
1-2-3-4-5	1 / 5	10	OC10G05PNBN00NST51	1SCA126604R1001	0.053
1-2-3-4-5	2 / 10	10	OC10G10PNBN00NST52	1SCA126605R1001	0.075
1-2-3-4-5	1 / 5	25	OC25G05PNBN00NST51	1SCA126606R1001	0.126
1-2-3-4-5	2 / 10	25	OC25G10PNBN00NST52	1SCA126607R1001	0.178

For more options of standard cam switches, see Order code configuration, pages 40...56.

Ordering information

Rotary cam switches, standard

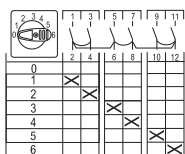

OC_SO61

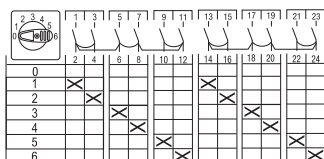

OC_SO62

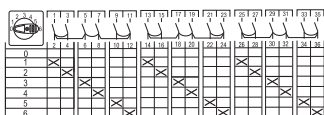

OC_SO63

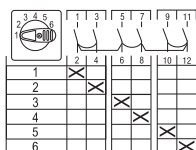

OC_ST61

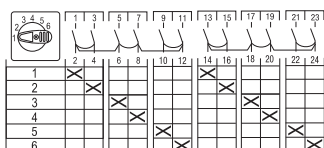

OC_ST62

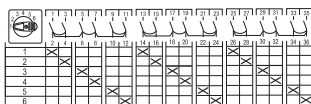

OC_ST63

Multistep switches

The handle and front plate with position indication are included according to the table below.
Step angle 30°

Function	Number of poles/ contacts	Rated thermal current I_{th} [A]	Type	Order number	Weight/ unit [kg]
6-step, with 0-position, door mounted					
Snap-on mounted black nose handle, black front frame and silver front plate					
0-1-2-3-4-5-6	1 / 6	25	OC25G06PNBN00NSO61	1SCA126608R1001	0.132
	2 / 12	25	OC25G12PNBN00NSO62	1SCA126609R1001	0.202
	3 / 18	25	OC25G18PNBN00NSO63	1SCA126610R1001	0.270
6-step, without 0-position, door mounted					
Snap-on mounted black nose handle, black front frame and silver front plate					
1-2-3-4-5-6	1 / 6	25	OC25G06PNBN00NST61	1SCA126611R1001	0.131
	2 / 12	25	OC25G12PNBN00NST62	1SCA126612R1001	0.201
	3 / 18	25	OC25G18PNBN00NST63	1SCA126613R1001	0.269

For more options of standard cam switches, see Order code configuration, pages 40...56.

Ordering information

Rotary cam switches, standard

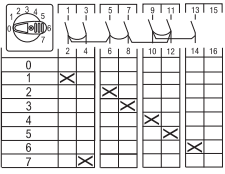

OC_S071

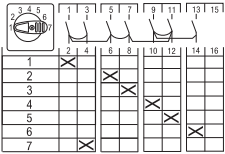

OC_ST71

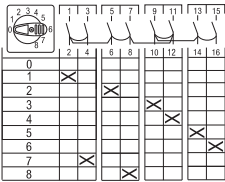

OC_S081

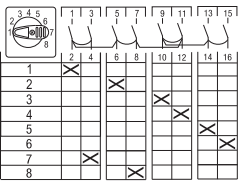

OC_ST81

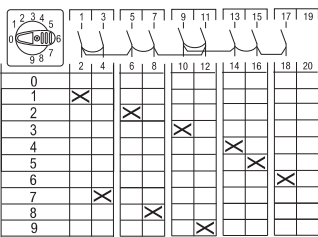

OC_S091

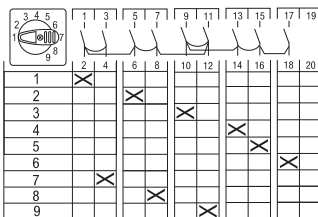

OC_ST91

Multistep switches

The handle and front plate with position indication are included according to the table below. Step angle 30°.

Function	Number of poles/contacts	Rated thermal current I_{th} [A]	Type	Order number	Weight/unit [kg]
7-step, with 0-position, door mounted					
Snap-on mounted black nose handle, black front frame and silver front plate					
0-1-2-3-4-5-6-7	1 / 7	25	OC25G07PNBN00NSO71	1SCA126614R1001	0.151
7-step, without 0-position, door mounted					
Snap-on mounted black nose handle, black front frame and silver front plate					
1-2-3-4-5-6-7	1 / 7	25	OC25G07PNBN00NST71	1SCA126615R1001	0.151
8-step, with 0-position, door mounted					
Snap-on mounted black nose handle, black front frame and silver front plate					
0-1-2-3-4-5-6-7-8	1 / 8	25	OC25G08PNBN00NSO81	1SCA126616R1001	0.156
8-step, without 0-position, door mounted					
Snap-on mounted black nose handle, black front frame and silver front plate					
1-2-3-4-5-6-7-8	1 / 8	25	OC25G08PNBN00NST81	1SCA126617R1001	0.156
9-step, with 0-position, door mounted					
Snap-on mounted black nose handle, black front frame and silver front plate					
0-1-2-3-4-5-6-7-8-9	1 / 9	25	OC25G09PNBN00NSO91	1SCA126618R1001	0.173
9-step, without 0-position, door mounted					
Snap-on mounted black nose handle, black front frame and silver front plate					
1-2-3-4-5-6-7-8-9	1 / 9	25	OC25G09PNBN00NST91	1SCA126619R1001	0.173

For more options of standard cam switches, see Order code configuration, pages 40...56.

Ordering information

Rotary cam switches, standard

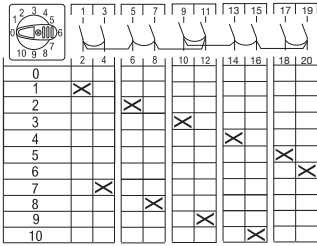

OC_SO10

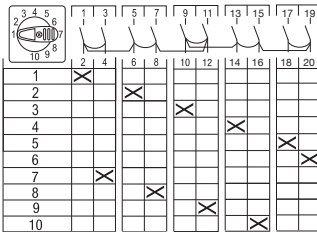

OC_ST10

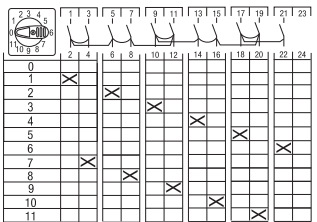

OC_SO11

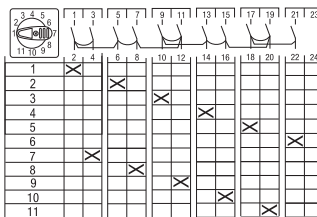

OC_ST11

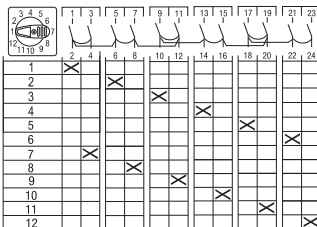

OC_ST12

Multistep switches

The handle and front plate with position indication are included according to the table below. Step angle 30°.

Function	Number of poles/contacts	Rated thermal current I _n [A]	Type	Order number	Weight/unit [kg]
10-step, with 0-position, door mounted					
Snap-on mounted black nose handle, black front frame and silver front plate					
0-1-2-3-4-5-6-7-8-9-10	1 / 10	25	OC25G10PNBN00NSO10	1SCA126620R1001	0.179
10-step, without 0-position, door mounted					
Snap-on mounted black nose handle, black front frame and silver front plate					
1-2-3-4-5-6-7-8-9-10	1 / 10	25	OC25G10PNBN00NST10	1SCA126621R1001	0.179
11-step, with 0-position, door mounted					
Snap-on mounted black nose handle, black front frame and silver front plate					
0-1-2-3-4-5-6-7-8-9-10-11	1 / 11	25	OC25G11PNBN00NSO11	1SCA126622R1001	0.197
11-step, without 0-position, door mounted					
Snap-on mounted black nose handle, black front frame and silver front plate					
1-2-3-4-5-6-7-8-9-10-11	1 / 11	25	OC25G11PNBN00NST11	1SCA126623R1001	0.197
12-step, without 0-position, door mounted					
Snap-on mounted black nose handle, black front frame and silver front plate					
1-2-3-4-5-6-7-8-9-10-11-12	1 / 12	25	OC25G12PNBN00NST12	1SCA126624R1001	0.202

For more options of standard cam switches, see Order code configuration, pages 40...56.

Ordering information

Rotary cam switches, standard

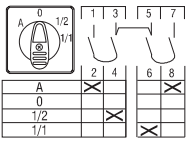

OC_ST30

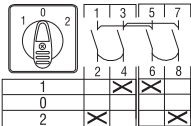

OC_W2

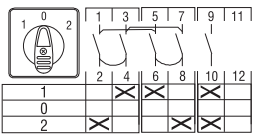

OC_W3

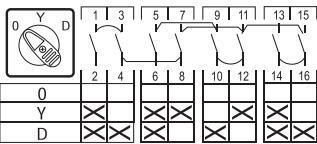

OC_SD

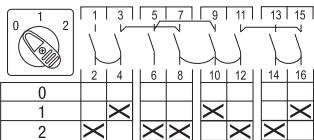

OC_P12

Motor control switches

The handle and front plate with position indication are included according to the table below.

Function	Number of poles/ contacts	Rated thermal current I_{th} [A]	Motor rating AC23/400V [kW]	Type	Order number	Weight/unit [kg]
----------	---------------------------	------------------------------------	-----------------------------	------	--------------	------------------

Ventilation switches

Door mounted, snap-on mounted black nose handle, black front frame and silver front plate

A-0-1/2-1/1	2 / 4	10	3	OC10G04PNBN00NST30	1SCA126625R1001	0.045
A-0-1/2-1/1	2 / 4	25	7.5	OC25G04PNBN00NST30	1SCA126627R1001	0.109

Modular DIN-rail base mounted, grey handle

A-0-1/2-1/1	2 / 4	25	7.5	OC25G04MNGN00NST30	1SCA126626R1001	0.102
-------------	-------	----	-----	--------------------	-----------------	-------

Reversing switches

Door mounted, snap-on mounted black nose handle, black front frame and silver front plate

1-0-2	2 / 4	25	7.5	OC25G04PNBN00NW2	1SCA126628R1001	0.109
1-0-2	3 / 5	25	7.5	OC25G05PNBN00NW3	1SCA126629R1001	0.126

Star-delta switches

Door mounted, snap-on mounted black nose handle, black front frame and silver front plate

0-Y-Δ	3 / 8	25	7.5	OC25G08PNBN00NSD	1SCA126630R1001	0.156
-------	-------	----	-----	------------------	-----------------	-------

Pole-change switches (Dahlander)

Door mounted, snap-on mounted black nose handle, black front frame and silver front plate

Winding for 2 speeds, one direction, 0-A-YY

0-1-2	3 / 8	25	7.5	OC25G08PNBN00NP12	1SCA126631R1001	0.156
-------	-------	----	-----	-------------------	-----------------	-------

For more options of standard cam switches, see Order code configuration, pages 40...56.

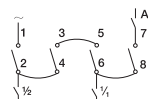

OC_ST30

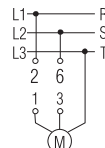

OC_W2

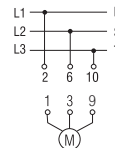

OC_W3

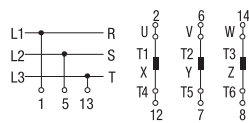

OC_SD

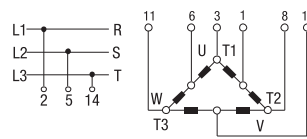

OC_P12

Ordering information

Rotary cam switches, standard

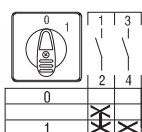

OC_SE15

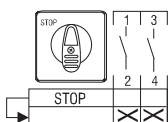

OC_SA2

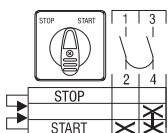

OC_SEA1

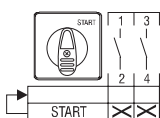

OC_SE2

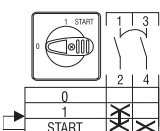

OC_SEA0

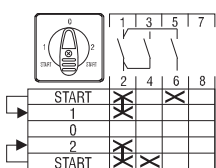

OC_UR13

Motor control switches

The handle and front plate with position indication are included according to the table below.
The round front ring: to be used in situations when position indications are on the door of the enclosure.

Function	Number of poles/ contacts	Rated thermal current I_n [A]	Type	Order number	Weight/ unit [kg]
Pumpstart switches					
Door mounted, snap-on mounted black nose handle, black front frame and silver front plate. Step angle 60°.					
0-1	1 / 2	10	OC10G02PNBN00NSE15	1SCA126632R1001	0.036
0-1	1 / 2	25	OC25G02PNBN00NSE15	1SCA126634R1001	0.086
Modular DIN-rail base mounted, grey handle. Step angle 60°.					
0-1	1 / 2	25	OC25G02MNGN00NSE15	1SCA126633R1001	0.089
Stop switches					
Door mounted, snap-on mounted black nose handle, black front frame and silver front plate					
Step angle 30°, with spring return, contacts N.C.					
0 _R -Stop	2 / 2	10	OC10G02PNBN00NSA2	1SCA126635R1001	0.036
0 _R -Stop	2 / 2	25	OC25G02PNBN00NSA2	1SCA126636R1001	0.086
Start switches, with spring return					
Door mounted, snap-on mounted black nose handle, black front frame and silver front plate					
Step angle 30°					
Stop-Start	1 / 2	25	OC25G02PNBN00NSEA1	1SCA126637R1001	0.086
0 _R -Start	1 / 2	10	OC10G02PNBN00NSE2	1SCA126643R1001	0.036
0 _R -Start	1 / 2	25	OC25G02PNBN00NSE2	1SCA126644R1001	0.086
Step angle 90°- 30°					
0-1 _R -Start	1 / 2	10	OC10G02PNBN00NSEA0	1SCA126638R1001	0.036
0-1 _R -Start	1 / 2	25	OC25G02PNBN00NSEA0	1SCA126640R1001	0.086
Start-1 _R -0-2 _R -	1 / 3	25	OC25G03PNBN00NUR13	1SCA126646R1001	0.103
Start					
Door mounted, screw mounted black nose handle, black front frame and silver front plate					
Step angle 90°- 30°					
0-1 _R -Start	1 / 2	25	OC25G02RNBN00NSEA0	1SCA126642R1001	0.158
Door mounted, snap-on mounted black nose handle with round black front ring, no engraving					
Step angle 90°- 30°					
0-1 _R -Start	1 / 2	25	OC25G02PXB00NSEA0	1SCA126641R1001	0.081
Modular DIN-rail base mounted, grey handle					
Step angle 90°- 30°					
0-1 _R -Start	1 / 2	25	OC25G02MNGN00NSEA0	1SCA126639R1001	0.090
Start-1 _R -0-2 _R -	1 / 3	25	OC25G03MNGN00NUR13	1SCA126645R1001	0.097
Start					

For more options of standard cam switches, see Order code configuration, pages 40...56.

Ordering information

Rotary cam switches, standard

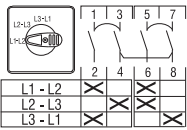

OC_VN3

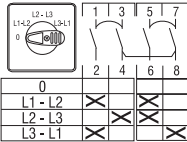

OC_V3

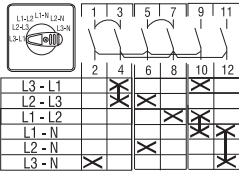

OC_VN30

Voltmeter switches

The handle and front plate with position indication are included according to the table below.
The round front ring: to be used in situations when position indications are on the door of the enclosure.

Function	Number of contacts	Rated thermal current I_{th} [A]	Type	Order number	Weight/unit [kg]
3 Positions, 3 phase -3 wire, without 0-position, step angle 45°					
Door mounted, snap-on mounted black nose handle, black front frame and silver front plate					
L1-L2, L2-L3, L3-L1	4	10	OC10G04PNBN00NVN3	1SCA126647R1001	0.045
Modular DIN-rail base mounted, grey handle					
L1-L2, L2-L3, L3-L1	4	25	OC25G04PNBN00NVN3	1SCA126649R1001	0.109
Door mounted, screw mounted black nose handle, black front frame and silver front plate					
L1-L2, L2-L3, L3-L1	4	25	OC25G04MNGN00NVN3	1SCA126648R1001	0.102
4 Positions, 3 phase -3 wire, with 0-position, step angle 45°					
Door mounted, snap-on mounted black nose handle, black front frame and silver front plate					
0, L1-L2, L2-L3, L3-L1	4	10	OC10G04PNBN00NV3	1SCA126650R1001	0.045
0, L1-L2, L2-L3, L3-L1	4	25	OC25G04PNBN00NV3	1SCA126652R1001	0.109
Door mounted, screw mounted black nose handle, black front frame and silver front plate					
0, L1-L2, L2-L3, L3-L1	4	25	OC25G04RNBN00NV3	1SCA126654R1001	0.180
Door mounted, snap-on mounted black nose handle with round black front ring, no engraving					
0, L1-L2, L2-L3, L3-L1	4	25	OC25G04PXBN00NV3	1SCA126653R1001	0.103
DIN-rail mounted					
0, L1-L2, L2-L3, L3-L1	4	25	OC25G04MNGN00NV3	1SCA126651R1001	0.102
6 Positions, 3 phase to phase, 3 phase to neutral, without 0-position, step angle 30°					
Door mounted, snap-on mounted black nose handle, black front frame and silver front plate					
L3-L1, L2-L3, L1-L2, L1-N, L2-N, L3-N	6	10	OC10G06PNBN00NVN30	1SCA126655R1001	0.055
L3-L1, L2-L3, L1-L2, L1-N, L2-N, L3-N	6	25	OC25G06PNBN00NVN30	1SCA126657R1001	0.132
Modular DIN-rail base mounted, grey handle					
L3-L1, L2-L3, L1-L2, L1-N, L2-N, L3-N	6	25	OC25G06MNGN00NVN30	1SCA126656R1001	0.114

For more options of standard cam switches, see Order code configuration, pages 40...56.

Ordering information

Rotary cam switches, standard

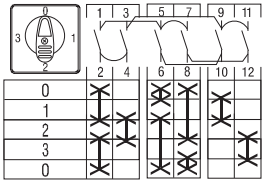

OC_AU31

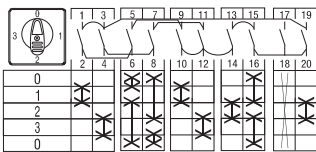

OC_AU32

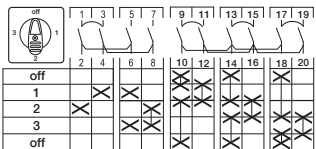

OC_VA21

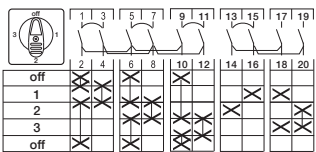

OC_AV12

Ammeter switches

The handle and front plate with position indication are included according to the table below. The round front ring: to be used in situations when position indications are on the door of the enclosure. No stop at last position.

Function	Number of contacts	Rated thermal current I_n [A]	Type	Order number	Weight/unit [kg]
For 3 current transformer circuits, with 0-position, step angle 90°					
Door mounted, snap-on mounted black nose handle, black front frame and silver front plate					
Single pole					
0-1-2-3	6	10	OC10G06PNBN00NAU31	1SCA126665R1001	0.055
0-1-2-3	6	25	OC25G06PNBN00NAU31	1SCA126667R1001	0.132
2 pole or direct measurement in 3 phases					
0-1-2-3	10	25	OC25G10PNBN00NAU32	1SCA126670R1001	0.179
Door mounted, screw mounted black nose handle, black front frame and silver front plate					
Single pole					
0-1-2-3	6	25	OC25G06RNB00NAU31	1SCA126669R1001	0.204
Door mounted, snap-on mounted black nose handle with round black front ring, no engraving					
Single pole					
0-1-2-3	6	25	OC25G06PXB00NAU31	1SCA126668R1001	0.126
Modular DIN-rail base mounted, grey handle					
Single pole					
0-1-2-3	6	25	OC25G06MNGN00NAU31	1SCA126666R1001	0.115

Volt-ammeter switches

The handle and front plate with position indication are included according to the table below. The type and the order number are for one piece. No stop at last position.

Function	Number of contacts	Rated thermal current I_n [A]	Type	Order number	Weight/unit [kg]
Measuring between phases and 3 current transformers with common pole, step angle 90°					
OFF-1-2-3	10	25	OC25G10PNBN00NVA21	1SCA126671R1001	0.179
OFF-1-2-3	10	25	OC25G10PNBN00NAV12	1SCA126672R1001	0.179

For more options of standard cam switches, see Order code configuration, pages 40...56.

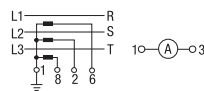

OC_AU31

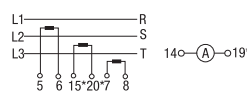

O_AU32

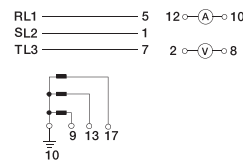

OC_VA

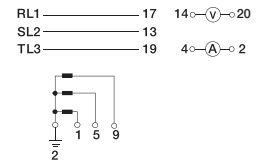

OC_AV

Ordering information

Rotary cam switches, standard

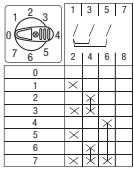

OC_B070

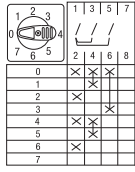

OC_B071

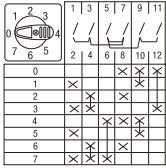

OC_B072

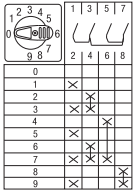

OC_B090

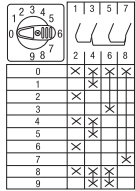

OC_B091

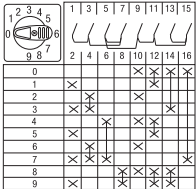

OC_B092

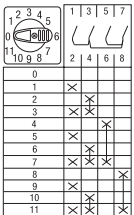

OC_B110

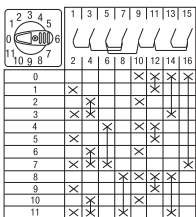

OC_B112

Binarycode switches

The handle and front plate with position indication are included according to the table below.

Function	Number of contacts	Rated thermal current I_{th} [A]	Type	Order number	Weight/unit [kg]
With 0-position, step angle 30° / 45°					
Door mounted, snap-on mounted black nose handle, black front frame and silver front plate					
0-1-2-3-4-5-6-7*	3	25	OC25G03PNBN00NB070	1SCA126673R1001	0.104
0-1-2-3-4-5-6-7*	3	25	OC25G03PNBN00NB071	1SCA126674R1001	0.104
0-1-2-3-4-5-6-7*	6	25	OC25G06PNBN00NB072	1SCA126678R1001	0.132
0-1-2-3-4-5-6-7-8-9	4	25	OC25G04PNBN00NB090	1SCA126675R1001	0.109
0-1-2-3-4-5-6-7-8-9	4	25	OC25G04PNBN00NB091	1SCA126676R1001	0.109
0-1-2-3-4-5-6-7-8-9	8	25	OC25G08PNBN00NB092	1SCA126679R1001	0.156
0-1-2-3-4-5-6-7-8-9-10-11*	4	25	OC25G04PNBN00NB110	1SCA126677R1001	0.109
0-1-2-3-4-5-6-7-8-9-10-11*	8	25	OC25G08PNBN00NB112	1SCA126680R1001	0.156

* No stop at last position.

For more options of standard cam switches, see Order code configuration, pages 40...56.

Ordering information

Rotary cam switches, standard

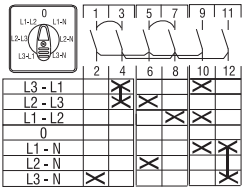

OC_V30

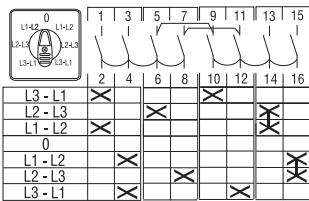

OC_V32

Voltmeter switches

The handle and front plate with position indication are included according to the table below. The round front ring: to be used in situations when position indications are on the door of the enclosure.

Function	Number of contacts	Rated thermal current I_n [A]	Type	Order number	Weight/unit [kg]
7 Positions, 3 phase to phase 3 phase to neutral, with 0-position, step angle 45°					
Door mounted, snap-on mounted black nose handle, black front frame and silver front plate					
L3-L1, L2-L3, L1-L2, 0, L1-N, L2-N, L3-N	6	10	OC10G06PNBN00NV30	1SCA126658R1001	0.055
L3-L1, L2-L3, L1-L2, 0, L1-N, L2-N, L3-N	6	25	OC25G06PNBN00NV30	1SCA126660R1001	0.132
Door mounted, screw mounted black nose handle, black front frame and silver front plate					
L3-L1, L2-L3, L1-L2, 0, L1-N, L2-N, L3-N	6	25	OC25G06RNB00NV30	1SCA126662R1001	0.204
Door mounted, snap-on mounted black nose handle with round black front ring, no engraving					
L3-L1, L2-L3, L1-L2, 0, L1-N, L2-N, L3-N	6	25	OC25G06PXB00NV30	1SCA126661R1001	0.126
Modular DIN-rail base mounted, grey handle					
L3-L1, L2-L3, L1-L2, 0, L1-N, L2-N, L3-N	6	25	OC25G06MNGN00NV30	1SCA126659R1001	0.115
7 Positions, 3 phase to phase voltages for 2 circuits, with 0 position, step angle 45°					
Door mounted, snap-on mounted black nose handle, black front frame and silver front plate					
L3-L1, L2-L3, L1-L2, 0, L1-L2, L2-L3, L3-L1	8	10	OC10G08PNBN00NV32	1SCA126663R1001	0.066
L3-L1, L2-L3, L1-L2, 0, L1-L2, L2-L3, L3-L1	8	25	OC25G08PNBN00NV32	1SCA126664R1001	0.157

For more options of standard cam switches, see Order code configuration, pages 40...56.

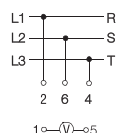

OC_VN3

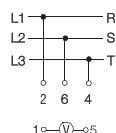

OC_V3

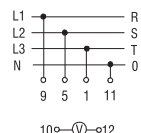

OC_VN30

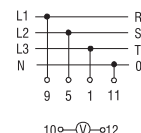

OC_V30

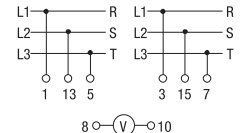

OC_V32

Ordering information

Accessories – Snap-on mounted handles



OC10GPNB*



OC10GPNG*

Snap on mounted nose handle without front plate

Handle delivery includes frame for front plate. The colour of the frame is same as the handle. The front plate has to be ordered separately. Front plates are available specially engraved via CamWeb2 or without engraving, see Accessories – Plates.



OC25GPNB*



OC25GPNG*



OC25GPMB*



OC25GPMG*



OC25GPB*



OC25GPE*



OC25GPFB*



OC25GPF*

Colour	For cam switches	Type	Order number	Weight/unit [kg]
Front frame size 32x32 mm				
Black	OC10_	OC10GPNB	1SCA126687R1001	0.05
Grey	OC10_	OC10GPNG	1SCA126684R1001	0.05
Front frame size 51x51 mm				
Black	OC25_	OC25GPNB	1SCA126690R1001	0.08
Grey	OC25_	OC25GPNG	1SCA126691R1001	0.08
Front frame size 66x66 mm				
Black	OC25_	OC25GPMB	1SCA126692R1001	0.10
Grey	OC25_	OC25GPMG	1SCA126693R1001	0.10

Snap on mounted extended handle without front plate

Handle delivery includes frame for front plate. The colour of the frame is same as the handle. The front plate has to be ordered separately. Front plates are available specially engraved via CamWeb2 or without engraving, see Accessories – Plates.

Colour	For cam switches	Type	Order number	Weight/unit [kg]
Front frame size 51x51 mm				
Black	OC25_	OC25GPB	1SCA126694R1001	0.08
Grey	OC25_	OC25GPE	1SCA126695R1001	0.08
Front frame size 66x66 mm				
Black	OC25_	OC25GPFB	1SCA126696R1001	0.10
Grey	OC25_	OC25GPF	1SCA126697R1001	0.10

* Front plate shown in the photograph has to be ordered separately.

Ordering information

Accessories – Snap-on mounted handles



OC10GPXB



OC10GPXG



OC25GPXB



OC25GPXG



OC25GMNG



OC25GP1B*



OC25GP1G*



OC25GP1Y*



OC25GP2B*



OC25GP2G*



OC25GP2Y*



OC25GP3B



OC25GP3G



OC25GP3R



OC25GP3Y

Snap on mounted nose handle with round front ring

The round front ring is the same colour as the handle.

Colour	For cam switches	Type	Order number	Weight/unit [kg]
Front ring size Ø 30 mm				
Black	OC10_	OC10GPXB	1SCA126685R1001	0.02
Grey	OC10_	OC10GPXG	1SCA126686R1001	0.02
Front ring size Ø 39 mm				
Black	OC25_	OC25GPXB	1SCA126698R1001	0.02
Grey	OC25_	OC25GPXG	1SCA126699R1001	0.02

Modular switch handle with front cover, without printing

Front plate is available specially printed via CamWeb2 or without engraving.

Colour	For cam switches	Type	Order number	Weight/unit [kg]
Front cover size 45x53 mm				
Grey	OC25_M_	OC25GMNG	1SCA126708R1001	0.05

Snap-on mounted handles - Padlockable

Handle delivery includes frame for front plate. The padlockable handles can be configured for locking positions every 45° beginning with 0°, by removing a precut in the locking ring. Cam switches with padlockable handles can be configured with the CamWeb2 configuration tool. The front plate has to be ordered separately. Front plates are available specially engraved via CamWeb2 or without engraving, see Accessories – Plates.

Colour	For cam switches	Type	Order number	Weight/unit [kg]
Front frame size 51x51 mm				
Black	OC25_	OC25GP1B	1SCA126738R1001	0.06
Grey	OC25_	OC25GP1G	1SCA126739R1001	0.06
Red-Yellow	OC25_	OC25GP1Y	1SCA126740R1001	0.06
Front frame size 66x66 mm				
Black	OC25_	OC25GP2B	1SCA126741R1001	0.06
Grey	OC25_	OC25GP2G	1SCA126742R1001	0.06
Red-Yellow	OC25_	OC25GP2Y	1SCA126743R1001	0.06

Snap-on mounted handles - Round padlockable

Only with OFF-ON text. Padlockable only in the OFF position (270°).

Colour	For cam switches	Type	Order number	Weight/unit [kg]
Front frame size 66x66 mm				
Black	OC25_	OC25GP3B	1SCA126744R1001	0.06
Grey	OC25_	OC25GP3G	1SCA126745R1001	0.06
Red	OC25_	OC25GP3R	1SCA126746R1001	0.06
Red-Yellow	OC25_	OC25GP3Y	1SCA126747R1001	0.06

* Front plate shown in the photograph has to be ordered separately.

Ordering information

Accessories – Screw mounted handles



OC10GRNB*



OC10GRNG*



OC25GRNB*



OC25GRNG*



OC25GRMB*



OC25GRMG*



OC25GREB*



OC25GREG*



OC25GRFB*



OC25GRFG*

Screw mounted nose handle without front plate

Handle delivery includes the frame for front plate. The colour of the frame is same as the handle. The front plate has to be ordered separately. Front plates are available specially engraved via CamWeb2 or without engraving, see Accessories – Plates.

Colour	For cam switches	Type	Order number	Weight/unit [kg]
Front frame size 32x32 mm				
Black	OC10_	OC10GRNB	1SCA126688R1001	0.05
Grey	OC10_	OC10GRNG	1SCA126689R1001	0.05
Front frame size 51x51 mm				
Black	OC25_	OC25GRNB	1SCA126700R1001	0.10
Grey	OC25_	OC25GRNG	1SCA126701R1001	0.10
Front frame size 66x66 mm				
Black	OC25_	OC25GRMB	1SCA126702R1001	0.10
Grey	OC25_	OC25GRMG	1SCA126703R1001	0.10

Screw mounted extended handle

Handle delivery includes the frame for front plate. The colour of the frame is same as the handle. The front plate has to be ordered separately. Front plates are available specially engraved via CamWeb2 or without engraving, see Accessories – Plates.

Colour	For cam switches	Type	Order number	Weight/unit [kg]
Front frame size 51x51 mm				
Black	OC25_	OC25GREB	1SCA126704R1001	0.10
Grey	OC25_	OC25GREG	1SCA126705R1001	0.10
Front frame size 66x66 mm				
Black	OC25_	OC25GRFB	1SCA126706R1001	0.10
Grey	OC25_	OC25GRFG	1SCA126707R1001	0.10

* Front plate shown in the photograph has to be ordered separately.

Ordering information

Accessories – Screw mounted handles



OC25GR1B*



OC25GR1G*



OC25GR1Y*



OC25GR2B*



OC25GR2G*



OC25GR2Y*



OC25GR3B



OC25GR3G



OC25GR3R



OC25GR3Y

Screw mounted handles - Padlockable

Handle delivery includes frame for front plate. The padlockable handles can be configured for locking positions every 45° beginning with 0°, by removing a precut in the locking ring. Cam switches with padlockable handles can be configured with the CamWeb2 configuration tool. The front plate has to be ordered separately. Front plates are available specially engraved via CamWeb2 or without engraving, see Accessories – Plates.

Colour	For cam switches	Type	Order number	Weight/unit [kg]
Front frame size 51x51 mm				
Black	OC25_	OC25GR1B	1SCA126748R1001	0.05
Grey	OC25_	OC25GR1G	1SCA126749R1001	0.05
Red-Yellow	OC25_	OC25GR1Y	1SCA126750R1001	0.05
Front frame size 66x66 mm				
Black	OC25_	OC25GR2B	1SCA126751R1001	0.05
Grey	OC25_	OC25GR2G	1SCA126752R1001	0.05
Red-Yellow	OC25_	OC25GR2Y	1SCA126753R1001	0.05

Screw mounted handles - Round padlockable

Only with OFF-ON text. Padlockable only in the OFF position (270°).

Colour	For cam switches	Type	Order number	Weight/unit [kg]
Front frame size 66x66 mm				
Black	OC25_	OC25GR3B	1SCA126754R1001	0.05
Grey	OC25_	OC25GR3G	1SCA126755R1001	0.05
Red	OC25_	OC25GR3R	1SCA126756R1001	0.05
Red-Yellow	OC25_	OC25GR3Y	1SCA126757R1001	0.05

* Front plate shown in the photograph has to be ordered separately.

Ordering information

Accessories – Plates



OC10GFP32S



OC25GFP51S



OC25GFP51Y



OC25GFP66S



OC25GFP66Y



OC10GLP32B



OC10GLP32G



OC25GLP51B



OC25GLP51G



OC25GLP66B



OC25GLP66G



OC25GLPRPB



OC25GLPRPG

Front plates without frame, without engraving

Colour	For cam switches	Type	Order number	Weight/unit [kg]
Front frame size 32x32 mm				
Silver	OC10_	OC10GFP32S	1SCA126709R1001	0.003
Front frame size 51x51 mm				
Silver	OC25_	OC25GFP51S	1SCA126710R1001	0.003
Yellow	OC25_	OC25GFP51Y	1SCA126711R1001	0.003
Front frame size 66x66 mm				
Silver	OC25_	OC25GFP66S	1SCA126712R1001	0.003
Yellow	OC25_	OC25GFP66Y	1SCA126713R1001	0.003

Additional lettering plates with frame, without engraving

Colour	For cam switches	Type	Order number	Weight/unit [kg]
Suitable for handles with 32x32 mm front frame				
Black frame	OC10_	OC10GLP32B	1SCA126714R1001	0.01
Grey frame	OC10_	OC10GLP32G	1SCA126715R1001	0.01
Suitable for handles with 51x51 mm front frame				
Black frame	OC25_	OC25GLP51B	1SCA126716R1001	0.01
Grey frame	OC25_	OC25GLP51G	1SCA126717R1001	0.01
Suitable for handles with 66x66 mm front frame				
Black frame	OC25_	OC25GLP66B	1SCA126718R1001	0.01
Grey frame	OC25_	OC25GLP66G	1SCA126719R1001	0.01
Suitable for round padlockable type handle size 66x66 mm				
Black frame	OC25_	OC25GLPRPB	1SCA126787R1001	0.01
Grey frame	OC25_	OC25GLPRPG	1SCA126721R1001	0.01

Ordering information

Accessories – Other



ONZ10L_

Protective rear cover

Transparent, IP42 protection.



OMNX80

Number of chambers	Number of contacts	For cam switches	Type	Order number	Weight/unit [kg]
Screw-Mounted					
1	1-2	OC25G_	ONZ10L2	1SCA022621R1570	
2-3	3-6	OC25G_	ONZ10L4	1SCA022621R1650	
4-5	7-10	OC25G_	ONZ10L6	1SCA022621R1730	
Snap-On Mounted					
1-2	1-4	OC25G_	ONZ10L4	1SCA022621R1650	
3-4	5-8	OC25G_	ONZ10L6	1SCA022621R1730	



ONX30

Nut spanner tool

For proper tightening the nut of snap-on mounted handle.



OC_R455

Colour	For cam switches	Type	Order number	Weight/unit [kg]
-	OC10_, OC25_	OMNX80	1SCA022553R8440	0.02

Adaptor ring for snap-on handles

For fixing the standard OC25 snap-on handles with 22.3 mm door drilling to 30 mm door drilling.

Black	OC25_	ONX30	1SCA022643R8510	0.01
-------	-------	-------	-----------------	------

Spare key

For key-operated cam switches.

Number of keys	For cam switches	Type	Order number	Weight/unit [kg]
2 pcs	OC10_K_ / R455	OC10GR455	1SCA126722R1001	0.01
2 pcs	OC25_K_ / R455	OC25GR455	1SCA126723R1001	0.01

Spare Snap-on mounting nut

	For cam switches	Type	Order number	Weight/unit [kg]
-	OC10_	OC10GNUT	1SCA137931R1001	
-	OC25_	OC25GNUT	1SCA137932R1001	

Spare IP protection sheet for screw mounted handles

Description	For cam switches	Type	Order number	Weight/unit [kg]
Front frame size 32x32 mm	OC10_	OC10GRIP32	1SCA137944R1001	
Front frame size 51x51 mm	OC25_	OC25GRIP51	1SCA137948R1001	
Front frame size 66x66 mm	OC25_	OC25GRIP66	1SCA138027R1001	

Order code configuration

Standard cam switches

Number of poles	Position 2	Front plate engravings	Position 7	Position 9	Connecting diagram
	Number of contacts		Legend plate	Function code for standard cam switch	
ON-OFF switches					
1	01		0	A1	
2	02			A2	
3	03			A3	
4	04			A4	
5	05			A5	
6	06			A6	
7	07			A7	
8	08			A8	
1	01		0	B1	
2	02			B2	
3	03			B3	
4	04			B4	
5	05			B5	
6	06			B6	
7	07			B7	
8	08			B8	
1	01		0	A01	
2	02			A02	
3	03			A03	
4	04			A04	
5	05			A05	
6	06			A06	
7	07			A07	
8	08			A08	
1	01		0	B01	
2	02			B02	
3	03			B03	
4	04			B04	
5	05			B05	
6	06			B06	
7	07			B07	
8	08			B08	
1	01		0	R01	
2	02			R02	
3	03			R03	
4	04			R04	
5	05			R05	
6	06			R06	
7	07			R07	
8	08			R08	

Order code configuration

Standard cam switches

	Position 2		Position 7	Position 9	
Number of poles	Number of contacts	Front plate engravings	Legend plate	Function code for standard cam switch	Connecting diagram
3	03		0	BB3	
4	04		0	AC4	
8	08		0	AC8	

Change over switches

1	02		0	WS1	
2	04		WS2		
3	06		WS3		
4	08		WS4		
5	10		WS5		
6	12		WS6		
7	14		WS7		
8	16		WS8		
9	18 (OC25 only)		WS9		
10	20 (OC25 only)		WS10		
1	02		0	WR1	
2	04		WR2		
3	06		WR3		
4	08		WR4		
5	10		WR5		
6	12		WR6		
7	14		WR7		
8	16		WR8		
1	02		0	WN1	
2	04		WN2		
3	06		WN3		
4	08		WN4		
5	10		WN5		
6	12		WN6		
7	14		WN7		
8	16		WN8		
1	02		0	WA1	
2	04		WA2		
3	06		WA3		
4	08		WA4		
5	10		WA5		
6	12		WA6		
7	14		WA7		
8	16		WA8		

Order code configuration

Standard cam switches

Number of poles	Position 2		Position 7	Position 9	Function code for standard cam switch	Connecting diagram
	Number of contacts	Front plate engravings				
1	02		0		WZ1	
2	04					
3	06					
4	08					
5	10					
6	12					
1	02		0		U1	
2	04					
3	06					
4	08					
5	10					
6	12					
7	14					
8	16					
9	18 (OC25 only)					
10	20 (OC25 only)					
1	02		0		UB1	
2	04					
3	06					
4	08					
5	10					
6	12					
7	14					
8	16					
1	02		0		UA1	
2	04					
3	06					
4	08					
5	10					
6	12					
7	14					
8	16					
1	02		0		UM1	
2	04					
3	06					
4	08					
5	10					
6	12					
7	14					
8	16					
1	02		0		UH1	
2	04					
3	06					
4	08					
5	10					
6	12					
7	14					
8	16					

Order code configuration

Standard cam switches

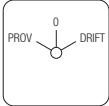
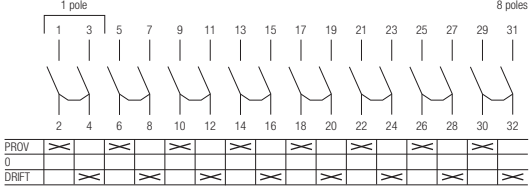
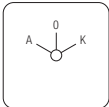
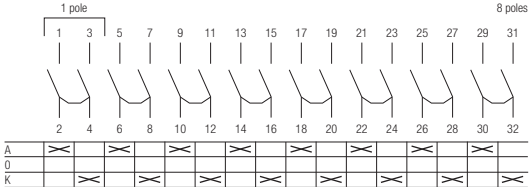
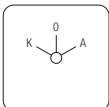
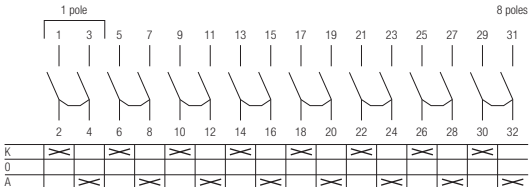
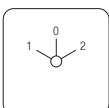
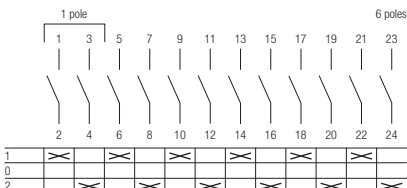
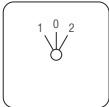
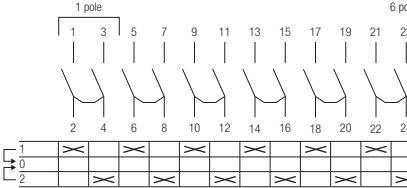
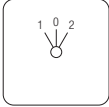
Number of poles	Position 2		Position 7	Position 9	Connecting diagram
	Number of contacts	Front plate engravings			
1	02		0	US1	
2	04			US2	
3	06			US3	
4	08			US4	
5	10			US5	
6	12			US6	
7	14			US7	
8	16			US8	
1	02		0	UK1	
2	04			UK2	
3	06			UK3	
4	08			UK4	
5	10			UK5	
6	12			UK6	
7	14			UK7	
8	16			UK8	
1	02		0	UP1	
2	04			UP2	
3	06			UP3	
4	08			UP4	
5	10			UP5	
6	12			UP6	
7	14			UP7	
8	16			UP8	
1	02		0	UZ1	
2	04			UZ2	
3	06			UZ3	
4	08			UZ4	
5	10			UZ5	
6	12			UZ6	
1	02		0	URR1	
2	04			URR2	
3	06			URR3	
4	08			URR4	
5	10			URR5	
6	12			URR6	
1	02		0	URZ1	
2	04			URZ2	
3	06			URZ3	
4	08			URZ4	
5	10			URZ5	
6	12			URZ6	

Order code configuration

Standard cam switches

Number of poles	Position 2	Front plate engravings	Position 7	Position 9	Connecting diagram
	Number of contacts		Legend plate	Function code for standard cam switch	
1	02		0	WC1	
2	04			WC2	
3	06			WC3	
4	08			WC4	
3	06		0	UC3	
4	08			UC4	

Bypass switches

With 0-position, step angle 60°, without overlapping, 3 and 4- pole network

Number of poles	Number of contacts	Front plate engravings	Legend plate	Function code	Connecting diagram
4	12	WS48			

Without 0-position, step angle 60°, with overlapping, 3 and 4- pole network

Number of poles	Number of contacts	Front plate engravings	Legend plate	Function code	Connecting diagram
4	12	PW48			

Multistep switches

With 0-position

Number of poles	Number of contacts	Front plate engravings	Legend plate	Function code	Connecting diagram
2	04	SO22			
3	06	SO23			
4	08	SO24			
1	03		0	SO31	
2	06			SO32	
3	09			SO33	
4	12			SO34	

Order code configuration

Standard cam switches

	Position 2		Position 7	Position 9	
Number of poles	Number of contacts	Front plate engravings	Legend plate	Function code for standard cam switch	Connecting diagram
1 2 3	04 08 12		0	SO41 SO42 SO43	
1 2	05 10		0	SO51 SO52	
1 2 3	06 12 18 (OC25 only)		0	SO61 SO62 SO63	
1	07		0	SO71	
1	08		0	SO81	

Order code configuration

Standard cam switches

	Position 2		Position 7	Position 9	
Number of poles	Number of contacts	Front plate engravings	Legend plate	Function code for standard cam switch	Connecting diagram
1	09		0	SO91	
1	10		0	SO10	
1	11		0	SO11	
Without 0-position					
1	03		0	ST31	
2	06		ST32		
3	09		ST33		
4	12		ST34		
1	04		0	ST41	
2	08		ST42		
3	12		ST43		

Order code configuration

Standard cam switches

	Position 2		Position 7	Position 9	
Number of poles	Number of contacts	Front plate engravings	Legend plate	Function code for standard cam switch	Connecting diagram
1 2	05 10		0	ST51 ST52	
1 2 3	06 12 18		0	ST61 ST62 ST63	
1	07		0	ST71	
1	08		0	ST81	
1	09		0	ST91	

Order code configuration

Standard cam switches

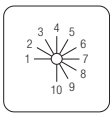
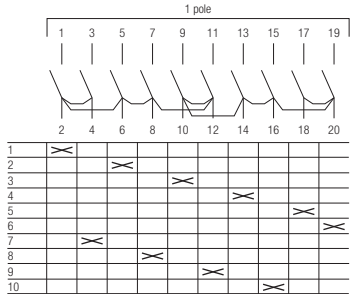
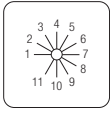
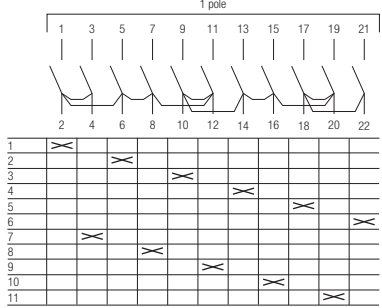
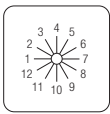
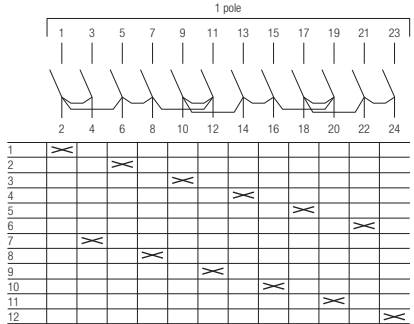
	Position 2		Position 7	Position 9	
Number of poles	Number of contacts	Front plate engravings	Legend plate	Function code for standard cam switch	Connecting diagram
1	10		0	ST10	
1	11		0	ST11	
1	12		0	ST12	

Motor control switches

Ventilation switches

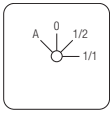
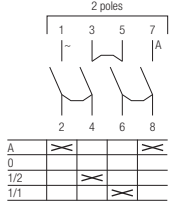
2	04		0	ST30	
---	----	---	---	------	--

Reversing switches

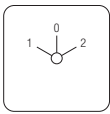
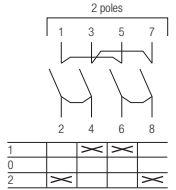
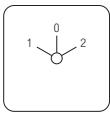
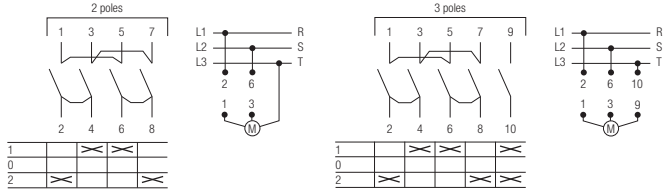
2	04		0	W2	
3	05		0	W3	

Order code configuration

Standard cam switches

	Position 2		Position 7	Position 9	
Number of poles	Number of contacts	Front plate engravings	Legend plate	Function code for standard cam switch	Connecting diagram
Star-delta switches					
3	08		0	SD	
Pole-change switches (Dahlander), winding for 2 speeds, one direction					
3	08		0	P12	
Pumpstart switches					
1	02		0	SE15	
Stop switches, with spring return, contacts N.C.					
2	2		0	SA2	
Start switches, with spring return					
1	02		0	SEA1	
1	02		0	SE2	
1	02		0	SEA0	

Order code configuration

Standard cam switches

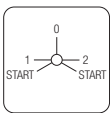
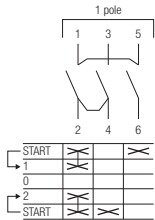
	Position 2		Position 7	Position 9	
Number of poles	Number of contacts	Front plate engravings	Legend plate	Function code for standard cam switch	Connecting diagram
1	03		0	UR13	

Voltmeter switches

3 Positions, 3 phase -3 wire, without 0-position, step angle 45°

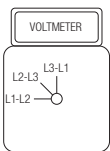
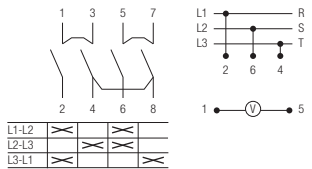
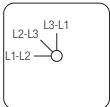
04		P	VN3	
		0		

4 Positions, 3 phase -3 wire, with 0-position, step angle 45°

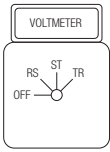
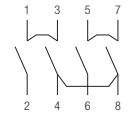
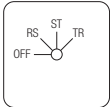
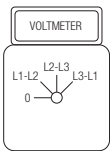
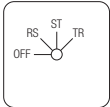
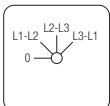
04		P	VT3	
		0		
04		P	V3	
		0		

Order code configuration

Standard cam switches

Number of poles	Position 2	Front plate engravings	Position 7	Position 9	Function code for standard cam switch	Connecting diagram
04	04		P	VGR3		
			0			
04	04		P	VGL3		
			0			
6 Positions, 3 phase to phase, 3 phase to neutral, without 0-position, step angle 30°						
06	06		P	VN30		
			0			
7 Positions, 3 phase to phase 3 phase to neutral, with 0-position, step angle 45°						
06	06		P	V30		
			0			

Order code configuration

Standard cam switches

Number of poles	Position 2	Front plate engravings	Position 7	Position 9	Function code for standard cam switch	Connecting diagram																																																																								
06	06		P	VT30																																																																										
			0			<table border="1"> <tr><td>TR</td><td></td><td></td><td></td><td></td><td></td><td></td><td></td><td></td><td></td><td></td><td></td></tr> <tr><td>ST</td><td></td><td></td><td></td><td></td><td></td><td></td><td></td><td></td><td></td><td></td><td></td></tr> <tr><td>RS</td><td></td><td></td><td></td><td></td><td></td><td></td><td></td><td></td><td></td><td></td><td></td></tr> <tr><td>RO</td><td></td><td></td><td></td><td></td><td></td><td></td><td></td><td></td><td></td><td></td><td></td></tr> <tr><td>SO</td><td></td><td></td><td></td><td></td><td></td><td></td><td></td><td></td><td></td><td></td><td></td></tr> <tr><td>TO</td><td></td><td></td><td></td><td></td><td></td><td></td><td></td><td></td><td></td><td></td><td></td></tr> </table>	TR												ST												RS												RO												SO												TO											
TR																																																																														
ST																																																																														
RS																																																																														
RO																																																																														
SO																																																																														
TO																																																																														
06	06		P	VR30																																																																										
			0			<table border="1"> <tr><td>BR</td><td></td><td></td><td></td><td></td><td></td><td></td><td></td><td></td><td></td><td></td><td></td></tr> <tr><td>YB</td><td></td><td></td><td></td><td></td><td></td><td></td><td></td><td></td><td></td><td></td><td></td></tr> <tr><td>RY</td><td></td><td></td><td></td><td></td><td></td><td></td><td></td><td></td><td></td><td></td><td></td></tr> <tr><td>OFF</td><td></td><td></td><td></td><td></td><td></td><td></td><td></td><td></td><td></td><td></td><td></td></tr> <tr><td>RN</td><td></td><td></td><td></td><td></td><td></td><td></td><td></td><td></td><td></td><td></td><td></td></tr> <tr><td>BN</td><td></td><td></td><td></td><td></td><td></td><td></td><td></td><td></td><td></td><td></td><td></td></tr> </table>	BR												YB												RY												OFF												RN												BN											
BR																																																																														
YB																																																																														
RY																																																																														
OFF																																																																														
RN																																																																														
BN																																																																														

7 Positions, 3 phase to phase voltages for 2 circuits, with 0 position, step angle 45°

06	06		P	V32																																																																																																																		
			0			<table border="1"> <tr><td>L3-L1</td><td></td><td></td><td></td><td></td><td></td><td></td><td></td><td></td><td></td><td></td><td></td><td></td><td></td><td></td><td></td></tr> <tr><td>L2-L3</td><td></td><td></td><td></td><td></td><td></td><td></td><td></td><td></td><td></td><td></td><td></td><td></td><td></td><td></td><td></td></tr> <tr><td>L1-L2</td><td></td><td></td><td></td><td></td><td></td><td></td><td></td><td></td><td></td><td></td><td></td><td></td><td></td><td></td><td></td></tr> <tr><td>0</td><td></td><td></td><td></td><td></td><td></td><td></td><td></td><td></td><td></td><td></td><td></td><td></td><td></td><td></td><td></td></tr> <tr><td>L1-L2</td><td></td><td></td><td></td><td></td><td></td><td></td><td></td><td></td><td></td><td></td><td></td><td></td><td></td><td></td><td></td></tr> <tr><td>L2-L3</td><td></td><td></td><td></td><td></td><td></td><td></td><td></td><td></td><td></td><td></td><td></td><td></td><td></td><td></td><td></td></tr> <tr><td>L3-L1</td><td></td><td></td><td></td><td></td><td></td><td></td><td></td><td></td><td></td><td></td><td></td><td></td><td></td><td></td><td></td></tr> </table>	L3-L1																L2-L3																L1-L2																0																L1-L2																L2-L3																L3-L1															
L3-L1																																																																																																																						
L2-L3																																																																																																																						
L1-L2																																																																																																																						
0																																																																																																																						
L1-L2																																																																																																																						
L2-L3																																																																																																																						
L3-L1																																																																																																																						

Ammeter switches

For 3 current transformer circuits, with 0-position, step angle 90°, in 2 pole switch: 2 pole or direct measurement in 3 phases

1	06		P	AU31																																																		
			0			<table border="1"> <tr><td>0</td><td></td><td></td><td></td><td></td><td></td><td></td><td></td><td></td><td></td><td></td><td></td></tr> <tr><td>1</td><td></td><td></td><td></td><td></td><td></td><td></td><td></td><td></td><td></td><td></td><td></td></tr> <tr><td>2</td><td></td><td></td><td></td><td></td><td></td><td></td><td></td><td></td><td></td><td></td><td></td></tr> <tr><td>0</td><td></td><td></td><td></td><td></td><td></td><td></td><td></td><td></td><td></td><td></td><td></td></tr> </table>	0												1												2												0											
0																																																						
1																																																						
2																																																						
0																																																						

Order code configuration

Standard cam switches

	Position 2		Position 7	Position 9																																																																																																					
Number of poles	Number of contacts	Front plate engravings	Legend plate	Function code for standard cam switch	Connecting diagram																																																																																																				
1	06		P	AR31	<table border="1"> <tr><td>OFF</td><td>X</td><td>X</td><td>X</td><td>X</td><td>X</td><td>X</td><td>X</td><td>X</td><td>X</td><td>X</td><td>X</td></tr> <tr><td>R</td><td>X</td><td>X</td><td>X</td><td>X</td><td>X</td><td>X</td><td>X</td><td>X</td><td>X</td><td>X</td><td>X</td></tr> <tr><td>Y</td><td>X</td><td>X</td><td>X</td><td>X</td><td>X</td><td>X</td><td>X</td><td>X</td><td>X</td><td>X</td><td>X</td></tr> <tr><td>B</td><td>X</td><td>X</td><td>X</td><td>X</td><td>X</td><td>X</td><td>X</td><td>X</td><td>X</td><td>X</td><td>X</td></tr> <tr><td>OFF</td><td>X</td><td>X</td><td>X</td><td>X</td><td>X</td><td>X</td><td>X</td><td>X</td><td>X</td><td>X</td><td>X</td></tr> </table>	OFF	X	X	X	X	X	X	X	X	X	X	X	R	X	X	X	X	X	X	X	X	X	X	X	Y	X	X	X	X	X	X	X	X	X	X	X	B	X	X	X	X	X	X	X	X	X	X	X	OFF	X	X	X	X	X	X	X	X	X	X	X																																								
		OFF	X	X		X	X	X	X	X	X	X	X	X																																																																																											
R	X	X	X	X	X	X	X	X	X	X	X																																																																																														
Y	X	X	X	X	X	X	X	X	X	X	X																																																																																														
B	X	X	X	X	X	X	X	X	X	X	X																																																																																														
OFF	X	X	X	X	X	X	X	X	X	X	X																																																																																														
			O																																																																																																						
1	06		P	AS31	<table border="1"> <tr><td>OFF</td><td>X</td><td>X</td><td>X</td><td>X</td><td>X</td><td>X</td><td>X</td><td>X</td><td>X</td><td>X</td><td>X</td></tr> <tr><td>R</td><td>X</td><td>X</td><td>X</td><td>X</td><td>X</td><td>X</td><td>X</td><td>X</td><td>X</td><td>X</td><td>X</td></tr> <tr><td>S</td><td>X</td><td>X</td><td>X</td><td>X</td><td>X</td><td>X</td><td>X</td><td>X</td><td>X</td><td>X</td><td>X</td></tr> <tr><td>T</td><td>X</td><td>X</td><td>X</td><td>X</td><td>X</td><td>X</td><td>X</td><td>X</td><td>X</td><td>X</td><td>X</td></tr> <tr><td>OFF</td><td>X</td><td>X</td><td>X</td><td>X</td><td>X</td><td>X</td><td>X</td><td>X</td><td>X</td><td>X</td><td>X</td></tr> </table>	OFF	X	X	X	X	X	X	X	X	X	X	X	R	X	X	X	X	X	X	X	X	X	X	X	S	X	X	X	X	X	X	X	X	X	X	X	T	X	X	X	X	X	X	X	X	X	X	X	OFF	X	X	X	X	X	X	X	X	X	X	X																																								
		OFF	X	X		X	X	X	X	X	X	X	X	X																																																																																											
R	X	X	X	X	X	X	X	X	X	X	X																																																																																														
S	X	X	X	X	X	X	X	X	X	X	X																																																																																														
T	X	X	X	X	X	X	X	X	X	X	X																																																																																														
OFF	X	X	X	X	X	X	X	X	X	X	X																																																																																														
			O																																																																																																						
2	10		P	AU32	<table border="1"> <tr><td>0</td><td>X</td><td>X</td><td>X</td><td>X</td><td>X</td><td>X</td><td>X</td><td>X</td><td>X</td><td>X</td><td>X</td><td>X</td><td>X</td><td>X</td><td>X</td><td>X</td><td>X</td><td>X</td><td>X</td></tr> <tr><td>1</td><td>X</td><td>X</td><td>X</td><td>X</td><td>X</td><td>X</td><td>X</td><td>X</td><td>X</td><td>X</td><td>X</td><td>X</td><td>X</td><td>X</td><td>X</td><td>X</td><td>X</td><td>X</td><td>X</td></tr> <tr><td>2</td><td>X</td><td>X</td><td>X</td><td>X</td><td>X</td><td>X</td><td>X</td><td>X</td><td>X</td><td>X</td><td>X</td><td>X</td><td>X</td><td>X</td><td>X</td><td>X</td><td>X</td><td>X</td><td>X</td></tr> <tr><td>3</td><td>X</td><td>X</td><td>X</td><td>X</td><td>X</td><td>X</td><td>X</td><td>X</td><td>X</td><td>X</td><td>X</td><td>X</td><td>X</td><td>X</td><td>X</td><td>X</td><td>X</td><td>X</td><td>X</td></tr> <tr><td>0</td><td>X</td><td>X</td><td>X</td><td>X</td><td>X</td><td>X</td><td>X</td><td>X</td><td>X</td><td>X</td><td>X</td><td>X</td><td>X</td><td>X</td><td>X</td><td>X</td><td>X</td><td>X</td><td>X</td></tr> </table>	0	X	X	X	X	X	X	X	X	X	X	X	X	X	X	X	X	X	X	X	1	X	X	X	X	X	X	X	X	X	X	X	X	X	X	X	X	X	X	X	2	X	X	X	X	X	X	X	X	X	X	X	X	X	X	X	X	X	X	X	3	X	X	X	X	X	X	X	X	X	X	X	X	X	X	X	X	X	X	X	0	X	X	X	X	X	X	X	X	X	X	X	X	X	X	X	X	X	X	X
		0	X	X		X	X	X	X	X	X	X	X	X	X	X	X	X	X	X	X	X																																																																																			
1	X	X	X	X	X	X	X	X	X	X	X	X	X	X	X	X	X	X	X																																																																																						
2	X	X	X	X	X	X	X	X	X	X	X	X	X	X	X	X	X	X	X																																																																																						
3	X	X	X	X	X	X	X	X	X	X	X	X	X	X	X	X	X	X	X																																																																																						
0	X	X	X	X	X	X	X	X	X	X	X	X	X	X	X	X	X	X	X																																																																																						
			O																																																																																																						
2	10		P	AR32	<table border="1"> <tr><td>OFF</td><td>X</td><td>X</td><td>X</td><td>X</td><td>X</td><td>X</td><td>X</td><td>X</td><td>X</td><td>X</td><td>X</td><td>X</td><td>X</td><td>X</td><td>X</td><td>X</td><td>X</td><td>X</td><td>X</td></tr> <tr><td>R</td><td>X</td><td>X</td><td>X</td><td>X</td><td>X</td><td>X</td><td>X</td><td>X</td><td>X</td><td>X</td><td>X</td><td>X</td><td>X</td><td>X</td><td>X</td><td>X</td><td>X</td><td>X</td><td>X</td></tr> <tr><td>Y</td><td>X</td><td>X</td><td>X</td><td>X</td><td>X</td><td>X</td><td>X</td><td>X</td><td>X</td><td>X</td><td>X</td><td>X</td><td>X</td><td>X</td><td>X</td><td>X</td><td>X</td><td>X</td><td>X</td></tr> <tr><td>B</td><td>X</td><td>X</td><td>X</td><td>X</td><td>X</td><td>X</td><td>X</td><td>X</td><td>X</td><td>X</td><td>X</td><td>X</td><td>X</td><td>X</td><td>X</td><td>X</td><td>X</td><td>X</td><td>X</td></tr> <tr><td>OFF</td><td>X</td><td>X</td><td>X</td><td>X</td><td>X</td><td>X</td><td>X</td><td>X</td><td>X</td><td>X</td><td>X</td><td>X</td><td>X</td><td>X</td><td>X</td><td>X</td><td>X</td><td>X</td><td>X</td></tr> </table>	OFF	X	X	X	X	X	X	X	X	X	X	X	X	X	X	X	X	X	X	X	R	X	X	X	X	X	X	X	X	X	X	X	X	X	X	X	X	X	X	X	Y	X	X	X	X	X	X	X	X	X	X	X	X	X	X	X	X	X	X	X	B	X	X	X	X	X	X	X	X	X	X	X	X	X	X	X	X	X	X	X	OFF	X	X	X	X	X	X	X	X	X	X	X	X	X	X	X	X	X	X	X
		OFF	X	X		X	X	X	X	X	X	X	X	X	X	X	X	X	X	X	X	X																																																																																			
R	X	X	X	X	X	X	X	X	X	X	X	X	X	X	X	X	X	X	X																																																																																						
Y	X	X	X	X	X	X	X	X	X	X	X	X	X	X	X	X	X	X	X																																																																																						
B	X	X	X	X	X	X	X	X	X	X	X	X	X	X	X	X	X	X	X																																																																																						
OFF	X	X	X	X	X	X	X	X	X	X	X	X	X	X	X	X	X	X	X																																																																																						
			O																																																																																																						
2	10		P	AS32	<table border="1"> <tr><td>OFF</td><td>X</td><td>X</td><td>X</td><td>X</td><td>X</td><td>X</td><td>X</td><td>X</td><td>X</td><td>X</td><td>X</td><td>X</td><td>X</td><td>X</td><td>X</td><td>X</td><td>X</td><td>X</td><td>X</td></tr> <tr><td>R</td><td>X</td><td>X</td><td>X</td><td>X</td><td>X</td><td>X</td><td>X</td><td>X</td><td>X</td><td>X</td><td>X</td><td>X</td><td>X</td><td>X</td><td>X</td><td>X</td><td>X</td><td>X</td><td>X</td></tr> <tr><td>S</td><td>X</td><td>X</td><td>X</td><td>X</td><td>X</td><td>X</td><td>X</td><td>X</td><td>X</td><td>X</td><td>X</td><td>X</td><td>X</td><td>X</td><td>X</td><td>X</td><td>X</td><td>X</td><td>X</td></tr> <tr><td>T</td><td>X</td><td>X</td><td>X</td><td>X</td><td>X</td><td>X</td><td>X</td><td>X</td><td>X</td><td>X</td><td>X</td><td>X</td><td>X</td><td>X</td><td>X</td><td>X</td><td>X</td><td>X</td><td>X</td></tr> <tr><td>OFF</td><td>X</td><td>X</td><td>X</td><td>X</td><td>X</td><td>X</td><td>X</td><td>X</td><td>X</td><td>X</td><td>X</td><td>X</td><td>X</td><td>X</td><td>X</td><td>X</td><td>X</td><td>X</td><td>X</td></tr> </table>	OFF	X	X	X	X	X	X	X	X	X	X	X	X	X	X	X	X	X	X	X	R	X	X	X	X	X	X	X	X	X	X	X	X	X	X	X	X	X	X	X	S	X	X	X	X	X	X	X	X	X	X	X	X	X	X	X	X	X	X	X	T	X	X	X	X	X	X	X	X	X	X	X	X	X	X	X	X	X	X	X	OFF	X	X	X	X	X	X	X	X	X	X	X	X	X	X	X	X	X	X	X
		OFF	X	X		X	X	X	X	X	X	X	X	X	X	X	X	X	X	X	X	X																																																																																			
R	X	X	X	X	X	X	X	X	X	X	X	X	X	X	X	X	X	X	X																																																																																						
S	X	X	X	X	X	X	X	X	X	X	X	X	X	X	X	X	X	X	X																																																																																						
T	X	X	X	X	X	X	X	X	X	X	X	X	X	X	X	X	X	X	X																																																																																						
OFF	X	X	X	X	X	X	X	X	X	X	X	X	X	X	X	X	X	X	X																																																																																						
			O																																																																																																						

Order code configuration

Standard cam switches

	Position 2		Position 7	Position 9	
Number of poles	Number of contacts	Front plate engravings	Legend plate	Function code for standard cam switch	Connecting diagram

Volt-ammeter switches

Measuring between phases and 3 current transformers with common pole, step angle 90°

10		0	VA21		
10		0	AV12		

Binarycode switches

With 0-position, step angle 30° / 45°

03		0	B070	
03		0	B071	
06		0	B072	

Order code configuration

Standard cam switches

	Position 2		Position 7	Position 9																																																																																																																									
Number of poles	Number of contacts	Front plate engravings	Legend plate	Function code for standard cam switch	Connecting diagram																																																																																																																								
	04		0	B090	<table border="1"> <tr><td>0</td><td></td><td></td><td></td><td></td></tr> <tr><td>1</td><td></td><td></td><td></td><td></td></tr> <tr><td>2</td><td>X</td><td></td><td></td><td></td></tr> <tr><td>3</td><td>X</td><td>X</td><td></td><td></td></tr> <tr><td>4</td><td></td><td></td><td>X</td><td></td></tr> <tr><td>5</td><td>X</td><td></td><td></td><td></td></tr> <tr><td>6</td><td>X</td><td>X</td><td></td><td></td></tr> <tr><td>7</td><td>X</td><td>X</td><td>X</td><td></td></tr> <tr><td>8</td><td></td><td></td><td></td><td>X</td></tr> <tr><td>9</td><td>X</td><td></td><td></td><td>X</td></tr> </table>	0					1					2	X				3	X	X			4			X		5	X				6	X	X			7	X	X	X		8				X	9	X			X																																																																						
0																																																																																																																													
1																																																																																																																													
2	X																																																																																																																												
3	X	X																																																																																																																											
4			X																																																																																																																										
5	X																																																																																																																												
6	X	X																																																																																																																											
7	X	X	X																																																																																																																										
8				X																																																																																																																									
9	X			X																																																																																																																									
	04		0	B091	<table border="1"> <tr><td>0</td><td></td><td>X</td><td>X</td><td>X</td><td>X</td></tr> <tr><td>1</td><td></td><td></td><td></td><td></td><td></td></tr> <tr><td>2</td><td>X</td><td></td><td></td><td></td><td></td></tr> <tr><td>3</td><td>X</td><td>X</td><td></td><td>X</td><td></td></tr> <tr><td>4</td><td></td><td></td><td>X</td><td></td><td></td></tr> <tr><td>5</td><td>X</td><td></td><td></td><td></td><td></td></tr> <tr><td>6</td><td>X</td><td>X</td><td></td><td></td><td></td></tr> <tr><td>7</td><td>X</td><td>X</td><td>X</td><td></td><td></td></tr> <tr><td>8</td><td>X</td><td>X</td><td>X</td><td>X</td><td></td></tr> <tr><td>9</td><td></td><td></td><td></td><td></td><td>X</td></tr> </table>	0		X	X	X	X	1						2	X					3	X	X		X		4			X			5	X					6	X	X				7	X	X	X			8	X	X	X	X		9					X																																																												
0		X	X	X	X																																																																																																																								
1																																																																																																																													
2	X																																																																																																																												
3	X	X		X																																																																																																																									
4			X																																																																																																																										
5	X																																																																																																																												
6	X	X																																																																																																																											
7	X	X	X																																																																																																																										
8	X	X	X	X																																																																																																																									
9					X																																																																																																																								
	08		0	B092	<table border="1"> <tr><td>0</td><td></td><td></td><td></td><td></td><td></td><td>X</td><td>X</td><td>X</td><td>X</td></tr> <tr><td>1</td><td></td><td></td><td></td><td></td><td></td><td></td><td></td><td></td><td></td></tr> <tr><td>2</td><td>X</td><td></td><td></td><td></td><td></td><td>X</td><td>X</td><td>X</td><td>X</td></tr> <tr><td>3</td><td>X</td><td>X</td><td></td><td></td><td></td><td></td><td></td><td></td><td></td></tr> <tr><td>4</td><td></td><td></td><td>X</td><td></td><td></td><td>X</td><td>X</td><td>X</td><td></td></tr> <tr><td>5</td><td>X</td><td></td><td></td><td></td><td></td><td>X</td><td>X</td><td>X</td><td></td></tr> <tr><td>6</td><td>X</td><td>X</td><td></td><td></td><td></td><td></td><td></td><td></td><td></td></tr> <tr><td>7</td><td>X</td><td>X</td><td>X</td><td></td><td></td><td>X</td><td>X</td><td>X</td><td></td></tr> <tr><td>8</td><td>X</td><td>X</td><td>X</td><td>X</td><td></td><td>X</td><td>X</td><td>X</td><td>X</td></tr> <tr><td>9</td><td></td><td></td><td></td><td></td><td>X</td><td>X</td><td>X</td><td>X</td><td></td></tr> <tr><td>10</td><td>X</td><td></td><td></td><td></td><td></td><td></td><td></td><td></td><td>X</td></tr> <tr><td>11</td><td>X</td><td>X</td><td></td><td></td><td></td><td>X</td><td>X</td><td>X</td><td></td></tr> </table>	0						X	X	X	X	1										2	X					X	X	X	X	3	X	X								4			X			X	X	X		5	X					X	X	X		6	X	X								7	X	X	X			X	X	X		8	X	X	X	X		X	X	X	X	9					X	X	X	X		10	X								X	11	X	X				X	X	X	
0						X	X	X	X																																																																																																																				
1																																																																																																																													
2	X					X	X	X	X																																																																																																																				
3	X	X																																																																																																																											
4			X			X	X	X																																																																																																																					
5	X					X	X	X																																																																																																																					
6	X	X																																																																																																																											
7	X	X	X			X	X	X																																																																																																																					
8	X	X	X	X		X	X	X	X																																																																																																																				
9					X	X	X	X																																																																																																																					
10	X								X																																																																																																																				
11	X	X				X	X	X																																																																																																																					
	04		0	B110	<table border="1"> <tr><td>0</td><td></td><td></td><td></td><td></td></tr> <tr><td>1</td><td></td><td></td><td></td><td></td></tr> <tr><td>2</td><td>X</td><td></td><td></td><td></td></tr> <tr><td>3</td><td>X</td><td>X</td><td></td><td></td></tr> <tr><td>4</td><td></td><td></td><td>X</td><td></td></tr> <tr><td>5</td><td>X</td><td></td><td></td><td></td></tr> <tr><td>6</td><td>X</td><td>X</td><td></td><td></td></tr> <tr><td>7</td><td>X</td><td>X</td><td>X</td><td></td></tr> <tr><td>8</td><td>X</td><td>X</td><td>X</td><td>X</td></tr> <tr><td>9</td><td>X</td><td></td><td></td><td></td></tr> <tr><td>10</td><td>X</td><td>X</td><td></td><td></td></tr> <tr><td>11</td><td>X</td><td>X</td><td>X</td><td>X</td></tr> </table>	0					1					2	X				3	X	X			4			X		5	X				6	X	X			7	X	X	X		8	X	X	X	X	9	X				10	X	X			11	X	X	X	X																																																												
0																																																																																																																													
1																																																																																																																													
2	X																																																																																																																												
3	X	X																																																																																																																											
4			X																																																																																																																										
5	X																																																																																																																												
6	X	X																																																																																																																											
7	X	X	X																																																																																																																										
8	X	X	X	X																																																																																																																									
9	X																																																																																																																												
10	X	X																																																																																																																											
11	X	X	X	X																																																																																																																									
	08		0	B112	<table border="1"> <tr><td>0</td><td></td><td></td><td></td><td></td><td></td><td>X</td><td>X</td><td>X</td><td>X</td></tr> <tr><td>1</td><td></td><td></td><td></td><td></td><td></td><td></td><td></td><td></td><td></td></tr> <tr><td>2</td><td>X</td><td></td><td></td><td></td><td></td><td>X</td><td>X</td><td>X</td><td>X</td></tr> <tr><td>3</td><td>X</td><td>X</td><td></td><td></td><td></td><td></td><td></td><td></td><td></td></tr> <tr><td>4</td><td></td><td></td><td>X</td><td></td><td></td><td>X</td><td>X</td><td>X</td><td></td></tr> <tr><td>5</td><td>X</td><td></td><td></td><td></td><td></td><td>X</td><td>X</td><td>X</td><td></td></tr> <tr><td>6</td><td>X</td><td>X</td><td></td><td></td><td></td><td></td><td></td><td></td><td></td></tr> <tr><td>7</td><td>X</td><td>X</td><td>X</td><td></td><td></td><td>X</td><td>X</td><td>X</td><td></td></tr> <tr><td>8</td><td>X</td><td>X</td><td>X</td><td>X</td><td></td><td>X</td><td>X</td><td>X</td><td>X</td></tr> <tr><td>9</td><td>X</td><td></td><td></td><td></td><td>X</td><td>X</td><td>X</td><td>X</td><td></td></tr> <tr><td>10</td><td>X</td><td></td><td></td><td></td><td></td><td></td><td></td><td></td><td>X</td></tr> <tr><td>11</td><td>X</td><td>X</td><td></td><td></td><td></td><td>X</td><td>X</td><td>X</td><td></td></tr> </table>	0						X	X	X	X	1										2	X					X	X	X	X	3	X	X								4			X			X	X	X		5	X					X	X	X		6	X	X								7	X	X	X			X	X	X		8	X	X	X	X		X	X	X	X	9	X				X	X	X	X		10	X								X	11	X	X				X	X	X	
0						X	X	X	X																																																																																																																				
1																																																																																																																													
2	X					X	X	X	X																																																																																																																				
3	X	X																																																																																																																											
4			X			X	X	X																																																																																																																					
5	X					X	X	X																																																																																																																					
6	X	X																																																																																																																											
7	X	X	X			X	X	X																																																																																																																					
8	X	X	X	X		X	X	X	X																																																																																																																				
9	X				X	X	X	X																																																																																																																					
10	X								X																																																																																																																				
11	X	X				X	X	X																																																																																																																					

Type designation

Rotary cam switches OC10...25, standard and customized











Option:

OC 25 G 01 PN B N 0 0 N A1

Position:

1 2 3 4 5 6 7 8 9

Order code example

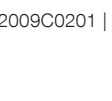







Position	Description	Option	
		OC10	OC25
1	Cam switch size Current rating, I_{th} [A]	OC10 G 10	OC25 G 25
2	Number of contacts	01...16	01...24, up to 72 (triple gang)
3	Mounting type and Handle type		
	Base mounting, Modular, IP20		MN 
	Door mounting, Snap-on, Nose handle, IP66	PN	PN 
	Door mounting, Screw mounting, Nose handle, IP40 or IP66	RN	RN 
	Base mounting, Snap-on, Nose handle, IP66, with shaft		BN 
	Base mounting, Snap-on, Direct Nose handle, IP66		DN 
	Door mounting, Snap-on, Nose handle, Large front plate, IP66		PM 
	Door mounting, Screw mounting, Nose handle, Large front plate, IP40 or IP66		RM 
	Base mounting, Snap-on, Nose handle, Large front plate, IP66, with shaft		BM 
	Base mounting, Snap-on, Direct Nose handle, Large front plate, IP66		DM 
	Door mounting, Snap-on, Extended handle, IP66		PE 
	Door mounting, Screw mounting, Extended handle, IP40 or IP66		RE 
	Base mounting, Snap-on, Extended handle, IP66, with shaft		BE 
	Base mounting, Snap-on, Extended handle, IP66		BE
	Base mounting, Snap-on, Direct Extended handle, IP66		DE
	Door mounting, Snap-on, Extended handle, Large front plate, IP66		PF
	Door mounting, Screw mounting, Extended handle, Large front plate, IP40 or IP66		RF
	Base mounting, Screw mounting, Direct extended handle, Large front plate, IP40 or IP66 ¹⁾		CF
	Base mounting, Snap-on, Extended handle, Large front plate, IP66, with shaft		BF
	Base mounting, Snap-on, Direct Extended handle, Large front plate, IP66		DF
	Door mounting, Snap-on, Nose handle, Padlockable, IP66		P1
	Door mounting, Screw mounting, Nose handle, Padlockable, IP40 or IP66		R1
	Base mounting, Snap-on, Nose handle, Padlockable, IP66, with shaft		B1
	Base mounting, Snap-on, Direct Nose handle, Padlockable, IP66		D1
	Door mounting, Snap-on, Extended handle, Padlockable, Large front plate, IP66		P2
	Door mounting, Screw mounting, Extended handle, Padlockable, Large front plate, IP40 or IP66		R2
	Base mounting, Snap-on, Extended handle, Padlockable, Large front plate, IP66, with shaft		B2
	Base mounting, Snap-on, Direct Extended handle, Padlockable, Large front plate, IP66		D2
	Base mounting, Screw mounting, Direct extended handle, Padlockable, Large front plate, IP40 or IP66 ¹⁾		C2
	Door mounting, Snap-on, Round padlockable, IP67		P3
	Door mounting, Screw mounting, Round padlockable, IP40 or IP67		R3
	Base mounting, Snap-on, Round padlockable, IP67, with shaft		B3

¹⁾ For tandem or triple gang only (see position 6)

Type designation

Rotary cam switches OC10...25, standard and customized

Option:	OC	25	G	01	PN	B	N	0	0	N	A1
Position:	1	2	3	4	5	6	7	8	9		
Order code example											

Position	Description	Option			
		OC10	OC25		
3	Continued from previous page. Mounting type and Handle type				
	Door mounting, Snap-on, Nose handle, Round front ring, IP66	PX		PX	
	Door mounting, Snap-on, Key operated, IP54	KN		KN	
	Door mounting, Snap-on, Key operated, Large front plate, IP54			KM	
	Door mounting, Snap-on, Key operated, Round front ring, IP54	KX		KX	
	Door mounting, Screw mounting, Key Interlock, IP40 or IP65			QN	
	Door mounting, Screw mounting, Key interlock, Large front plate, IP40 or IP65			QM	
4	Colour option				
	No handle	0		0	
	Black	B		B	(Not available for "Modular")
	Grey	G		G	
	Red (Only for round padlockable handle)			R	
	Red-yellow (Available for all padlockable handles)			Y	
5	Terminal type/contact material				
	Standard box (tunnel) terminals	N		N	
	Standard box (tunnel) terminals, Gold contacts	G		G	
6	Mechanical option				
	No options 2	0		0	
	Metallic shaft option for Door mounting, Screw mounting			T	
	Tandem gang for 25A frame up to 24+24 contacts			2	
	Triple gang for 25A frame up to 24+24+24 contacts			3	

Type designation

Rotary cam switches OC10...25, standard and customized

Option: OC 25 G 01 PN B N 0 0 N A1

Position: 1 2 3 4 5 6 7 8 9

Order code example

Position	Description	Option	
		OC10	OC25
7	Legend and IP option		
	No options	0	0
	Additional lettering plate (Not available with round front ring)	P	P
	Handle IP40 (option for screw mounted handles)	H	H
	Additional lettering plate and handle IP40 (option for screw mounted handles only)	E	E
8	Configuration		
	Cam Switch (Followed by function code)	N	N
9	Index number for Special Cam Switches		
	Index number for cam switches generated in Camweb2	SXXXX	SXXXX
9	Function code for cam switches, see pages 40...55		
	ON - OFF switches		
	O-position: 9 o'clock, step angle 90°	A1... A8	A1... A8, B1...B8
	O-position: 12 o'clock, step angle 90°	A01... A06	A01...A08, B01...B08
	O-position: 12 o'clock, step angle 30°, spring return		R01...R08
	O-position: 12 and 6 o'clock, step angle 90°, late break		BB3
	O-position: 9 o'clock, step angle 90°, fourth pole with later break		AC4, AC8
	Change-over switches		
	With 0-position, step angle 60°	U1...U4	U1...U10, UB1...UB8, UA1...UA8, UM1...UM8, UH1, US1...US8, UK1... UK8, UP1...UP8, UZ1... UZ6
	With 0-position, with two sided spring return, step angle 30°	URR1...URR3	URR1...URR6
	With 0-position, with two sided spring return, step angle 30°, without jumbers		URZ1...URZ6
	Without 0-position, step angle 60°	WS1...WS5	WS1... WS10, WR1... WR8, WA1...WA8, WZ1...WZ6
	With overlapping contacts, step angle 60°	WC1...WC4	WC1...WC4
	With common center position and with overlapping contacts, step angle 60°	UC3, UC4	UC3, UC4
	Bypass switches		
	With 0-position, step angle 60°, without overlapping, 3 and 4- pole network	WS36, WS48	WS36, WS48
	Without 0-position, step angle 60°, with overlapping, 3 and 4- pole network	PW36, PW48	PW36, PW48
	Multistep switches		
	2- step, with 0-position	SO21... SO24	SO21... SO24
	3- step, with 0-position	SO31... SO34	SO31... SO34
	3- step, without 0-position	ST31...ST34	ST31...ST34
	4- step, with 0-position	SO41...SO43	SO41...SO43
	4- step, without 0-position	ST41...ST43	ST41...ST43
	5- step, with 0-position	SO51, SO52	SO51, SO52
	5- step, without 0-position	ST51, ST52	ST51, ST52
	6-step, with 0-position	SO61... SO63	SO61... SO63
	6-step, without 0-position	ST61...ST63	ST61...ST63
	7-step, with 0-position	SO71	SO71
	7-step, without 0-position	ST71	ST71

Type designation

Rotary cam switches OC10...25, standard and customized

Option:	OC 25 G 01 PN B N 0 0 N A1									
Position:	1	2	3	4	5	6	7	8	9	
Order code example										

Position	Description	Option	
		OC10	OC25
9	Continued from previous page. Function code for cam switches, see pages 40...55		
	8-step, with 0-position	SO81	SO81
	8-step, without 0-position	ST81	ST81
	9-step, with 0-position	SO91	SO91
	9-step, without 0-position	ST91	ST91
	10-step, with 0-position	SO10	SO10
	10-step, without 0-position	ST10	ST10
	11-step, with 0-position	SO11	SO11
	11-step, without 0-position	ST11	ST11
	12-step, without 0-position	ST12	ST12
	Motor control switches		
	Ventilation switches	ST30	ST30
	Reversing switches	W2, W3	W2, W3
	Star-delta switches	SD	SD
	Pole-change switches (Dahlander)	P12	P12
	Pumpstart switches	SE15	SE15
	Stop switches	SA2	SA2
	Start switches, Stop-Start	SEA1	SEA1
	Start switches, 0-1-Start	SEA0	SEA0
	Start switches, 0-Start	SE2	SE2
	Start switches, Start-1-0-2-Start	UR13	UR13
	Voltmeter switches		
	3 Positions, 3 phase -3 wire, without 0-position, step angle 45°	VN3	VN3
	4 Positions, 3 phase -3 wire, with 0-position, step angle 45°	V3, VT3, VGR3, VGL3	V3, VT3, VGR3, VGL3
	6 Positions, 3 phase to phase 3 phase to neutral, without 0-position, step angle 30°	VN30	VN30
	7 Positions, 3 phase to phase 3 phase to neutral, with 0-position, step angle 45°	V30, VT30, VR30	V30, VT30, VR30
	7 Positions, 3 phase to phase voltages for 2 circuits, with 0 position, step angle 45°	V32	V32
	Ammeter switches		
	For 3 current transformer circuits, with 0-position, step angle 90°	AU31/32, AR31/32, AS31/32	AU31/32, AR31/32, AS31/32
	Volt-ammeter switches		
	Voltmeter contacts closer to handle	VA21	VA21
	Ammeter contacts closer to handle	AV12	AV12
	Binarycode switches		
	With 0-position, step angle 30°	B070, B071, B072, B090, B091, B092, B110, B112	B070, B071, B072, B090, B091, B092, B110, B112

Dimension drawings

Rotary cam switches OC10

Door mounting

mm/in

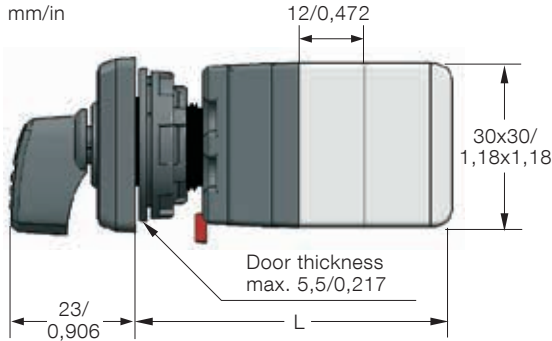

Snap-on mounting, IP66

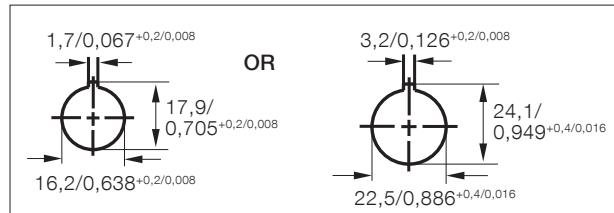

Door drilling, snap-on mounting*

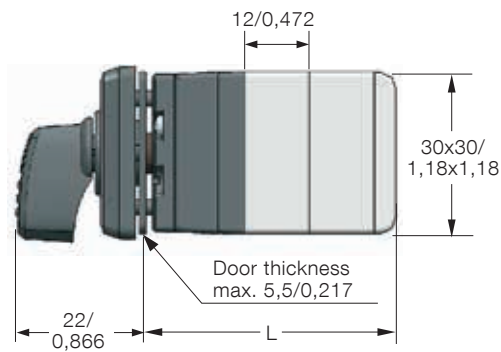

Screw mounting type, IP66

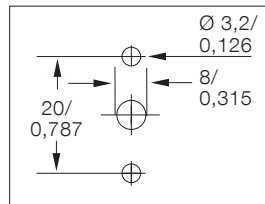

Door drilling, screw mounting

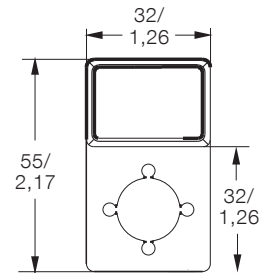

Option P (for position 7 in order code)

	Option**	Length L [mm/in] for number of contact chambers (two contacts / contact chamber)							
		1	2	3	4	5	6	7	8
Snap-on mounting	PN, KN, PX, KX	46/1,81	58/2,28	70/2,76	82/3,23	94/3,70	106/4,17	118/4,65	130/5,12
Screw mounting	RN	36/1,42	48/1,89	60/2,36	72/2,83	84/3,31	96/3,78	108/4,25	120/4,72

* OC10 snap-on handles are always equipped with a fixing ring, which enables the switch to be mounted to the 22.5mm door drilling.

** Option for position 3 in order code

Dimension drawings

Handles, OC10

Snap-on mounting*



mm/in

Nose handle

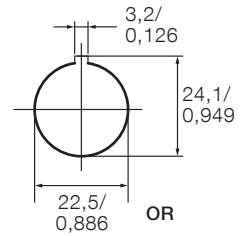
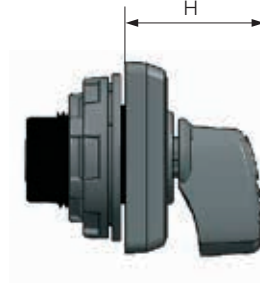
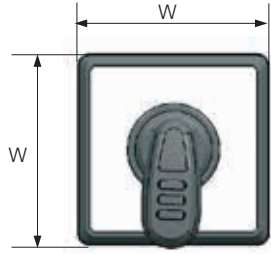

OR

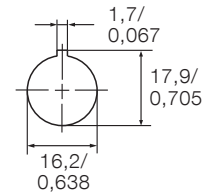

Handle type, suitable for OC10	Option**	Protection degree	Size [mm/in]	
			W	H
Nose handle	PN	IP66	32/1,26	23/0,906

* OC10 snap-on handles are always equipped with a fixing ring, which enables the switch to be mounted to the 22.5 mm door drilling.

** Option for position 3 in order code

Screw mounting



mm/in

Nose handle

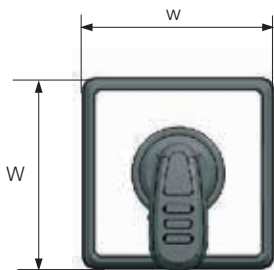

Handle type, suitable for OC10	Option**	Protection degree	Size [mm/in]	
			W	H
Nose handle	RN	IP66	32/1,26	22/0,866

** Option for position 3 in order code

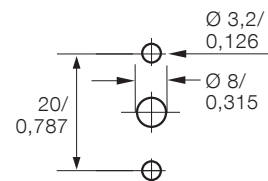

Dimension drawings

Handles, OC10

Round front ring*

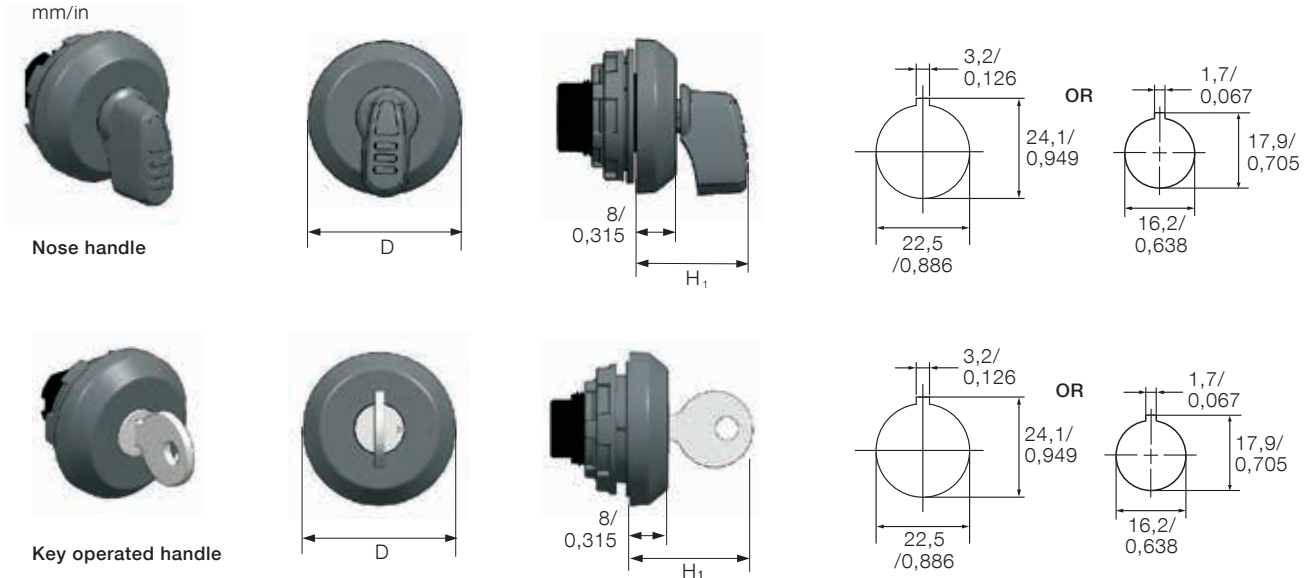

Handle type, suitable for OC10	Option**	Protection degree	Size [mm/in]	
			H ₁	D
Nose handle	PX	IP66	22/0,866	32/1,26
Key operated handle	KX	IP54	31/1,22	32/1,26

* OC10 snap-on handles are always equipped with a fixing ring, which enables the switch to be mounted to the 22.5 mm door drilling.

** Option for position 3 in order code

Snap-on key operated*

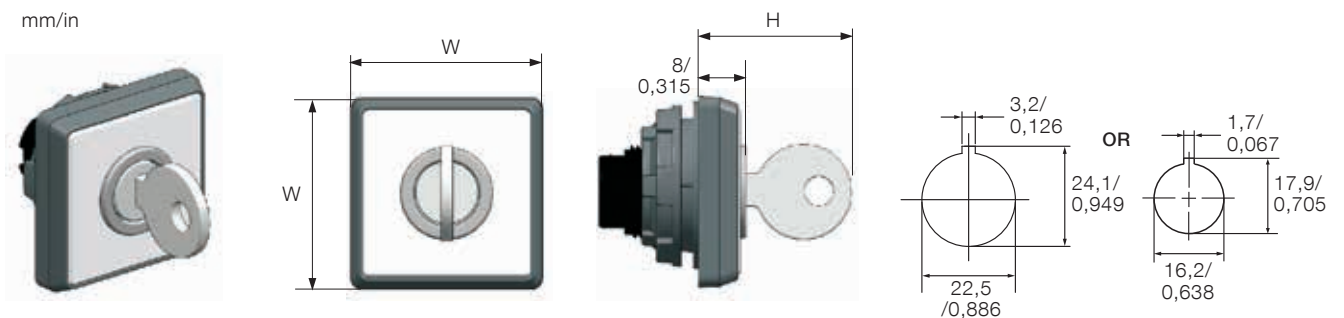

Handle type, suitable for OC10	Option**	Protection degree	Size [mm/in]	
			W	H
Key operated handle	KN	IP54	32/1,26	31/1,22

* OC10 snap-on handles are always equipped with a fixing ring, which enables the switch to be mounted to the 22.5 mm door drilling.

** Option for position 3 in order code

Dimension drawings

Rotary cam switches, OC25

Door mounting

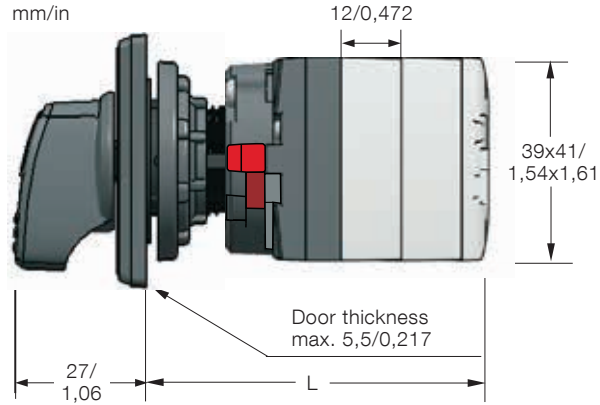

Snap-on mounting, IP66

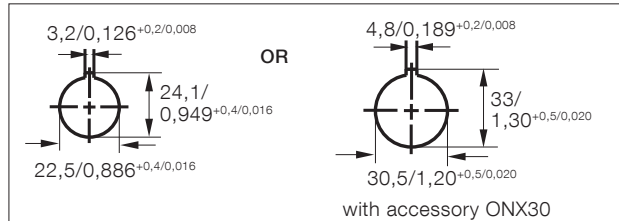

Door drilling, snap-on mounting

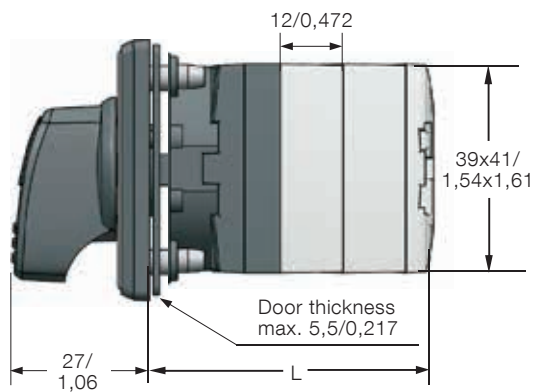

Screw mounting type, IP66

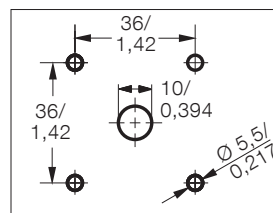

Door drilling, screw mounting

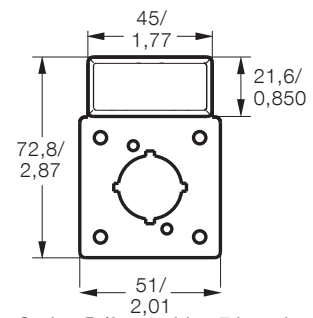

Option P (for position 7 in order code)

	Option**	Length L [mm/in] for number of contact chambers (two contacts / contact chamber)											
		1	2	3	4	5	6	7	8	9	10	11	12
Snap-on mounting	PN, KN, PX, KX	56/	68/	80/	92/	104/	116/	128/	140/	152/	164/	176/	188/
		2,20	2,68	3,15	3,62	4,09	4,57	5,04	5,51	5,98	6,46	6,93	7,40
Screw mounting	RN	44/	56/	68/	80/	92/	104/	116/	128/	140/	152/	164/	176/
		1,73	2,20	2,68	3,15	3,62	4,09	4,57	5,04	5,51	5,98	6,46	6,93

** Option for position 3 in order code

Dimension drawings

Handles, OC25

Snap-on mounting

mm/in



Nose handle

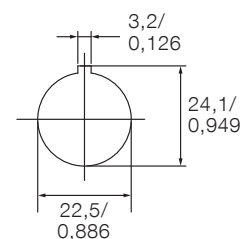
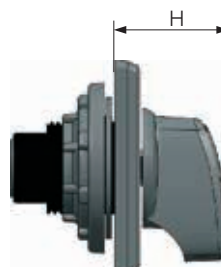
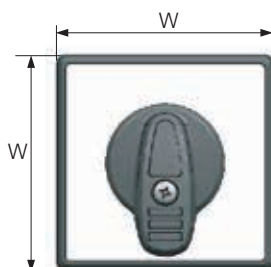

Handle type, suitable for OC25	Option**	Protection degree	Size [mm/in]	
			W	H
Nose handle	PN, BN, DN	IP66	51/2,01	27/1,06
Nose handle, large front plate	PM, BM, DM	IP66	66/2,60	30/1,18
Extended handle	PE, BE, DE	IP66	51/2,01	27/1,06
Extended handle, large front plate	PF, BF, DF	IP66	66/2,60	31/1,22

** Option for position 3 in order code



Extended handle

Screw mounting

mm/in



Nose handle

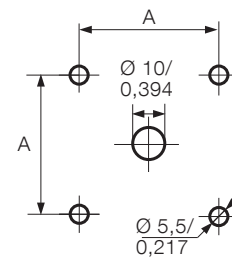
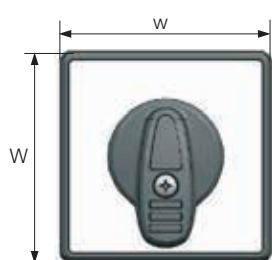

Handle type, suitable for OC25	Option**	Protection degree	Size [mm/in]	
			W	H
Nose handle	RN	IP66	51/2,01	27/1,06
Nose handle, large front plate	RM	IP66	66/2,60	30/1,18
Extended handle	RE	IP66	51/2,01	27/1,06
Extended handle, large front plate	RF, CF	IP66	66/2,60	31/1,22

** Option for position 3 in order code



Extended handle

Dimension drawings

Handles, OC25

Round front ring, snap-on mounted

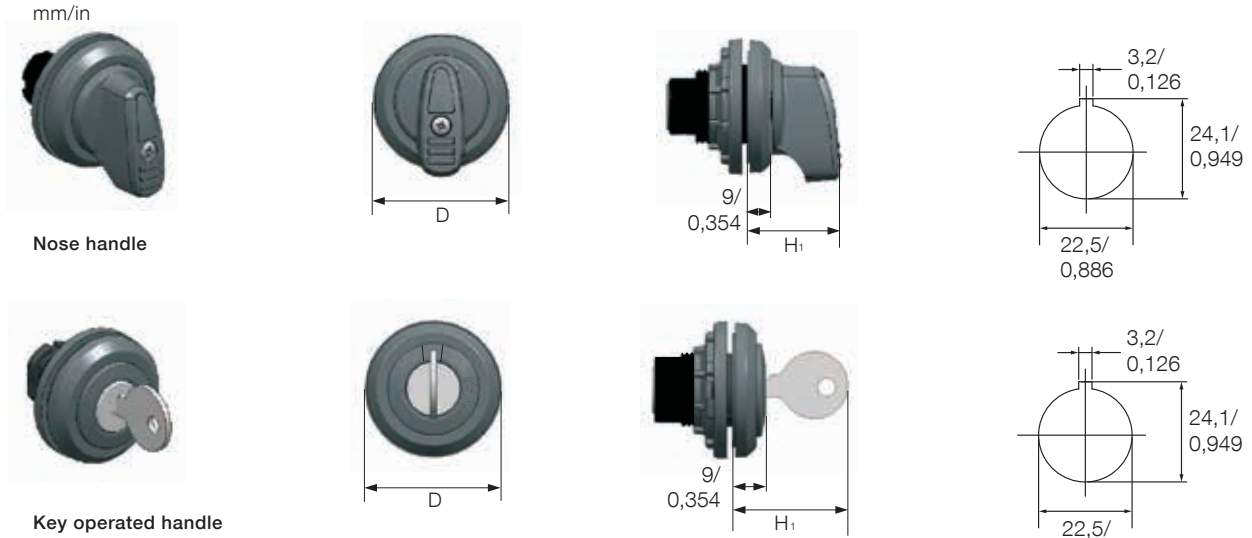

Handle type, suitable for OC25	Option**	Protection degree	Size [mm/in]	
			H ₁	D
Nose handle	PX	IP66	27/1,06	39/ 1,54
Key operated handle	KX	IP54	32/1,26	39/ 1,54

** Option for position 3 in order code

Snap-on key operated

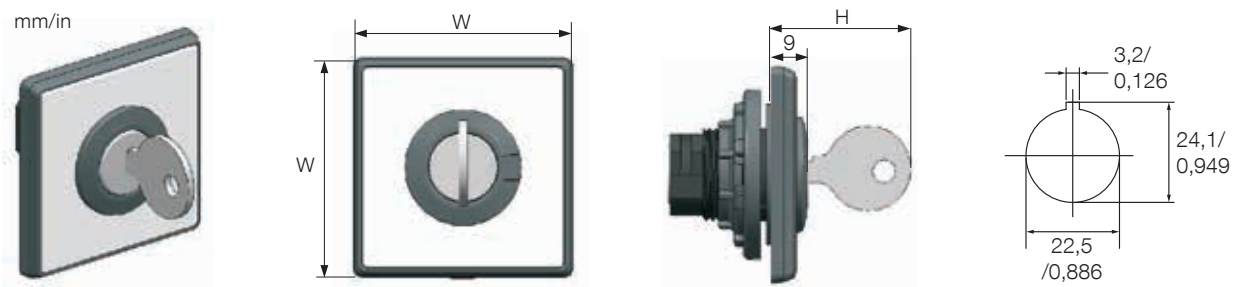

Handle type, suitable for OC25	Option**	Protection degree	Size [mm/in]	
			W	H
Key operated handle	KN	IP54	51/2,01	32/1,26
Key operated handle, large front plate	KM	IP54	66/2,60	32/1,26

** Option for position 3 in order code

Dimension drawings

Rotary cam switches, OC25

Modular type, mounting on DIN-rail

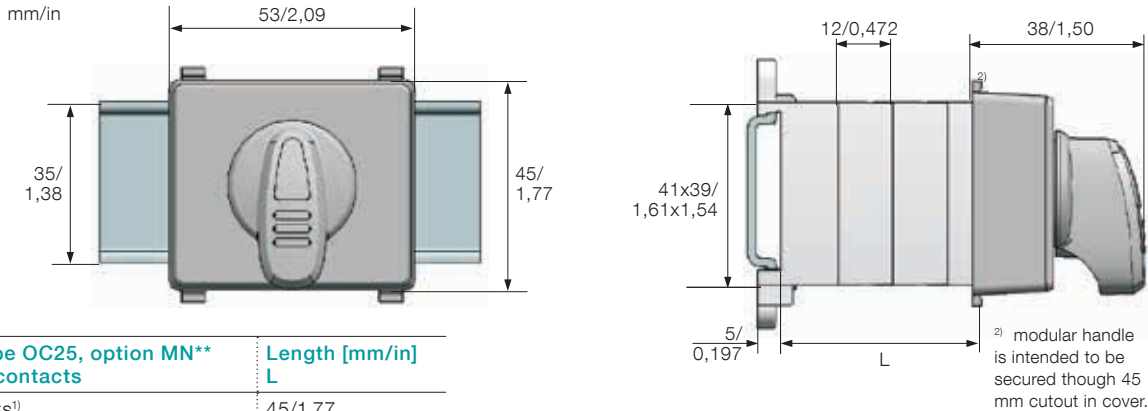

Modular type OC25, option MN** Number of contacts	Length [mm/in] L
1...6 contacts ¹⁾	45/1,77
7...8 contacts	57/2,24
9...10 contacts	69/2,72
11...12 contacts	81/3,19

¹⁾ If 6 contacts or less are used, the switch depth is consistent with other standard 45 mm components, such as miniature circuit breakers.

** Option for position 3 in order code

Base mounting with direct snap-on handle

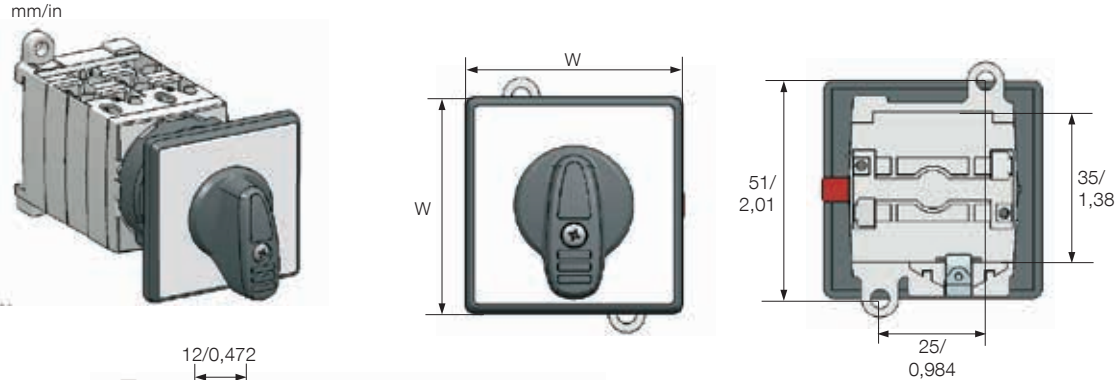

Handle type, suitable for OC25, IP66	Option**	Size [mm/in]	
		W	H
Direct, snap-on handles			
Nose handle	DN	51/2,01	27/1,06
Nose handle, large front plate	DM	66/2,60	30/1,18
Extended handle	DE	51/2,01	27/1,06
Extended handle, large front plate	DF	66/2,60	31/1,22
Nose handle, padlockable	D1	51/2,01	34/1,34
Extended handle, padlockable, large front plate	D2	66/2,60	46/1,81

** Option for position 3 in order code

Length L [mm/in] for number of contact chambers (two contacts / contact chamber)

1	2	3	4	5	6	7	8	9	10	11	12
62/2,44	74/2,91	86/3,39	96/3,78	110/4,33	122/4,80	134/5,28	146/5,75	158/6,22	170/6,69	182/7,17	194/7,64

Dimension drawings

Rotary cam switches, OC25

Base mounting with normal shaft and snap-on handle

mm/in

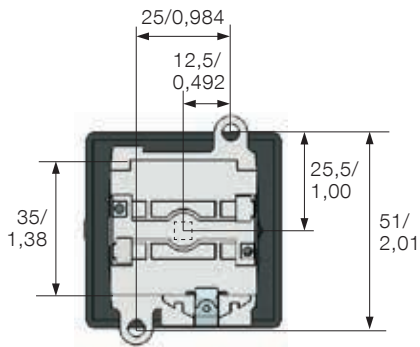
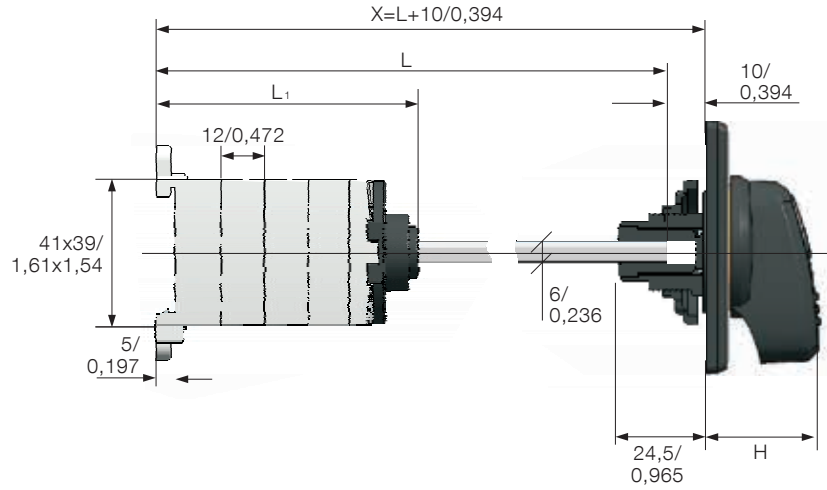
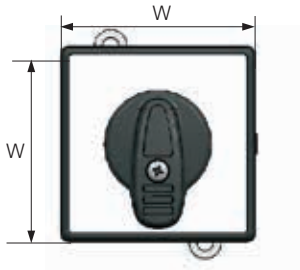

Handle type, suitable for OC25	Option**	Protection degree	Size [mm/in]	
			W	H
Snap-on handles				
Nose handle	BN	IP66	51/2,01	27/1,06
Nose handle, large front plate	BM	IP66	66/2,60	30/1,18
Extended handle	BE	IP66	51/2,01	27/1,06
Extended handle, large front plate	BF	IP66	66/2,60	31/1,22
Nose handle, padlockable	B1	IP66	51/2,01	34/1,34
Extended handle, padlockable, large front plate	B2	IP66	66/2,60	46/1,81
Round padlockable handle	B3	IP67	66/2,60	35/1,38

** Option for position 3 in order code

	Number of contact chambers / shaft length (example) 220 mm (two contacts / contact chamber)											
	1	2	3	4	5	6	7	8	9	10	11	12
X [mm/in]	268/10,6	280/11,0	292/11,5	304/12,0	316/12,4	328/12,9	340/13,4	352/13,9	364/14,3	376/14,8	388/15,3	400/15,7
L [mm/in]	258/10,2	270/10,6	282/11,1	294/11,6	306/12,0	318/12,5	330/13,0	342/13,5	354/13,9	366/14,4	378/14,9	390/15,3
L1 [mm/in]	48,5/1,91	60,5/2,38	72,5/2,85	84,5/3,33	96,5/3,80	108,5/4,27	120,5/4,74	132,5/5,22	144,5/5,69	156,5/6,16	168,5/6,63	180,5/7,11

Dimension drawings

Lockable handles, OC25

Padlockable

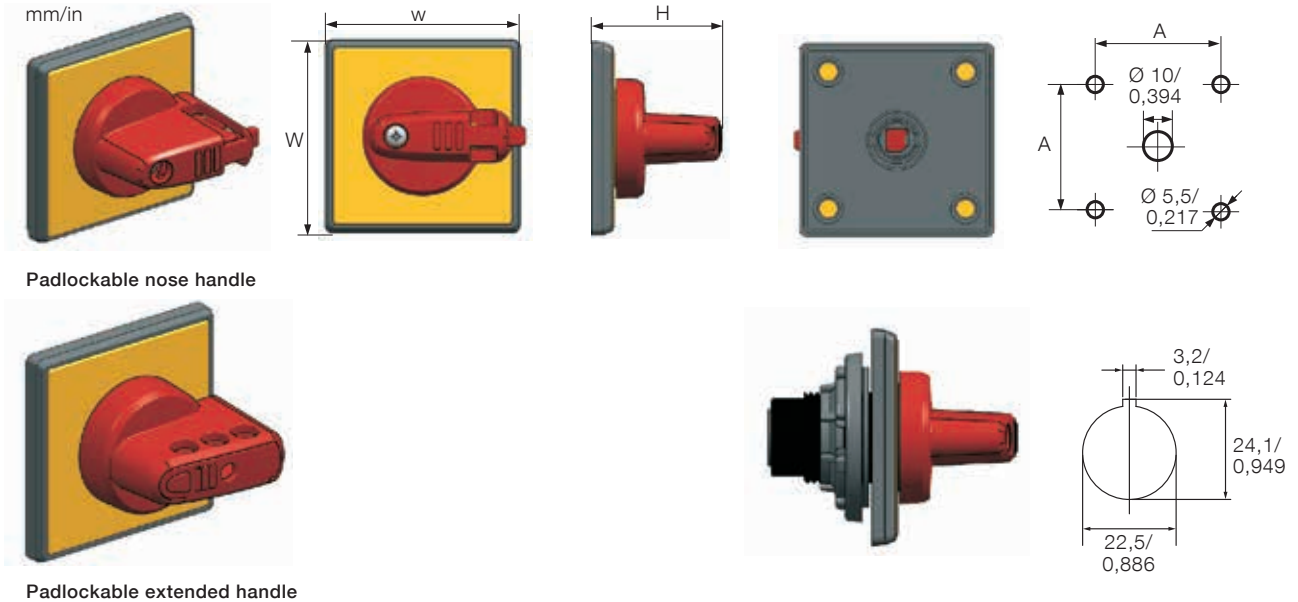

Handle type, suitable for OC25	Option**	Protection degree	Size [mm/in]		
			W	H	A
Padlockable nose handle snap-on mounted	P1, B1, D1	IP66	51/2,01	34/1,34	
Padlockable nose handle screw mounted	R1	IP66	51/2,01	34/1,34	36/1,42
Padlockable extended handle snap-on mounted	P2, B2, D2, C2	IP66	66/2,60	46/1,81	
Padlockable extended handle screw mounted	R2	IP66	66/2,60	46/1,81	48/1,89

** Option for position 3 in order code

Round padlockable screw mounted

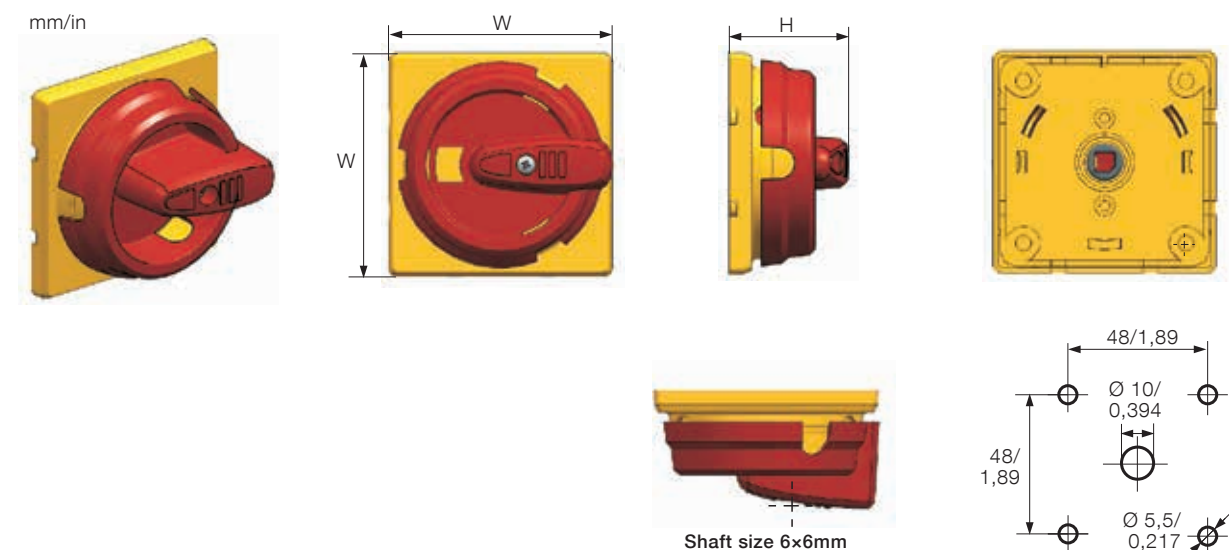

Handle type, suitable for OC25	Option**	Protection degree	Size [mm/in]	
			W	H
Round padlockable handle	R3	IP67	66/2,60	35/1,38

** Option for position 3 in order code

Dimension drawings

Lockable handles, OC25

Round padlockable handle, snap-on mounted

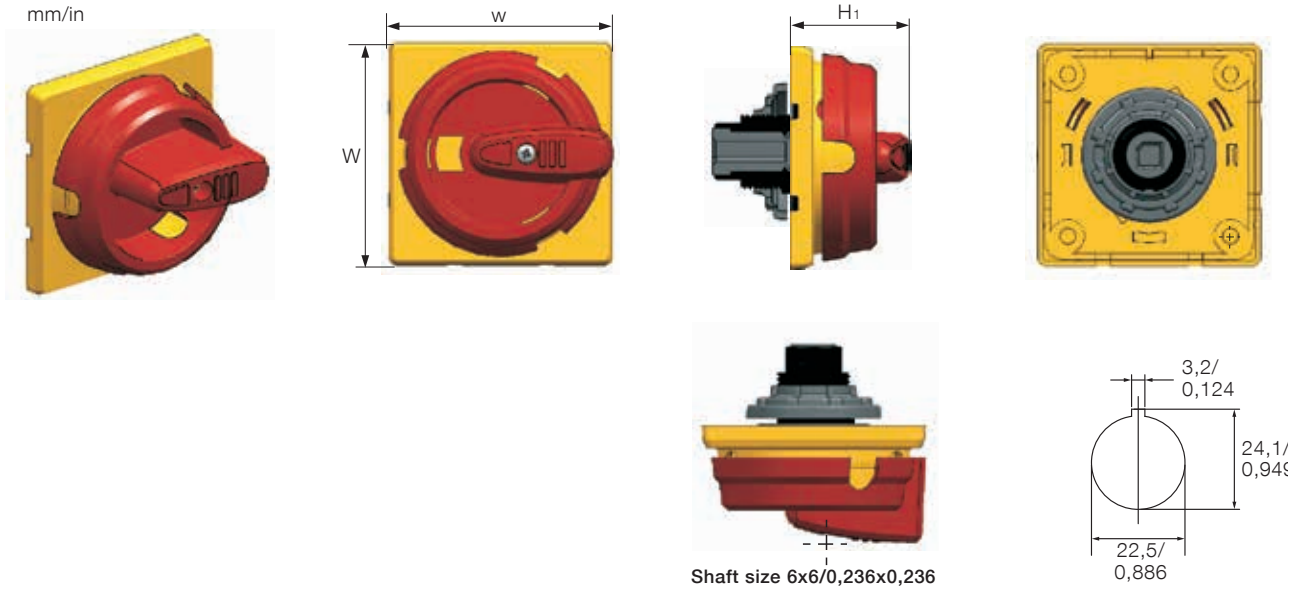

Handle type, suitable for OC25	Option**	Protection degree	Size [mm/in]	
			W	H ₁
Round padlockable handle	P3, B3	IP67	66/2,60	35/1,38

** Option for position 3 in order code

Key interlocked handle, screw mounted

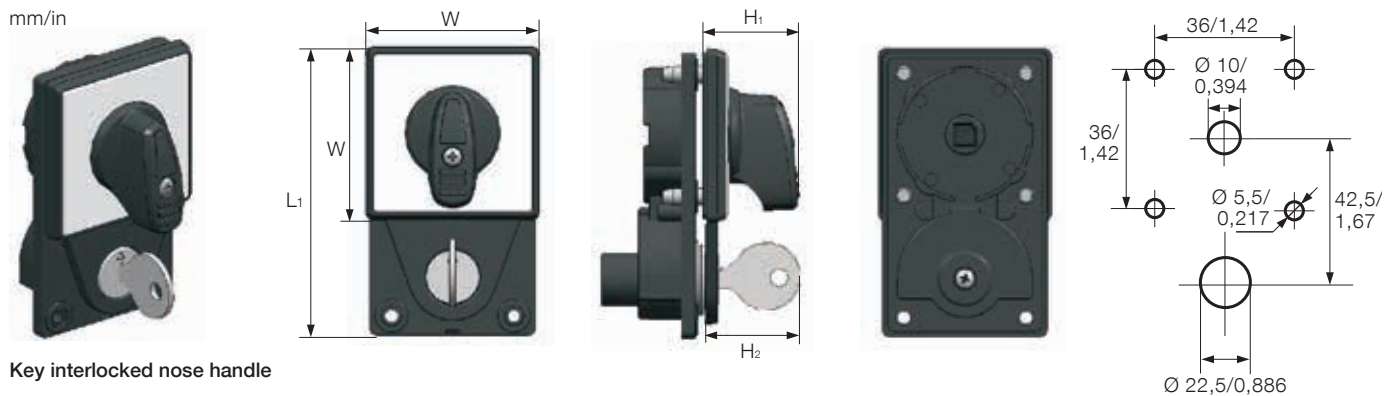

Key interlocked nose handle

Handle type, suitable for OC25	Option**	Protection degree	Size [mm/in]			
			W	L ₁	H ₁	H ₂
Key interlocked handle	QN	IP65	51/2,01	85/3,35	28/1,10	27/1,06
Key interlocked handle, large front plate	QM	IP65	66/2,60	93/3,66	32/1,26	27/1,06

** Option for position 3 in order code

Dimension drawings

Gang drive handles, OC25

Double gang (Tandem) drive

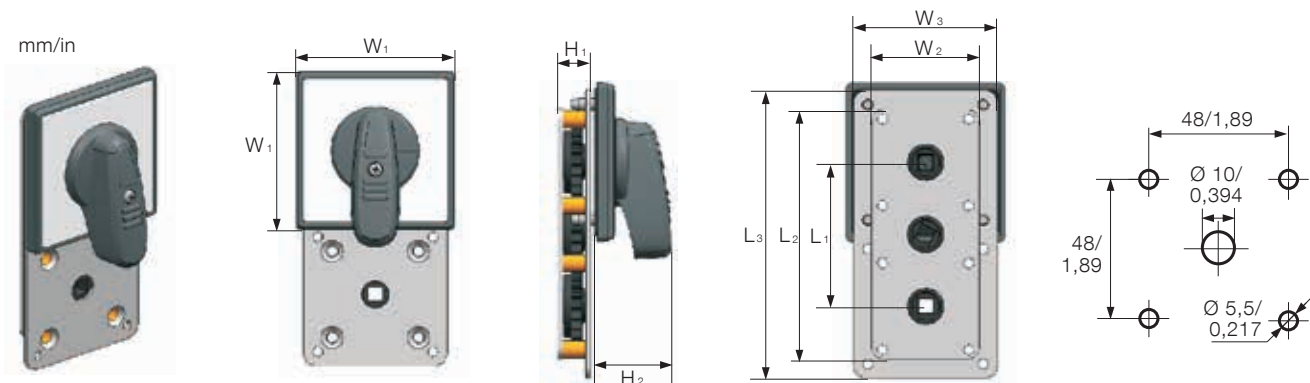

Type	Size [mm/in]							
	W ₁	W ₂	W ₃	L ₁	L ₂	L ₃	H ₁	H ₂
Double gang drive handle	66/2,60	45/1,77	60/2,36	60/2,36	104/4,09	120/4,72	13,5/0,532	31/1,22

Triple gang drive

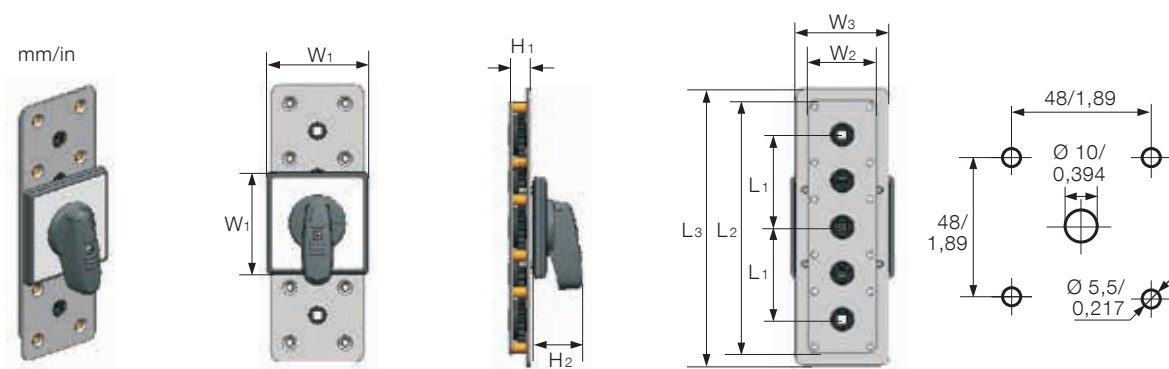

Type	Size [mm/in]							
	W ₁	W ₂	W ₃	L ₁	L ₂	L ₃	H ₁	H ₂
Triple gang drive handle	66/2,60	45/1,77	60/2,36	60/2,36	164/6,46	180/7,09	13,5/0,532	31/1,22

Dimension drawings

Front plates, OC10...25

Front plates

mm/in

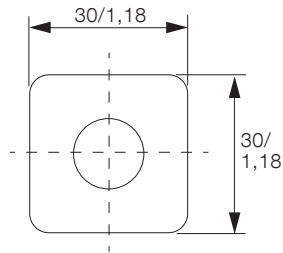

OC10: 30x30/1,18x1,18

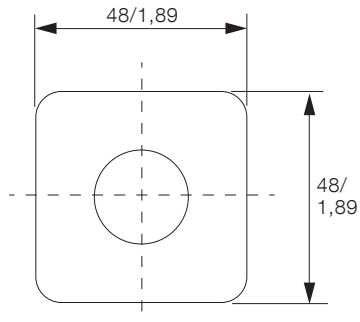

OC25: 4x48/1,89x1,89

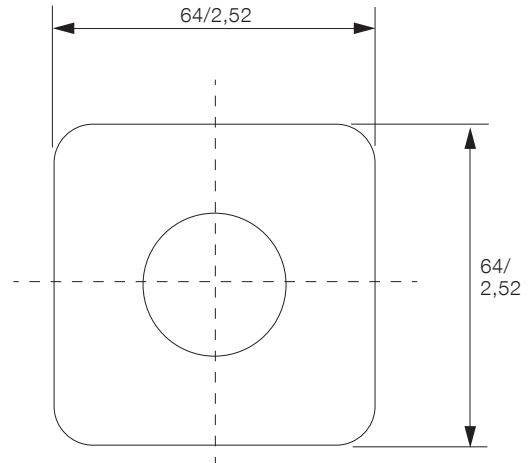

OC25: 64x64/2,52x2,52

ABB customized cam switch order form

Or visit our easy online configuration tool at <https://camweb2.com>

Company:	Contact name:
Phone number:	Customer reference:
Quantity:	Date:
Typecode (to be provided by ABB):	

Technical specification

Current rating(I_{tr}): 10 A 25 A

Configuration information

Switch mounting:	Door mounted	Base mounted (25 A only)	Base mounted w/ shaft (25 A only)
Handle mounting:	Snap-on		Screw mounted
Handle type:	Nose handle		Extended nose handle (25 A only)
	Nose-padlockable (25 A only)		Extended nose padlockable (25 A only)
	Key-interlock (25 A and screw only)		Key-operated (snap-on only)
	Round front ring		Round front ring with key
	Round padlockable (25 A only)		Modular – 45mm standard (base mounted only)
Handle colour:	Black	Gray	Red (padlockable only) Red-yellow (padlockable only)
Front plate options:	Additional legend plate		Larger front plate – 66 mm (25 A only)



Index

Type	Order number	Description	Page
OC10G01KNBN00NA01	1SCA126466R1001	ON - OFF switch	16
OC10G01KNBN00NA1	1SCA126420R1001	ON - OFF switch	15
OC10G01PNBN00NA01	1SCA126467R1001	ON - OFF switch	16
OC10G01PNBN00NA1	1SCA126421R1001	ON - OFF switch	14
OC10G01PNBN00NB01	1SCA135569R1001	ON - OFF switch	16
OC10G01PNBN00NB1	1SCA134986R1001	ON - OFF switch	14
OC10G01RNBN00NB01	1SCA135571R1001	ON - OFF switch	16
OC10G02KNBN00NU1	1SCA126486R1001	Change-over switch	17
OC10G02PNBN00NA02	1SCA126468R1001	ON - OFF switch	16
OC10G02PNBN00NA2	1SCA126423R1001	ON - OFF switch	14
OC10G02PNBN00NB02	1SCA135578R1001	ON - OFF switch	16
OC10G02PNBN00NB2	1SCA134993R1001	ON - OFF switch	14
OC10G02PNBN00NSA2	1SCA126635R1001	Stop switch	29
OC10G02PNBN00NSE15	1SCA126632R1001	Pumpstart switch	29
OC10G02PNBN00NSE2	1SCA126643R1001	Start switch	29
OC10G02PNBN00NSEA0	1SCA126638R1001	Start switch	29
OC10G02PNBN00NSO21	1SCA126551R1001	Multistep switch	21
OC10G02PNBN00NU1	1SCA126487R1001	Change-over switch	17
OC10G02PNBN00NURR1	1SCA126509R1001	Change-over switch	18
OC10G02PNBN00NWC1	1SCA126537R1001	Change-over switch	19
OC10G02PNBN00NWS1	1SCA126517R1001	Change-over switch	18
OC10G02RNBN00NB02	1SCA135579R1001	ON - OFF switch	16
OC10G03KNBN00NA03	1SCA126469R1001	ON - OFF switch	16
OC10G03KNBN00NA3	1SCA126425R1001	ON - OFF switch	15
OC10G03PNBN00NA03	1SCA126470R1001	ON - OFF switch	16
OC10G03PNBN00NA3	1SCA126426R1001	ON - OFF switch	14
OC10G03PNBN00NB03	1SCA135582R1001	ON - OFF switch	16
OC10G03PNBN00NB3	1SCA134996R1001	ON - OFF switch	14
OC10G03PNBN00NSO31	1SCA126564R1001	Multistep switch	22
OC10G03PNBN00NST31	1SCA126575R1001	Multistep switch	22
OC10G04PNBN00NA04	1SCA126471R1001	ON - OFF switch	16
OC10G04PNBN00NA4	1SCA126427R1001	ON - OFF switch	14
OC10G04PNBN00NB04	1SCA135585R1001	ON - OFF switch	16
OC10G04PNBN00NB4	1SCA135000R1001	ON - OFF switch	14
OC10G04PNBN00NSO22	1SCA126552R1001	Multistep switch	21
OC10G04PNBN00NSO41	1SCA126586R1001	Multistep switch	23
OC10G04PNBN00NST30	1SCA126625R1001	Ventilation switch	28
OC10G04PNBN00NST41	1SCA126592R1001	Multistep switch	23
OC10G04PNBN00NU2	1SCA126488R1001	Change-over switch	17
OC10G04PNBN00NV3	1SCA126650R1001	Voltmeter switch	30
OC10G04PNBN00NVN3	1SCA126647R1001	Voltmeter switch	30
OC10G04PNBN00NWC2	1SCA126538R1001	Change-over switch	19
OC10G04PNBN00NWS2	1SCA126518R1001	Change-over switch	18
OC10G04RNBN00NB04	1SCA135586R1001	ON - OFF switch	16
OC10G05PNBN00NA05	1SCA126472R1001	ON - OFF switch	16
OC10G05PNBN00NA5	1SCA126428R1001	ON - OFF switch	14
OC10G05PNBN00NB05	1SCA135588R1001	ON - OFF switch	16
OC10G05PNBN00NB5	1SCA135003R1001	ON - OFF switch	14
OC10G05PNBN00NSO51	1SCA126600R1001	Multistep switch	24
OC10G05PNBN00NST51	1SCA126604R1001	Multistep switch	24
OC10G06KNBN00NU3	1SCA126489R1001	Change-over switch	17
OC10G06PNBN00NA06	1SCA126473R1001	ON - OFF switch	16

Type	Order number	Description	Page
OC10G06PNBN00NA6	1SCA126429R1001	ON - OFF switch	14
OC10G06PNBN00NAU31	1SCA126665R1001	Ammeter switch	32
OC10G06PNBN00NB06	1SCA135590R1001	ON - OFF switch	16
OC10G06PNBN00NB6	1SCA135005R1001	ON - OFF switch	14
OC10G06PNBN00NSO23	1SCA126553R1001	Multistep switch	21
OC10G06PNBN00NSO32	1SCA126565R1001	Multistep switch	22
OC10G06PNBN00NST32	1SCA126576R1001	Multistep switch	22
OC10G06PNBN00NU3	1SCA126490R1001	Change-over switch	17
OC10G06PNBN00NURR3	1SCA126510R1001	Change-over switch	18
OC10G06PNBN00NV30	1SCA126658R1001	Voltmeter switch	31
OC10G06PNBN00NVN30	1SCA126655R1001	Voltmeter switch	30
OC10G06PNBN00NWC3	1SCA126539R1001	Change-over switch	19
OC10G06PNBN00NWS3	1SCA126519R1001	Change-over switch	18
OC10G08PNBN00NSO24	1SCA126554R1001	Multistep switch	21
OC10G08PNBN00NSO42	1SCA126587R1001	Multistep switch	23
OC10G08PNBN00NST42	1SCA126593R1001	Multistep switch	23
OC10G08PNBN00NU4	1SCA126491R1001	Change-over switch	17
OC10G08PNBN00NV32	1SCA126663R1001	Voltmeter switch	31
OC10G08PNBN00NWC4	1SCA126540R1001	Change-over switch	19
OC10G08PNBN00NWS4	1SCA126520R1001	Change-over switch	18
OC10G09PNBN00NSO33	1SCA126566R1001	Multistep switch	22
OC10G09PNBN00NST33	1SCA126577R1001	Multistep switch	22
OC10G10PNBN00NSO52	1SCA126601R1001	Multistep switch	24
OC10G10PNBN00NST52	1SCA126605R1001	Multistep switch	24
OC10G12PNBN00NSO34	1SCA126567R1001	Multistep switch	22
OC10G12PNBN00NSO43	1SCA126588R1001	Multistep switch	23
OC10G12PNBN00NST34	1SCA126578R1001	Multistep switch	22
OC10G12PNBN00NST43	1SCA126594R1001	Multistep switch	23
OC10GFP32S	1SCA126709R1001	Front plate	38
OC10GLP32B	1SCA126714R1001	Additional lettering plate	38
OC10GLP32G	1SCA126715R1001	Additional lettering plate	38
OC10GNUT	1SCA137931R1001	Spare Snap-on mounting nut	39
OC10GPNB	1SCA126687R1001	Handle	34
OC10GPNG	1SCA126684R1001	Handle	34
OC10GPXB	1SCA126685R1001	Handle	35
OC10GFXG	1SCA126686R1001	Handle	35
OC10GR455	1SCA126722R1001	Spare key	39
OC10GRIP32	1SCA137944R1001	Spare IP protection sheet for screw mounted handle	39
OC10GRNB	1SCA126688R1001	Handle	36
OC10GRNG	1SCA126689R1001	Handle	36
OC25G01KNBN00NA01	1SCA126474R1001	ON - OFF switch	16
OC25G01KNBN00NA1	1SCA126430R1001	ON - OFF switch	15
OC25G01KNBN00NB1	1SCA134989R1001	ON - OFF switch	15
OC25G01KXBN00NA1	1SCA126431R1001	ON - OFF switch	15
OC25G01MMNGN00NA01	1SCA126475R1001	ON - OFF switch	16
OC25G01MMNGN00NA1	1SCA126432R1001	ON - OFF switch	15
OC25G01PNBN00NA01	1SCA126476R1001	ON - OFF switch	16
OC25G01PNBN00NA1	1SCA126433R1001	ON - OFF switch	14
OC25G01PNBN00NB01	1SCA135572R1001	ON - OFF switch	16
OC25G01PNBN00NB1	1SCA134987R1001	ON - OFF switch	14

Type	Order number	Description	Page
OC25G01PXB00NA1	1SCA126435R1001	ON - OFF switch	15
OC25G01RNB00NA1	1SCA126436R1001	ON - OFF switch	15
OC25G01RNB00NB01	1SCA135575R1001	ON - OFF switch	16
OC25G01RNB00NB1	1SCA134988R1001	ON - OFF switch	15
OC25G02KBN00NU1	1SCA126492R1001	Change-over switch	17
OC25G02KXB00NA2	1SCA126437R1001	ON - OFF switch	15
OC25G02MNGN00NA02	1SCA126477R1001	ON - OFF switch	16
OC25G02MNGN00NA2	1SCA126439R1001	ON - OFF switch	15
OC25G02MNGN00NSE15	1SCA126633R1001	Pumpstart switch	29
OC25G02MNGN00NSEA0	1SCA126639R1001	Start switch	29
OC25G02MNGN00NSO21	1SCA126555R1001	Multistep switch	21
OC25G02MNGN00NU1	1SCA126493R1001	Change-over switch	17
OC25G02MNGN00NURR1	1SCA126511R1001	Change-over switch	18
OC25G02MNGN00NWS1	1SCA126521R1001	Change-over switch	18
OC25G02PNBN00NA02	1SCA126478R1001	ON - OFF switch	16
OC25G02PNBN00NA2	1SCA126440R1001	ON - OFF switch	14
OC25G02PNBN00NB02	1SCA135580R1001	ON - OFF switch	16
OC25G02PNBN00NB2	1SCA134994R1001	ON - OFF switch	14
OC25G02PNBN00NSA2	1SCA126636R1001	Stop switch	29
OC25G02PNBN00NSE15	1SCA126634R1001	Pumpstart switch	29
OC25G02PNBN00NSE2	1SCA126644R1001	Start switch	29
OC25G02PNBN00NSEA0	1SCA126640R1001	Start switch	29
OC25G02PNBN00NSEA1	1SCA126637R1001	Start switch	29
OC25G02PNBN00NSO21	1SCA126556R1001	Multistep switch	21
OC25G02PNBN00NU1	1SCA126494R1001	Change-over switch	17
OC25G02PNBN00NURR1	1SCA126512R1001	Change-over switch	18
OC25G02PNBN00NWC1	1SCA126541R1001	Change-over switch	19
OC25G02PNBN00NWS1	1SCA126522R1001	Change-over switch	18
OC25G02PXB00NA2	1SCA126441R1001	ON - OFF switch	15
OC25G02PXB00NSEA0	1SCA126641R1001	Start switch	29
OC25G02PXB00NSO21	1SCA126557R1001	Multistep switch	21
OC25G02PXB00NU1	1SCA126495R1001	Change-over switch	17
OC25G02PXB00NWS1	1SCA126523R1001	Change-over switch	18
OC25G02RNB00NA2	1SCA126442R1001	ON - OFF switch	15
OC25G02RNB00NB02	1SCA135581R1001	ON - OFF switch	16
OC25G02RNB00NB2	1SCA134995R1001	ON - OFF switch	15
OC25G02RNB00NSEA0	1SCA126642R1001	Start switch	29
OC25G02RNB00NSO21	1SCA126558R1001	Multistep switch	21
OC25G02RNB00NU1	1SCA126496R1001	Change-over switch	17
OC25G02RNB00NWS1	1SCA126524R1001	Change-over switch	18
OC25G03KBN00NA03	1SCA126479R1001	ON - OFF switch	16
OC25G03KBN00NA3	1SCA126444R1001	ON - OFF switch	15
OC25G03KBN00NB3	1SCA134997R1001	ON - OFF switch	15
OC25G03KXB00NA3	1SCA126446R1001	ON - OFF switch	15
OC25G03MNGN00NA03	1SCA126480R1001	ON - OFF switch	16
OC25G03MNGN00NA3	1SCA126447R1001	ON - OFF switch	15
OC25G03MNGN00NSO31	1SCA126568R1001	Multistep switch	22
OC25G03MNGN00NST31	1SCA126579R1001	Multistep switch	22
OC25G03MNGN00NUR13	1SCA126645R1001	Start switch	29
OC25G03PNBN00NA03	1SCA126481R1001	ON - OFF switch	16
OC25G03PNBN00NA3	1SCA126448R1001	ON - OFF switch	14
OC25G03PNBN00NB03	1SCA135583R1001	ON - OFF switch	16
OC25G03PNBN00NB070	1SCA126673R1001	Binarycode switch	33
OC25G03PNBN00NB071	1SCA126674R1001	Binarycode switch	33
OC25G03PNBN00NB3	1SCA134998R1001	ON - OFF switch	14
OC25G03PNBN00NSO31	1SCA126569R1001	Multistep switch	22
OC25G03PNBN00NST31	1SCA126580R1001	Multistep switch	22

Type	Order number	Description	Page
OC25G03PNBN00NUR13	1SCA126646R1001	Start switch	29
OC25G03PXB00NA3	1SCA126450R1001	ON - OFF switch	15
OC25G03PXB00NSO31	1SCA126570R1001	Multistep switch	22
OC25G03PXB00NST31	1SCA126581R1001	Multistep switch	22
OC25G03RNB00NA3	1SCA126451R1001	ON - OFF switch	15
OC25G03RNB00NB03	1SCA135584R1001	ON - OFF switch	16
OC25G03RNB00NB3	1SCA134999R1001	ON - OFF switch	15
OC25G03RNB00NSO31	1SCA126571R1001	Multistep switch	22
OC25G03RNB00NST31	1SCA126582R1001	Multistep switch	22
OC25G04MNGN00NST30	1SCA126626R1001	Ventilation switch	28
OC25G04MNGN00NU2	1SCA126497R1001	Change-over switch	17
OC25G04MNGN00NV3	1SCA126651R1001	Voltmeter switch	30
OC25G04MNGN00NVN3	1SCA126648R1001	Voltmeter switch	30
OC25G04MNGN00NWS2	1SCA126525R1001	Change-over switch	18
OC25G04PNBN00NA04	1SCA126482R1001	ON - OFF switch	16
OC25G04PNBN00NA4	1SCA126452R1001	ON - OFF switch	14
OC25G04PNBN00NB04	1SCA135587R1001	ON - OFF switch	16
OC25G04PNBN00NB090	1SCA126675R1001	Binarycode switch	33
OC25G04PNBN00NB091	1SCA126676R1001	Binarycode switch	33
OC25G04PNBN00NB110	1SCA126677R1001	Binarycode switch	33
OC25G04PNBN00NB4	1SCA135001R1001	ON - OFF switch	14
OC25G04PNBN00NSO22	1SCA126559R1001	Multistep switch	21
OC25G04PNBN00NSO41	1SCA126589R1001	Multistep switch	23
OC25G04PNBN00NST30	1SCA126627R1001	Ventilation switch	28
OC25G04PNBN00NST41	1SCA126595R1001	Multistep switch	23
OC25G04PNBN00NU2	1SCA126498R1001	Change-over switch	17
OC25G04PNBN00NURR2	1SCA126513R1001	Change-over switch	18
OC25G04PNBN00NV3	1SCA126652R1001	Voltmeter switch	30
OC25G04PNBN00NVN3	1SCA126649R1001	Voltmeter switch	30
OC25G04PNBN00NW2	1SCA126628R1001	Reversing switch	28
OC25G04PNBN00NWC2	1SCA126542R1001	Change-over switch	19
OC25G04PNBN00NWS2	1SCA126526R1001	Change-over switch	18
OC25G04PXB00NA4	1SCA126454R1001	ON - OFF switch	15
OC25G04PXB00NSO22	1SCA126560R1001	Multistep switch	21
OC25G04PXB00NST41	1SCA126596R1001	Multistep switch	23
OC25G04PXB00NU2	1SCA126499R1001	Change-over switch	17
OC25G04PXB00NURR2	1SCA126514R1001	Change-over switch	18
OC25G04PXB00NV3	1SCA126653R1001	Voltmeter switch	30
OC25G04PXB00NWS2	1SCA126527R1001	Change-over switch	18
OC25G04RNB00NA4	1SCA126455R1001	ON - OFF switch	15
OC25G04RNB00NB4	1SCA135002R1001	ON - OFF switch	15
OC25G04RNB00NSO22	1SCA126561R1001	Multistep switch	21
OC25G04RNB00NST41	1SCA126597R1001	Multistep switch	23
OC25G04RNB00NU2	1SCA126500R1001	Change-over switch	17
OC25G04RNB00NURR2	1SCA126515R1001	Change-over switch	18
OC25G04RNB00NV3	1SCA126654R1001	Voltmeter switch	30
OC25G04RNB00NWS2	1SCA126528R1001	Change-over switch	18
OC25G05PNBN00NA05	1SCA126483R1001	ON - OFF switch	16
OC25G05PNBN00NA5	1SCA126456R1001	ON - OFF switch	14
OC25G05PNBN00NB05	1SCA135589R1001	ON - OFF switch	16
OC25G05PNBN00NB5	1SCA135004R1001	ON - OFF switch	14
OC25G05PNBN00NSO51	1SCA126602R1001	Multistep switch	24
OC25G05PNBN00NST51	1SCA126606R1001	Multistep switch	24
OC25G05PNBN00NW3	1SCA126629R1001	Reversing switch	28
OC25G06KBN00NU3	1SCA126501R1001	Change-over switch	17
OC25G06MNGN00NA06	1SCA126484R1001	ON - OFF switch	16
OC25G06MNGN00NA6	1SCA126458R1001	ON - OFF switch	15

Type	Order number	Description	Page
OC25G06MNGN00NAU31	1SCA126668R1001	Ammeter switch	32
OC25G06MNGN00NU3	1SCA126502R1001	Change-over switch	17
OC25G06MNGN00NV30	1SCA126659R1001	Voltmeter switch	31
OC25G06MNGN00NVN30	1SCA126656R1001	Voltmeter switch	30
OC25G06MNGN00NWS3	1SCA126529R1001	Change-over switch	18
OC25G06PNBN00NA06	1SCA126485R1001	ON - OFF switch	16
OC25G06PNBN00NA6	1SCA126459R1001	ON - OFF switch	14
OC25G06PNBN00NAU31	1SCA126667R1001	Ammeter switch	32
OC25G06PNBN00NB06	1SCA135591R1001	ON - OFF switch	16
OC25G06PNBN00NB072	1SCA126678R1001	Binarycode switch	33
OC25G06PNBN00NB6	1SCA135006R1001	ON - OFF switch	14
OC25G06PNBN00NSO23	1SCA126562R1001	Multistep switch	21
OC25G06PNBN00NSO32	1SCA126572R1001	Multistep switch	22
OC25G06PNBN00NSO61	1SCA126608R1001	Multistep switch	25
OC25G06PNBN00NST32	1SCA126583R1001	Multistep switch	22
OC25G06PNBN00NST61	1SCA126611R1001	Multistep switch	25
OC25G06PNBN00NU3	1SCA126503R1001	Change-over switch	17
OC25G06PNBN00NUC3	1SCA126545R1001	Change-over switch	19
OC25G06PNBN00NURR3	1SCA126516R1001	Change-over switch	18
OC25G06PNBN00NV30	1SCA126660R1001	Voltmeter switch	31
OC25G06PNBN00NVN30	1SCA126657R1001	Voltmeter switch	30
OC25G06PNBN00NWC3	1SCA126543R1001	Change-over switch	19
OC25G06PNBN00NWS3	1SCA126530R1001	Change-over switch	18
OC25G06PXB00NAU31	1SCA126668R1001	Ammeter switch	32
OC25G06PXB00NU3	1SCA126504R1001	Change-over switch	17
OC25G06PXB00NV30	1SCA126661R1001	Voltmeter switch	31
OC25G06PXB00NWS3	1SCA126531R1001	Change-over switch	18
OC25G06RNB00NAU31	1SCA126669R1001	Ammeter switch	32
OC25G06RNB00NU3	1SCA126505R1001	Change-over switch	17
OC25G06RNB00NV30	1SCA126662R1001	Voltmeter switch	31
OC25G06RNB00NWS3	1SCA126532R1001	Change-over switch	18
OC25G07PNBN00NSO71	1SCA126614R1001	Multistep switch	26
OC25G07PNBN00NST71	1SCA126615R1001	Multistep switch	26
OC25G08PNBN00NA8	1SCA126461R1001	ON - OFF switch	14
OC25G08PNBN00NB092	1SCA126679R1001	Binarycode switch	33
OC25G08PNBN00NB112	1SCA126680R1001	Binarycode switch	33
OC25G08PNBN00NB8	1SCA135007R1001	ON - OFF switch	14
OC25G08PNBN00NP12	1SCA126631R1001	Pole-change switch	28
OC25G08PNBN00NSD	1SCA126630R1001	Star-delta switch	28
OC25G08PNBN00NSO24	1SCA126563R1001	Multistep switch	21
OC25G08PNBN00NSO42	1SCA126590R1001	Multistep switch	23
OC25G08PNBN00NSO81	1SCA126616R1001	Multistep switch	26
OC25G08PNBN00NST42	1SCA126598R1001	Multistep switch	23
OC25G08PNBN00NST81	1SCA126617R1001	Multistep switch	26
OC25G08PNBN00NU4	1SCA126506R1001	Change-over switch	17
OC25G08PNBN00NUC4	1SCA126546R1001	Change-over switch	19
OC25G08PNBN00NV32	1SCA126664R1001	Voltmeter switch	31
OC25G08PNBN00NWC4	1SCA126544R1001	Change-over switch	19
OC25G08PNBN00NWS4	1SCA126533R1001	Change-over switch	18
OC25G08PXB00NU4	1SCA126507R1001	Change-over switch	17
OC25G08PXB00NWS4	1SCA126534R1001	Change-over switch	18
OC25G08RNB00NU4	1SCA126508R1001	Change-over switch	17
OC25G08RNB00NWS4	1SCA126535R1001	Change-over switch	18
OC25G09PNBN00NPW36	1SCA126549R1001	Bypass switch	20
OC25G09PNBN00NSO33	1SCA126573R1001	Multistep switch	22
OC25G09PNBN00NSO91	1SCA126618R1001	Multistep switch	26
OC25G09PNBN00NST33	1SCA126584R1001	Multistep switch	22

Type	Order number	Description	Page
OC25G09PNBN00NST91	1SCA126619R1001	Multistep switch	26
OC25G09PNBN00NWS36	1SCA126547R1001	Bypass switch	20
OC25G10PNBN00NAU32	1SCA126670R1001	Ammeter switch	32
OC25G10PNBN00NAV12	1SCA126672R1001	Volt-ammeter switch	32
OC25G10PNBN00NSO10	1SCA126620R1001	Multistep switch	27
OC25G10PNBN00NSO52	1SCA126603R1001	Multistep switch	24
OC25G10PNBN00NST10	1SCA126621R1001	Multistep switch	27
OC25G10PNBN00NST52	1SCA126607R1001	Multistep switch	24
OC25G10PNBN00NVA21	1SCA126671R1001	Volt-ammeter switch	32
OC25G10PNBN00NWS5	1SCA126536R1001	Change-over switch	18
OC25G11PNBN00NSO11	1SCA126622R1001	Multistep switch	27
OC25G11PNBN00NST11	1SCA126623R1001	Multistep switch	27
OC25G12PNBN00NPW48	1SCA126550R1001	Bypass switch	20
OC25G12PNBN00NSO34	1SCA126574R1001	Multistep switch	22
OC25G12PNBN00NSO43	1SCA126591R1001	Multistep switch	23
OC25G12PNBN00NSO62	1SCA126609R1001	Multistep switch	25
OC25G12PNBN00NST12	1SCA126624R1001	Multistep switch	27
OC25G12PNBN00NST34	1SCA126585R1001	Multistep switch	22
OC25G12PNBN00NST43	1SCA126599R1001	Multistep switch	23
OC25G12PNBN00NST62	1SCA126612R1001	Multistep switch	25
OC25G12PNBN00NWS48	1SCA126548R1001	Bypass switch	20
OC25G18PNBN00NSO63	1SCA126610R1001	Multistep switch	25
OC25G18PNBN00NST63	1SCA126613R1001	Multistep switch	25
OC25GFP51S	1SCA126710R1001	Front plate	38
OC25GFP51Y	1SCA126711R1001	Front plate	38
OC25GFP66S	1SCA126712R1001	Front plate	38
OC25GFP66Y	1SCA126713R1001	Front plate	38
OC25GLP51B	1SCA126716R1001	Additional lettering plate	38
OC25GLP51G	1SCA126717R1001	Additional lettering plate	38
OC25GLP66B	1SCA126718R1001	Additional lettering plate	38
OC25GLP66G	1SCA126719R1001	Additional lettering plate	38
OC25GLPRPB	1SCA126787R1001	Additional lettering plate	38
OC25GLPRPG	1SCA126721R1001	Additional lettering plate	38
OC25GMNG	1SCA126708R1001	Handle	35
OC25GNUT	1SCA137932R1001	Spare Snap-on mounting nut	39
OC25GP1B	1SCA126738R1001	Handle	35
OC25GP1G	1SCA126739R1001	Handle	35
OC25GP1Y	1SCA126740R1001	Handle	35
OC25GP2B	1SCA126741R1001	Handle	35
OC25GP2G	1SCA126742R1001	Handle	35
OC25GP2Y	1SCA126743R1001	Handle	35
OC25GP3B	1SCA126744R1001	Handle	35
OC25GP3G	1SCA126745R1001	Handle	35
OC25GP3R	1SCA126746R1001	Handle	35
OC25GP3Y	1SCA126747R1001	Handle	35
OC25GPEB	1SCA126694R1001	Handle	34
OC25GPEG	1SCA126695R1001	Handle	34
OC25GPFB	1SCA126696R1001	Handle	34
OC25GPFG	1SCA126697R1001	Handle	34
OC25GPMB	1SCA126692R1001	Handle	34
OC25GPMG	1SCA126693R1001	Handle	34
OC25GPNB	1SCA126690R1001	Handle	34
OC25GPNG	1SCA126691R1001	Handle	34
OC25GPXB	1SCA126698R1001	Handle	35
OC25GPXG	1SCA126699R1001	Handle	35
OC25GR1B	1SCA126748R1001	Handle	37

Type	Order number	Description	Page
OC25GR1G	1SCA126749R1001	Handle	37
OC25GR1Y	1SCA126750R1001	Handle	37
OC25GR2B	1SCA126751R1001	Handle	37
OC25GR2G	1SCA126752R1001	Handle	37
OC25GR2Y	1SCA126753R1001	Handle	37
OC25GR3B	1SCA126754R1001	Handle	37
OC25GR3G	1SCA126755R1001	Handle	37
OC25GR3R	1SCA126756R1001	Handle	37
OC25GR3Y	1SCA126757R1001	Handle	37
OC25GR455	1SCA126723R1001	Spare key	39
OC25GREB	1SCA126704R1001	Handle	36
OC25GREG	1SCA126705R1001	Handle	36
OC25GRFB	1SCA126706R1001	Handle	36
OC25GRFG	1SCA126707R1001	Handle	36
OC25GRIP51	1SCA137948R1001	Spare IP protection sheet for screw mounted handle	39
OC25GRIP66	1SCA138027R1001	Spare IP protection sheet for screw mounted handle	39
OC25GRMB	1SCA126702R1001	Handle	36
OC25GRMG	1SCA126703R1001	Handle	36
OC25GRNB	1SCA126700R1001	Handle	36
OC25GRNG	1SCA126701R1001	Handle	36
OMNX80	1SCA022553R8440	Nut spanner tool	39
ONX30	1SCA022643R8510	Adaptor ring for snap-on handle	39
ONZ10L2	1SCA022621R1570	Protective rear cover	39
ONZ10L4	1SCA022621R1650	Protective rear cover	39
ONZ10L4	1SCA022621R1650	Protective rear cover	39
ONZ10L6	1SCA022621R1730	Protective rear cover	39
ONZ10L6	1SCA022621R1730	Protective rear cover	39

Contact us

ABB Oy

Breakers and Switches

P.O. Box 622

FI-65101 Vaasa, Finland

Phone: +358 10 22 11

Fax: +358 10 22 45708

E-Mail: firstname.surname@fi.abb.com

www.abb.com

You can find the address of your local sales organisation on the ABB homepage:

www.abb.com/contacts

> Low Voltage Products and Systems

Note: We reserve the right to make technical changes or modify the contents of this document without prior notice. With regard to purchase orders, the agreed particulars shall prevail. ABB AG does not accept any responsibility whatsoever for potential errors or possible lack of information in this document.

We reserve all rights in this document and in the subject matter and illustrations contained therein. Any reproduction, disclosure to third parties or utilization of its contents – in whole or in parts – is forbidden without prior written consent of ABB AG.

Copyright © 2014 ABB

All rights reserved

X-ON Electronics

Largest Supplier of Electrical and Electronic Components

Click to view similar products for [abb](#) manufacturer:

Other Similar products are found below :

[TV10-516R](#) [017667013](#) [RF727](#) [2CMA100178R1000](#) [2CMA100163R1000](#) [5SDD 92Z0401](#) [ESV14-BS](#) [EVS-21-250](#) [F204AC-40/0.03](#) [F362-25/0.03](#) [GJL1211201R8000](#) [GJL1211501R8000](#) [GJL1213001R0017](#) [GJL1213001R0101](#) [GJL1311001R0011](#) [GJL1311001R0101](#) [GJL1311001R8010](#) [GJL1311201R0001](#) [GJL1313001R0011](#) [GJL1313001R0101](#) [GJL1317201R0001](#) [A40-30-10-84](#) [AF09-30-01-11](#) [AF460-30-11-68](#) [1455](#) [B14-250](#) [EF45-30](#) [ERG297](#) [HSC2-20](#) [1SAM201904R1001](#) [1SAM350000R1003](#) [1SAZ721201R1009](#) [1SAZ721201R1014](#) [1SAZ721201R1025](#) [1SBL157001R1310](#) [1SBL277001R1300](#) [1SBL277001R4100](#) [1SBL367001R1300](#) [1SBL387001R4100](#) [1SBN010110R1001](#) [1SBN010110R1010](#) [1SBN010140R1022](#) [1SBN010140R1122](#) [1SDA057197R1](#) [1SFA611101R1002](#) [1SFA611130R1103](#) [1SFA611131R1101](#) [1SFA611143R1101](#) [1SFA611202R1108](#) [1SFA611203R1108](#)