

# System pro M compact® Miniature Circuit Breaker S 200/S 200 M



2GDC0021023S0012



2GDC0021038S0012

The miniature circuit breakers of the System pro M compact® series S 200 and S 200 M provide state-of-the-art safety and comfort. They stand out due to their high performance and the wide range of accessories and approvals.

## Features

- Clear contact position indication in red/green (“real CPI”)
- Unique, patented twin terminal with captive screws and an increased opening for cables up to max. 35 mm<sup>2</sup>, finger-proof (IP20)
- Busbar slot in the back for best visibility during installation
- High performance at an increased rated voltage for marine and industrial applications: 10 kA/15 kA at  $U_n = 440$  V AC acc. to IEC/EN 60947-2
- Individual product identification code
- Approved acc. to IEC/EN 60898-1, IEC/EN 60947-2 and UL 1077/CSA 22.2 No. 235 for global use

# Miniature Circuit Breaker S 200/S 200 M

## Technical data

	S 200	S 200 M
<b>General Data</b>		
Standards	IEC/EN 60898-1, IEC/EN 60947-2 UL 1077	IEC/EN 60898-1, IEC/EN 60947-2 UL 1077, CSA 22.2 No. 235
Poles	1P, 2P, 3P, 4P, 1P+N, 3P+N	
Tripping Characteristics	B, C, D, K, Z	
Rated current $I_n$	0.5 up to 63 A	
Rated insulation voltage $U_i$	250 V AC (phase to ground), 500 V AC (phase to phase)	
Rated frequency	50/60 Hz	
Overvoltage Category	III	
Pollution Degree	3	
<b>IEC/EN 60898-1</b>		
Rated operational voltage $U_n$	1P: 230/400 V AC; 1P+N: 230 V AC; 2P, 3P, 4P: 400 V AC; 3P+N: 400 V AC	
Power frequency recovery voltage $U_{max}$	1P: 253 V AC; 1P+N: 253 V AC; 2P, 3P, 4P: 440 V AC; 3P+N: 440 V AC; 1P: 72 V DC; 2P: 125 V DC	
Min. operating voltage	12 V AC, 12 V DC	
Rated short-circuit capacity $I_{en}$	6 kA	10 kA
Energy limiting class (B, C up to 40 A)	3	
Rated impulse withstand voltage $U_{imp}$ (1.2/50 $\mu$ s)	4 kV (test voltage 6.2 kV at sea level, 5 kV at 2,000 m)	
Dielectric test voltage	2.0 kV (50/60 Hz, 1 min)	
Reference temperature for tripping characteristics	B, C, D: 30 °C	
Electrical endurance	$I_n < 32$ A: 20,000 ops. (AC), 1,000 ops. (DC); one cycle 2 s - ON, 13 s - OFF $I_n \geq 32$ A: 10,000 ops. (AC), 1,000 ops. (DC); one cycle 2 s - ON, 28 s - OFF	
<b>IEC/EN 60947-2</b>		
Rated operational voltage $U_e$	1P: 230 V AC; 1P+N: 230 V AC; 2P, 3P, 4P: 440 V AC; 3P+N: 440 V AC	
Power frequency recovery voltage $U_{max}$	1P: 253 V AC; 1P+N: 253 V AC; 2P, 3P, 4P: 462 V AC; 3P+N: 462 V AC; 1P: 72 V DC; 2P: 125 V DC	
Min. operating voltage	12 V AC, 12 V DC	
Rated ultimate short-circuit breaking capacity $I_{cu}$	10 kA	15 kA
Rated service short-circuit breaking capacity $I_{cs}$	7.5 kA	$\leq 40$ A: 11.2 kA 50, 63 A: 7.5 kA
Rated impulse withstand voltage $U_{imp}$ (1.2/50 $\mu$ s)	4 kV (test voltage 6.2 kV at sea level, 5 kV at 2,000 m)	
Dielectric test voltage	2.0 kV (50/60 Hz, 1 min)	
Reference temperature for tripping characteristics	B, C, D: 55 °C; K, Z: 20 °C	
Electrical endurance	$I_n < 32$ A: 20,000 ops. (AC), 1,000 ops. (DC); one cycle 2 s - ON, 13 s - OFF $I_n \geq 32$ A: 10,000 ops. (AC), 1,000 ops. (DC); one cycle 2 s - ON, 28 s - OFF	
<b>Data acc. to UL/CSA</b>		
Rated voltage	480Y / 277 V AC	
Rated interrupting capacity	6 kA	
Application	Suppl. prot. for general use. Application Codes: TC2, OLO, SC: U1	
Reference temperature for tripping characteristic	B, C, D, K, Z: 25 °C	
Electrical endurance	6,000 ops. (AC), 6,000 ops. (DC); one cycle 1 s - ON, 9 s - OFF	
<b>Mechanical data</b>		
Housing	Insulation group II, RAL 7035	Insulation group I, RAL 7035
Toggle	Insulation group II, black, sealable	
Contact position indication	Marking on toggle (I ON/O OFF), Real CPI (red ON/green OFF)	
Protection degree acc. to EN 60529	IP20*, IP40 in enclosure with cover	
Mechanical endurance	20,000 ops.	
Shock resistance acc. to IEC/EN 60068-2-27	25 g, 3 shocks, 11 ms	
Vibration resistance acc. to IEC/EN 60068-2-6	5 g, 20 cycles at 5...150...5 Hz with load 0.8 $I_n$	
Environmental conditions acc. to IEC/EN 60068-2-30	28 cycles with 55 °C/90-96 % and 25 °C/95-100 %	
Ambient temperature	-25 ... +55 °C	
Storage temperature	-40 ... +70 °C	

\* Also fulfilling the requirements acc. to the protection degree IPXXB

# Miniature Circuit Breaker S 200/S 200 M

## Technical data and tripping characteristics

	S 200	S 200 M
<b>Installation</b>		
Terminal	Failsafe bi-directional cylinder-lift terminal	
Cross-section of conductors (top/bottom)	35 mm <sup>2</sup> / 35 mm <sup>2</sup>	
	18 – 4 AWG	
Cross-section of busbars (top/bottom)	10 mm <sup>2</sup> / 10 mm <sup>2</sup>	
	18 – 8 AWG	
Torque	2.8 Nm	
	25 in.-lbs.	
Screwdriver	No. 2 Pozidrive	
Mounting	On DIN rail 35 mm acc. to EN 60715 by fast clip	
Mounting position	any	
Supply	optional	
<b>Dimensions and weight</b>		
Mounting dimensions acc. to DIN 43880	Mounting dimension 1	
Pole dimensions (H x D x W)	85 x 69 x 17.5	
Pole weight	approx. 125 g	
<b>Combination with auxiliary elements</b>		
Auxiliary contact	Yes	
Signal/auxiliary contact	Yes	
Shunt trip	Yes	
Undervoltage release	Yes	
Motor Operating Device	Yes	

### Tripping characteristics

Acc. to	Tripping characteristics	Rated current $I_n$	Thermal release <sup>1)</sup>			Electromagnetic release <sup>2)</sup>	
			Currents: conventional non-tripping current $I_1$	conventional tripping current $I_2$	Tripping time	Range of instantaneous tripping	Tripping time
IEC/EN 60898-1	B	6 to 63 A	$1.13 \cdot I_n$	$1.45 \cdot I_n$	> 1 h < 1 h	$3 \cdot I_n$ $5 \cdot I_n$	0.1 ... 45 s ( $I_n \leq 32$ A)/0.1 ... 90 s ( $I_n > 32$ A) < 0.1 s
	C	0.5 to 63 A	$1.13 \cdot I_n$	$1.45 \cdot I_n$	> 1 h < 1 h <sup>3)</sup>	$5 \cdot I_n$ $10 \cdot I_n$	0.1 ... 15 s ( $I_n \leq 32$ A)/0.1 ... 30 s ( $I_n > 32$ A) < 0.1 s
	D	0.5 to 63 A	$1.13 \cdot I_n$	$1.45 \cdot I_n$	> 1 h < 1 h <sup>3)</sup>	$10 \cdot I_n$ $20 \cdot I_n$	0.1 ... 4 s ( $I_n \leq 32$ A)/0.1 ... 8 s ( $I_n > 32$ A) < 0.1 s
IEC/EN 60947-2	K	0.5 to 63 A	$1.05 \cdot I_n$	$1.2 \cdot I_n$	> 1 h < 1 h	not applicable	
			$1.05 \cdot I_n$	$1.2 \cdot I_n$	> 2 h < 1 h <sup>3)</sup>	$10 \cdot I_n$ $14 \cdot I_n$	> 0.2 s < 0.2 s
	Z	0.5 to 63 A	$1.05 \cdot I_n$	$1.2 \cdot I_n$	> 1 h < 1 h	not applicable	
			$1.05 \cdot I_n$	$1.2 \cdot I_n$	> 2 h < 1 h <sup>3)</sup>	$2 \cdot I_n$ $3 \cdot I_n$	> 0.2 s < 0.2 s

<sup>1)</sup> The thermal releases are calibrated to a nominal reference ambient temperature; for B, C, D the reference value is 30 °C, for K and Z the reference value is 20 °C. In the case of higher ambient temperatures, the current values fall by approx. 6 % for each 10 K temperature rise.

<sup>2)</sup> The indicated tripping values of electromagnetic tripping devices apply to a frequency of 50/60 Hz. The thermal release operates independent of frequency.

<sup>3)</sup> As from operating temperature (after  $I_1 > 1$  h or, as applicable, 2h)

# Miniature Circuit Breaker S 200/S 200 M

## Tripping characteristics

**B characteristic**

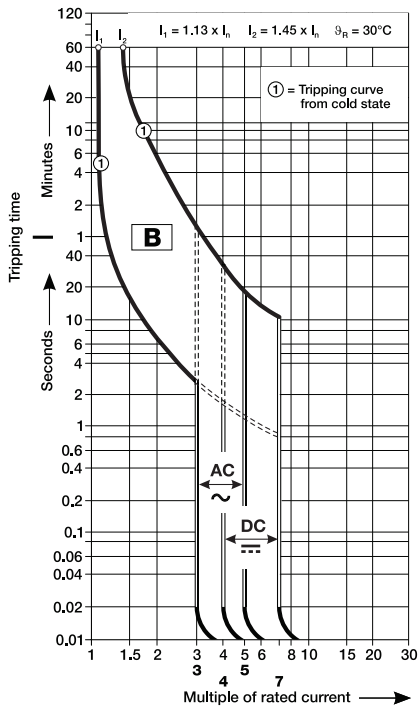

**C characteristic**

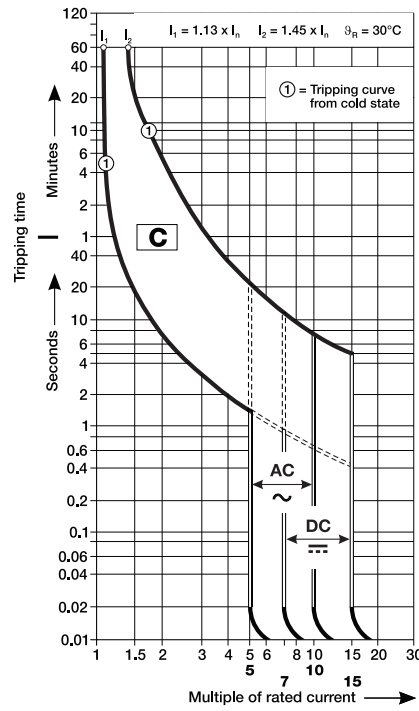

**D characteristic**

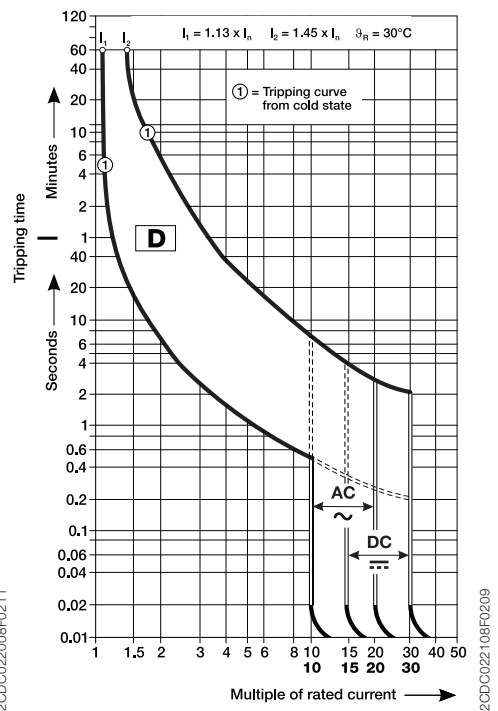

**K characteristic**

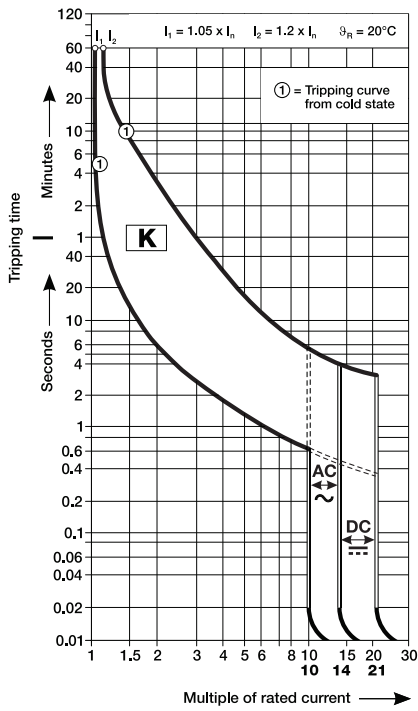

**Z characteristic**

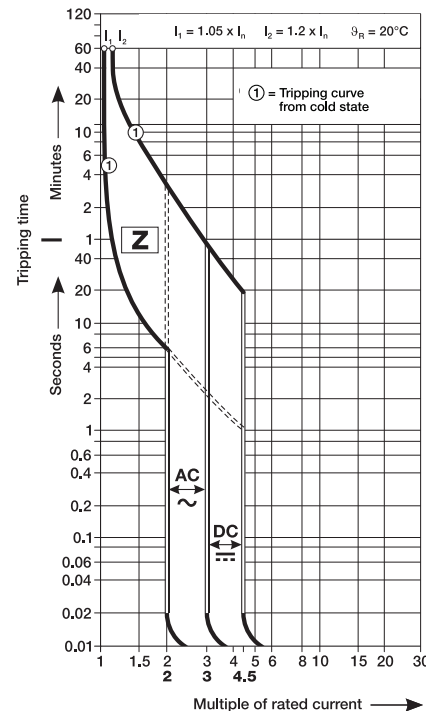

# Miniature Circuit Breaker S 200/S 200 M

## Derating

For installations of miniature circuit breakers at other temperatures than the reference value and installations of several miniature circuit breakers directly side by side, derating factors have to be considered.

### Deviating ambient temperature

The rated value of the current of a miniature circuit breaker refers to a reference ambient temperature of 30 °C for circuit breakers with the characteristics B, C and D and 20 °C for circuit breakers with the characteristics K and Z. The following table contains the derating of the load capability at ambient temperatures from -40 °C to 70 °C for the characteristics B, C, D, K and Z.

Tripping characteristics	Rated current $I_n$	Maximum operating current at ambient temperature T											
		- 40 °C	- 30 °C	- 20 °C	- 10 °C	0 °C	10 °C	20 °C	30 °C	40 °C	50 °C	60 °C	70 °C
B, C, D	0.5	0.67	0.65	0.62	0.60	0.58	0.55	0.53	0.50	0.47	0.44	0.41	0.37
	1.0	1.33	1.29	1.25	1.20	1.15	1.11	1.05	1.00	0.94	0.88	0.82	0.75
	1.6	2.13	2.07	2.00	1.92	1.85	1.77	1.69	1.60	1.51	1.41	1.31	1.19
	2.0	2.67	2.58	2.49	2.40	2.31	2.21	2.11	2.00	1.89	1.76	1.63	1.49
	3.0	4.0	3.9	3.7	3.6	3.5	3.3	3.2	3.0	2.8	2.6	2.4	2.2
	4.0	5.3	5.2	5.0	4.8	4.6	4.4	4.2	4.0	3.8	3.5	3.3	3.0
	6.0	8.0	7.7	7.5	7.2	6.9	6.6	6.3	6.0	5.7	5.3	4.9	4.5
	8.0	10.7	10.3	10.0	9.6	9.2	8.8	8.4	8.0	7.5	7.1	6.5	6.0
	10.0	13.3	12.9	12.5	12.0	11.5	11.1	10.5	10.0	9.4	8.8	8.2	7.5
	13.0	17.3	16.8	16.2	15.6	15.0	14.4	13.7	13.0	12.3	11.5	10.6	9.7
	16.0	21.3	20.7	20.0	19.2	18.5	17.7	16.9	16.0	15.1	14.1	13.1	11.9
	20.0	26.7	25.8	24.9	24.0	23.1	22.1	21.1	20.0	18.9	17.6	16.3	14.9
	25.0	33.3	32.3	31.2	30.0	28.9	27.6	26.4	25.0	23.6	22.0	20.4	18.6
	32.0	42.7	41.3	39.9	38.5	37.0	35.4	33.7	32.0	30.2	28.2	26.1	23.9
	40.0	53.3	51.6	49.9	48.1	46.2	44.2	42.2	40.0	37.7	35.3	32.7	29.8
	50.0	66.7	64.5	62.4	60.1	57.7	55.3	52.7	50.0	47.1	44.1	40.8	37.3
63.0	84.0	81.3	78.6	75.7	72.7	69.6	66.4	63.0	59.4	55.6	51.4	47.0	
K, Z	0.5	0.66	0.64	0.61	0.59	0.56	0.53	0.50	0.47	0.43	0.40	0.35	0.31
	1.0	1.32	1.27	1.22	1.17	1.12	1.06	1.00	0.94	0.87	0.79	0.71	0.61
	1.6	2.12	2.04	1.96	1.88	1.79	1.70	1.60	1.50	1.39	1.26	1.13	0.98
	2.0	2.65	2.55	2.45	2.35	2.24	2.12	2.00	1.87	1.73	1.58	1.41	1.22
	3.0	4.0	3.8	3.7	3.5	3.4	3.2	3.0	2.8	2.6	2.4	2.1	1.8
	4.0	5.3	5.1	4.9	4.7	4.5	4.2	4.0	3.7	3.5	3.2	2.8	2.4
	6.0	7.9	7.6	7.3	7.0	6.7	6.4	6.0	5.6	5.2	4.7	4.2	3.7
	8.0	10.8	10.2	9.8	9.4	8.9	8.5	8.0	7.5	6.9	6.3	5.7	4.9
	10.0	13.2	12.7	12.2	11.7	11.2	10.6	10.0	9.4	8.7	7.9	7.1	6.1
	13.0	17.2	16.6	15.9	15.2	14.5	13.8	13.0	12.2	11.3	10.3	9.2	8.0
	16.0	21.2	20.4	19.6	18.8	17.9	17.0	16.0	15.0	13.9	12.6	11.3	9.8
	20.0	26.5	25.5	24.5	23.5	22.4	21.2	20.0	18.7	17.3	15.8	14.1	12.2
	25.0	33.1	31.9	30.6	29.3	28.0	26.5	25.0	23.4	21.7	19.8	17.7	15.3
	32.0	42.3	40.8	39.2	37.5	35.8	33.9	32.0	29.9	27.7	25.3	22.6	19.6
	40.0	52.9	51.0	49.0	46.9	44.7	42.4	40.0	37.4	34.6	31.6	28.3	24.5
	50.0	66.1	63.7	61.2	58.6	55.9	53.0	50.0	46.8	43.3	39.5	35.4	30.6
63.0	83.3	80.3	77.2	73.9	70.4	66.8	63.0	58.9	54.6	49.8	44.5	38.6	

### Influence of adjacent devices

If several miniature circuit breakers are installed directly side by side with high load on all poles, a correction factor has to be applied to the rated current (see table). If distance pieces are used, the factor is not to be considered.

No. of adjacent devices	Factor F
1	1
2, 3	0.9
4, 5	0.8
≥ 6	0.75

### Example

S201-C16 at T = 40 °C

Conditions of use	Values to use	Calculation	Result
Load at ambient temperature 40 °C with 8 adjacent devices	$I_n$ (40 °C), Factor F	15.1 A x 0.75	$I_n = 11.33$ A

# Miniature Circuit Breaker S 200/S 200 M

## Accessories and dimensional drawing

### Accessory overview

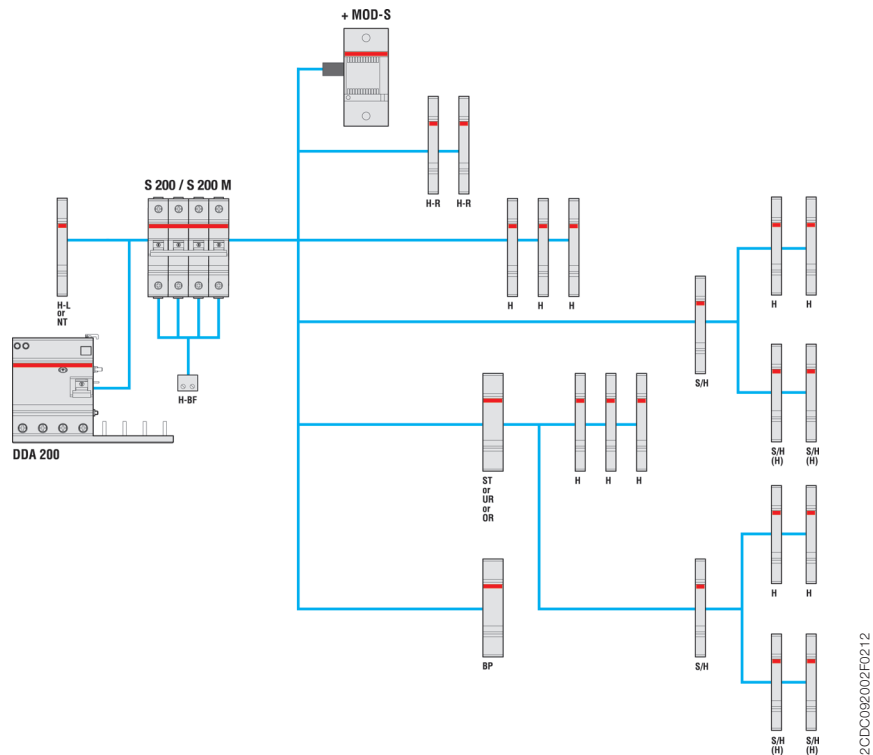

H	Auxiliary contact (change-over contact)	S2C-H6R	H-L	Auxiliary contact	S2C-H...L
H-R	Auxiliary contact	S2C-H6-...R	H-BF	Auxiliary contact for bottom fitting (1 per pole)	S2C-H01 S2C-H10
S/H	Signal/Auxiliary contact	S2C-S/H6R	BP	Mechanical tripping device	S2C-BP
S/H (H)	Signal/Auxiliary contact used as auxiliary contact	S2C-S/H6R	NT	Neutral disconnector	S2C-Nt
ST	Shunt trip	S2C-A...	MOD-S*	Motor operating device	S2C-CM
UR	Undervoltage release	S2C-UA	DDA 200	RCD-block	DDA 20...
OR	Oversvoltage release	S2C-OVP			

\* In case of using S 200/S 200 M coupled with DDA 200, MOD-S does not operate in case of earth-leakage fault.

### Dimensional drawing

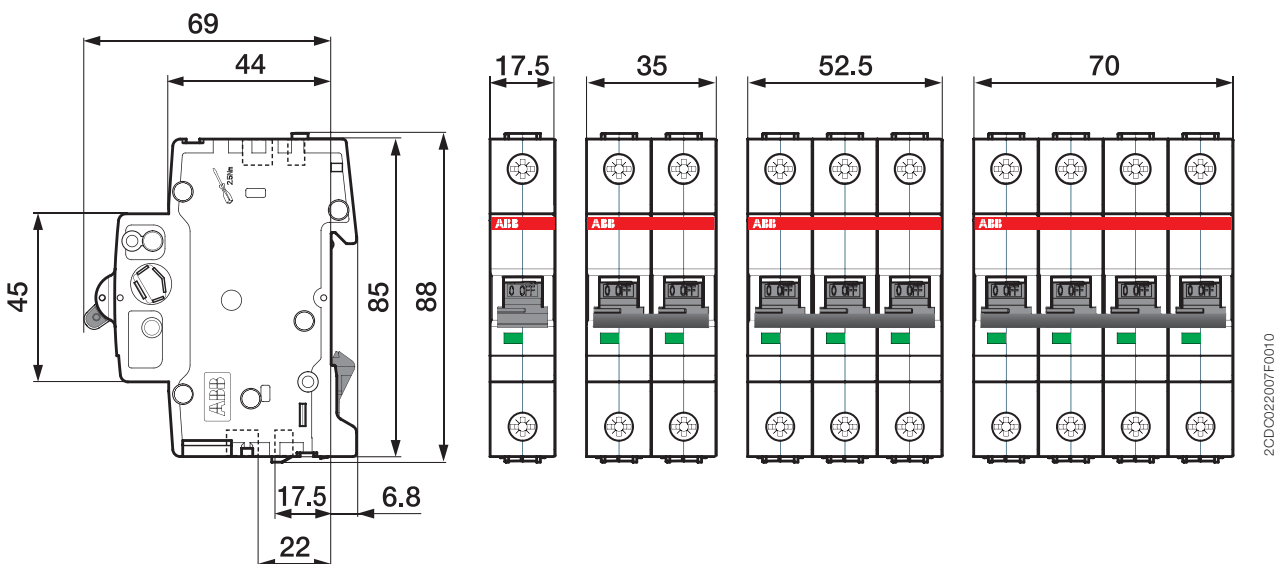

# Contact us

## **ABB STOTZ-KONTAKT GmbH**

Eppelheimer Straße 82  
69123 Heidelberg, Germany  
Phone: +49 (0) 6221 7 01-0  
Fax: +49 (0) 6221 7 01-13 25  
E-Mail: [info.desto@de.abb.com](mailto:info.desto@de.abb.com)

You can find the address of your  
local sales organization on the  
ABB home page  
<http://www.abb.com/contacts>  
-> Low Voltage Products and Systems

### **Note:**

We reserve the right to make technical changes or modify the contents of this document without prior notice. With regard to purchase orders, the agreed particulars shall prevail. ABB AG does not accept any responsibility whatsoever for potential errors or possible lack of information in this document.

We reserve all rights in this document and in the subject matter and illustrations contained therein. Any reproduction, disclosure to third parties or utilization of its contents – in whole or in parts – is forbidden without prior written consent of ABB AG.

Copyright© 2012 ABB  
All rights reserved

Brochure number 2CDC002157D0201.pdf (04/12-.pdf)

## X-ON Electronics

Largest Supplier of Electrical and Electronic Components

*Click to view similar products for [Circuit Breakers](#) category:*

*Click to view products by [ABB](#) manufacturer:*

Other Similar products are found below :

[LUGZX66-1-61-20.0-44](#) [M39019/01-201](#) [M39019/01-221](#) [M39019/01-323](#) [M39019/01-336](#) [M39019/02-248](#) [M39019/02-311](#) [M39019/02-316](#) [M39019/04-249S](#) [M39019/05-246S](#) [M39019/06-254S](#) [M55629/1-016](#) [M55629/1-018](#) [M55629/1-021](#) [M55629/1-033](#) [M55629/1-036](#) [M55629/1-046](#) [M55629/1-048](#) [M55629/1-058](#) [M55629/1-067](#) [M55629/1-070](#) [M55629/1-079](#) [M55629/1-084](#) [M55629/1-085](#) [M55629/1-101](#) [M55629/1-109](#) [M55629/11-102](#) [M55629/1-120](#) [M55629/12-045](#) [M55629/12-046](#) [M55629/1-330](#) [M55629/1-366](#) [M55629/1-387](#) [M55629/1-401](#) [M55629/2-022](#) [M55629/2-030](#) [M55629/2-072](#) [M55629/2-082](#) [M55629/2-099](#) [M55629/2-101](#) [M55629/2-102](#) [M55629/21-BM-BM](#) [M55629/21-HM-HM](#) [M55629/21-NS-NS](#) [M55629/22-NR-NR-NR](#) [M55629/22-RS-RS-RS](#) [M55629/2-347](#) [M55629/2-401](#) [M55629/2-413](#) [M55629/3-030](#)