

Contents

Page

Technical data

General	4
Technical data	8
Tripping characteristics	14
Short-Circuit rupturing capacity	15
Back-up protection	17
Tripping diagrams	18
Internal resistances	22
Max. permissible impedances of fault loops	23
Short-circuit selectivity	24
Temperature influence	27
Application examples	28
Protection of lamps	28
Tripping diagrams, characteristics UC Range	29
Supplementary devices	31
Mounting of supplementary devices	33
Mounting and operating instructions	35
Dimensions	37
Busbars and busbar blocks	39
Approvals and certifications	41

Order specification

S 230-B /-C	42
S 260-B	43
S 260-C	45
S 260-D	47
S 270-K	49
S 270-Z	51
S 270-B	53
S 270-C	55
S 280-B	57
S 280-C	59
S 280-D	61
S 280-K	63
S 280-Z	65
S 280 UC-B /-K	67
S 280 UC-Z	69
Supplementary devices	70
S 290-C /-D	71
S 290-K and Supplementary devices	72
Accessories	73
Busbars and busbar blocks	77

Prior to connection of aluminium conductors ensure that their contact points are cleaned, brushed and coated with grease. The contact terminals must be tighten up after six to eight weeks.

Conditions of Delivery and Sale

For business conducted in domestic and foreign markets the following conditions in their latest versions are valid:

General conditions of Supply and Delivery for products and services of the electrical industry: Form 2292 German, 2293 German-English, 2294 German-French. General conditions of Sale for the products and services of the electrical industry: Form 2327 German, 2381 English, 2326 French.

Relevant to specific orders special conditions can be agreed upon.

Guarantee

The guarantee period is 6 months, in favour of the endbuyer, and commences when the is in possession of the products. In this connection, our valid guarantee conditions are included in the packing of our cordless tools.

Technical Reservations

The data and figures of this publication are subject to change as required by technical progress.

These are the outstanding features for the S2 Generation.

- All round protection against contact with live parts in accordance with DIN VDE 106 part 100.
- Delivered with open box terminals with captive screws and lower dualfunction terminal ready for busbar connection.
- Dualfunction terminals enables simultaneous connection of busbar and cable without additional connection pieces.
- Connection capacity for flexible multi- or single core conductors of 0,75 up to 25 mm² up to 40 A and 0,75 up to 35 mm² for 50 and 63 A. S 280 in general 0,75 up to 35 mm².
- Cross wiring possible with solid round conductor up to 10 mm².
- Positioning of the M.C.B. on the DIN-rail now possible before snapping on, as the mounting clip is on the lower side.
- Accessories can be fitted to the S2... range, on site by the user.
- High short-circuit switching capacity.
- Low let-through energy at the point of fault.
- Rated voltage single pole: 230/400 V AC
multi pole: 400 V AC

The new terminal design has the following additional advantages:

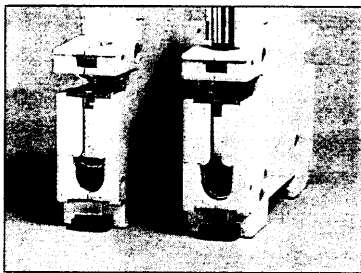

The new dualfunction terminal is delivered in open position for connection of busbars. When screw head is pressed the box terminal below opens fully.

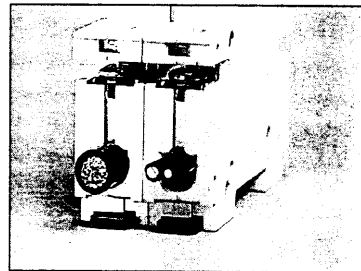

The terminals allow connection of conductors with 0.75 up to 25 mm² / 35 mm² cross-section. Furthermore conductors of different cross-sections can be connected.

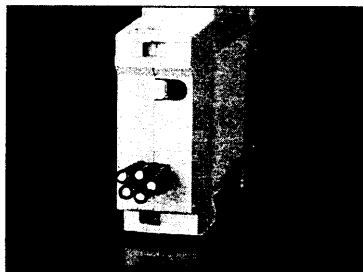

Up to 5 conductors with cross section 1.5 mm² each can be connected safely and reliably.

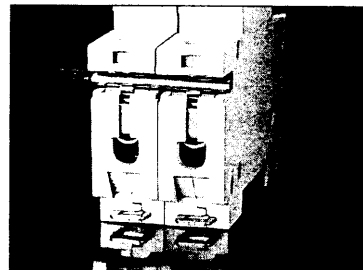

The lower terminal also allows cross-wiring by solid round conductor.

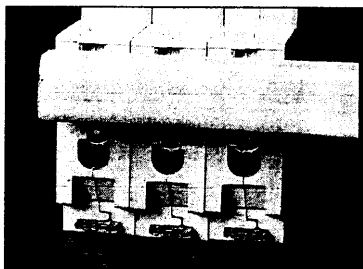

At the lower terminals cross-wiring can be made with comb-busbars up to a thickness of 4 mm or with 3-phase busbar blocks as shown above.



In addition, the incoming cable can be connected without accessories. Extra connection pieces are no longer necessary.

System pro M

STOTZ M.C.B.'s of the System proM are equipped with the for well proven STOTZ hammer head system and thus offer current limiting to the highest degree.

Oscillogram of a rupturing process

They offer

- high short-circuit switching capacity
- high selectivity to back up fuses
- in case of short-circuit, low stress on the cable in the point of fault due to the high limitation of the let-through $\int i^2 dt$ (current heating value).

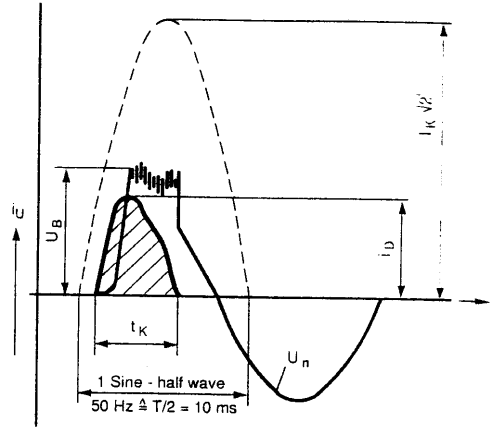

SK 0102 Z 94

- $i_k \cdot \sqrt{2}$ = peak value of the prospective short-circuit current
- i_b = max. let-through current of the M.C.B.
- U_n = mains voltage
- U_B = arc voltage of the M.C.B.
- t_k = breaking time of the M.C.B.

Additional devices for example (more supplementary devices on page 31)

S 260, S 270, S 280

S 260, S 270, S 280

Disconnecting neutral conductor NA

Unprotected pole (no trip mechanism) is force switched together with the M.C.B.

It can also be used as a normally open contact for signalling the contact position of the M.C.B.

Auxiliary contacts H ...

Contact position dependent on that of the M.C.B.
The contacts are potential-free.

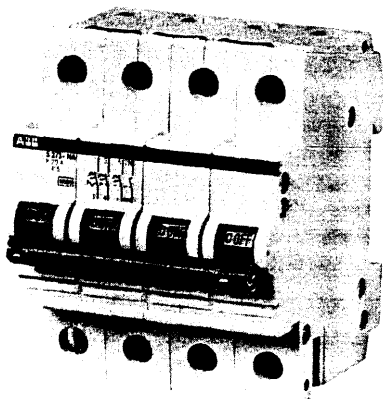

SK 0294 B 91



SK 0328 B 91

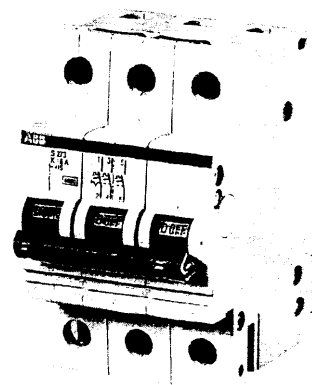

SK 0067 B 92

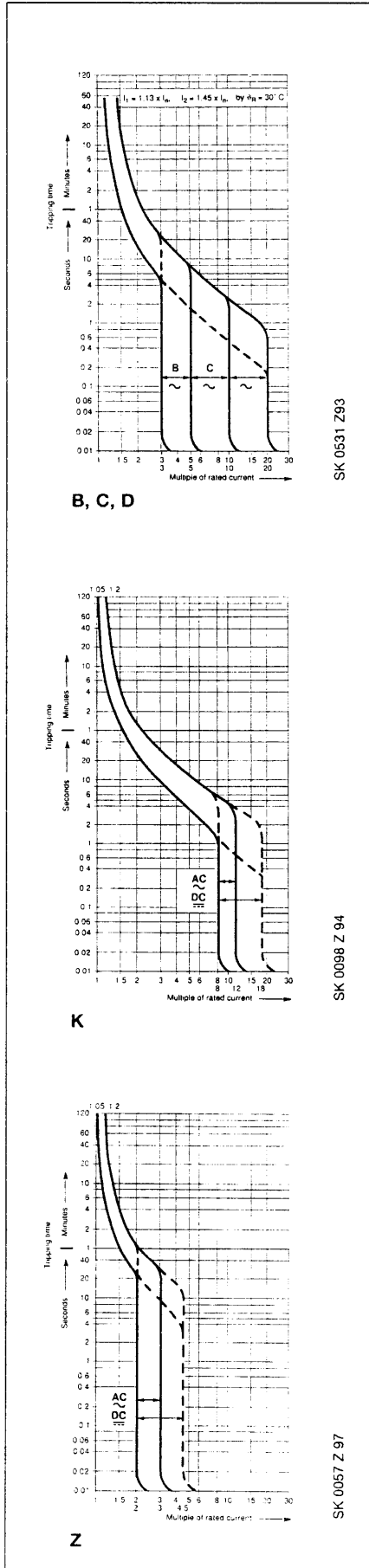

General

Brief description

Current limiting M.C.B.'s with undelayed magnetic and delayed thermal trips, with fixed setting. Metal framed trip-free switching mechanism.

Task

Protection against overheating of electrical wires, cables and appliances in the case of overcurrent due to overload, short-circuit or earth fault in compliance with DIN VDE 0100 part 430.

Protection against dangerous body currents in the case of too high touch voltage due to insulation faults in compliance with DIN VDE 0100 part 410.

Application

For installation, switching, regulation and metering systems of building installations in commercial and industrial projects.

Accessories

The S2 ... range can be fitted subsequently with an auxiliary contact. The auxiliary contacts are suitable for switching auxiliary circuits as a function of the M.C.B.'s contact position; with 2 or 3 galvanically separated contacts. The auxiliary contacts are trip-free due to their coupling with the switching mechanism.

Tripping characteristics and rated currents

B-, C- and D-Characteristic

The new characteristics acc. EN 60 898 are for line protection. They all have the same thermal settings and differ only in their magnetic tripping values.

The higher magnetic settings of the C- or D-characteristics are for applications with start or high inrush-currents.

K-Characteristic

For cable and appliance protection.

Rated currents 0.5 to 63 A in 17 steps (S 270) or 0.2 to 63 A in 20 steps (S 280). Motor protection can be achieved by the selection of the M.C.B. with the correct rated current corresponding to the motor data. The electro-magnetic trip is set in such a way that the motor starting current does not lead to tripping.

Due to the higher magnetic non tripping current, in circuits with incandescent lamp groups, mains parallel operated fluorescent lamps or other discharge lamps, the conductor cross-section to be protected can be more economically utilized as compared to a M.C.B. of the same rated current in tripping characteristic B.

Z-Characteristic

For protection of semiconductor devices and voltage transformer circuits.

Miniature Circuit Breakers

System pro M

Technical data S 230

Specifications:	EN 60 898, DIN VDE 0641 part 11, IEC 898
No. of poles:	1, 2, 3
Tripping characteristics:	acc. to EN 60 898
Rated current I_n :	6 ... 40 A
Rated voltage U_n :	single pole: 230 / 400 V ~ multipole 400 V ~
Max. operating voltage U_{Bmax} :	$U_n + 10 \%$
Min. operating voltage U_{Bmin} :	12 V ~
Rated rupturing capacity acc. to IEC 898, EN 60 898:	see page 15
Selectivity class:	-
Short-circuit rupturing capacity:	see page 15
Frequency:	50 ... 60 Hz, other frequencies see page 14
Insulation acc. DIN VDE 0110 part 1 and 2	
- Overvoltage category:	IV
- Pollution degree:	2
- Surge voltage:	5 kV (1.2/50 μ s)
- Surge voltage:	3 kV (50/60 Hz)
Housing:	Moulded plastic group I (CTI \geq 600) to DIN IEC 112/VDE 303 part 1 RAL 7035
Switching lever:	Moulded plastic group II (400 \leq CTI < 600) black, sealable
Degree of protection acc. to DIN VDE 40 050, IEC 529:	IP 20, when built in into distribution board: IP 40
Depth of unit:	68 mm
Dimensions:	acc. to DIN 43 880, size 1, see page 37
Mounting position:	optional
Mounting:	snap-on fixing on standard profile rails EN 50 022, 35 x 7.5 or screw fixing by means of mounting plate (see accessories)
Connection:	Combi box terminals on top and bottom, safe against unintentional touch acc. to DIN VDE 0106 part 100. Suitable for solid or flexible conductors from 0.75 to 25 mm ² (till 40 A) and up to 35 mm ² (for 50 A, 63 A) when no busbar is connected, and up to 16 mm ² or 25 mm ² (for 50 A, 63 A) when a max. 3 mm busbar is connected
Tightening torque:	2 Nm
Mech. service life:	20 000 operations
Service life at rated load:	$I_n < 32$ A: 20 000 operations $I_n \geq 32$ A: 10 000 operations
Climate resistance acc. to DIN VDE 40 046 and IEC 68-2:	constant climatic conditions 23/83, 40/93, 55/20 [°C/RH] variable climatic conditions 25/95 - 40/93 [°C/RH]
Storage temperature:	$T_{max} + 70$ °C, $T_{min} - 40$ °C
Ambient temperature:	$T_{max} + 55$ °C, $T_{min} - 25$ °C
Shock resistance acc to DIN IEC 68-2-27 and DIN EN 60 068-2-27:	30 g minimum of 2 impacts duration of shock 13 ms
Vibration resistance acc. to DIN IEC 68-2-6:	5 g, 20 cycles 5 ... 150 ... 5 Hz at $0.8 \cdot I_n$
Weight:	see selection tables

Miniature Circuit Breakers

System pro M

Technical data S 260, S 270

Specifications:	DIN VDE 0641 part 11, IEC 898, EN 60 898, IEC 947-2
No. of poles:	1, 2, 3, 4, 1+NA, 3+NA
Tripping characteristics:	B, C, K, Z
Rated current I_n :	0,5 ... 63 A
Rated voltage U_n :	single pole: 230 / 400 V ~ multipole 400 V ~
Max. operating voltage U_{Bmax} :	AC: $U_n + 10 \%$, acc. to UL 1077 and CSA 22.2: 480 V ~ DC: 1-pole 60 V \dots , 2-pole 125 V \dots
Min. operating voltage U_{Bmin} :	12 V ~, 12 V \dots
Rated rupturing capacity acc. to IEC 898, EN 60 898:	see page 15
Selectivity class:	S 3
Short-circuit rupturing capacity:	see page 15
Frequency:	50 ... 60 Hz, other frequencies see page 14
Insulation acc. DIN VDE 0110 part 1 and 2	
- Overvoltage category:	III
- Pollution degree:	2
- Surge voltage:	5 kV (1.2/50 μ s)
- Surge voltage:	3 kV (50/60 Hz)
Housing:	Moulded plastic group I (CTI \geq 600) to DIN IEC 112/VDE 303 part 1 RAL 7035
Switching lever:	Moulded plastic group II (400 \leq CTI < 600) black, sealable
Degree of protection acc. to DIN VDE 0100:	IP 20, when built in into distribution board: IP 40
Depth of unit:	68 mm
Dimensions:	acc. to DIN 43 880, size 1, see page 37
Mounting position:	optional
Mounting:	snap-on fixing on standard profile rails EN 50 022, 35 x 7.5 or screw fixing by means of mounting plate (see accessories)
Connection:	Box terminals on top and combi box terminals on bottom, safe against unintentional touch acc. to DIN VDE 0106 part 100. Suitable for solid or flexible conductors from 0,75 mm ² to 25 mm ² (max.16 mm ² when a max. 3 mm busbar is connected; from 0,75 mm ² with casing and from 1,5 mm ² without)
Tightening torque:	2 Nm
Mech. service life:	20 000 operations
Service life at rated load:	$I_n < 32$ A: 20 000 operations $I_n \geq 32$ A: 10 000 operations
Climate resistance acc. to DIN VDE 50 015 and DIN 68 part 2-30:	constant climatic conditions 23/83, 40/93, 55/20 [°C/RH] variable climatic conditions 25/95 – 40/93 [°C/RH]
Storage temperature:	$T_{max} + 70$ °C, $T_{min} - 40$ °C
Ambient temperature:	$T_{max} + 55$ °C, $T_{min} - 25$ °C
Shock resistance acc to DIN IEC 68-2-27 and DIN EN 60 068-2-27:	30 g minimum of 2 impacts duration of shock 13 ms
Vibration resistance acc. to DIN IEC 68-2-6 and DIN EN 60 068-2-6:	5 g, 20 cycles 5 ... 150 ... 5 Hz at $0.8 \cdot I_n$
Weight:	see selection tables

Miniature Circuit Breakers

System pro M

Technical data S 280

Specifications:	DIN VDE 0641, DIN VDE 0660 Teil 1, BS 3871, IEC 898, EN 60 898, IEC 947-2
No. of poles:	1, 2, 3, 4, 1+NA, 3+NA
Tripping characteristics:	B, C, K, Z, UC-B, UC-K, UC-Z
Rated current I_n :	0,2 ... 63 A
Rated voltage U_n :	single pole: 230 / 400 V ~ multipole 400 V ~
Max. operating voltage U_{Bmax} :	AC: $U_n + 10 \%$, acc. to UL 1077 and CSA 22.2: 480 V ~ DC: 1-pole 60 V \dots S 280 UC: 220 V \dots 2-pole 125 V \dots S 280 UC: 440 V \dots
Min. operating voltage U_{Bmin} :	12 V ~, 12 V \dots
Rated rupturing capacity acc. to IEC 898, EN 60 898:	see page 16
Selectivity class:	S 3
Short-circuit rupturing capacity:	see page 16
Frequency:	16 $\frac{2}{3}$... 60 Hz, other frequencies see page 14
Insulation acc. DIN VDE 0110 part 1 and 2	
- Overvoltage category:	III
- Pollution degree:	2
- Surge voltage:	5 kV (1.2/50 μ s)
- Surge voltage:	3 kV (50/60 Hz)
Housing:	Moulded plastic group I (CTI \geq 600) to DIN IEC 112/VDE 303 part 1 RAL 7035
Switching lever:	Moulded plastic group II (400 \leq CTI < 600) black, sealable
Degree of protection acc. to DIN VDE 0100:	IP 20, when built in into distribution board: IP 40
Depth of unit:	68 mm
Dimensions:	acc. to DIN 43 880, size 1, see page 37
Mounting position:	optional
Mounting:	snap-on fixing on standard profile rails EN 50 022, 35 x 7.5 or screw fixing by means of mounting plate (see accessories)
Connection:	Combi box terminals on top and bottom, safe against unintentional touch acc. to DIN VDE 0106 part 100. Suitable for solid or flexible conductors from 0,75 mm ² to 35 mm ² (max. 25 mm ² when a max. 3 mm busbar is connected; from 0,75 mm ² with casing and from 1,5 mm ² without)
Tightening torque:	2 Nm
Mech. service life:	20 000 operations
Service life at rated load:	$I_n < 32$ A: 20 000 operations $I_n \geq 32$ A: 10 000 operations
Climate resistance acc. to DIN VDE 50 015 and DIN 68 part 2-30:	constant climatic conditions 23/83, 40/93, 55/20 [$^{\circ}$ C/RH] variable climatic conditions 25/95 - 40/93 [$^{\circ}$ C/RH]
Storage temperature:	$T_{max} + 70$ $^{\circ}$ C, $T_{min} - 40$ $^{\circ}$ C
Ambient temperature:	$T_{max} + 55$ $^{\circ}$ C, $T_{min} - 25$ $^{\circ}$ C
Shock resistance acc to DIN IEC 68-2-27 and DIN EN 60 068-2-27:	30 g minimum of 2 impacts duration of shock 13 ms
Vibration resistance acc. to DIN IEC 68-2-6 and DIN EN 60 068-2-6:	5 g, 20 cycles 5 ... 150 ... 5 Hz at 0.8 $\cdot I_n$
Contact position indicator:	OFF = green, ON = red
Weight:	see selection tables

Miniature Circuit Breakers

System pro M

Technical data S 290

Specifications:	DIN VDE 0641 Teil 11, EN 60 898, IEC 898
No. of poles:	1, 2, 3 and 4- pole
Tripping characteristics:	C, D, K
Rated current I_n :	80, 100 and 125 A
Rated voltage U_n :	single pole: 230 / 400 V ~ multipole 400 V ~
Max. operating voltage U_{Bmax} :	AC: $U_n + 10 \%$, DC: 1-pole 60 V \dots 2-pole 110 V \dots
Min. operating voltage U_{Bmin} :	12 V ~, 12 V \dots
Rated rupturing capacity:	10 kA acc. to DIN VDE 0641
Selectivity class:	S 3
Frequency:	50 ... 60 Hz
Insulation acc. DIN VDE 0110 part 1 and 2	
- Overvoltage category:	III
- Pollution degree:	2
- Surge voltage:	5 kV (1.2/50 μ s)
- Surge voltage:	3 kV (50/60 Hz)
Housing:	Moulded plastic group I (CTI \geq 600) to DIN IEC 112/VDE 303 part 1 RAL 7035
Switching lever:	Moulded plastic group II (400 \leq CTI < 600) black, sealable
Degree of protection acc. to DIN VDE 0100:	IP 20, when built in into distribution board: IP 40
Depth of unit:	70 mm
Dimensions:	acc. to DIN 43 880, size 1, see page 37
Mounting position:	optional
Mounting:	snap-on fixing on standard profile rails EN 50 022, 35 x 7.5 or screw fixing by means of mounting plate (see accessories)
Connection:	flexible conductors from 1,5 mm ² up to 50 mm ²
Tightening torque:	4,5 Nm
Connection terminals:	Safe against unintentional touch acc. to DIN VDE 0106 part 10
Service life:	10 000 operations (mechanical and electrical)
Climate resistance:	acc. to CEE 27
Storage temperature:	$T_{max} + 70 \text{ }^\circ\text{C}$, $T_{min} - 25 \text{ }^\circ\text{C}$
Ambient temperature:	$T_{max} + 45 \text{ }^\circ\text{C}$, $T_{min} - 5 \text{ }^\circ\text{C}$ (at day average temperature $\leq +35 \text{ }^\circ\text{C}$)
Shock resistance acc to DIN IEC 68-2-27 and DIN EN 60 068-2-27:	30 g minimum of 2 impacts duration of shock 13 ms
Vibration resistance acc. to DIN IEC 68-2-6 and DIN EN 60 068-2-6:	60 m/s ² at 10 ... 150 ... 5 Hz
Contact position indicator:	OFF = green, ON = red
Disconnection:	acc. to VDE 0660 part 107
Weight:	see selection tables

Auxiliary contact and Signal contact / Auxiliary contact (acc. DIN VDE 0660 part 200)

$I_{th} = 10 A$

Auxiliary contact S2 – H..

2 contacts

AC 14	U_e	400 V	230 V
	I_e	2 A	6 A
DC 12	U_e	220 V	110 V
	I_e	1 A	1.5 A
DC 13	U_e	60 V	24 V
	I_e	2 A	4 A

Min. operating voltage:

Min. operating power:

Short circuit withstand cap.:

Insulation acc. DIN VDE 0110 part 1 and 2

- Overvoltage class:

- Pollution degree:

Connection capacity:

S2 – H..

3 contacts

AC 14	U_e	400 V	230 V
	I_e	1 A	2 A
DC 12	U_e	220 V	110 V
	I_e	1 A	1.5 A
DC 13	U_e	60 V	24 V
	I_e	2 A	4 A

24 V ~, 24 V ∴

5 VA

230 V ~ 1000 A with S270 K6

III

2

up to 2 x 1.5 mm²

Signal contact / Auxiliary contact S2 – S/H

AC 14	U_e	400 V	230 V
	I_e	2 A	6 A
DC 12	U_e	220 V	110 V
	I_e	0.5 A	1 A
DC 13	U_e	60 V	24 V
	I_e	1 A	4 A

Min. operating voltage: 24 V ~, 24 V ∴

Min. operating power: 0,1 VA

Auxiliary contact S2 – H ... KL (Low power)

$I_{th} = 0.5 A$

AC 12	U_e	24 V	12 V
	I_e	20 mA	10 mA
DC 12	U_e	24 V	12 V
	I_e	20 mA	10 mA

Min. operating voltage: 12 V ~, 12 V ∴

Operating power: min 0,1 VA, max 5 VA

Insulation acc. DIN VDE 0110 part 1 und 2

- Overvoltage category: III

- Pollution degree: 2

Connection capacity: up to 2 x 1.5 mm²

Technical data Auxiliary contact S 290-H and signal contact S 290-S

acc. to DIN VDE 0660 part 200/7. 92; EN 60 947-5 -1

$I_{th} = 16 A$

$U_i = 440 V$

Min. operating voltage: 17 V DC

Min. operating current: 5 mA

Short-circuit withstand capacity: 1000 A with Diazed gL 6 A
acc. to VDE 0660 part 200 8.3.4

Insulation acc. to DIN VDE part 1 and 2

- Overvoltage category: III

- Pollution degree: 2

- Surge voltage: 4 kV (1,2/50µs)

- Surge voltage: 2,8 kV (50/60 Hz)

Connection capacity: 0,5 up to 2,5 mm²

AC 15	U_e	415 V	240 V		
	I_e	2 A	6 A		
DC 13	U_e	220 V	110 V	60 V	24 V
	I_e	1 A	1 A	3 A	6 A

Undervoltage release S 2 – UA ...

Type:	S2 – UA 12	S2 – UA 24	S2 – UA 48	S2 – UA 110	S2 – UA 220	S2 – UA 380
Specifications:	IEC 947-1, CEI 17-5, DIN VDE 0660 part 1					
Rated voltage AC:	–	24 V	48 V	110 V	220 – 240 V	380 V
DC:	12 V	24 V	48 V	110 V	220 V	–
Current rating:	10 mA					
Degree of protection acc. to DIN VDE 0100:	IP 20					
Frequency:	50 ... 60 Hz					
Drop away voltage:	$0.35 \times U_n \leq V \leq 0.7 \times U_n$					
Climate resistance:	constant climate conditions 23/83, 40/93, 55/20 [°C/RH]; variable climatic conditions 25/95 – 40/93 [°C/RH]					
Connection capacity:	2 x 1.5 mm ²					
Max. tightening torque:	0.4 Nm					

Shunt trip S2 – A

Type:	S2 – A 1	S2 – A 2
Operating voltages:	12 ... 60 V 24 VA / W ... 600 VA / W	110 ... 415 V AC and 110 ... 250 V DC 40 VA ... 570 VA and 40 W ... 207 W

Removable base S2 – EST for S 280, I_n ≤ 32 A

Depth of unit:	78 mm incl. MCB
Width:	17.5 mm (1 modul)
Length:	150 mm
Degree of protection acc. to DIN VDE 0100:	IP 20
Mounting:	snap-on fixing on standard profile EN 50 022 possibility to take several bases for multipole MCB's
Mounting position:	optional
Mech. service life:	200 plug-ins
Enclosure:	grey, RAL 7035 (self extinguish VO acc. to UL 94)
Connection capacity:	1 ... 10 mm ²

Undervoltage release S 290 – UA ...

Type:	S290 – UA 24	S290 – UA 110	S290 – UA 230
Rated voltage AC:	24 V	110 V	230 V
DC:	24 V	110 V	–

Shunt trip S290 – A

Type:	S290 – A 1	S290 – A 2
Operating voltages:	AC 110 - 415 V	DC 24 - 48 V

Auxiliary contact

DIN VDE 0660 T 200
EN 60 947-5-1
IEC 947-5-1
U_i = 440 V; I_{th} = 16 A

AC 15	U _e	240 V
	I _e	6 A
DC 13	U _e	220 V
	I _e	1 A

Signal contact

DIN VDE 0660 T 200
EN 60 947-5-1
IEC 947-5-1
U_i = 440 V; I_{th} = 16 A

AC 15	U _e	240 V
	I _e	6 A
DC 13	U _e	220 V
	I _e	1 A

Miniature Circuit Breakers

System pro M

Tripping characteristics

acc. to	Tripping characteristic	Thermal trips ①			Electromagnetic trips ②		
		Test currents: Low test current I_1	High test current I_2	Tripping-time 	Test currents: hold current surges of	trip at least at	Tripping-time
EN 60 898	B	$1.13 \cdot I_n$	$1.45 \cdot I_n$	$> 1 \text{ h}$ $< 1 \text{ h}$ ③	$3 \cdot I_n$	$5 \cdot I_n$	$> 0.1 \text{ s}$ $< 0.1 \text{ s}$
IEC 898	C	$1.13 \cdot I_n$	$1.45 \cdot I_n$	$> 1 \text{ h}$ $< 1 \text{ h}$ ③	$5 \cdot I_n$	$10 \cdot I_n$	$> 0.1 \text{ s}$ $< 0.1 \text{ s}$
DIN VDE 0641 part 11	D	$1.13 \cdot I_n$	$1.45 \cdot I_n$	$> 1 \text{ h}$ $< 1 \text{ h}$ ③	$10 \cdot I_n$	$14 \cdot I_n$	$> 0.1 \text{ s}$ $< 0.1 \text{ s}$
DIN VDE 0660 part 101	K	$1.05 \cdot I_n$	$1.2 \cdot I_n$	$> 1 \text{ h}$ $< 1 \text{ h}$ ③	$8 \cdot I_n$	$12 \cdot I_n$	$> 0.2 \text{ s}$ $< 0.2 \text{ s}$
EN 60 947 IEC 947-2	Z	$1.05 \cdot I_n$	$1.2 \cdot I_n$	$> 1 \text{ h}$ $< 1 \text{ h}$ ③	$2 \cdot I_n$	$3 \cdot I_n$	$> 0.2 \text{ s}$ $< 0.2 \text{ s}$

① Influence of ambient temperature see below. ② The tripping values for the electromagnetic trip are valid for AC 50 ... 60 Hz. For other frequencies see table below. ③ From warm operating condition (After $I_1 > 1 \text{ h}$ resp. 2h)

S 280 UC

acc. to	Tripping characteristic	Thermal trips ①			Electromagnetic trips ②				
		Test currents: Low test current I_1	High test current I_2	Tripping-time	Test currents: hold current surges of	trip at least at ~	...	Tripping-time at ~	at ...
DIN VDE 0641 part 12	B 6 up to 63 A	$1.13 \cdot I_n$	$1.45 \cdot I_n$	$> 1 \text{ h}$ $< 1 \text{ h}$ ③	$3 \cdot I_n$	$5 \cdot I_n$	$8 \cdot I_n$	$> 0.1 \text{ s}$ $< 0.1 \text{ s}$	$> 0.1 \text{ s}$ $< 0.1 \text{ s}$
acc. to IEC 947-2	K 0.2 up to 63 A	$1.05 \cdot I_n$	$1.2 \cdot I_n$	$> 1 \text{ h}$ $< 1 \text{ h}$ ③	$10 \cdot I_n$	$14 \cdot I_n$	$21 \cdot I_n$	$> 0.1 \text{ s}$ $< 0.1 \text{ s}$	$> 0.2 \text{ s}$ $< 0.2 \text{ s}$
acc. to IEC 947-2	Z 0.5 up to 63 A	$1.05 \cdot I_n$	$1.2 \cdot I_n$	$> 1 \text{ h}$ $< 1 \text{ h}$ ③	$2 \cdot I_n$	$3 \cdot I_n$	$5 \cdot I_n$	$> 0.1 \text{ s}$ $< 0.1 \text{ s}$	$> 0.2 \text{ s}$ $< 0.2 \text{ s}$

① Influence of ambient temperature see below. ② The tripping values for the electromagnetic trip are valid for AC 50 ... 60 Hz. For other frequencies see table below. ③ From warm operating condition (After $I_1 > 1 \text{ h}$)

Influence of frequency on electromagnetic trips

The stated tripping values of the electromagnetic trips are valid for a frequency of 50 ... 60 Hz. In case of frequencies deviating from 50 ... 60 Hz as well as a direct current the tripping values are changed by the factor mentioned below.

Factor approx.	AC			DC
	100 Hz	200 Hz	400 Hz	
	1.1	1.2	1.5	1.5

The tripping values of the thermal trips are independent of the frequency.

Influence of ambient temperature

The thermal trips are calibrated for an ambient temperature of 20°C for K and Z; 30°C for B, C, D-characteristic

In the case of temperatures deviating from these values the tripping values

- are reduced in case of higher temperatures
 - are increased in case of lower temperatures
- (see page 27).

The electromagnetic tripping is not dependent on temperature.

Miniature Circuit Breakers

System pro M

Short circuit rupturing capacity

Switching sequence acc. to DIN VDE 0641 part 11, EN 60 898, IEC 898
 Ratings with AC in kA / cos φ, with DC in kA / T ms

Range Tripping characteristic Rated current	AC 1-phase 133 V ~ kA/cos φ	230 V ~ kA/cos φ	2/3-phase 230 V ~ 133/230 V ~ kA/cos φ	400 V ~ 230/400 V ~ kA/cos φ	DC ① single pole up to 60 V ... kA/T ≤ ms	Max. Back-up protection		Max. Short-circuit rupturing capacity of the range
						fuse	Main circuit breaker ②	
S 230 - B 6 10 ... 20 25 ... 32 40	3/0.9	3/0.9	3/0.9	3/0.9	-	63 A 80 A 100 A 125 A	100 A 100 A 100 A 100 A	3000
S 230 - C 6 10 16...20 25...32 40	3/0.9	3/0.9	3/0.9	3/0.9	-	40 A 63 A 80 A 100 A 125 A	100 A 100 A 100 A 100 A 100 A	3000
S 260 - B 6 10 ... 20 25 ... 32 40 50 ... 63	10/0.5	6/0.7	10/0.5	6/0.7	10/4	63 A 80 A 100 A 125 A 160 A	100 A 100 A 100 A 100 A 100 A	6000 3
S 260 - C, D 0.5 ... 2	unlimited					not necessary		unlimited
3 ... 4 6 8 ... 13 16 ... 20 25 ... 32 40 50 ... 63	10/0.5	6/0.7	10/0.5	6/0.7	10/4	20 A 40 A 63 A 80 A 100 A 125 A 160 A	- - 100 A 100 A 100 A 100 A 100 A	6000 3
S 270 - B 6 10 ... 20 25 ... 32 40 50 ... 63	10/0.5	10/0.5	10/0.5	10/0.5	10/4	63 A 80 A 100 A 125 A 160 A	100 A 100 A 100 A 100 A 100 A	10 000 3
S 270 - C 0.5 ... 2	unlimited					not necessary		unlimited
3 ... 4 6 8 ... 13 16 ... 20 25 ... 32 40 50 ... 63	10/0.5	10/0.5	10/0.5	10/0.5	10/4	20 A 40 A 63 A 80 A 100 A 125 A 160 A	- - 100 A 100 A 100 A 100 A 100 A	10 000 3
S 270 - K 0.5 ... 2	unlimited					not necessary		unlimited
3 4 6 ... 10 16 ... 20 25 ... 32 40 50 ... 63	10/0.5	6/0.7	10/0.5	6/0.7	10/4	20 A 25 A 63 A 80 A 100 A 125 A 160 A	- - 100 A 100 A 100 A 100 A 100 A	6000
S 270 - Z 0.5 ... 2	unlimited					not necessary		unlimited
3 ... 4 6 8 10 ... 16 20 ... 25 32 ... 40 50 ... 63	10/0.5	6/0.7	10/0.5	6/0.7	10/4	20 A 35 A 40 A 63 A 80 A 100 A 125 A	- 100 A 100 A 100 A 100 A 100 A 100 A	6000

Miniature Circuit Breakers

System pro M

Short circuit rupturing capacity

Switching sequence acc. to DIN VDE 0641 part 11, EN 60 898, IEC 898

Ratings with AC in kA / cos φ, with DC in kA / T ms

Range	Tripping characteristic	Rated current	AC				DC ① single pole up to 60 V ... kA/T ≤ ms	Max. Back-up protection		Max. Short-circuit rupturing capacity of the range
			1-phase 133 V ~ kA/cos φ	230 V ~ kA/cos φ	2/3-phase 230 V ~ 133/230 V ~ kA/cos φ	400 V ~ 230/400 V ~ kA/cos φ		fuse	Main circuit breaker ②	
S 280 - B	6	15/0.25	10/0.5	15/0.25	10/0.5	10/4	63 A	100 A	up to 25 000	
	10 ... 13	25/0.25	25/0.25	25/0.25	25/0.25		80 A	100 A		
	16 ... 25					15/4	100 A	100 A		
	32 ... 40	20/0.25	15/0.25	20/0.25	15/0.25		125 A	100 A		
	50 ... 63	15/0.25	10/0.25	15/0.25	10/0.5		10/4	160 A		100 A
S 280 - C	0.5 ... 2	unlimited					not necessary		unlimited	
	3, 4	15/0.25	10/0.5	15/0.25	10/0.5	10/4	35 A	100 A	up to 25 000	
	6, 8						63 A	100 A		
	10, 13	25/0.25	25/0.25	25/0.25	25/0.25		80 A	100 A		
	16 ... 25					15/4	100 A	100 A		
	32 ... 40	20/0.25	15/0.25	20/0.25	15/0.25		15/4	125 A		100 A
50 ... 63	15/0.25	10/0.5	15/0.25	10/0.5	10/4	160 A	100 A			
S 280 - K,Z,D	0.2 ... 2 ③	unlimited					not necessary		unlimited	
	3	15/0.25	10/0.5	15/0.25	10/0.5	10/4	25 A	-	up to 25 000	
	4						35 A	-		
	6						63 A	100 A		
	8						80 A	100 A		
	10 ... 20	25/0.25	25/0.25	25/0.25	25/0.25	15/4	100 A	100 A		
	25 ... 32	20/0.25	15/0.25	20/0.25	15/0.25	15/4	125 A	100 A		
40 ... 63	15/0.25	10/0.5	15/0.25	10/0.5	10/4	160 A	100 A			

① In symmetrical earth-ground AC networks 2 pole MCB's (two poles in series) are applicable up to 110 V ... In this case the rated rupturing capacity is one step higher than the 1 pole version. Direction of connection is optional.

② The max. back-up protection is only required if the prospective short circuit current may exceed the short circuit rupturing capacity of the MCB.

③ K from 0.2 A, Z from 0.5 A rated current.

Short circuit rupturing capacity

Switching sequence according to DIN VDE 0660 Part 101, IEC 947

For the short circuit rupturing capacities listed the time constant $T = L/R \leq 15$ ms is valid in the case of DC.

In the case of AC for 10 kA; cos φ ≥ 0.6 - for 8 and 6 kA: cos φ ≥ 0.7 - for 4, 5 and 3 kA: cos φ ≥ 0.8 and for 2 kA: cos φ ≥ 0.9.

S 280 UC	1 pole				2/4 pole				Max. fuse ④ for back-up protection; operating class gL (DIN VDE 0636/IEC 269)
	up to 60 V ...	100 V ...	220 V ...	up to 60 V ...	110 V ...	220 V ...	440 V ...		
for DC	up to 60 V ~	127 V ~	240 V ~	up to 60 V ~	127 V ~	240 V ~	415 V ~		
for AC	up to 60 V ~	127 V ~	240 V ~	up to 60 V ~	127 V ~	240 V ~	415 V ~		
B 6 ... 25 A	10 kA	10 kA	6 kA	10 kA	10 kA	10 kA	6 kA	100 A	
K, Z 0.2 ... 2 A ⑤	unlimited	unlimited	unlimited	unlimited	unlimited	unlimited	unlimited	not necessary	
K, Z 3 ... 4 A	10 kA	10 kA	6 kA	10 kA	10 kA	10 kA	6 kA	35 A	
K, Z 6 ... 8 A	10 kA	10 kA	6 kA	10 kA	10 kA	10 kA	6 kA	63 A	
K, Z 10 ... 32 A	10 kA	10 kA	6 kA	10 kA	10 kA	10 kA	6 kA	100 A	
K; Z 40 ... 63 A	6 kA	6 kA	4.5 kA	10 kA	6 kA	6 kA	4.5 kA	125 A	

④ Back-up protection is only necessary when, at the point of installation the maximum rated short circuit rupturing capacity is expected to be exceeded.

⑤ Z 0.5 A ... 2 A

Miniature Circuit Breakers

System pro M

Rated current of MCB S 280-UC I_n A	Maximum back-up protection			
	MCB S 280 UC - B		MCB S 280 UC - K, Z	
	to fuses gL A	to Main-circuit Breakers S 700-E A	to fuses gL A	to Main-circuit Breakers S 700-E A
0.2 ... 2	-	-	not necessary	
3	-	-	35	-
4	-	-	50	-
6	63	100	63	100
8 ... 10	80	100	80	100
16 ... 40	100	100	100	100
50 ... 63	125	100	100	100

Selectivity in case of overload

The miniature circuit breaker is selective to the back-up fuse in the overcurrent range. For short-circuit selectivity see page 23/25.

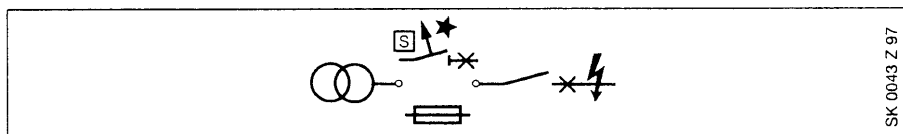

Determination of the smallest selective back-up device (main circuit breaker or fuse) to a STOTZ M.C.B.

Smallest rated current of back-up device = rated current of M.C.B. x selective factor

Selective factors (overload)

M.C.B. Characteristic/ S 240/S 260/S 270/S 280 rated current	main circuit breaker S 700		Fuse
	E_{sel}	K_{esel}	gL
B 6 - B 63 A	1.4	1.4	-
C 0.5 - C 6 A C 8 - C 32 A C 40 - C 63 A	2.0	1.4	5 3.2 2.5
D 0.5 - D 3 A D 4 - D 16 A D 25 - D 63 A	2.8	1.4	5 4 3.2
K 0.5 - K 3 A K 4 - K 20 A K 25 - K 63 A	2.4	1.2	5 2 3.2
S 280 K 0.2 - K 16 A K 20 - K 63 A	2.8	1.4	5 4
Z 0.5 - Z 10 A Z 16 - Z 63 A	1.15	1.15	2 1.6

Examples

Determine for a M.C.B. type B16 the smallest selective back-up device.

S 700 - E_{sel}

$I_{n S 700 E} \geq 16 \cdot 1.4 = 22.4 \text{ A}$
select: S 700 - E 25

S 700 - K_{sel}

$I_{n S 700 E} \geq 16 \cdot 1.4 = 22.4 \text{ A}$
select: S 700 - K 25

Fuse gL

$I_{n \text{ fuse gL}} > 16 \times 2.0 = 32 \text{ A}$
select: fuse gL 32 A

Miniature Circuit Breakers

System pro M

Tripping diagrams

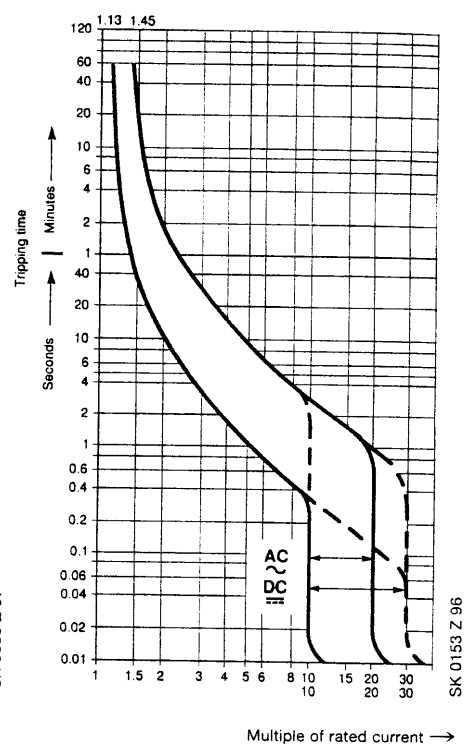
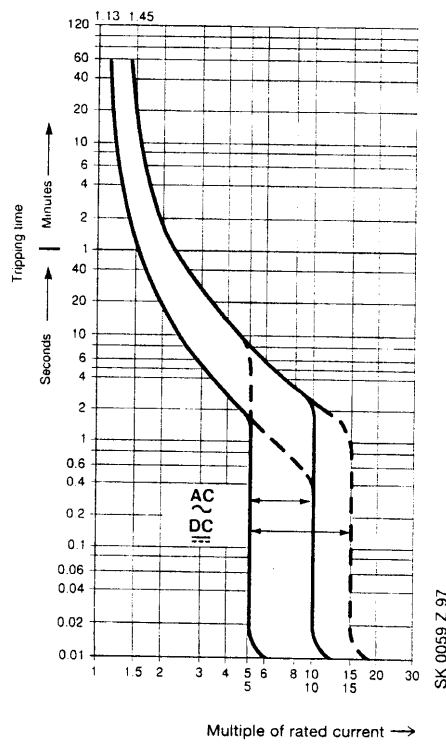
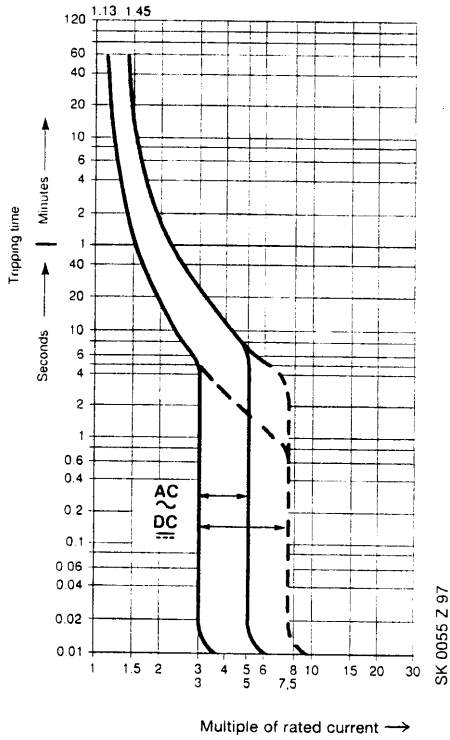

Tripping characteristic B
acc. to DIN VDE 0641 part 11
 $I_n = 6 \dots 63 \text{ A}$

Tripping characteristic C
acc. to DIN VDE 0641 part 11
 $I_n = 0.5 \dots 63 \text{ A}$

Tripping characteristic D
acc. to DIN VDE 0641 part 11
 $I_n = 0.5 \dots 63 \text{ A}$

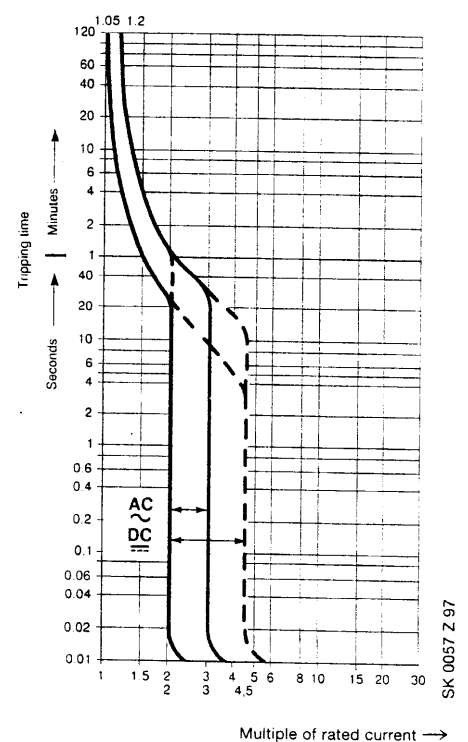
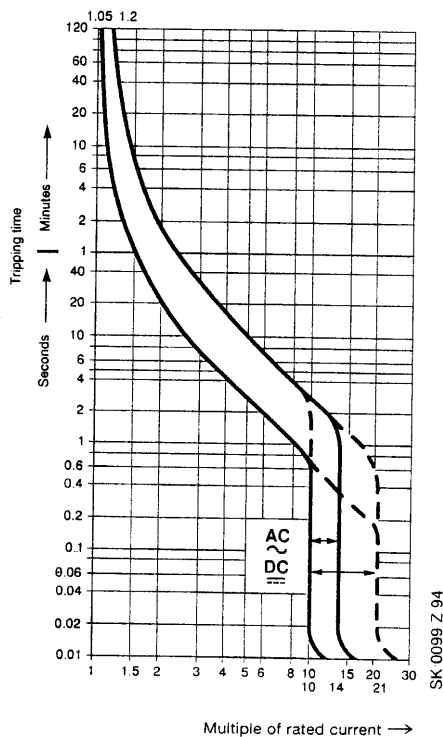
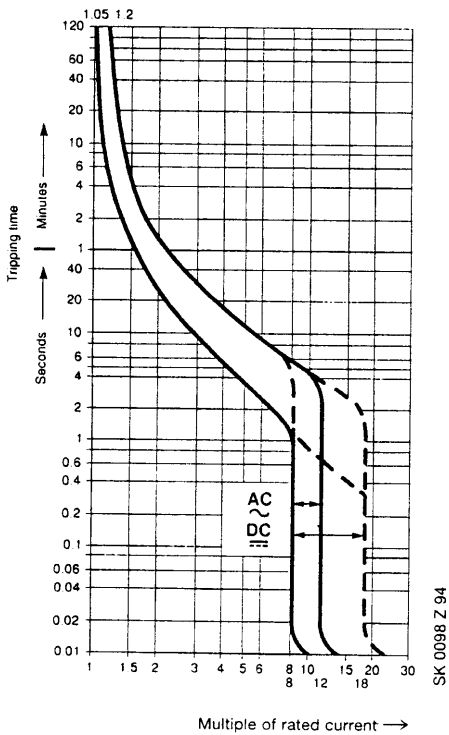

Tripping characteristic K
 $I_n = 0.5 \dots 63 \text{ A}$
S 270

Tripping characteristic K
 $I_n = 0.2 \dots 63 \text{ A}$
S 280

Tripping characteristic Z
 $I_n = 0.5 \dots 63 \text{ A}$

Miniature Circuit Breakers

System pro M

Pulse tripping of the STOTZ MBC's acc. to EN 60 898

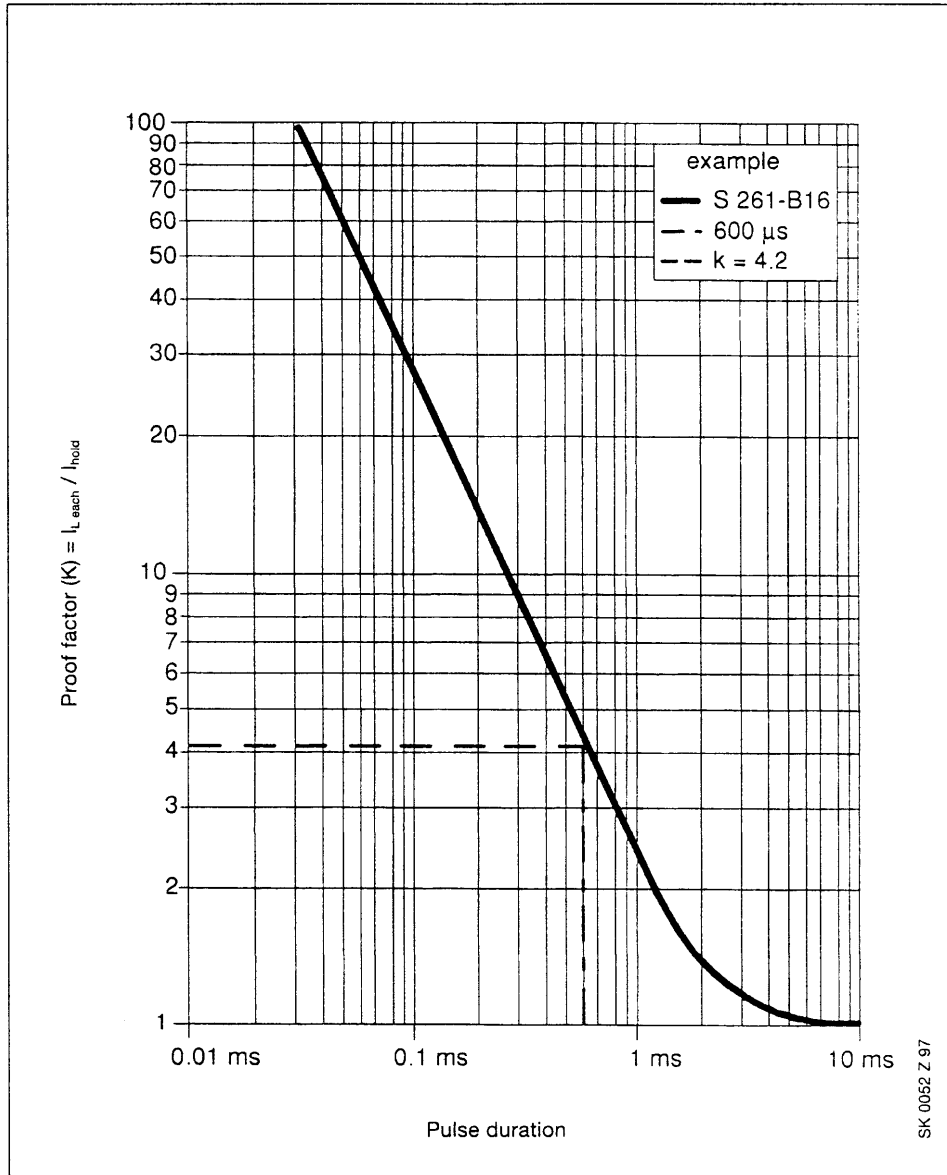

Example: S 261 – B 16

$$I_{hold} = K \cdot I_{hold} \quad (I_{hold} = 3 \cdot I_n)$$

$$I_{hold} = 4.2 \cdot 3 \cdot 16$$

$$I_{hold} = 201.6 \text{ A}$$

B-Charakteristik = $3 \cdot I_n$

C-Charakteristik = $5 \cdot I_n$

K-Charakteristik = $8 \cdot I_n$

Miniature Circuit Breakers

System pro M

Diagram of the let-through value I^2t

Miniature circuit breakers S 260 B/C

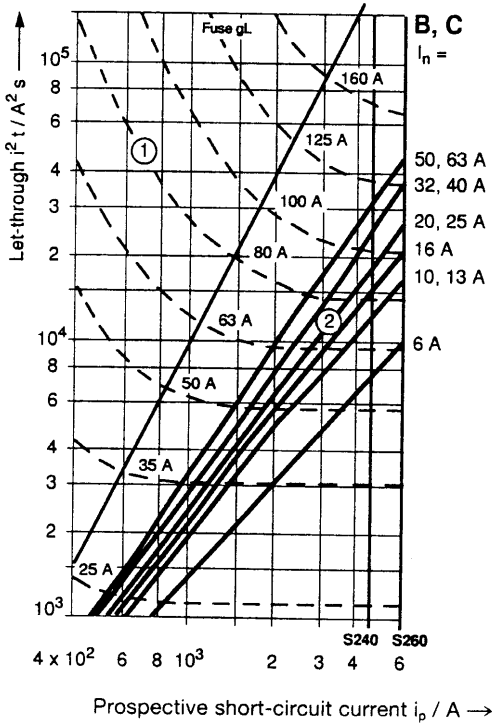

Miniature circuit breakers S 270 B/C

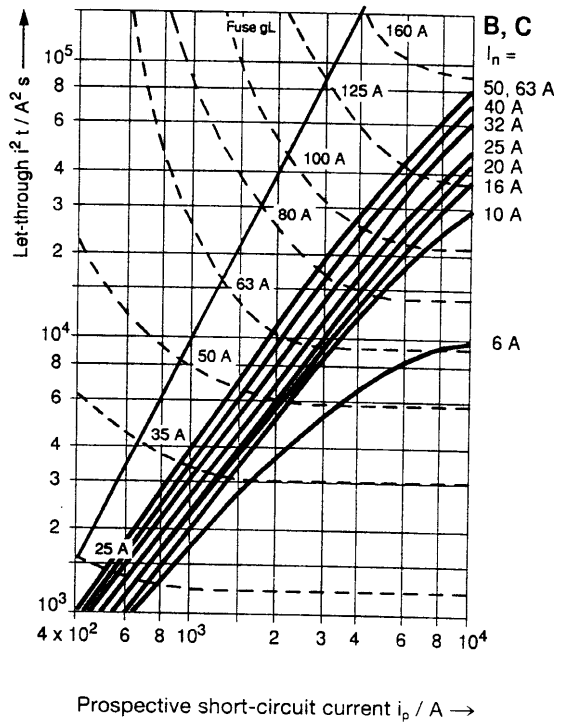

- ① min. melting I^2t (pre-arcing), e.g. $I_n = 80 A$ gL
- ② max. Let-through I^2t of M.C.B., e.g. B 20 A

Let through value I^2t reduce by
127 V ~ with factor 2.5 - 110 V ~ with factor 3.0

Miniature circuit breakers S 270-K, S 260-D

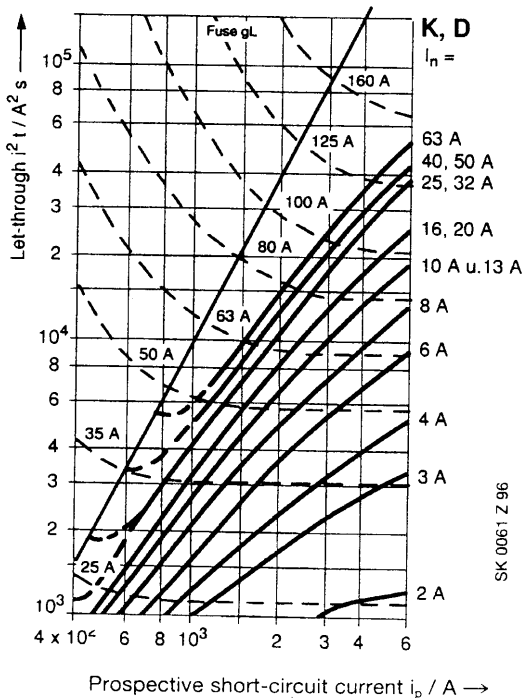

Miniature circuit breakers S 270-Z

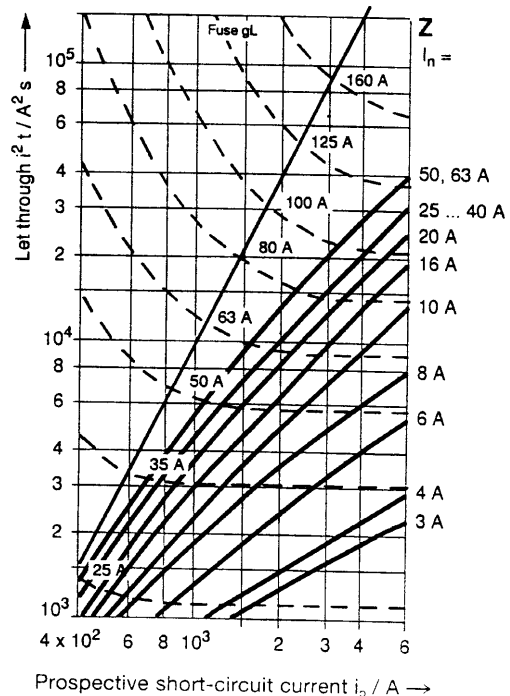

Miniature Circuit Breakers

System pro M

Diagram of the let-through value I^2t

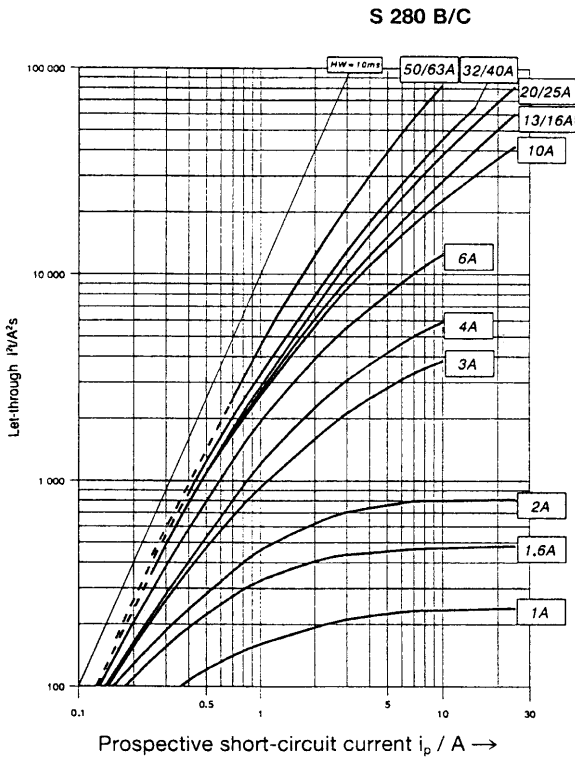

SK 0156 Z 94

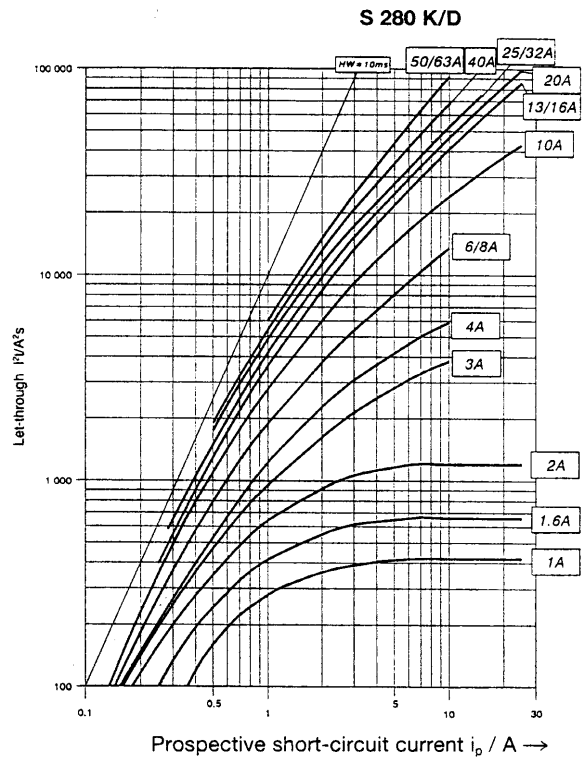

SK 0157 Z 94

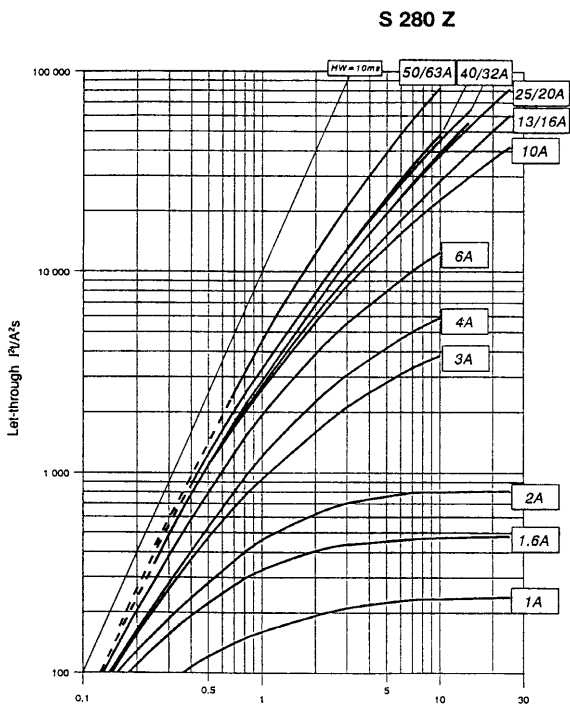

SK 0158 Z 94

Miniature Circuit Breakers

System pro M

Internal resistances and power losses of the Miniature Circuit-Breakers

Internal resistances per pole in mΩ

Power losses per pole in W

Type	Rated current A	Range S 230-B, C		Range S 260-B, S 270-B		Range S 260-C, S 270-C		Range S 270-K, S 260-D		Range S 270-Z	
		mΩ	W	mΩ	W	mΩ	W	mΩ	W	mΩ	W
S 2	0.5	-	-	-	-	5500	1.4	6340	1.6	10100	2.52
	1	-	-	-	-	1440	1.4	1550	1.6	2270	2.27
	1.6	-	-	-	-	630	1.6	695	1.8	1100	2.81
	2	-	-	-	-	460	1.8	460	1.9	619	2.47
	3	-	-	-	-	150	1.3	165	1.5	202	1.82
	4	-	-	-	-	110	1.8	120	2.0	149	2.38
	6	55	2.0	55	2.0	55	2.0	52	1.9	104	3.74
	8	-	-	-	-	15	1.0	38	2.5	53.9	3.45
	10	13.3	1.3	13.3	1.3	13.3	1.3	12.6	1.26	17.5	1.75
	13	13.3	2.3	13.3	2.3	13.3	2.3	12.6	1.26	-	-
	16	7.0	1.8	7.0	1.8	7.0	1.8	7.7	2.0	10.9	2.80
	20	6.25	2.5	6.25	2.5	6.25	2.5	6.7	2.7	6.0	2.40
	25	5.0	3.2	5.0	3.2	5.0	3.2	4.6	2.9	4.10	2.56
	32	3.6	3.7	3.6	3.7	3.6	3.7	3.5	3.6	2.81	2.88
	40	3.0	4.8	3.0	4.8	3.0	4.8	2.8	4.5	2.55	4.09
	50	-	-	1.2	3.0	1.2	3.0	1.15	2.9	1.77	4.43
	63	-	-	0.9	3.6	1.4	5.6	0.7	5.2	1.31	5.20

	Rated current I _n	S 280 UC-B		S 280-D S 280-K/S 280 UC-K		S 280-Z/S 280 UC-Z		S 280-B and C ①	
		mΩ	W	mΩ	W	mΩ	W	mΩ	W
S 280	0.2	-	-	33300	1.33	-	-	-	-
	0.3	-	-	19700	1.77	-	-	-	-
	0.5	-	-	5020	1.26	10100	2.52	5500	1.4
	0.75	-	-	2400	1.35	-	-	-	-
	1	-	-	1390	1.39	2270	2.27	1440	1.4
	1.6	-	-	612	1.56	1100	2.81	630	1.6
	2	-	-	450	1.79	619	2.47	460	1.8
	3	-	-	147	1.32	202	1.82	150	1.3
	4	-	-	112	1.79	149	2.38	110	1.8
	6	55	2.0	54.1	1.95	104	3.74	55	2.0
	8	-	-	33.8	2.16	53.9	3.45	15	1.0
	10	13.5	1.35	15.1	1.51	17.5	1.75	13.5	1.35
	13	-	-	-	-	-	-	13.3	2.3
	16	9.7	2.5	8.1	2.07	10.9	2.80	9.7	2.5
	20	6.25	2.5	5.27	2.11	6.0	2.40	6.25	2.5
	25	3.0	1.9	3.97	2.48	4.1	2.56	3.0	1.9
	32	-	-	2.65	2.71	2.81	2.88	2.9	3.7
	40	-	-	2.44	3.90	2.55	4.09	2.0	4.8
	50	-	-	1.15	2.90	1.77	4.43	1.2	3.0
	63	-	-	0.7	5.20	1.31	5.20	1.4	5.6

① 0.5 – 4 A and 8 A rated current only apply to C-characteristic

Miniature Circuit Breakers

System pro M

**Maximum permissible fault loop impedance Z_s for $U_0 = 230\text{ V} \sim$ ①
for compliance with the rupturing conditions prescribed in DIN VDE 0100, part 410**

Rated current I_n A	B		C		D, K		Z	
	max. Z_s for rupturing time $t_a < 0.2\text{ s}$ < 5 s							
	< 0.2 s Ω	< 5 s Ω	< 0.2 s Ω	< 5 s Ω	< 0.2 s Ω	< 5 s Ω	< 0.2 s Ω	< 5 s Ω
0.2	-	-	-	-	82.1	110	-	-
0.3	-	-	-	-	54.7	73	-	-
0.5	-	-	46	70.8	32.8	44	153	153
0.75	-	-	-	-	21.9	29.3	-	-
1.0	-	-	23	35.4	16.4	22.0	78.7	78.7
1.6	-	-	14.4	22.1	10.2	13.7	47.9	47.9
2	-	-	11.5	17.7	8.2	11.0	38.3	38.3
3	-	-	7.7	11.8	5.4	7.3	25.5	25.5
4	-	-	5.8	8.8	4.1	5.5	19.1	19.1
6	7.6	7.6	3.8	5.9	2.7	3.6	12.7	12.7
8	-	-	2.8	5.7	2.0	2.7	9.5	9.5
10	4.6	4.6	2.3	3.5	1.6	2.9	4.1	4.1
13	3.5	3.5	1.7	2.7	-	-	-	-
16	2.9	2.9	1.4	2.2	1.0	1.8	4.7	4.7
20	2.3	2.3	1.1	1.7	0.8	1.4	3.8	3.8
25	1.8	1.8	0.9	1.4	0.6	1.1	3.0	3.0
32	1.4	1.4	0.7	1.1	0.5	0.9	2.4	2.4
40	1.1	1.1	0.6	0.9	0.4	0.7	1.9	1.9
50	0.9	0.9	0.5	0.7	0.3	0.6	1.5	1.5
63	0.7	0.7	0.4	0.6	0.25	0.46	1.1	1.1

In those cases where the measured impedances exceed these values an earth fault protection device in acc. with VDE 0664 should be provided as a rupturing device in TN or TT networks.

e.g. STOTZ Residual Current Circuit-Breakers F 372 and F 374 or RCBO multiSTOTZ F 270/6.

① U_0 = rated voltage to earthed conductors: for $U_0 = 240\text{ V} \sim$ $Z_s \cdot 1.04$ applies;

for $U_0 = 127\text{ V} \sim$ $Z_s \cdot 0.55$ applies $ZS = R_{M,C.B.} + R_{loop}$

The fault loop impedance can be measured with commercially available instruments such as e.g. ABB-

Internal resistances and power losses of the MCB s

Internal resistances per pole in m Ω

Power losses per pole in W

S 290	C	
I_n	m Ω	W
80 A	1,0	6,4
100 A	0,8	8,0
125 A	0,7	10,9

Short-circuit selectivity in kA

If the short-circuit does not exceed the rupturing capacity of the MCB selectivity is given up to the stated values.

S 290 - C	to fuses gL / gl (DIN VDE 0663, IEC 269 / 3)					
$I_n \downarrow \rightarrow$	100	125	160	200	224	250
80 A	2,5	3,5	5,1	7,5	9,2	10
100 A	-	3,3	4,5	6,5	8,0	10
125 A	-	-	4,5	6,5	8,0	10

Maximum back-up fuse

The max. fuse for the back-up protection is only necessary, if at the mounting station the prospective short.circuit current could pass the declared short-circuit capacity.

S 290	Maximum back- up fuse S 290-C	
I_n	to fuses gL	to main MCB S 700 E
80 A	224	100
100 A	250	-
125 A	-	-

S 290	C	
I_n	max. Z_s for rupturing time $t_a < 0,2\text{ s}$ and $< 5\text{ s}$	
	< 0,2 s Ω	< 5 s Ω
	80 A	0,3
100 A	0,2	0,4
125 A	0,16	0,3

Miniature Circuit Breakers

System pro M

Short-circuit selectivity

If the short-circuit current does not exceed the rupturing capacity of the M.C.B. selectivity is given up to the stated values.

Miniature Circuit Breakers	Short-circuit selectivity in kA									to fuses, characteristic gL/gI (DIN VDE 0636; IEC 269/3)								
	I_n A	20	25	35	40	50	63	80	100	20	25	35	50	63	80	100	125	160
S 230-B ^① -C	6	3,0	3,0	3,0	3,0	3,0	3,0	3,0	3,0									
	10	3,0	3,0	3,0	3,0	3,0	3,0	3,0	3,0									
	16		3,0	3,0	3,0	3,0	3,0	3,0	3,0									
	20			3,0	3,0	3,0	3,0	3,0	3,0									
	25			3,0	3,0	3,0	3,0	3,0	3,0									
	32				3,0	3,0	3,0	3,0	3,0									
	40					3,0	3,0	3,0	3,0									
		no selectivity							3,0	3,0	3,0	on request						

S 260-B ^①	≤ 2	> 15	> 15	> 15	> 15	> 15	> 15	> 15	> 15	1.2	4	> 15	> 15	> 15	> 15	> 15	> 15	> 15		
-C ^②	3	6	6	6	6	6	6	6	6	0.7	1.2	4.6	6	6	6	6	6	6		
	4	6	6	6	6	6	6	6	6	0.6	0.9	2.8	6	6	6	6	6	6		
	6	6	6	6	6	6	6	6	6	0.5	0.8	2	3.3	5.5	6	6	6	6		
③	8	6	6	6	6	6	6	6	6	0.4	0.7	1.7	2.8	4.5	6	6	6	6		
	10	6	6	6	6	6	6	6	6	0.4	0.7	1.5	2.5	3.5	5	6	6	6		
	13	6	6	6	6	6	6	6	6		0.7	1.5	2.5	3.5	5	6	6	6		
	16		6	6	6	6	6	6	6			1.3	2	2.9	4.1	6	6	6		
	20			6	6	6	6	6	6				1.8	2.6	3.5	5	6	6		
	25			6	6	6	6	6	6				1.8	2.6	3.5	5	6	6		
	32				6	6	6	6	6					2.2	3	4	6	6		
	40					6	6	6	6						2.5	4	6	6		
	50/63	no selectivity							6	6	no selectivity							3.5	5	6

S 260-D	≤ 2	> 15	> 15	> 15	> 15	> 15	> 15	> 15	> 15	> 15	> 15	> 15	> 15	> 15	> 15	> 15	> 15	> 15		
	3	6	6	6	6	6	6	6	6	0.7	1.2	4.6	6	6	6	6	6	6		
	4	6	6	6	6	6	6	6	6	0.6	0.9	2.8	6	6	6	6	6	6		
	6	6	6	6	6	6	6	6	6		0.7	1.7	3	5.9	6	6	6	6		
	8		6	6	6	6	6	6	6			1.3	2.2	3.6	6	6	6	6		
	10			6	6	6	6	6	6				1.7	2.5	4	6	6	6		
	13				6	6	6	6	6				1.6	2.2	3.1	4.6	6	6		
	16					6	6	6	6					2.2	3.1	4.6	6	6		
	20						6	6	6						3.1	4.6	6	6		
	25							6	6						2.6	3.5	6	6		
	32								6							3.5	6	6		
	40/50																5.5	6		
	63	no selectivity									no selectivity									

- ① For the B-characteristic all values are valid, for the C-characteristic only the grey fields.
- ② Smaller currents below 6 A are only valid for C-characteristic.
- ③ The current 8 A are only valid for C-characteristic.

Miniature Circuit Breakers

System pro M

Short-circuit selectivity

If the short-circuit current does not exceed the rupturing capacity of the M.C.B. selectivity is given up to the stated values.

Miniature Circuit Breakers	I _n A	Short-circuit selectivity in kA to main circuit breakers S 700								to fuses, characteristic gL/gI (DIN VDE 0636; IEC 269/3)								
		20	25	35	40	50	63	80	100	20	25	35	50	63	80	100	125	160
S 270-B ① -C ②	≤ 2	> 15	> 15	> 15	> 15	> 15	> 15	> 15	> 15	1.2	4	> 15	> 15	> 15	> 15	> 15	> 15	> 15
	3	10	10	10	10	10	10	10	10	0.7	1.2	4.6	10	10	10	10	10	10
	4	10	10	10	10	10	10	10	10	0.6	0.9	2.8	7	10	10	10	10	10
	6	10	10	10	10	10	10	10	10	0.5	0.8	1.7	3.1	7	10	10	10	10
	10	10	10	10	10	10	10	10	10	0.4	0.7	1.4	2.3	3.4	4.8	7.5	10	10
	13	10	10	10	10	10	10	10	10		0.7	1.4	2.3	3.4	4.8	7.5	10	10
	16		10	10	10	10	10	10	10			1.3	2	2.9	4.2	6	9.5	10
	20			10	10	10	10	10	10				1.9	2.7	3.8	5.6	8.5	10
	25			10	10	10	10	10	10				1.8	2.6	3.6	5.4	8	10
	32				10	10	10	10	10					2.4	3.2	4.2	6.8	10
	40					10	10	10	10						3.2	4.2	6.8	9.5
	50/63	no selectivity							10	10	no selectivity					3.8	5.7	8.5

S 270-K	≤ 2	> 15	> 15	> 15	> 15	> 15	> 15	> 15	> 15	1.2	4	> 15	> 15	> 15	> 15	> 15	> 15	> 15	
	3	6	6	6	6	6	6	6	6	0.7	1.2	4.6	6	6	6	6	6	6	
	4	6	6	6	6	6	6	6	6	0.6	0.9	2.8	6	6	6	6	6	6	
	6	6	6	6	6	6	6	6	6		0.7	1.7	3	5.9	6	6	6	6	
	8	6	6	6	6	6	6	6	6			1.3	2.2	3.6	6	6	6	6	
	10/13		6	6	6	6	6	6	6				1.7	2.5	4	6	6	6	
	16			6	6	6	6	6	6					2.2	3.1	4.6	6	6	
	20				6	6	6	6	6						3.1	4.6	6	6	
	25					6	6	6	6						2.6	3.5	6	6	
	32						6	6	6							3.5	6	6	
	40/50							6	6								5.5	6	
	63	no selectivity								no selectivity									6

S 270-Z	≤ 2	> 15	> 15	> 15	> 15	> 15	> 15	> 15	> 15	> 15	> 15	> 15	> 15	> 15	> 15	> 15	> 15	> 15
	3	6	6	6	6	6	6	6	6	0.7	1.8	6	6	6	6	6	6	6
	4	6	6	6	6	6	6	6	6	0.6	1.3	6	6	6	6	6	6	6
	6	6	6	6	6	6	6	6	6	0.5	0.9	2.7	6	6	6	6	6	6
	8	6	6	6	6	6	6	6	6	0.5	0.6	1.7	3.8	6	6	6	6	6
	10	6	6	6	6	6	6	6	6	0.4	0.6	1.3	2.4	4	6	6	6	6
	16	6	6	6	6	6	6	6	6		0.5	1.1	1.7	3	4.5	6	6	6
	20		6	6	6	6	6	6	6			0.9	1.5	2.3	3.5	5.2	6	6
	25			6	6	6	6	6	6				1.4	2	3	4	6	6
	32				6	6	6	6	6				1.4	2	3	4	6	6
	40					6	6	6	6					2	3	4	6	6
	50/63	no selectivity					6	6	6	no selectivity					2.2	3.5	5.8	6

① For the B-characteristic all values are valid, for the C-characteristic only the grey fields.
 ② Smaller currents below 6 A are only valid for C-characteristic.

Miniature Circuit Breakers

System pro M

Short-circuit selectivity

If the short-circuit current does not exceed the rupturing capacity of the M.C.B. selectivity is given up to the stated values.

Miniature Circuit Breakers	I_n A	Short-circuit selectivity in kA to main circuit breakers S 700								to fuses, characteristic gL/gI (DIN VDE 0636; IEC 269/3)								
		20	25	35	40	50	63	80	100	20	25	35	50	63	80	100	125	160
S 280-B ① -C ②	≤ 2	> 15	> 15	> 15	> 15	> 15	> 15	> 15	> 15	1.2	4	> 15	> 15	> 15	> 15	> 15	> 15	> 15
	3	10	10	10	10	10	10	10	10	0.7	1.2	4.6	10	10	10	10	10	10
	4	10	10	10	10	10	10	10	10	0.6	0.9	2.8	7	10	10	10	10	10
	6	10	10	10	10	10	10	10	10	0.5	0.8	1.7	3.1	7	10	10	10	10
	10	10	10	10	10	10	10	10	10	0.4	0.7	1.4	2.3	3.4	4.8	7.5	10	10
	13	10	10	10	10	10	10	10	10		0.7	1.4	2.3	3.4	4.8	7.5	10	10
	16		10	10	10	10	10	10	10			1.3	2	2.9	4.2	6	9.5	10
	20			10	10	10	10	10	10				1.9	2.7	3.8	5.6	8.5	10
	25			10	10	10	10	10	10				1.8	2.6	3.6	5.4	8	10
	32				10	10	10	10	10					2.4	3.2	4.2	6.8	10
	40					10	10	10	10						3.2	4.2	6.8	9.5
	50/63							10	10							3.8	5.7	8.5

S 280-D -K	≤ 2	> 15	> 15	> 15	> 15	> 15	> 15	> 15	> 15	1.2	4	> 15	> 15	> 15	> 15	> 15	> 15	> 15	
	3	10	10	10	10	10	10	10	10	0.7	1.2	4.6	10	10	10	10	10	10	
	4	10	10	10	10	10	10	10	10	0.6	0.9	2.8	7	10	10	10	10	10	
	6	10	10	10	10	10	10	10	10		0.7	1.7	3	5.9	10	10	10	10	
	8	10	10	10	10	10	10	10	10			1.3	2.2	3.6	6	10	10	10	
	10/13		10	10	10	10	10	10	10				1.7	2.5	4	6.5	10	10	
	16			10	10	10	10	10	10					2.2	3.1	4.6	10	10	
	20				10	10	10	10	10						3.1	4.6	10	10	
	25					10	10	10	10						2.6	3.5	6	10	
	32						10	10	10							3.5	6	10	
	40/50							10	10									5.5	9
	63								10										7.5

S 280-Z	≤ 2	> 15	> 15	> 15	> 15	> 15	> 15	> 15	> 15	1.2	4	> 15	> 15	> 15	> 15	> 15	> 15	> 15	
	3	10	10	10	10	10	10	10	10	0.7	1.8	10	10	10	10	10	10	10	
	4	10	10	10	10	10	10	10	10	0.6	1.3	7	10	10	10	10	10	10	
	6	10	10	10	10	10	10	10	10	0.5	0.9	2.7	6	10	10	10	10	10	
	8	10	10	10	10	10	10	10	10	0.5	0.6	1.7	3.8	8	10	10	10	10	
	10	10	10	10	10	10	10	10	10	0.4	0.6	1.3	2.4	4	7	10	10	10	
	16	10	10	10	10	10	10	10	10		0.5	1.1	1.7	3	4.5	7.5	10	10	
	20		10	10	10	10	10	10	10			0.9	1.5	2.3	3.5	5.2	9.5	10	
	25			10	10	10	10	10	10					1.4	2	3	4	7	10
	32				10	10	10	10	10					1.4	2	3	4	7	10
	40					10	10	10	10						2	3	4	7	10
	50/63						10	10	10							2.2	3.5	5.8	10

① For the B-characteristic all values are valid, for the C-characteristic only the grey fields.

② Smaller currents below 6 A are only valid for C-characteristic.

Miniature Circuit Breakers

System pro M

Current-carrying capacity of the MCB's as a function of the ambient temperature

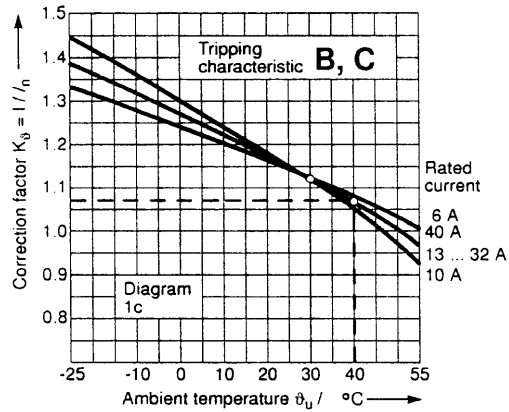

SK 0232 Z 95

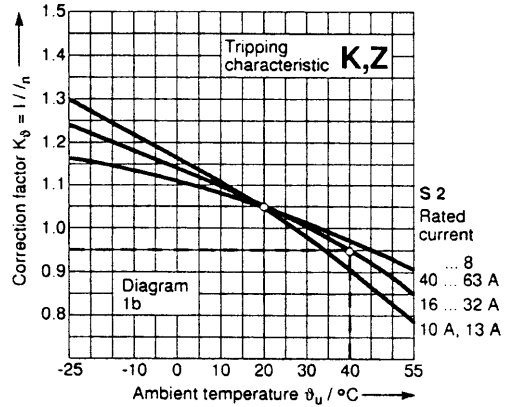

SK 0109 Z 94

Mutual thermal influence in the case of simultaneous load

MCB's mounted in a row side by side

MCB's mounted with a separating distance X

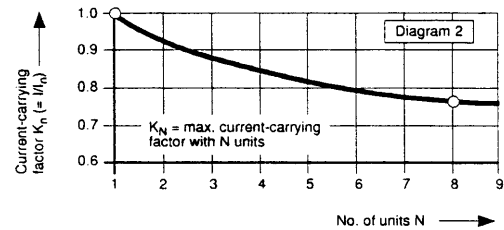

SK 0080 Z 93

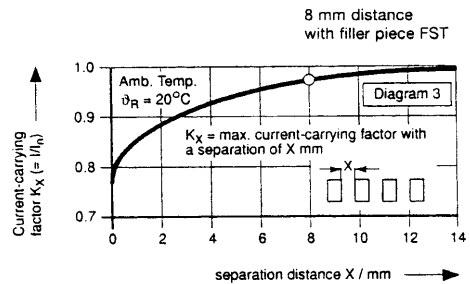

SK 0078 Z 93

Load data	from diagram	Calculation	Example
Rated current and characteristic of M.C.B. Continuous load Number of M.C.B.'s / Mounting distance		$I_n / B, C, D, K, Z$ θ_R N / X	16 A – B 40 °C 8 pieces / 0 and 8 mm
Load ≤ 1 h	1 a resp. 1 b	$I = I_n \cdot K_\theta$	$16 \cdot 1.07 = 17.1 \text{ A}$
Continuous load > 1 h		$I = 0.9 \cdot I_n \cdot K_\theta$	$0.9 \cdot 16 \cdot 1.07 = 15.4 \text{ A}$
Continuous load, N M.C.B.'s, Distance 0	2	$I = 0.9 \cdot K_\theta \cdot K_N$	$0.9 \cdot 16 \cdot 1.07 \cdot 0.77 = 11.9 \text{ A}$
Continuous load, N M.C.B.'s, Distance X	3	$I = 0.9 \cdot K_\theta \cdot K_X$	$0.9 \cdot 16 \cdot 1.07 \cdot 0.98 = 15.1 \text{ A}$

Miniature Circuit Breakers

System pro M

Examples for application

Reduction of making current peaks

The making time of a contactor type B 9 is 9 ... 17 ms. If this time is not sufficient, a delay-on energisation timer (0.1 ... 40 s) may be snapped onto the contactor without problems.

The resistor R_x has to be selected according to the requirements (see determination of R_x).

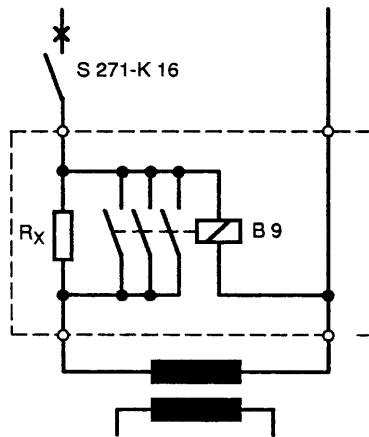

SK 0112 Z 94

Monitoring of fuses

The M.C.B. S 270-K 0.5 is especially suitable for the monitoring of fuses, since, due to its high internal resistance it has an unlimited switching capacity.

In case of planned switching, e.g. withdrawal of the fuse cartridges or opening of the disconnector it must be ensured that the M.C.B. also is switched off.

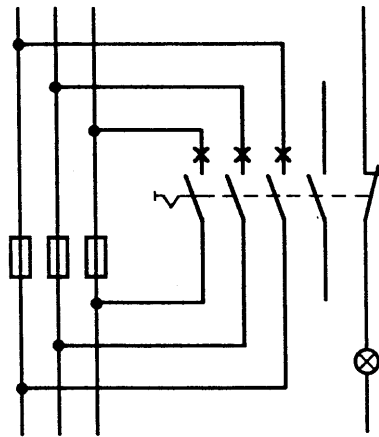

SK 0209 Z 95

Determination of R_x :

$$R_x > \frac{1.1 U_n}{I_H}$$

U_n = Mains voltage

I_H = electromagn. non tripping current of S 271-K ($8 \times I_n$) see table on page 14

Protection of lamps

1. Tungsten lamps and fluorescent tubes

In the following table is indicated the maximum allowed number of fluorescent lamps, which can be protected with a single pole M.C.B. For unit multi pole M.C.B.'s this number is reduced by 20%.

Miniature circuit breakers with K and C characteristic, can carry their rated current I_n when protecting:

Tungsten lamps

- Fluorescent lamps
- a) non compensated
 - b) parallel compensated
 - c) electronic ballast

2. High pressure lamps

Starting load: appr. 1.7 x nominal current of lamp.

Recovery time: 3 ... 5 min. Dependent on lamps type, cable impedance and starting moment a rectifier effect can overlay the starting current of lamps for some half waves.

In the worst case starting currents of approx. 15 x rated current of lamp may occur. To prevent nuisance tripping, M.C.B.'s with K characteristics may only be loaded with 0.6 times rated current of lamps.

The indicated load factor refers to the worst case of application (position near trafo, low cable impedances).

Characteristic / rated current	non compensated KVG			parallel compensated KVG			EVG 1		
	18/20 W	36/40 W	58/65 W	18/20 W	36/40 W	58/65 W	18/20 W	36/40 W	58/65 W
10	27	23	15	32	32	20	18	18	8
16	43	37	24	51	51	33	26	26	12
20	53	46	30	64	64	41	33	33	15
25	66	58	37	82	82	53	42	42	19

1 Version with 2 tubes, switched together

KVG: conventional ballast

EVG: electronic ballast

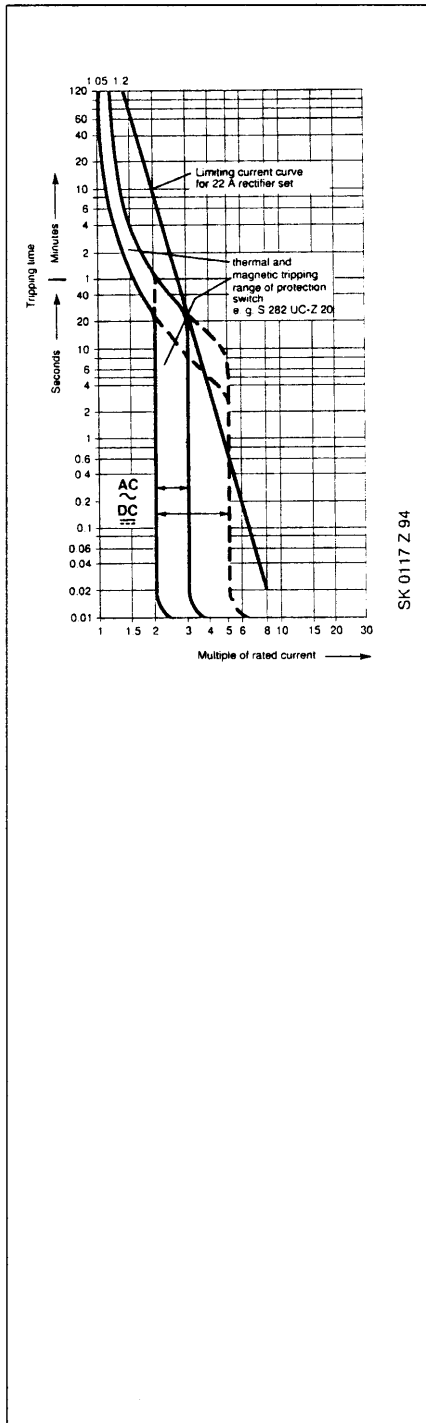

Thermal trips

acc. DIN VDE 0660 Part 104, Type 1
 Tripping time at $1.05 \cdot I_n > 1 \text{ h}$
 $1.2 \cdot I_n < 1 \text{ h}$

Electromagnetic trips

Tripping time at $2 \cdot I_n \sim > 0.2 \text{ s}$
 $3 \cdot I_n \sim < 0.1 \text{ s}$
 $5 \cdot I_n \sim < 0.2 \text{ s}$

S 280 Z I_n A	hold current surges of	break undelayed at	
		AC and DC $\geq 48\%$ ripple	DC $\leq 5\%$ ripple
0,5 A	1 A	1.5 A	2.4 A
1 A	2 A	3.0 A	4.8 A
1.6 A	3.2 A	4.8 A	7.7 A
2 A	4 A	6 A	9 A
3 A	6 A	9 A	15 A
4 A	8 A	12 A	19 A
6 A	12 A	18 A	29 A
8 A	16 A	24 A	38 A
10 A	20 A	30 A	48 A
16 A	32 A	48 A	77 A
20 A	40 A	60 A	96 A
25 A	50 A	75 A	120 A
32 A	64 A	96 A	153 A
40 A	80 A	120 A	192 A
50 A	100 A	150 A	240 A
63 A	126 A	189 A	120 A

Example, connection of a protection switch to a silicon rectifier set
(see characteristic curve)

22 A rectifier set in full wave connection with 4 silicon cells 11 A.
 Type of M.C.B. selected - S 282 UC-Z - 20 A.

The fact that both characteristic curves run side by side shows that the coordination conditions are still being fulfilled. If this were not the case, it would be necessary to substitute the next lower current rating S 282 UC-Z 16.

If short circuit currents higher than the surge current limiting values for 10 ms given in the manufacturer's documentation of the device are expected, the let through $\int I^2 dt$ of the protection switch must be less than the limiting load $\int I^2 dt$ of the device.

High rupturing capacity M.C.B.'s S 280 UC Range

The M.C.B.'s type S 280 UC can be used up to 220 V $\overline{\text{~}}$ for single pole M.C.B.'s or up to 440 V $\overline{\text{~}}$ for 2 pole or for 4 pole M.C.B.'s with series connection of 2 poles.

The S 280 UC version differs from the standard S 280 M.C.B. in that it is fitted with a permanent magnet which assists in the forced extinguishing of the arc. It is therefore important that care is taken to observe the correct polarity and current flow direction when connecting these M.C.B.'s.

If voltages of over 220 V $\overline{\text{~}}$ to earth are to be switched then for single pole switching a 2 pole M.C.B. S 280 UC and for all pole switching a 4 pole M.C.B. S 280 should be used.

It is not permitted to use a larger number of M.C.B.'s with less poles in place of a smaller number of M.C.B.'s with more poles i.e. separate single pole M.C.B.'s in place of a 2 or 4 pole M.C.B. are not allowed.

In the case of DC voltages up to 60 V $\overline{\text{~}}$ or by series connection up to 110 V $\overline{\text{~}}$ the standard S 280 M.C.B. can be used.

Example for max. permissible voltages between leads in relation to the number of poles and switching:

max. voltage between the leads	220 V $\overline{\text{~}}$	440 V $\overline{\text{~}}$	440 V $\overline{\text{~}}$	440 V $\overline{\text{~}}$	440 V $\overline{\text{~}}$ (voltage reversal)
max. voltage between leads and earth	220 V $\overline{\text{~}}$	220 V $\overline{\text{~}}$	440 V $\overline{\text{~}}$	220 V $\overline{\text{~}}$	220 V $\overline{\text{~}}$
M.C.B.	1 pole S 281 UC	2 pole S 282 UC	2 pole S 282 UC	2 pole S 282 UC	4 pole S 284 UC
Supply-input below					
Supply-input above					

① Negative pole connected to earth

② Positive pole connected to earth

Examples for various high voltages between a connecting lead and earth with equal voltages between the leads:

max. voltage between the leads	440 V $\overline{\text{~}}$ All pole switching	440 V $\overline{\text{~}}$ All pole switching	440 V $\overline{\text{~}}$ All pole switching
max. voltage between the leads and earth	220 V supply symmetrically earthed	440 V Mains unearthed or unsymmetrically earthed	440 V Mains unearthed or unsymmetrically earthed
M.C.B.	2 pole S 282 UC	2 pole S 282 UC	4 pole S 284 UC

Miniature Circuit Breakers

System pro M

Add-on possibilities of supplementary devices to M.C.B.'s (Examples)

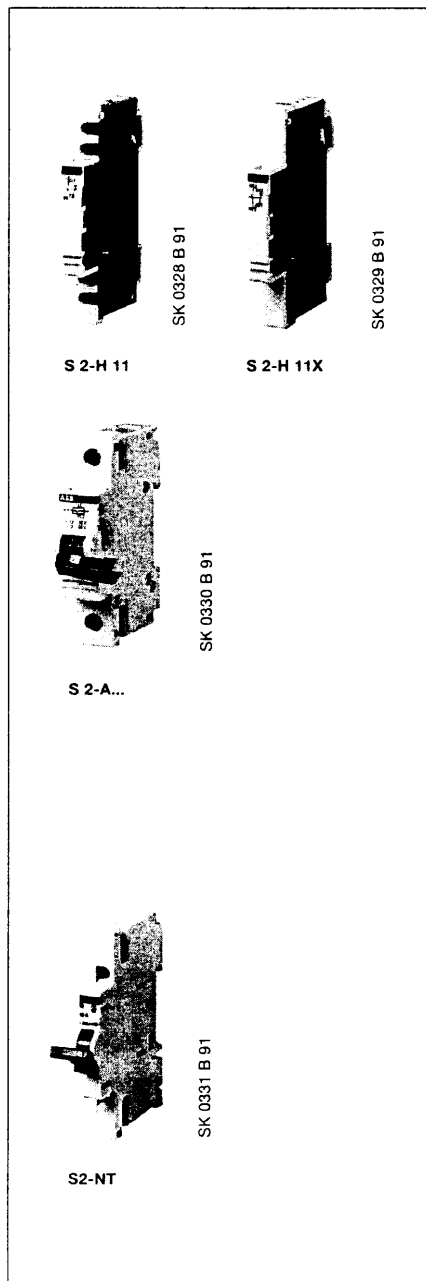
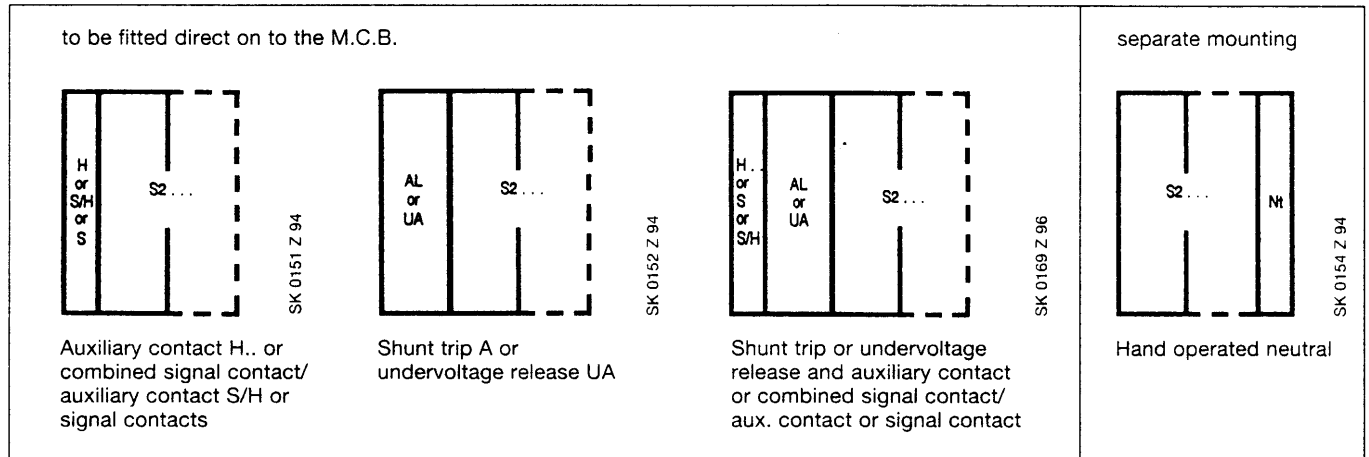

Supplementary devices for subsequent mounting

Auxiliary contact S 2 – H...

The auxiliary contact can be built on subsequently to the M.C.B.

The switching position of the auxiliary contact depends on the position of the M.C.B. (ON-OFF). Because of coupling to the switching mechanism of the M.C.B. the auxiliary contact offers a trip free feature.

The auxiliary contact can be delivered either with screw- or plug in connections, the auxiliary contact with 3 potential free contacts only in screw-in connection.

Signal contact S 2 – S

It signals the tripping caused by overload earth fault or short circuit current however there is no signal when the M.C.B. is switched OFF manually. With a red handle which allows resetting of the trip signal without the M.C.B. being switched on. It has also a test button for checking the control circuit without interrupting the main circuit.

Undervoltage release S 2 – UA ..

For remote tripping of the M.C.B. Only in case of substained voltage the relay allows to switch on the M.C.B. The undervoltage release trips the M.C.B. if the supply voltage is interrupted or switched off (suitable for emergency off circuits).

Shunt trip S 2 – A .

For remote tripping of the M.C.B. by applying a control voltage. The shunt trip contains a relay with an integrated contact, that opens after the M.C.B. has tripped and interrupts the control voltage of the relays, this prevents the flow of current in case of substained control voltage.

Supplementary devices for separate mounting

Hand operated neutral

The hand operated neutral has to be mounted to the right hand side of the M.C.B. and be snapped on to the DIN rail. It is used for measuring duties where the neutral conductor must be in the open position. Due to the special design of the handle – when switching ON the M.C.B. – the neutral will make before the M.C.B. is closed.

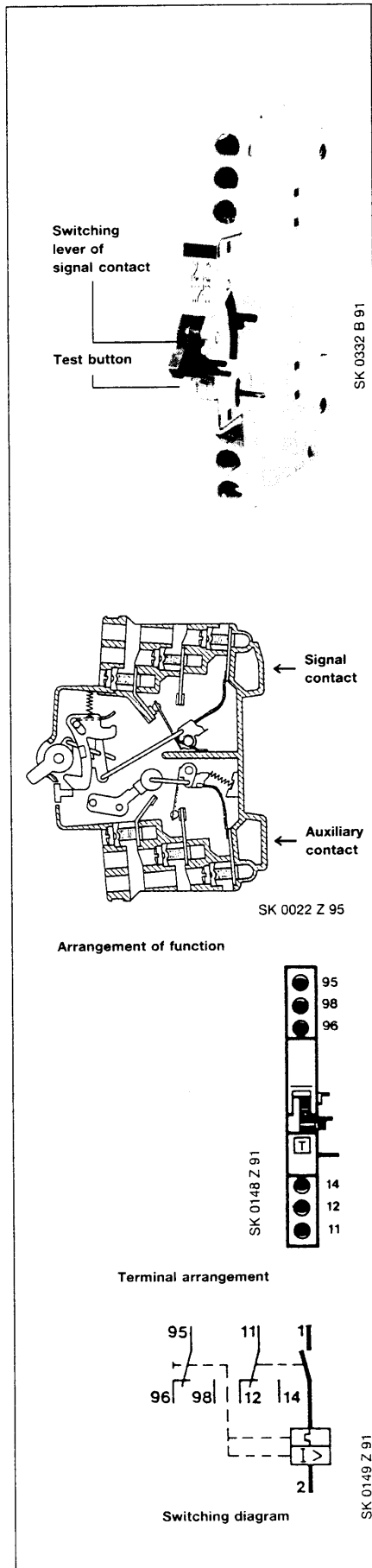

Supplementary devices for subsequent mounting

Combined signal contact/auxiliary contact S/H

The combined signal contact/auxiliary contact can easily be built-on subsequently to M.C.B.'s of the range S 260/S 270/S 280.

The signal unit and the auxiliary unit have a potential free changeover contact.

The contacts are trip free.

The signal contact

- signals the tripping caused by overload earth fault or short circuit current however there is no signal when the M.C.B. is switched OFF manually.
- has a red handle which allows resetting of the trip signal without the M.C.B. being switched on.
- has a test button for checking the control circuit without interrupting the main circuit.

The auxiliary contact

- signals a trip caused by overload, earth fault and short circuit current as well as the manual switching OFF of the M.C.B.

Applications

- for insulation measuring when the M.C.B. is switched OFF, in this case only the auxiliary contact switches, however, the signal contact remains in its position.
- for testing purposes of the control circuit. The signal contact is switched OFF of by pressing the test button "T" and can be reset by operating the red toggle, the main circuit will not be interrupted.
- the signal contact can be reset in order to switch OFF an accoustic signal, without switching the M.C.B.

The multipurpose function of the combined signal contact/auxiliary contact S2-H is excellent.

Testing the main circuit without signalling

Testing the signal circuit without service interruption

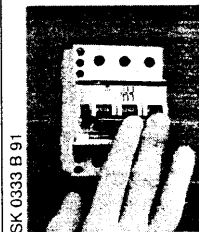

SK 0333 B 91

Manual operation

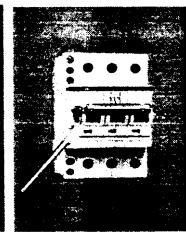

SK 0334 B 91

Pressing Test "T"

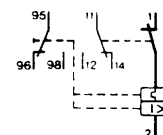
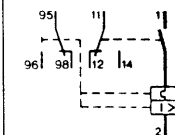

SK 0150 Z 91

After short circuit or overload, resetting of the signal

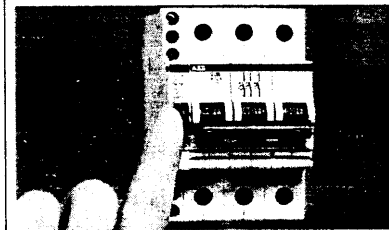

SK 0335 B 91

Press red signal contact handle to the top position

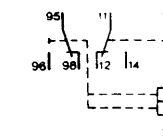
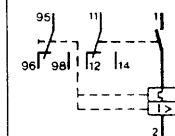

SK 0151 Z 91

Miniature Circuit Breaker

Mounting instruction for supplementary devices

System pro M

Auxiliary contacts, signal contact or combined signal contact/auxiliary contact

The M.C.B.'s S 260/S 270/S 280 range can subsequently be fitted with an auxiliary contact, signal contact or combined signal contact/auxiliary contact.

The auxiliary contact blocks are supplied with the contact arrangement 1 NO + 1 NC, 2 NO or 2 NC.

Ordering details see selection table.

The combined signal contact/auxiliary contact have each a potential free changeover contact.

Fitting of auxiliary contact

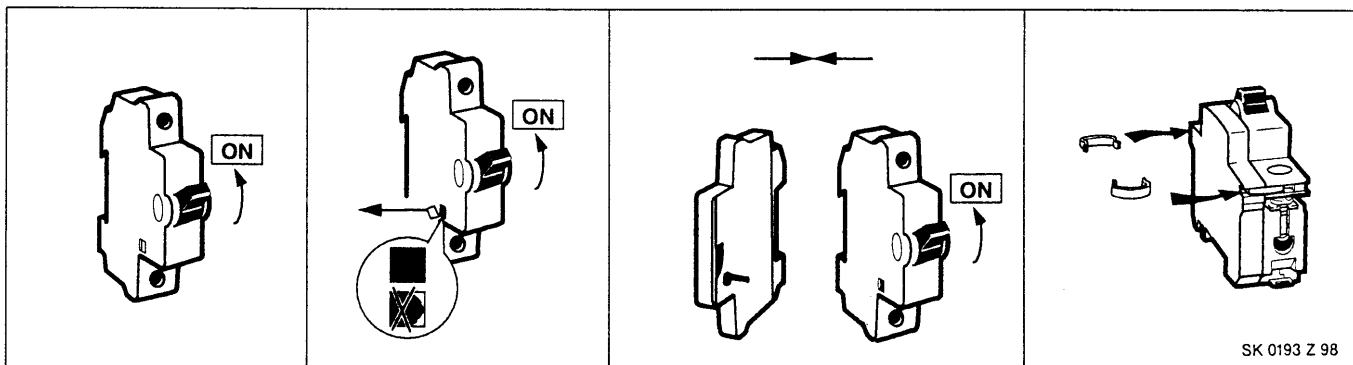

Bring the M.C.B.'s handle to the ON position.

Break out the opening at the M.C.B.

Place the auxiliary contact to the M.C.B. ...

... and fix it with spring clamps

Fitting of signal contact

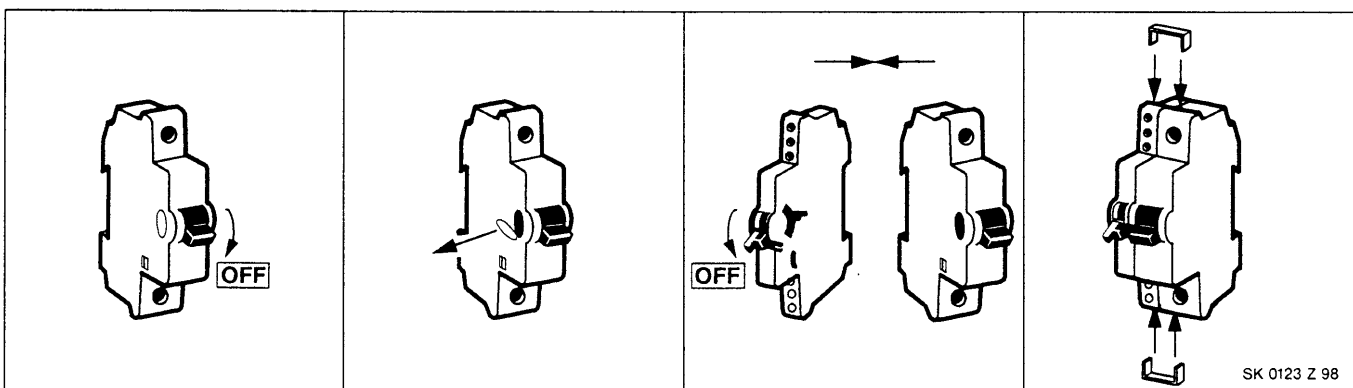

Bring the M.C.B.'s handle to the OFF position.

Remove the cover at the M.C.B.

Bring the signal contact's handle to the OFF position, place the signal contact to the M.C.B. ...

... and fix it with spring clamps

Fitting of combined signal contact/auxiliary contact

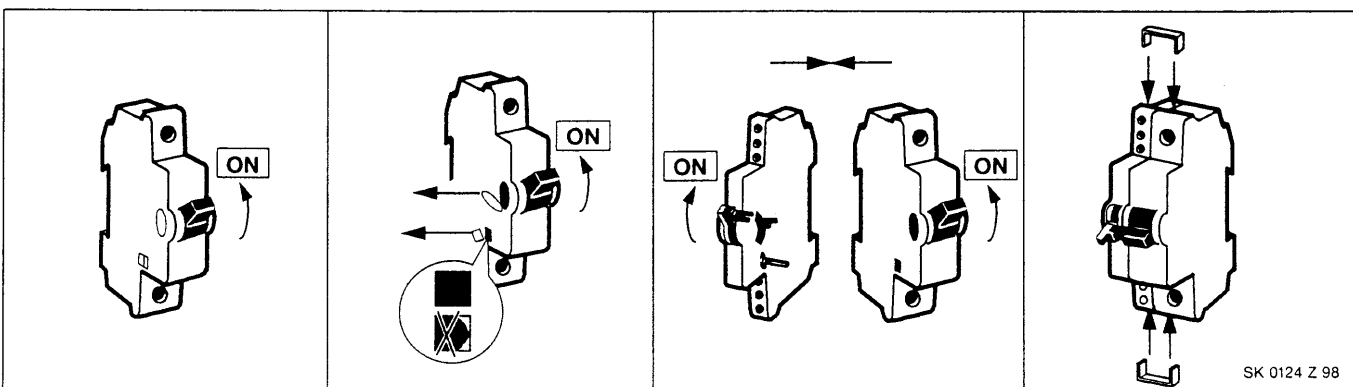

Bring the M.C.B.'s handle to the ON position.

Remove the cover and break out the opening at the M.C.B.

Bring the handles to the ON position, place the signal contact/auxiliary contact to the M.C.B. ...

... and fix it with spring clamps

Shunt trip

The M.C.B.'s S 260, S 270 and S 280 range can be subsequently be fitted with a shunt trip.

Mounting always to the left hand side of the M.C.B.

If auxiliary contacts or the combined signal contact/auxiliary contact are to be fitted these must be fitted on left hand side of the shunt trip.

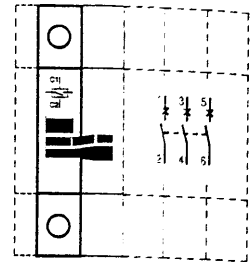

SK 0122 Z 94

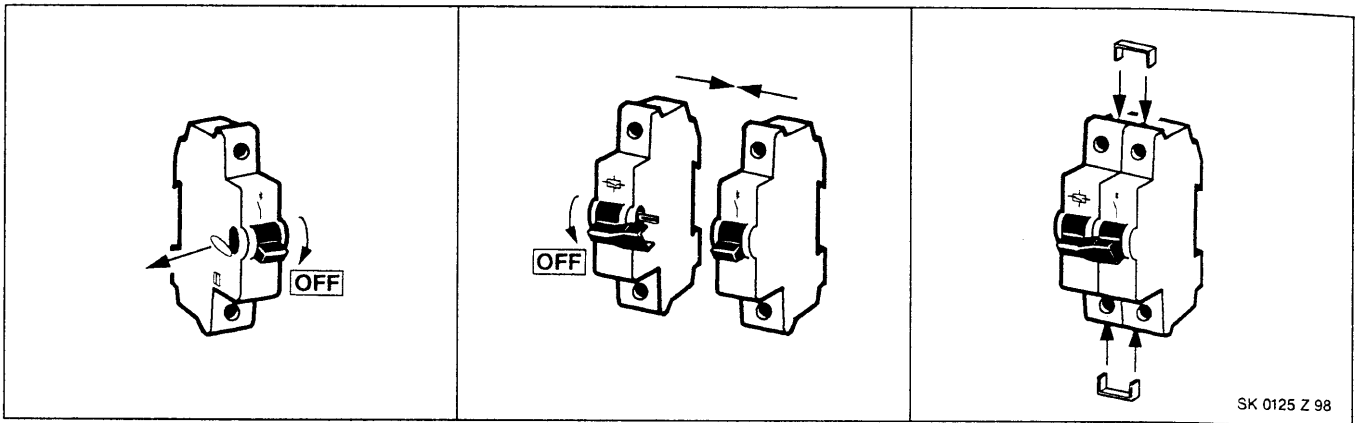

Bring the M.C.B.'s handle to the OFF position and remove the cover at the M.C.B.

Bring the shunt trip's handle in the OFF position, place the shunt trip to the M.C.B. ...

... and fix it with spring clamps

The possible fitting of an auxiliary contact or combined signal contact/auxiliary contact is described on page 32.

Under voltage release

Fitting of undervoltage release

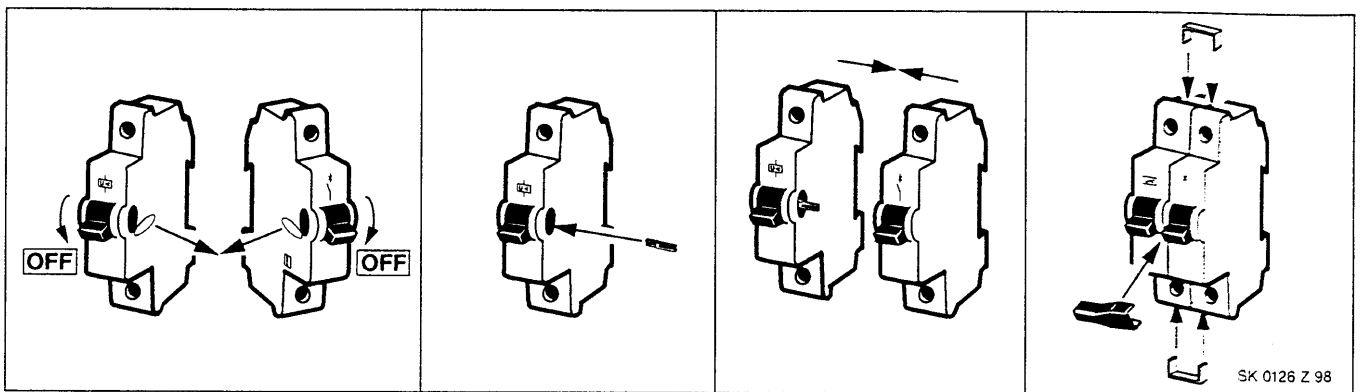

Bring the undervoltage relays and M.C.B.'s handle in OFF position and remove the covers.

Fit the connection lever in the housing of the M.C.B.

Place the undervoltage release to the M.C.B. ...

... fix it with spring clamps and install the switch lever.

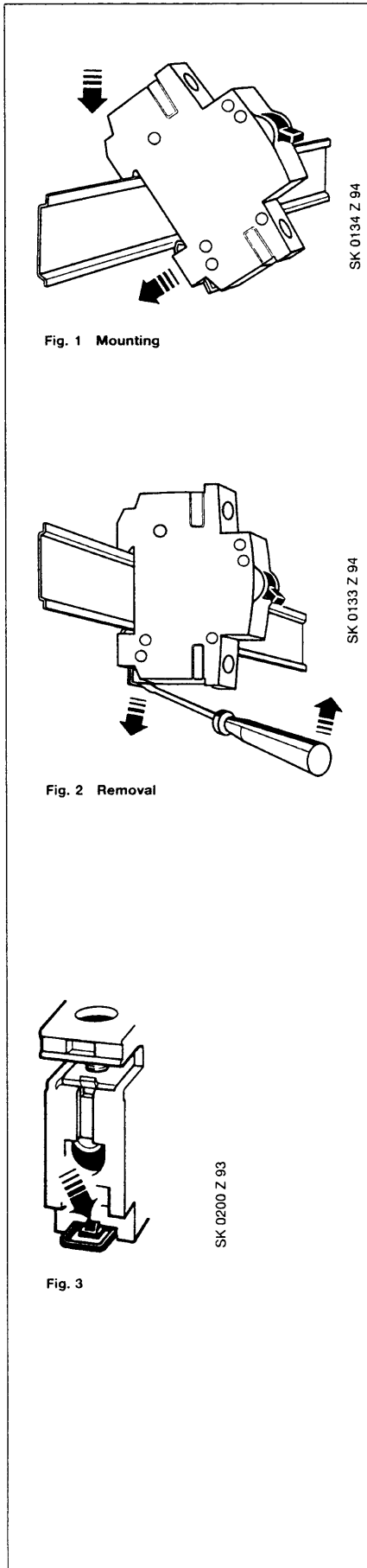

Fig. 1 Mounting

Fig. 2 Removal

Fig. 3

SK 0134 Z 94

SK 0133 Z 94

SK 0200 Z 93

SK 0030 Z 92

SK 0075 Z 94

SK 0105 Z 93

SK 0149 Z 91

SK 0118 Z 93

Technical Data see page 8/10

Mounting

Arbitrary mounting position using snap-on fixing to standard mounting rail EN 50 022 35 x 7.5 mm. The slide bolt located on the bottom side of the M.C.B. engaged in the external position. The engagement is triggered off by pressure on the middle part of the slide bolt only S 280 (see Fig. 3).

Separate mounting by means of:

- Mounting rail with 2 screw fixing holes.
- Mounting kit with terminal covers.
- Mounting kit for flange mounting with special terminals for rear connection.

Connection

Cable cross section see page 8/10

When connecting cables it must be ensured that the cable is rigidly fixed and is not likely to be moved by other components or is subject to excessive vibration.

Max. tightening torque 2 Nm for main terminals, and 0.5 Nm for auxiliary terminals.

Operation

The M.C.B.'s are switched on by operation of the switch toggle to the upper position i.e. towards the type label in the position "I" ON is visible on the switch toggle. At the S 280 the contact position indicator turns from red to green.

If the M.C.B. can be reclosed soon after a trip it can be assumed that the reason for tripping was an overload. If the M.C.B. trips instantly again when reclosed after a trip, wait for a while and try again. A repeated instant trip indicates a short-circuit or earthfault in the circuit. No attempt should be made to continually reclose on to an existing short-circuit or earth fault. The M.C.B.'s are fitted with a trip free mechanism i.e. they even trip under fault conditions also when the switch handle is held to the "I" (ON) position by force.

Cleaning

M.C.B.'s which may have become soiled during assembly work in the switchboard can be cleaned with a damp and soapy cloth. On no account corrosive or similar solvents should be used.

Maintenance

STOTZ M.C.B.'s are maintenance free.

In case of opening the M.C.B. the right to claim under guarantee expires.

Connection diagrams

Input optional from top or bottom. Terminal markings acc. EN 50 005.

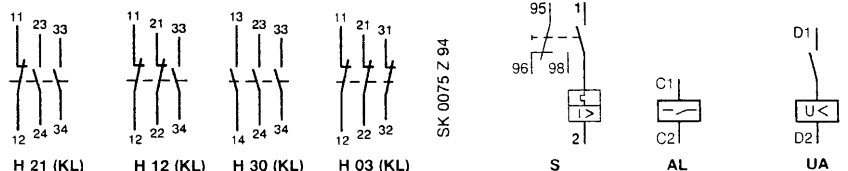
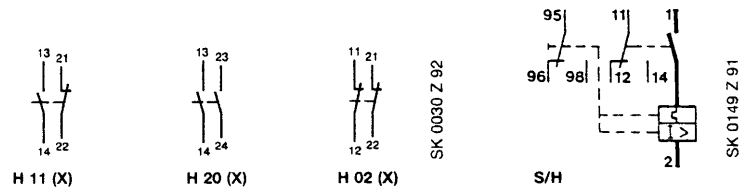
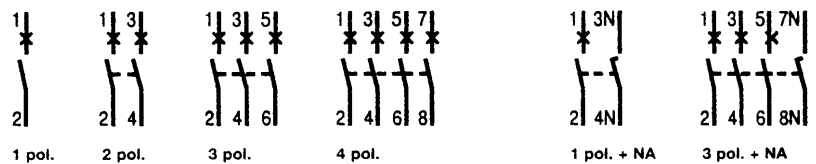

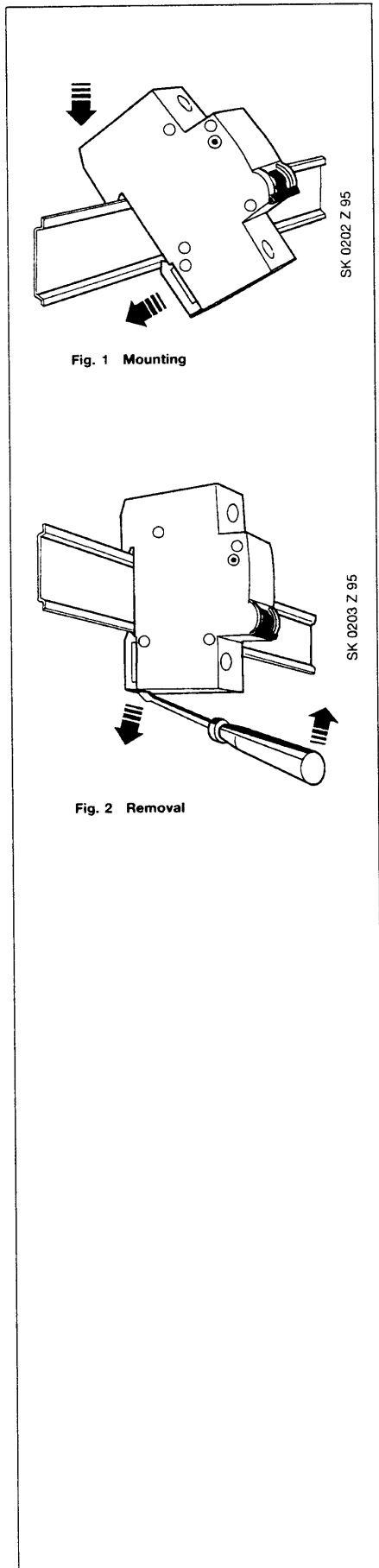

Fig. 1 Mounting

Fig. 2 Removal

Technical Data see page 11

Mounting

Arbitrary mounting position using snap-on fixing to standard mounting rail EN 50 022 35 x 7.5 mm.

Connection

When connecting cables it must be ensured that the cable is rigidly fixed and is not likely to be moved by other components or is subject to excessive vibration.
Max. tightening torque 4.5 Nm for main terminals, and 0.5 Nm for auxiliary terminals.

Operation

The M.C.B.'s are switched on by operation of the switch toggle to the upper position i.e. towards the type label in the position "I". The contact position indicator turns from red to green. If the M.C.B. can be reclosed soon after a trip it can be assumed that the reason for tripping was an overload. If the M.C.B. trips instantly again when reclosed after a trip, wait for a while and try again. A repeated instant trip indicates a short-circuit or earthfault in the circuit. No attempt should be made to continually reclose on to an existing short-circuit or earth fault. The M.C.B.'s are fitted with a trip free mechanism i.e. they even trip under fault conditions also when the switch handle is held to the "I" position.

Cleaning

M.C.B.'s which may have become soiled during assembly work in the switchboard can be cleaned with a damp and soapy cloth. On no account corrosive or similar solvents should be used.

Maintenance.

STOTZ M.C.B.'s are maintenance free.

In case of opening the M.C.B, the right to claim under guarantee expires.

Connection diagrams

Input optional from top or bottom. Terminal markings acc. EN 50 005.

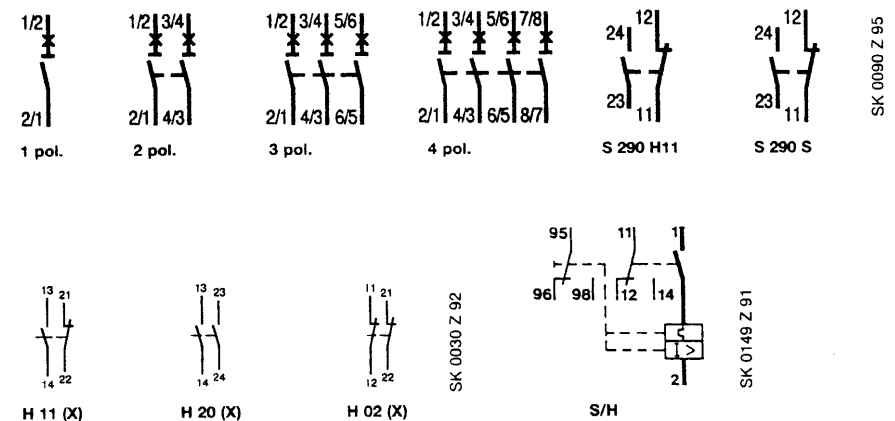

Miniature Circuit Breaker Dimensions

System pro M

Miniature Circuit Breaker S 230, S 260, S 270, S 280 and S 290

Dimensions in mm

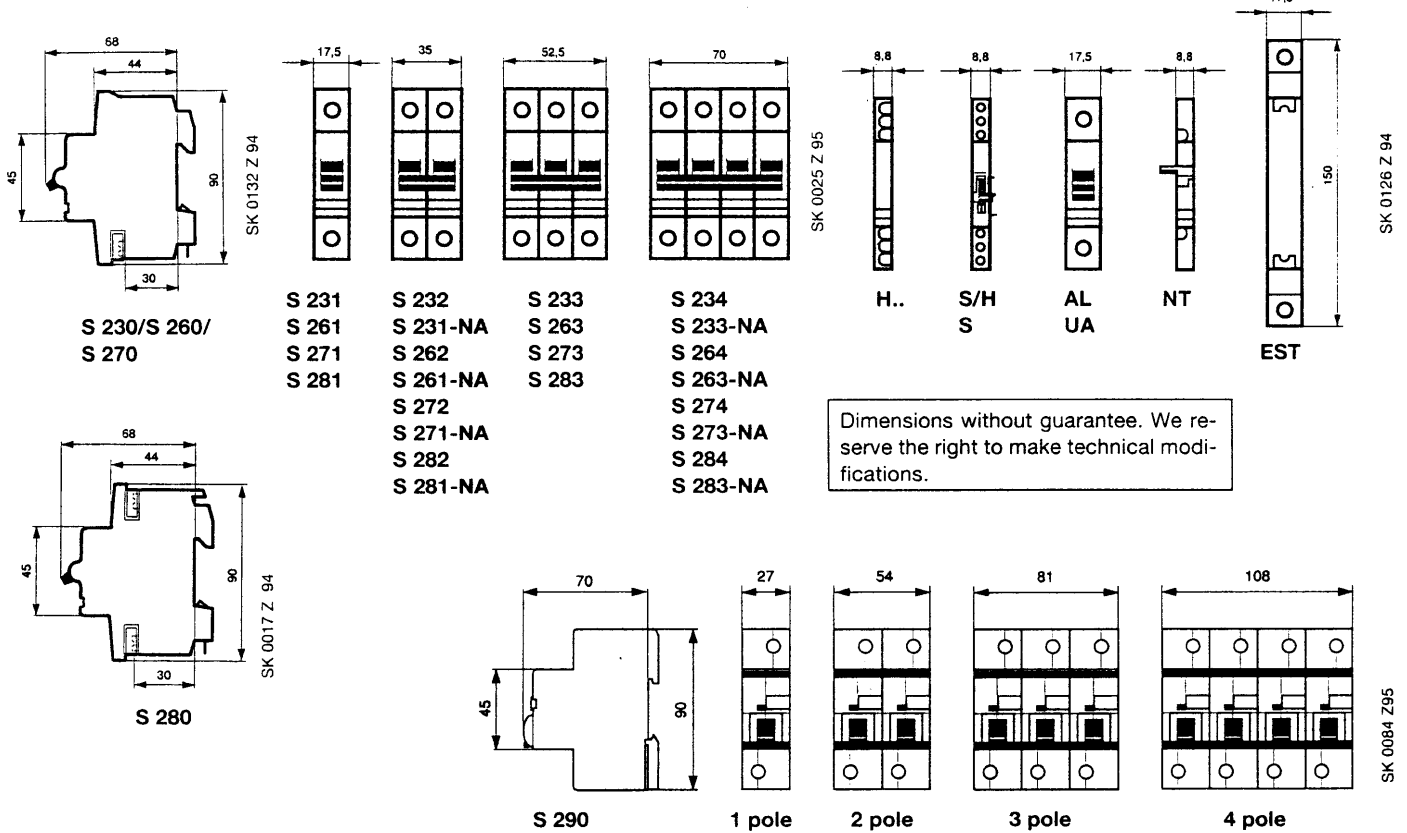

Terminal covers

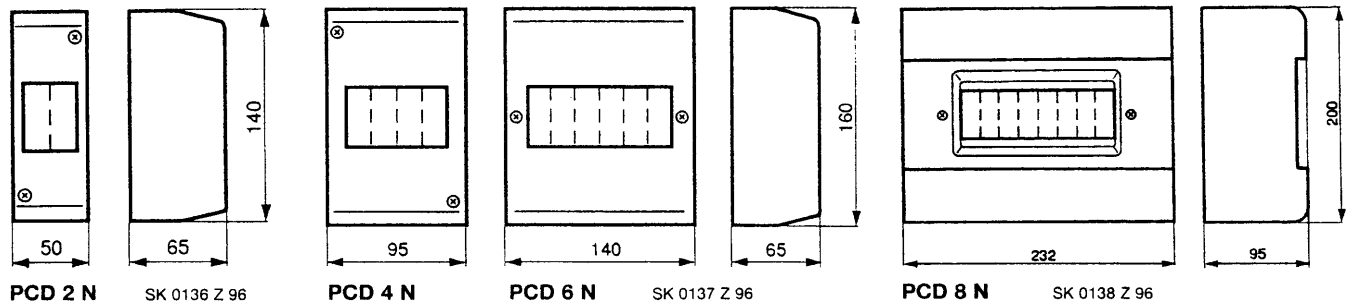

Busbar adapter

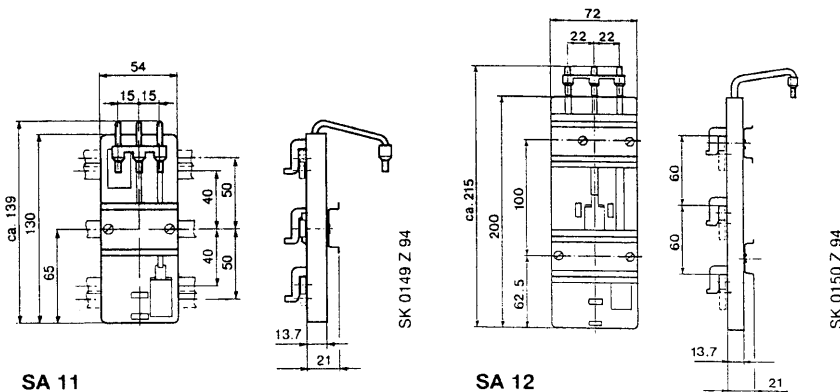

Enclosure of moulded plastic

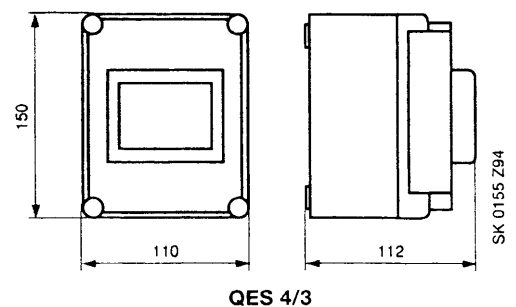

Mounting plates

Extended flat terminals

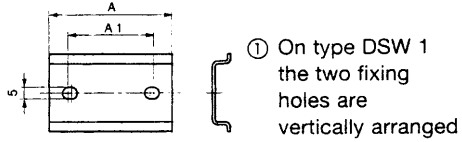

SK 0150 Z 93

Type	A	A1
DSW 1 ①	17.5	15
DSW 2	35	20
DSW 3	52.5	37.5
DSW 4	70	55
DSW 6	105	90

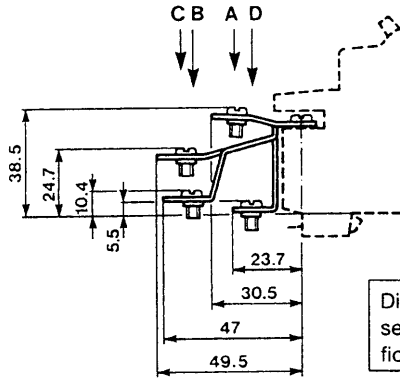

SK 0148 Z 94

Dimensions without guarantee. We reserve the right to make technical modifications.

Flush frame

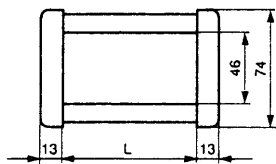

S 500 - ME

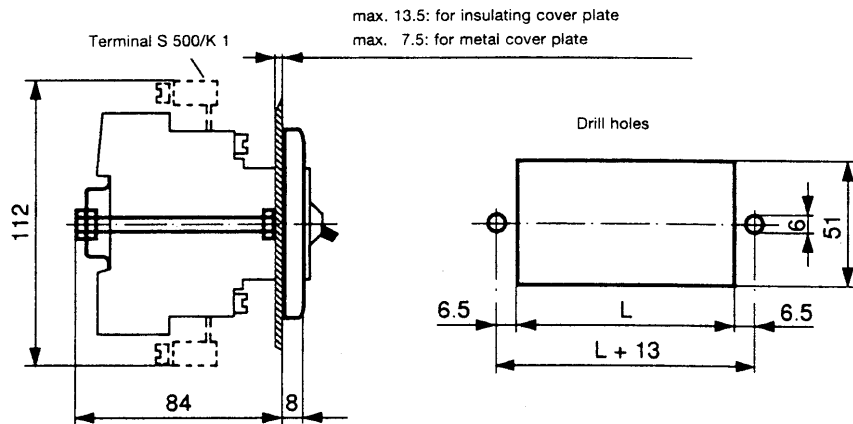

SK 0131 Z 94

Technical Data

Busbar material:	SF-Cu							
Insulation material:	Plastic, temperature resistant $\geq 90\text{ }^\circ\text{C}$ non inflammable, self extinguishing							
Cross sections of busbars:	10, 12, 16, 20, 24 and 36 mm ²							
Rated voltage:	440 V							
Insulation voltage:	> 3 kV							
Max. short.circuit capacity:	25 kA							
Climatic resistance:	acc. to DIN 40 046 resp. IEC 68-2 Constant climate: 23/83; 40/93; 55/20 Changing climate: 25/85; 40/93 [$^\circ\text{C}/\text{RH}$]							
Standards:	DIN VDE 0606 (wiring material) DIN VDE 0606 part 504 (consumer units)							
Max. busbar current I_B /Phase depending on cross section of busbar:	<table border="0"> <tr> <td>10 mm²: 50 A</td> <td rowspan="6">} per branch</td> </tr> <tr> <td>12 mm²: 55 A</td> </tr> <tr> <td>16 mm²: 65 A</td> </tr> <tr> <td>20 mm²: 75 A</td> </tr> <tr> <td>24 mm²: 85 A</td> </tr> <tr> <td>36 mm²: 110 A</td> </tr> </table>	10 mm ² : 50 A	} per branch	12 mm ² : 55 A	16 mm ² : 65 A	20 mm ² : 75 A	24 mm ² : 85 A	36 mm ² : 110 A
10 mm ² : 50 A	} per branch							
12 mm ² : 55 A								
16 mm ² : 65 A								
20 mm ² : 75 A								
24 mm ² : 85 A								
36 mm ² : 110 A								

Maximum load depending on supply connection point

Cross section of busbar	mm ²	Comb-busbars						Busbar blocks					
		10	12	16	20	24	36	10	12	16	20	24	36
① max. supply current I_S / Phase	A	50	55	-	75	85	110	50	-	65	-	-	-
Connection cross section	mm ²	10	16	-	25	25	35	10	-	16	-	-	-
② max. supply current I_S / Phase	A	100	110	-	150 ^{*)}	170 ^{*)}	220 ^{*)}	110	-	130 ^{*)}	-	-	-
Connection cross section	mm ²	25	35	-	2 x 25	2 x 25	2 x 35	25	-	35	-	-	-

① Supply connection at the end of the busbar

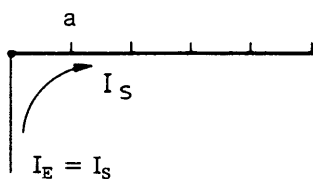

SK 0062 Z 91

② Supply connection along the busbar or at the centre

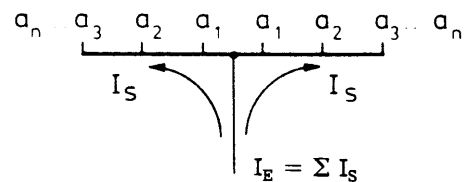

SK 0063 Z 91

*) If supply connection is at the centre via the M.C.B.-terminals, care has to be taken that the max. current for each supply point does not exceed the values as stated by the manufacturers. For example: for STOTZ-M.C.B.'s of ranges S 240, S 260 and S 270: max. 110 A, for M.C.B.'s S 280 range: max. 140 A.

Further care has to be taken that the sum of each branch currents $a_1 \dots a_n$, does not exceed the max. busbar load I_B / Phase, mentioned in above table.

Miniature Circuit Breaker Comb-busbars and busbar blocks

System pro M

Dimensions in mm

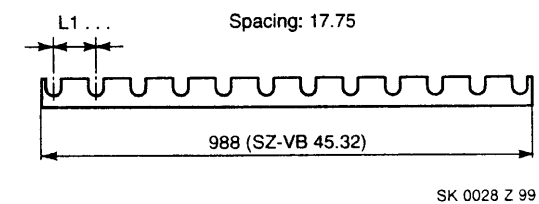
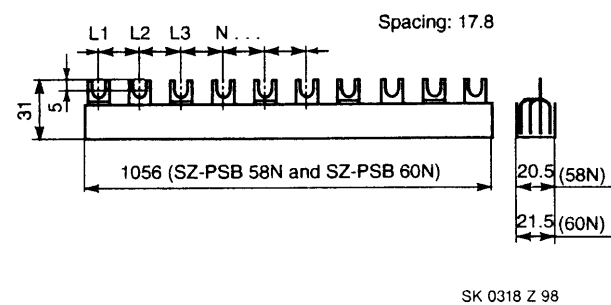
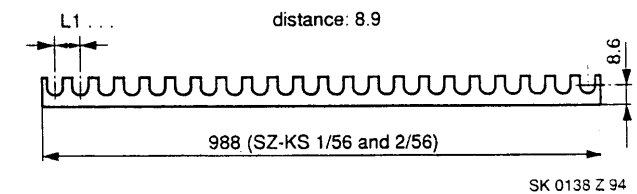
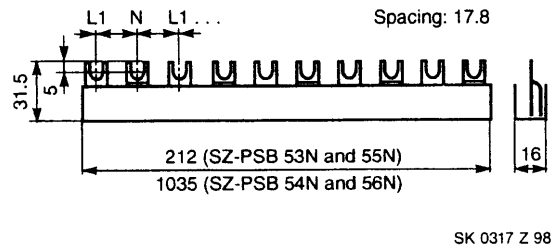
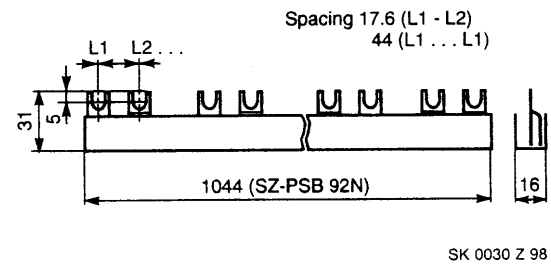
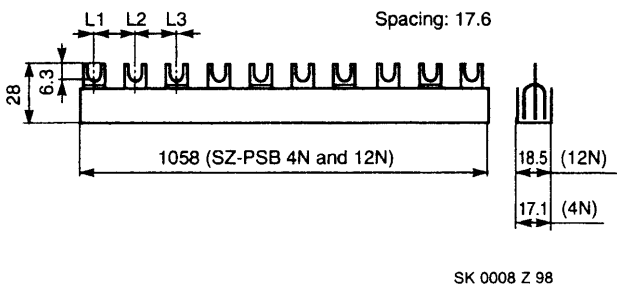
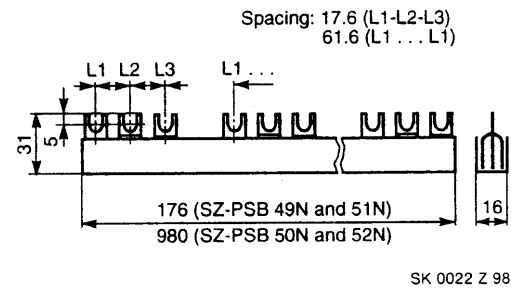
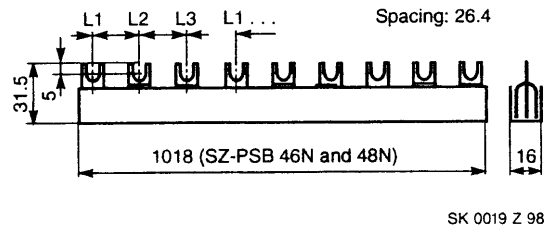
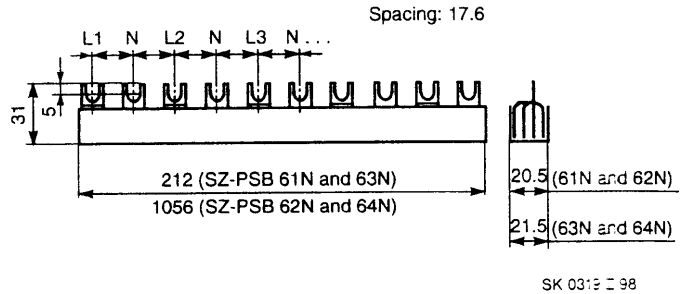
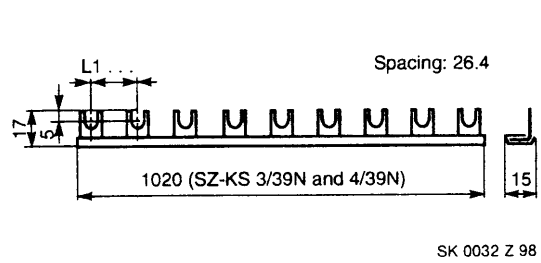



Approvals and certifications by classification societies Miniature Circuit Breakers

Type valid for Sign of conformity Symbol	Approvals										Ship classification associations								
	CH SEV	DK DEMKO	N NEMKO	S SEMKO	SF EL	CDN CSA inspect.	USA UL	NL KEMA KEMA	A OVE	B CEBEC	F UTE	D VDE	PL BBJ	CZ EZU	GOST	F BV	D GL	GB LRS	N DNV
S 230																			
S 260, B, C 1 - 4 pol.	■	■	○	■	■		■	■	■	■	■	■	■	■	■	■	■	■	■
S 260, B, C 1 + 3 pol. + NA	■	■	○	■	■	S 277/480 V AC, B, C		■	■	■	■	■	■	■					
S 270, B, C 1 - 4 pol.	■	■	○	■	○		■	■	■	■	■	■	■	■	■	■	■	■	■
S 270, B, C 1 + 3pol. + NA	■	■	○	■	○		■	■	■	■	■	■	■	■	■	■	■	■	■
S 270, K 1 - 3pol	■		■	■	■	S 277/480 V AC, K, Z		■	■	■	■	■	■	■	■	■	■	■	■
S 280, B, C 1 - 4 pol.	■	■	○	■	○		■	■	■	■	■	■	■	■	■	■	■	■	■
S 280, B, C 1 + 3pol. + NA	■	■	○	■	○		■	■	■	■	■	■	■	■	■	■	■	■	■
S 280, K 1 - 4 pol.	■			■	■														
S 280, Z 1 - 4pol.	■					S 277/480 V AC													
S 280 UC, K, Z 1 + 2 pol.																			
S 280 UC - B 1 + 2 pol.																			
S 290, C																			

on request

Approved
 Submitted for approval / planned to be submitted
 Approved variants on request
 Approval not required

Selection table

No. of poles	Rated current I _n A	Ordering details		bbn 40 16779 EAN	Price 1 piece DM	Price group	Weight 1 piece kg	Pack. unit pcs.
		Type No.	Order code					
1	6	S 231-B 6	GH S2311001 R0065	01550 9			0.110	10/40
	10	S 231-B 10	GH S231 0001 R0105	01560 8				
	16	S 231-B 16	GH S231 0001 R0165	01580 6				
	20	S 231-B 20	GH S231 0001 R0205	01590 5				
	25	S 231-B 25	GH S231 0001 R0255	01600 1				
	U _{Bmax} 440 V ~ 60 V ∴	32	S 231-B 32	GH S231 0001 R0325				
	40	S 231-B 40	GH S231 0001 R0405	01620 9				
2	6	S 232-B 6	GH S2321001 R0065	01760 2			0.250	5/20
	10	S 232-B 10	GH S232 0001 R0105	01770 1				
	16	S 232-B 16	GH S232 0001 R0165	01790 9				
	20	S 232-B 20	GH S232 0001 R0205	01800 5				
	25	S 232-B 25	GH S232 0001 R0255	01810 4				
	U _{Bmax} 440 V ~ 110 V ∴	32	S 232-B 32	GH S232 0001 R0325				
	40	S 232-B 40	GH S232 0001 R0405	01830 2				
3	6	S 233-B 6	GH S233 0001 R0065	01970 5			0.375	3/12
	10	S 233-B 10	GH S233 0001 R0105	01980 4				
	16	S 233-B 16	GH S233 0001 R0165	02000 8				
	20 ①	S 233-B 20	GH S233 0001 R0205	02010 7				
	25	S 233-B 25	GH S233 0001 R0255	02020 6				
	U _{Bmax} 440 V ~	32 ②	S 233-B 32	GH S233 0001 R0325				
	40 ③	S 233-B 40	GH S233 0001 R0405	02040 4				

- ① suitable for continuous flow water heater 12 kW
- ② suitable for continuous flow water heater 18 kW
- ③ suitable for continuous flow water heater 21, 24 and 27 kW

Selection table

No. of poles	Rated current I _n A	Ordering details		bbn 40 16779 EAN	Price 1 piece DM	Price group	Weight 1 piece kg	Pack. unit pcs.
		Type No.	Order code					
1	6	S 231-C 6	GH S2311001 R0064	01440 5			0.110	10/40
	10	S 231-C 10	GH S231 0001 R0104	01460 1				
	16	S 231-C 16	GH S231 0001 R0164	01480 9				
	20	S 231-C 20	GH S231 0001 R0204	01490 8				
	25	S 231-C 25	GH S231 0001 R0254	01500 4				
	U _{Bmax} 440 V ~ 60 V ∴	32	S 231-C 32	GH S231 0001 R0324				
	40	S 231-C 40	GH S231 0001 R0404	01520 2				
2	6	S 232-C 6	GH S232 0001 R0064	01650 6			0.250	5/20
	10	S 232-C 10	GH S232 0001 R0104	01670 4				
	16	S 232-C 16	GH S232 0001 R0164	01690 2				
	20	S 232-C 20	GH S232 0001 R0204	01700 8				
	25	S 232-C 25	GH S232 0001 R0254	01710 7				
	U _{Bmax} 440 V ~ 110 V ∴	32	S 232-C 32	GH S232 0001 R0324				
④	40	S 232-C 40	GH S232 0001 R0404	01730 5				
3	6	S 233-C 6	GH S233 0001 R0064	01860 9			0.375	3/12
	10	S 233-C 10	GH S233 0001 R0104	01880 7				
	16	S 233-C 16	GH S233 0001 R0164	01900 2				
	20 ①	S 233-C 20	GH S233 0001 R0204	01910 1				
	25	S 233-C 25	GH S233 0001 R0254	01920 0				
	U _{Bmax} 440 V ~	32 ②	S 233-C 32	GH S233 0001 R0324				
	40 ③	S 233-C 40	GH S233 0001 R0404	01940 8				

- ① suitable for continuous flow water heater 12 kW
- ② suitable for continuous flow water heater 18 kW
- ③ suitable for continuous flow water heater 21, 24 and 27 kW
- ④ U_{Bmax} 110 V ∴ with 2 poles connected in series

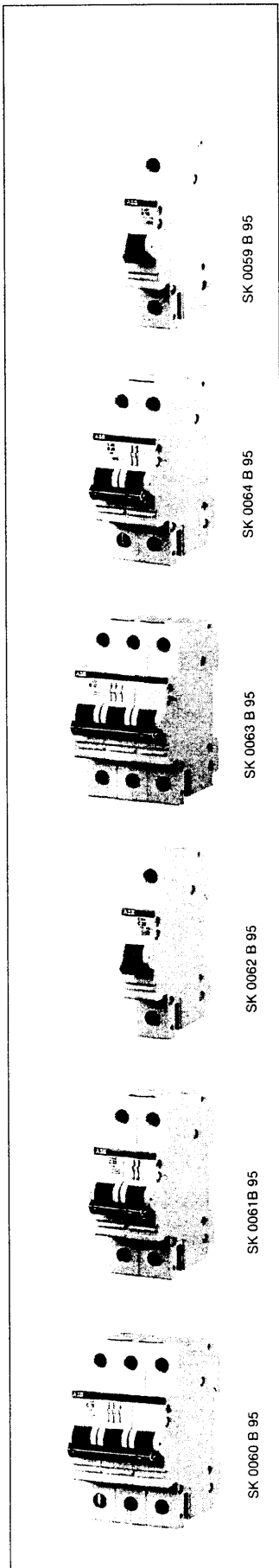

Selection table

No. of poles	Rated current I _n A	Ordering details		bbn 40 12233 EAN	Price 1 piece DM	Price group	Weight 1 piece kg	Pack. unit pcs.	
		Type No.	Order code						
1	6	S 261-B 6	GH S261 0001 R0065	34130 6			0.125	10/40	
	10	S 261-B 10	GH S261 0001 R0105	34170 2					
	13	S 261-B 13	GH S261 0001 R0135	34190 0					
	16 *	S 261-B 16	GH S261 0001 R0165	34220 4					
	16 **	S 261-B 16	GH S261 0001 R1165	34400 0					
	20 ①	S 261-B 20	GH S261 0001 R0205	34250 1					
	25	S 261-B 25	GH S261 0001 R0255	34280 8					
	32 ②	S 261-B 32	GH S261 0001 R0325	34300 3					
	U _{Bmax} 440 V ~	40 ③	S 261-B 40	GH S261 0001 R0405	34330 0				
	60 V ~	50	S 261-B 50	GH S261 0001 R0505	34350 8				
	63	S 261-B 63	GH S261 0001 R0635	34370 6					
									0.145
	2	6	S 262-B 6	GH S262 0001 R0065	35060 5				
10		S 262-B 10	GH S262 0001 R0105	35100 8					
13		S 262-B 13	GH S262 0001 R0135	35120 6					
16		S 262-B 16	GH S262 0001 R0165	35150 3					
20		S 262-B 20	GH S262 0001 R0205	35180 0					
25		S 262-B 25	GH S262 0001 R0255	35210 4					
32		S 262-B 32	GH S262 0001 R0325	35240 1					
U _{Bmax} 440 V ~		40	S 262-B 40	GH S262 0001 R0405	35260 9				
125 V ~		50	S 262-B 50	GH S262 0001 R0505	35280 7				
④		63	S 262-B 63	GH S262 0001 R0635	35300 2				
							0.290		
3		6	S 263-B 6	GH S263 0001 R0065	35620 1			0.375	3/12
	10	S 263-B 10	GH S263 0001 R0105	35660 7					
	13	S 263-B 13	GH S263 0001 R0135	35680 5					
	16	S 263-B 16	GH S263 0001 R0165	35710 9					
	20 ①	S 263-B 20	GH S263 0001 R0205	35740 6					
	25	S 263-B 25	GH S263 0001 R0255	35770 3					
	32 ②	S 263-B 32	GH S263 0001 R0325	35800 7					
	U _{Bmax} 440 V ~	40 ③	S 263-B 40	GH S263 0001 R0405	35820 5				
		50	S 263-B 50	GH S263 0001 R0505	35840 3				
		63	S 263-B 63	GH S263 0001 R0635	35860 1				
							0.435		
	4	6	S 264-B 6	GH S264 0001 R0065	72060 6				
10		S 264-B 10	GH S264 0001 R0105	72070 5					
13		S 264-B 13	GH S264 0001 R0135	75810 4					
16		S 264-B 16	GH S264 0001 R0165	67310 0					
20		S 264-B 20	GH S264 0001 R0205	72080 4					
25		S 264-B 25	GH S264 0001 R0255	67320 9					
32		S 264-B 32	GH S264 0001 R0325	67330 8					
U _{Bmax} 440 V ~		40	S 264-B 40	GH S264 0001 R0405	72120 7				
125 V ~		50	S 264-B 50	GH S264 0001 R0505	67340 7				
		63	S 264-B 63	GH S264 0001 R0635	67350 6				
							0.580		

- ① Suitable for continuous flow water heater 12 kW
- ② Suitable for continuous flow water heater 18 kW
- ③ Suitable for continuous flow water heater 21, 24 and 27 kW
- ④ U_{Bmax} 125 V ~ with 2 poles connected in series
- ⑤ large pack B 16 = 5000 pieces
- * only suitable for addition of auxiliary contacts S2-H... or S2-H...X
- ** suitable for addition of all supplementary add on devices

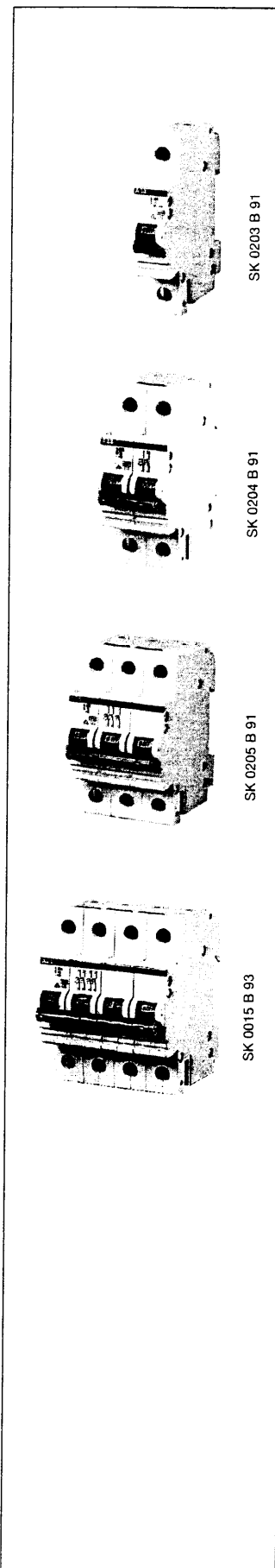

M.C.B.'s with disconnecting neutral NA

No. of poles	Rated current I_n A	Ordering details		bbn 40 12233 EAN	Price 1 piece DM	Price group	Weight 1 piece kg	Pack. unit pcs.
		Type No.	Order code					
1 + NA	6	S 261-B 6 NA	GH S261 0103 R0065	34660 8			0.250	5
	10	S 261-B 10 NA	GH S261 0103 R0105	34680 6				
	13	S 261-B 13 NA	GH S261 0103 R0135	34690 5				
	16	S 261-B 16 NA	GH S261 0103 R0165	34710 0				
	20 ①	S 261-B 20 NA	GH S261 0103 R0205	34730 8				
	25	S 261-B 25 NA	GH S261 0103 R0255	34750 6				
	32 ②	S 261-B 32 NA	GH S261 0103 R0325	34760 5				
	40 ③	S 261-B 40 NA	GH S261 0103 R0405	34780 3				
	50	S 261-B 50 NA	GH S261 0103 R0505	65750 6				
	63	S 261-B 63 NA	GH S261 0103 R0635	65760 5				
U_{Bmax} 440 V ~ 60 V -							0.290	
3 + NA	6	S 263-B 6 NA	GH S263 0103 R0065	36130 4			0.500	2
	10	S 263-B 10 NA	GH S263 0103 R0105	36150 2				
	13	S 263-B 13 NA	GH S263 0103 R0135	36160 1				
	16	S 263-B 16 NA	GH S263 0103 R0165	36180 9				
	20 ①	S 263-B 20 NA	GH S263 0103 R0205	36200 4				
	25	S 263-B 25 NA	GH S263 0103 R0255	36220 2				
	32 ②	S 263-B 32 NA	GH S263 0103 R0325	36240 0				
	40 ③	S 263-B 40 NA	GH S263 0103 R0405	36250 9				
	50	S 263-B 50 NA	GH S263 0103 R0505	65770 4				
	63	S 263-B 63 NA	GH S263 0103 R0635	65780 3				
U_{Bmax} 440 V ~							0.560	

- ① Suitable for continuous flow water heater 12 kW
- ② Suitable for continuous flow water heater 18 kW
- ③ Suitable for continuous flow water heater 21, 24 and 27 kW

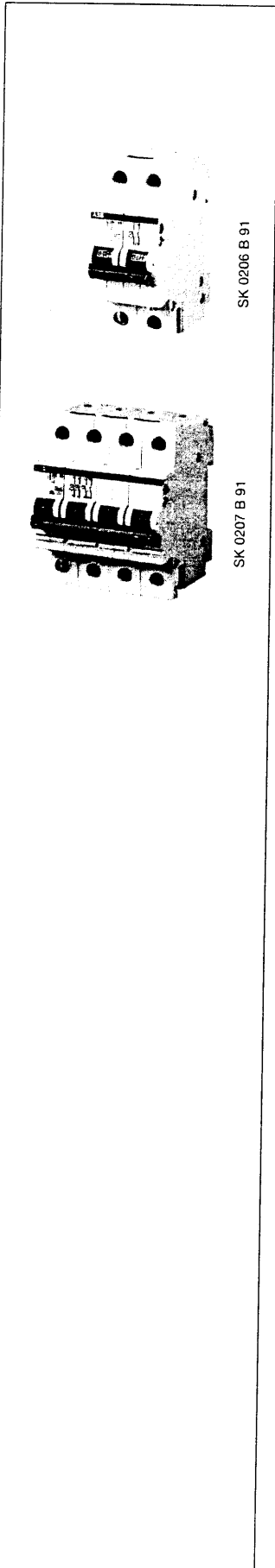

Selection table

No. of poles	Rated current I_n A	Ordering details		bbn 40 12233 EAN	Price 1 piece DM	Price group	Weight 1 piece kg	Pack. unit pcs.					
		Type No.	Order code										
1	0.5	S 261-C 0.5	GH S261 0001 R0984	34390 4			0.125	10/40					
	1	S 261-C 1	GH S261 0001 R0014	34070 5									
	1.6	S 261-C 1.6	GH S261 0001 R0974	34380 5									
	2	S 261-C 2	GH S261 0001 R0024	34080 4									
	3	S 261-C 3	GH S261 0001 R0034	34090 3									
	4	S 261-C 4	GH S261 0001 R0044	34100 9									
	6	S 261-C 6	GH S261 0001 R0064	34120 7									
	8	S 261-C 8	GH S261 0001 R0084	34140 5									
	10	S 261-C 10	GH S261 0001 R0104	34160 3									
	13	S 261-C 13	GH S261 0001 R0134	34180 1									
	16	S 261-C 16	GH S261 0001 R0164	34210 5									
	20 ①	S 261-C 20	GH S261 0001 R0204	34240 2									
	25	S 261-C 25	GH S261 0001 R0254	34270 9									
	32 ②	S 261-C 32	GH S261 0001 R0324	34290 7									
	40 ③	S 261-C 40	GH S261 0001 R0404	34320 1									
	U_{Bmax} 440 V ~ 60 V ∴	50	S 261-C 50	GH S261 0001 R0504					34340 9			0.145	
		63	S 261-C 63	GH S261 0001 R0634					34360 7				
	2	0.5	S 262-C 0.5	GH S262 0001 R0984					35320 0			0.250	5/20
		1	S 262-C 1	GH S262 0001 R0014					35000 1				
1.6		S 262-C 1.6	GH S262 0001 R0974	35310 1									
2		S 262-C 2	GH S262 0001 R0024	35010 0									
3		S 262-C 3	GH S262 0001 R0034	35020 9									
4		S 262-C 4	GH S262 0001 R0044	35030 8									
6		S 262-C 6	GH S262 0001 R0064	35050 6									
8		S 262-C 8	GH S262 0001 R0084	35070 4									
10		S 262-C 10	GH S262 0001 R0104	35090 2									
13		S 262-C 13	GH S262 0001 R0134	35110 7									
16		S 262-C 16	GH S262 0001 R0164	35140 4									
20		S 262-C 20	GH S262 0001 R0204	35170 1									
25		S 262-C 25	GH S262 0001 R0254	35200 5									
32		S 262-C 32	GH S262 0001 R0324	35230 2									
40		S 262-C 40	GH S262 0001 R0404	35250 0									
U_{Bmax} 440 V ~ 125 V ∴ ④		50	S 262-C 50	GH S262 0001 R0504	35270 8			0.290					
		63	S 262-C 63	GH S262 0001 R0634	35290 6								
3		0.5	S 263-C 0.5	GH S263 0001 R0984	35880 9			0.375	3/12				
		1	S 263-C 1	GH S263 0001 R0014	35560 0								
	1.6	S 263-C 1.6	GH S263 0001 R0974	35870 0									
	2	S 263-C 2	GH S263 0001 R0024	35570 9									
	3	S 263-C 3	GH S263 0001 R0034	35580 8									
	4	S 263-C 4	GH S263 0001 R0044	35590 7									
	6	S 263-C 6	GH S263 0001 R0064	35610 2									
	8	S 263-C 8	GH S263 0001 R0084	35630 0									
	10	S 263-C 10	GH S263 0001 R0104	35650 8									
	13	S 263-C 13	GH S263 0001 R0134	35670 6									
	16	S 263-C 16	GH S263 0001 R0164	35700 0									
	20 ①	S 263-C 20	GH S263 0001 R0204	35730 7									
	25	S 263-C 25	GH S263 0001 R0254	35760 4									
	32 ②	S 263-C 32	GH S263 0001 R0324	35790 1									
	40 ③	S 263-C 40	GH S263 0001 R0404	35810 6									
	U_{Bmax} 440 V ~	50	S 263-C 50	GH S263 0001 R0504	35830 4							0.435	
		63	S 263-C 63	GH S263 0001 R0634	35850 2								

- ① Suitable for continuous flow water heater 12 kW
- ② Suitable for continuous flow water heater 18 kW
- ③ Suitable for continuous flow water heater 21, 24 and 27 kW
- ④ U_{Bmax} 125 V ∴ with 2 poles connected in series

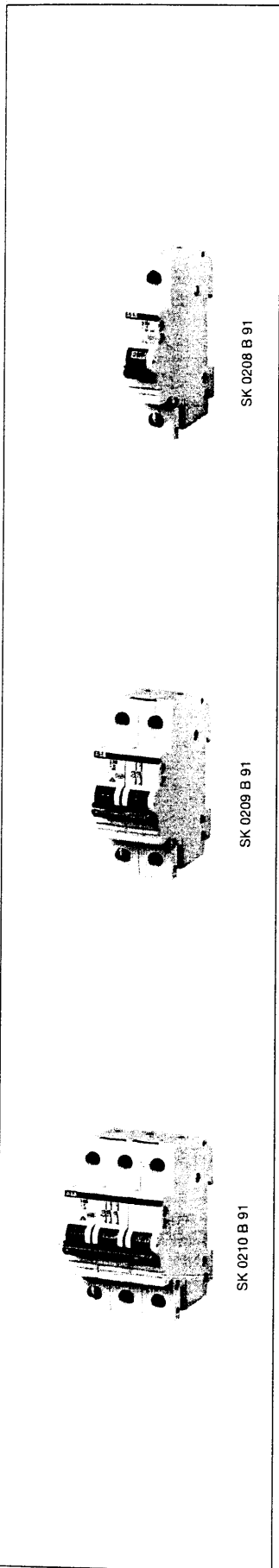

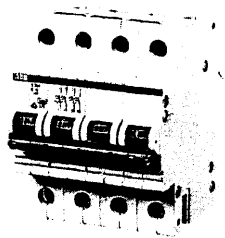

SK 0016 B 93

No. of poles	Rated current I_n A	Ordering details		bbn 40 12233 EAN	Price 1 piece DM	Price group	Weight 1 piece kg	Pack. unit pcs.
		Type No.	Order code					
4	0.5	S 264-C 0.5	GH S264 0001 R0984	75830 2			0.500	2
	1	S 264-C 1	GH S264 0001 R0014	73460 3				
	1.6	S 264-C 1.6	GH S264 0001 R0974	73470 2				
	2	S 264-C 2	GH S264 0001 R0024	67360 5				
	3	S 264-C 3	GH S264 0001 R0034	67370 4				
	4	S 264-C 4	GH S264 0001 R0044	67380 3				
	6	S 264-C 6	GH S264 0001 R0064	67390 2				
	8	S 264-C 8	GH S264 0001 R0084	73480 1				
	10	S 264-C 10	GH S264 0001 R0104	72090 3				
	13	S 264-C 13	GH S264 0001 R0134	73490 0				
	16	S 264-C 16	GH S264 0001 R0164	67400 8				
	20	S 264-C 20	GH S264 0001 R0204	67410 7				
	25	S 264-C 25	GH S264 0001 R0254	72100 9				
	32	S 264-C 32	GH S264 0001 R0324	67420 6				
	40	S 264-C 40	GH S264 0001 R0404	72110 8				
	U_{Bmax} 440 V ~ 125 V --- ④	50	S 264-C 50	GH S264 0001 R0504	36470 1			
63		S 264-C 63	GH S264 0001 R0634	36480 0				

M.C.B.'s with disconnecting neutral NA

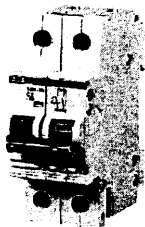

SK 0011 B 93

1 + NA	0.5	S 261-C 0.5 NA	GH S261 0103 R0984	66080 3		0.250	5	
	1	S 261-C 1 NA	GH S261 0103 R0014	66090 2				
	1.6	S 261-C 1.6 NA	GH S261 0103 R0974	66100 8				
	2	S 261-C 2 NA	GH S261 0103 R0024	66110 7				
	3	S 261-C 3 NA	GH S261 0103 R0034	66120 6				
	4	S 261-C 4 NA	GH S261 0103 R0044	66130 5				
	6	S 261-C 6 NA	GH S261 0103 R0064	65910 4				
	8	S 261-C 8 NA	GH S261 0103 R0084	66140 4				
	10	S 261-C 10 NA	GH S261 0103 R0104	65920 3				
	13	S 261-C 13 NA	GH S261 0103 R0134	65930 2				
	16	S 261-C 16 NA	GH S261 0103 R0164	65940 1				
	20 ①	S 261-C 20 NA	GH S261 0103 R0204	65950 0				
	25	S 261-C 25 NA	GH S261 0103 R0254	65960 9				
	32 ②	S 261-C 32 NA	GH S261 0103 R0324	65970 8				
	40 ③	S 261-C 40 NA	GH S261 0103 R0404	65980 7				
	U_{Bmax} 440 V ~ 60 V ---	50	S 261-C 50 NA	GH S261 0103 R0504	67430 5			
63		S 261-C 63 NA	GH S261 0103 R0634	67440 4				

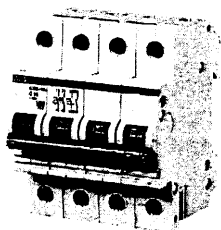

SK 0003 B 93

3 + NA	0.5	S 263-C 0.5 NA	GH S263 0103 R0984	66150 3		0.500	2	
	1	S 263-C 1 NA	GH S263 0103 R0014	66160 2				
	1.6	S 263-C 1.6 NA	GH S263 0103 R0974	66170 1				
	2	S 263-C 2 NA	GH S263 0103 R0024	66180 0				
	3	S 263-C 3 NA	GH S263 0103 R0034	66190 9				
	4	S 263-C 4 NA	GH S263 0103 R0044	66200 5				
	6	S 263-C 6 NA	GH S263 0103 R0064	65990 6				
	8	S 263-C 8 NA	GH S263 0103 R0084	66210 4				
	10	S 263-C 10 NA	GH S263 0103 R0104	66010 0				
	13	S 263-C 13 NA	GH S263 0103 R0134	66020 9				
	16	S 263-C 16 NA	GH S263 0103 R0164	66030 8				
	20 ①	S 263-C 20 NA	GH S263 0103 R0204	66040 7				
	25	S 263-C 25 NA	GH S263 0103 R0254	66050 6				
	32 ②	S 263-C 32 NA	GH S263 0103 R0324	66060 5				
	40 ③	S 263-C 40 NA	GH S263 0103 R0404	66070 4				
	U_{Bmax} 440 V ~	50	S 263-C 50 NA	GH S263 0103 R0504	67450 3			
63		S 263-C 63 NA	GH S263 0103 R0634	67460 2				

- ① Suitable for continuous flow water heater 12 kW
- ② Suitable for continuous flow water heater 18 kW
- ③ Suitable for continuous flow water heater 21, 24 and 27 kW
- ④ U_{Bmax} 125 V --- with 2 poles connected in series

Selection table

No. of poles	Rated current I_n , A	Ordering details		bbn 40 12233 EAN	Price 1 piece DM	Price group	Weight 1 piece kg	Pack. unit pcs.					
		Type No.	Order code										
1	0.5	S 261-D 0.5	GH S261 0001 R0981	67470 1			0.125	10/40					
	1	S 261-D 1	GH S261 0001 R0011	67480 0									
	1.6	S 261-D 1.6	GH S261 0001 R0971	67490 9									
	2	S 261-D 2	GH S261 0001 R0021	67500 5									
	3	S 261-D 3	GH S261 0001 R0031	67510 4									
	4	S 261-D 4	GH S261 0001 R0041	67520 3									
	6	S 261-D 6	GH S261 0001 R0061	67530 2									
	8	S 261-D 8	GH S261 0001 R0081	67540 1									
	10	S 261-D 10	GH S261 0001 R0101	67550 0									
	13	S 261-D 13	GH S261 0001 R0131	76030 5									
	16	S 261-D 16	GH S261 0001 R0161	67560 9									
	20	S 261-D 20	GH S261 0001 R0201	67570 8									
	25	S 261-D 25	GH S261 0001 R0251	67580 7									
	32	S 261-D 32	GH S261 0001 R0321	67600 2									
	40	S 261-D 40	GH S261 0001 R0401	67610 1									
	U_{Bmax} 440 V ~	50	S 261-D 50	GH S261 0001 R0501					67620 0				
	60 V ∴	63	S 261-D 63	GH S261 0001 R0631					67630 9				
	2	0.5	S 262-D 0.5	GH S262 0001 R0981					67640 8			0.250	5/20
		1	S 262-D 1	GH S262 0001 R0011					67650 7				
1.6		S 262-D 1.6	GH S262 0001 R0971	67660 6									
2		S 262-D 2	GH S262 0001 R0021	67670 5									
3		S 262-D 3	GH S262 0001 R0031	67680 4									
4		S 262-D 4	GH S262 0001 R0041	67690 3									
6		S 262-D 6	GH S262 0001 R0061	67700 9									
8		S 262-D 8	GH S262 0001 R0081	67710 8									
10		S 262-D 10	GH S262 0001 R0101	67720 7									
13		S 262-D 13	GH S262 0001 R0131	76040 4									
16		S 262-D 16	GH S262 0001 R0161	67730 6									
20		S 262-D 20	GH S262 0001 R0201	67740 5									
25		S 262-D 25	GH S262 0001 R0251	67750 4									
32		S 262-D 32	GH S262 0001 R0321	67760 3									
40		S 262-D 40	GH S262 0001 R0401	67770 2									
U_{Bmax} 440 V ~		50	S 262-D 50	GH S262 0001 R0501	67780 1								
125 V ∴		63	S 262-D 63	GH S262 0001 R0631	67790 0								
3		0.5	S 263-D 0.5	GH S263 0001 R0981	67800 6			0.375	3/12				
		1	S 263-D 1	GH S263 0001 R0011	67810 5								
	1.6	S 263-D 1.6	GH S263 0001 R0971	67820 4									
	2	S 263-D 2	GH S263 0001 R0021	67830 3									
	3	S 263-D 3	GH S263 0001 R0031	67860 0									
	4	S 263-D 4	GH S263 0001 R0041	67870 9									
	6	S 263-D 6	GH S263 0001 R0061	67880 8									
	8	S 263-D 8	GH S263 0001 R0081	67890 7									
	10	S 263-D 10	GH S263 0001 R0101	67850 1									
	13	S 263-D 13	GH S263 0001 R0131	76050 3									
	16	S 263-D 16	GH S263 0001 R0161	67900 3									
	20	S 263-D 20	GH S263 0001 R0201	67910 2									
	25	S 263-D 25	GH S263 0001 R0251	67920 1									
	32	S 263-D 32	GH S263 0001 R0321	67930 0									
	40	S 263-D 40	GH S263 0001 R0401	67940 9									
	U_{Bmax} 440 V ~	50	S 263-D 50	GH S263 0001 R0501	67950 8								
		63	S 263-D 63	GH S263 0001 R0631	67840 2								

① U_{Bmax} 125 V ∴ with 2 poles connected in series



SK 0012 B 93

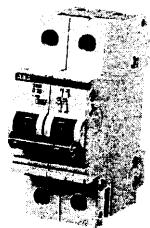

SK 0013 B 93

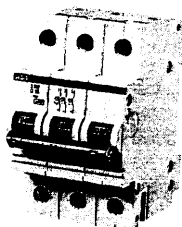

SK 0014 B 93

Selection table

No. of poles	Rated current I_n , A	Ordering details		bbn 40 12233 EAN	Price 1 piece DM	Price group	Weight 1 piece kg	Pack. unit pcs.
		Type No.	Order code					
4	0.5	S 264-D 0.5	GH S264 0001 R0981	67960 7			0.500	2
	1	S 264-D 1	GH S264 0001 R0011	67980 5				
	1.6	S 264-D 1.6	GH S264 0001 R0971	67970 6				
	2	S 264-D 2	GH S264 0001 R0021	67990 4				
	3	S 264-D 3	GH S264 0001 R0031	68000 9				
	4	S 264-D 4	GH S264 0001 R0041	68010 8				
	6	S 264-D 6	GH S264 0001 R0061	68020 7				
	8	S 264-D 8	GH S264 0001 R0081	68030 6				
	10	S 264-D 10	GH S264 0001 R0101	68040 5				
	13	S 264-D 13	GH S264 0001 R0131	76060 2				
	16	S 264-D 16	GH S264 0001 R0161	68050 4				
	20	S 264-D 20	GH S264 0001 R0201	68060 3				
	25	S 264-D 25	GH S264 0001 R0251	68070 2				
	32	S 264-D 32	GH S264 0001 R0321	68080 1				
	40	S 264-D 40	GH S264 0001 R0401	68090 0				
U_{Bmax} 440 V ~ 125 V =	50	S 264-D 50	GH S264 0001 R0501	68100 6			0.580	
	① 63	S 264-D 63	GH S264 0001 R0631	68110 5				

M.C.B.'s with disconnecting neutral NA

1 + NA	0.5	S 261-D 0.5 NA	GH S261 0103 R0981	68120 4			0.250	5
	1	S 261-D 1 NA	GH S261 0103 R0011	68140 2				
	1.6	S 261-D 1.6 NA	GH S261 0103 R0971	68130 3				
	2	S 261-D 2 NA	GH S261 0103 R0021	68150 1				
	3	S 261-D 3 NA	GH S261 0103 R0031	68160 0				
	4	S 261-D 4 NA	GH S261 0103 R0041	68170 9				
	6	S 261-D 6 NA	GH S261 0103 R0061	68180 8				
	8	S 261-D 8 NA	GH S261 0103 R0081	68190 7				
	10	S 261-D 10 NA	GH S261 0103 R0101	68200 3				
	13	S 261-D 13 NA	GH S261 0103 R0131	76070 1				
	16	S 261-D 16 NA	GH S261 0103 R0161	68210 2				
	20	S 261-D 20 NA	GH S261 0103 R0201	68220 1				
	25	S 261-D 25 NA	GH S261 0103 R0251	68230 0				
	32	S 261-D 32 NA	GH S261 0103 R0321	68240 9				
	40	S 261-D 40 NA	GH S261 0103 R0401	68250 8				
U_{Bmax} 440 V ~ 60 V =	50	S 261-D 50 NA	GH S261 0103 R0501	68260 7			0.290	
	63	S 261-D 63 NA	GH S261 0103 R0631	68270 6				
3 + NA	0.5	S 263-D 0.5 NA	GH S263 0103 R0981	68280 5			0.500	2
	1	S 263-D 1 NA	GH S263 0103 R0011	68300 0				
	1.6	S 263-D 1.6 NA	GH S263 0103 R0971	68290 4				
	2	S 263-D 2 NA	GH S263 0103 R0021	68310 9				
	3	S 263-D 3 NA	GH S263 0103 R0031	68320 8				
	4	S 263-D 4 NA	GH S263 0103 R0041	68330 7				
	6	S 263-D 6 NA	GH S263 0103 R0061	68340 6				
	8	S 263-D 8 NA	GH S263 0103 R0081	68350 5				
	10	S 263-D 10 NA	GH S263 0103 R0101	68370 3				
	13	S 263-D 13 NA	GH S263 0103 R0131	76080 0				
	16	S 263-D 16 NA	GH S263 0103 R0161	68380 2				
	20	S 263-D 20 NA	GH S263 0103 R0201	68390 1				
	25	S 263-D 25 NA	GH S263 0103 R0251	68400 7				
	32	S 263-D 32 NA	GH S263 0103 R0321	68410 6				
	40	S 263-D 40 NA	GH S263 0103 R0401	68420 5				
U_{Bmax} 440 V ~	50	S 263-D 50 NA	GH S263 0103 R0501	68430 4			0.580	
	63	S 263-D 63 NA	GH S263 0103 R0631	68440 3				

① U_{Bmax} 125 V = with 2 poles connected in series

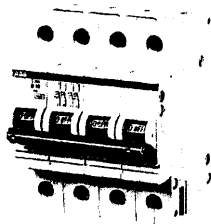

SK 0017 B 93

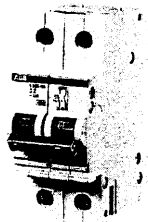

SK 0039 B 93

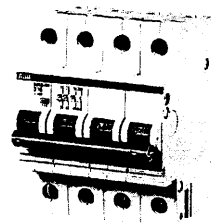

SK 0040 B 93

Selection table

No. of poles	Rated current I_n A	Ordering details		bbn 40 12233 EAN	Price 1 piece DM	Price group	Weight 1 piece kg	Pack. unit pcs.					
		Type No.	Order code										
1	0.5	S 271-K 0.5	GH S271 0001 R0157	36750 4			0.125	10/40					
	1	S 271-K 1	GH S271 0001 R0217	36800 6									
	1.6	S 271-K 1.6	GH S271 0001 R0257	36830 3									
	2	S 271-K 2	GH S271 0001 R0277	36850 1									
	3	S 271-K 3	GH S271 0001 R0317	36870 9									
	4	S 271-K 4	GH S271 0001 R0337	36900 3									
	6	S 271-K 6	GH S271 0001 R0377	36920 1									
	8	S 271-K 8	GH S271 0001 R0407	36940 9									
	10	S 271-K 10	GH S271 0001 R0427	36960 7									
	13	S 271-K 13	GH S271 0001 R0447	36950 0									
	16	S 271-K 16	GH S271 0001 R0467	36980 5									
	20	S 271-K 20	GH S271 0001 R0487	37000 9									
	25	S 271-K 25	GH S271 0001 R0517	37020 7									
	32	S 271-K 32	GH S271 0001 R0537	37040 5									
	40	S 271-K 40	GH S271 0001 R0557	37050 4									
	U_{Bmax} 440 V ~	50	S 271-K 50	GH S271 0001 R0577					37060 3				
	60 V ≍	63	S 271-K 63	GH S271 0001 R0607					37070 2				
	2	0.5	S 272-K 0.5	GH S272 0001 R0157					38630 7			0.250	5/20
		1	S 272-K 1	GH S272 0001 R0217					38670 3				
		1.6	S 272-K 1.6	GH S272 0001 R0257					38700 7				
2		S 272-K 2	GH S272 0001 R0277	38720 5									
3		S 272-K 3	GH S272 0001 R0317	38740 3									
4		S 272-K 4	GH S272 0001 R0337	38770 0									
6		S 272-K 6	GH S272 0001 R0377	38790 8									
8		S 272-K 8	GH S272 0001 R0407	38810 3									
10		S 272-K 10	GH S272 0001 R0427	38830 1									
13		S 272-K 13	GH S272 0001 R0447	96960 9									
16		S 272-K 16	GH S272 0001 R0467	38850 9									
20		S 272-K 20	GH S272 0001 R0487	38870 7									
25		S 272-K 25	GH S272 0001 R0517	38890 5									
32		S 272-K 32	GH S272 0001 R0537	38910 0									
40		S 272-K 40	GH S272 0001 R0557	38920 9									
U_{Bmax} 440 V ~		50	S 272-K 50	GH S272 0001 R0577	38930 8								
125 V ≍		63	S 272-K 63	GH S272 0001 R0607	38940 7								
3		0.5	S 273-K 0.5	GH S273 0001 R0157	39930 7			0.375	3/12				
		1	S 273-K 1	GH S273 0001 R0217	39970 3								
		1.6	S 273-K 1.6	GH S273 0001 R0257	39990 1								
	2	S 273-K 2	GH S273 0001 R0277	40000 3									
	3	S 273-K 3	GH S273 0001 R0317	40010 2									
	4	S 273-K 4	GH S273 0001 R0337	40030 0									
	6	S 273-K 6	GH S273 0001 R0377	40040 9									
	8	S 273-K 8	GH S273 0001 R0407	40050 8									
	10	S 273-K 10	GH S273 0001 R0427	40060 7									
	13	S 273-K 13	GH S273 0001 R0447	96970 8									
	16	S 273-K 16	GH S273 0001 R0467	40070 6									
	20	S 273-K 20	GH S273 0001 R0487	40080 5									
	25	S 273-K 25	GH S273 0001 R0517	40090 4									
	32	S 273-K 32	GH S273 0001 R0537	40100 0									
	40	S 273-K 40	GH S273 0001 R0557	40110 9									
	U_{Bmax} 440 V ~	50	S 273-K 50	GH S273 0001 R0577	40120 8								
		63	S 273-K 63	GH S273 0001 R0607	40130 7								

① U_{Bmax} 125 V ≍ with 2 poles connected in series

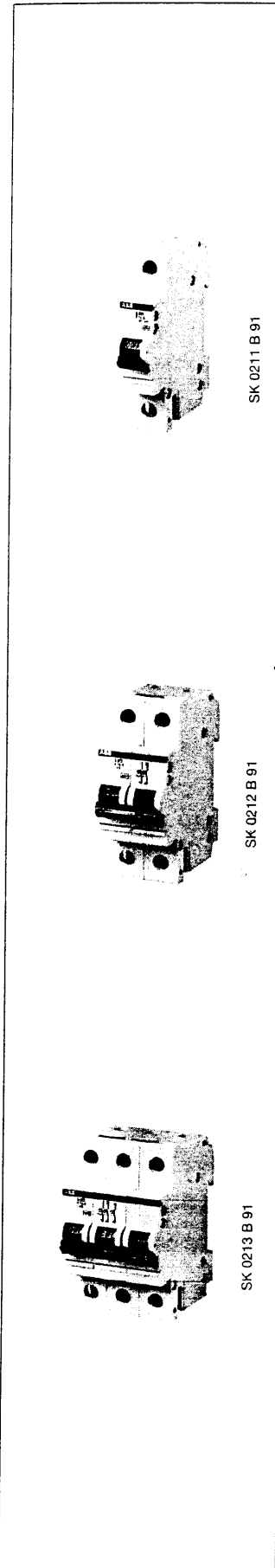

Selection table

No. of poles	Rated current I_n A	Ordering details		bbn 40 12233 EAN	Price 1 piece DM	Price group	Weight 1 piece kg	Pack. unit pcs.
		Type No.	Order code					
4	0.5	S 274-K 0.5	GH S274 0001 R0157	41620 2			0.500	2
	1	S 274-K 1	GH S274 0001 R0217	41650 9				
	1.6	S 274-K 1.6	GH S274 0001 R0257	41670 7				
	2	S 274-K 2	GH S274 0001 R0277	41680 6				
	3	S 274-K 3	GH S274 0001 R0317	41690 5				
	4	S 274-K 4	GH S274 0001 R0337	41710 0				
	6	S 274-K 6	GH S274 0001 R0377	41720 9				
	8	S 274-K 8	GH S274 0001 R0407	41730 8				
	10	S 274-K 10	GH S274 0001 R0427	41727 7				
	13	S 274-K 13	GH S274 0001 R0447	83830 1				
	16	S 274-K 16	GH S274 0001 R0467	41750 6				
	20	S 274-K 20	GH S274 0001 R0487	41760 5				
	25	S 274-K 25	GH S274 0001 R0517	41770 4				
	32	S 274-K 32	GH S274 0001 R0537	41780 3				
	40	S 274-K 40	GH S274 0001 R0557	41790 2				
	50	S 274-K 50	GH S274 0001 R0577	41800 8				
63	S 274-K 63	GH S274 0001 R0607	41810 7					

U_{Bmax}
440 V ~
125 V =
①

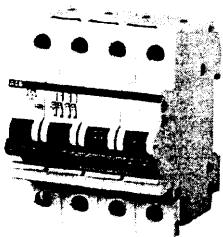

SK 0214 B 91

M.C.B.'s with disconnecting neutral NA

1 + NA	0.5	S 271-K 0.5 NA	GH S271 0103 R0157	37640 7			0.250	5
	1	S 271-K 1 NA	GH S271 0103 R0217	37670 4				
	1.6	S 271-K 1.6 NA	GH S271 0103 R0257	37690 2				
	2	S 271-K 2 NA	GH S271 0103 R0277	37700 8				
	3	S 271-K 3 NA	GH S271 0103 R0317	37710 7				
	4	S 271-K 4 NA	GH S271 0103 R0337	37730 5				
	6	S 271-K 6 NA	GH S271 0103 R0377	37740 4				
	8	S 271-K 8 NA	GH S271 0103 R0407	37750 3				
	10	S 271-K 10 NA	GH S271 0103 R0427	37760 2				
	13	S 271-K 13 NA	GH S271 0103 R0447	96980 7				
	16	S 271-K 16 NA	GH S271 0103 R0467	37770 1				
	20	S 271-K 20 NA	GH S271 0103 R0487	37780 0				
	25	S 271-K 25 NA	GH S271 0103 R0517	37790 9				
	32	S 271-K 32 NA	GH S271 0103 R0537	37800 5				
	40	S 271-K 40 NA	GH S271 0103 R0557	37810 4				
	50	S 271-K 50 NA	GH S271 0103 R0577	65710 0				
63	S 271-K 63 NA	GH S271 0103 R0607	65720 9					
3 + NA	0.5	S 273-K 0.5 NA	GH S273 0103 R0157	40690 6			0.500	2
	1	S 273-K 1 NA	GH S273 0103 R0217	40730 9				
	1.6	S 273-K 1.6 NA	GH S273 0103 R0257	40750 7				
	2	S 273-K 2 NA	GH S273 0103 R0277	40760 6				
	3	S 273-K 3 NA	GH S273 0103 R0317	40770 5				
	4	S 273-K 4 NA	GH S273 0103 R0337	40790 3				
	6	S 273-K 6 NA	GH S273 0103 R0377	40800 9				
	8	S 273-K 8 NA	GH S273 0103 R0407	40810 8				
	10	S 273-K 10 NA	GH S273 0103 R0427	40820 7				
	13	S 273-K 13 NA	GH S273 0103 R0447	96990 6				
	16	S 273-K 16 NA	GH S273 0103 R0467	40830 6				
	20	S 273-K 20 NA	GH S273 0103 R0487	40840 5				
	25	S 273-K 25 NA	GH S273 0103 R0517	40850 4				
	32	S 273-K 32 NA	GH S273 0103 R0537	40860 3				
	40	S 273-K 40 NA	GH S273 0103 R0557	40870 2				
	50	S 273-K 50 NA	GH S273 0103 R0577	65730 8				
63	S 273-K 63 NA	GH S273 0103 R0607	65740 7					

U_{Bmax}
440 V ~
60 V =

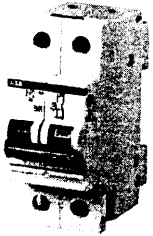

SK 0293 B 91

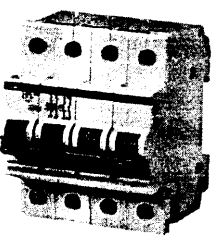

SK 0294 B 91

① U_{Bmax} 125 V = with 2 poles connected in series



Selection table

No. of poles	Rated current I_n A	Ordering details		bbn 40 12233 EAN	Price 1 piece DM	Price group	Weight 1 piece kg	Pack. unit pcs.
		Type No.	Order code					
1	0.5	S 271-Z 0.5	GH S271 0001 R0158	36760 3			0.130	10/40
	1	S 271-Z 1	GH S271 0001 R0218	36810 5				
	1.6	S 271-Z 1.6	GH S271 0001 R0258	36840 2				
	2	S 271-Z 2	GH S271 0001 R0278	36860 0				
	3	S 271-Z 3	GH S271 0001 R0318	36880 8				
	4	S 271-Z 4	GH S271 0001 R0338	36910 2				
	6	S 271-Z 6	GH S271 0001 R0378	36930 0				
	8	S 271-Z 8	GH S271 0001 R0408	36950 8				
	10	S 271-Z 10	GH S271 0001 R0428	36970 6				
	16	S 271-Z 16	GH S271 0001 R0468	36990 4				
	20	S 271-Z 20	GH S271 0001 R0488	37010 8				
	25	S 271-Z 25	GH S271 0001 R0518	37030 6				
	32	S 271-Z 32	GH S271 0001 R0538	65300 3				
	40	S 271-Z 40	GH S271 0001 R0558	65310 2				
	50	S 271-Z 50	GH S271 0001 R0578	65320 1				
	2	0.5	S 272-Z 0.5	GH S272 0001 R0158				
1		S 272-Z 1	GH S272 0001 R0218	38680 2				
1.6		S 272-Z 1.6	GH S272 0001 R0258	38710 6				
2		S 272-Z 2	GH S272 0001 R0278	38730 4				
3		S 272-Z 3	GH S272 0001 R0318	38750 2				
4		S 272-Z 4	GH S272 0001 R0338	38780 9				
6		S 272-Z 6	GH S272 0001 R0378	38800 4				
8		S 272-Z 8	GH S272 0001 R0408	38820 2				
10		S 272-Z 10	GH S272 0001 R0428	38840 0				
16		S 272-Z 16	GH S272 0001 R0468	38860 8				
20		S 272-Z 20	GH S272 0001 R0488	38880 6				
25		S 272-Z 25	GH S272 0001 R0518	38900 1				
32		S 272-Z 32	GH S272 0001 R0538	65350 8				
40		S 272-Z 40	GH S272 0001 R0558	65360 7				
50		S 272-Z 50	GH S272 0001 R0578	65370 6				
3		0.5	S 273-Z 0.5	GH S273 0001 R0158	65390 4			0.390
	1	S 273-Z 1	GH S273 0001 R0218	65400 0				
	1.6	S 273-Z 1.6	GH S273 0001 R0258	65410 9				
	2	S 273-Z 2	GH S273 0001 R0278	65420 8				
	3	S 273-Z 3	GH S273 0001 R0318	65430 7				
	4	S 273-Z 4	GH S273 0001 R0338	65440 6				
	6	S 273-Z 6	GH S273 0001 R0378	65450 5				
	8	S 273-Z 8	GH S273 0001 R0408	65460 4				
	10	S 273-Z 10	GH S273 0001 R0428	65470 3				
	16	S 273-Z 16	GH S273 0001 R0468	65480 2				
	20	S 273-Z 20	GH S273 0001 R0488	65490 1				
	25	S 273-Z 25	GH S273 0001 R0518	65500 7				
	32	S 273-Z 32	GH S273 0001 R0538	65510 6				
	40	S 273-Z 40	GH S273 0001 R0558	65520 5				
	50	S 273-Z 50	GH S273 0001 R0578	65530 4				
	4	0.5	S 274-Z 0.5	GH S274 0001 R0158	65540 3			
1		S 274-Z 1	GH S274 0001 R0218					
1.6		S 274-Z 1.6	GH S274 0001 R0258					
2		S 274-Z 2	GH S274 0001 R0278					
3		S 274-Z 3	GH S274 0001 R0318					
4		S 274-Z 4	GH S274 0001 R0338					
6		S 274-Z 6	GH S274 0001 R0378					
8		S 274-Z 8	GH S274 0001 R0408					
10		S 274-Z 10	GH S274 0001 R0428					
16		S 274-Z 16	GH S274 0001 R0468					
20		S 274-Z 20	GH S274 0001 R0488					
25		S 274-Z 25	GH S274 0001 R0518					
32		S 274-Z 32	GH S274 0001 R0538					
40		S 274-Z 40	GH S274 0001 R0558					
50		S 274-Z 50	GH S274 0001 R0578					

① U_{Bmax} 125 V ... with poles connected in series

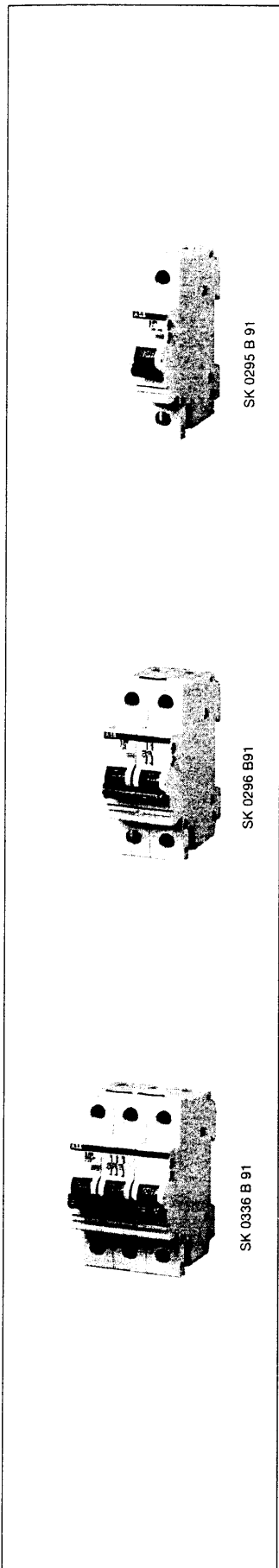

Z with reference to IEC 60898-1 for the protection of semiconductor devices and voltage transformer circuits

Selection table

No. of poles	Rated current I_n A	Ordering details		bbn 40 12233 EAN	Price 1 piece DM	Price group	Weight 1 piece kg
		Type No.	Order code				
4	0.5	S 274-Z 0.5	GH S274 0001 R0158	65550 2			0.520
	1	S 274-Z 1	GH S274 0001 R0218	65560 1			
	1.6	S 274-Z 1.6	GH S274 0001 R0258	65570 0			
	2	S 274-Z 2	GH S274 0001 R0278	65580 9			
	3	S 274-Z 3	GH S274 0001 R0318	65590 8			
	4	S 274-Z 4	GH S274 0001 R0338	65600 4			
	6	S 274-Z 6	GH S274 0001 R0378	65610 3			
	8	S 274-Z 8	GH S274 0001 R0408	65620 2			
	10	S 274-Z 10	GH S274 0001 R0428	65630 1			
	16	S 274-Z 16	GH S274 0001 R0468	65640 0			
	20	S 274-Z 20	GH S274 0001 R0488	65650 9			
	25	S 274-Z 25	GH S274 0001 R0518	65660 8			
	32	S 274-Z 32	GH S274 0001 R0538	65670 7			
	40	S 274-Z 40	GH S274 0001 R0558	65680 6			
	50	S 274-Z 50	GH S274 0001 R0578	65690 5			
63	S 274-Z 63	GH S274 0001 R0608	65700 1				

U_{Bmax}
440 V ~
125 V ∴

① U_{Bmax} 125 V ∴ with 2 poles connected in series

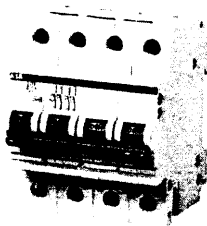

SK 0337 B 91

Selection table

No. of poles	Rated current I_n A	Ordering details		bbn 40 12233 EAN	Price 1 piece DM	Price group	Weight 1 piece kg	Pack. unit pcs.	
		Type No.	Order code						
1	6	S 271-B 6	GH S271 0001 R0065	68580 6			0.125	10/40	
	10	S 271-B 10	GH S271 0001 R0105	68590 5					
	13	S 271-B 13	GH S271 0001 R0135	68530 1					
	16	S 271-B 16	GH S271 0001 R0165	37770 2					
	20 ①	S 271-B 20	GH S271 0001 R0205	68600 1					
	25	S 271-B 25	GH S271 0001 R0255	68540 0					
	32 ②	S 271-B 32	GH S271 0001 R0325	68550 9					
	U_{Bmax} 440 V ~	40 ③	S 271-B 40	GH S271 0001 R0405					68610 0
	50	S 271-B 50	GH S271 0001 R0505	68560 8					
	60 V ≍	63	S 271-B 63	GH S271 0001 R0635					68570 7
2	6	S 272-B 6	GH S272 0001 R0065	68620 9			0.250	5/20	
	10	S 272-B 10	GH S272 0001 R0105	68630 8					
	13	S 272-B 13	GH S272 0001 R0135	68660 5					
	16	S 272-B 16	GH S272 0001 R0165	64810 8					
	20	S 272-B 20	GH S272 0001 R0205	68640 7					
	25	S 272-B 25	GH S272 0001 R0255	68670 4					
	32	S 272-B 32	GH S272 0001 R0325	68680 3					
	U_{Bmax} 440 V ~	40	S 272-B 40	GH S272 0001 R0405					68650 6
	125 V ≍	50	S 272-B 50	GH S272 0001 R0505					68690 2
	④	63	S 272-B 63	GH S272 0001 R0635					68700 8
3	6	S 273-B 6	GH S273 0001 R0065	68740 4			0.375	3/12	
	10	S 273-B 10	GH S273 0001 R0105	68730 5					
	13	S 273-B 13	GH S273 0001 R0135	68750 3					
	16	S 273-B 16	GH S273 0001 R0165	39940 6					
	20	S 273-B 20	GH S273 0001 R0205	68720 6					
	25	S 273-B 25	GH S273 0001 R0255	68760 2					
	32	S 273-B 32	GH S273 0001 R0325	68770 1					
	U_{Bmax} 440 V ~	40	S 273-B 40	GH S273 0001 R0405					68710 7
	50	S 273-B 50	GH S273 0001 R0505	68780 0					
	63	S 273-B 63	GH S273 0001 R0635	68790 9					
4	6	S 274-B 6	GH S274 0001 R0065	68800 5			0.500	2	
	10	S 274-B 10	GH S274 0001 R0105	68810 4					
	13	S 274-B 13	GH S274 0001 R0135	68840 1					
	16	S 274-B 16	GH S274 0001 R0165	68850 0					
	20	S 274-B 20	GH S274 0001 R0205	68820 3					
	25	S 274-B 25	GH S274 0001 R0255	68860 9					
	32	S 274-B 32	GH S274 0001 R0325	68870 8					
	U_{Bmax} 440 V ~	40	S 274-B 40	GH S274 0001 R0405					68830 2
	125 V ≍	50	S 274-B 50	GH S274 0001 R0505					68880 7
	④	63	S 274-B 63	GH S274 0001 R0635					68890 6

- ① Suitable for continuous flow water heater 12 kW
 ② Suitable for continuous flow water heater 18 kW
 ③ Suitable for continuous flow water heater 21, 24 and 27 kW
 ④ U_{Bmax} 125 V ≍ with 2 poles connected in series

Selection table

M.C.B.'s with disconnecting neutral NA

No. of poles	Rated current I_n , A	Ordering details		bbn 40 12233 EAN	Price 1 piece DM	Price group	Weight 1 piece kg	Pack. unit pcs.
		Type No.	Order code					
1+NA	6	S 271-B 6 NA	GH S271 0103 R0065	68450 2			0.250	5
	10	S 271-B 10 NA	GH S271 0103 R0105	68460 1				
	13	S 271-B 13 NA	GH S271 0103 R0135	68470 0				
	16	S 271-B 16 NA	GH S271 0103 R0165	68480 9				
	20 ①	S 271-B 20 NA	GH S271 0103 R0205	68490 8			0.250	
	25	S 271-B 25 NA	GH S271 0103 R0255	68500 4				
	32 ②	S 271-B 32 NA	GH S271 0103 R0325	68510 3				
	U_{Bmax} 440 V ~ 60 V ∴	40 ③	S 271-B 40 NA	GH S271 0103 R0405	68520 2			0.250
50		S 271-B 50 NA	GH S271 0103 R0505	76010 7				
63		S 271-B 63 NA	GH S271 0103 R0635	76020 6				
3+NA	6	S 273-B 6 NA	GH S273 0103 R0065	68900 2			0.500	2
	10	S 273-B 10 NA	GH S273 0103 R0105	68910 1				
	13	S 273-B 13 NA	GH S273 0103 R0135	68920 0				
	16	S 273-B 16 NA	GH S273 0103 R0165	68930 9				
	20 ①	S 273-B 20 NA	GH S273 0103 R0205	68940 8			0.500	
	25	S 273-B 25 NA	GH S273 0103 R0255	68950 7				
	32 ②	S 273-B 32 NA	GH S273 0103 R0325	68960 6				
	U_{Bmax} 440 V ~	40 ③	S 273-B 40 NA	GH S273 0103 R0405	68970 5			0.500
50		S 273-B 50 NA	GH S273 0103 R0505	68980 4				
63		S 273-B 63 NA	GH S273 0103 R0635	68990 3				

- ① Suitable for continuous flow water heater 12 kW
 ② Suitable for continuous flow water heater 18 kW
 ③ Suitable for continuous flow water heater 21, 24 and 27 kW



SK 0018 B 93

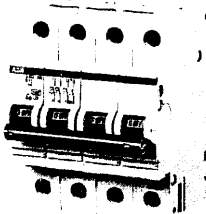

SK 0023 B 93

Selection table

No. of poles	Rated current I_n A	Ordering details		bbn 40 12233 EAN	Price 1 piece DM	Price group	Weight 1 piece kg	Pack. unit pcs.					
		Type No.	Order code										
1	0.5	S 271-C 0.5	GH S271 0001 R0984	69000 8			0.125	10/40					
	1	S 271-C 1	GH S271 0001 R0014	69040 4									
	1.6	S 271-C 1.6	GH S271 0001 R0974	69050 3									
	2	S 271-C 2	GH S271 0001 R0024	69060 2									
	3	S 271-C 3	GH S271 0001 R0034	69070 1									
	4	S 271-C 4	GH S271 0001 R0044	69110 4									
	6	S 271-C 6	GH S271 0001 R0064	69120 3									
	8	S 271-C 8	GH S271 0001 R0084	69130 2									
	10	S 271-C 10	GH S271 0001 R0104	69010 7									
	13	S 271-C 13	GH S271 0001 R0134	69140 1									
	16	S 271-C 16	GH S271 0001 R0164	69160 9									
	20 ①	S 271-C 20	GH S271 0001 R0204	69170 8									
	25	S 271-C 25	GH S271 0001 R0254	69020 6									
	32 ②	S 271-C 32	GH S271 0001 R0324	69180 7									
	40 ③	S 271-C 40	GH S271 0001 R0404	69030 5									
	U_{Bmax} 440 V ~ 60 V ∴	50	S 271-C 50	GH S271 0001 R0504					69190 6				
		63	S 271-C 63	GH S271 0001 R0634					69210 1				
	2	0.5	S 272-C 0.5	GH S272 0001 R0984					69270 5			0.250	5/20
		1	S 272-C 1	GH S272 0001 R0014					69280 4				
1.6		S 272-C 1.6	GH S272 0001 R0974	69290 3									
2		S 272-C 2	GH S272 0001 R0024	69300 9									
3		S 272-C 3	GH S272 0001 R0034	69310 8									
4		S 272-C 4	GH S272 0001 R0044	69320 7									
6		S 272-C 6	GH S272 0001 R0064	69330 6									
8		S 272-C 8	GH S272 0001 R0084	69340 5									
10		S 272-C 10	GH S272 0001 R0104	69260 6									
13		S 272-C 13	GH S272 0001 R0134	69350 4									
16		S 272-C 16	GH S272 0001 R0164	69360 3									
20		S 272-C 20	GH S272 0001 R0204	69370 2									
25		S 272-C 25	GH S272 0001 R0254	69250 7									
32		S 272-C 32	GH S272 0001 R0324	69380 1									
40		S 272-C 40	GH S272 0001 R0404	69240 8									
U_{Bmax} 440 V ~ 125 V ∴		50	S 272-C 50	GH S272 0001 R0504	69390 0								
		④ 63	S 272-C 63	GH S272 0001 R0634	69400 6								
3		0.5	S 273-C 0.5	GH S273 0001 R0984	69410 5			0.375	3/12				
		1	S 273-C 1	GH S273 0001 R0014	69460 0								
	1.6	S 273-C 1.6	GH S273 0001 R0974	69450 1									
	2	S 273-C 2	GH S273 0001 R0024	69470 9									
	3	S 273-C 3	GH S273 0001 R0034	69480 8									
	4	S 273-C 4	GH S273 0001 R0044	69490 7									
	6	S 273-C 6	GH S273 0001 R0064	69500 3									
	8	S 273-C 8	GH S273 0001 R0084	69510 2									
	10	S 273-C 10	GH S273 0001 R0104	69420 4									
	13	S 273-C 13	GH S273 0001 R0134	69520 1									
	16	S 273-C 16	GH S273 0001 R0164	64820 7									
	20 ①	S 273-C 20	GH S273 0001 R0204	69530 0									
	25	S 273-C 25	GH S273 0001 R0254	69430 3									
	32 ②	S 273-C 32	GH S273 0001 R0324	69540 9									
	40 ③	S 273-C 40	GH S273 0001 R0404	69440 2									
	U_{Bmax} 440 V ~	50	S 273-C 50	GH S273 0001 R0504	69550 8								
		63	S 273-C 63	GH S273 0001 R0634	69560 7								

- ① Suitable for continuous flow water heater 12 kW
- ② Suitable for continuous flow water heater 18 kW
- ③ Suitable for continuous flow water heater 21, 24 and 27 kW
- ④ U_{Bmax} 125 V ∴ with 2 poles connected in series

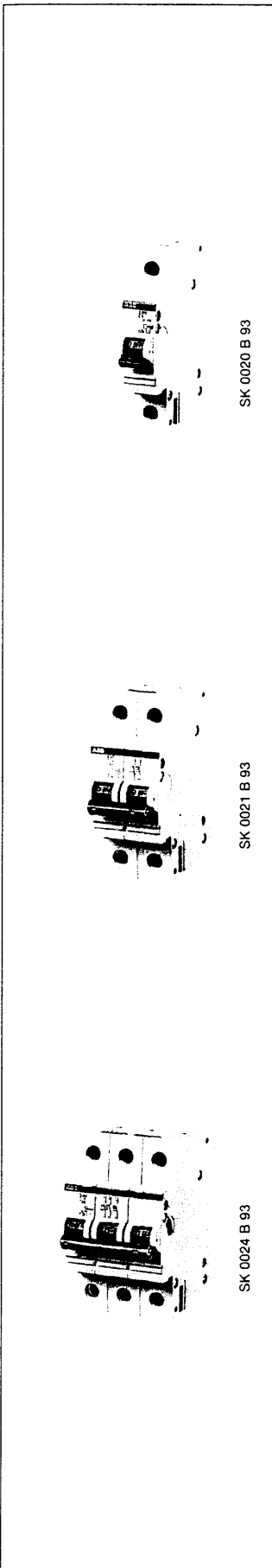

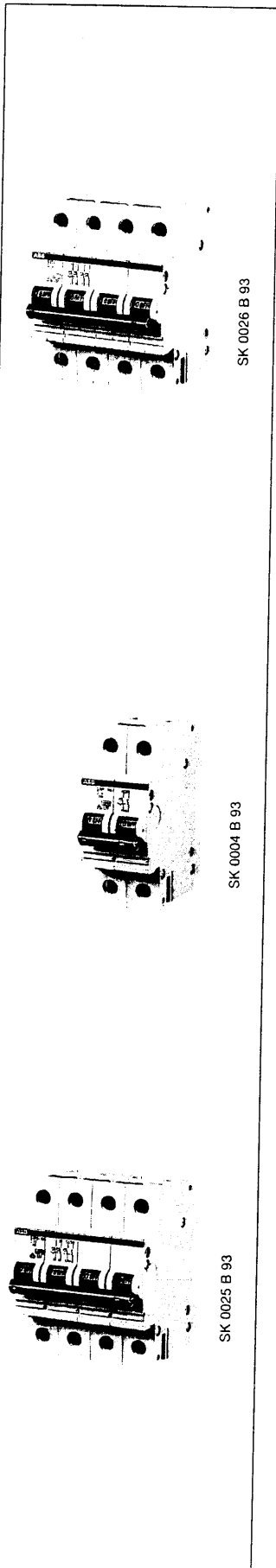

No. of poles	Rated current I _n A	Ordering details		bbn 40 12233 EAN	Price 1 piece DM	Price group	Weight 1 piece kg	Pack. unit pcs.
		Type No.	Order code					
4	0.5	S 274-C 0.5	GH S274 0001 R0984	69570 6			0.500	2
	1	S 274-C 1	GH S274 0001 R0014	69630 7				
	1.6	S 274-C 1.6	GH S274 0001 R0974	69610 9				
	2	S 274-C 2	GH S274 0001 R0024	69920 9				
	3	S 274-C 3	GH S274 0001 R0034	69930 8				
	4	S 274-C 4	GH S274 0001 R0044	69960 5				
	6	S 274-C 6	GH S274 0001 R0064	69980 3				
	8	S 274-C 8	GH S274 0001 R0084	70000 4				
	10	S 274-C 10	GH S274 0001 R0104	69580 5				
	13	S 274-C 13	GH S274 0001 R0134	70020 2				
	16	S 274-C 16	GH S274 0001 R0164	70030 1				
	20	S 274-C 20	GH S274 0001 R0204	70050 9				
	25	S 274-C 25	GH S274 0001 R0254	69590 4				
	32	S 274-C 32	GH S274 0001 R0324	70070 7				
	40	S 274-C 40	GH S274 0001 R0404	69600 0				
	50	S 274-C 50	GH S274 0001 R0504	70080 6				
63	S 274-C 63	GH S274 0001 R0634	70100 1					

U_{Bmax}
440 V ~
125 V ≍
④

M.C.B.'s with disconnecting neutral NA

1 + NA	0.5	S 271-C 0.5 NA	GH S271 0103 R0984	69080 0			0.250	5
	1	S 271-C 1 NA	GH S271 0103 R0014	69090 9				
	1.6	S 271-C 1.6 NA	GH S271 0103 R0974	69100 5				
	2	S 271-C 2 NA	GH S271 0103 R0024	69150 0				
	3	S 271-C 3 NA	GH S271 0103 R0034	69200 2				
	4	S 271-C 4 NA	GH S271 0103 R0044	69220 0				
	6	S 271-C 6 NA	GH S271 0103 R0064	69230 9				
	8	S 271-C 8 NA	GH S271 0103 R0084	69620 8				
	10	S 271-C 10 NA	GH S271 0103 R0104	69640 6				
	13	S 271-C 13 NA	GH S271 0103 R0134	69650 5				
	16	S 271-C 16 NA	GH S271 0103 R0164	69660 4				
	20 ①	S 271-C 20 NA	GH S271 0103 R0204	69670 3				
	25	S 271-C 25 NA	GH S271 0103 R0254	69680 2				
	32 ②	S 271-C 32 NA	GH S271 0103 R0324	69690 1				
	40 ③	S 271-C 40 NA	GH S271 0103 R0404	69700 7				
	50	S 271-C 50 NA	GH S271 0103 R0504	69710 6				
63	S 271-C 63 NA	GH S271 0103 R0634	69720 9					
3 + NA	0.5	S 273-C 0.5 NA	GH S273 0103 R0984	69730 4			0.500	2
	1	S 273-C 1 NA	GH S273 0103 R0014	69740 3				
	1.6	S 273-C 1.6 NA	GH S273 0103 R0974	69750 2				
	2	S 273-C 2 NA	GH S273 0103 R0024	69760 1				
	3	S 273-C 3 NA	GH S273 0103 R0034	69770 0				
	4	S 273-C 4 NA	GH S273 0103 R0044	69780 9				
	6	S 273-C 6 NA	GH S273 0103 R0064	69790 8				
	8	S 273-C 8 NA	GH S273 0103 R0084	69800 4				
	10	S 273-C 10 NA	GH S273 0103 R0104	69810 3				
	13	S 273-C 13 NA	GH S273 0103 R0134	69820 2				
	16	S 273-C 16 NA	GH S273 0103 R0164	64830 1				
	20 ①	S 273-C 20 NA	GH S273 0103 R0204	69840 0				
	25	S 273-C 25 NA	GH S273 0103 R0254	69850 9				
	32 ②	S 273-C 32 NA	GH S273 0103 R0324	69860 8				
	40 ③	S 273-C 40 NA	GH S273 0103 R0404	69870 7				
	50	S 273-C 50 NA	GH S273 0103 R0504	69880 6				
63	S 273-C 63 NA	GH S273 0103 R0634	69890 5					

U_{Bmax}
440 V ~
60 V ≍

- ① Suitable for continuous flow water heater 12 kW
- ② Suitable for continuous flow water heater 18 kW
- ③ Suitable for continuous flow water heater 21, 24 and 27 kW
- ④ U_{Bmax} 125 V ≍ with 2 poles connected in series

Selection table

No. of poles	Rated current I_n , A	Ordering details		bbn 40 12233 EAN	Price 1 piece DM	Price group	Weight 1 piece kg	Pack. unit pcs.
		Type No.	Order code					
1	6	S 281-B 6	GH S281 0001 R0065	43100 7			0.130	10/40
	10	S 281-B 10	GH S281 0001 R0105	43150 2				
	13	S 281-B 13	GH S281 0001 R0135	43190 8				
	16	S 281-B 16	GH S281 0001 R0165	43240 0				
	20	S 281-B 20	GH S281 0001 R0205	43280 6				
	25	S 281-B 25	GH S281 0001 R0255	43330 8				
	32	S 281-B 32	GH S281 0001 R0325	43420 6			0.160	
	40	S 281-B 40	GH S281 0001 R0405	43500 5				
	50	S 281-B 50	GH S281 0001 R0505	65830 5				
	63	S 281-B 63	GH S281 0001 R0635	64860 3				
	U_{Bmax} 440 V ~ 60 V =							
	①							
	②							
2	6	S 282-B 6	GH S282 0001 R0065	44760 2			0.260	5/20
	10	S 282-B 10	GH S282 0001 R0105	44810 4				
	13	S 282-B 13	GH S282 0001 R0135	44850 0				
	16	S 282-B 16	GH S282 0001 R0165	44900 2				
	20	S 282-B 20	GH S282 0001 R0205	44940 8				
	25	S 282-B 25	GH S282 0001 R0255	44990 3				
	32	S 282-B 32	GH S282 0001 R0325	45080 0			0.320	
	40	S 282-B 40	GH S282 0001 R0405	45150 0				
	50	S 282-B 50	GH S282 0001 R0505	65840 4				
	63	S 282-B 63	GH S282 0001 R0635	65850 3				
	U_{Bmax} 440 V ~ 125 V =							
	①							
	②							
3	6	S 283-B 6	GH S283 0001 R0065	45950 6			0.390	3/12
	10	S 283-B 10	GH S283 0001 R0105	46000 7				
	13	S 283-B 13	GH S283 0001 R0135	46040 3				
	16	S 283-B 16	GH S283 0001 R0165	46090 8				
	20	S 283-B 20	GH S283 0001 R0205	46130 1				
	25	S 283-B 25	GH S283 0001 R0255	46180 6				
	32	S 283-B 32	GH S283 0001 R0325	46270 4			0.480	
	40	S 283-B 40	GH S283 0001 R0405	46340 4				
	50	S 283-B 50	GH S283 0001 R0505	65860 2				
	63	S 283-B 63	GH S283 0001 R0635	65870 1				
	U_{Bmax} 440 V ~							
	①							
	②							
4	6	S 284-B 6	GH S284 0001 R0065	47620 6			0.520	2
	10	S 284-B 10	GH S284 0001 R0105	47650 3				
	13	S 284-B 13	GH S284 0001 R0135	47680 0				
	16	S 284-B 16	GH S284 0001 R0165	47720 3				
	20	S 284-B 20	GH S284 0001 R0205	47750 0				
	25	S 284-B 25	GH S284 0001 R0255	47790 6				
	32	S 284-B 32	GH S284 0001 R0325	47870 5			0.640	
	40	S 284-B 40	GH S284 0001 R0405	47930 6				
	50	S 284-B 50	GH S284 0001 R0505	48030 2				
	63	S 284-B 63	GH S284 0001 R0635	48150 7				
	U_{Bmax} 440 V ~ 125 V =							
	①							
	②							

① U_{Bmax} 125 V = with 2 poles connected in series
② max. rated rupturing capacity of the range

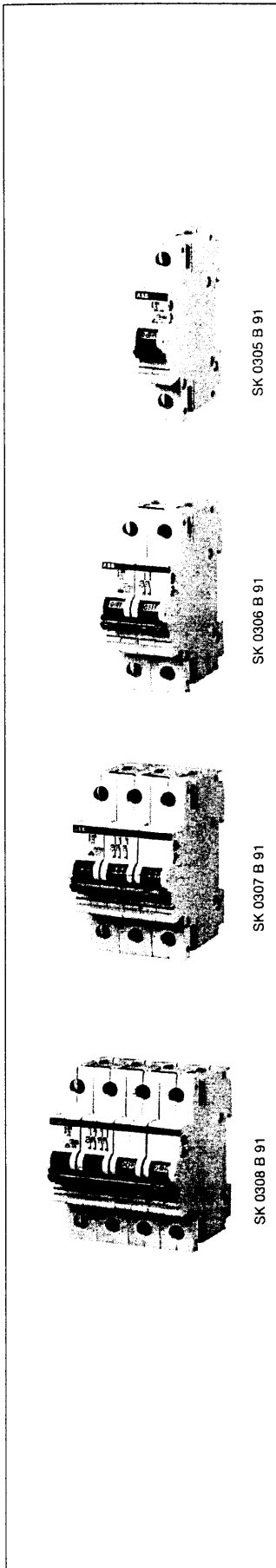

B 800 100 100 DE
324 100 100 DE
0808 00000000
25 000

Selection table

No. of poles	Rated current I_n A	Ordering details		bbn 40 12233 EAN	Price 1 piece DM	Price gross	Price net
		Type No.	Order code				
M.C.B's with disconnecting neutral NA							
1 + NA	6	S 281-B 6 NA	GH S281 0103 R0065	69900 1			
	10	S 281-B 10 NA	GH S281 0103 R0105	69910 0			
	13	S 281-B 13 NA	GH S281 0103 R0135	69940 7			
	16	S 281-B 16 NA	GH S281 0103 R0165	69950 6			
	20	S 281-B 20 NA	GH S281 0103 R0205	69970 4			
	25	S 281-B 25 NA	GH S281 0103 R0255	69990 2			
	32	S 281-B 32 NA	GH S281 0103 R0325	70370 8			
	40	S 281-B 40 NA	GH S281 0103 R0405	70040 0			
	50	S 281-B 50 NA	GH S281 0103 R0505	70060 8			
	63	S 281-B 63 NA	GH S281 0103 R0635	70090 5			
3 + NA	6	S 283-B 6 NA	GH S283 0103 R0065	76380 1			
	10	S 283-B 10 NA	GH S283 0103 R0105	70120 9			
	13	S 283-B 13 NA	GH S283 0103 R0135	70130 8			
	16	S 283-B 16 NA	GH S283 0103 R0165	70140 7			
	20	S 283-B 20 NA	GH S283 0103 R0205	70150 6			
	25	S 283-B 25 NA	GH S283 0103 R0255	70160 5			
	32	S 283-B 32 NA	GH S283 0103 R0325	70110 0			
	40	S 283-B 40 NA	GH S283 0103 R0405	70170 4			
	50	S 283-B 50 NA	GH S283 0103 R0505	70180 3			
	63	S 283-B 63 NA	GH S283 0103 R0635	70190 2			

① max. rated rupturing capacity of the range

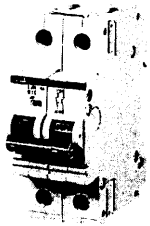

SK 0134 B 93

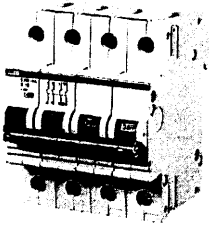

SK 0131 B 93

Selection table

No. of poles	Rated current I_n , A	Ordering details		bbn 40 12233 EAN	Price 1 piece DM	Price group	Weight 1 piece kg	Pack. unit pcs.				
		Type No.	Order code									
1	0.5	S 281-C 0.5	GH S281 0001 R0984	43720 7			0.130					
	1	S 281-C 1	GH S281 0001 R0014	43040 6								
	1.6	S 281-C 1.6	GH S281 0001 R0974	43710 8								
	2	S 281-C 2	GH S281 0001 R0024	43050 5								
	3	S 281-C 3	GH S281 0001 R0034	43060 4								
	4	S 281-C 4	GH S281 0001 R0044	43070 3								
	6	S 281-C 6	GH S281 0001 R0064	43090 1								
	8	S 281-C 8	GH S281 0001 R0084	43110 6								
	10	S 281-C 10	GH S281 0001 R0104	43140 3								
	13	S 281-C 13	GH S281 0001 R0134	43180 9								
	16	S 281-C 16	GH S281 0001 R0164	43230 1								
	20	S 281-C 20	GH S281 0001 R0204	43270 7								
	25	S 281-C 25	GH S281 0001 R0254	43320 9								
	32	S 281-C 32	GH S281 0001 R0324	43410 7								
	40	S 281-C 40	GH S281 0001 R0404	43490 9								
	U_{Bmax} 440 V ~ 60 V ∴	50	S 281-C 50	GH S281 0001 R0504			64850 4					
		63	S 281-C 63	GH S281 0001 R0634			65790 2					
	2	0.5	S 282-C 0.5	GH S282 0001 R0984			45360 3				0.260	5/20
		1	S 282-C 1	GH S282 0001 R0014			44700 8					
		1.6	S 282-C 1.6	GH S282 0001 R0974			45350 4					
2		S 282-C 2	GH S282 0001 R0024	44710 7								
3		S 282-C 3	GH S282 0001 R0034	44720 6								
4		S 282-C 4	GH S282 0001 R0044	44730 5								
6		S 282-C 6	GH S282 0001 R0064	44750 3								
8		S 282-C 8	GH S282 0001 R0084	44770 1								
10		S 282-C 10	GH S282 0001 R0104	44800 5								
13		S 282-C 13	GH S282 0001 R0134	44840 1								
16		S 282-C 16	GH S282 0001 R0164	44890 6								
20		S 282-C 20	GH S282 0001 R0204	44930 9								
25		S 282-C 25	GH S282 0001 R0254	44980 4								
32		S 282-C 32	GH S282 0001 R0324	45070 1								
40		S 282-C 40	GH S282 0001 R0404	45140 1								
U_{Bmax} 440 V ~ 125 V ∴ ①		50	S 282-C 50	GH S282 0001 R0504	65810 7							
		63	S 282-C 63	GH S282 0001 R0634	65820 6							
3		0.5	S 283-C 0.5	GH S283 0001 R0984	46550 7			0.390			3/12	
		1	S 283-C 1	GH S283 0001 R0014	45890 5							
		1.6	S 283-C 1.6	GH S283 0001 R0974	46540 8							
	2	S 283-C 2	GH S283 0001 R0024	45900 1								
	3	S 283-C 3	GH S283 0001 R0034	45910 0								
	4	S 283-C 4	GH S283 0001 R0044	45920 9								
	6	S 283-C 6	GH S283 0001 R0064	45940 7								
	8	S 283-C 8	GH S283 0001 R0084	45960 5								
	10	S 283-C 10	GH S283 0001 R0104	45990 2								
	13	S 283-C 13	GH S283 0001 R0134	46030 4								
	16	S 283-C 16	GH S283 0001 R0164	46080 9								
	20 ①	S 283-C 20	GH S283 0001 R0204	46120 2								
	25	S 283-C 25	GH S283 0001 R0254	46170 7								
	32 ②	S 283-C 32	GH S283 0001 R0324	46260 5								
	40 ③	S 283-C 40	GH S283 0001 R0404	46330 5								
	U_{Bmax} 440 V ~	50	S 283-C 50	GH S283 0001 R0504	65260 0							
		63	S 283-C 63	GH S283 0001 R0634	65270 9							

① U_{Bmax} 125 V ∴ with 2 poles connected in series
② max. rated rupturing capacity of the range



SK 0309 B 91

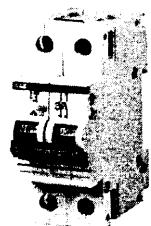

SK 0310 B 91

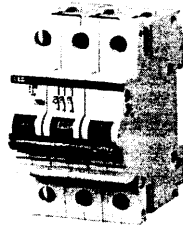

SK 0311 B 91

Miniature Circuit Breakers S 280-C type

C 25 000

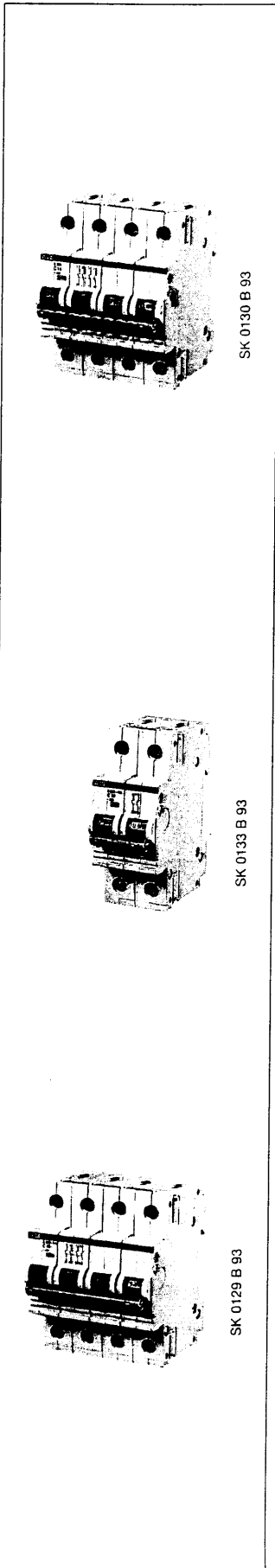

No. of poles	Rated current I _n A	Ordering details		bbn 40 12233 EAN	Price group	Weight
		Type No.	Order code			
4	0.5	S 284-C 0.5	GH S284 0001 R0984	71380 6		0.220 2
	1	S 284-C 1	GH S284 0001 R0014	71400 1		
	1.6	S 284-C 1.6	GH S284 0001 R0974	71390 5		
	2	S 284-C 2	GH S284 0001 R0024	71410 0		
	3	S 284-C 3	GH S284 0001 R0034	71420 9		
	4	S 284-C 4	GH S284 0001 R0044	71430 8		
	6	S 284-C 6	GH S284 0001 R0064	71440 7		
	8	S 284-C 8	GH S284 0001 R0084	71450 6		
	10	S 284-C 10	GH S284 0001 R0104	71460 5		
	13	S 284-C 13	GH S284 0001 R0134	71470 4		
	16	S 284-C 16	GH S284 0001 R0164	71480 3		
	20	S 284-C 20	GH S284 0001 R0204	71490 2		
	25	S 284-C 25	GH S284 0001 R0254	64830 6		
	32	S 284-C 32	GH S284 0001 R0324	71500 8		
	40	S 284-C 40	GH S284 0001 R0404	71510 7		
②	50	S 284-C 50	GH S284 0001 R0504	71520 6	0.340	
	63	S 284-C 63	GH S284 0001 R0634	71530 5		

M.C.B.'s with disconnecting neutral NA

1 + NA	0.5	S 281-C 0.5 NA	GH S281 0103 R0984	70200 8	0.250 3
	1	S 281-C 1 NA	GH S281 0103 R0014	70220 6	
	1.6	S 281-C 1.6 NA	GH S281 0103 R0974	70210 7	
	2	S 281-C 2 NA	GH S281 0103 R0024	70230 5	
	3	S 281-C 3 NA	GH S281 0103 R0034	70240 4	
	4	S 281-C 4 NA	GH S281 0103 R0044	70250 3	
	6	S 281-C 6 NA	GH S281 0103 R0064	70260 2	
	8	S 281-C 8 NA	GH S281 0103 R0084	70270 1	
	10	S 281-C 10 NA	GH S281 0103 R0104	70280 0	
	13	S 281-C 13 NA	GH S281 0103 R0134	70290 9	
	16	S 281-C 16 NA	GH S281 0103 R0164	70300 5	
	20	S 281-C 20 NA	GH S281 0103 R0204	70310 4	
	25	S 281-C 25 NA	GH S281 0103 R0254	70320 3	
	32	S 281-C 32 NA	GH S281 0103 R0324	70330 2	
	40	S 281-C 40 NA	GH S281 0103 R0404	70340 1	
②	50	S 281-C 50 NA	GH S281 0103 R0504	70350 0	0.320
	63	S 281-C 63 NA	GH S281 0103 R0634	70360 9	
3 + NA	0.5	S 283-C 0.5 NA	GH S283 0103 R0984	70380 7	0.320 2
	1	S 283-C 1 NA	GH S283 0103 R0014	70400 2	
	1.6	S 283-C 1.6 NA	GH S283 0103 R0974	70390 6	
	2	S 283-C 2 NA	GH S283 0103 R0024	70410 1	
	3	S 283-C 3 NA	GH S283 0103 R0034	70420 0	
	4	S 283-C 4 NA	GH S283 0103 R0044	70430 3	
	6	S 283-C 6 NA	GH S283 0103 R0064	70440 8	
	8	S 283-C 8 NA	GH S283 0103 R0084	70450 7	
	10	S 283-C 10 NA	GH S283 0103 R0104	70460 6	
	13	S 283-C 13 NA	GH S283 0103 R0134	70470 5	
	16	S 283-C 16 NA	GH S283 0103 R0164	70480 4	
	20	S 283-C 20 NA	GH S283 0103 R0204	70490 3	
	25	S 283-C 25 NA	GH S283 0103 R0254	70500 9	
	32	S 283-C 32 NA	GH S283 0103 R0324	70510 8	
	40	S 283-C 40 NA	GH S283 0103 R0404	70170 4	
②	50	S 283-C 50 NA	GH S283 0103 R0504	70530 6	0.290
	63	S 283-C 63 NA	GH S283 0103 R0634	70540 5	

① max. rated rupturing capacity of the range
 ② U_{Bmax} 125 V ~ with 2 poles connected in series

Selection table

No. of poles	Rated current I_n A	Ordering details Type No.	Order code	bbn 40 12233 EAN	Price 1 piece DM	Price group	Weight 1 piece kg	Pack. unit pcs.			
1	0.5	S 281-D 0.5	GH S281 0001 R0981	71560 2			0.130	10/40			
	1	S 281-D 1	GH S281 0001 R0011	71590 9							
	1.6	S 281-D 1.6	GH S281 0001 R0971	71580 0							
	2	S 281-D 2	GH S281 0001 R0021	71600 5							
	3	S 281-D 3	GH S281 0001 R0031	71610 4							
	4	S 281-D 4	GH S281 0001 R0041	71620 3							
	6	S 281-D 6	GH S281 0001 R0061	71630 2							
	8	S 281-D 8	GH S281 0001 R0081	71640 1							
	10	S 281-D 10	GH S281 0001 R0101	71660 9							
	13	S 281-D 13	GH S281 0001 R0131	71670 8							
	16	S 281-D 16	GH S281 0001 R0161	71680 7							
	20	S 281-D 20	GH S281 0001 R0201	71690 6							
	25	S 281-D 25	GH S281 0001 R0251	71700 2							
	32	S 281-D 32	GH S281 0001 R0321	71710 1							
	40	S 281-D 40	GH S281 0001 R0401	71720 0							
	U_{Bmax} 440 V ~	50	S 281-D 50	GH S281 0001 R0501			71730 9	0.160			
	60 V ~	63	S 281-D 63	GH S281 0001 R0631			71740 8				
	2	0.5	S 282-D 0.5	GH S282 0001 R0981			71770 5			0.260	5/20
		1	S 282-D 1	GH S282 0001 R0011			71800 9				
		1.6	S 282-D 1.6	GH S282 0001 R0971			71790 3				
2		S 282-D 2	GH S282 0001 R0021	71810 8							
3		S 282-D 3	GH S282 0001 R0031	71820 7							
4		S 282-D 4	GH S282 0001 R0041	71830 6							
6		S 282-D 6	GH S282 0001 R0061	71840 5							
8		S 282-D 8	GH S282 0001 R0081	71850 4							
10		S 282-D 10	GH S282 0001 R0101	71860 3							
13		S 282-D 13	GH S282 0001 R0131	71870 2							
16		S 282-D 16	GH S282 0001 R0161	71880 1							
20		S 282-D 20	GH S282 0001 R0201	71890 0							
25		S 282-D 25	GH S282 0001 R0251	71900 6							
32		S 282-D 32	GH S282 0001 R0321	71910 5							
40		S 282-D 40	GH S282 0001 R0401	71920 4							
U_{Bmax} 440 V ~		50	S 282-D 50	GH S282 0001 R0501	71930 3	0.320					
125 V ~ ①		63	S 282-D 63	GH S282 0001 R0631	71940 2						
3		0.5	S 283-D 0.5	GH S283 0001 R0981	71000 3					0.390	3/12
		1	S 283-D 1	GH S283 0001 R0011	71030 0						
		1.6	S 283-D 1.6	GH S283 0001 R0971	71020 1						
	2	S 283-D 2	GH S283 0001 R0021	71040 9							
	3	S 283-D 3	GH S283 0001 R0031	71050 8							
	4	S 283-D 4	GH S283 0001 R0041	71060 7							
	6	S 283-D 6	GH S283 0001 R0061	71070 6							
	8	S 283-D 8	GH S283 0001 R0081	71080 5							
	10	S 283-D 10	GH S283 0001 R0101	71090 4							
	13	S 283-D 13	GH S283 0001 R0131	71100 0							
	16	S 283-D 16	GH S283 0001 R0161	71110 9							
	20	S 283-D 20	GH S283 0001 R0201	71120 8							
	25	S 283-D 25	GH S283 0001 R0251	71130 7							
	32	S 283-D 32	GH S283 0001 R0321	71140 6							
	40	S 283-D 40	GH S283 0001 R0401	71150 5							
	U_{Bmax} 440 V ~	50	S 283-D 50	GH S283 0001 R0501	71160 4			0.480			
		63	S 283-D 63	GH S283 0001 R0631	71170 3						

① U_{Bmax} 125 V ~ with 2 poles connected in series
② max. rated rupturing capacity of the range

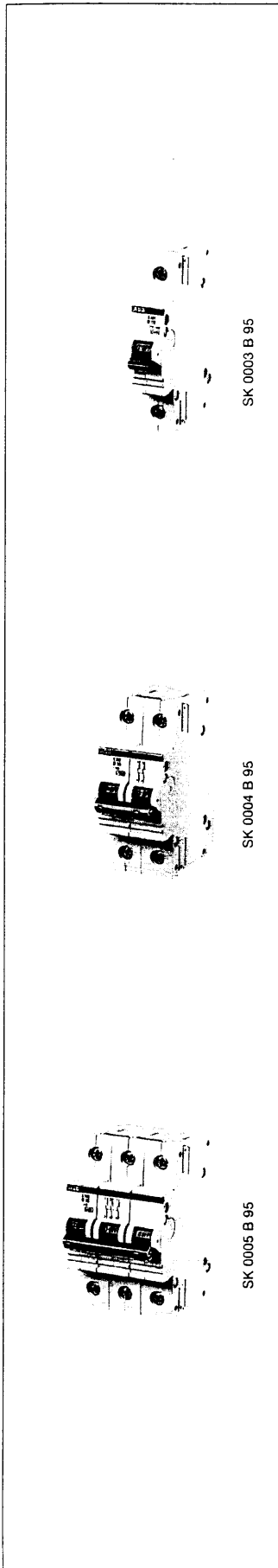

Miniature Circuit Breakers S 280-D type

D acc. to EN 60 898 for cable protection:
25 000 ②

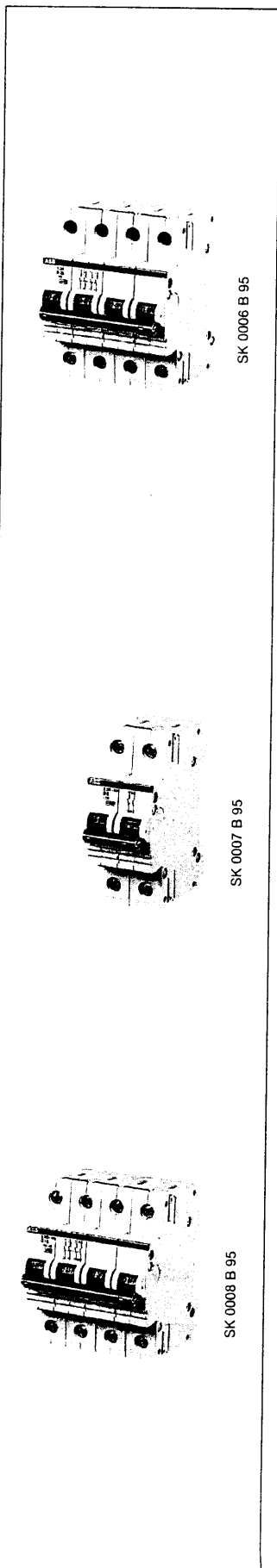

No. of poles	Rated current I_n A	Ordering details		bbn 40 12233 EAN	Weight 1 piece kg	Pack. unit pcs.
		Type No.	Order code			
4	0.5	S 284-D 0.5	GH S284 0001 R0981	71200 7	0.520	2
	1	S 284-D 1	GH S284 0001 R0011	71230 4		
	1.6	S 284-D 1.6	GH S284 0001 R0971	71220 5		
	2	S 284-D 2	GH S284 0001 R0021	71240 3		
	3	S 284-D 3	GH S284 0001 R0031	71250 2		
	4	S 284-D 4	GH S284 0001 R0041	71260 1		
	6	S 284-D 6	GH S284 0001 R0061	71270 0		
	8	S 284-D 8	GH S284 0001 R0081	71280 9		
	10	S 284-D 10	GH S284 0001 R0101	71290 8		
	13	S 284-D 13	GH S284 0001 R0131	71300 4		
	16	S 284-D 16	GH S284 0001 R0161	71310 3		
	20	S 284-D 20	GH S284 0001 R0201	71320 2		
	25	S 284-D 25	GH S284 0001 R0251	71330 1		
	32	S 284-D 32	GH S284 0001 R0321	71340 0		
	40	S 284-D 40	GH S284 0001 R0401	71350 9		
	①	50	S 284-D 50	GH S284 0001 R0501		
63		S 284-D 63	GH S284 0001 R0631	71370 7		

M.C.B.'s with disconnecting neutral NA

1 + NA	0.5	S 281-D 0.5 NA	GH S281 0103 R0981	70570 2	0.260	5
	1	S 281-D 1 NA	GH S281 0103 R0011	70600 6		
	1.6	S 281-D 1.6 NA	GH S281 0103 R0971	70590 0		
	2	S 281-D 2 NA	GH S281 0103 R0021	70620 4		
	3	S 281-D 3 NA	GH S281 0103 R0031	70630 3		
	4	S 281-D 4 NA	GH S281 0103 R0041	70640 2		
	6	S 281-D 6 NA	GH S281 0103 R0061	70650 1		
	8	S 281-D 8 NA	GH S281 0103 R0081	70660 0		
	10	S 281-D 10 NA	GH S281 0103 R0101	70670 9		
	13	S 281-D 13 NA	GH S281 0103 R0131	70680 8		
	16	S 281-D 16 NA	GH S281 0103 R0161	70690 7		
	20	S 281-D 20 NA	GH S281 0103 R0201	70700 3		
	25	S 281-D 25 NA	GH S281 0103 R0251	70710 2		
	32	S 281-D 32 NA	GH S281 0103 R0321	70720 1		
	40	S 281-D 40 NA	GH S281 0103 R0401	70730 0		
	①	50	S 281-D 50 NA	GH S281 0103 R0501		
63		S 281-D 63 NA	GH S281 0103 R0631	70750 8		
3 + NA	0.5	S 283-D 0.5 NA	GH S283 0103 R0981	70790 4	0.520	2
	1	S 283-D 1 NA	GH S283 0103 R0011	70820 8		
	1.6	S 283-D 1.6 NA	GH S283 0103 R0971	70810 9		
	2	S 283-D 2 NA	GH S283 0103 R0021	70830 7		
	3	S 283-D 3 NA	GH S283 0103 R0031	70840 6		
	4	S 283-D 4 NA	GH S283 0103 R0041	70850 5		
	6	S 283-D 6 NA	GH S283 0103 R0061	70860 4		
	8	S 283-D 8 NA	GH S283 0103 R0081	70870 3		
	10	S 283-D 10 NA	GH S283 0103 R0101	70880 2		
	13	S 283-D 13 NA	GH S283 0103 R0131	70890 1		
	16	S 283-D 16 NA	GH S283 0103 R0161	70900 7		
	20	S 283-D 20 NA	GH S283 0103 R0201	70920 5		
	25	S 283-D 25 NA	GH S283 0103 R0251	70930 4		
	32	S 283-D 32 NA	GH S283 0103 R0321	70940 3		
	40	S 283-D 40 NA	GH S283 0103 R0401	70950 2		
	①	50	S 283-D 50 NA	GH S283 0103 R0501		
63		S 283-D 63 NA	GH S283 0103 R0631	70970 0		

① U_{Bmax} 125 V ~ with 2 poles connected in series
② max. rated rupturing capacity of the range

Selection table

No. of poles	Rated current I_n A	Ordering details		bbn 40 12233 EAN	Price 1 piece DM	Price group	Weight 1 piece kg	Pack. unit pcs.					
		Type No.	Order code										
1	0.2	S 281-K 0.2	GH S281 0001 R0087	43120 5			0.130	10/40					
	0.3	S 281-K 0.3	GH S281 0001 R0117	43160 1									
	0.5	S 281-K 0.5	GH S281 0001 R0157	43200 4									
	0.75	S 281-K 0.75	GH S281 0001 R0187	43250 9									
	1	S 281-K 1	GH S281 0001 R0217	43290 5									
	1.6	S 281-K 1.6	GH S281 0001 R0257	43340 7									
	2	S 281-K 2	GH S281 0001 R0277	43360 5									
	3	S 281-K 3	GH S281 0001 R0317	43380 3									
	4	S 281-K 4	GH S281 0001 R0337	43430 5									
	6	S 281-K 6	GH S281 0001 R0377	43460 2									
	8	S 281-K 8	GH S281 0001 R0407	43510 4									
	10	S 281-K 10	GH S281 0001 R0427	43530 2									
	13	S 281-K 13	GH S281 0001 R0447	97000 1									
	16	S 281-K 16	GH S281 0001 R0467	43550 0									
	20	S 281-K 20	GH S281 0001 R0487	43570 8									
	25	S 281-K 25	GH S281 0001 R0517	43600 2									
	32	S 281-K 32	GH S281 0001 R0537	43620 0									
	40	S 281-K 40	GH S281 0001 R0557	43640 8									
	U_{Bmax} 440 V ~ 60 V ∴	50	S 281-K 50	GH S281 0001 R0577					43660 6			0.160	
		63	S 281-K 63	GH S281 0001 R0607					43680 4				
2	0.2	S 282-K 0.2	GH S282 0001 R0087	44780 0			0.260	5/20					
	0.3	S 282-K 0.3	GH S282 0001 R0117	44820 3									
	0.5	S 282-K 0.5	GH S282 0001 R0157	44860 9									
	0.75	S 282-K 0.75	GH S282 0001 R0187	44910 1									
	1	S 282-K 1	GH S282 0001 R0217	44950 7									
	1.6	S 282-K 1.6	GH S282 0001 R0257	45000 8									
	2	S 282-K 2	GH S282 0001 R0277	45020 6									
	3	S 282-K 3	GH S282 0001 R0317	45040 4									
	4	S 282-K 4	GH S282 0001 R0337	45090 9									
	6	S 282-K 6	GH S282 0001 R0377	45110 4									
	8	S 282-K 8	GH S282 0001 R0407	45160 9									
	10	S 282-K 10	GH S282 0001 R0427	45180 7									
	13	S 282-K 13	GH S282 0001 R0447	97060 5									
	16	S 282-K 16	GH S282 0001 R0467	45200 2									
	20	S 282-K 20	GH S282 0001 R0487	45220 0									
	25	S 282-K 25	GH S282 0001 R0517	45240 8									
	32	S 282-K 32	GH S282 0001 R0537	45260 6									
	40	S 282-K 40	GH S282 0001 R0557	45280 4									
	U_{Bmax} 440 V ~ 125 V ∴ ①	50	S 282-K 50	GH S282 0001 R0577					45300 9			0.320	
		63	S 282-K 63	GH S282 0001 R0607					45320 7				
3	0.2	S 283-K 0.2	GH S283 0001 R0087	45970 4			0.390	3/12					
	0.3	S 283-K 0.3	GH S283 0001 R0117	46010 6									
	0.5	S 283-K 0.5	GH S283 0001 R0157	46050 2									
	0.75	S 283-K 0.75	GH S283 0001 R0187	46100 4									
	1	S 283-K 1	GH S283 0001 R0217	46140 0									
	1.6	S 283-K 1.6	GH S283 0001 R0257	46190 5									
	2	S 283-K 2	GH S283 0001 R0277	46210 0									
	3	S 283-K 3	GH S283 0001 R0317	46230 8									
	4	S 283-K 4	GH S283 0001 R0337	46280 3									
	6	S 283-K 6	GH S283 0001 R0377	46300 8									
	8	S 283-K 8	GH S283 0001 R0407	46350 3									
	10	S 283-K 10	GH S283 0001 R0427	46370 1									
	13	S 283-K 13	GH S283 0001 R0447	97070 4									
	16	S 283-K 16	GH S283 0001 R0467	46390 9									
	20	S 283-K 20	GH S283 0001 R0487	46410 4									
	25	S 283-K 25	GH S283 0001 R0517	46430 2									
	32	S 283-K 32	GH S283 0001 R0537	46450 0									
	40	S 283-K 40	GH S283 0001 R0557	46470 8									
	U_{Bmax} 440 V ~	50	S 283-K 50	GH S283 0001 R0577					46490 6			0.480	
		63	S 283-K 63	GH S283 0001 R0607					46510 1				

① U_{Bmax} 125 V ∴ with 2 poles connected in series
② max. rated rupturing capacity of the range

Selection table

No. of poles	Rated current I_n A	Ordering details		bbn 40 12233 EAN	Price 1 piece DM	Price group	Weight 1 piece kg	Pack. unit pcs.
		Type No.	Order code					
4	0.2	S 284-K 0.2	GH S284 0001 R0087	47630 5			0.520	2
	0.3	S 284-K 0.3	GH S284 0001 R0117	47660 2				
	0.5	S 284-K 0.5	GH S284 0001 R0157	47690 9				
	0.75	S 284-K 0.75	GH S284 0001 R0187	47730 2				
	1	S 284-K 1	GH S284 0001 R0217	47760 9				
	1.6	S 284-K 1.6	GH S284 0001 R0257	47800 2				
	2	S 284-K 2	GH S284 0001 R0277	47820 0				
	3	S 284-K 3	GH S284 0001 R0317	47840 8				
	4	S 284-K 4	GH S284 0001 R0337	47880 4				
	6	S 284-K 6	GH S284 0001 R0377	47900 9				
	8	S 284-K 8	GH S284 0001 R0407	47940 5				
	10	S 284-K 10	GH S284 0001 R0427	47960 3				
	13	S 284-K 13	GH S284 0001 R0447	97080 3				
	16	S 284-K 16	GH S284 0001 R0467	47980 1				
	20	S 284-K 20	GH S284 0001 R0487	48000 5				
②	25	S 284-K 25	GH S284 0001 R0517	48040 1			0.640	
	32	S 284-K 32	GH S284 0001 R0537	48060 9				
	40	S 284-K 40	GH S284 0001 R0557	48080 7				
	50	S 284-K 50	GH S284 0001 R0577	48100 2				
	63	S 284-K 63	GH S284 0001 R0607	48120 0				

U_{Bmax}
440 V ~
125 V ∴

M.C.B.'s with disconnecting neutral NA

1+NA	0.2	S 281-K 0.2	GH S281 0103 R0087	44190 7			0.260	5
	0.3	S 281-K 0.3	GH S281 0103 R0117	44210 2				
	0.5	S 281-K 0.5	GH S281 0103 R0157	44220 1				
	0.75	S 281-K 0.75	GH S281 0103 R0187	44250 8				
	1	S 281-K 1	GH S281 0103 R0217	44270 6				
	1.6	S 281-K 1.6	GH S281 0103 R0257	44300 0				
	2	S 281-K 2	GH S281 0103 R0277	44320 8				
	3	S 281-K 3	GH S281 0103 R0317	44340 6				
	4	S 281-K 4	GH S281 0103 R0337	44370 3				
	6	S 281-K 6	GH S281 0103 R0377	44380 1				
	8	S 281-K 8	GH S281 0103 R0407	44420 5				
	10	S 281-K 10	GH S281 0103 R0427	44440 3				
	13	S 281-K 13	GH S281 0103 R0447	97090 2				
	16	S 281-K 16	GH S281 0103 R0467	44460 1				
	20	S 281-K 20	GH S281 0103 R0487	44480 9				
②	25	S 281-K 25	GH S281 0103 R0517	44510 3			0.320	
	32	S 281-K 32	GH S281 0103 R0537	44530 1				
	40	S 281-K 40	GH S281 0103 R0557	44550 9				
	50	S 281-K 50	GH S281 0103 R0577	44570 7				
	63	S 281-K 63	GH S281 0103 R0607	44590 5				
3+NA	0.2	S 283-K 0.2	GH S283 0103 R0087	47090 7			0.520	2
	0.3	S 283-K 0.3	GH S283 0103 R0117	47110 2				
	0.5	S 283-K 0.5	GH S283 0103 R0157	47120 1				
	0.75	S 283-K 0.75	GH S283 0103 R0187	47150 8				
	1	S 283-K 1	GH S283 0103 R0217	47170 6				
	1.6	S 283-K 1.6	GH S283 0103 R0257	47200 0				
	2	S 283-K 2	GH S283 0103 R0277	47220 8				
	3	S 283-K 3	GH S283 0103 R0317	47240 6				
	4	S 283-K 4	GH S283 0103 R0337	47270 3				
	6	S 283-K 6	GH S283 0103 R0377	47290 1				
	8	S 283-K 8	GH S283 0103 R0407	47320 5				
	10	S 283-K 10	GH S283 0103 R0427	47340 3				
	13	S 283-K 13	GH S283 0103 R0447	97100 8				
	16	S 283-K 16	GH S283 0103 R0467	47360 1				
	20	S 283-K 20	GH S283 0103 R0487	47380 9				
②	25	S 283-K 25	GH S283 0103 R0517	47410 3			0.640	
	32	S 283-K 32	GH S283 0103 R0537	47430 1				
	40	S 283-K 40	GH S283 0103 R0557	47450 9				
	50	S 283-K 50	GH S283 0103 R0577	47470 7				
	63	S 283-K 63	GH S283 0103 R0607	47490 5				

① max. rated rupturing capacity of the range

② U_{Bmax} 125 V ∴ with 2 poles connected in series

Selection table

No. of poles	Rated current I _n A	Ordering details		bbn 40 12233 EAN	Price 1 piece DM	Price group	Weight 1 piece kg	Pack. unit pcs.
		Type No.	Order code					
1	0.5	S 281-Z 0.5	GH S281 0001 R0158	43210 3			0.130	10/40
	1	S 281-Z 1	GH S281 0001 R0218	43300 1				
	1.6	S 281-Z 1.6	GH S281 0001 R0258	43350 6				
	2	S 281-Z 2	GH S281 0001 R0278	43370 4				
	3	S 281-Z 3	GH S281 0001 R0318	43390 2				
	4	S 281-Z 4	GH S281 0001 R0338	43440 4				
	6	S 281-Z 6	GH S281 0001 R0378	43470 1				
	8	S 281-Z 8	GH S281 0001 R0408	43520 3				
	10	S 281-Z 10	GH S281 0001 R0428	43540 1				
	16	S 281-Z 16	GH S281 0001 R0468	43560 9				
	20	S 281-Z 20	GH S281 0001 R0488	43580 7				
	25	S 281-Z 25	GH S281 0001 R0518	43610 1				
	32	S 281-Z 32	GH S281 0001 R0538	43620 0				
	40	S 281-Z 40	GH S281 0001 R0558	43650 7				
	50	S 281-Z 50	GH S281 0001 R0578	43670 5				
	63	S 281-Z 63	GH S281 0001 R0608	43690 3				
U _{Bmax} 440 V ~ 60 V ∴							0.160	
2	0.5	S 282-Z 0.5	GH S282 0001 R0158	44870 8			0.260	5/20
	1	S 282-Z 1	GH S282 0001 R0218	44960 6				
	1.6	S 282-Z 1.6	GH S282 0001 R0258	45010 7				
	2	S 282-Z 2	GH S282 0001 R0278	45030 5				
	3	S 282-Z 3	GH S282 0001 R0318	45050 3				
	4	S 282-Z 4	GH S282 0001 R0338	45100 5				
	6	S 282-Z 6	GH S282 0001 R0378	45120 3				
	8	S 282-Z 8	GH S282 0001 R0408	45170 8				
	10	S 282-Z 10	GH S282 0001 R0428	45190 6				
	16	S 282-Z 16	GH S282 0001 R0468	45210 1				
	20	S 282-Z 20	GH S282 0001 R0488	45230 9				
	25	S 282-Z 25	GH S282 0001 R0518	45250 7				
	32	S 282-Z 32	GH S282 0001 R0538	45270 5				
	40	S 282-Z 40	GH S282 0001 R0558	45290 3				
	50	S 282-Z 50	GH S282 0001 R0578	45310 8				
	63	S 282-Z 63	GH S282 0001 R0608	45330 6				
U _{Bmax} 440 V ~ 125 V ∴ ①							0.320	
3	0.5	S 283-Z 0.5	GH S283 0001 R0158	46060 1			0.390	3/12
	1	S 283-Z 1	GH S283 0001 R0218	46150 9				
	1.6	S 283-Z 1.6	GH S283 0001 R0258	46200 1				
	2	S 283-Z 2	GH S283 0001 R0278	46220 9				
	3	S 283-Z 3	GH S283 0001 R0318	46240 7				
	4	S 283-Z 4	GH S283 0001 R0338	46290 2				
	6	S 283-Z 6	GH S283 0001 R0378	46310 7				
	8	S 283-Z 8	GH S283 0001 R0408	46360 2				
	10	S 283-Z 10	GH S283 0001 R0428	46380 0				
	16	S 283-Z 16	GH S283 0001 R0468	46400 5				
	20	S 283-Z 20	GH S283 0001 R0488	46420 3				
	25	S 283-Z 25	GH S283 0001 R0518	46440 1				
	32	S 283-Z 32	GH S283 0001 R0538	46460 9				
	40	S 283-Z 40	GH S283 0001 R0558	46480 7				
	50	S 283-Z 50	GH S283 0001 R0578	46500 2				
	63	S 283-Z 63	GH S283 0001 R0608	46520 0				
U _{Bmax} 440 V ~							0.480	

① U_{Bmax} 125 V ∴ with 2 poles connected in series
② max. rated rupturing capacity of the range



SK 0318 B 91

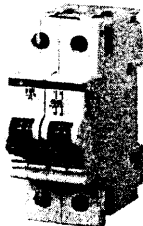

SK 0319 B 91

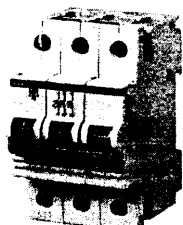

SK 0320 B 91

Selection table

No. of poles	Rated current I _n , A	Ordering details		bbn 40 12233 EAN	Price 1 piece DM	Price group	Weight 1 piece kg	Pack. unit pcs.
		Type No.	Order code					
4	0.5	S 284-Z 0.5	GH S284 0001 R0158	47700 5			0.520	2
	1	S 284-Z 1	GH S284 0001 R0218	47770 8				
	1.6	S 284-Z 1.6	GH S284 0001 R0258	47810 1				
	2	S 284-Z 2	GH S284 0001 R0278	47830 9				
	3	S 284-Z 3	GH S284 0001 R0318	47850 7				
	4	S 284-Z 4	GH S284 0001 R0338	47890 3				
	6	S 284-Z 6	GH S284 0001 R0378	47910 8				
	8	S 284-Z 8	GH S284 0001 R0408	47950 4				
	10	S 284-Z 10	GH S284 0001 R0428	47970 2				
	16	S 284-Z 16	GH S284 0001 R0468	47990 0				
	20	S 284-Z 20	GH S284 0001 R0488	48010 4				
	25	S 284-Z 25	GH S284 0001 R0518	48050 0				
	32	S 284-Z 32	GH S284 0001 R0538	48070 8				
	40	S 284-Z 40	GH S284 0001 R0558	48090 6				
	50	S 284-Z 50	GH S284 0001 R0578	48110 1				
② 63	S 284-Z 63	GH S284 0001 R0608	48130 9					

U_{Bmax}
440 V ~
125 V ∴
②

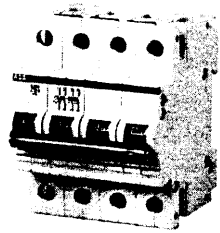

SK 0321 B 91

M.C.B.'s with disconnecting neutral NA

1+NA	0.5	S 281-Z 0.5	GH S281 0103 R0158	44230 0			0.260	5
	1	S 281-Z 1	GH S281 0103 R0218	44280 5				
	1.6	S 281-Z 1.6	GH S281 0103 R0258	44310 9				
	2	S 281-Z 2	GH S281 0103 R0278	44330 7				
	3	S 281-Z 3	GH S281 0103 R0318	44350 5				
	4	S 281-Z 4	GH S281 0103 R0338	44380 2				
	6	S 281-Z 6	GH S281 0103 R0378	44400 7				
	8	S 281-Z 8	GH S281 0103 R0408	44430 4				
	10	S 281-Z 10	GH S281 0103 R0428	44450 2				
	16	S 281-Z 16	GH S281 0103 R0468	44470 0				
	20	S 281-Z 20	GH S281 0103 R0488	44490 8				
	25	S 281-Z 25	GH S281 0103 R0518	44520 2				
	32	S 281-Z 32	GH S281 0103 R0538	44540 0				
	40	S 281-Z 40	GH S281 0103 R0558	44560 8				
	50	S 281-Z 50	GH S281 0103 R0578	44580 6				
63	S 281-Z 63	GH S281 0103 R0608	44600 1					
3+NA	0.5	S 283-Z 0.5	GH S283 0103 R0158	47130 0			0.520	2
	1	S 283-Z 1	GH S283 0103 R0218	47180 5				
	1.6	S 283-Z 1.6	GH S283 0103 R0258	47210 9				
	2	S 283-Z 2	GH S283 0103 R0278	47230 7				
	3	S 283-Z 3	GH S283 0103 R0318	47250 5				
	4	S 283-Z 4	GH S283 0103 R0338	47280 2				
	6	S 283-Z 6	GH S283 0103 R0378	47300 7				
	8	S 283-Z 8	GH S283 0103 R0408	47330 4				
	10	S 283-Z 10	GH S283 0103 R0428	47350 2				
	16	S 283-Z 16	GH S283 0103 R0468	47370 0				
	20	S 283-Z 20	GH S283 0103 R0488	47390 8				
	25	S 283-Z 25	GH S283 0103 R0518	47420 2				
	32	S 283-Z 32	GH S283 0103 R0538	47440 0				
	40	S 283-Z 40	GH S283 0103 R0558	47460 8				
	50	S 283-Z 50	GH S283 0103 R0578	47480 6				
63	S 283-Z 63	GH S283 0103 R0608	47500 1					

U_{Bmax}
440 V ~
60 V ∴

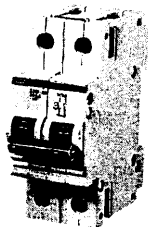

SK 0132 B 93

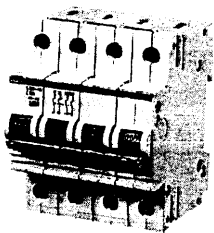

SK 0128 B 93

① max. rated rupturing capacity of the range
② U_{Bmax} 125 V ∴ with 2 poles connected in series

B

acc. to DIN VDE 0641 part 11

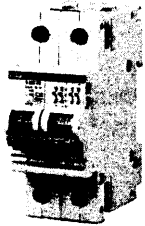

SK 0322 B 91

K

acc. to VDE 0660 part 101
for the protection of
devices such as motors,
transformers, lamps etc.
and for cable protection.



SK 0323 B 91

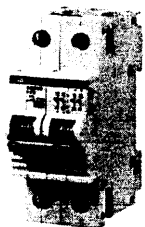

SK 0324 B 91

Selection table

No. of poles	Rated current I _n A	Ordering details		bbn 40 12233 EAN	Price 1 piece DM	Price group	Weight 1 piece kg	Pack. unit pcs.
		Type No.	Order code					
1	6	S 281 UC-B 6	GH S281 0164 R0065	16230 2 ①			0.130	10
	10	S 281 UC-B 10	GH S281 0164 R0105	16240 1 ①				
	16	S 281 UC-B 16	GH S281 0164 R0165	16230 0 ①				
	20	S 281 UC-B 20	GH S281 0164 R0205	16260 9 ①				
	25	S 281 UC-B 25	GH S281 0164 R0255	16270 8 ①				
2	6	S 282 UC-B 6	GH S282 0164 R0065	16280 7 ①			0.260	5
	10	S 282 UC-B 10	GH S282 0164 R0105	16290 6 ①				
	16	S 282 UC-B 16	GH S282 0164 R0165	16200 2 ①				
	20	S 282 UC-B 20	GH S282 0164 R0205	16210 1 ①				
	25	S 282 UC-B 25	GH S282 0164 R0255	16220 0 ①				

① bbn-Nr. 40 16779

Selection table

1	0.2	S 281 UC-K 0.2	GH S281 0164 R0087	63420 0			0.130	10	
	0.3	S 281 UC-K 0.3	GH S281 0164 R0117	63430 9					
	0.5	S 281 UC-K 0.5	GH S281 0164 R0157	63440 8					
	0.75	0.75	S 281 UC-K 0.75	GH S281 0164 R0187	63550 4			0.140	
		1	S 281 UC-K 1	GH S281 0164 R0217	63460 6				
		1.6	S 281 UC-K 1.6	GH S281 0164 R0257	63470 5				
	2	2	S 281 UC-K 2	GH S281 0164 R0277	63480 4				
		3	S 281 UC-K 3	GH S281 0164 R0317	63490 3				
		4	S 281 UC-K 4	GH S281 0164 R0337	63500 9				
	6	6	S 281 UC-K 6	GH S281 0164 R0377	63520 7				
		8	S 281 UC-K 8	GH S281 0164 R0407	63510 8				
		10	S 281 UC-K 10	GH S281 0164 R0427	63530 6				
	16	16	S 281 UC-K 16	GH S281 0164 R0467	63540 5				
		20	S 281 UC-K 20	GH S281 0164 R0487	63560 3				
		25	S 281 UC-K 25	GH S281 0164 R0517	63570 2				
32	32	S 281 UC-K 32	GH S281 0164 R0537	63580 1					
	40	S 281 UC-K 40	GH S281 0164 R0557	63590 0					
	50	S 281 UC-K 50	GH S281 0164 R0577	63600 6					
2	63	S 281 UC-K 63	GH S281 0164 R0607	63610 5			0.260	5	
	0.2	0.2	S 282 UC-K 0.2	GH S282 0164 R0087	63620 4				
		0.3	S 282 UC-K 0.3	GH S282 0164 R0117	63630 3				
		0.5	S 282 UC-K 0.5	GH S282 0164 R0157	63640 2				
	0.75	0.75	S 282 UC-K 0.75	GH S282 0164 R0187	63650 1				
		1	S 282 UC-K 1	GH S282 0164 R0217	63660 0				
		1.6	S 282 UC-K 1.6	GH S282 0164 R0257	63670 9				
	2	2	S 282 UC-K 2	GH S282 0164 R0277	65280 8				
		3	S 282 UC-K 3	GH S282 0164 R0317	63680 8				
		4	S 282 UC-K 4	GH S282 0164 R0337	63690 7				
	6	6	S 282 UC-K 6	GH S282 0164 R0377	63700 3				
		8	S 282 UC-K 8	GH S282 0164 R0407	63710 2				
		10	S 282 UC-K 10	GH S282 0164 R0427	63720 1				
	16	16	S 282 UC-K 16	GH S282 0164 R0467	63730 0				
		20	S 282 UC-K 20	GH S282 0164 R0487	63740 9				
25		S 282 UC-K 25	GH S282 0164 R0517	63750 8					
32	32	S 282 UC-K 32	GH S282 0164 R0537	63760 7					
	40	S 282 UC-K 40	GH S282 0164 R0557	63770 6					
	50	S 282 UC-K 50	GH S282 0164 R0577	63790 4					
2	63	S 282 UC-K 63	GH S282 0164 R0607	63800 0			0.320		

① U_{Bmax} 440 V ~ with 2 poles connected in series

Selection table

No. of poles	Rated current I_n A	Ordering details		bbn 40 12233 EAN	Price 1 piece DM	Price group	Weight 1 piece kg	Pack. unit pcs.
		Type No.	Order code					
3	0.2	S 283 UC-K 0.2	GH S283 0164 R0087	73810 6			0.390	3/12
	0.3	S 283 UC-K 0.3	GH S283 0164 R0117	73820 5				
	0.5	S 283 UC-K 0.5	GH S283 0164 R0157	73830 4				
	0.75	S 283 UC-K 0.75	GH S283 0164 R0187	73840 3				
	1	S 283 UC-K 1	GH S283 0164 R0217	73850 2				
	1.6	S 283 UC-K 1.6	GH S283 0164 R0257	73860 1				
	2	S 283 UC-K 2	GH S283 0164 R0277	73870 0				
	3	S 283 UC-K 3	GH S283 0164 R0317	73880 9				
	4	S 283 UC-K 4	GH S283 0164 R0337	73890 8				
	6	S 283 UC-K 6	GH S283 0164 R0377	73900 4				
	8	S 283 UC-K 8	GH S283 0164 R0407	73910 3				
	10	S 283 UC-K 10	GH S283 0164 R0427	73920 2				
	16	S 283 UC-K 16	GH S283 0164 R0467	73930 1				
	20	S 283 UC-K 20	GH S283 0164 R0487	73940 0				
	25	S 283 UC-K 25	GH S283 0164 R0517	73950 9				
	32	S 283 UC-K 32	GH S283 0164 R0537	73960 8				
	40	S 283 UC-K 40	GH S283 0164 R0557	73970 7				
	50	S 283 UC-K 50	GH S283 0164 R0577	73980 6				
U_{Bmax} 440 V ~ 440 V ∴	63	S 283 UC-K 63	GH S283 0164 R0607	73990 5			0.480	
4	0.2	S 284 UC-K 0.2	GH S284 0164 R0087	73160 1			0.520	2
	0.3	S 284 UC-K 0.3	GH S284 0164 R0117	73170 0				
	0.5	S 284 UC-K 0.5	GH S284 0164 R0157	73180 9				
	0.75	S 284 UC-K 0.75	GH S284 0164 R0187	73190 8				
	1	S 284 UC-K 1	GH S284 0164 R0217	74200 4				
	1.6	S 284 UC-K 1.6	GH S284 0164 R0257	74210 3				
	2	S 284 UC-K 2	GH S284 0164 R0277	74220 2				
	3	S 284 UC-K 3	GH S284 0164 R0317	74230 1				
	4	S 284 UC-K 4	GH S284 0164 R0337	74240 0				
	6	S 284 UC-K 6	GH S284 0164 R0377	74250 9				
	8	S 284 UC-K 8	GH S284 0164 R0407	74260 8				
	10	S 284 UC-K 10	GH S284 0164 R0427	74270 7				
	16	S 284 UC-K 16	GH S284 0164 R0467	74280 6				
	20	S 284 UC-K 20	GH S284 0164 R0487	74300 1				
	25	S 284 UC-K 25	GH S284 0164 R0517	74310 0				
	32	S 284 UC-K 32	GH S284 0164 R0537	74320 9				
	40	S 284 UC-K 40	GH S284 0164 R0557	74330 8				
	50	S 284 UC-K 50	GH S284 0164 R0577	74340 7				
U_{Bmax} 440 V ~ 440 V ∴	63	S 284 UC-K 63	GH S284 0164 R0607	74350 6			0.640	

① U_{Bmax} 440 V ∴ with 2 poles connected in series

SK 0184 B 92

SK 0185 B 92

Selection table

No. of poles	Rated current I _n A	Ordering details Type No.	Order code	bbn 40 12233 EAN	Price 1 piece DM	Price group	Weight 1 piece kg	Pack. unit pcs.	
1	0.5 1 1.6	S 281 UC-Z 0.5	GH S281 0164 R0158	63860 4			0.130	10	
		S 281 UC-Z 1	GH S281 0164 R0218	63870 3					
		S 281 UC-Z 1.6	GH S281 0164 R0258	63880 2					
	2 3 4	S 281 UC-Z 2	GH S281 0164 R0278	63890 1					
		S 281 UC-Z 3	GH S281 0164 R0318	63900 7					
		S 281 UC-Z 4	GH S281 0164 R0338	63910 6					
		6 8 10	S 281 UC-Z 6	GH S281 0164 R0378					63920 5
	S 281 UC-Z 8		GH S281 0164 R0408	63940 3					
	S 281 UC-Z 10		GH S281 0164 R0428	63950 2					
	16 20 25	S 281 UC-Z 16	GH S281 0164 R0468	63960 1					
		S 281 UC-Z 20	GH S281 0164 R0488	63970 0					
		S 281 UC-Z 25	GH S281 0164 R0518	63980 9					
		32 40 50	S 281 UC-Z 32	GH S281 0164 R0538					63990 8
			S 281 UC-Z 40	GH S281 0164 R0558					64000 3
	S 281 UC-Z 50		GH S281 0164 R0578	64010 2					
	U _{Bmax} 440 V ~ 220 V ≍	63	S 281 UC-Z 63	GH S281 0164 R0608					64020 1
2		0.5 1 1.6	S 282 UC-Z 0.5	GH S282 0164 R0158	64030 0			0.260	5
	S 282 UC-Z 1		GH S282 0164 R0218	64040 9					
	S 282 UC-Z 1.6		GH S282 0164 R0258	64230 4					
	2 3 4	S 282 UC-Z 2	GH S282 0164 R0278	64100 0					
		S 282 UC-Z 3	GH S282 0164 R0318	64110 9					
		S 282 UC-Z 4	GH S282 0164 R0338	64120 8					
		6 8 10	S 282 UC-Z 6	GH S282 0164 R0378	64130 7				
	S 282 UC-Z 8		GH S282 0164 R0408	64140 6					
	S 282 UC-Z 10		GH S282 0164 R0428	64150 5					
	16 20 25	S 282 UC-Z 16	GH S282 0164 R0468	64160 4					
		S 282 UC-Z 20	GH S282 0164 R0488	64170 3					
		S 282 UC-Z 25	GH S282 0164 R0518	64180 2					
		32 40 50	S 282 UC-Z 32	GH S282 0164 R0538	64190 1				
			S 282 UC-Z 40	GH S282 0164 R0558	64200 7				
	S 282 UC-Z 50		GH S282 0164 R0578	64210 6					
	U _{Bmax} 440 V ~ 440 V ≍ ①	63	S 282 UC-Z 63	GH S282 0164 R0608	64220 5				
3		0.5 1 1.6	S 283 UC-Z 0.5	GH S283 0164 R0158	74000 0			0.390	3/12
	S 283 UC-Z 1		GH S283 0164 R0218	74010 9					
	S 283 UC-Z 1.6		GH S283 0164 R0258	74020 8					
	2 3 4	S 283 UC-Z 2	GH S283 0164 R0278	74030 7					
		S 283 UC-Z 3	GH S283 0164 R0318	74040 6					
		S 283 UC-Z 4	GH S283 0164 R0338	74050 5					
		6 8 10	S 283 UC-Z 6	GH S283 0164 R0378	74060 4				
	S 283 UC-Z 8		GH S283 0164 R0408	74070 3					
	S 283 UC-Z 10		GH S283 0164 R0428	74080 2					
	16 20 25	S 283 UC-Z 16	GH S283 0164 R0468	74090 1					
		S 283 UC-Z 20	GH S283 0164 R0488	74100 7					
		S 283 UC-Z 25	GH S283 0164 R0518	74110 6					
		32 40 50	S 283 UC-Z 32	GH S283 0164 R0538	74120 5				
			S 283 UC-Z 40	GH S283 0164 R0558	74130 4				
	S 283 UC-Z 50		GH S283 0164 R0578	74140 3					
	U _{Bmax} 440 V ~ 440 V ≍	63	S 283 UC-Z 63	GH S283 0164 R0608	74150 2				
4		0.5 1 1.6	S 284 UC-Z 0.5	GH S284 0164 R0158	74360 5			0.520	2
	S 284 UC-Z 1		GH S284 0164 R0218	74370 4					
	S 284 UC-Z 1.6		GH S284 0164 R0258	74380 3					
	2 3 4	S 284 UC-Z 2	GH S284 0164 R0278	74390 2					
		S 284 UC-Z 3	GH S284 0164 R0318	74400 8					
		S 284 UC-Z 4	GH S284 0164 R0338	74410 7					
		6 8 10	S 284 UC-Z 6	GH S284 0164 R0378	74420 6				
	S 284 UC-Z 8		GH S284 0164 R0408	74430 5					
	S 284 UC-Z 10		GH S284 0164 R0428	74440 4					
	16 20 25	S 284 UC-Z 16	GH S284 0164 R0468	74450 3					
		S 284 UC-Z 20	GH S284 0164 R0488	74460 2					
		S 284 UC-Z 25	GH S284 0164 R0518	74470 1					
		32 40 50	S 284 UC-Z 32	GH S284 0164 R0538	74480 0				
			S 284 UC-Z 40	GH S284 0164 R0558	74490 9				
	S 284 UC-Z 50		GH S284 0164 R0578	74500 5					
	U _{Bmax} 440 V ~ 440 V ≍ ①	63	S 284 UC-Z 63	GH S284 0164 R0608	74510 4				

① U_{Bmax} 440 V ≍ with 2 poles connected in series

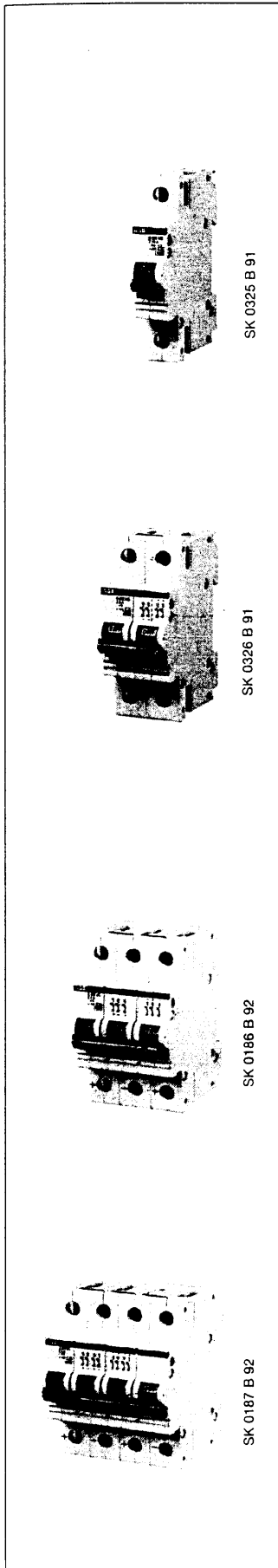

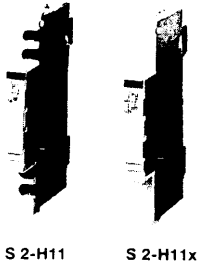

SK 0009 B 95

S 2-H11

S 2-H11x



SK 0332 B 91

S 2-S/H ...



SK 0330 B 91

S 2-A ...



SK 0331 B 91

S 2-NT

Ordering details		bbn 40 12233 EAN	Price 1 piece DM	Price group	Weight 1 piece kg	Pack. unit pcs.
Type No.	Order code					
Auxiliary contact						
Screw connection						
1 S + 1 Ö	S 2-H 11	GH S270 1916 R0001	61500 1		0.04	1
2 S	S 2-H 20	GH S270 1916 R0002	61510 0		0.04	1
2 Ö	S 2-H 02	GH S270 1916 R0003	61520 9		0.04	1
Plug connection 2 x (2.8 x 0.8)						
1 S + 1 Ö	S 2-H 11 X	GH S270 1917 R0001	61530 8		0.04	1
2 S	S 2-H 20 X	GH S270 1917 R0002	61540 7		0.04	1
2 Ö	S 2-H 02 X	GH S270 1917 R0003	61550 6		0.04	1
Screw connection						
2 S + 1 Ö	S 2-H 21	GH S270 1936 R0001	013703 ①		0.05	1
1 S + 2 Ö	S 2-H 12	GH S270 1936 R0002	013802 ①		0.05	1
3 S	S 2-H 30	GH S270 1936 R0003	013901 ①		0.05	1
3 Ö	S 2-H 03	GH S270 1936 R0004	014007 ①		0.05	1
Screw connection low power						
2 S + 1 Ö	S 2-H 21 KL	GH S270 1937 R0001	128100 ①		0.05	1
1 S + 2 Ö	S 2-H 12 KL	GH S270 1937 R0002	128209 ①		0.05	1
3 S	S 2-H 30 KL	GH S270 1937 R0003	128308 ①		0.05	1
3 Ö	S 2-H 03 KL	GH S270 1937 R0004	128407 ①		0.05	1
Signalcontact						
Signal contact	S 2-S	GH S280 1902 R0008	42920 2		0.05	1
Signal contact / aux. contact						
Signal contact / aux. contact with screw connect.	S 2-S/H	GH S280 1901 R0008	42900 4		0.05	1
Undervoltage release						
12 V DC	S 2-UA 12	GH S280 1911 R0001	42970 7		0.07	1
24 V AC/DC	S 2-UA 24	GH S280 1911 R0002	42980 6		0.07	1
48 V AC/DC	S 2-UA 48	GH S280 1911 R0003	79360 0		0.07	1
110 V AC/DC	S 2-UA 110	GH S280 1911 R0004	43000 0		0.07	1
220 V AC/DC	S 2-UA 220	GH S280 1911 R0005	43010 9		0.07	1
380 V AC	S 2-UA 380	GH S280 1911 R0006	79370 9		0.07	1
Shunt trip						
12 ... 60 V ...	S 2-A 1	GH S280 1909 R0001	42930 1		0.145	1
110 ... 415 V ... and	S 2-A 2	GH S280 1909 R0002	42940 0		0.145	1
110 ... 250 V ...						
Hand operated neutral						
	S 2-NT	GH S270 1908 R0001	36610 1		0.06	1
Removable base for S 280 max. I_n = 32 A						
	S 2-EST	GH S280 1925 R0001	127707 ①		0.07	1

① bbn 40 16779

C

acc. to DIN VDE
0641 part 11 for
cable protection

10 000



SK 0043 B 95

D

acc. to
EN 60 898
for cable
protection

10 000

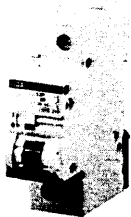

SK 0064 B 97

Selection table

No. of poles	Rated current I_n A	Ordering details		bbn 40 16779 EAN	Price 1 piece DM	Price group	Weight 1 piece kg	Pack. unit pcs.
		Type No.	Order code					
1 U _{Bmax} 440 V AC 60 V AC	80	S 291-C-80	GH S291 1001 R0804	11960 3			0,26	6
	100	S 291-C 100	GHS 291 1001 R0824	11970 2				
	125	S 291-C 125	GHS 291 1001 R0844	11980 1				
2 U _{Bmax} 440 V AC 110 V DC ①	80	S 292-C 80	GHS 292 1001 R0804	11990 0			0,52	3
	100	S 292-C 100	GHS 292 1001 R0824	12000 5				
	125	S 292-C 125	GHS 292 1001 R0844	12010 4				
3 U _{Bmax} 440 V AC	80	S 293-C 80	GHS 293 1001 R0804	12020 3			0,79	2
	100	S 293-C 100	GHS 293 1001 R0824	12030 2				
	125	S 293-C 125	GHS 293 1001 R0844	12040 1				
4 U _{Bmax} 440 V AC 110 V DC ①	80	S 294-C 80	GHS 294 1001 R0804	12050 0			1,05	1
	100	S 294-C 100	GHS 294 1001 R0824	12060 9				
	125	S 294-C 125	GHS 294 1001 R0844	12070 8				

① U_{Bmax} 110 V DC with 2 poles connected in series

Selection table

No. of poles	Rated current I_n A	Ordering details		bbn 40 16779 EAN	Price 1 piece DM	Price group	Weight 1 piece kg	Pack. unit pcs.
		Type No.	Order code					
1 U _{Bmax} 440 V AC 60 V AC	80	S 291-D 80	GHS 291 1001 R0801	12080 7			0,26	6
	100	S 291-D100	GHS 291 1001 R0821	12090 6				
	125	S 291-D125	GHS 291 1001 R0841	12330 3				
2 U _{Bmax} 440 V AC 110 V DC ①	80	S 292-D 80	GHS 292 1001 R0801	12100 2			0,52	3
	100	S 292-D 100	GHS 292 1001 R0821	12150 7				
	125	S 292-D125	GHS 292 1001 R0841	12160 6				
3 U _{Bmax} 440 V AC	80	S 293-D 80	GHS 293 1001 R0801	12170 5			0,79	2
	100	S 293-D 100	GHS 293 1001 R0821	12180 4				
	125	S 293-D125	GHS 293 1001 R0841	12110 1				
4 U _{Bmax} 440 V AC 110 V DC ①	80	S 294-D 80	GHS 294 1001 R0801	12120 0			1,05	1
	100	S 294-D 100	GHS 294 1001 R0821	12130 9				
	125	S 294-D 125	GHS 294 1001 R0841	12140 8				

① U_{Bmax} 110 V DC with 2 poles connected in series

K

10 000

acc. to DIN VDE 0660 part 101 for the protection of devices such as motors, transformers, lamps etc. and for cable protection



SK 0065 B 97



SK 0039 B 95



SK 0040 B 95

Selection table

No. of poles	Rated current I _n A	Ordering details		bbn 40 16779 EAN	Price 1 piece DM	Price group	Weight 1 piece kg	Pack. unit pcs.
		Type No.	Order code					
1 U _{bmax} 440 V AC 60 V DC	80	S 291-K 80	GHS 291 1001 R0807	30880 9			0,26	6
	100	S 291-K 100	GHS 291 1001 R0827	30890 8				
	125	S 291-K 125	GHS 291 1001 R0847	30900 4				
2 U _{bmax} 440 V AC 110 V DC ①	80	S 292-K 80	GHS 292 1001 R0807	30910 3			0,52	3
	100	S 292-K 100	GHS 292 1001 R0827	30920 2				
	125	S 292-K 125	GHS 292 1001 R0847	30930 1				
3 U _{bmax} 440 V AC	80	S 293-K 80	GHS 293 1001 R0807	30940 0			0,79	2
	100	S 293-K 100	GHS 293 1001 R0827	30950 9				
	125	S 293-K 125	GHS 293 1001 R0847	30960 8				
4 U _{bmax} 440 V AC 110 V DC ①	80	S 294-K 80	GHS 294 1001 R0807	30970 7			1,05	1
	100	S 294-K 100	GHS 294 1001 R0827	30980 6				
	125	S 294-K 125	GHS 294 1001 R0847	30990 5				

① U_{bmax} 110 V DC with 2 poles connected in series

Selection table

Description	Ordering details		bbn 40 16779 EAN	Price 1 piece DM	Price group	Weight 1 piece kg	Pack. unit pcs.
	Type No.	Order code					
Auxiliary contact							
Auxiliary contact	S 290-H 11	G HS 290 1916 R0001	12200 9			0,05	1
Signal contact							
Signal contact	S 290-S	G HS 290 1902 R0008	12210 8			0,05	1
Shunt trip							
AC 110 - 415V	S 290-A1	G HS 290 1909 R0001	30030 8			0,09	1
DC 24 - 48V	S 290-A2	G HS 290 1909 R0002	30040 7			0,09	1
Undervoltage release							
DC 24V	S 290-UA 24	G HS 290 1911 R0002	30050 6			0,10	1
DC 110V	S 290-UA 110	G HS 290 1911 R0004	30060 5			0,10	1
AC 230V	S 290-UA 230	G HS 2901911 R0005	30070 4			0,10	1

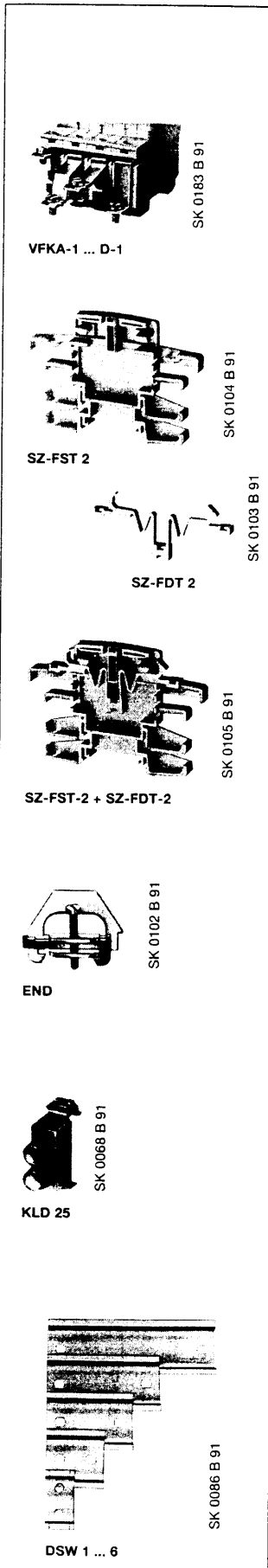

Description	Ordering details		bbrn 40 12233 EAN	Price 1 piece DM	Price group	Weight 1 piece kg	Pack. unit pcs.
	Type No.	Order code					

Extended flat terminals

for busbar connection with slotted or single phase busbars

Terminal	Type No.	Order code	bbrn	Price	Weight	Pack.
A	VFKA-1	GH S270 1211 R0001	36490 9		0.008	10
B	VFKB-1	GH S270 1212 R0001	36500 5		0.013	10
C	VFKC-1	GH S270 1213 R0001	36510 4		0.012	10
D	VFKD-1	GH S270 1214 R0001	36520 3		0.011	10

Filler piece

Width 8.75 mm for us as heat conductor for M.C.B.'s mounted in a row. Two different heights, with break-off sections, for rails acc. to EN 50 022, 35 x 7.5 mm

Type No.	Order code	bbrn	Price	Weight	Pack.
SZ-FST-2	GH L530 1908 R0002	06070 2		0.01	25

Spring part

Carrier for equipment covers, various heights (in combination with filler piece FST-2)

Type No.	Order code	bbrn	Price	Weight	Pack.
SZ-FDT 2	GH L530 1908 R0001	06080 1		0.002	25

Filler plate

Material thickness 1 mm, light grey, to compensate possible tolerances of adjacent M.C.B.'s

Type No.	Order code	bbrn	Price	Weight	Pack.
SZ-FW	GH L530 1901 R0001	06030 6		0.001	25

End clamp

to prevent the units moving sideways along mounting rails to EN 50 022, 35 mm

Type No.	Order code	bbrn	Price	Weight	Pack.
END	GJ I100 1814 R0001	59090 2		0.02	50

Neutral terminals

for fixing on to mounting rails EN 50 022, 35 mm

up to 25 mm ²	Type No.	Order code	bbrn	Price	Weight	Pack.
	KLD 25	GH S210 1921 R0002	13430 4		0.03	10

Connection terminal, pin-type

necessary when conductors of 35 mm² cross section and busbars are connected simultaneously to M.C.B.'s

35 mm ²	Type No.	Order code	bbrn	Price	Weight	Pack.
	SZ-Ast 35	GJ I256 0003 R0010	59860 1		0.014	10

Mounting plates (EN 50 022 - 35 x 7.5)

for fixing M.C.B.'s to flat surface by means of 2 screws (1 Module = 17.5 mm)

for	Type No.	Order code	bbrn	Price	Weight	Pack.
1 Module	DSW 1	GH S210 1926 R0001	13580 6		0.006	10
2 Modules	DSW 2	GH S210 1926 R0002	13590 5		0.012	10
3 Modules	DSW 3	GH S210 1926 R0003	13600 1		0.018	10
4 Modules	DSW 4	GH S210 1926 R0004	13610 0		0.024	10
6 Modules	DSW 6	GH S210 1926 R0006	13620 9		0.036	10



ME 02

SK 0127 B 92



ST

SK 0120 B 91

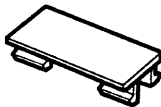

SZ-KZS ...

SK 0018 Z 94



SK 0202 B 93

Description	Ordering details		bbn 40 12233 EAN	Price 1 piece DM	Price group	Weight 1 piece kg	Pack. unit pcs.
	Type No.	Order code					

Mounting kits for flush mounting

Description	Type No.	Order code	bbn	Price	Price group	Weight	Pack.
for 2 Modules	S 500-ME 1	GH S500 1008 R0001	48450 8				
for 5 Modules	S 500-ME 2	GH S500 1008 R0002	48460 7				
for 10 Modules	S 500-ME 3	GH S500 1008 R0003	48470 6				

Terminals for rear connection of main contacts (for flush mounting)

Description	Type No.	Order code	bbn	Price	Price group	Weight	Pack.
up to 25 mm ²	S 500-K 1	GH S500 1210 R0001	48530 7				

Label mats

40 labels labelled or unlabelled. The unlabelled can be labelled by water-resistant and permanent marker or by means of computer-controlled labelling systems (plotter)

Description	Type No.	Order code	bbn	Price	Price group	Weight	Pack.
Label unlabelled	SZ-KZS	GH S210 1946 R0004	00850 1				30
Label numbering 1-40	SZ-KZS/1	GH S210 1946 R0005	00860 0				30
Label numbering 41-80	SZ-KZS/2	GH S210 1946 R0006	00870 9				30
Label numbering 81-120	SZ-KZS/3	GH S210 1946 R0007	00880 8				30
Label numbering 121-160	SZ-KZS/4	GH S210 1946 R0008	00890 7				30
Label with pictograms	SZ-KZS/5	GH S210 1946 R0009	00900 3				30
Label numbering 2x1-20	SZ-KZS/6	GH S210 1946 R0010	05080 7				30
Label numbering 4x1-10	SZ-KZS/9	GH S210 1946 R0013	39050 7				30
Label numbering 4x11-20	SZ-KZS/10	GH S210 1946 R0014	39060 6				30

① bbn-No.: 4016779

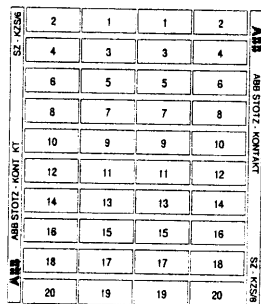

SK 0004 Z 94

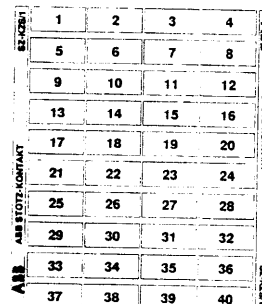

SK 0162 Z 93

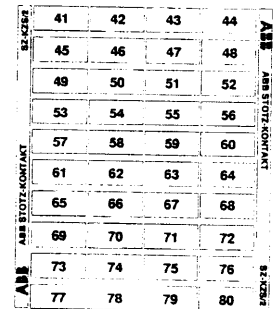

SK 0163 Z 93

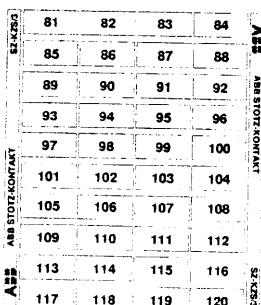

SK 0164 Z 93

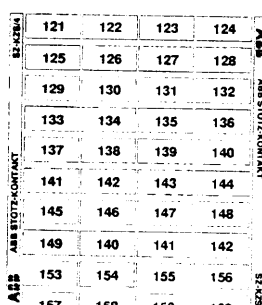

SK 0165 Z 93

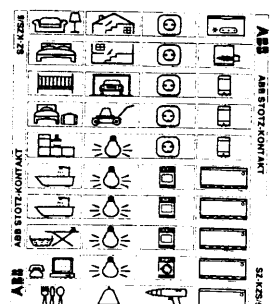

SK 0166 Z 93

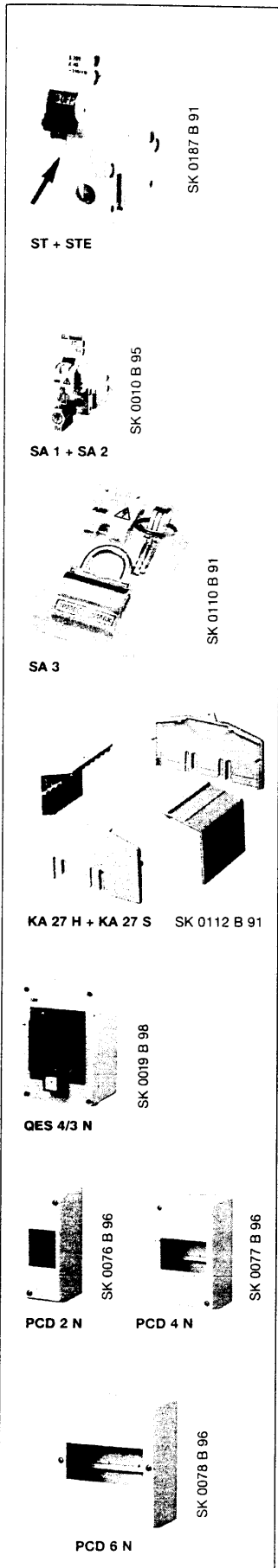

Description	Ordering details		bbn 40 12233 EAN	Price 1 piece DM	Price group	Weight 1 piece kg	Pack. unit pcs.
	Type No.	Order code					

Labelling accessories

Label carrier snap-on fixing	ST	GH S210 6641 P0001	13820 3			0.001	100
Description label 1 sheet = 300 pcs	ST-E	GH V021 0895 R0010	13830 2			0.010	1 sheet
Description labels numbering 1-100 1 sheet = 5 x 1-100	ST-EN	GH S210 1946 R0003	64530 5				1 sheet

Locking device for M.C.B.'s

For prevention of single- or multi-pole M.C.B.'s against dangerous switching on or unauthorized switching-off. For padlock with hasp diameter max. 4 mm and lock width max. 17 mm.

Application

Locking against switching ON:

- Locking against undesired switching ON during maintenance work
- Locking with commissioning notice
- Locking when supply is being blocked

Locking against switching OFF:

- Prevention of unwanted manual switching OFF, e.g. of Alarm, air conditioning, computer installations etc.
- Reclosing after tripping only allowed by authorised persons

Adapter	SA 1	GJ F110 1903 R0001	58760 5			0.02	10
Padlock with 2 keys	SA 2	GJ F110 1903 R0002	58770 4			0.004	10
Adapter incl. padlock with 3 keys	SA 3	GJ F110 1903 R0003	58780 3			0.05	10

Terminal cover KA 27

as a protection against accidental contact with live parts by occasional handling (e.g. in switch-boards) according to the accident prevention regulations (e.g. VBG 4); comprising side pieces 475 mm long = 27 modules each 17.5 mm which can be cut to the required size end pieces; can be snapped onto mounting rail EN 50 022, 35 mm. Side and end pieces must be separately ordered.

Side piece, 1 piece	KA 27 H	GH S210 1933 R0001	13630 8			0.104	10
End piece, 1 piece	KA 27 S	GH D210 1934 R0001	13640 7			0.027	10

Insulated enclosure, protection category IP 55

Complete with DIN rail EN 50022 and 3 cable entry sockets PG 21, knockouts: on top 1 x PG 21, on bottom 2 x PG 21 (housing can be turned 180°)

for 4 modules	QES 4/3 N	GH L111 2304 R0013	12644 0			0,330	1
---------------	-----------	--------------------	---------	--	--	-------	---

① bbn-No. 80 00126

Terminal cover PCD with base plate, Prot. cat. IP 20

The terminal cover is snapped onto the base plate and is sealable. The base has an integrated mounting rail for snap-on equipment such as M.C.B.'s, RCD's, Manual motor starters and other modular installation equipment.

Terminal cover with base plate

for 2 modules	PCD 2 N	GH S270 1921 R0002	28530 8	①			1
for 4 modules	PCD 4 N	GH S270 1921 R0004	28540 7	①			1
for 6 modules	PCD 6 N	GH S270 1921 R0006	28550 6	①			1
for 8 modules	PCD 8 N	GH S270 1921 R0008	28560 5	①			1

① bbn-Nr. 40 16779

Accessories

Earth bar for subsequent mounting	ES	GH S270 1912 R0001	36660 6			0.08	10
Blanking plate 1 Module = 17.5 mm Division: ½ module	BP	GH S270 1913 R0001	36670 5			0.005	10

Supplementary devices

Description	Ordering details		bbn	Price	Price group	Weight 1 piece kg	Pack. unit pcs.
	Type No.	Order code	40 12233 EAN	1 piece DM			

Filler piece FST

Width 8.75 mm as heat conductor for M.C.B.'s mounted in a row. Three different heights, with break-off sections, for rails acc. to EN 50 022, 35 mm.

	SZ-FST	GJI 1480 003 R0001	59410 8			0.10	25
--	---------------	--------------------	----------------	--	--	------	----

Push-on terminals

for 2 connectors 2.8 mm without insulation (max. 8 A), push-on terminals HSTF also for 1 connector 6.3 mm with insulation (max. 20 A)

for main poles 2 x 2.8 - 0.5 or 1 x 6.3 - 0.5	HSTF	GH S210 4555 P0001	65880 0			0.002	50
for aux. contacts 2 x 2.8 - 0.5 2 x 2.8 - 0.8	HISTF	GH S210 4554 P0001	65890 9			0.002	100
	HISTF 2	GH S210 4554 P0002	65900 5			0.002	100

Enclosure of moulded plastic for units with a depth of 1 module

	E 430-AP	GH V021 0895 R0100	53030 4				10
--	-----------------	--------------------	----------------	--	--	--	----

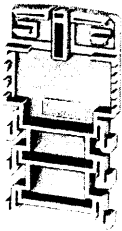

SK 0184 B 91

SZ-FST



SK 0023 Z 95

HSTF



SK 0024 Z 95

HISTF



SK 0118 B 91





E430-AP

Selection table

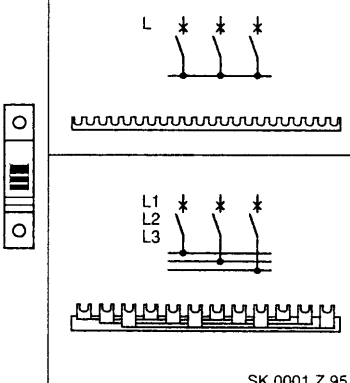
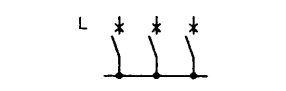
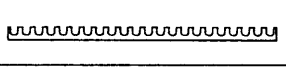

M.C.B.	Busbar connection	Cross section mm ²	Length mm	Poles No.	Ordering details		bbn 40 12233 EAN	Price 1 piece DM	Price group	Weight 1 piece kg	Pack. unit pcs.
					Type No.	Order code					

Busbars for M.C.B.'s without supplementary devices

for single pole M.C.B.'s

		12	988	56 x 1	SZ-KS 1/56	GJI 2 322 322 R0003	59800 7			0.073	50
		24	988	56 x 1	SZ-KS 2/56	GJI 2 322 322 R0004	59820 5			0.138	50
		36	988	56 x 1	SZ-VB 45.32	GJI 2 322 148 R0001	59720 8			0.33	50
		10	1065	20 x 3	SZ-PSB 4 N ①	GH L520 1915 R0004	05940 9			0.468	10
		16	1065	20 x 3	SZ-PSB 12 N ②	GH L520 1916 R0004	05960 7			0.70	10

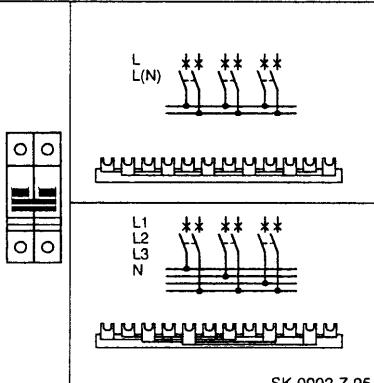
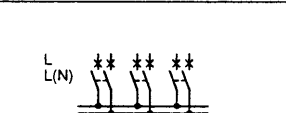
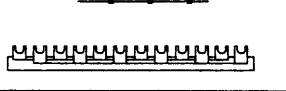

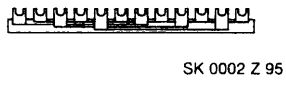
for 2 pole M.C.B.'s

		10	1035	29 x 2	SZ-PSB 54 N ③	GH V036 0874 R0032	54950 4			0.403	10
		16	1035	29 x 2	SZ-PSB 56 N ③	GH V036 0874 R0034	54970 2			0.534	10
		10	1048	29 x 2	SZ-PSB 58 N ③	GH V036 0874 R0036	54990 0			0.626	10
		16	1048	29 x 2	SZ-PSB 60 N ③	GH V036 0874 R0038	55010 4			0.861	10

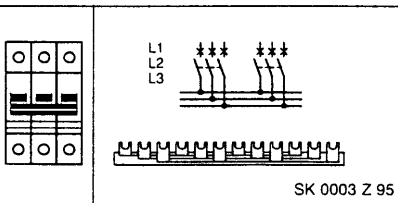
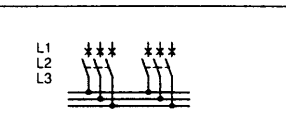
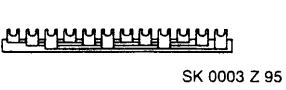
for 3 pole M.C.B.'s

		10	1065	20 x 3	SZ-PSB 4 N ①	GH L520 1915 R0004	05940 9			0.468	10
		16	1065	20 x 3	SZ-PSB 12 N ②	GH L520 1916 R0004	05960 7			0.70	10

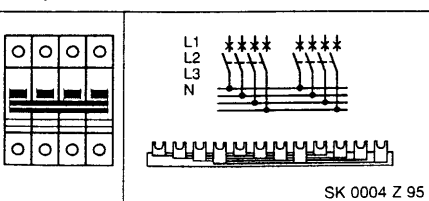
for 4 pole M.C.B.'s

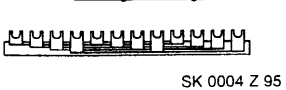

		10	1056	15 x 4	SZ-PSB 62 N ③	GH V036 0874 R0040	55030 2			0.650	10
		16	1056	15 x 4	SZ-PSB 64 N ③	GH V036 0874 R0042	550 50 0			0.884	10

① ② ③ End caps for busbar blocks see page 78

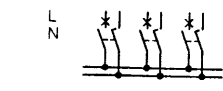
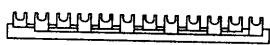

Selection table

M.C.B.	Busbar connection	Cross section mm ²	Length mm	Poles No.	Ordering details		bbn 40 12233 EAN	Price 1 piece DM	Price group	Weight 1 piece kg	Pack. unit pcs.
					Type No.	Order code					

Busbars for M.C.B.'s without supplementary devices for single pole M.C.B.'s with disconnecting neutral NA

		SK 0005 Z 95	10	1035	29 x 2	SZ-PSB 54 N ③	GH V036 0874 R0032	54950 4			0.403	10
			16	1035	29 x 2	SZ-PSB 56 N ③	GH V036 0874 R0034	54970 2			0.534	10
		SK 0005 Z 95	10	1048	29 x 2	SZ-PSB 58 N ③	GH V036 0874 R0036	54990 0			0.626	10
			16	1048	29 x 2	SZ-PSB 60 N ③	GH V036 0874 R0038	55010 4			0.861	10

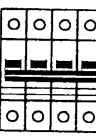
for 3 pole M.C.B.'s with disconnecting neutral NA

		SK 0006 Z 95	10	1056	15 x 4	SZ-PSB 62 N ③	GH V036 0874 R0040	55030 2			0.650	10
			16	1056	15 x 4	SZ-PSB 64 N ③	GH V036 0874 R0042	55050 0			0.884	10

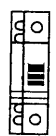
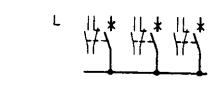
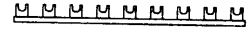
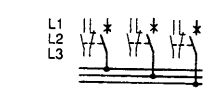
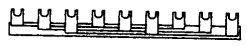

Busbars for M.C.B.'s with aux. contact H... or combined signal contact/aux. contact S/H for single pole M.C.B.'s with H... or S/H

		SK 0007 Z 95	10	1044	39 x 1	SZ-KS 3/39 N ③	GH V036 0874 R0060	55130 9			0.206	10
			16	1044	39 x 1	SZ-KS 4/39 N ③	GH V036 0874 R0004	55150 7			0.283	10
		SK 0007 Z 95	10	1044	13 x 3	SZ-PSB 46 N ③	GH V036 0874 R0024	54870 5			0.451	10
			16	1044	13 x 3	SZ-PSB 48 N ③	GH V036 0874 R0026	54890 3			0.620	10

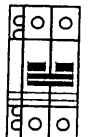
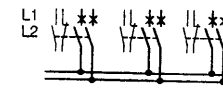
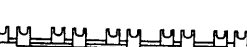
for 2 pole M.C.B.'s with H... or S/H

		SK 0008 Z 95	-									
			16	1065	24 x 2	SZ-PSB 92 N	GH V036 0875 R0010	55380 8			0.650	10

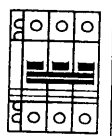
or 3 pole M.C.B.'s with H... or S/H

		SK 0009 Z 95	10	980	16 x 3	SZ-PSB 50 N ③	GH V036 0874 R0028	54910 8			0.442	10
			16	980	16 x 3	SZ-PSB 52 N ③	GH V036 0874 R0030	54930 6			0.632	10

③ End caps see below

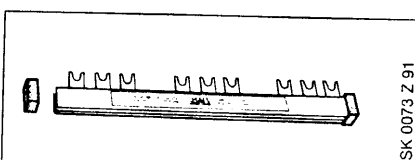

End caps for comb busbar blocks SZ-PSB ...

suitable ①	PSB-END 1	GH L520 1921 R0001	06000 9			50
for ②	PSB-END 2	GH L520 1921 R0002	06010 8			50
suitable ③	PSB-END 3	GH V036 1325 R0001	55630 4			50

Miniature Circuit Breakers Accessories for the use of M.C.B.'s in Busbar Systems

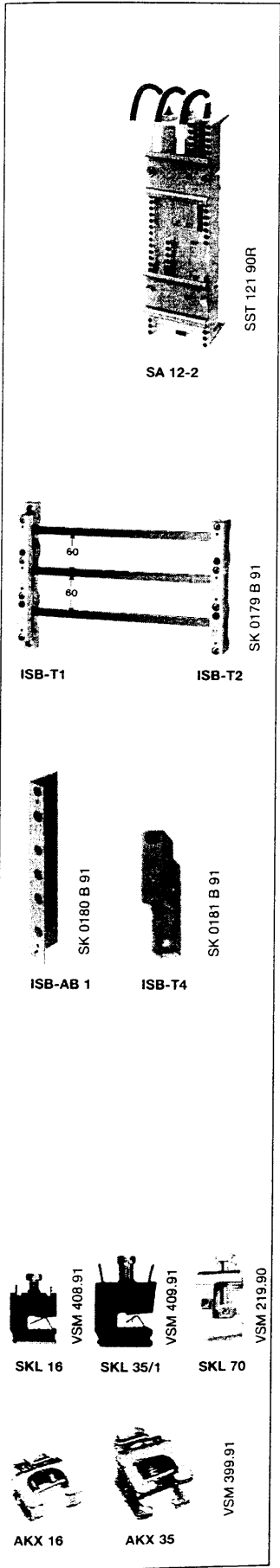

Description	Ordering details		bbn 40 12233 EAN	Price 1 piece DM	Price group	Weight 1 piece kg	Pack. unit pcs.
	Type No.	Order code					

Adapter for busbars with a distance of 40 mm and 50 mm
for direct mounting M.C.B.'s to busbars 12 ... 15 x 5 mm

I_n max. = 32 A	SA 11-2	GJ M620 1910 R0211	05858 5 ①			0.066	1
-------------------	---------	--------------------	-----------	--	--	-------	---

Adapter for busbars with a distance of 60 mm

for direct mounting a motor starter combination (consisting of a M.C.B.'s and a contactor)
to busbars 12 ... 30 x 5 mm

I_n max. = 32 A	SA 12-2	GJ M620 1910 R0212	05859 2 ①			0.115	1
-------------------	---------	--------------------	-----------	--	--	-------	---

① bbn-No. 40 13614

Busbar carrier

suitable for fitting in all types of enclosures e.g. moulded plastic or sheet steel.

The fixing holes of busbar carrier have a distance of 25 mm.

max. carrier distance							
busbar	12 x 5 up to 20 x 5 mm					= max. 350 mm	
cross section	25 x 5 up to 30 x 5 and 12 x 10 up to 30 x 10 mm					= max. 500 mm	

Busbar carrier for 60 mm busbar distance

Busbar carrier for busbars	ISB-T1	GHV 024 0849 R0001	54090 7			0.170	10
12 x 5 ... 10 up to 30 x 5 ... 10 mm	ISB-T2	GHV 024 0849 R0002	54100 3			0.155	10

Carrier for P/EN busbars

for busbars 12 x 5 ... 10 up to 30 x 5 ... 10 mm

for sep. mounting	ISB-T3	GHV 024 0849 R0003	54110 2			0.045	10
to be flanged to busbars ISB-T1 and T2	ISB-T4	GHV 024 0849 R0003	54330 4			0.045	10

Insulation cap for busbar ends

	ISB-AB1	GHV 024 0849 R0004	54120 2			0.025	10
--	---------	--------------------	---------	--	--	-------	----

Busbar connection terminals

for busbars mm	cross sect. of connect. max. mm ²	Ordering details		bbn 40 16779 EAN	Price 1 piece DM	Price group	Weight 1 piece kg	Pack. unit pcs.
		Type No.	Order code					
12 x 5	1.5 ... 16	SKL 16	GH L290 1200 R0001	00420 6			0.010	100
	1.5 ... 35	SKL 35/1	GH L290 1200 R0002	00430 5			0.028	100
	16 ... 70	SKL 70	GH L290 1200 R0003	00440 4			0.055	100
12 x 5 and 12 x 10	up to 16	AKX 16	GH L290 1200 R0008	00370 4			0.015	10
12 x 5	up to 35	AKX 35	GH L290 1200 R0009	00380 3			0.035	10

ABB STOTZ-KONTAKT develops, manufactures and distributes most modern systems for the electrical building installation.

Moreover STOTZ products are produced and distributed in many other countries of the world through associated companies and licensees.

Under the STOTZ quality mark the company offers complete building installation systems:

System pro M

For Universal Use

The universal, modular System pro M for DIN rail installation includes a complete range of built-in devices for protection, switching, control and monitoring functions alongside Europe's best-selling miniature circuit breakers, not to mention time-saving wiring and installation tools.

EIB- Installation Systems

Intelligent Installation Systems

Modern programmable installation systems using bus technology based on the European EIB-Standards.

ABB i-bus® EIB

The system using a dedicated 2-core bus cable: the preference for new buildings.

ABB Powernet EIB

The system for building modernisation. Information transfer takes place over the existing power network.

Security Systems

For all-round protection

A complete program of security systems and components:

- Wireless alarm systems
- Intruder and fire alarm systems
- Door closure equipment
- Signalling components



ABB STOTZ-KONTAKT GmbH

P.O. Box 10 16 80
D-69006 Heidelberg
Phone 0 62 21 / 701 - 00
Fax 0 62 21 / 701 - 723
www.abb-stotz-kontakt.de

X-ON Electronics

Largest Supplier of Electrical and Electronic Components

Click to view similar products for [abb](#) manufacturer:

Other Similar products are found below :

[TV10-516R](#) [017667013](#) [RF727](#) [2CMA100178R1000](#) [5SDD 92Z0401](#) [ESV14-BS](#) [EZS-21-250](#) [F204AC-40/0.03](#) [F362-25/0.03](#)

[GJL1211001R0011](#) [GJL1211201R8000](#) [GJL1211501R8000](#) [GJL1213001R0017](#) [GJL1213001R0101](#) [GJL1311001R0101](#) [GJL1311001R8010](#)

[GJL1311201R0001](#) [GJL1313001R0011](#) [GJL1313001R0101](#) [GJL1317201R0001](#) [A40-30-10-84](#) [AF09-30-01-11](#) [AF460-30-11-68](#) [1455](#) [B14-](#)

[250](#) [EF45-30](#) [ERG297](#) [HSC2-20](#) [1SAM201904R1001](#) [1SAM350000R1003](#) [1SAZ721201R1009](#) [1SAZ721201R1014](#) [1SAZ721201R1025](#)

[1SDA057197R1](#) [1SFA611101R1002](#) [1SFA611130R1103](#) [1SFA611131R1101](#) [1SFA611143R1101](#) [1SFA611202R1108](#) [1SFA611203R1108](#)

[1SFA611215R1001](#) [1SFA611216R1108](#) [1SFA611285R1002](#) [1SFA611702R6006](#) [1SFA616162R1025](#) [1SFA619100R3015](#)

[1SVR730020R0200](#) [IPC4111](#) [OS30FACC12](#) [OS60GJ03](#)