

---

PRODUCT OVERVIEW

# PrimEvo Emergency Lighting

for optimised productivity and reliability





## PrimEvo XT100E

Productivity & reliability



### PrimEvo XT100E

- **Global availability**  
Available at your local wholesaler
- **Easy to install**  
Plug and play, maintained and non-maintained in one
- **Unique 3 year warranty**
- **Affordable range**  
Full LED range with best price/performance ratio

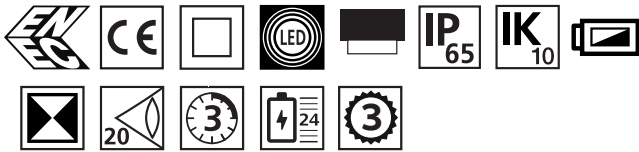

### Luminaire

| Order Code      | Input voltage        | Description          | Lamp type | Power consumption (VA/W) | Operation duration (hrs) | Environment temperature (°C) | Weight (kg) | Configurable pictograms included |
|-----------------|----------------------|----------------------|-----------|--------------------------|--------------------------|------------------------------|-------------|----------------------------------|
| 7TCA091160R0499 | 220 - 240 Vac, 50 Hz | XT100E 2 x 0.5W LED* |           | 5/2                      | 3                        | 0 - +40                      | 0.6         |                                  |

\* = 1W LED

### Spacing table

| Mounting height (m) |      |      |      |      |      |
|---------------------|------|------|------|------|------|
| 2.00                | 2.97 | 7.80 | 8.14 | 8.61 | 3.33 |
| 2.50                | 3.09 | 8.38 | 8.72 | 9.18 | 3.32 |
| 3.00                | 3.22 | 8.78 | 8.96 | 9.42 | 3.33 |
| 3.50                | 3.15 | 9.03 | 9.16 | 9.47 | 3.15 |
| 4.00                | 3.01 | 9.16 | 9.25 | 9.50 | 3.01 |

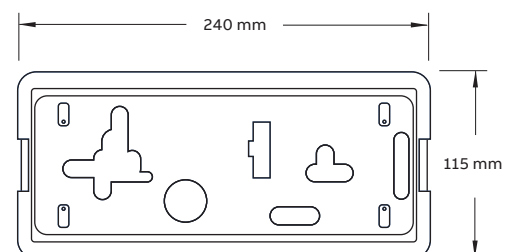



## PrimEvo XT200E

Productivity & reliability



### PrimEvo XT200E

- **Global availability**  
Available at your local wholesaler
- **Easy to install**  
Plug and play, maintained and non-maintained in one
- **Unique 3 year warranty**
- **Affordable range**  
Full LED range with best price/performance ratio

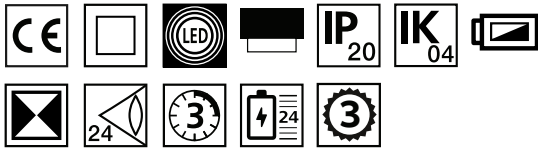

### Luminaire

| Order Code      | Input voltage     | Description | Lamp type       | Power consumption (VA/W) | Operation duration (hrs) | Environment temperature (°C) | Weight (kg) | Configurable pictograms included |
|-----------------|-------------------|-------------|-----------------|--------------------------|--------------------------|------------------------------|-------------|----------------------------------|
| 7TCA091720R0090 | 220 - 240 Vac, 50 | XT200E      | 14 x 0.125W LED | 5.2/2.4                  | 3                        | -5 - +45                     | 0.95        |                                  |

\* = 1.75W LED

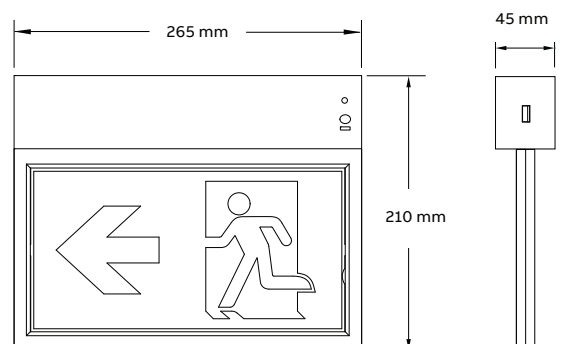



## PrimEvo RS100E & SM100E

Productivity & reliability



RS100E



SM100E

### PrimEvo RS100E & SM100E

- **Global availability**  
Available at your local wholesaler
- **Easy to install**  
Plug and play, maintained and non-maintained in one
- **Unique 3 year warranty**
- **Affordable range**  
Full LED range with best price/performance ratio

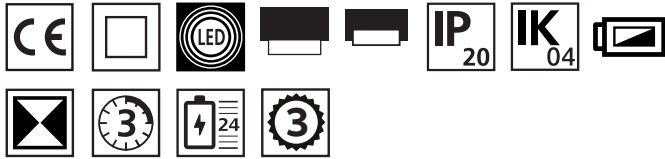

### Luminaire

| Order Code      | Input voltage        | Description | Lamp type     | Power consumption** (VA/W) | Operation duration (hrs) | Environment temperature (°C) | Weight (kg) |
|-----------------|----------------------|-------------|---------------|----------------------------|--------------------------|------------------------------|-------------|
| 7TCA091720R0091 | 220 - 240 Vac, 50 Hz | RS100E      | 2 x 1.5W LED* | 10/4.8                     | 3                        | 0 - +25                      | 0.425       |
| 7TCA091720R0092 | 220 - 240 Vac, 50 Hz | SM100E      | 2 x 1.5W LED* | 9/4.5                      | 3                        | 0 - +25                      | 0.425       |

\* = 3W LED

\*\* maintained mode

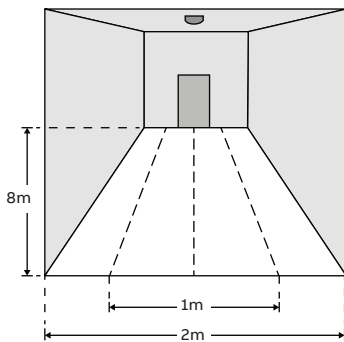

### PrimEvo RS100E

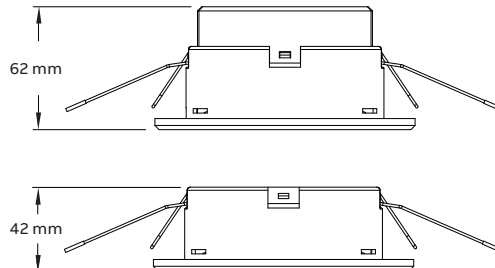
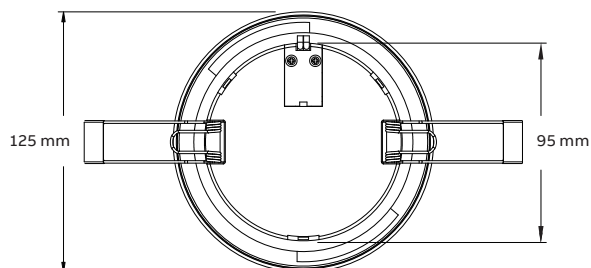

### PrimEvo SM100E

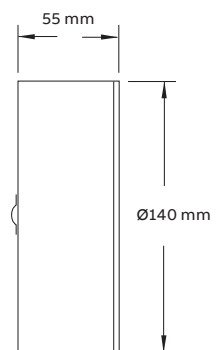



—  
**ABB Ltd**  
**Electrification Products**  
Tower Court  
Courtaulds Way  
Foleshill Enterprise Park  
Coventry  
West Midlands  
CV6 5NX  
Sales Tel: +44 (0) 333 999 9900  
Sales Fax: +44 (0) 333 999 9901  
E-Mail: [lv.enquiries@gb.abb.com](mailto:lv.enquiries@gb.abb.com)

[www.abb.com](http://www.abb.com)



9AKK106930A8304 REV A 05.04.2017



## X-ON Electronics

Largest Supplier of Electrical and Electronic Components

*Click to view similar products for [ABB manufacturer:](#)*

Other Similar products are found below :

[TY27MX](#) [TV10-516R](#) [017667013](#) [RF727](#) [2CMA100178R1000](#) [ACS150-01E-09A8-2](#) [ACS355-03E-15A6-4](#) [KS70-1104](#) [A75-30-11-230V-50HZ](#) [CP1-10Y-20](#) [10-100](#) [5SDD](#) [92Z0401](#) [ESV14-BS](#) [EZS-21-250](#) [F204AC-40/0.1](#) [F362-25/0.03](#) [A40-30-10-84](#) [AF09-30-01-11](#)  
[AF460-30-11-68](#) [AF50-30-11-70](#) [1455](#) [EF45-30](#) [ERG297](#) [18RA-10](#) [HSC2-20](#) [1SAM201904R1001](#) [1SAM350000R1003](#) [1SAZ721201R1009](#)  
[1SAZ721201R1014](#) [1SAZ721201R1025](#) [1SDA057197R1](#) [1SFA611101R1002](#) [1SFA611130R1103](#) [1SFA611143R1101](#) [1SFA611201R1006](#)  
[1SFA611202R1001](#) [1SFA611202R1007](#) [1SFA611202R1103](#) [1SFA611202R1108](#) [1SFA611203R1108](#) [1SFA611204R1007](#)  
[1SFA611205R1006](#) [1SFA611205R1103](#) [1SFA611205R1104](#) [1SFA611210R1101](#) [1SFA611210R1108](#) [1SFA611211R1001](#)  
[1SFA611211R1006](#) [1SFA611211R1007](#) [1SFA611211R1102](#)