

The S-1170 Series is a positive voltage regulator with a low dropout voltage, high-accuracy output voltage, and low current consumption developed based on CMOS technology.

A built-in low on-resistance transistor provides a low dropout voltage and large output current, a built-in overcurrent protection circuit prevents the load current from exceeding the current capacity of the output transistor, and a built-in thermal shutdown circuit prevents damage caused by the heat. An ON/OFF circuit ensures a long battery life. Compared with the voltage regulators using the conventional CMOS technology, a larger variety of capacitors are available, including small ceramic capacitors. Small SOT-89-5 and 6-Pin HSON(A) packages realize high-density mounting.

## ■ Features

- Output voltage: 1.5 V to 5.5 V, selectable in 0.1 V step
- Output voltage accuracy:  $\pm 1.0\%$
- Dropout voltage: 120 mV typ. (3.0 V output product,  $I_{OUT} = 300$  mA)
- Current consumption: During operation: 80  $\mu$ A typ., 160  $\mu$ A max.  
During power-off: 0.1  $\mu$ A typ., 1.0  $\mu$ A max.
- Output current: Possible to output 800 mA ( $V_{IN} \geq V_{OUT(S)} + 1.0$  V)<sup>\*1</sup>
- Input and output capacitors: A ceramic capacitor of 4.7  $\mu$ F or more can be used.
- Ripple rejection: 70 dB typ. (f = 1.0 kHz)
- Built-in overcurrent protection circuit: Limits overcurrent of output transistor.
- Built-in thermal shutdown circuit: Prevents damage caused by heat.
- Built-in ON/OFF circuit: Ensures long battery life.
- Operation temperature range:  $T_a = -40^\circ\text{C}$  to  $+85^\circ\text{C}$
- Lead-free, Sn 100%, halogen-free<sup>\*2</sup>

\*1. Attention should be paid to the power dissipation of the package when the output current is large.

\*2. Refer to “**■ Product Name Structure**” for details.

## ■ Applications

- Constant-voltage power supply for DVD and CD-ROM drive
- Constant-voltage power supply for battery-powered device
- Constant-voltage power supply for personal communication device
- Constant-voltage power supply for notebook PC

## ■ Packages

- SOT-89-5
- 6-Pin HSON(A)

■ Block Diagram

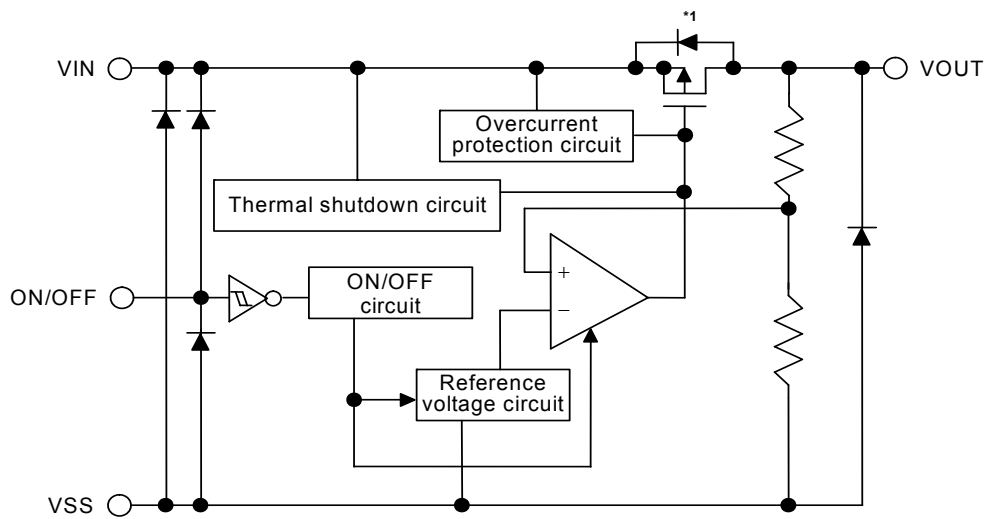

\*1. Parasitic diode

Figure 1

■ **Product Name Structure**

Users can select the product type, output voltage, and package type for the S-1170 Series. Refer to “1. **Product name**” regarding the contents of product name, “2. **Packages**” regarding the package drawings, “3. **Product name list**” regarding details of the product name.

1. **Product name**

(1) **SOT-89-5**

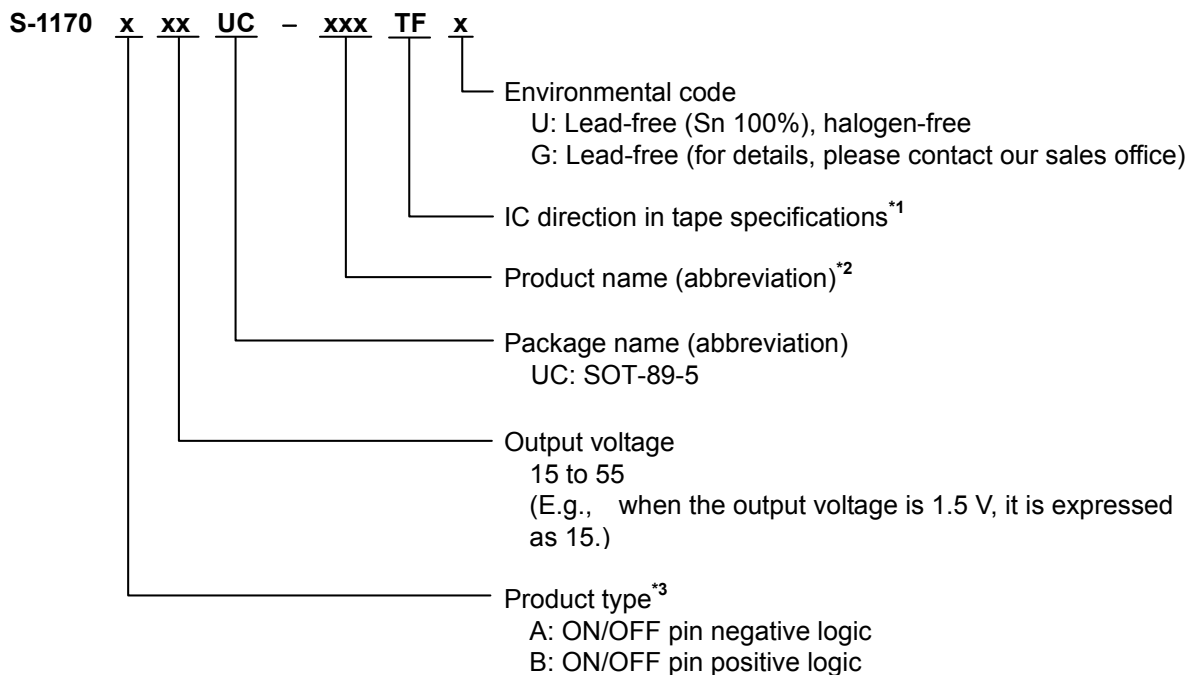

\*1. Refer to the tape drawing.

\*2. Refer to the product name list.

\*3. Refer to “3. ON/OFF pin” in “■ Operation”.

**(2) 6-Pin HSON(A)**

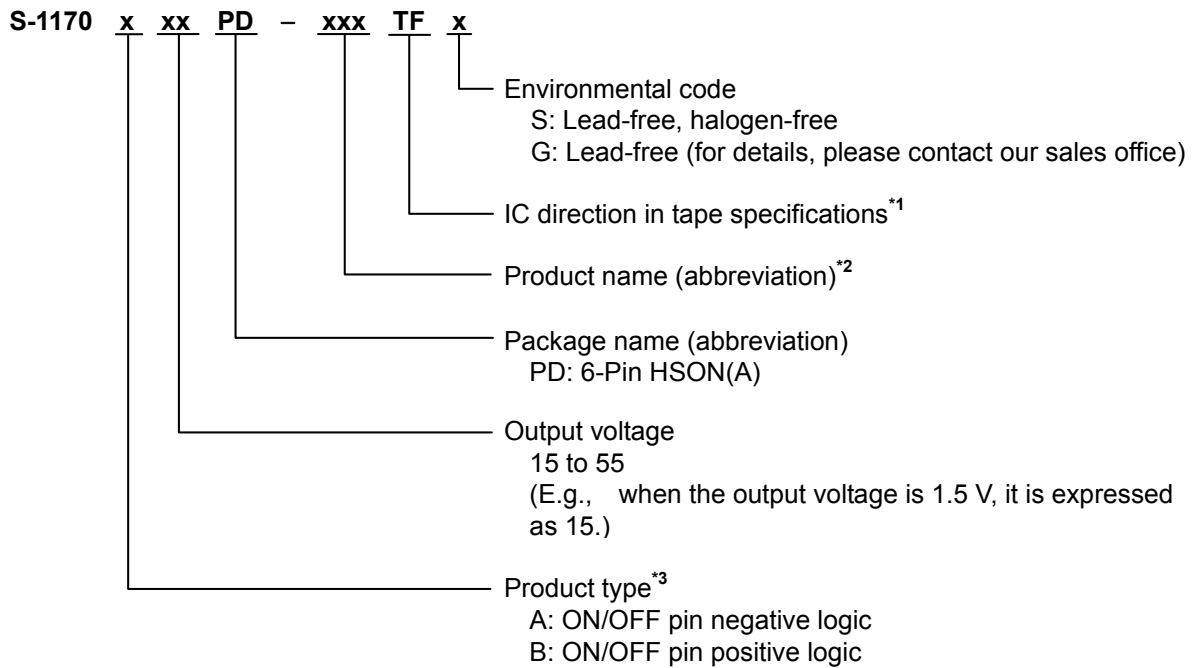

- \*1. Refer to the tape drawing.
- \*2. Refer to the product name list.
- \*3. Refer to “3. ON/OFF pin” in “■ Operation”.

**2. Packages**

Package Name	Drawing Code		
	Package	Tape	Reel
SOT-89-5	UP005-A-P-SD	UP005-A-C-SD	UP005-A-R-SD
6-Pin HSON(A)	PD006-A-P-SD	PD006-A-C-SD	PD006-A-R-SD

3. Product name list

Table 1

Output Voltage	SOT-89-5	6-Pin HSON(A)
1.5 V ±1.0%	S-1170B15UC-OTATF <sub>x</sub>	S-1170B15PD-OTATF <sub>z</sub>
1.6 V ±1.0%	S-1170B16UC-OTBTF <sub>x</sub>	S-1170B16PD-OTBTF <sub>z</sub>
1.7 V ±1.0%	S-1170B17UC-OTCTF <sub>x</sub>	S-1170B17PD-OTCTF <sub>z</sub>
1.8 V ±1.0%	S-1170B18UC-OTDTF <sub>x</sub>	S-1170B18PD-OTDTF <sub>z</sub>
1.9 V ±1.0%	S-1170B19UC-OTETF <sub>x</sub>	S-1170B19PD-OTETF <sub>z</sub>
2.0 V ±1.0%	S-1170B20UC-OTFTF <sub>x</sub>	S-1170B20PD-OTFTF <sub>z</sub>
2.1 V ±1.0%	S-1170B21UC-OTGTF <sub>x</sub>	S-1170B21PD-OTGTF <sub>z</sub>
2.2 V ±1.0%	S-1170B22UC-OTHTF <sub>x</sub>	S-1170B22PD-OTHTF <sub>z</sub>
2.3 V ±1.0%	S-1170B23UC-OTITF <sub>x</sub>	S-1170B23PD-OTITF <sub>z</sub>
2.4 V ±1.0%	S-1170B24UC-OTJTF <sub>x</sub>	S-1170B24PD-OTJTF <sub>z</sub>
2.5 V ±1.0%	S-1170B25UC-OTKTF <sub>x</sub>	S-1170B25PD-OTKTF <sub>z</sub>
2.6 V ±1.0%	S-1170B26UC-OTLTF <sub>x</sub>	S-1170B26PD-OTLTF <sub>z</sub>
2.7 V ±1.0%	S-1170B27UC-OTMTF <sub>x</sub>	S-1170B27PD-OTMTF <sub>z</sub>
2.8 V ±1.0%	S-1170B28UC-OTNTF <sub>x</sub>	S-1170B28PD-OTNTF <sub>z</sub>
2.9 V ±1.0%	S-1170B29UC-OTOTF <sub>x</sub>	S-1170B29PD-OTOTF <sub>z</sub>
3.0 V ±1.0%	S-1170B30UC-OTPTF <sub>x</sub>	S-1170B30PD-OTPTF <sub>z</sub>
3.1 V ±1.0%	S-1170B31UC-OTQTF <sub>x</sub>	S-1170B31PD-OTQTF <sub>z</sub>
3.2 V ±1.0%	S-1170B32UC-OTRTF <sub>x</sub>	S-1170B32PD-OTRTF <sub>z</sub>
3.3 V ±1.0%	S-1170B33UC-OTSTF <sub>x</sub>	S-1170B33PD-OTSTF <sub>z</sub>
3.4 V ±1.0%	S-1170B34UC-OTTF <sub>x</sub>	S-1170B34PD-OTTF <sub>z</sub>
3.5 V ±1.0%	S-1170B35UC-OTUTF <sub>x</sub>	S-1170B35PD-OTUTF <sub>z</sub>
3.6 V ±1.0%	S-1170B36UC-OTVTF <sub>x</sub>	S-1170B36PD-OTVTF <sub>z</sub>
3.7 V ±1.0%	S-1170B37UC-OTWTF <sub>x</sub>	S-1170B37PD-OTWTF <sub>z</sub>
3.8 V ±1.0%	S-1170B38UC-OTXTF <sub>x</sub>	S-1170B38PD-OTXTF <sub>z</sub>
3.9 V ±1.0%	S-1170B39UC-OTYTF <sub>x</sub>	S-1170B39PD-OTYTF <sub>z</sub>
4.0 V ±1.0%	S-1170B40UC-OTZTF <sub>x</sub>	S-1170B40PD-OTZTF <sub>z</sub>
4.1 V ±1.0%	S-1170B41UC-OUATF <sub>x</sub>	S-1170B41PD-OUATF <sub>z</sub>
4.2 V ±1.0%	S-1170B42UC-OUBTF <sub>x</sub>	S-1170B42PD-OUBTF <sub>z</sub>
4.3 V ±1.0%	S-1170B43UC-OUCTF <sub>x</sub>	S-1170B43PD-OUCTF <sub>z</sub>
4.4 V ±1.0%	S-1170B44UC-OUDTF <sub>x</sub>	S-1170B44PD-OUDTF <sub>z</sub>
4.5 V ±1.0%	S-1170B45UC-OUETF <sub>x</sub>	S-1170B45PD-OUETF <sub>z</sub>
4.6 V ±1.0%	S-1170B46UC-OUFTF <sub>x</sub>	S-1170B46PD-OUFTF <sub>z</sub>
4.7 V ±1.0%	S-1170B47UC-OUGTF <sub>x</sub>	S-1170B47PD-OUGTF <sub>z</sub>
4.8 V ±1.0%	S-1170B48UC-OUHTF <sub>x</sub>	S-1170B48PD-OUHTF <sub>z</sub>
4.9 V ±1.0%	S-1170B49UC-OUITF <sub>x</sub>	S-1170B49PD-OUITF <sub>z</sub>
5.0 V ±1.0%	S-1170B50UC-OUJTF <sub>x</sub>	S-1170B50PD-OUJTF <sub>z</sub>
5.1 V ±1.0%	S-1170B51UC-OUKTF <sub>x</sub>	S-1170B51PD-OUKTF <sub>z</sub>
5.2 V ±1.0%	S-1170B52UC-OULTF <sub>x</sub>	S-1170B52PD-OULTF <sub>z</sub>
5.3 V ±1.0%	S-1170B53UC-OUMTF <sub>x</sub>	S-1170B53PD-OUMTF <sub>z</sub>
5.4 V ±1.0%	S-1170B54UC-OUNTF <sub>x</sub>	S-1170B54PD-OUNTF <sub>z</sub>
5.5 V ±1.0%	S-1170B55UC-OUOTF <sub>x</sub>	S-1170B55PD-OUOTF <sub>z</sub>

**Remark 1.** Please contact our sales office for products with an output voltage other than those specified above or type A products.

2. x: G or U

z: G or S

3. Please select products of environmental code = U for Sn 100%, halogen-free products.

■ Pin Configurations

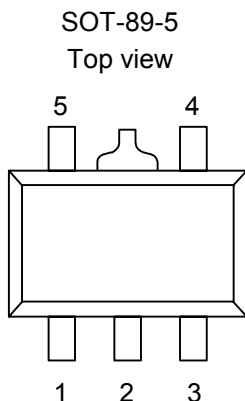
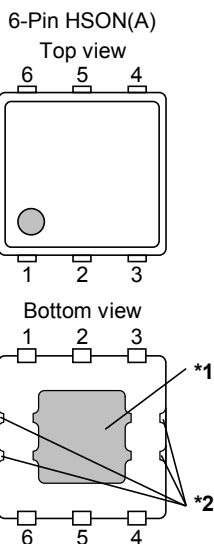

Figure 2

Table 2

Pin No.	Symbol	Description
1	ON/OFF	ON/OFF pin
2	VSS	GND pin
3	NC*1	No connection
4	VIN	Input voltage pin
5	VOUT	Output voltage pin

\*1. The NC pin is electrically open.  
The NC pin can be connected to VIN pin or VSS pin.



- \*1. Connect the exposed thermal die pad at shadowed area to the board, and set electric potential open or VSS. However, do not use it as the function of electrode.
- \*2. Be careful of the contact with other wires because the pinch lead has the same electric potential as VSS.

Figure 3

Table 3

Pin No.	Symbol	Description
1	VOUT*1	Output voltage pin
2	VOUT*1	Output voltage pin
3	ON/OFF	ON/OFF pin
4	VSS	GND pin
5	VIN*2	Input voltage pin
6	VIN*2	Input voltage pin

\*1. Short pins 1 and 2.  
\*2. Short pins 5 and 6.

■ Absolute Maximum Ratings

Table 4

(Ta = 25°C unless otherwise specified)

Parameter	Symbol	Absolute Maximum Rating	Unit
Input voltage	V <sub>IN</sub>	V <sub>SS</sub> - 0.3 to V <sub>SS</sub> + 7	V
	V <sub>ON/OFF</sub>	V <sub>SS</sub> - 0.3 to V <sub>IN</sub> + 0.3	V
Output voltage	V <sub>OUT</sub>	V <sub>SS</sub> - 0.3 to V <sub>IN</sub> + 0.3	V
Power dissipation	SOT-89-5	1000 *1	mW
	6-Pin HSON(A)		
Operation ambient temperature	T <sub>opr</sub>	-40 to +85	°C
Storage temperature	T <sub>stg</sub>	-40 to +125	°C

\*1. At mounted on printed circuit board

**[Mounted board]**

- (1) Board size : 40 mm × 40 mm × t1.6 mm
- (2) Cu wiring shear : 180 % at both sides

**Caution** The absolute maximum ratings are rated values exceeding which the product could suffer physical damage. These values must therefore not be exceeded under any conditions.

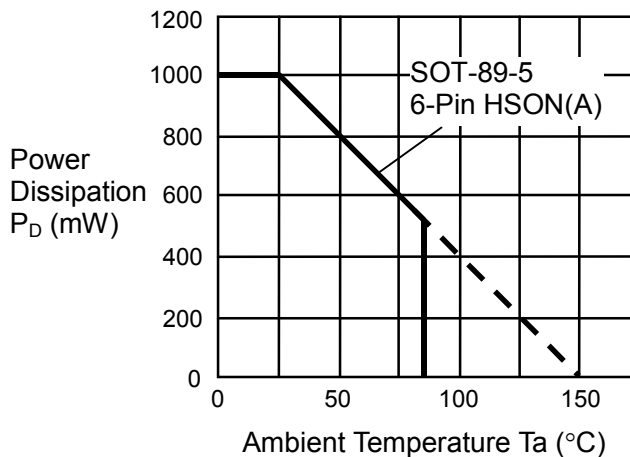

Figure 4 Power Dissipation of Package (Mounted on Printed Circuit Board)

**Caution** Thermal shutdown circuit may operate when junction temperature is 150 °C.

■ **Electrical Characteristics**

**Table 5**

(Ta = 25°C unless otherwise specified)

Parameter	Symbol	Conditions	Min.	Typ.	Max.	Unit	Test Circuit	
Output voltage*1	$V_{OUT(E)}$	$V_{IN} = V_{OUT(S)} + 1.0 \text{ V}$ , $I_{OUT} = 100 \text{ mA}$	$V_{OUT(S)} \times 0.99$	$V_{OUT(S)}$	$V_{OUT(S)} \times 1.01$	V	1	
Output current*2	$I_{OUT}$	$V_{IN} \geq V_{OUT(S)} + 1.0 \text{ V}$	800*5	—	—	mA	3	
Dropout voltage*3	$V_{drop}$	$I_{OUT} = 300 \text{ mA}$	$V_{OUT(S)} = 1.5 \text{ V}$	—	0.35	0.45	V	1
			$V_{OUT(S)} = 1.6 \text{ V}$	—	0.30	0.35	V	1
			$V_{OUT(S)} = 1.7 \text{ V}$	—	0.25	0.30	V	1
			$1.8 \text{ V} \leq V_{OUT(S)} \leq 2.0 \text{ V}$	—	0.20	0.26	V	1
			$2.1 \text{ V} \leq V_{OUT(S)} \leq 2.9 \text{ V}$	—	0.15	0.22	V	1
			$3.0 \text{ V} \leq V_{OUT(S)} \leq 5.5 \text{ V}$	—	0.12	0.18	V	1
Line regulation	$\frac{\Delta V_{OUT1}}{\Delta V_{IN} \cdot V_{OUT}}$	$V_{OUT(S)} + 0.5 \text{ V} \leq V_{IN} \leq 6.5 \text{ V}$ , $I_{OUT} = 100 \text{ mA}$	—	0.05	0.3	%/V	1	
Load regulation	$\Delta V_{OUT2}$	$V_{IN} = V_{OUT(S)} + 1.0 \text{ V}$ , $1.0 \text{ mA} \leq I_{OUT} \leq 300 \text{ mA}$	—	30	100	mV	1	
Output voltage temperature coefficient*4	$\frac{\Delta V_{OUT}}{\Delta T_a \cdot V_{OUT}}$	$V_{IN} = V_{OUT(S)} + 1.0 \text{ V}$ , $I_{OUT} = 10 \text{ mA}$ , $-40^\circ\text{C} \leq T_a \leq 85^\circ\text{C}$	—	$\pm 150$	—	ppm / °C	1	
Current consumption during operation	$I_{SS1}$	$V_{IN} = V_{OUT(S)} + 1.0 \text{ V}$ , ON/OFF pin = ON, no load	—	80	160	μA	2	
Current consumption during power-off	$I_{SS2}$	$V_{IN} = V_{OUT(S)} + 1.0 \text{ V}$ , ON/OFF pin = OFF, no load	—	0.1	1.0	μA	2	
Input voltage	$V_{IN}$	—	2.0	—	6.5	V	—	
ON/OFF pin input voltage "H"	$V_{SH}$	$V_{IN} = V_{OUT(S)} + 1.0 \text{ V}$ , $R_L = 1.0 \text{ k}\Omega$	1.5	—	—	V	4	
ON/OFF pin input voltage "L"	$V_{SL}$	$V_{IN} = V_{OUT(S)} + 1.0 \text{ V}$ , $R_L = 1.0 \text{ k}\Omega$	—	—	0.3	V	4	
ON/OFF pin input current "H"	$I_{SH}$	$V_{IN} = 6.5 \text{ V}$ , $V_{ON/OFF} = 6.5 \text{ V}$	-0.1	—	0.1	μA	4	
ON/OFF pin input current "L"	$I_{SL}$	$V_{IN} = 6.5 \text{ V}$ , $V_{ON/OFF} = 0 \text{ V}$	-0.1	—	0.1	μA	4	
Ripple rejection	RR	$V_{IN} = V_{OUT(S)} + 1.0 \text{ V}$ , $f = 1.0 \text{ kHz}$ , $\Delta V_{rip} = 0.5 \text{ V}_{rms}$ , $I_{OUT} = 100 \text{ mA}$	$1.5 \text{ V} \leq V_{OUT(S)} \leq 3.0 \text{ V}$	—	70	—	dB	5
			$3.1 \text{ V} \leq V_{OUT(S)} \leq 5.5 \text{ V}$	—	65	—	dB	5
Short-circuit current	$I_{short}$	$V_{IN} = V_{OUT(S)} + 1.0 \text{ V}$ , ON/OFF pin = ON, $V_{OUT} = 0 \text{ V}$	—	350	—	mA	3	
Thermal shutdown detection temperature	$T_{SD}$	Junction temperature	—	150	—	°C	—	
Thermal shutdown release temperature	$T_{SR}$	Junction temperature	—	120	—	°C	—	



- \*1.  $V_{OUT(S)}$ : Set output voltage  
 $V_{OUT(E)}$ : Actual output voltage  
 Output voltage when fixing  $I_{OUT}$  (= 100 mA) and inputting  $V_{OUT(S)} + 1.0$  V
- \*2. The output current at which the output voltage becomes 95% of  $V_{OUT(E)}$  after gradually increasing the output current.
- \*3.  $V_{drop} = V_{IN1} - (V_{OUT3} \times 0.98)$   
 $V_{OUT3}$  is the output voltage when  $V_{IN} = V_{OUT(S)} + 1.0$  V and  $I_{OUT} = 300$  mA.  
 $V_{IN1}$  is the input voltage at which the output voltage becomes 98% of  $V_{OUT3}$  after gradually decreasing the input voltage.
- \*4. A change in the temperature of the output voltage [mV/°C] is calculated using the following equation.  

$$\frac{\Delta V_{OUT}}{\Delta Ta} \text{ [mV/°C]}^{*1} = V_{OUT(S)} \text{ [V]}^{*2} \times \frac{\Delta V_{OUT}}{\Delta Ta \bullet V_{OUT}} \text{ [ppm/°C]}^{*3} \div 1000$$
  - \*1. Change in temperature of output voltage
  - \*2. Set output voltage
  - \*3. Output voltage temperature coefficient
- \*5. The output current can be at least this value.  
 Due to restrictions on the package power dissipation, this value may not be satisfied. Attention should be paid to the power dissipation of the package when the output current is large.  
 This specification is guaranteed by design.

■ Test Circuits

1.

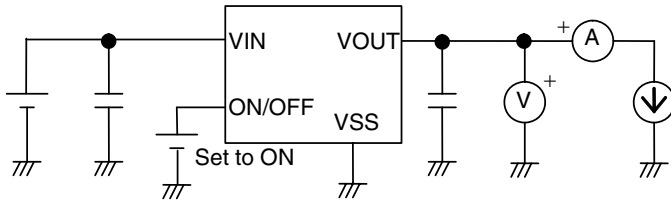

Figure 5

2.

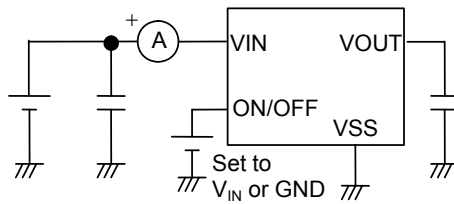

Figure 6

3.

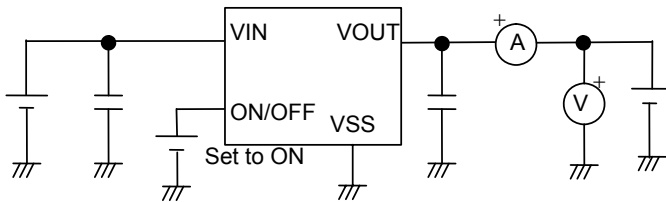

Figure 7

4.

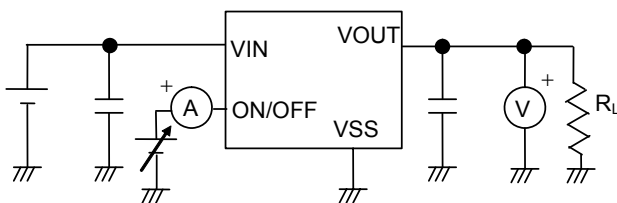

Figure 8

5.

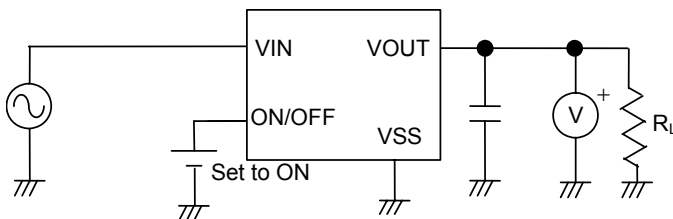
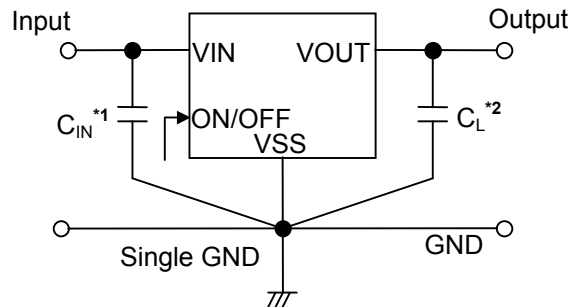

Figure 9

■ **Standard Circuit**



\*1.  $C_{IN}$  is a capacitor for stabilizing the input.

\*2. A ceramic capacitor of 4.7  $\mu\text{F}$  or more can be used for  $C_L$ .

Figure 10

**Caution** The above connection diagram and constant will not guarantee successful operation. Perform thorough evaluation using the actual application to set the constant.

■ **Condition of Application**

Input capacitor ( $C_{IN}$ ): 4.7  $\mu\text{F}$  or more

Output capacitor ( $C_L$ ): 4.7  $\mu\text{F}$  or more

ESR of output capacitor: 0.5  $\Omega$  or less

**Caution** Generally a series regulator may cause oscillation, depending on the selection of external parts. Check that no oscillation occurs with the application using the above capacitor.

■ **Selection of Input and Output Capacitors ( $C_{IN}$ ,  $C_L$ )**

The S-1170 Series requires an output capacitor between the VOUT pin and the VSS pin for phase compensation. A ceramic capacitor with a capacitance of 4.7  $\mu\text{F}$  or more provides a stable operation in all temperature ranges. When using an OS capacitor, a tantalum capacitor, or an aluminum electrolytic capacitor, the capacitance must be 4.7  $\mu\text{F}$  or more, and the ESR must be 0.5  $\Omega$  or less.

The output overshoot and undershoot values, which are transient response characteristics, vary depending on the output capacitor value. The required capacitance value for the input capacitor differs depending on the application.

The recommended value for an application is  $C_{IN} \geq 4.7 \mu\text{F}$  and  $C_L \geq 4.7 \mu\text{F}$ , however, perform a thorough evaluation using the actual device, including evaluation of temperature characteristics.

## ■ Explanation of Terms

### 1. Low dropout voltage regulator

This voltage regulator has the low dropout voltage due to its built-in low on-resistance transistor.

### 2. Low ESR

A capacitor whose ESR (Equivalent Series Resistance) is low. The S-1170 Series enables use of a low ESR capacitor, such as a ceramic capacitor, for the output-side capacitor ( $C_L$ ). A capacitor whose ESR is  $0.5 \Omega$  or less can be used.

### 3. Output voltage ( $V_{OUT}$ )

The accuracy of the output voltage is ensured at  $\pm 1.0\%$  under the specified conditions of fixed input voltage<sup>\*1</sup>, fixed output current, and fixed temperature.

\*1. Differs depending the product.

**Caution** If the above conditions change, the output voltage value may vary and exceed the accuracy range of the output voltage. Refer to “■ Electrical Characteristics” and “■ Characteristics (Typical Data)” for details.

### 4. Line regulation $\left( \frac{\Delta V_{OUT1}}{\Delta V_{IN} \cdot V_{OUT}} \right)$

Indicates the dependency of the output voltage on the input voltage. That is, the values show how much the output voltage changes due to a change in the input voltage with the output current remaining unchanged.

### 5. Load regulation ( $\Delta V_{OUT2}$ )

Indicates the dependency of the output voltage on the output current. That is, the values show how much the output voltage changes due to a change in the output current with the input voltage remaining unchanged.

### 6. Dropout voltage ( $V_{drop}$ )

Indicates the difference between input voltage ( $V_{IN1}$ ) and the output voltage when; decreasing input voltage ( $V_{IN}$ ) gradually until the output voltage has dropped out to the value of 98% of output voltage ( $V_{OUT3}$ ), which is at  $V_{IN} = V_{OUT(S)} + 1.0 \text{ V}$ .

$$V_{drop} = V_{IN1} - (V_{OUT3} \times 0.98)$$

**7. Output voltage temperature coefficient**  $\left( \frac{\Delta V_{OUT}}{\Delta T_a \bullet V_{OUT}} \right)$

The shaded area in **Figure 11** is the range where  $V_{OUT}$  varies in the operation temperature range when the output voltage temperature coefficient is  $\pm 150$  ppm/ $^{\circ}$ C.

Example of S-1170B28 typ. product

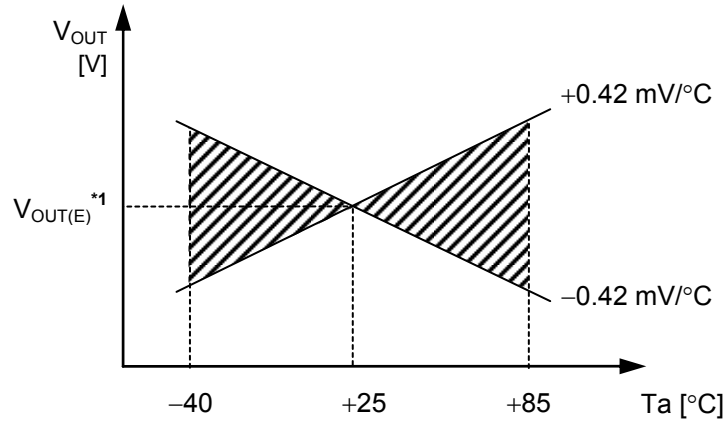

\*1.  $V_{OUT(E)}$  is the value of the output voltage measured at  $T_a = +25^{\circ}\text{C}$ .

**Figure 11**

A change in the temperature of the output voltage [mV/ $^{\circ}$ C] is calculated using the following equation.

$$\frac{\Delta V_{OUT}}{\Delta T_a} \text{ [mV}/^{\circ}\text{C}]^{*1} = V_{OUT(S)} \text{ [V]}^{*2} \times \frac{\Delta V_{OUT}}{\Delta T_a \bullet V_{OUT}} \text{ [ppm}/^{\circ}\text{C}]^{*3} \div 1000$$

- \*1. Change in temperature of output voltage
- \*2. Set output voltage
- \*3. Output voltage temperature coefficient

■ **Operation**

**1. Basic operation**

Figure 12 shows the block diagram of the S-1170 Series.

The error amplifier compares the reference voltage ( $V_{ref}$ ) with feedback voltage ( $V_{fb}$ ), which is the output voltage resistance-divided by feedback resistors ( $R_s$  and  $R_f$ ). It supplies the gate voltage necessary to maintain the constant output voltage which is not influenced by the input voltage and temperature change, to the output transistor.



\*1. Parasitic diode

Figure 12

**2. Output transistor**

In the S-1170 Series, a low on-resistance P-channel MOS FET is used as the output transistor. Be sure that  $V_{OUT}$  does not exceed  $V_{IN} + 0.3$  V to prevent the voltage regulator from being damaged due to reverse current flowing from the VOUT pin through a parasitic diode to the VIN pin, when the potential of  $V_{OUT}$  became higher than  $V_{IN}$ .

**3. ON/OFF pin**

This pin starts and stops the regulator.

When the ON/OFF pin is set to OFF level, the entire internal circuit stops operating, and the built-in P-channel MOS FET output transistor between the VIN pin and the VOUT pin is turned off, reducing current consumption significantly. The VOUT pin becomes the V<sub>SS</sub> level due to the internally divided resistance of several hundreds kΩ between the VOUT pin and the VSS pin.

The structure of the ON/OFF pin is as shown in **Figure 13**. Since the ON/OFF pin is neither pulled down nor pulled up internally, do not use it in the floating status. In addition, note that the current consumption increases if a voltage of 0.3 V to V<sub>IN</sub> – 0.3 V is applied to the ON/OFF pin. When not using the ON/OFF pin, connect it to the VSS pin in the product A type, and connect it to the VIN pin in B type.

**Table 6**

Product Type	ON/OFF Pin	Internal Circuit	VOUT Pin Voltage	Current Consumption
A	“L”: ON	Operate	Set value	I <sub>SS1</sub>
A	“H”: OFF	Stop	V <sub>SS</sub> level	I <sub>SS2</sub>
B	“L”: OFF	Stop	V <sub>SS</sub> level	I <sub>SS2</sub>
B	“H”: ON	Operate	Set value	I <sub>SS1</sub>

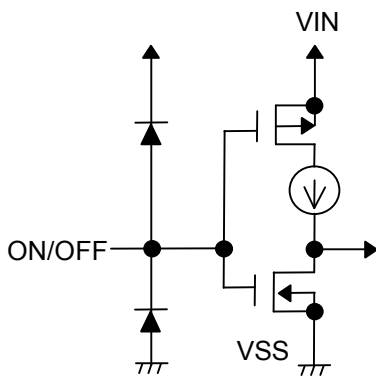

**Figure 13**

**4. Thermal shutdown circuit**

The S-1170 Series implements a thermal shutdown circuit to protect the device from damage due to overheating. When the junction temperature rises to 150°C (typ.), the thermal shutdown circuit operates and the regulator operation stops. When the junction temperature drops to 120°C (typ.), the thermal shutdown circuit is released and the regulator operation resumes.

If the thermal shutdown circuit starts operating due to self-heating, the regulator operation stops and the output voltage falls. When the regulator operation has stopped, no self-heat is generated and the temperature of the IC is lowered. When the temperature has dropped, the thermal shutdown circuit is released, the regulator operation resumes, and self-heat is generated again. By repeating this procedure, the output voltage waveform forms pulses. Stop or restart of regulation continues unless decreasing either or both of the input voltage and the output current in order to reduce the internal power consumption, or decreasing the ambient temperature.

**Table 7**

Thermal Shutdown Circuit	VOUT Pin Voltage
Operating: 150°C (typ.)	V <sub>ss</sub> level
Released: 120°C (typ.)	Set value



## ■ Precautions

- Wiring patterns for the VIN pin, the VOUT pin and GND should be designed so that the impedance is low. When mounting an output capacitor between the VOUT pin and the VSS pin ( $C_L$ ) and a capacitor for stabilizing the input between the VIN pin and the VSS pin ( $C_{IN}$ ), the distance from the capacitors to these pins should be as short as possible.
- Note that generally the output voltage may increase when a series regulator is used at low load current (1.0 mA or less).
- Note that the output voltage may increase due to the leakage current from an output driver even if the ON/OFF pin is at OFF level when a series regulator is used at high temperature.
- Generally a series regulator may cause oscillation, depending on the selection of external parts. The following conditions are recommended for the S-1170 Series. However, be sure to perform sufficient evaluation under the actual usage conditions for selection, including evaluation of temperature characteristics.

Input capacitor ( $C_{IN}$ ):	4.7 $\mu$ F or more
Output capacitor ( $C_L$ ):	4.7 $\mu$ F or more
Equivalent series resistance (ESR):	0.5 $\Omega$ or less

- The voltage regulator may oscillate when the impedance of the power supply is high and the input capacitance is small or an input capacitor is not connected.
- Overshoot may occur in the output voltage momentarily if the voltage is rapidly raised at power-on or when the power supply fluctuates. Sufficiently evaluate the output voltage at power-on with the actual device.
- The application conditions for the input voltage, the output voltage, and the load current should not exceed the package power dissipation.
- Do not apply an electrostatic discharge to this IC that exceeds the performance ratings of the built-in electrostatic protection circuit.
- In determining the output current, attention should be paid to the output current value specified in **Table 5** in “■ Electrical Characteristics” and footnote \*5 of the table.
- ABLIC Inc. claims no responsibility for any disputes arising out of or in connection with any infringement by products including this IC of patents owned by a third party.

**■ Characteristics (Typical Data)**

**(1) Output voltage vs. Output current (when load current increases)**

S-1170B15 (Ta = 25°C)

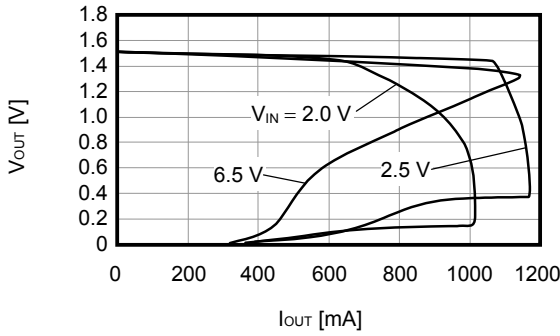

S-1170B30 (Ta = 25°C)

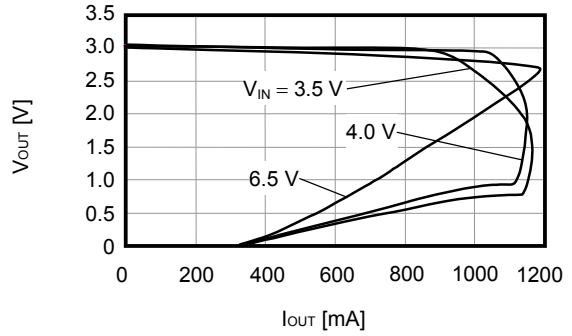

S-1170B50 (Ta = 25°C)

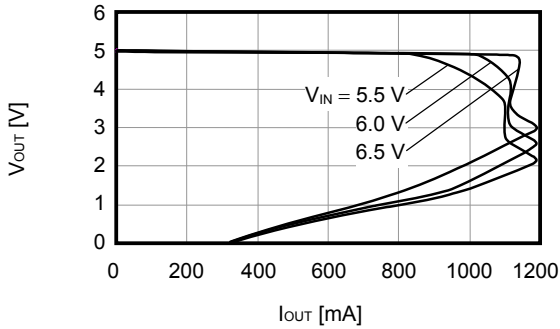

**Remark** In determining the output current, attention should be paid to the following.

1. The minimum output current value and footnote \*5 in Table 5 in "■ Electrical Characteristics"
2. The package power dissipation

**(2) Output voltage vs. Input voltage**

S-1170B15 (Ta = 25°C)

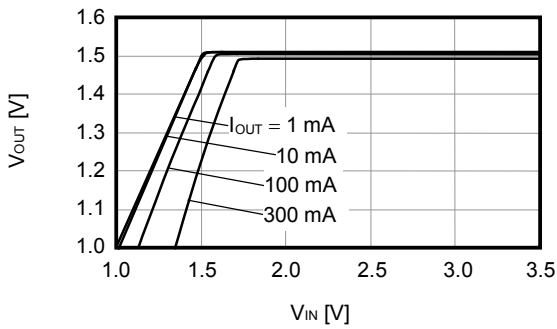

S-1170B30 (Ta = 25°C)

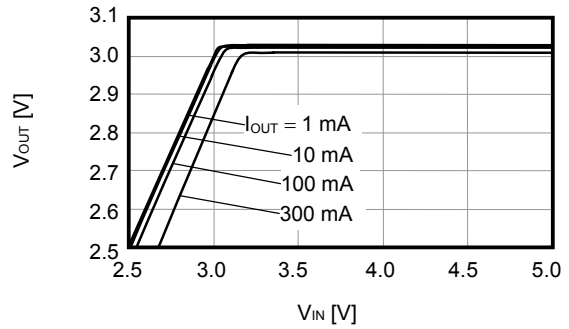

S-1170B50 (Ta = 25°C)

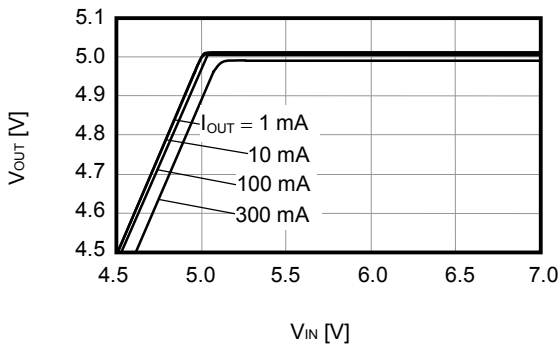

**(3) Dropout voltage vs. Output current**

S-1170B15

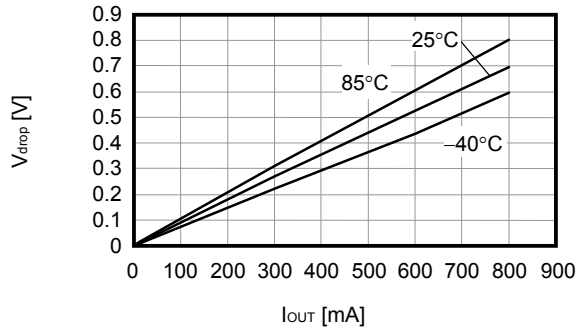

S-1170B30

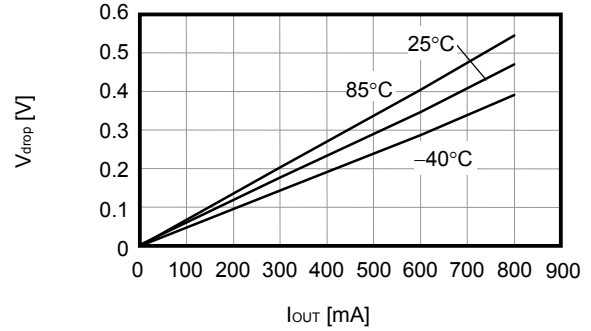

S-1170B50

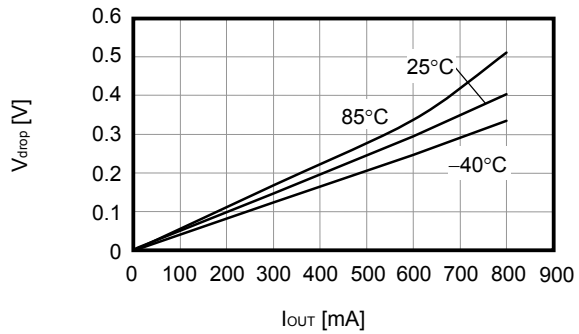

**(4) Dropout voltage vs. Set output voltage**

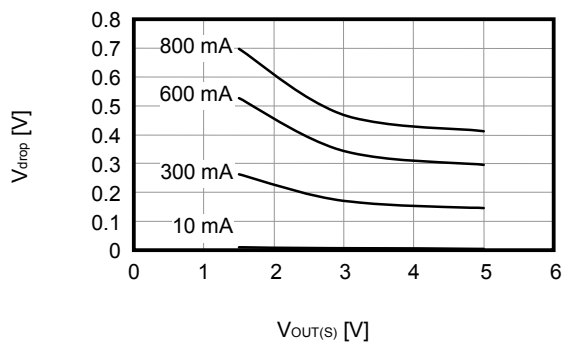

**(5) Output voltage vs. Ambient temperature**

S-1170B15 ( $I_{OUT} = 10\text{ mA}$ )

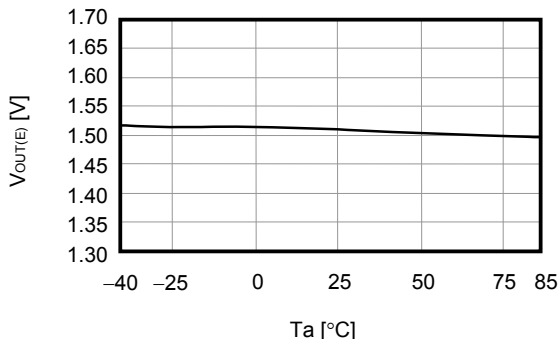

S-1170B30 ( $I_{OUT} = 10\text{ mA}$ )

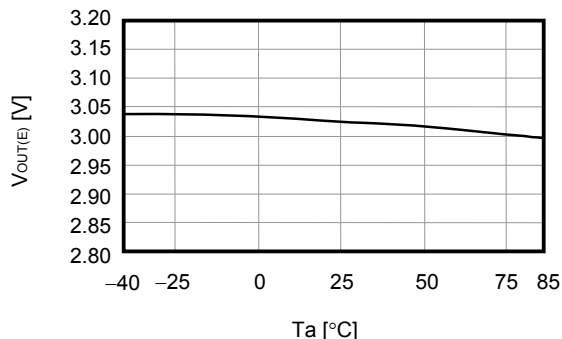

S-1170B50 ( $I_{OUT} = 10\text{ mA}$ )

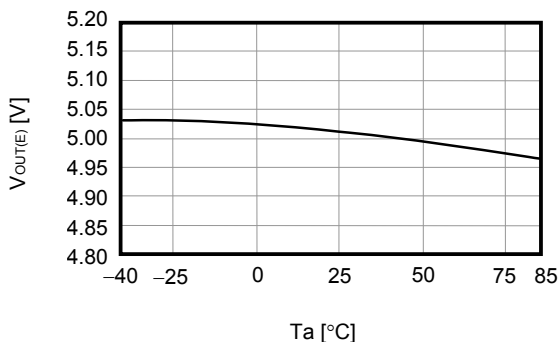

**(6) Current consumption vs. Input voltage**

S-1170B15 ( $T_a = 25^\circ\text{C}$ )

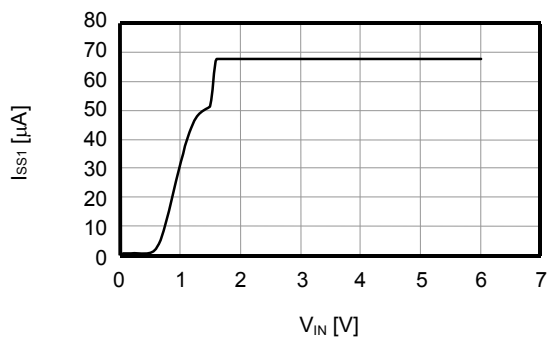

S-1170B30 ( $T_a = 25^\circ\text{C}$ )

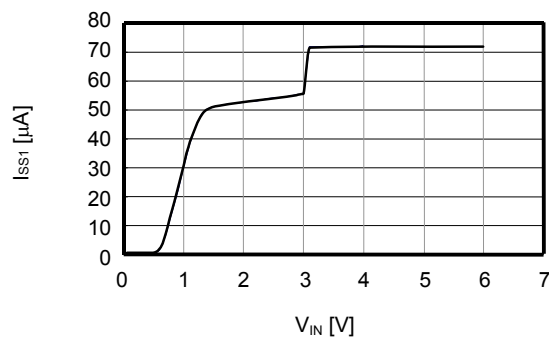

S-1170B50 ( $T_a = 25^\circ\text{C}$ )

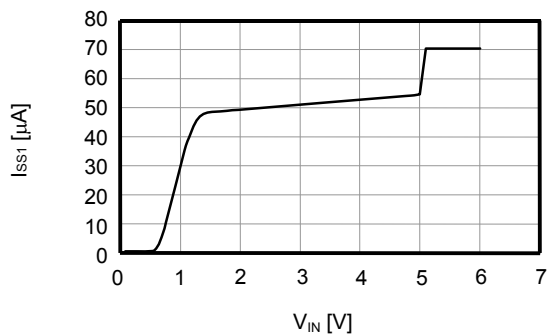

**(7) Ripple rejection**

S-1170B15 ( $T_a = 25^\circ\text{C}$ )

$V_{IN} = 2.5\text{ V}$ ,  $C_{OUT} = 4.7\ \mu\text{F}$

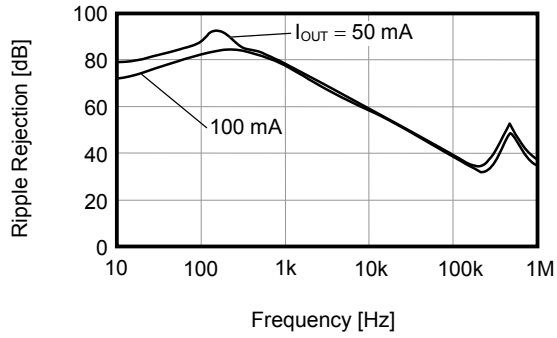

S-1170B30 ( $T_a = 25^\circ\text{C}$ )

$V_{IN} = 4.0\text{ V}$ ,  $C_{OUT} = 4.7\ \mu\text{F}$

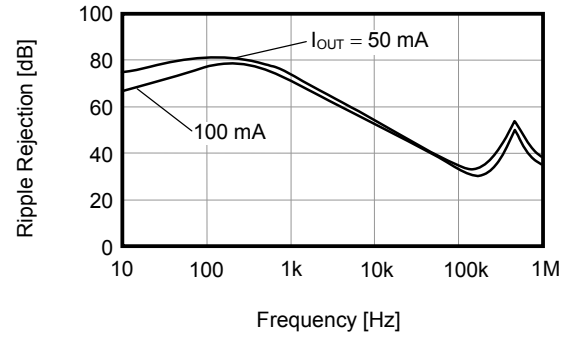

S-1170B50 ( $T_a = 25^\circ\text{C}$ )

$V_{IN} = 6.0\text{ V}$ ,  $C_{OUT} = 4.7\ \mu\text{F}$

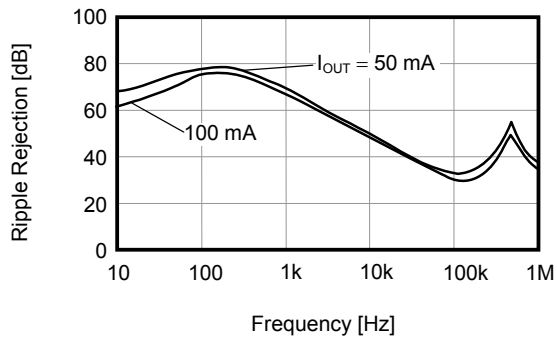

■ **Reference Data**

**(1) Input transient response characteristics**

**S-1170B15**

$I_{OUT} = 100\text{ mA}$ ,  $t_r = t_f = 5.0\ \mu\text{s}$ ,  $C_{OUT} = 4.7\ \mu\text{F}$ ,  $C_{IN} = 4.7\ \mu\text{F}$

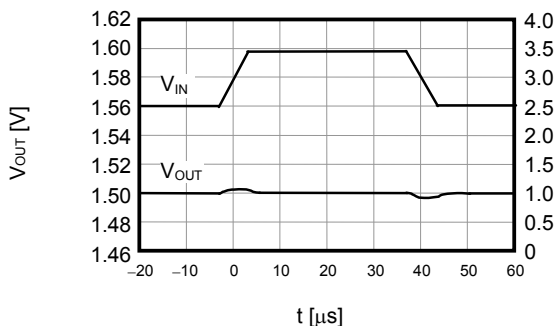

**S-1170B30**

$I_{OUT} = 100\text{ mA}$ ,  $t_r = t_f = 5.0\ \mu\text{s}$ ,  $C_{OUT} = 4.7\ \mu\text{F}$ ,  $C_{IN} = 4.7\ \mu\text{F}$

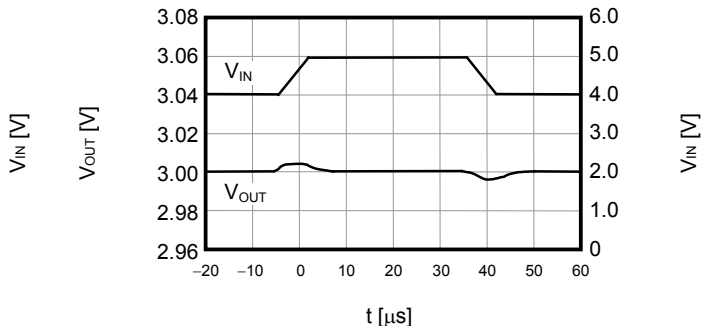

**S-1170B50**

$I_{OUT} = 100\text{ mA}$ ,  $t_r = t_f = 5.0\ \mu\text{s}$ ,  $C_{OUT} = 4.7\ \mu\text{F}$ ,  $C_{IN} = 4.7\ \mu\text{F}$

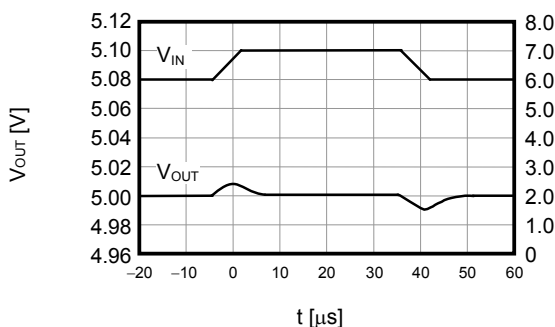

**(2) Load transient response characteristics**

**S-1170B15 (Ta = 25°C)**

$V_{IN} = 2.5\text{ V}$ ,  $C_{OUT} = 4.7\ \mu\text{F}$ ,  $C_{IN} = 4.7\ \mu\text{F}$ ,  $I_{OUT} = 50\text{ mA} \leftrightarrow 100\text{ mA}$

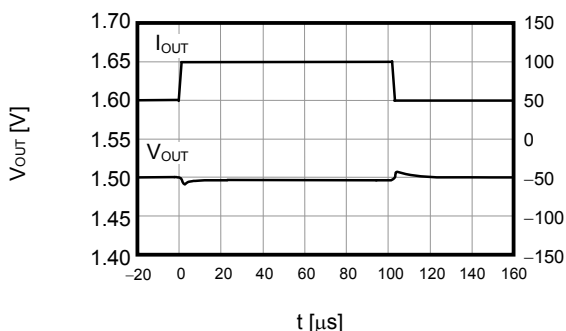

**S-1170B30 (Ta = 25°C)**

$V_{IN} = 4.0\text{ V}$ ,  $C_{OUT} = 4.7\ \mu\text{F}$ ,  $C_{IN} = 4.7\ \mu\text{F}$ ,  $I_{OUT} = 50\text{ mA} \leftrightarrow 100\text{ mA}$

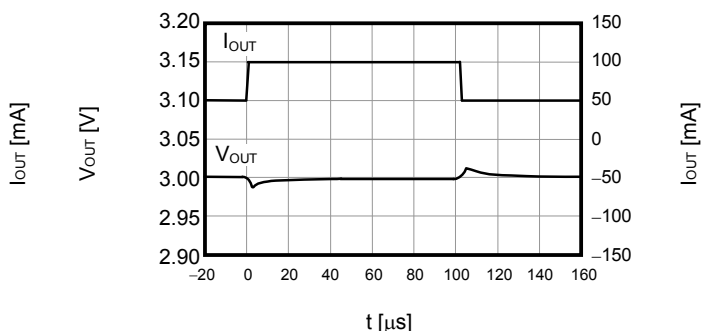

**S-1170B50 (Ta = 25°C)**

$V_{IN} = 6.0\text{ V}$ ,  $C_{OUT} = 4.7\ \mu\text{F}$ ,  $C_{IN} = 4.7\ \mu\text{F}$ ,  $I_{OUT} = 50\text{ mA} \leftrightarrow 100\text{ mA}$

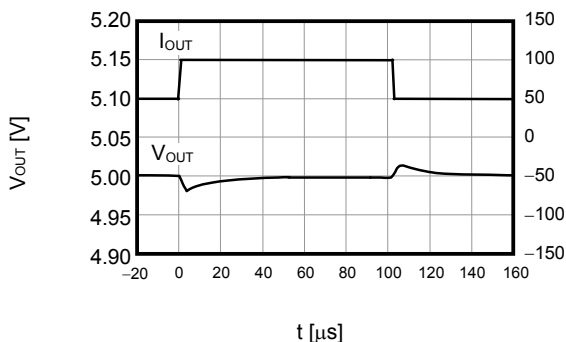

**(3) ON/OFF pin transient response characteristics**

S-1170B15 (Ta = 25°C)

V<sub>IN</sub> = 2.5 V, C<sub>OUT</sub> = 4.7 μF, C<sub>IN</sub> = 4.7 μF, I<sub>OUT</sub> = 100 mA

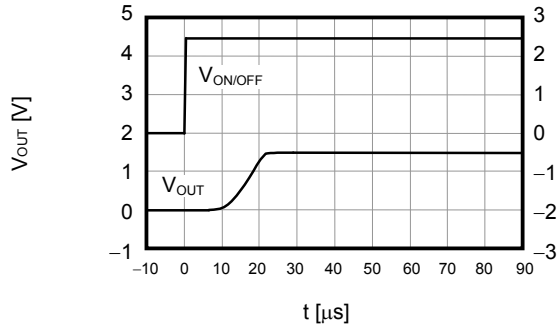

S-1170B30 (Ta = 25°C)

V<sub>IN</sub> = 4.0 V, C<sub>OUT</sub> = 4.7 μF, C<sub>IN</sub> = 4.7 μF, I<sub>OUT</sub> = 100 mA

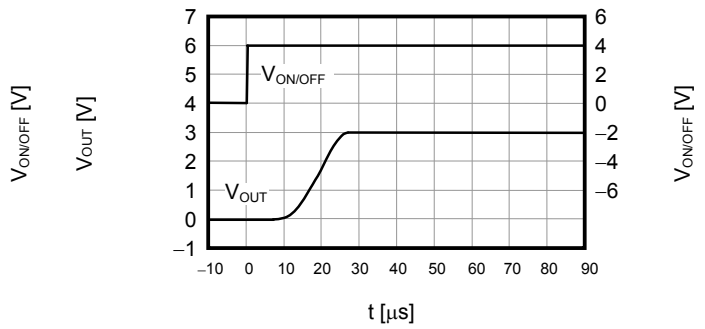

S-1170B50 (Ta = 25°C)

V<sub>IN</sub> = 6.0 V, C<sub>OUT</sub> = 4.7 μF, C<sub>IN</sub> = 4.7 μF, I<sub>OUT</sub> = 100 mA

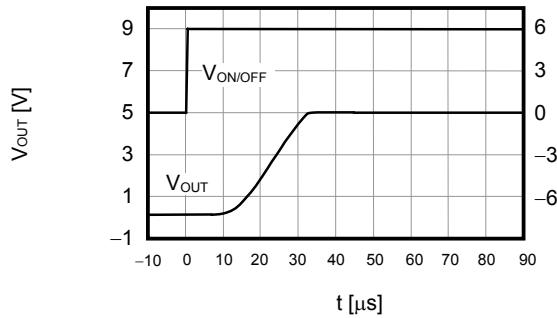

S-1170B15 (Ta = 25°C)

V<sub>IN</sub> = 2.5 V, C<sub>OUT</sub> = 4.7 μF, C<sub>IN</sub> = 4.7 μF, I<sub>OUT</sub> = 300 mA

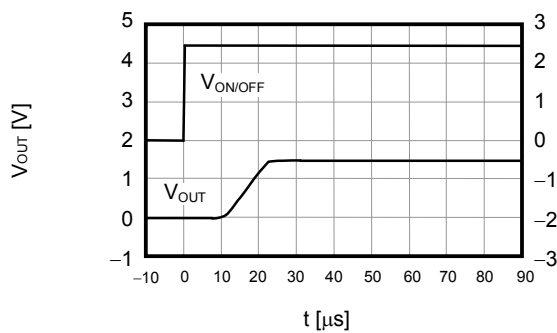

S-1170B30 (Ta = 25°C)

V<sub>IN</sub> = 4.0 V, C<sub>OUT</sub> = 4.7 μF, C<sub>IN</sub> = 4.7 μF, I<sub>OUT</sub> = 300 mA

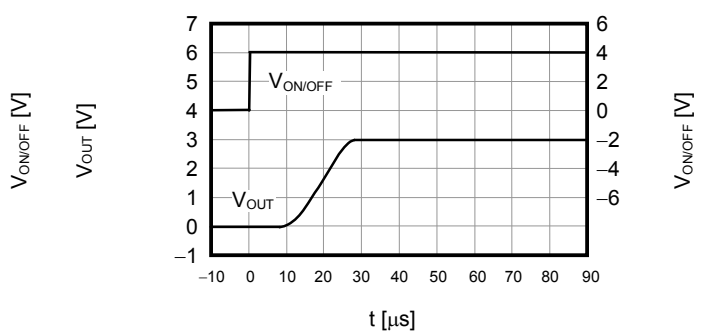

S-1170B50 (Ta = 25°C)

V<sub>IN</sub> = 6.0 V, C<sub>OUT</sub> = 4.7 μF, C<sub>IN</sub> = 4.7 μF, I<sub>OUT</sub> = 300 mA

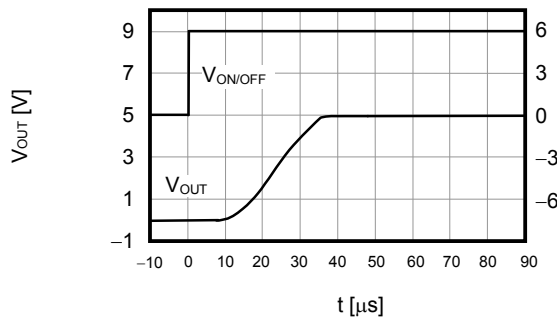

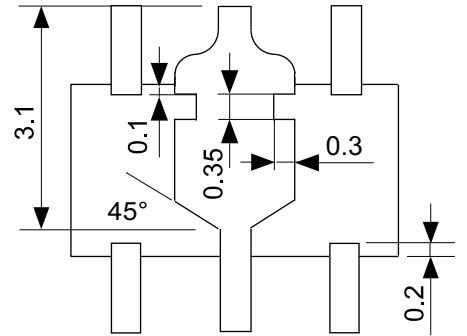
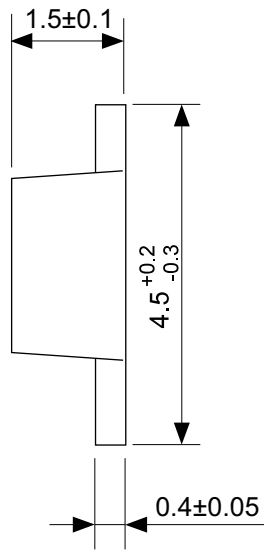

No. UP005-A-P-SD-2.0

TITLE	SOT895-A-PKG Dimensions
No.	UP005-A-P-SD-2.0
ANGLE	
UNIT	mm
<b>ABLIC Inc.</b>	



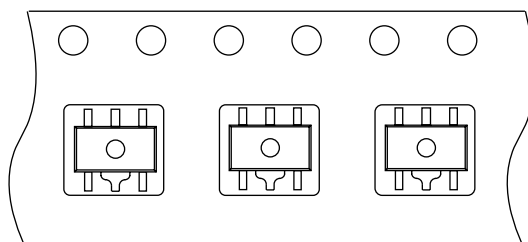
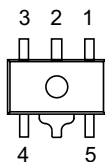
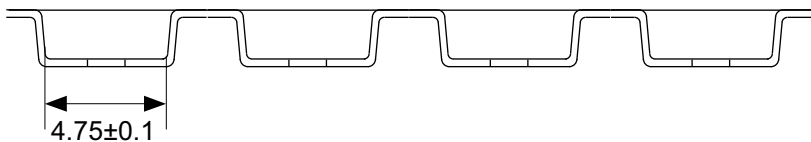
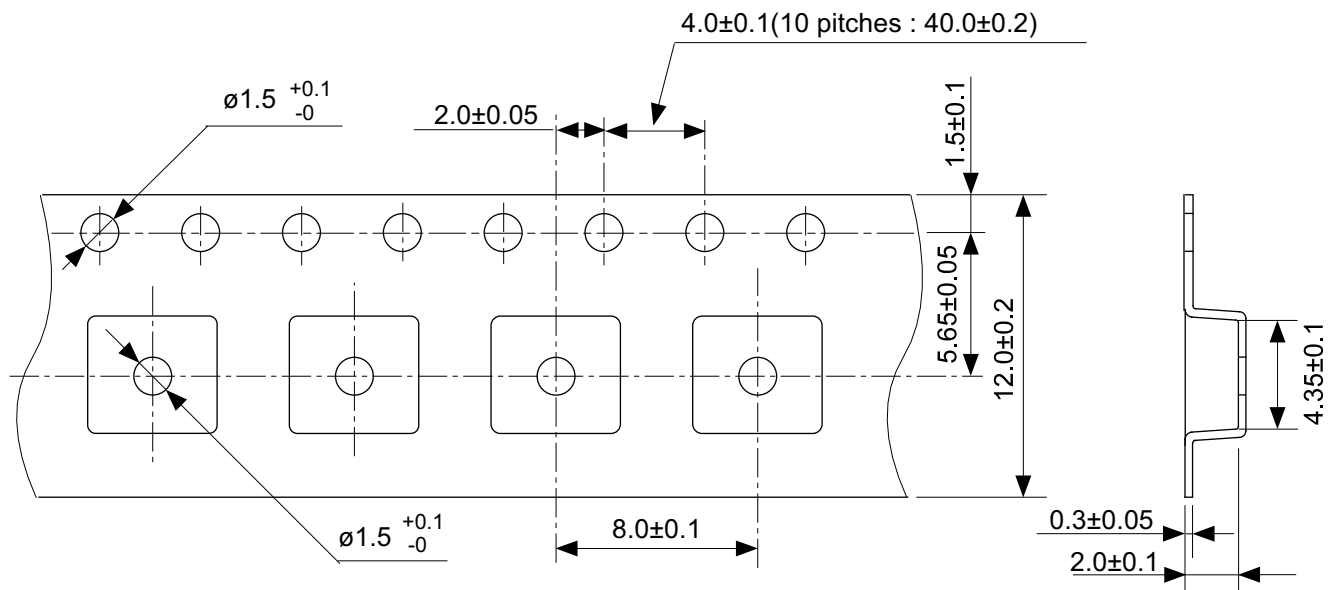

→  
Feed direction

No. UP005-A-C-SD-2.0

TITLE	SOT895-A-Carrier Tape
No.	UP005-A-C-SD-2.0
ANGLE	
UNIT	mm
<b>ABLIC Inc.</b>	

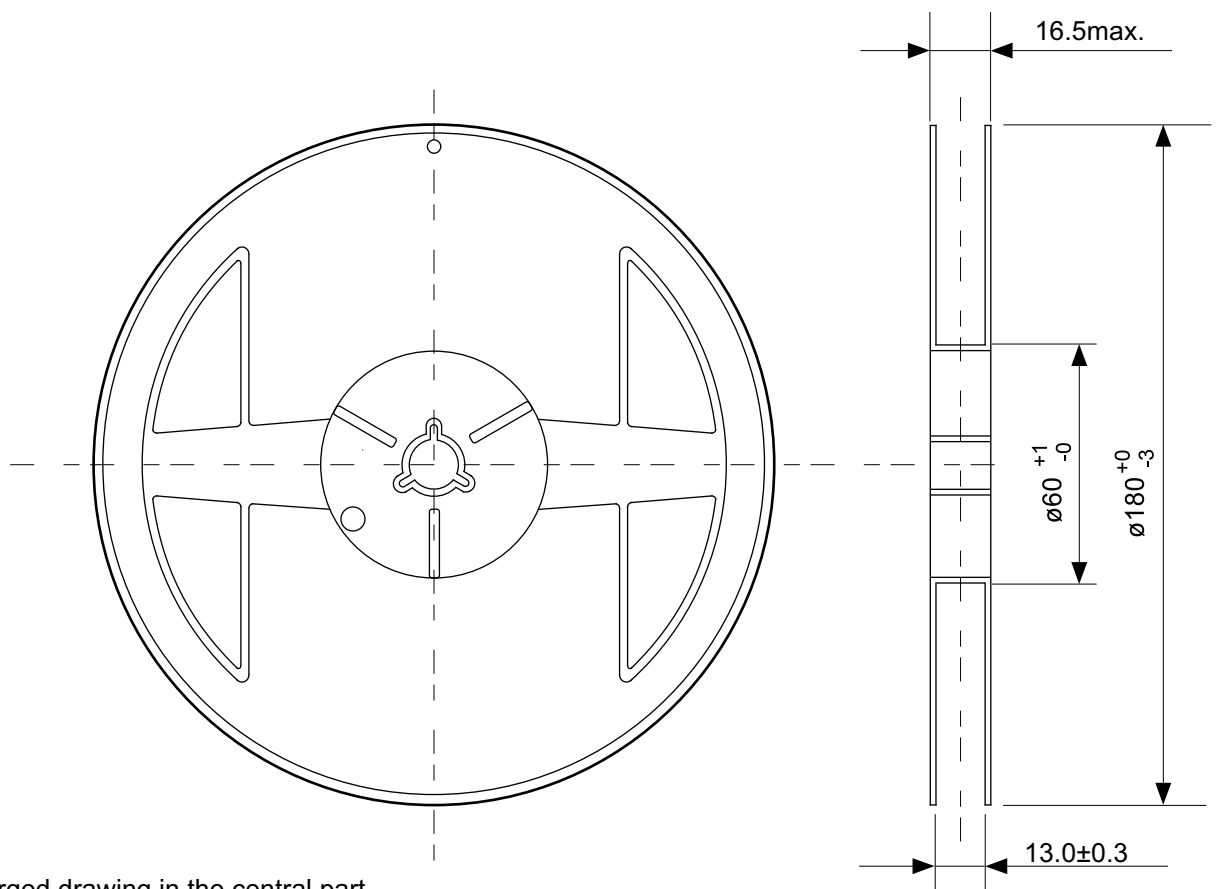

Enlarged drawing in the central part

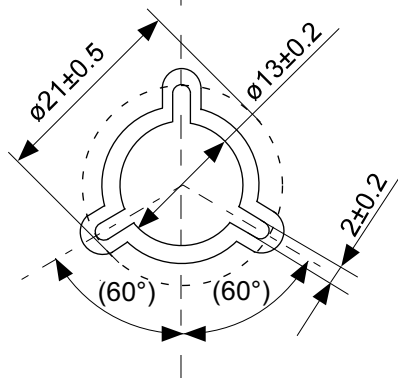

No. UP005-A-R-SD-1.1

TITLE	SOT895-A-Reel		
No.	UP005-A-R-SD-1.1		
ANGLE		QTY.	1,000
UNIT	mm		
<b>ABLIC Inc.</b>			

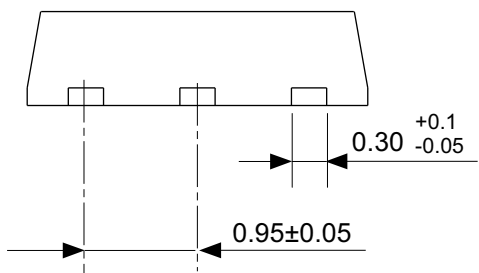
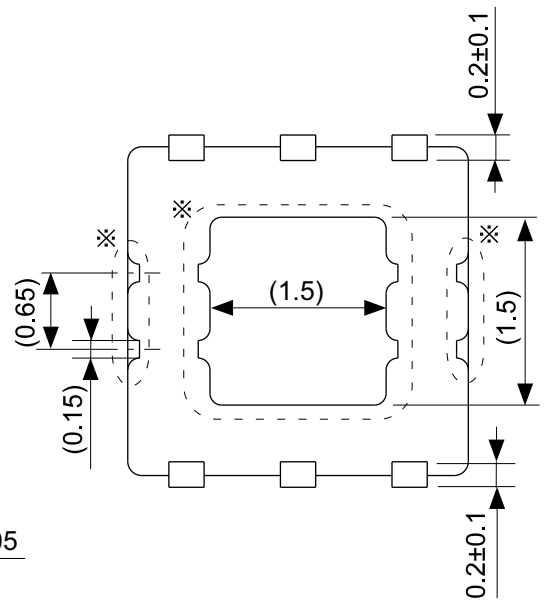
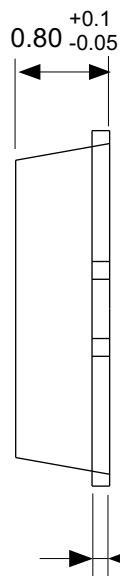
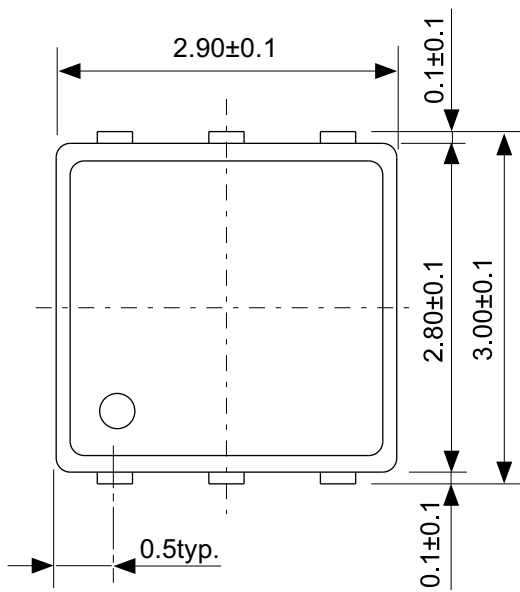

※ The exposed thermal die pad has different electric potential depending on the product. Confirm specifications of each product. Do not use it as the function of electrode.

No. PD006-A-P-SD-5.0

TITLE	HSON6A-A-PKG Dimensions
No.	PD006-A-P-SD-5.0
ANGLE	
UNIT	mm
<b>ABLIC Inc.</b>	

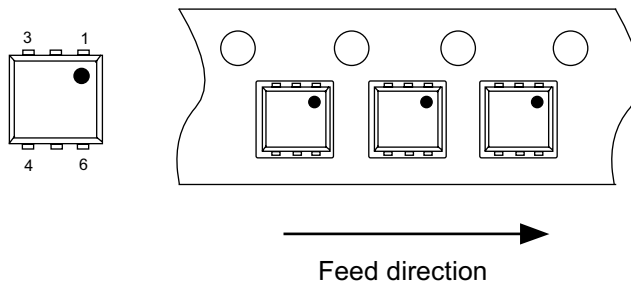
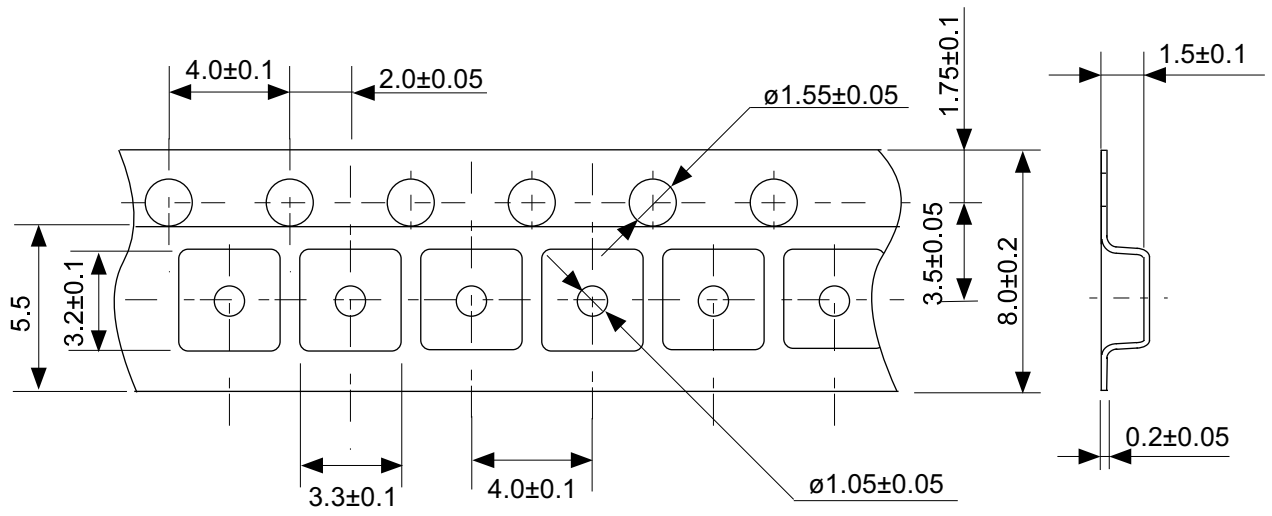

No. PD006-A-C-SD-2.0

TITLE	HS0N6A-A-Carrier Tape
No.	PD006-A-C-SD-2.0
ANGLE	
UNIT	mm
<b>ABLIC Inc.</b>	

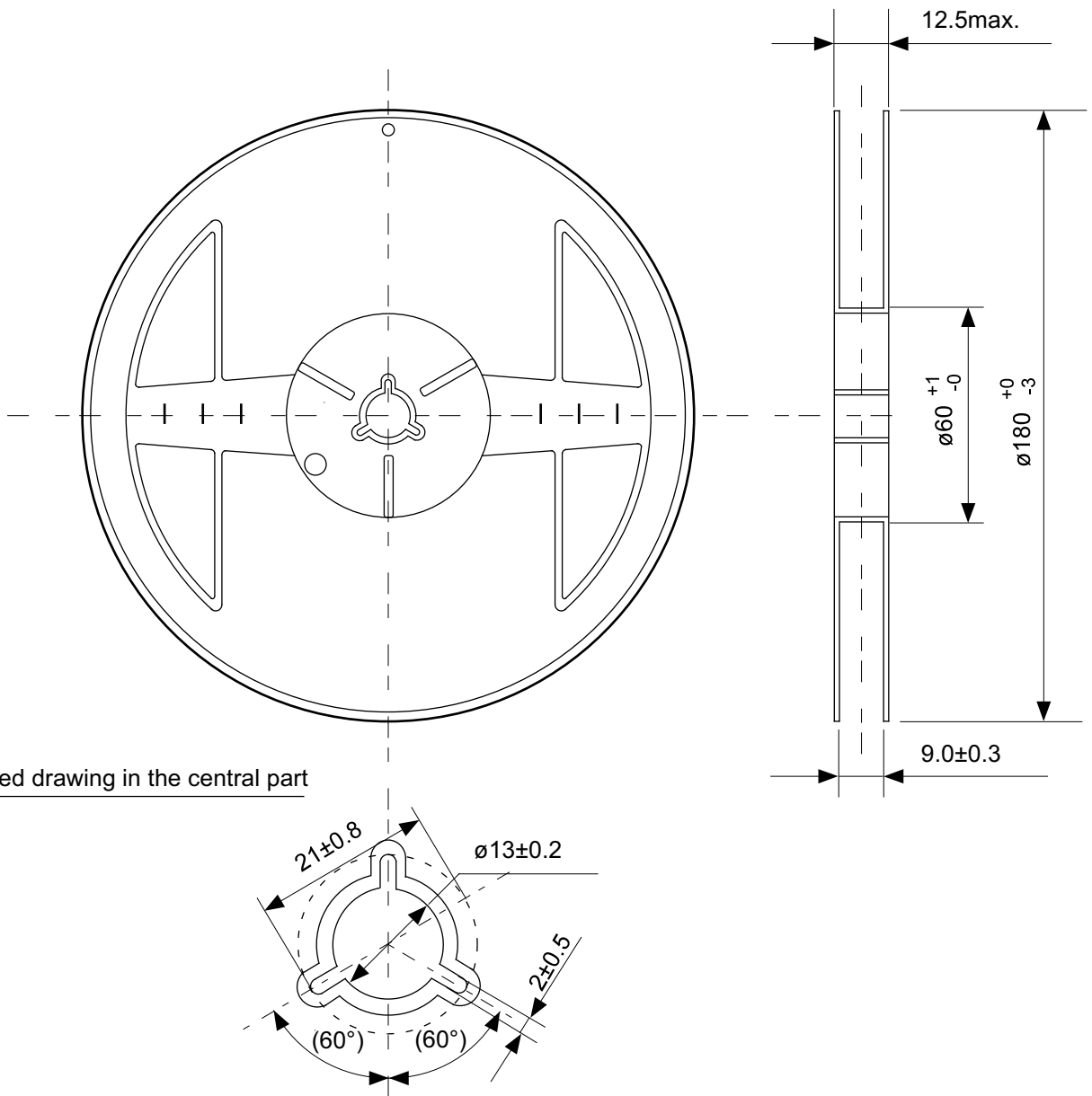

Enlarged drawing in the central part

No. PD006-A-R-SD-1.0

TITLE	HSO6A-A-Reel		
No.	PD006-A-R-SD-1.0		
ANGLE		QTY.	3,000
UNIT	mm		
<b>ABLIC Inc.</b>			

## Disclaimers (Handling Precautions)

1. All the information described herein (product data, specifications, figures, tables, programs, algorithms and application circuit examples, etc.) is current as of publishing date of this document and is subject to change without notice.
2. The circuit examples and the usages described herein are for reference only, and do not guarantee the success of any specific mass-production design.  
ABLIC Inc. is not liable for any losses, damages, claims or demands caused by the reasons other than the products described herein (hereinafter "the products") or infringement of third-party intellectual property right and any other right due to the use of the information described herein.
3. ABLIC Inc. is not liable for any losses, damages, claims or demands caused by the incorrect information described herein.
4. Be careful to use the products within their ranges described herein. Pay special attention for use to the absolute maximum ratings, operation voltage range and electrical characteristics, etc.  
ABLIC Inc. is not liable for any losses, damages, claims or demands caused by failures and / or accidents, etc. due to the use of the products outside their specified ranges.
5. Before using the products, confirm their applications, and the laws and regulations of the region or country where they are used and verify suitability, safety and other factors for the intended use.
6. When exporting the products, comply with the Foreign Exchange and Foreign Trade Act and all other export-related laws, and follow the required procedures.
7. The products are strictly prohibited from using, providing or exporting for the purposes of the development of weapons of mass destruction or military use. ABLIC Inc. is not liable for any losses, damages, claims or demands caused by any provision or export to the person or entity who intends to develop, manufacture, use or store nuclear, biological or chemical weapons or missiles, or use any other military purposes.
8. The products are not designed to be used as part of any device or equipment that may affect the human body, human life, or assets (such as medical equipment, disaster prevention systems, security systems, combustion control systems, infrastructure control systems, vehicle equipment, traffic systems, in-vehicle equipment, aviation equipment, aerospace equipment, and nuclear-related equipment), excluding when specified for in-vehicle use or other uses by ABLIC, Inc. Do not apply the products to the above listed devices and equipments.  
ABLIC Inc. is not liable for any losses, damages, claims or demands caused by unauthorized or unspecified use of the products.
9. In general, semiconductor products may fail or malfunction with some probability. The user of the products should therefore take responsibility to give thorough consideration to safety design including redundancy, fire spread prevention measures, and malfunction prevention to prevent accidents causing injury or death, fires and social damage, etc. that may ensue from the products' failure or malfunction.  
The entire system in which the products are used must be sufficiently evaluated and judged whether the products are allowed to apply for the system on customer's own responsibility.
10. The products are not designed to be radiation-proof. The necessary radiation measures should be taken in the product design by the customer depending on the intended use.
11. The products do not affect human health under normal use. However, they contain chemical substances and heavy metals and should therefore not be put in the mouth. The fracture surfaces of wafers and chips may be sharp. Be careful when handling these with the bare hands to prevent injuries, etc.
12. When disposing of the products, comply with the laws and ordinances of the country or region where they are used.
13. The information described herein contains copyright information and know-how of ABLIC Inc. The information described herein does not convey any license under any intellectual property rights or any other rights belonging to ABLIC Inc. or a third party. Reproduction or copying of the information from this document or any part of this document described herein for the purpose of disclosing it to a third-party is strictly prohibited without the express permission of ABLIC Inc.
14. For more details on the information described herein or any other questions, please contact ABLIC Inc.'s sales representative.
15. This Disclaimers have been delivered in a text using the Japanese language, which text, despite any translations into the English language and the Chinese language, shall be controlling.

2.4-2019.07

## X-ON Electronics

Largest Supplier of Electrical and Electronic Components

*Click to view similar products for [LDO Voltage Regulators](#) category:*

*Click to view products by [Ablic](#) manufacturer:*

Other Similar products are found below :

[AP7363-SP-13](#) [L79M05TL-E](#) [PT7M8202B12TA5EX](#) [TCR3DF185,LM\(CT](#) [TCR3DF24,LM\(CT](#) [TCR3DF285,LM\(CT](#) [TCR3DF31,LM\(CT](#)  
[TCR3DF45,LM\(CT](#) [MP2013GQ-33-Z](#) [059985X](#) [NCP4687DH15T1G](#) [701326R](#) [TCR2EN28,LF\(S](#) [NCV8170AXV250T2G](#)  
[TCR3DF27,LM\(CT](#) [TCR3DF19,LM\(CT](#) [TCR3DF125,LM\(CT](#) [TCR2EN18,LF\(S](#) [AP2112R5A-3.3TRG1](#) [AP7315-25W5-7](#)  
[IFX30081LDVGRNXUMA1](#) [NCV47411PAAJR2G](#) [AP2113KTR-G1](#) [AP2111H-1.2TRG1](#) [ZLDO1117QK50TC](#) [AZ1117IH-1.8TRG1](#)  
[AZ1117ID-ADJTRG1](#) [TCR3DG12,LF](#) [MIC5514-3.3YMT-T5](#) [MIC5512-1.2YMT-T5](#) [MIC5317-2.8YM5-T5](#) [SCD7912BTG](#)  
[NCP154MX180270TAG](#) [SCD33269T-5.0G](#) [NCV8170BMX330TCG](#) [NCV8170AMX120TCG](#) [NCP706ABMX300TAG](#)  
[NCP153MX330180TCG](#) [NCP114BMX075TCG](#) [MC33269T-3.5G](#) [CAT6243-ADJCMT5T](#) [TCR3DG33,LF](#) [AP2127N-1.0TRG1](#)  
[TCR4DG35,LF](#) [LT1117CST-3.3](#) [LT1117CST-5](#) [TAR5S15U\(TE85L,F\)](#) [TAR5S18U\(TE85L,F\)](#) [TCR3UG19A,LF](#) [TCR4DG105,LF](#)