

The S-19214 Series developed by using high-withstand voltage CMOS process technology, is a positive voltage regulator with a high-withstand voltage, low current consumption and high-accuracy output voltage.

The S-19214 Series operates at the maximum operation voltage of 36 V and a low current consumption of 5.0 μ A typ. and has a built-in low on-resistance output transistor, which provides a very small dropout voltage and a large output current. In addition to the type in which output voltage is set inside the IC, the type for which output voltage can be set via an external resistor is added to a lineup. Also, a built-in overcurrent protection circuit to limit overcurrent of the output transistor and a built-in thermal shutdown circuit to limit heat are included.

ABLIC Inc. offers a "thermal simulation service" which supports the thermal design in conditions when our power management ICs are in use by customers. Our thermal simulation service will contribute to reducing the risk in the thermal design at customers' development stage.

For more information regarding our thermal simulation service, contact our sales representatives.

ABLIC Inc. offers FIT rate calculated based on actual customer usage conditions in order to support customer functional safety design.

For more information regarding our FIT rate calculation, contact our sales representatives.

Caution This product can be used in vehicle equipment and in-vehicle equipment. Before using the product for these purposes, it is imperative to contact our sales representatives.

■ Features

- Output voltage (internally set): 1.8 V, 3.0 V, 3.3 V, 5.0 V, 8.0 V, 12.0 V
- Output voltage (externally set): 1.8 V to 30.0 V, settable via external resistor
- Input voltage: 2.8 V to 36.0 V
- Output voltage accuracy: $\pm 1.5\%$ ($T_j = -40^\circ\text{C}$ to $+125^\circ\text{C}$)
- Current consumption:
 - During operation: 5.0 μ A typ., 9.8 μ A max. ($T_j = -40^\circ\text{C}$ to $+125^\circ\text{C}$)
 - During power-off: 0.1 μ A typ., 2.0 μ A max. ($T_j = -40^\circ\text{C}$ to $+125^\circ\text{C}$)
- Output current: Possible to output 1000 mA (at $V_{IN} \geq V_{OUT(S)} + 2.0\text{ V}$)*1
- Input and output capacitors: A ceramic capacitor can be used. (1.0 μ F or more)
- Built-in overcurrent protection circuit: Limits overcurrent of output transistor.
(with a detection function of the difference between input and output voltage)
- Built-in thermal shutdown circuit: Detection temperature 170°C typ.
- Built-in ON / OFF circuit: Ensures long battery life.
Discharge shunt function is available.
Pull-down function is available.
- Operation temperature range: $T_a = -40^\circ\text{C}$ to $+125^\circ\text{C}$
- Lead-free (Sn 100%), halogen-free
- Withstand 45 V load dump
- AEC-Q100 qualified*2

*1. Please make sure that the loss of the IC will not exceed the power dissipation when the output current is large.

*2. Contact our sales representatives for details.

■ Applications

- Constant-voltage power supply for electrical application for vehicle interior
- Constant-voltage power supply for home electric appliance
- For automotive use (engine, transmission, suspension, ABS, related-devices for EV / HEV / PHEV, etc.)

■ Packages

- TO-252-5S(A)
- HSOP-8A

■ **Block Diagrams**

1. Type in which output voltage is internally set

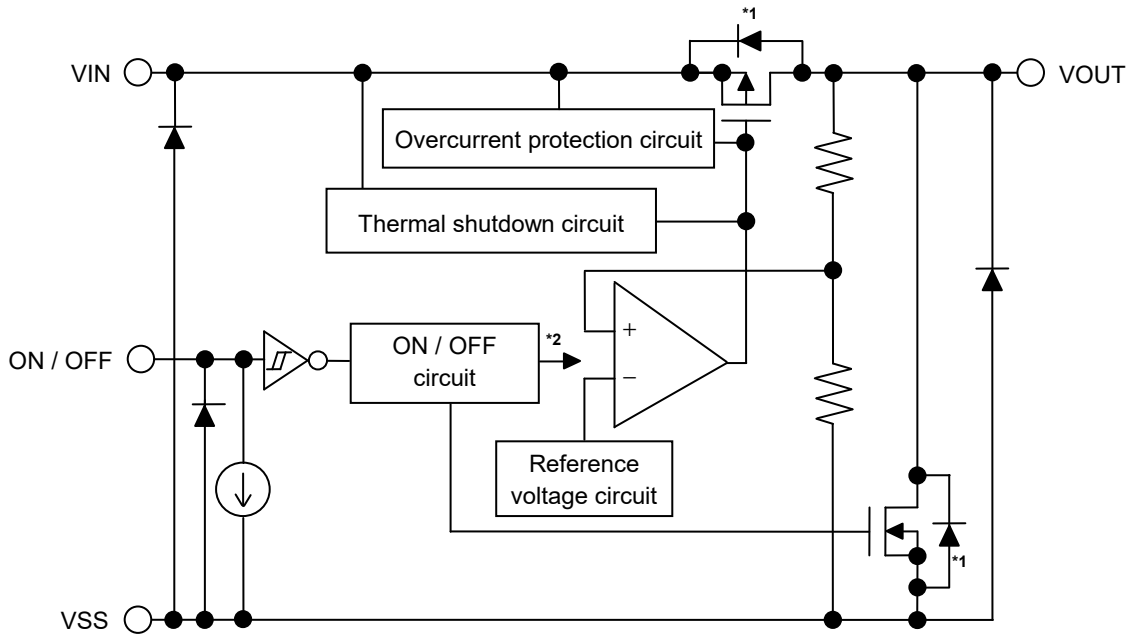

*1. Parasitic diode

*2. The ON / OFF circuit controls the internal circuit and the output transistor.

Figure 1

2. Type in which output voltage is externally set

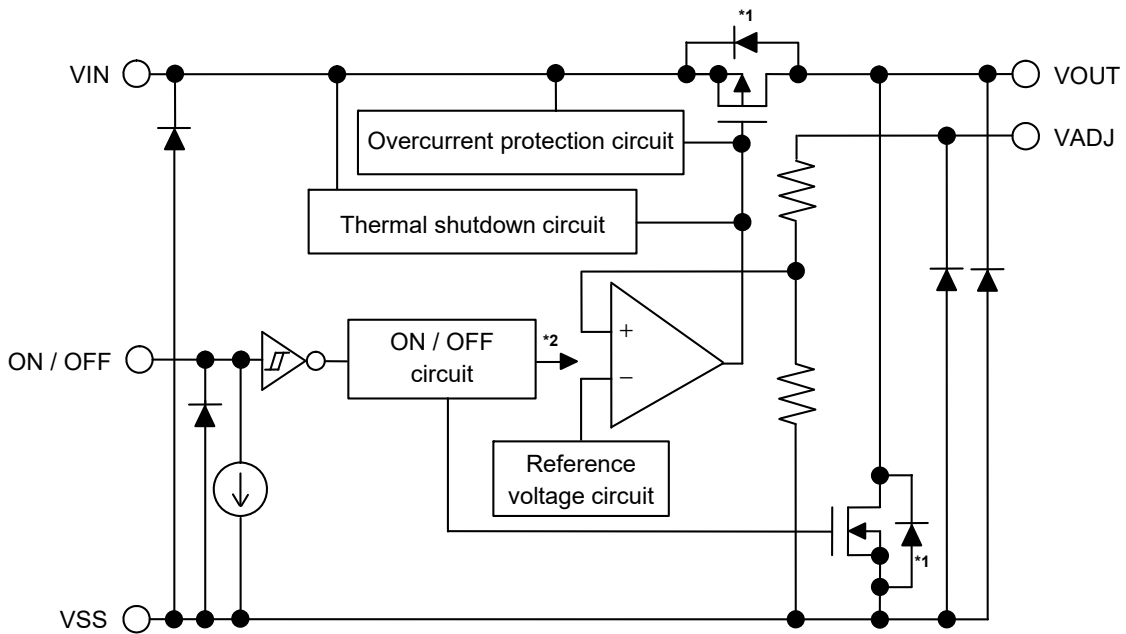

*1. Parasitic diode

*2. The ON / OFF circuit controls the internal circuit and the output transistor.

Figure 2

■ **AEC-Q100 qualified**

This IC supports AEC-Q100 for operation temperature grade 1.
 Contact our sales representatives for details of AEC-Q100 reliability specification.

■ **Product Name Structure**

Users can select the output voltage and package type for the S-19214 Series. Refer to "1. **Product name**" regarding the contents of product name, "2. **Packages**" regarding the package drawings and "3. **Product name list**" for details of product names.

1. Product name

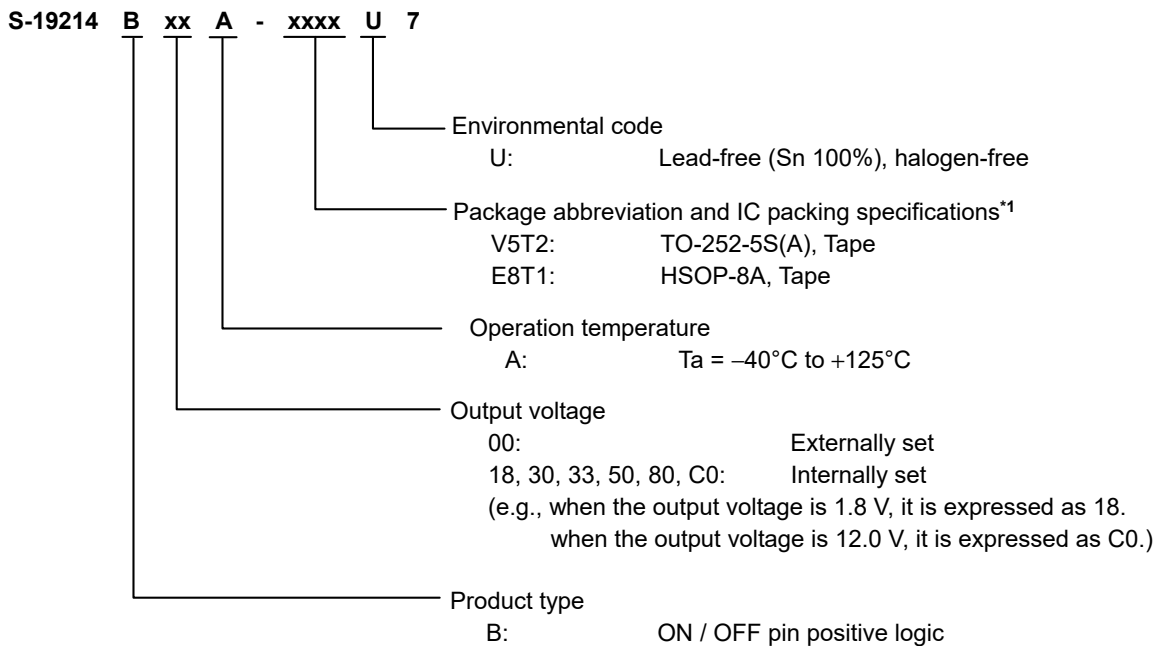

*1. Refer to the tape drawing.

2. Packages

Table 1 Package Drawing Codes

Package Name	Dimension	Tape	Reel	Land
TO-252-5S(A)	VA005-A-P-SD	VA005-A-C-SD	VA005-A-R-SD	VA005-A-L-SD
HSOP-8A	FH008-A-P-SD	FH008-A-C-SD	FH008-A-R-SD	FH008-A-L-SD

3. Product name list

Table 2

Output Voltage	TO-252-5S(A)	HSOP-8A
Externally set	S-19214B00A-V5T2U7	S-19214B00A-E8T1U7
1.8 V \pm 1.5%	S-19214B18A-V5T2U7	S-19214B18A-E8T1U7
3.0 V \pm 1.5%	S-19214B30A-V5T2U7	S-19214B30A-E8T1U7
3.3 V \pm 1.5%	S-19214B33A-V5T2U7	S-19214B33A-E8T1U7
5.0 V \pm 1.5%	S-19214B50A-V5T2U7	S-19214B50A-E8T1U7
8.0 V \pm 1.5%	S-19214B80A-V5T2U7	S-19214B80A-E8T1U7
12.0 V \pm 1.5%	S-19214BC0A-V5T2U7	S-19214BC0A-E8T1U7

Remark Please contact our sales representatives for products other than the above.

■ **Pin Configurations**

1. **TO-252-5S(A)**

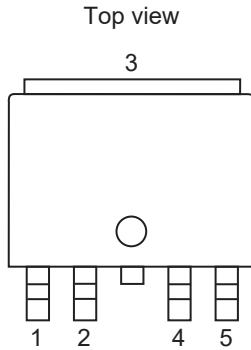

Figure 3

Table 3 Type in Which Output Voltage is Internally Set

Pin No.	Symbol	Description
1	VIN	Input voltage pin
2	ON / OFF	ON / OFF pin
3	VSS	GND pin
4	NC*1	No connection
5	VOUT	Output voltage pin

Table 4 Type in Which Output Voltage is Externally Set

Pin No.	Symbol	Description
1	VIN	Input voltage pin
2	ON / OFF	ON / OFF pin
3	VSS	GND pin
4	VADJ	Output voltage adjustment pin
5	VOUT	Output voltage pin

*1. The NC pin is electrically open.
 The NC pin can be connected to the VIN pin or the VSS pin.

2. HSOP-8A

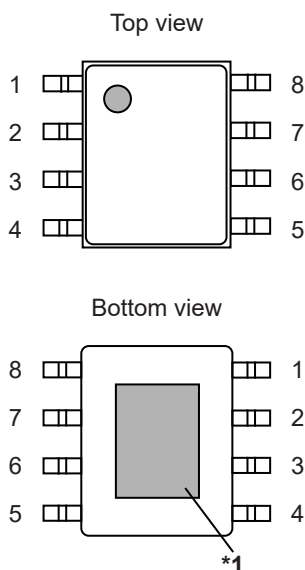

Figure 4

Table 5 Type in Which Output Voltage is Internally Set

Pin No.	Symbol	Description
1	VIN	Input voltage pin
2	NC*2	No connection
3	NC*2	No connection
4	ON / OFF	ON / OFF pin
5	VSS	GND pin
6	NC*2	No connection
7	NC*2	No connection
8	VOUT	Output voltage pin

Table 6 Type in Which Output Voltage is Externally Set

Pin No.	Symbol	Description
1	VIN	Input voltage pin
2	NC*2	No connection
3	NC*2	No connection
4	ON / OFF	ON / OFF pin
5	VSS	GND pin
6	NC*2	No connection
7	VADJ	Output voltage adjustment pin
8	VOUT	Output voltage pin

- *1. Connect the heat sink of backside at shadowed area to the board, and set electric potential GND.
However, do not use it as the function of electrode.
- *2. The NC pin is electrically open.
The NC pin can be connected to the VIN pin or the VSS pin.

■ **Absolute Maximum Ratings**

Table 7

(Ta = +25°C unless otherwise specified)

Item	Symbol	Absolute Maximum Rating	Unit
Input voltage	V _{IN}	V _{SS} - 0.3 to V _{SS} + 45	V
	V _{ON/OFF}	V _{SS} - 0.3 to V _{SS} + 45	V
	V _{VADJ}	V _{SS} - 0.3 to V _{SS} + 45	V
Output voltage	V _{OUT}	V _{SS} - 0.3 to V _{IN} + 0.3 ≤ V _{SS} + 45	V
Output current	I _{OUT}	1100	mA
Junction temperature	T _J	-40 to +150	°C
Operation ambient temperature	T _{opr}	-40 to +125	°C
Storage temperature	T _{stg}	-40 to +150	°C

Caution The absolute maximum ratings are rated values exceeding which the product could suffer physical damage. These values must therefore not be exceeded under any conditions.

■ **Thermal Resistance Value**

Table 8

Item	Symbol	Condition	Min.	Typ.	Max.	Unit	
Junction-to-ambient thermal resistance*1,*2	θ _{JA}	TO-252-5S(A)	Board A	-	86	-	°C/W
			Board B	-	-	-	°C/W
			Board C	-	-	-	°C/W
			Board D	-	-	-	°C/W
			Board E	-	24	-	°C/W
		HSOP-8A	Board A	-	104	-	°C/W
			Board B	-	-	-	°C/W
			Board C	-	-	-	°C/W
			Board D	-	-	-	°C/W
			Board E	-	30	-	°C/W

*1. Test environment: compliance with JEDEC STANDARD JESD51-2A

*2. Measurement values when this IC is mounted on each board

Remark Refer to "■ Power Dissipation" and "Test Board" for details.

■ **Electrical Characteristics**

1. Type in which output voltage is internally set

Table 9

(T_j = -40°C to +125°C unless otherwise specified)

Item	Symbol	Condition		Min.	Typ.	Max.	Unit	Test Circuit
Output voltage*1	V _{OUT(E)}	V _{IN} = 13.5 V, I _{OUT} = 10 mA	V _{OUT(S)} = 1.8 V, 3.0 V, 3.3 V, 5.0 V, 8.0 V, 12.0 V	V _{OUT(S)} - 1.5%	V _{OUT(S)}	V _{OUT(S)} + 1.5%	V	1
		V _{OUT(S)} + 1.0 V ≤ V _{IN} ≤ 18.0 V, 1 mA ≤ I _{OUT} ≤ 200 mA		V _{OUT(S)} - 1.8%	V _{OUT(S)}	V _{OUT(S)} + 1.8%	V	1
Output current*2	I _{OUT}	V _{OUT(S)} + 2.0 V ≤ V _{IN}		1000*4	-	-	mA	3
Dropout voltage*3	V _{drop}	I _{OUT} = 200 mA, T _a = +25°C	V _{OUT(S)} = 1.8 V	-	*5	-	V	1
			V _{OUT(S)} = 3.0 V, 3.3 V	-	0.16	0.32	V	1
			V _{OUT(S)} = 5.0 V, 8.0 V, 12.0 V	-	0.13	0.22	V	1
Line regulation	$\frac{\Delta V_{OUT1}}{\Delta V_{IN} \cdot V_{OUT}}$	V _{OUT(S)} + 1.0 V ≤ V _{IN} ≤ 28.0 V, I _{OUT} = 10 mA		-	0.015	0.03	%/V	1
Load regulation	ΔV _{OUT2}	V _{IN} = V _{OUT(S)} + 1.0 V, 1 mA ≤ I _{OUT} ≤ 300 mA, T _a = +25°C	V _{OUT(S)} = 1.8 V, 3.0 V, 3.3 V	-	15	30	mV	1
			V _{OUT(S)} = 5.0 V	-	20	40	mV	1
			V _{OUT(S)} = 8.0 V	-	35	70	mV	1
			V _{OUT(S)} = 12.0 V	-	45	90	mV	1
Current consumption during operation	I _{SS1}	V _{IN} = 13.5 V, I _{OUT} = 10 μA, ON / OFF pin = ON		-	5.0	9.8	μA	2
Current consumption during power-off	I _{SS2}	V _{IN} = 13.5 V, no load, ON / OFF pin = OFF		-	0.1	2.0	μA	2
Input voltage	V _{IN}	-		2.8	-	36.0	V	-
ON / OFF pin input voltage "H"	V _{SH}	V _{IN} = 13.5 V, R _L = 1.0 kΩ, determined by V _{OUT} output level		2.0	-	-	V	4
ON / OFF pin input voltage "L"	V _{SL}	V _{IN} = 13.5 V, R _L = 1.0 kΩ, determined by V _{OUT} output level		-	-	0.8	V	4
ON / OFF pin input current "H"	I _{SH}	V _{IN} = 13.5 V, V _{ON / OFF} = V _{IN}		-0.1	0.3	1.0	μA	4
ON / OFF pin input current "L"	I _{SL}	V _{IN} = 13.5 V, V _{ON / OFF} = 0 V		-0.1	-	0.1	μA	4
Ripple rejection	RR	V _{IN} = 13.5 V, f = 100 Hz, ΔV _{rip} = 0.5 V _{rms} , I _{OUT} = 100 mA, T _a = +25°C	V _{OUT(S)} = 1.8 V, 3.0 V, 3.3 V, 5.0 V	-	60	-	dB	5
			V _{OUT(S)} = 8.0 V, 12.0 V	-	50	-	dB	5
Short-circuit current	I _{short}	V _{IN} = V _{OUT(S)} + 1.0 V, ON / OFF pin = ON, V _{OUT} = 0 V, T _a = +25°C		-	250	-	mA	3
Thermal shutdown detection temperature	T _{SD}	Junction temperature		-	170	-	°C	-
Thermal shutdown release temperature	T _{SR}	Junction temperature		-	135	-	°C	-
Discharge shunt resistance during power-off	R _{LOW}	V _{IN} = 13.5 V, V _{OUT} = 0.1 V, ON / OFF pin = OFF		-	3.0	-	kΩ	6

- *1. $V_{OUT(S)}$: Set output voltage
 $V_{OUT(E)}$: Actual output voltage
- *2. The output current at which the output voltage becomes 95% of $V_{OUT(E)}$ after gradually increasing the output current.
- *3. $V_{drop} = V_{IN1} - (V_{OUT3} \times 0.98)$
 V_{IN1} is the input voltage at which the output voltage becomes 98% of V_{OUT3} after gradually decreasing the input voltage.
 V_{OUT3} is the output voltage when $V_{IN} = V_{OUT(S)} + 1.0$ V and $I_{OUT} = 200$ mA.
- *4. Due to limitation of the power dissipation, this value may not be satisfied. Attention should be paid to the power dissipation when the output current is large.
This specification is guaranteed by design.
- *5. The dropout voltage is limited by the difference between the input voltage (min. value) and the set output voltage.
In case of 1.8 V $\leq V_{OUT(S)} < 2.8$ V: 2.8 V $- V_{OUT(S)} = V_{drop}$

2. Type in which output voltage is externally set

Table 10

(T_j = -40°C to +125°C, V_{OUT} = V_{VADJ} unless otherwise specified)

Item	Symbol	Condition	Min.	Typ.	Max.	Unit	Test Circuit
Adjustment pin output voltage*1	V _{VADJ}	V _{IN} = 13.5 V, I _{OUT} = 10 mA	1.773	1.8	1.827	V	7
		2.8 V ≤ V _{IN} ≤ 18.0 V, 1 mA ≤ I _{OUT} ≤ 200 mA	1.768	1.8	1.832	V	7
Output voltage range	V _{ROUT}	–	1.8	–	30.0	V	13
Adjustment pin internal resistance	R _{VADJ}	–	–	26	–	MΩ	–
Output current*2	I _{OUT}	3.8 V ≤ V _{IN}	1000*4	–	–	mA	9
Dropout voltage*3	V _{drop}	I _{OUT} = 200 mA, T _a = +25°C	–	*5	–	V	7
Line regulation	$\frac{\Delta V_{OUT1}}{\Delta V_{IN} \cdot V_{OUT}}$	2.8 V ≤ V _{IN} ≤ 28.0 V, I _{OUT} = 10 mA	–	0.015	0.03	%/V	7
Load regulation	ΔV _{OUT2}	V _{IN} = 2.8 V, 1 mA ≤ I _{OUT} ≤ 200 mA, T _a = +25°C	–	15	30	mV	7
Current consumption during operation	I _{SS1}	V _{IN} = 13.5 V, ON / OFF pin = ON, I _{OUT} = 10 μA	–	5.0	9.8	μA	8
Current consumption during power-off	I _{SS2}	V _{IN} = 13.5 V, ON / OFF pin = OFF, no load	–	0.1	2.0	μA	8
Input voltage	V _{IN}	–	2.8	–	36.0	V	–
ON / OFF pin input voltage "H"	V _{SH}	V _{IN} = 13.5 V, R _L = 1.0 kΩ, determined by V _{OUT} output level	2.0	–	–	V	10
ON / OFF pin input voltage "L"	V _{SL}	V _{IN} = 13.5 V, R _L = 1.0 kΩ, determined by V _{OUT} output level	–	–	0.8	V	10
ON / OFF pin input current "H"	I _{SH}	V _{IN} = 13.5 V, V _{ON / OFF} = V _{IN}	–0.1	0.3	1.0	μA	10
ON / OFF pin input current "L"	I _{SL}	V _{IN} = 13.5 V, V _{ON / OFF} = 0 V	–0.1	–	0.1	μA	10
Ripple rejection	RR	V _{IN} = 13.5 V, f = 100 Hz, ΔV _{rip} = 0.5 V _{rms} , I _{OUT} = 100 mA, T _a = +25°C	–	60	–	dB	11
Short-circuit current	I _{short}	V _{IN} = 2.8 V, ON / OFF pin = ON, V _{OUT} = 0 V, T _a = +25°C	–	250	–	mA	9
Thermal shutdown detection temperature	T _{SD}	Junction temperature	–	170	–	°C	–
Thermal shutdown release temperature	T _{SR}	Junction temperature	–	135	–	°C	–
Discharge shunt resistance during power-off	R _{LOW}	V _{IN} = 13.5 V, ON / OFF pin = OFF, V _{OUT} = 0.1 V	–	3.0	–	kΩ	12

- *1. V_{OUT(S)}: Set output voltage = 1.8 V
- *2. The output current at which the output voltage becomes 95% of V_{OUT(E)} after gradually increasing the output current.
- *3. V_{drop} = V_{IN1} – (V_{OUT3} × 0.98)
V_{IN1} is the input voltage at which the output voltage becomes 98% of V_{OUT3} after gradually decreasing the input voltage.
V_{OUT3} is the output voltage when V_{IN} = V_{OUT(S)} + 1.0 V and I_{OUT} = 200 mA.
- *4. Due to limitation of the power dissipation, this value may not be satisfied. Attention should be paid to the power dissipation when the output current is large.
This specification is guaranteed by design.
- *5. The dropout voltage is limited by the difference between the input voltage (min. value) and the set output voltage.
In case of 1.8 V ≤ V_{OUT(S)} < 2.8 V: 2.8 V – V_{OUT(S)} = V_{drop}

■ **Test Circuits**

1. Type in which output voltage is internally set

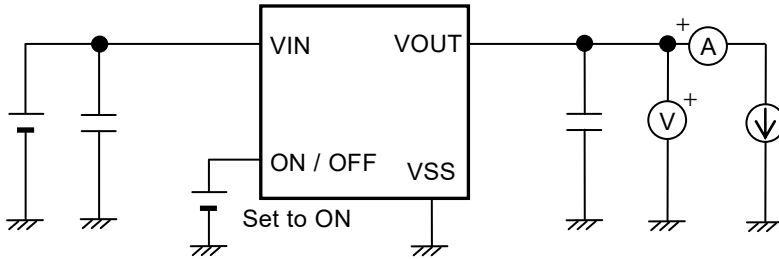

Figure 5 Test Circuit 1

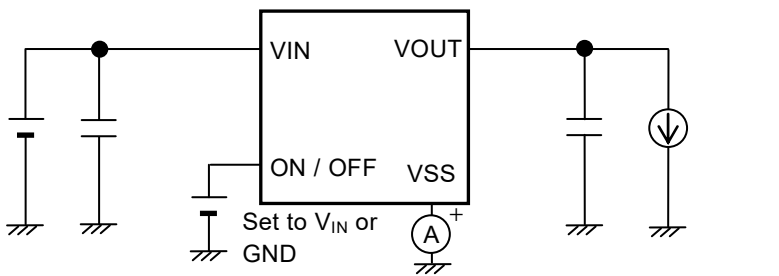

Figure 6 Test Circuit 2

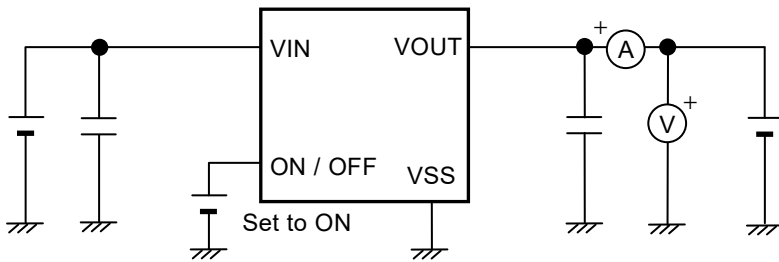

Figure 7 Test Circuit 3

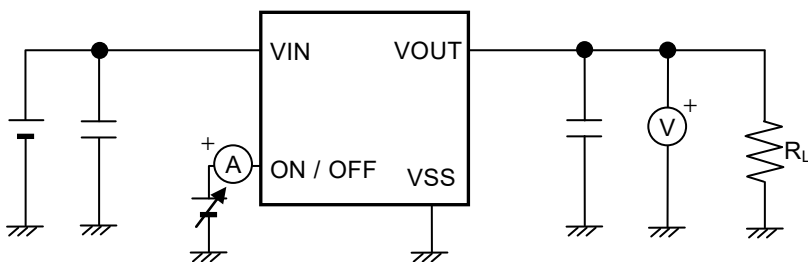

Figure 8 Test Circuit 4

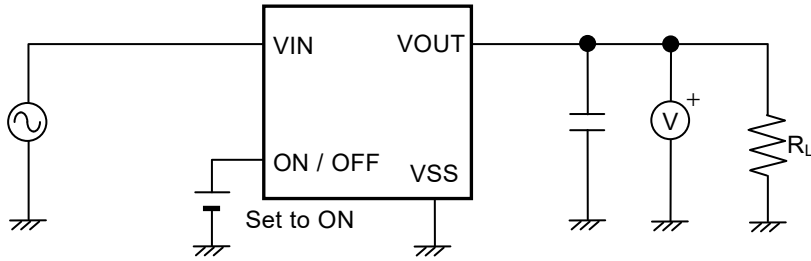

Figure 9 Test Circuit 5

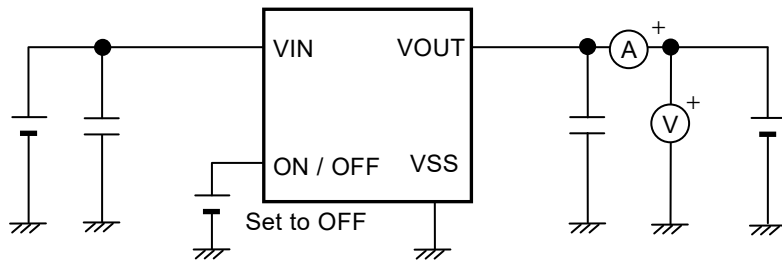

Figure 10 Test Circuit 6

2. Type in which output voltage is externally set

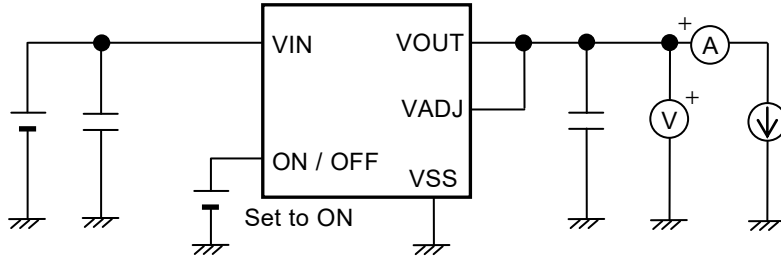

Figure 11 Test Circuit 7

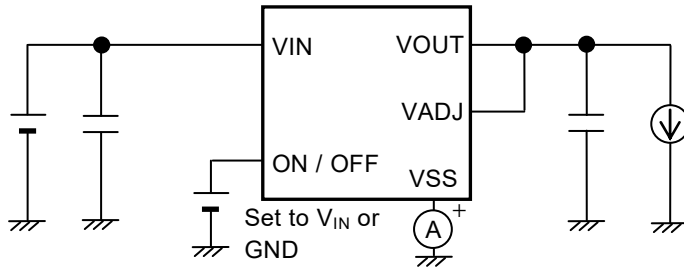

Figure 12 Test Circuit 8

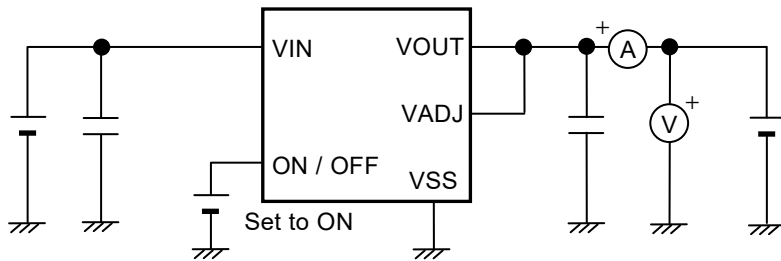

Figure 13 Test Circuit 9

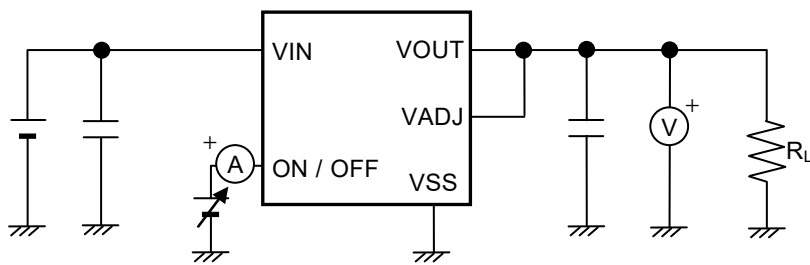

Figure 14 Test Circuit 10

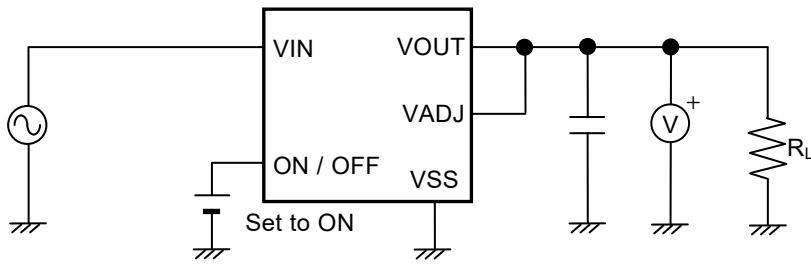

Figure 15 Test Circuit 11

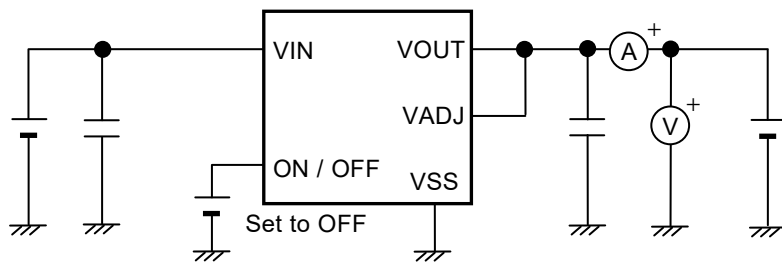

Figure 16 Test Circuit 12

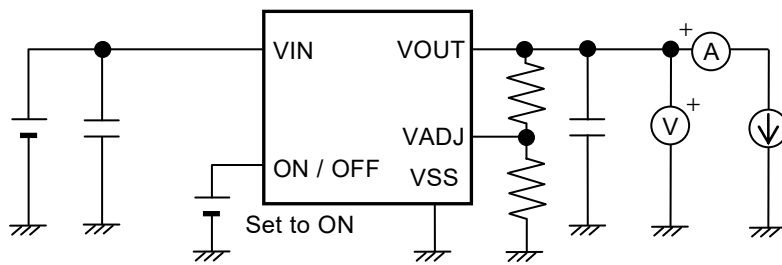

Figure 17 Test Circuit 13

■ Standard Circuits

1. Type in which output voltage is internally set

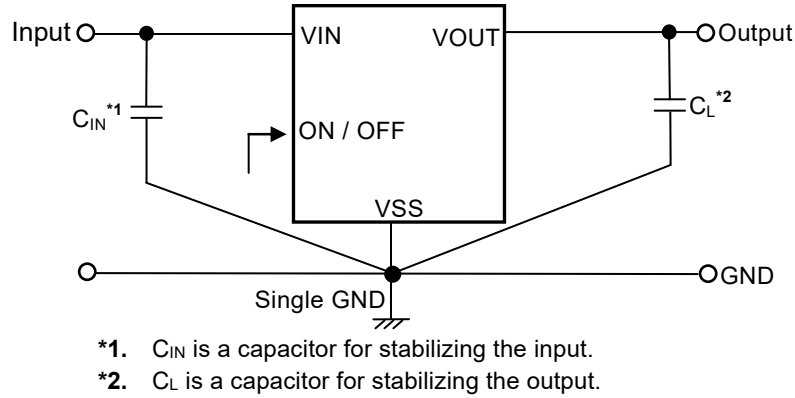

Figure 18

2. Type in which output voltage is externally set

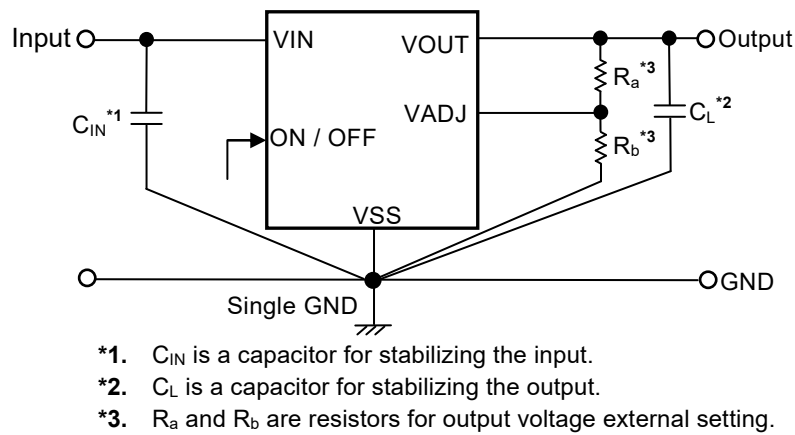

Figure 19

Caution The above connection diagrams and constants will not guarantee successful operation. Perform thorough evaluation including the temperature characteristics with an actual application to set the constants.

■ Condition of Application

Input capacitor (C_{IN}): A ceramic capacitor with capacitance of 1.0 μ F or more is recommended.
 Output capacitor (C_L): A ceramic capacitor with capacitance of 1.0 μ F or more is recommended.
 ESR of output capacitor: A ceramic capacitor with capacitance of 100 Ω or less is recommended.

Caution Generally, in a voltage regulator, an oscillation may occur depending on the selection of the external parts. Perform thorough evaluation including the temperature characteristics with an actual application using the above capacitors to confirm no oscillation occurs.

■ Selection of Input Capacitor (C_{IN}) and Output Capacitor (C_L)

The S-19214 Series requires C_L between the VOUT pin and the VSS pin for phase compensation. The operation is stabilized by a ceramic capacitor with capacitance of 1.0 μ F or more. When using an OS capacitor, a tantalum capacitor or an aluminum electrolytic capacitor, the capacitance also must be 1.0 μ F or more. However, an oscillation may occur depending on the equivalent series resistance (ESR).

Moreover, the S-19214 Series requires C_{IN} between the VIN pin and the VSS pin for a stable operation.

Generally, an oscillation may occur when a voltage regulator is used under the condition that the impedance of the power supply is high.

Note that the output voltage transient characteristics varies depending on the capacitance of C_{IN} and C_L and the value of ESR.

Caution Perform thorough evaluation including the temperature characteristics with an actual application to select C_{IN} and C_L .

■ Selection of Resistors (R_a , R_b) for Output Voltage External Setting

The S-19214 Series provides the type in which output voltage can be set via the external resistor. The output voltage can be set by connecting a resistor (R_a) between the VOUT pin and the VADJ pin, and a resistor (R_b) between the VADJ pin and the VSS pin.

Depending on the intended output voltage, select R_a and R_b from the range shown in **Table 11**.

Caution Since the VADJ pin impedance is comparatively high and is easily affected by noise, pay adequate attention to the wiring pattern.

Table 11

V_{OUT}	R_a	R_b
1.8 V	Connect to VOUT pin	Unnecessary
1.85 V to 30.0 V	0.25 k Ω to 2.6 M Ω	10 k Ω to 200 k Ω

■ Explanation of Terms

1. Low dropout voltage regulator

This is a voltage regulator which made dropout voltage small by its built-in low on-resistance output transistor.

2. Output voltage (V_{OUT})

This voltage is output at an accuracy of $\pm 1.5\%$ when the input voltage, the output current and the temperature are in a certain condition*1.

*1. Differs depending on the product.

Caution If the certain condition is not satisfied, the output voltage may exceed the accuracy range of $\pm 1.5\%$. Refer to "■ Electrical Characteristics" and "■ Characteristics (Typical Data)" for details.

3. Line regulation $\left(\frac{\Delta V_{OUT1}}{\Delta V_{IN} \bullet V_{OUT}} \right)$

Indicates the dependency of the output voltage against the input voltage. That is, the value shows how much the output voltage changes due to a change in the input voltage after fixing output current constant.

4. Load regulation (ΔV_{OUT2})

Indicates the dependency of the output voltage against the output current. That is, the value shows how much the output voltage changes due to a change in the output current after fixing input voltage constant.

5. Dropout voltage (V_{drop})

Indicates the difference between input voltage (V_{IN1}) and the output voltage when the output voltage becomes 98% of the output voltage value (V_{OUT3}) at $V_{IN} = V_{OUT(S)} + 1.0$ V after the input voltage (V_{IN}) is decreased gradually.

$$V_{drop} = V_{IN1} - (V_{OUT3} \times 0.98)$$

■ **Operation**

1. Basic operation

Figure 20 shows the block diagram of the S-19214 Series to describe the basic operation.

The error amplifier compares the feedback voltage (V_{fb}) whose output voltage (V_{OUT}) is divided by the feedback resistors (R_s and R_f) with the reference voltage (V_{ref}). The error amplifier controls the output transistor, consequently, the regulator starts the operation that keeps V_{OUT} constant without the influence of the input voltage (V_{IN}).

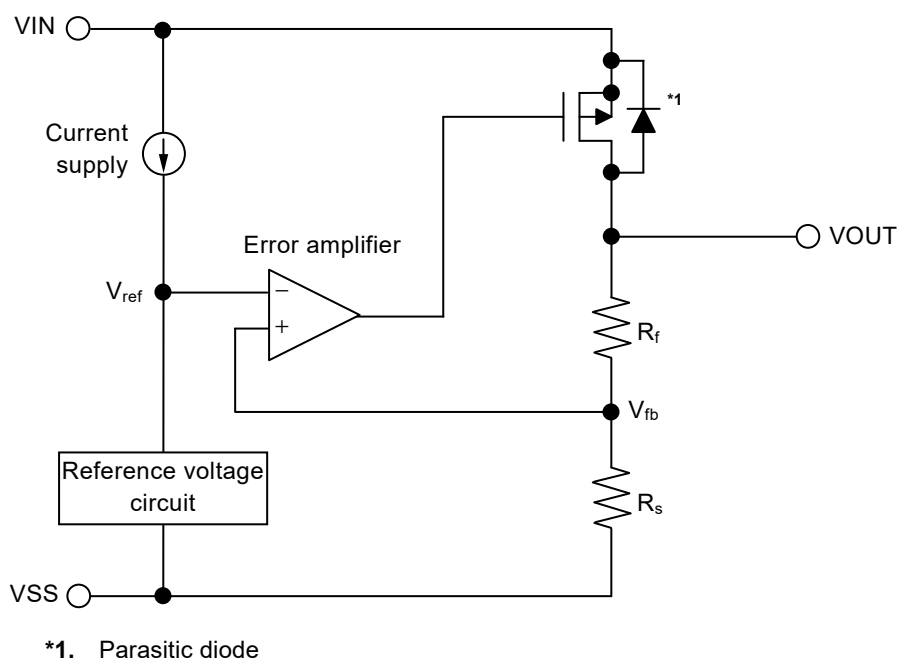

Figure 20

2. Output transistor

In the S-19214 Series, a low on-resistance P-channel MOS FET is used between the VIN pin and the VOUT pin as the output transistor. In order to keep V_{OUT} constant, the on-resistance of the output transistor varies appropriately according to the output current (I_{OUT}).

Caution Since a parasitic diode exists between the VIN pin and the VOUT pin due to the structure of the transistor, the IC may be damaged by a reverse current if V_{OUT} becomes higher than V_{IN} . Therefore, be sure that V_{OUT} does not exceed $V_{IN} + 0.3$ V.

3. ON / OFF pin

The ON / OFF pin controls the internal circuit and the output transistor in order to start and stop the regulator. When the ON / OFF pin is set to OFF, the internal circuit stops operating and the output transistor between the VIN pin and the VOUT pin is turned off, reducing current consumption significantly.

Note that the current consumption increases when a voltage of 0.8 V to $V_{IN} - 0.3$ V is applied to the ON / OFF pin.

The ON / OFF pin is configured as shown in **Figure 21**.

Since the ON / OFF pin is internally pulled down to the VSS pin in the floating status, the VOUT pin is set to the V_{SS} level.

Table 12

Product Type	ON / OFF Pin	Internal Circuit	VOUT Pin Voltage	Current Consumption
B	"H" : ON	Operate	Constant value*1	I_{SS1}
B	"L" : OFF	Stop	Pulled down to V_{SS} *2	I_{SS2}

*1. The constant value is output due to the regulating based on the set output voltage value.

*2. The VOUT pin voltage is pulled down to V_{SS} due to combined resistance ($R_{LOW} = 3.0$ k Ω typ.) of the discharge shunt circuit and the feedback resistors, and a load.

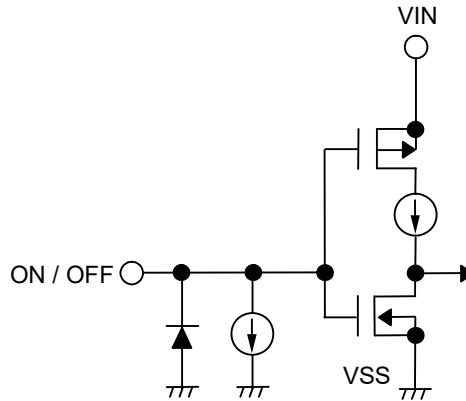
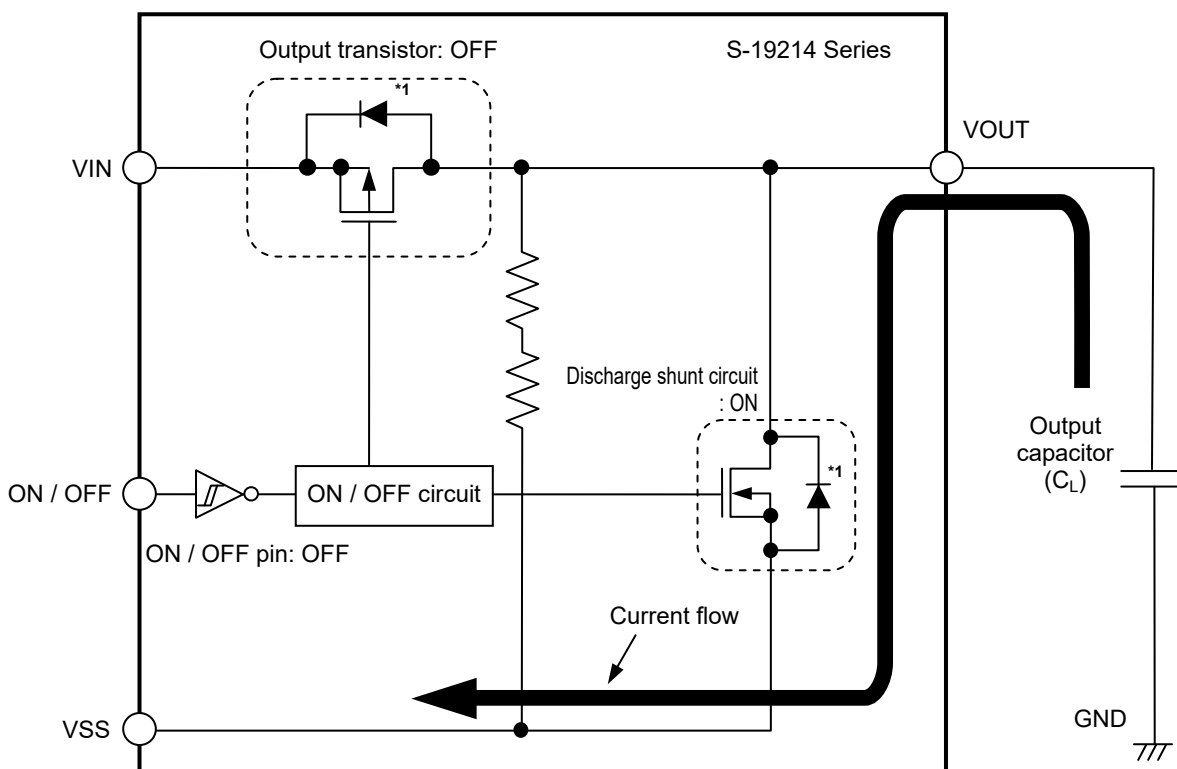

Figure 21

4. Discharge shunt function

The S-19214 Series has a built-in discharge shunt circuit to discharge the output capacitance. The output capacitance is discharged as follows so that the VOUT pin reaches the VSS level.

- (1) The ON / OFF pin is set to OFF level.
- (2) The output transistor is turned off.
- (3) The discharge shunt circuit is turned on.
- (4) The output capacitor discharges.



*1. Parasitic diode

Figure 22

5. Constant current source pull-down

Note that the IC's current consumption increases as much as current flows into the constant current of 0.3 μ A typ. when the ON / OFF pin is connected to the VIN pin and the S-19214 Series is operating. Since the ON / OFF pin is internally pulled down to the VSS pin in the floating status, the VOUT pin is set to the VSS level.

6. Overcurrent protection circuit

The S-19214 Series has a built-in overcurrent protection circuit to limit the overcurrent of the output transistor. When the VOUT pin is shorted to the VSS pin, that is, at the time of the output short-circuit, the output current is limited to 250 mA typ. due to the overcurrent protection circuit operation. The S-19214 Series restarts regulating when the output transistor is released from the overcurrent status.

In addition, the overcurrent protection circuit is equipped with a detection function of the difference between input and output voltage. When the output current is large and the difference between input voltage and output voltage is large, the output current is limited by the detection function of the difference between input and output voltage. This prevents the output transistor which drives the load from being damaged by excessive electric power. The S-19214 Series restarts regulating when the output transistor is released from the excessive electric power.

For details on output current limit values in input voltage, refer to "10. Input voltage vs. Output current (When load current increases) (Ta = +25°C)" in "■ Characteristics (Typical Data)".

Caution This overcurrent protection circuit does not work as for thermal protection. For example, when the output transistor keeps the overcurrent status long at the time of output short-circuit or due to other reasons, pay attention to the conditions of the input voltage and the load current so as not to exceed the power dissipation.

7. Thermal shutdown circuit

The S-19214 Series has a built-in thermal shutdown circuit to limit overheating. When the junction temperature increases to 170°C typ., the thermal shutdown circuit becomes the detection status, and the regulating is stopped. When the junction temperature decreases to 135°C typ., the thermal shutdown circuit becomes the release status, and the regulator is restarted.

If the thermal shutdown circuit becomes the detection status due to self-heating, the regulating is stopped and VOUT decreases. For this reason, the self-heating is limited and the temperature of the IC decreases. The thermal shutdown circuit becomes release status when the temperature of the IC decreases, and the regulating is restarted thus the self-heating is generated again. Repeating this procedure makes the waveform of VOUT into a pulse-like form. This phenomenon continues unless decreasing either or both of the input voltage and the output current in order to reduce the internal power consumption, or decreasing the ambient temperature. Note that the product may suffer physical damage such as deterioration if the above phenomenon occurs continuously.

Caution If a large load current flows during the restart process of regulating after the thermal shutdown circuit changes to the release status from the detection status, the thermal shutdown circuit becomes the detection status again due to self-heating, and a problem may happen in the restart of regulating. A large load current, for example, occurs when charging to the CL whose capacitance is large. Perform thorough evaluation including the temperature characteristics with an actual application to select CL.

Table 13

Thermal Shutdown Circuit	VOUT Pin Voltage
Release: 135°C typ.*1	Constant value*2
Detection: 170°C typ.*1	Pulled down to VSS*3

*1. Junction temperature

*2. The constant value is output due to the regulating based on the set output voltage value.

*3. The VOUT pin voltage is pulled down to VSS due to the feedback resistors (Rs and Rf) and a load.

8. Inrush current limit circuit

The S-19214 Series has a built-in inrush current limit circuit to limit the inrush current generated at power-on or at the time when the ON / OFF pin is set to ON. The inrush current is limited to 400 mA typ. immediately after power-on or for the internally set, predetermined time of 100 μs min. from the time when ON / OFF pin is set to ON.

9. Type in which output voltage is externally set

The S-19214 Series provides the type in which output voltage can be set via the external resistor. The output voltage can be set by connecting a resistor (R_a) between the VOUT pin and the VADJ pin, and a resistor (R_b) between the VADJ pin and the VSS pin.

The output voltage is determined by the following formulas.

$$V_{OUT} = 1.8 + R_a \times I_a \dots\dots\dots (1)$$

By substituting $I_a = I_{VADJ} + 1.8 / R_b$ to above formula (1),

$$V_{OUT} = 1.8 + R_a \times (I_{VADJ} + 1.8 / R_b) = 1.8 \times (1.0 + R_a / R_b) + R_a \times I_{VADJ} \dots\dots\dots (2)$$

In above formula (2), $R_a \times I_{VADJ}$ is a factor for the output voltage error.

Whether the output voltage error is minute is judged depending on the following (3) formula.

By substituting $I_{VADJ} = 1.8 / R_{VADJ}$ to $R_a \times I_{VADJ}$

$$V_{OUT} = 1.8 \times (1.0 + R_a / R_b) + 1.8 \times R_a / R_{VADJ} \dots\dots\dots (3)$$

If R_{VADJ} is sufficiently larger than R_a , the error is judged as minute.

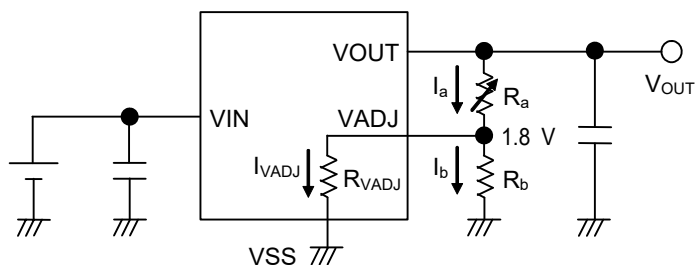

Figure 23

The following expression is in order to determine $V_{OUT} = 20.0$ V.

If $R_b = 10$ k Ω , substitute $R_{VADJ} = 26$ M Ω typ. into (3),

$$R_a = (20.0 / 1.8 - 1) \times ((10 \text{ k} \times 26 \text{ M}) / (10 \text{ k} + 26 \text{ M})) \cong 101 \text{ k}\Omega$$

Caution The above connection diagram and constants will not guarantee successful operation. Perform thorough evaluation using the actual application to set the constants.

■ Precautions

- Generally, when a voltage regulator is used under the condition that the load current value is small (1 mA or less), the output voltage may increase due to the leakage current of an output transistor.
- Generally, when a voltage regulator is used under the condition that the temperature is high, the output voltage may increase due to the leakage current of an output transistor.
- Generally, when the ON / OFF pin is used under the condition of OFF, the output voltage may increase due to the leakage current of an output transistor.
- Generally, when a voltage regulator is used under the condition that the impedance of the power supply is high, an oscillation may occur. Perform thorough evaluation including the temperature characteristics with an actual application to select C_{IN}.
- Generally, in a voltage regulator, an oscillation may occur depending on the selection of the external parts. The following use conditions are recommended in the S-19214 Series; however, perform thorough evaluation including the temperature characteristics with an actual application to select C_{IN} and C_L.

Input capacitor (C_{IN}): A ceramic capacitor with capacitance of 1.0 μF or more is recommended.

Output capacitor (C_L): A ceramic capacitor with capacitance of 1.0 μF or more is recommended.

- Generally, in a voltage regulator, the values of an overshoot and an undershoot in the output voltage vary depending on the variation factors of input voltage start-up, input voltage fluctuation, load fluctuation etc., or the capacitance of C_{IN} or C_L and the value of the equivalent series resistance (ESR), which may cause a problem to the stable operation. Perform thorough evaluation including the temperature characteristics with an actual application to select C_{IN} and C_L.
- Generally, in a voltage regulator, an overshoot may occur in the output voltage momentarily if the input voltage steeply changes when the input voltage is started up, the input voltage fluctuates, etc. Perform thorough evaluation including the temperature characteristics with an actual application to confirm no problems happen.
- Generally, in a voltage regulator, if the VOUT pin is steeply shorted with GND, a negative voltage exceeding the absolute maximum ratings may occur in the VOUT pin due to resonance phenomenon of the inductance and the capacitance including C_L on the application. The resonance phenomenon is expected to be weakened by inserting a series resistor into the resonance path, and the negative voltage is expected to be limited by inserting a protection diode between the VOUT pin and the VSS pin.
- If the input voltage is started up steeply under the condition that the capacitance of C_L is large, the thermal shutdown circuit may be in the detection status by self-heating due to the charge current to C_L.
- Make sure of the conditions for the input voltage, output voltage and the load current so that the internal loss does not exceed the power dissipation.
- Do not apply an electrostatic discharge to this IC that exceeds the performance ratings of the built-in electrostatic protection circuit.
- When considering the output current value that the IC is able to output, make sure of the output current value specified in **Table 9** and **Table 10** in "**■ Electrical Characteristics**" and footnote *4 of the table.
- Wiring patterns on the application related to the VIN pin, the VOUT pin and the VSS pin should be designed so that the impedance is low. When mounting C_{IN} between the VIN pin and the VSS pin and C_L between the VOUT pin and the VSS pin, connect the capacitors as close as possible to the respective destination pins of the IC.
- When setting the output voltage by using an external resistor, connect a resistor (R_a) between the VOUT pin and the VADJ pin and a resistor (R_b) between the VADJ pin and the VSS pin close to the respective pins.
- In the package equipped with heat sink of backside, mount the heat sink firmly. Since the heat radiation differs according to the condition of the application, perform thorough evaluation with an actual application to confirm no problems happen.
- ABLIC Inc. claims no responsibility for any disputes arising out of or in connection with any infringement by products including this IC of patents owned by a third party.

■ **Characteristics (Typical Data)**

1. Output voltage vs. Output current (When load current increases) (Ta = +25°C)

1.1 V_{OUT} = 1.8 V

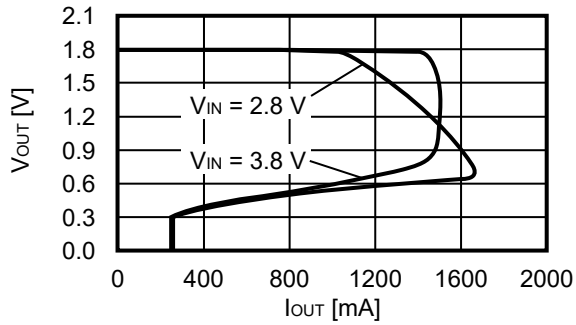

1.2 V_{OUT} = 5.0 V

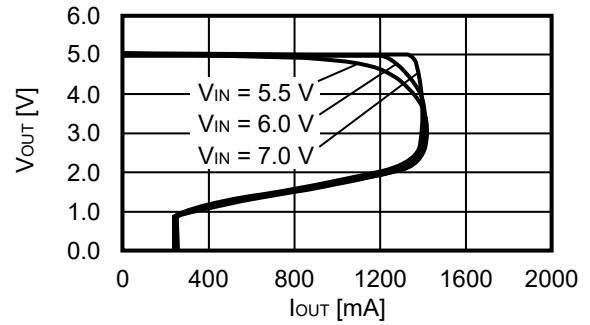

1.3 V_{OUT} = 12.0 V

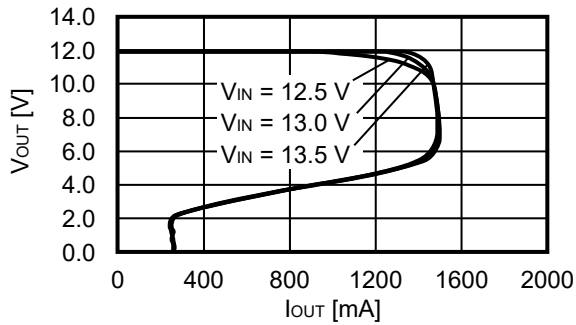

Remark In determining the output current, attention should be paid to the following.

1. The minimum output current value and footnote *4 of Table 9 and Table 10 in "■ Electrical Characteristics"
2. Power dissipation

2. Output voltage vs. Input voltage (Ta = +25°C)

2.1 V_{OUT} = 1.8 V

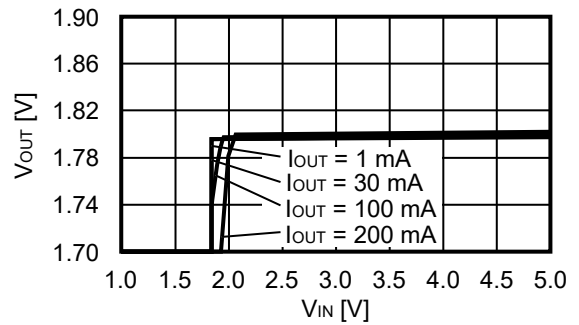
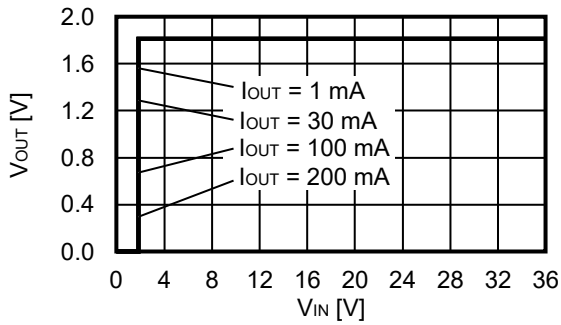

2.2 V_{OUT} = 5.0 V

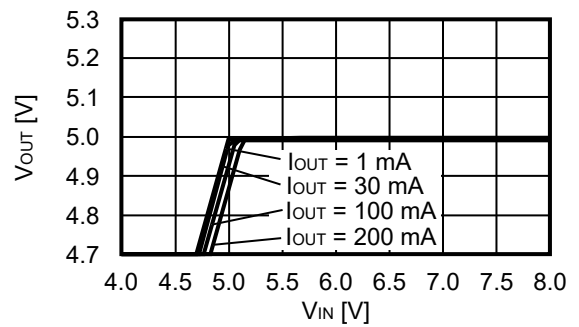
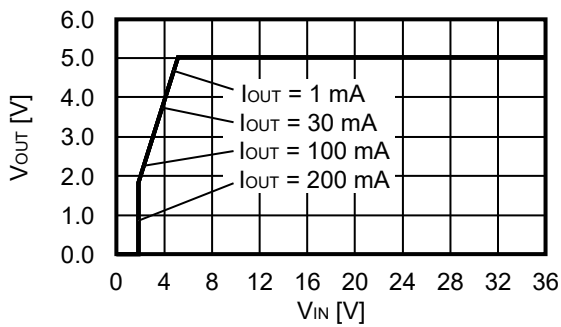

2.3 V_{OUT} = 12.0 V

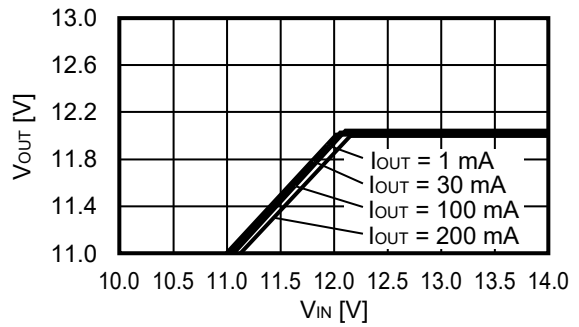
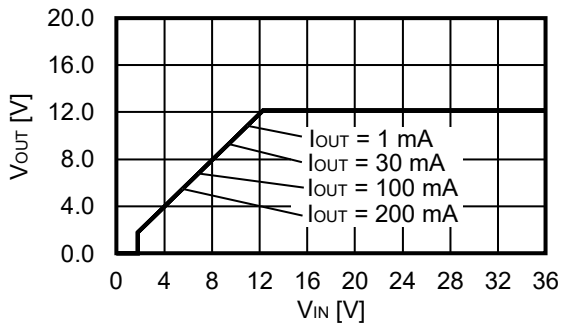

3. Dropout voltage vs. Output current

3.1 $V_{OUT} = 5.0\text{ V}$

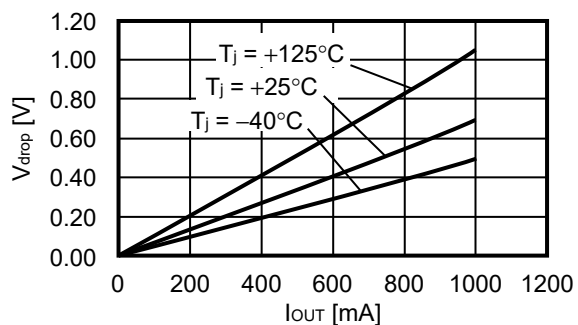

3.2 $V_{OUT} = 12.0\text{ V}$

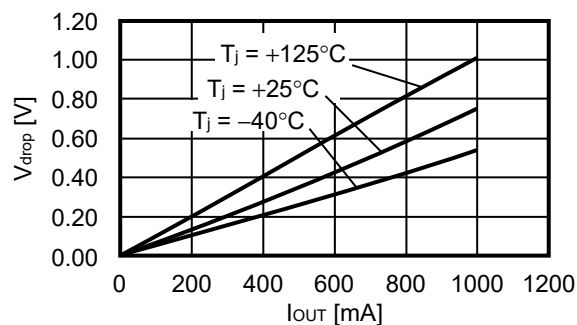

4. Dropout voltage vs. Junction temperature

4.1 $V_{OUT} = 5.0\text{ V}$

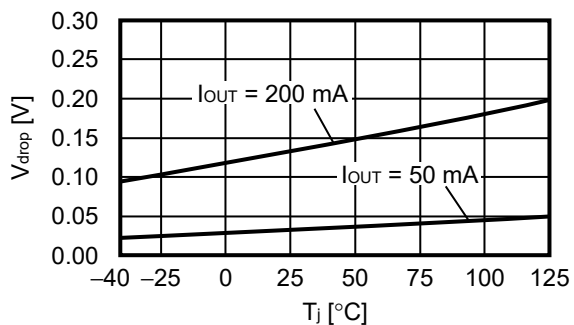

4.2 $V_{OUT} = 12.0\text{ V}$

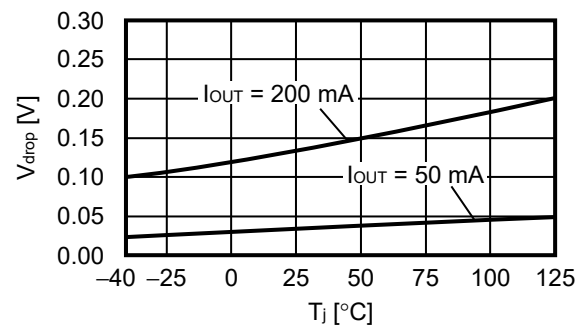

5. Dropout voltage vs. Set output voltage ($T_a = +25^\circ\text{C}$)

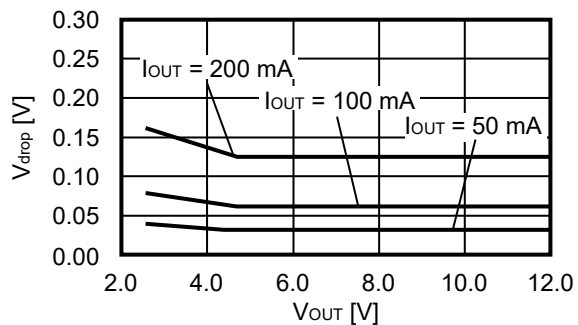

6. Output voltage vs. Junction temperature

6.1 $V_{OUT} = 1.8\text{ V}$

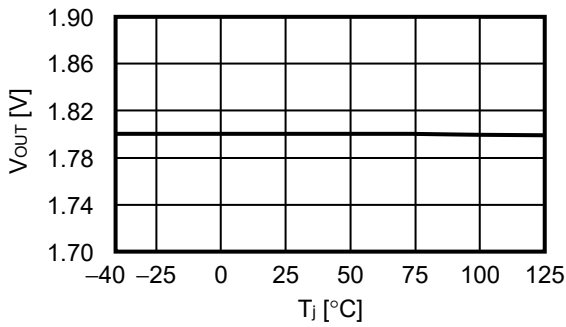

6.2 $V_{OUT} = 5.0\text{ V}$

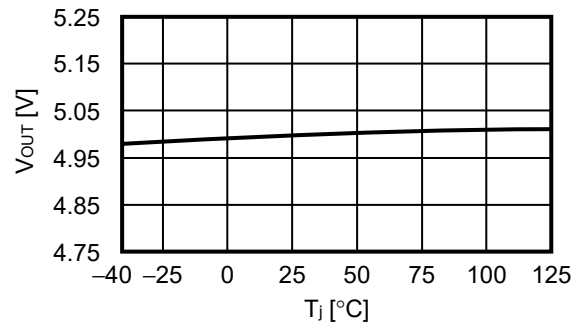

6.3 $V_{OUT} = 12.0\text{ V}$

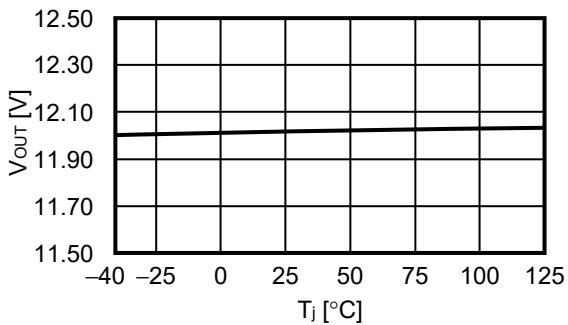

7. Current consumption during operation vs. Input voltage (When ON / OFF pin is ON, no load)

7.1 $V_{OUT} = 1.8\text{ V}$

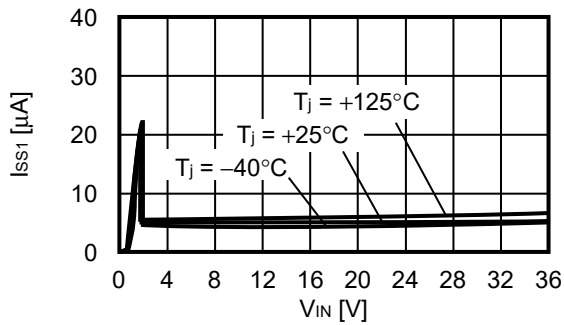

7.2 $V_{OUT} = 5.0\text{ V}$

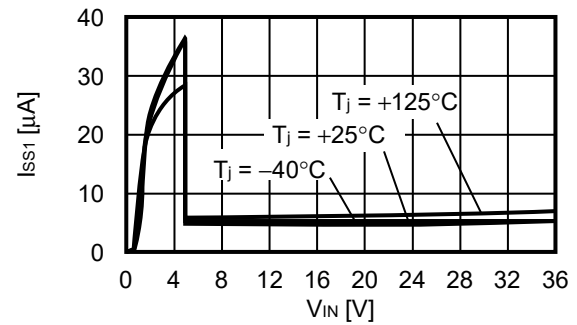

7.3 $V_{OUT} = 12.0\text{ V}$

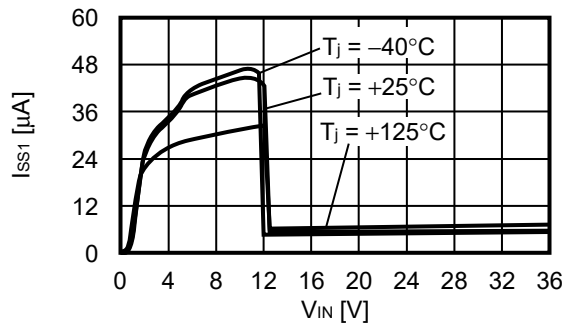

8. Current consumption during operation vs. Junction temperature

8.1 $V_{OUT} = 1.8\text{ V}$

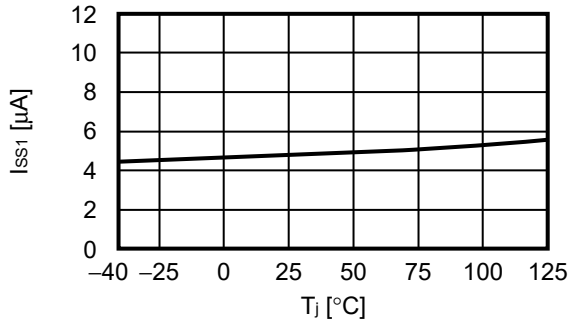

8.2 $V_{OUT} = 5.0\text{ V}$

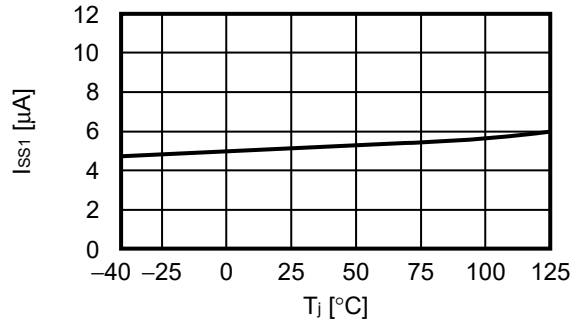

8.3 $V_{OUT} = 12.0\text{ V}$

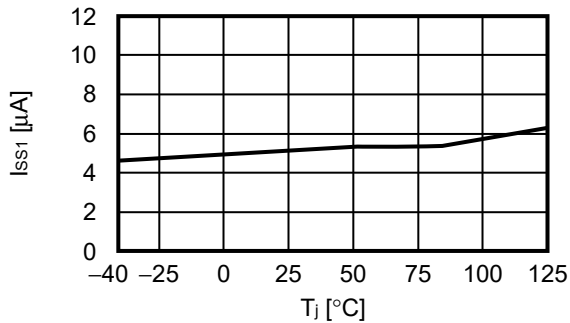

9. Current consumption during operation vs. Output current ($T_a = +25^\circ\text{C}$)

9.1 $V_{OUT} = 1.8\text{ V}$

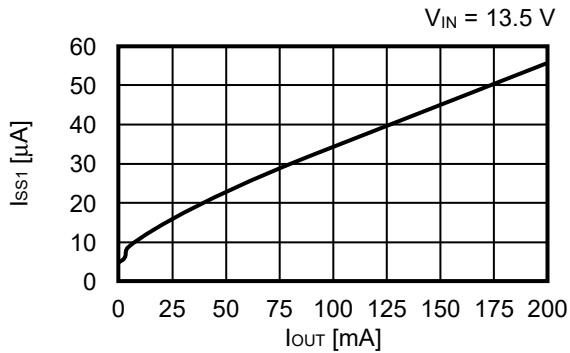

9.2 $V_{OUT} = 5.0\text{ V}$

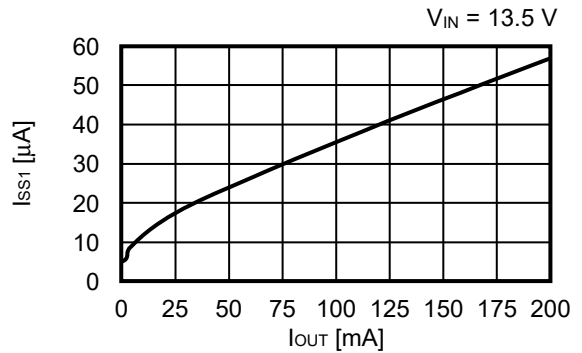

9.3 $V_{OUT} = 12.0\text{ V}$

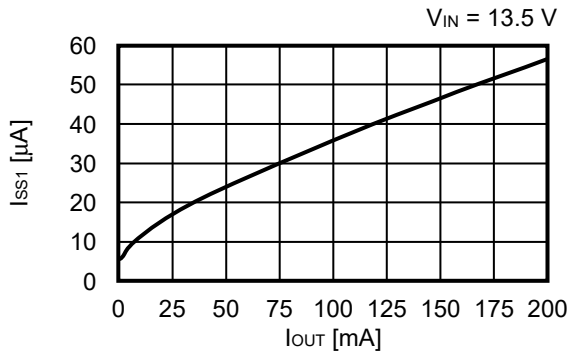

10. Input voltage vs. Output current (When load current increases) (Ta = +25°C)

10.1 V_{OUT} = 1.8 V

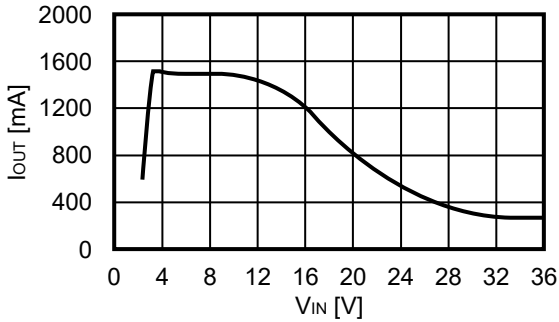

10.2 V_{OUT} = 5.0 V

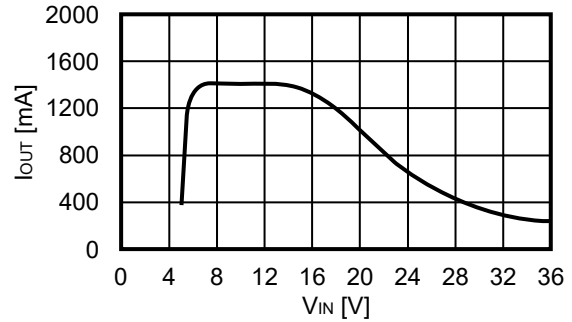

10.3 V_{OUT} = 12.0 V

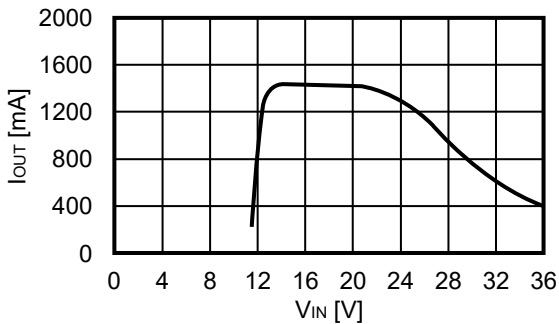

11. Ripple rejection (Ta = +25°C)

11.1 V_{OUT} = 1.8 V

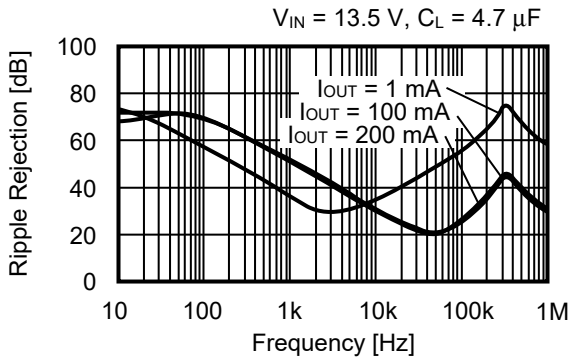

11.2 V_{OUT} = 5.0 V

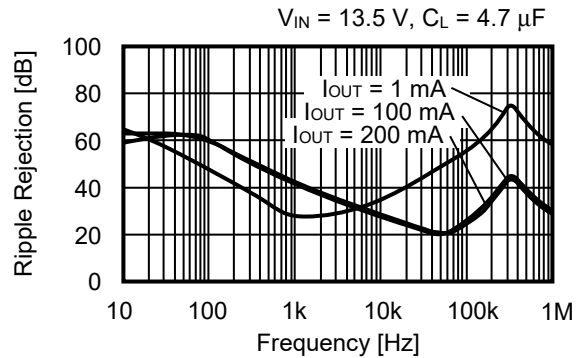

11.3 V_{OUT} = 12.0 V

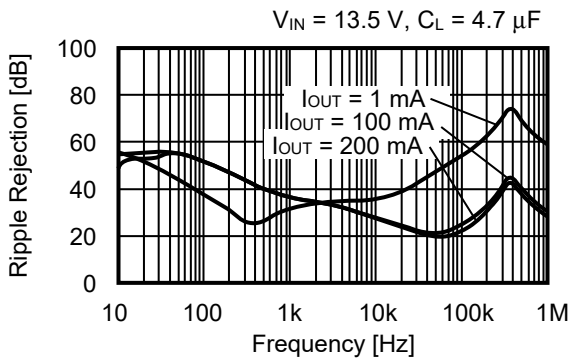

■ **Reference Data**

1. Characteristics of input transient response (Ta = +25°C)

1.1 V_{OUT} = 1.8 V

I_{OUT} = 100 mA, C_L = 4.7 μF, V_{IN} = 11.5 V ↔ 13.5 V, t_r = t_f = 5.0 μs

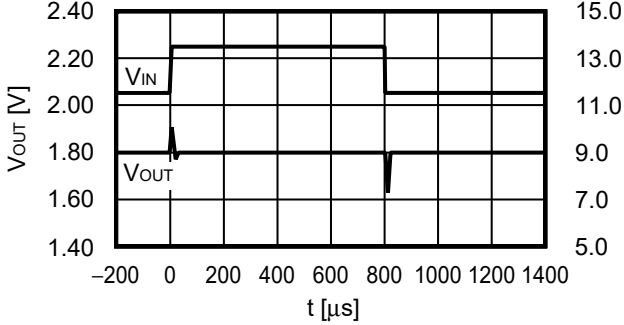

1.2 V_{OUT} = 5.0 V

I_{OUT} = 100 mA, C_L = 4.7 μF, V_{IN} = 11.5 V ↔ 13.5 V, t_r = t_f = 5.0 μs

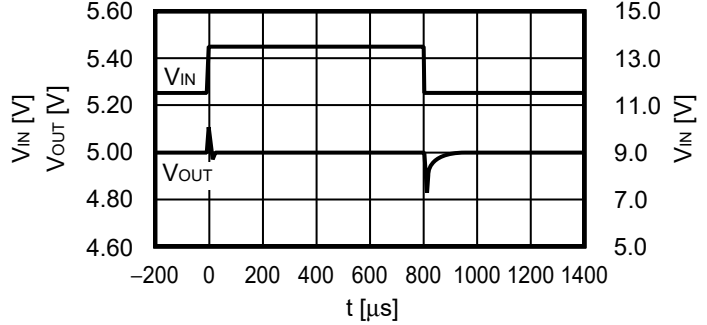

1.3 V_{OUT} = 12.0 V

I_{OUT} = 100 mA, C_L = 4.7 μF, V_{IN} = 13.5 V ↔ 15.5 V, t_r = t_f = 5.0 μs

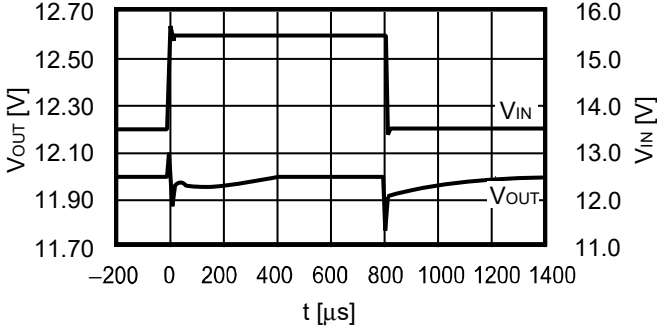

2. Characteristics of load transient response (Ta = +25°C)

2.1 V_{OUT} = 1.8 V

V_{IN} = 2.8 V, C_{IN} = C_L = 4.7 μF, I_{OUT} = 50 mA ↔ 100 mA

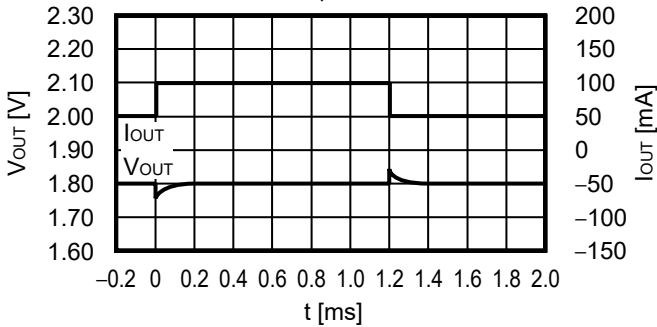

2.2 V_{OUT} = 5.0 V

V_{IN} = 6.0 V, C_{IN} = C_L = 4.7 μF, I_{OUT} = 50 mA ↔ 100 mA

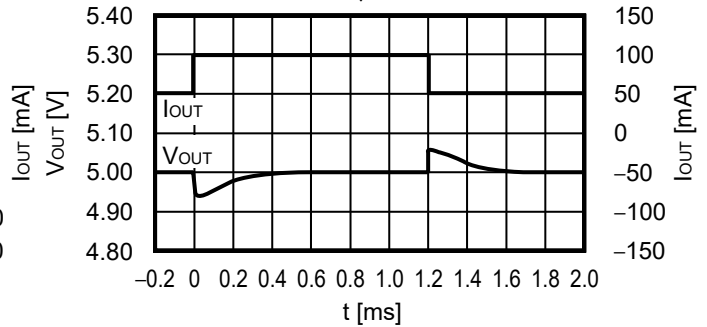

2.3 V_{OUT} = 12.0 V

V_{IN} = 13.5 V, C_{IN} = C_L = 4.7 μF, I_{OUT} = 50 mA ↔ 100 mA

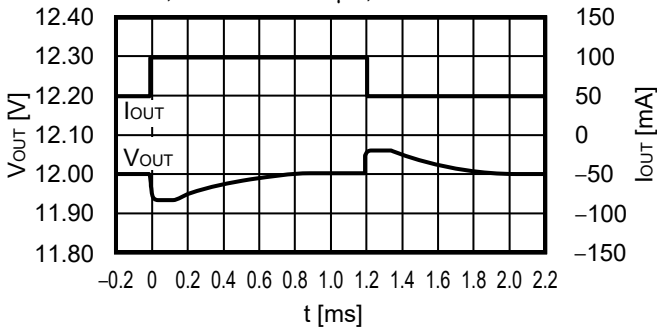

3. Transient response characteristics of ON / OFF pin ($T_a = +25^\circ\text{C}$)

3.1 $V_{OUT} = 1.8\text{ V}$

$V_{IN} = 13.5\text{ V}$, $C_{IN} = C_L = 4.7\ \mu\text{F}$,
 $I_{OUT} = 100\text{ mA}$, $V_{ON/OFF} = 0\text{ V} \rightarrow 13.5\text{ V}$

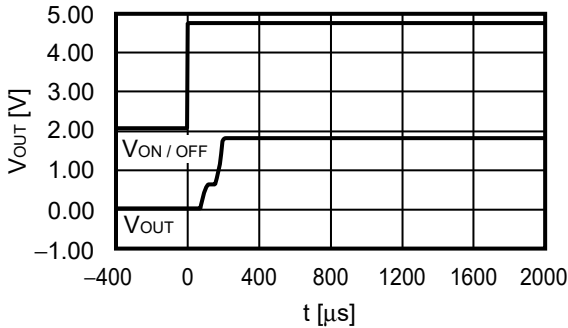

3.2 $V_{OUT} = 5.0\text{ V}$

$V_{IN} = 13.5\text{ V}$, $C_{IN} = C_L = 4.7\ \mu\text{F}$,
 $I_{OUT} = 100\text{ mA}$, $V_{ON/OFF} = 0\text{ V} \rightarrow 13.5\text{ V}$

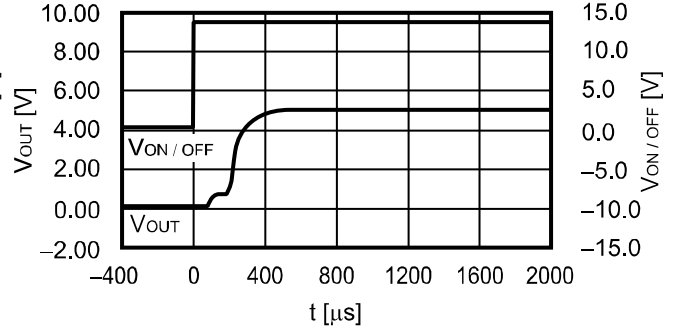

3.3 $V_{OUT} = 12.0\text{ V}$

$V_{IN} = 13.5\text{ V}$, $C_{IN} = C_L = 4.7\ \mu\text{F}$,
 $I_{OUT} = 100\text{ mA}$, $V_{ON/OFF} = 0\text{ V} \rightarrow 13.5\text{ V}$

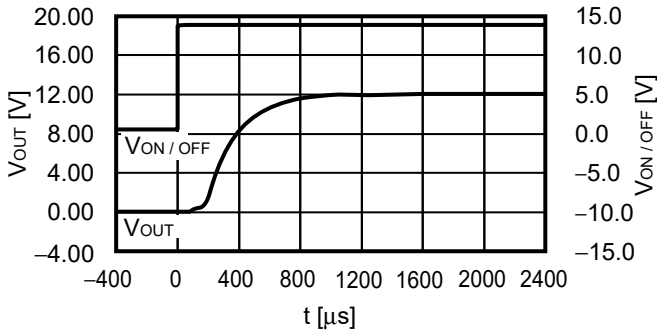

4. Inrush current characteristics ($T_a = +25^\circ\text{C}$)

4.1 $V_{OUT} = 1.8\text{ V}$

$V_{IN} = 13.5\text{ V}$, $I_{OUT} = 100\text{ mA}$, $C_L = 4.7\ \mu\text{F}$

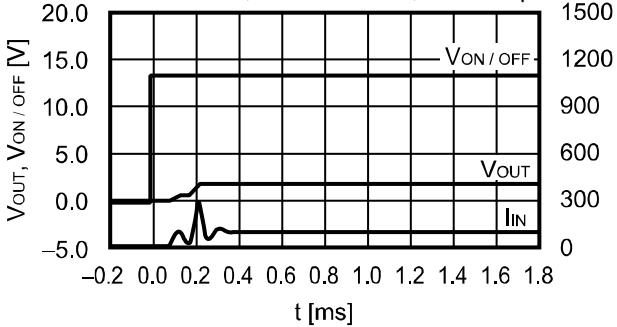

4.2 $V_{OUT} = 5.0\text{ V}$

$V_{IN} = 13.5\text{ V}$, $I_{OUT} = 100\text{ mA}$, $C_L = 4.7\ \mu\text{F}$

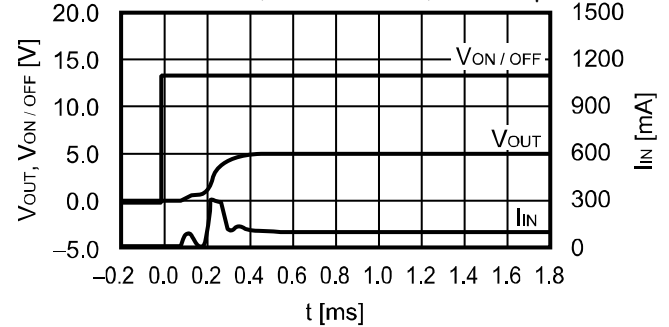

4.3 $V_{OUT} = 12.0\text{ V}$

$V_{IN} = 13.5\text{ V}$, $I_{OUT} = 100\text{ mA}$, $C_L = 4.7\ \mu\text{F}$

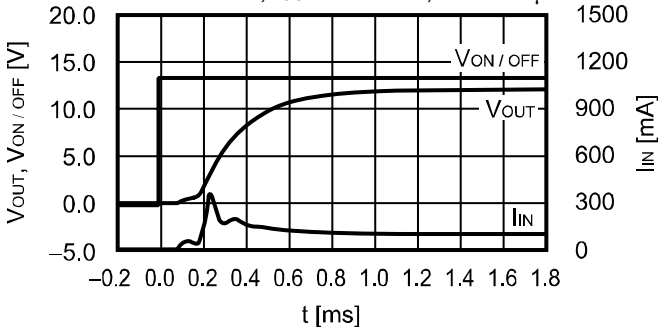

5. Load dump characteristics (Ta = +25°C)

5.1 V_{OUT} = 5.0 V

$I_{OUT} = 1 \text{ mA}$, $V_{IN} = 13.5 \text{ V} \leftrightarrow 45.0 \text{ V}$, $C_{IN} = C_L = 1.0 \mu\text{F}$

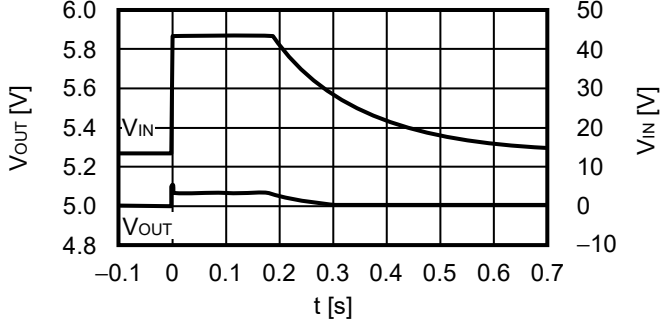

6. Example of equivalent series resistance vs. Output current characteristics (Ta = +25°C)

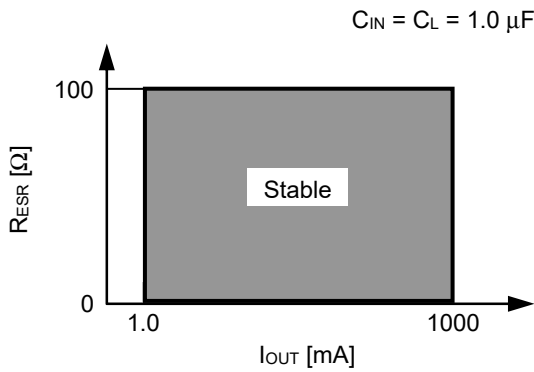
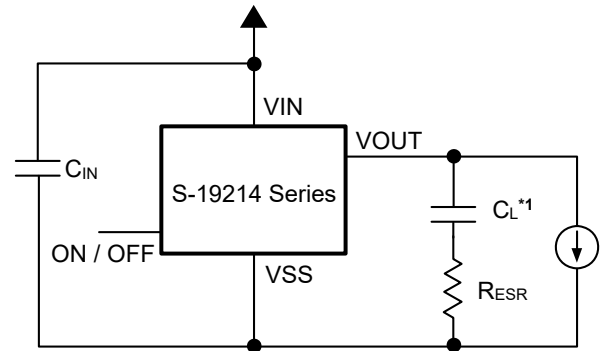

Figure 24



*1. CL: TDK Corporation CGA5L2X7R2A105K (1.0 μF)

Figure 25

■ **Power Dissipation**

TO-252-5S(A)

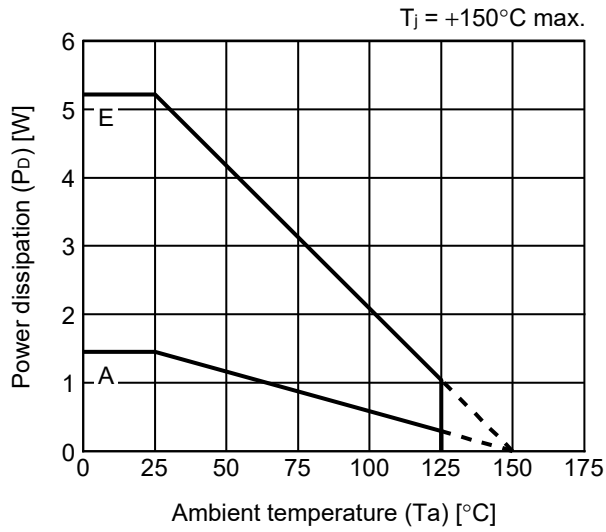

Board	Power Dissipation (P_D)*1
A	1.45 W
B	-
C	-
D	-
E	5.21 W

HSOP-8A

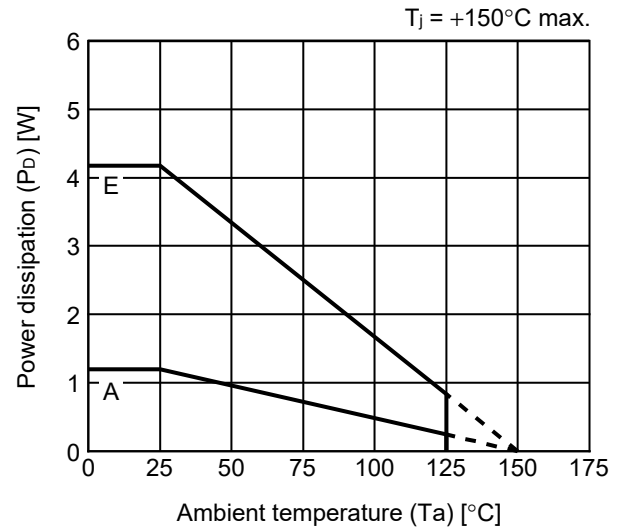

Board	Power Dissipation (P_D)*1
A	1.20 W
B	-
C	-
D	-
E	4.17 W

*1. Measurement values when this IC is mounted on each board

TO-252-5S Test Board

(1) Board A

 IC Mount Area

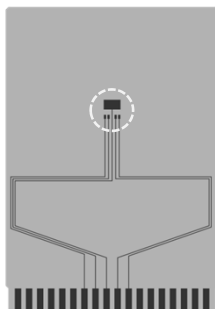

Item	Specification	
Size [mm]	114.3 x 76.2 x t1.6	
Material	FR-4	
Number of copper foil layer	2	
Copper foil layer [mm]	1	Land pattern and wiring for testing: t0.070
	2	-
	3	-
	4	74.2 x 74.2 x t0.070
Thermal via	-	

(2) Board B

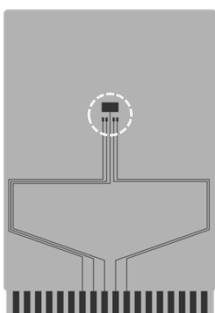

Item	Specification	
Size [mm]	114.3 x 76.2 x t1.6	
Material	FR-4	
Number of copper foil layer	4	
Copper foil layer [mm]	1	Land pattern and wiring for testing: t0.070
	2	74.2 x 74.2 x t0.035
	3	74.2 x 74.2 x t0.035
	4	74.2 x 74.2 x t0.070
Thermal via	-	

(3) Board C

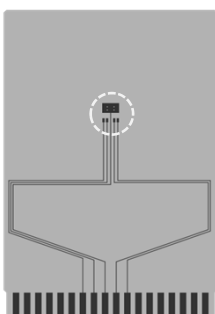

Item	Specification	
Size [mm]	114.3 x 76.2 x t1.6	
Material	FR-4	
Number of copper foil layer	4	
Copper foil layer [mm]	1	Land pattern and wiring for testing: t0.070
	2	74.2 x 74.2 x t0.035
	3	74.2 x 74.2 x t0.035
	4	74.2 x 74.2 x t0.070
Thermal via	Number: 4 Diameter: 0.3 mm	

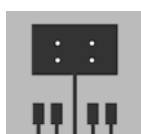

enlarged view

No. TO252-5S-A-Board-SD-1.0

TO-252-5S Test Board

(4) Board D

 IC Mount Area

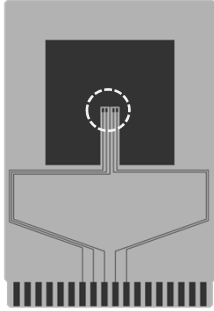

Item		Specification
Size [mm]		114.3 x 76.2 x t1.6
Material		FR-4
Number of copper foil layer		4
Copper foil layer [mm]	1	Pattern for heat radiation: 2000mm ² t0.070
	2	74.2 x 74.2 x t0.035
	3	74.2 x 74.2 x t0.035
	4	74.2 x 74.2 x t0.070
Thermal via		-

(5) Board E

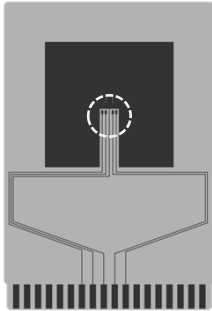

Item		Specification
Size [mm]		114.3 x 76.2 x t1.6
Material		FR-4
Number of copper foil layer		4
Copper foil layer [mm]	1	Pattern for heat radiation: 2000mm ² t0.070
	2	74.2 x 74.2 x t0.035
	3	74.2 x 74.2 x t0.035
	4	74.2 x 74.2 x t0.070
Thermal via		Number: 4 Diameter: 0.3 mm



enlarged view

No. TO252-5S-A-Board-SD-1.0

HSOP-8A Test Board

(1) Board A

 IC Mount Area

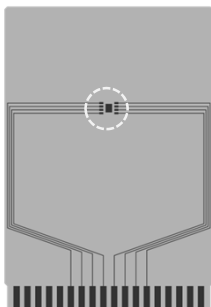

Item	Specification	
Size [mm]	114.3 x 76.2 x t1.6	
Material	FR-4	
Number of copper foil layer	2	
Copper foil layer [mm]	1	Land pattern and wiring for testing: t0.070
	2	-
	3	-
	4	74.2 x 74.2 x t0.070
Thermal via	-	

(2) Board B

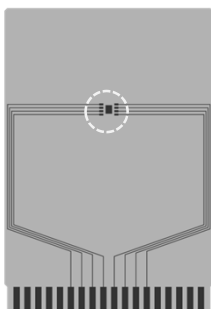

Item	Specification	
Size [mm]	114.3 x 76.2 x t1.6	
Material	FR-4	
Number of copper foil layer	4	
Copper foil layer [mm]	1	Land pattern and wiring for testing: t0.070
	2	74.2 x 74.2 x t0.035
	3	74.2 x 74.2 x t0.035
	4	74.2 x 74.2 x t0.070
Thermal via	-	

(3) Board C

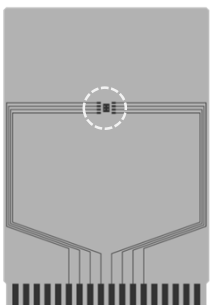

Item	Specification	
Size [mm]	114.3 x 76.2 x t1.6	
Material	FR-4	
Number of copper foil layer	4	
Copper foil layer [mm]	1	Land pattern and wiring for testing: t0.070
	2	74.2 x 74.2 x t0.035
	3	74.2 x 74.2 x t0.035
	4	74.2 x 74.2 x t0.070
Thermal via	Number: 4 Diameter: 0.3 mm	

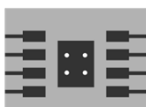

enlarged view

No. HSOP8A-A-Board-SD-1.0

HSOP-8A Test Board

(4) Board D

○ IC Mount Area

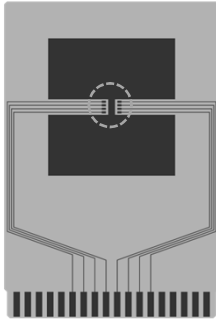

Item		Specification
Size [mm]		114.3 x 76.2 x t1.6
Material		FR-4
Number of copper foil layer		4
Copper foil layer [mm]	1	Pattern for heat radiation: 2000mm ² t0.070
	2	74.2 x 74.2 x t0.035
	3	74.2 x 74.2 x t0.035
	4	74.2 x 74.2 x t0.070
Thermal via		-

(5) Board E

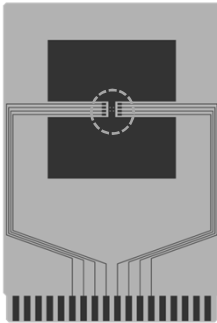

Item		Specification
Size [mm]		114.3 x 76.2 x t1.6
Material		FR-4
Number of copper foil layer		4
Copper foil layer [mm]	1	Pattern for heat radiation: 2000mm ² t0.070
	2	74.2 x 74.2 x t0.035
	3	74.2 x 74.2 x t0.035
	4	74.2 x 74.2 x t0.070
Thermal via		Number: 4 Diameter: 0.3 mm



enlarged view

No. HSOP8A-A-Board-SD-1.0

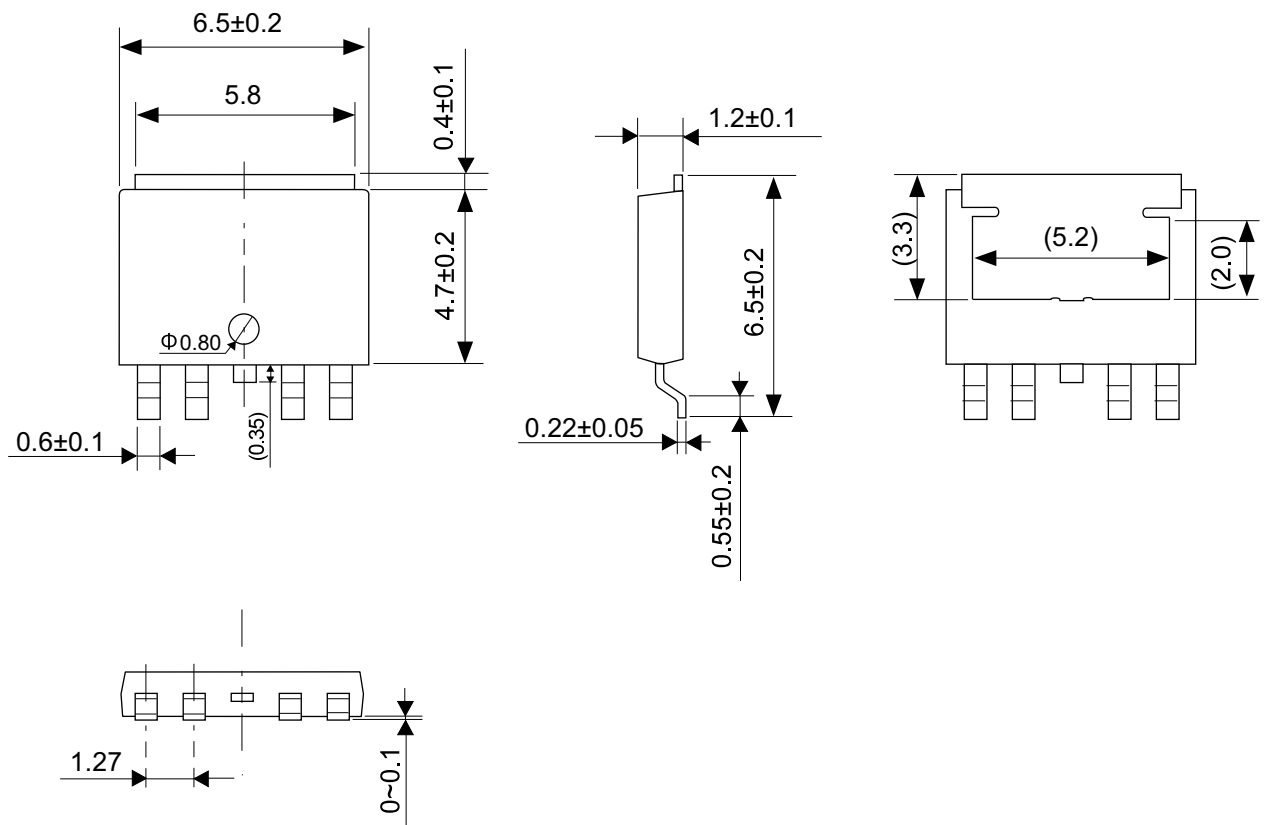

No. VA005-A-P-SD-2.0

TITLE	TO-252-5S-A-PKG Dimensions
No.	VA005-A-P-SD-2.0
ANGLE	
UNIT	mm
ABLIC Inc.	

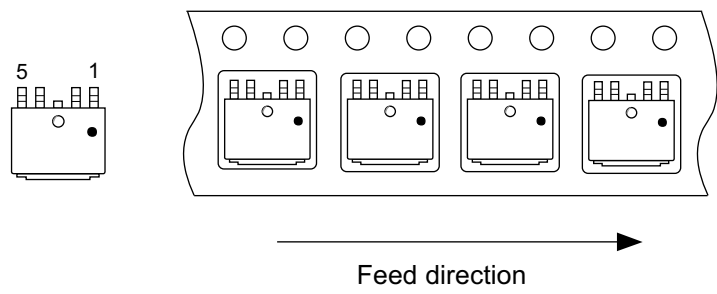
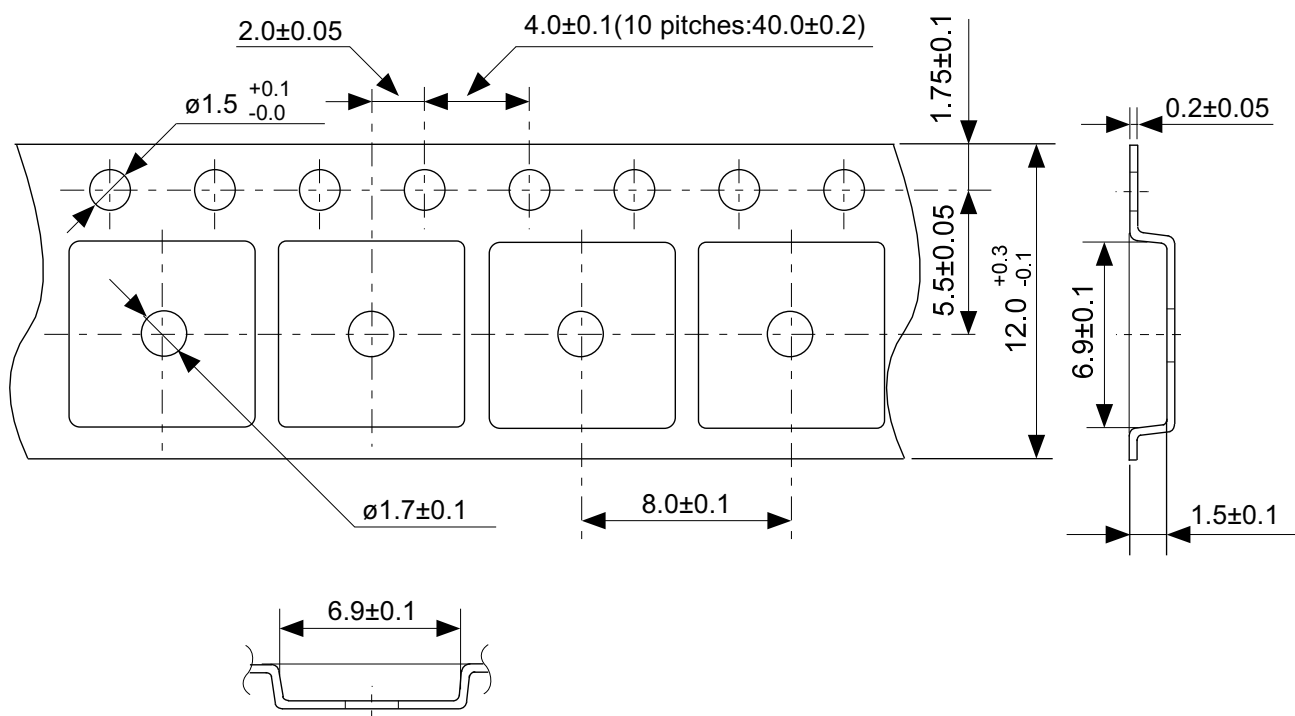

No. VA005-A-C-SD-1.0

TITLE	TO-252-5S-A-Carrier Tape
No.	VA005-A-C-SD-1.0
ANGLE	
UNIT	mm
ABLIC Inc.	

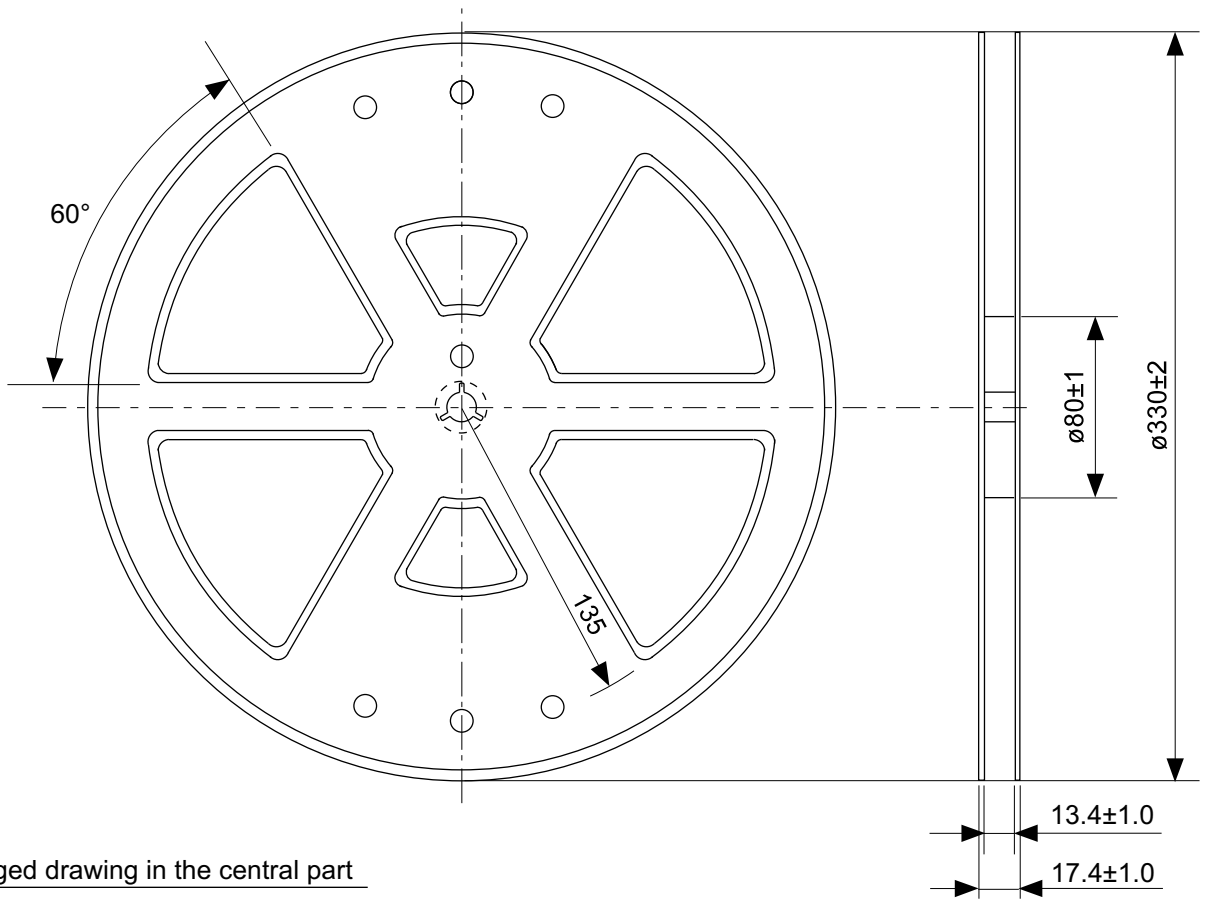

Enlarged drawing in the central part

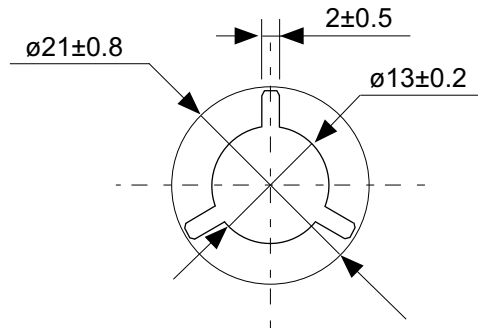

No. VA005-A-R-SD-1.0

TITLE	TO-252-5S-A-Reel		
No.	VA005-A-R-SD-1.0		
ANGLE		QTY.	4,000
UNIT	mm		
ABLIC Inc.			

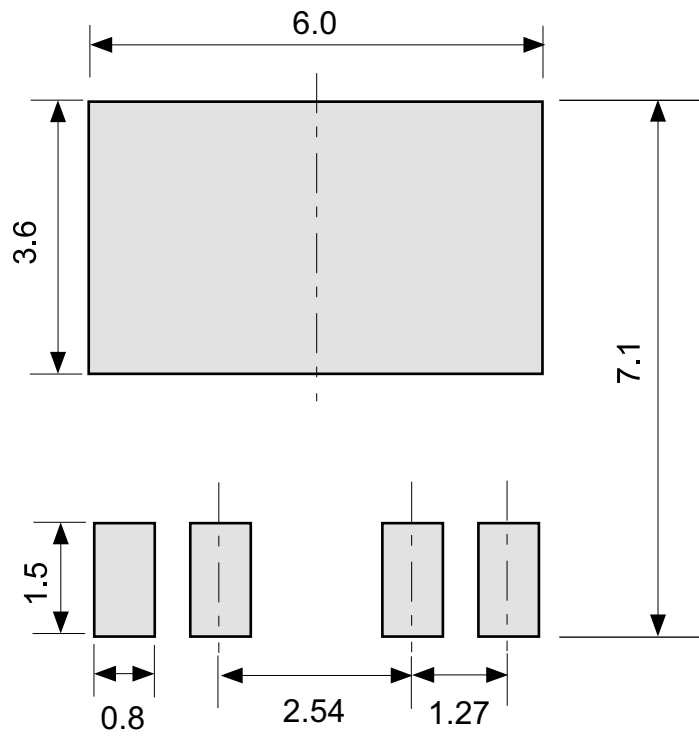

No. VA005-A-L-SD-1.0

TITLE	TO-252-5S-A -Land Recommendation
No.	VA005-A-L-SD-1.0
ANGLE	
UNIT	mm
ABLIC Inc.	

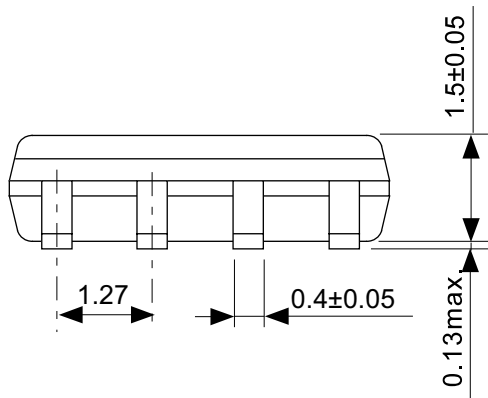
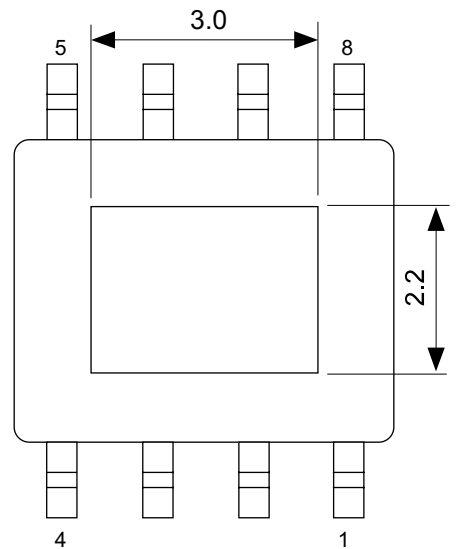
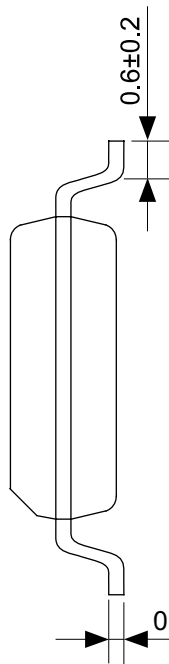
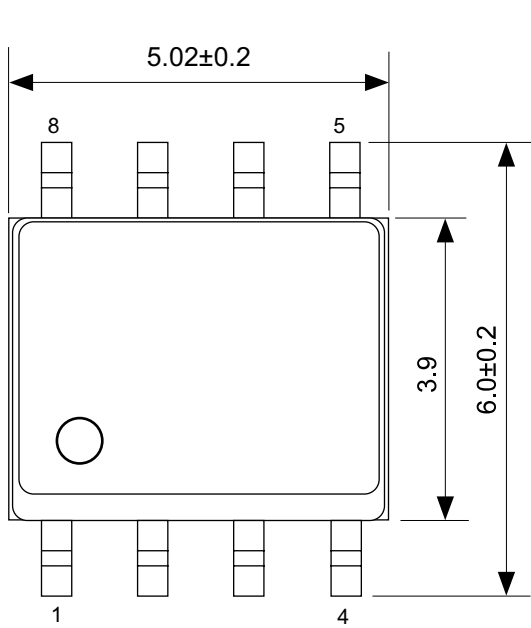

No. FH008-A-P-SD-2.0

TITLE	HSOP8A-A-PKG Dimensions
No.	FH008-A-P-SD-2.0
ANGLE	
UNIT	mm
ABLIC Inc.	

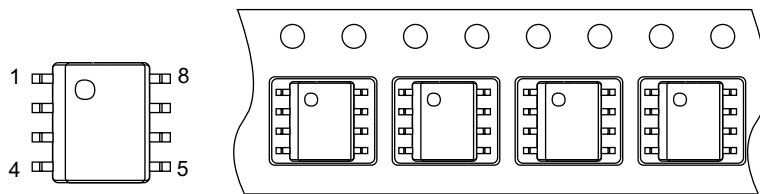
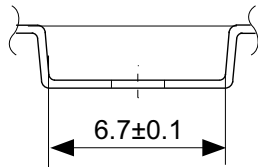
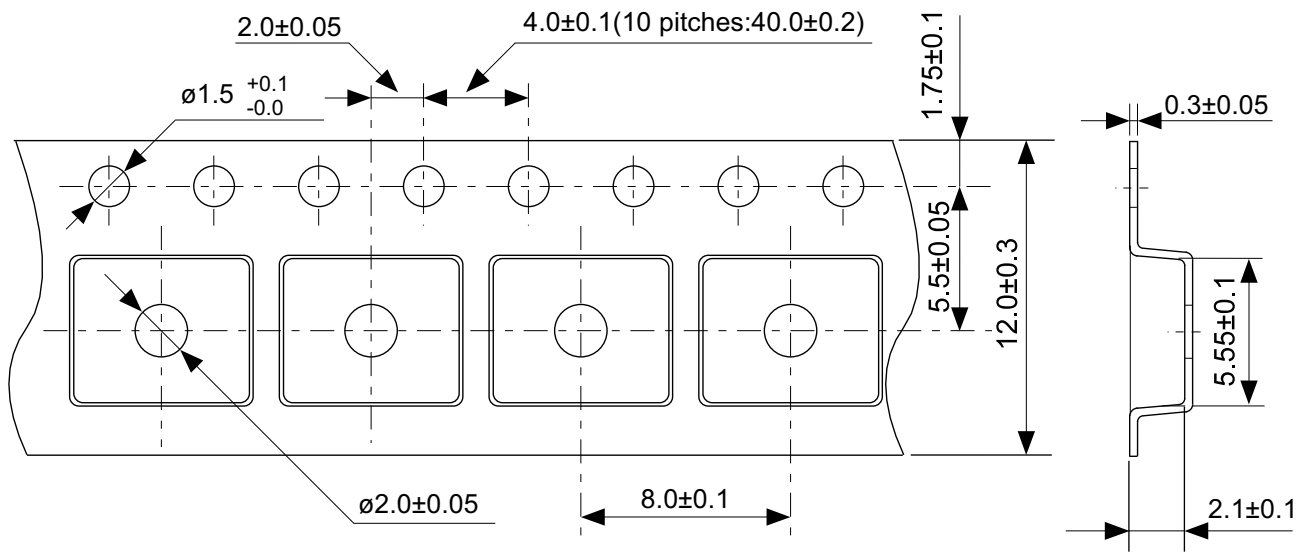

→
Feed direction

No. FH008-A-C-SD-1.0

TITLE	HSOP8A-A-Carrier Tape
No.	FH008-A-C-SD-1.0
ANGLE	
UNIT	mm
ABLIC Inc.	

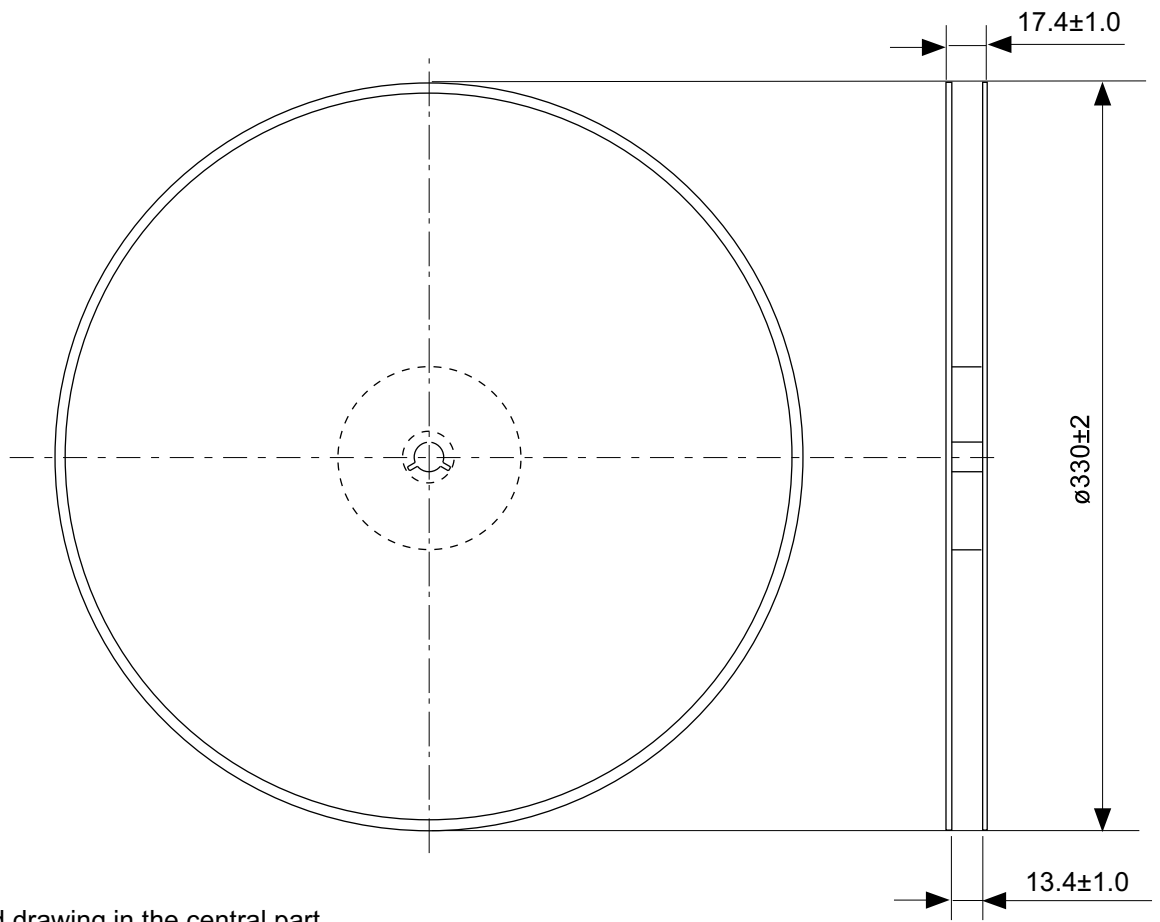

Enlarged drawing in the central part

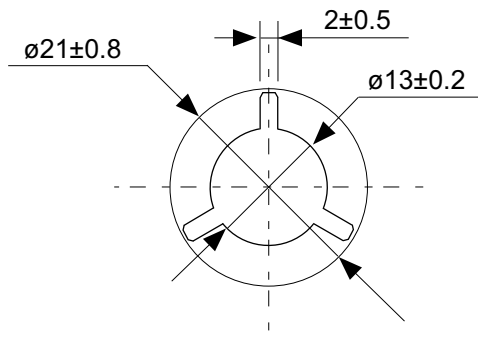

No. FH008-A-R-SD-1.0

TITLE	HSOP8A-A-Reel		
No.	FH008-A-R-SD-1.0		
ANGLE		QTY.	4,000
UNIT	mm		

ABLIC Inc.

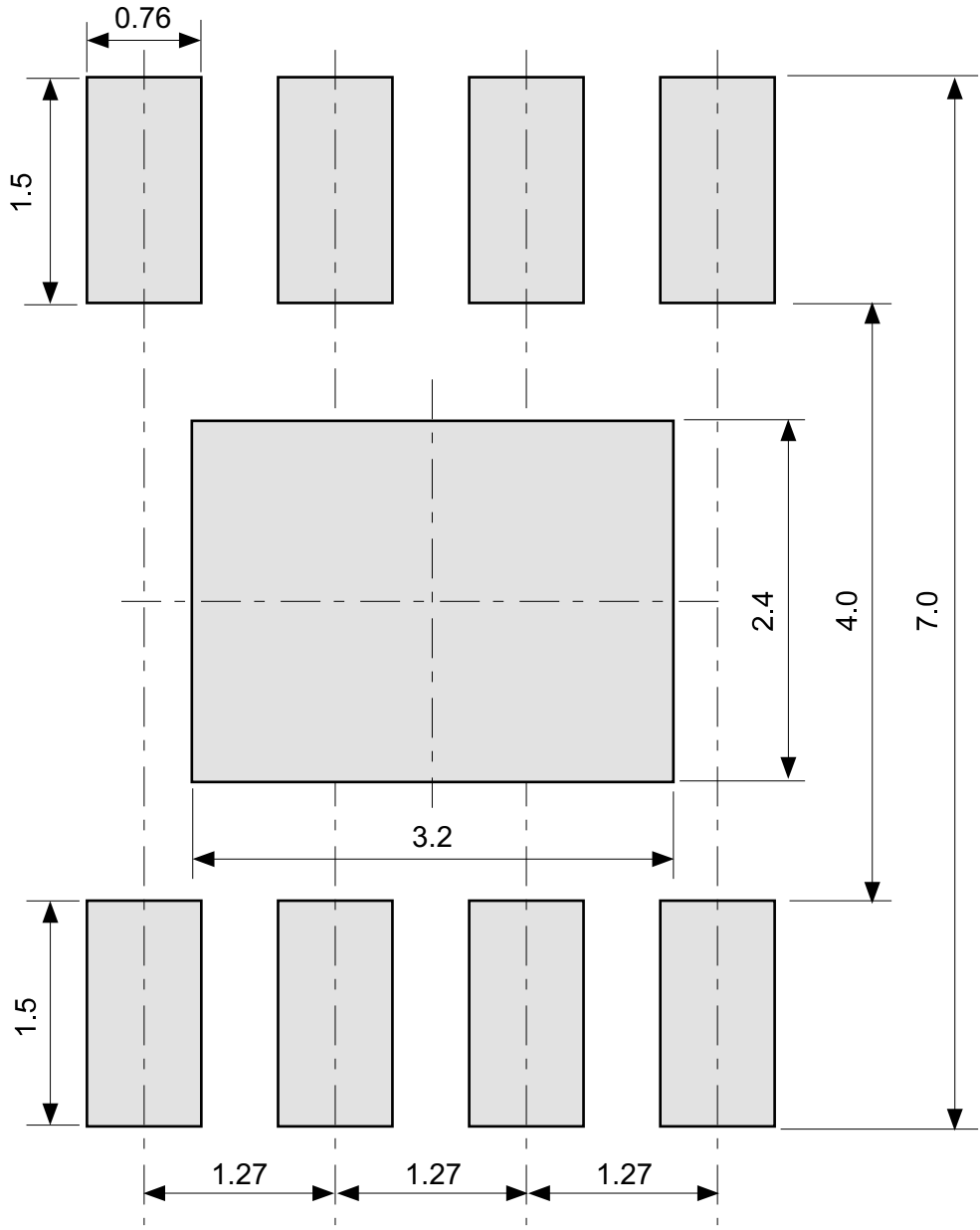

No. FH008-A-L-SD-1.0

TITLE	HSOP8A-A -Land Recommendation
No.	FH008-A-L-SD-1.0
ANGLE	
UNIT	mm
ABLIC Inc.	

Disclaimers (Handling Precautions)

1. All the information described herein (product data, specifications, figures, tables, programs, algorithms and application circuit examples, etc.) is current as of publishing date of this document and is subject to change without notice.
2. The circuit examples and the usages described herein are for reference only, and do not guarantee the success of any specific mass-production design.
ABLIC Inc. is not liable for any losses, damages, claims or demands caused by the reasons other than the products described herein (hereinafter "the products") or infringement of third-party intellectual property right and any other right due to the use of the information described herein.
3. ABLIC Inc. is not liable for any losses, damages, claims or demands caused by the incorrect information described herein.
4. Be careful to use the products within their ranges described herein. Pay special attention for use to the absolute maximum ratings, operation voltage range and electrical characteristics, etc.
ABLIC Inc. is not liable for any losses, damages, claims or demands caused by failures and / or accidents, etc. due to the use of the products outside their specified ranges.
5. Before using the products, confirm their applications, and the laws and regulations of the region or country where they are used and verify suitability, safety and other factors for the intended use.
6. When exporting the products, comply with the Foreign Exchange and Foreign Trade Act and all other export-related laws, and follow the required procedures.
7. The products are strictly prohibited from using, providing or exporting for the purposes of the development of weapons of mass destruction or military use. ABLIC Inc. is not liable for any losses, damages, claims or demands caused by any provision or export to the person or entity who intends to develop, manufacture, use or store nuclear, biological or chemical weapons or missiles, or use any other military purposes.
8. The products are not designed to be used as part of any device or equipment that may affect the human body, human life, or assets (such as medical equipment, disaster prevention systems, security systems, combustion control systems, infrastructure control systems, vehicle equipment, traffic systems, in-vehicle equipment, aviation equipment, aerospace equipment, and nuclear-related equipment), excluding when specified for in-vehicle use or other uses by ABLIC, Inc. Do not apply the products to the above listed devices and equipments.
ABLIC Inc. is not liable for any losses, damages, claims or demands caused by unauthorized or unspecified use of the products.
9. In general, semiconductor products may fail or malfunction with some probability. The user of the products should therefore take responsibility to give thorough consideration to safety design including redundancy, fire spread prevention measures, and malfunction prevention to prevent accidents causing injury or death, fires and social damage, etc. that may ensue from the products' failure or malfunction.
The entire system in which the products are used must be sufficiently evaluated and judged whether the products are allowed to apply for the system on customer's own responsibility.
10. The products are not designed to be radiation-proof. The necessary radiation measures should be taken in the product design by the customer depending on the intended use.
11. The products do not affect human health under normal use. However, they contain chemical substances and heavy metals and should therefore not be put in the mouth. The fracture surfaces of wafers and chips may be sharp. Be careful when handling these with the bare hands to prevent injuries, etc.
12. When disposing of the products, comply with the laws and ordinances of the country or region where they are used.
13. The information described herein contains copyright information and know-how of ABLIC Inc. The information described herein does not convey any license under any intellectual property rights or any other rights belonging to ABLIC Inc. or a third party. Reproduction or copying of the information from this document or any part of this document described herein for the purpose of disclosing it to a third-party is strictly prohibited without the express permission of ABLIC Inc.
14. For more details on the information described herein or any other questions, please contact ABLIC Inc.'s sales representative.
15. This Disclaimers have been delivered in a text using the Japanese language, which text, despite any translations into the English language and the Chinese language, shall be controlling.

2.4-2019.07

X-ON Electronics

Largest Supplier of Electrical and Electronic Components

Click to view similar products for [LDO Voltage Regulators](#) category:

Click to view products by [ABLIC](#) manufacturer:

Other Similar products are found below :

[AP7363-SP-13](#) [L79M05TL-E](#) [PT7M8202B12TA5EX](#) [TCR3DF185,LM\(CT](#) [TCR3DF24,LM\(CT](#) [TCR3DF285,LM\(CT](#) [TCR3DF31,LM\(CT](#)
[TCR3DF45,LM\(CT](#) [MP2013GQ-33-Z](#) [059985X](#) [NCP4687DH15T1G](#) [701326R](#) [TCR2EN28,LF\(S](#) [NCV8170AXV250T2G](#)
[TCR3DF27,LM\(CT](#) [TCR3DF19,LM\(CT](#) [TCR3DF125,LM\(CT](#) [TCR2EN18,LF\(S](#) [AP2112R5A-3.3TRG1](#) [AP7315-25W5-7](#)
[IFX30081LDVGRNXUMA1](#) [NCV47411PAAJR2G](#) [AP2113KTR-G1](#) [AP2111H-1.2TRG1](#) [ZLDO1117QK50TC](#) [AZ1117IH-1.8TRG1](#)
[AZ1117ID-ADJTRG1](#) [TCR3DG12,LF](#) [MIC5514-3.3YMT-T5](#) [MIC5512-1.2YMT-T5](#) [MIC5317-2.8YM5-T5](#) [SCD7912BTG](#)
[NCP154MX180270TAG](#) [SCD33269T-5.0G](#) [NCV8170BMX330TCG](#) [NCV8170AMX120TCG](#) [NCP706ABMX300TAG](#)
[NCP153MX330180TCG](#) [NCP114BMX075TCG](#) [MC33269T-3.5G](#) [CAT6243-ADJCMT5T](#) [TCR3DG33,LF](#) [AP2127N-1.0TRG1](#)
[TCR4DG35,LF](#) [LT1117CST-3.3](#) [LT1117CST-5](#) [TAR5S15U\(TE85L,F\)](#) [TAR5S18U\(TE85L,F\)](#) [TCR3UG19A,LF](#) [TCR4DG105,LF](#)