

# IoT OPTIMIZED LOW PROFILE QUARTZ CRYSTAL

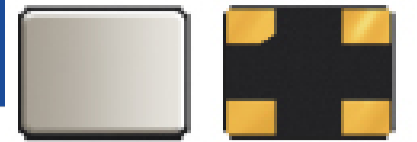

ABM11W SERIES

2.0 x 1.6 x 0.5mm



RoHS/RoHS II Compliant

MSL = N/A: NOT APPLICABLE

## FEATURES

- Optimized for energy saving wearables, and IoT applications
- Plated at exceptionally low plating capacitance, as low as 4pF, with optimized ESR
- 0.5 mm max height ideally suited for height constrained designs
- Seam sealed for longterm reliability

## APPLICATIONS

- Wearables
- Internet of Things (IoT)
- Bluetooth/Bluetooth Low Energy (BLE)
- Wireless modules
- Machine-to-machine (M2M) connectivity
- Ultra-low power MCU
- Near Field Communication (NFC)
- ISM Band

## STANDARD SPECIFICATIONS

Parameters	Minimum	Typical	Maximum	Units	Notes
Frequency Range	16.0000		50.0000	MHz	
Operation Mode	Fundamental				
Operating Temperature Range	-40		+125	°C	See options
Storage Temperature	-55		+125	°C	
Frequency Tolerance @ +25°C	-10		+10	ppm	See options
Frequency Stability over the Operating Temperature ( ref. to +25°C)	-10		+10	ppm	See options
Equivalent series resistance "R1" (over Operating Temperature Range) (CL=4pF)		< 150	200	Ω	16.0000 – 17.9999MHz
		< 80	120		18.0000 – 20.9999MHz
		< 60	100		21.0000 – 29.9999MHz
		< 50	80		30.0000 – 37.9999MHz
		< 30	60		38.0000 – 50.0000MHz
Equivalent series resistance "R1" (over Operating Temperature Range) (CL=6pF, 7pF, 8pF)		< 120	150	Ω	16.0000 – 17.9999MHz
		< 80	120		18.0000 – 20.9999MHz
		< 60	100		21.0000 – 23.9999MHz
		< 30	50		24.0000 – 29.9999MHz
		< 30	50		30.0000 – 37.9999MHz
		< 30	40		38.0000 – 50.0000MHz
Shunt capacitance (C0)		< 1.0	2.0	pF	
Load capacitance (CL)		4.0		pF	See options
Drive Level		10	100	μW	
Aging (1 year)	-2		+2	ppm	@ 25°C±3°C
Insulation Resistance	500			MΩ	@ 100Vdc ± 15V



5101 Hidden Creek Ln Spicewood TX 78669  
 Phone: 512-371-6159 | Fax: 512-351-8858  
 For terms and conditions of sales, please visit:  
[www.abracon.com](http://www.abracon.com)

REVISED: 10.06.2020

ABRACON IS  
 ISO9001-2015  
 CERTIFIED

# IoT OPTIMIZED LOW PROFILE QUARTZ CRYSTAL

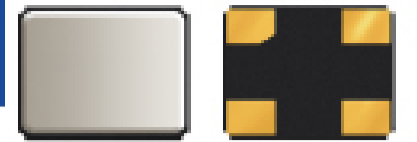

ABM11W SERIES

2.0 x 1.6 x 0.5mm



RoHS/RoHS II Compliant

MSL = N/A: NOT APPLICABLE

## OPTIONS AND PART IDENTIFICATION (NOTE 1)

Note 1: Contact Abracon for part number requests with carrier frequency callouts up to 5 & 6 digit accuracy after the decimal.

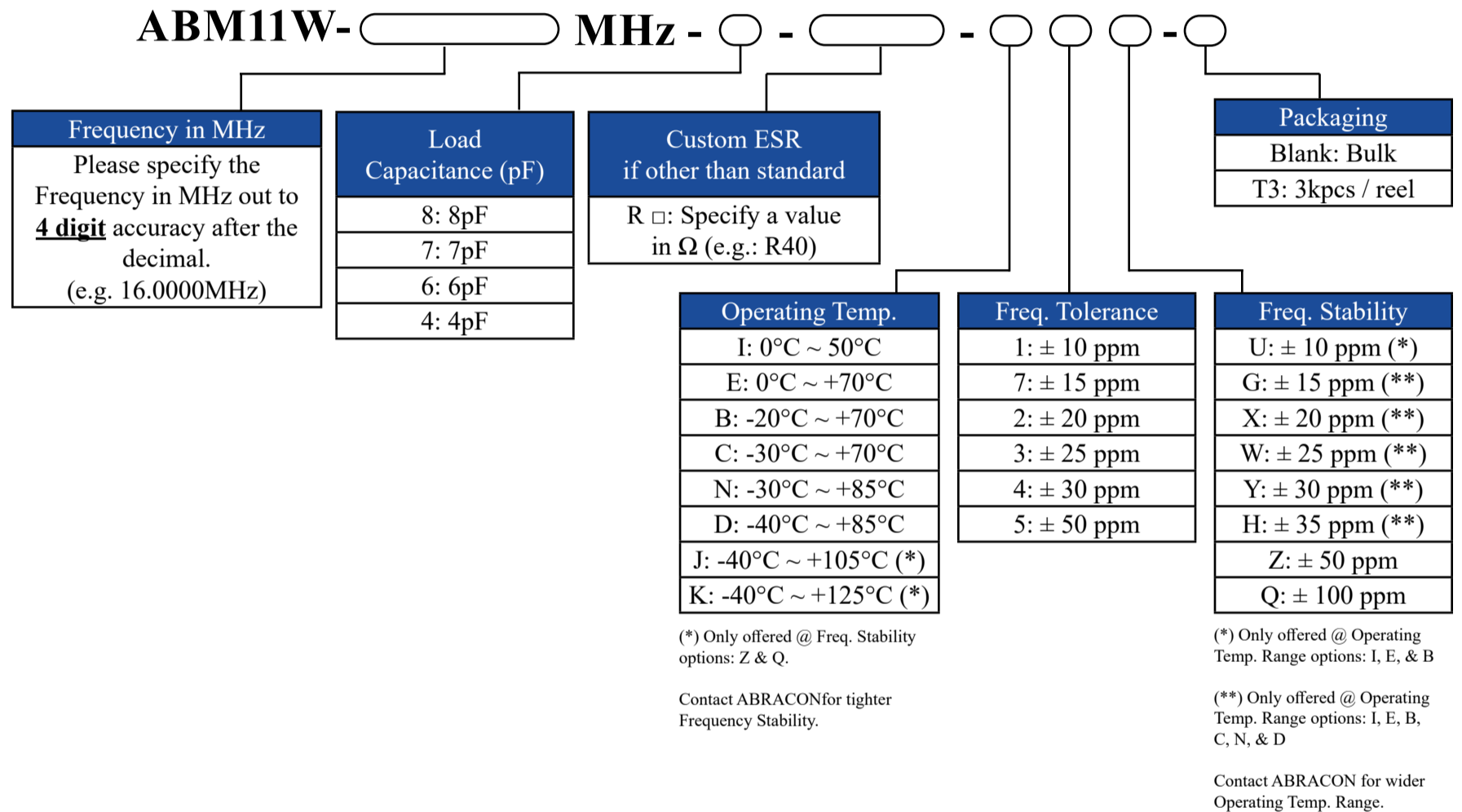

# IoT OPTIMIZED LOW PROFILE QUARTZ CRYSTAL

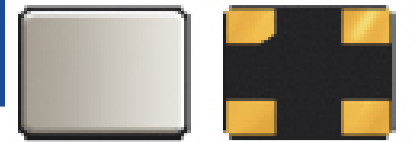

ABM11W SERIES

2.0 x 1.6 x 0.5mm



RoHS/RoHS II Compliant

MSL = N/A: NOT APPLICABLE

## TYPICAL FREQUENCY Vs. TEMPERATURE CHARACTERISTICS

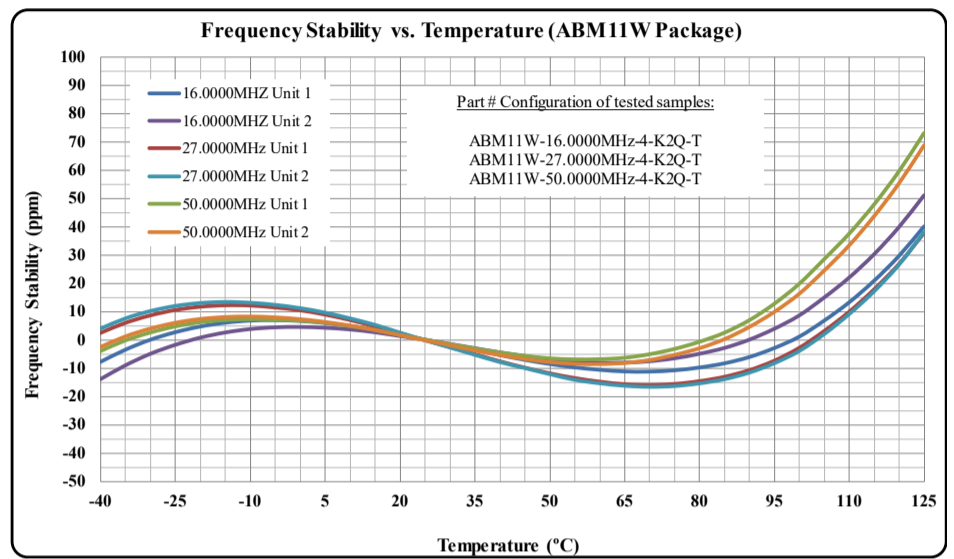
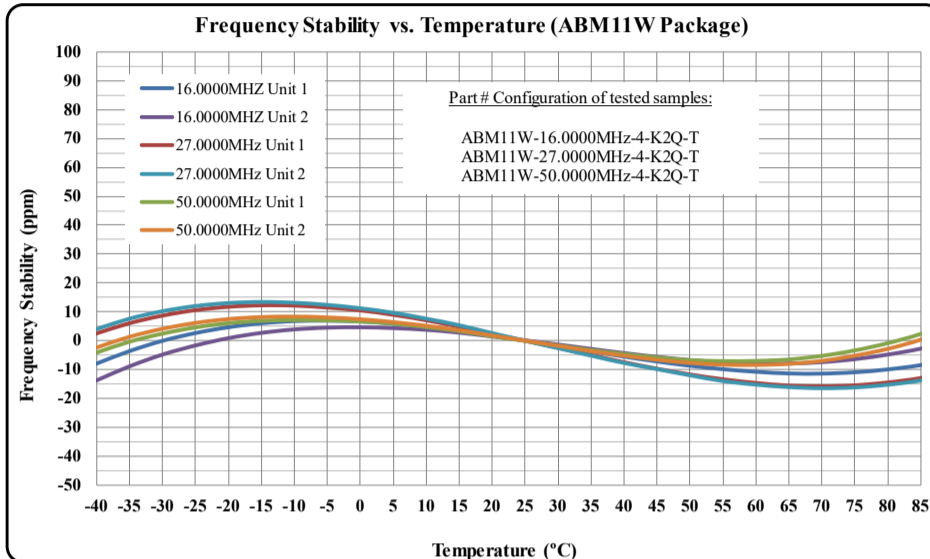

## TYPICAL ESR (EQUIVALENT SERIES RESISTANCE) Vs. TEMPERATURE CHARACTERISTICS

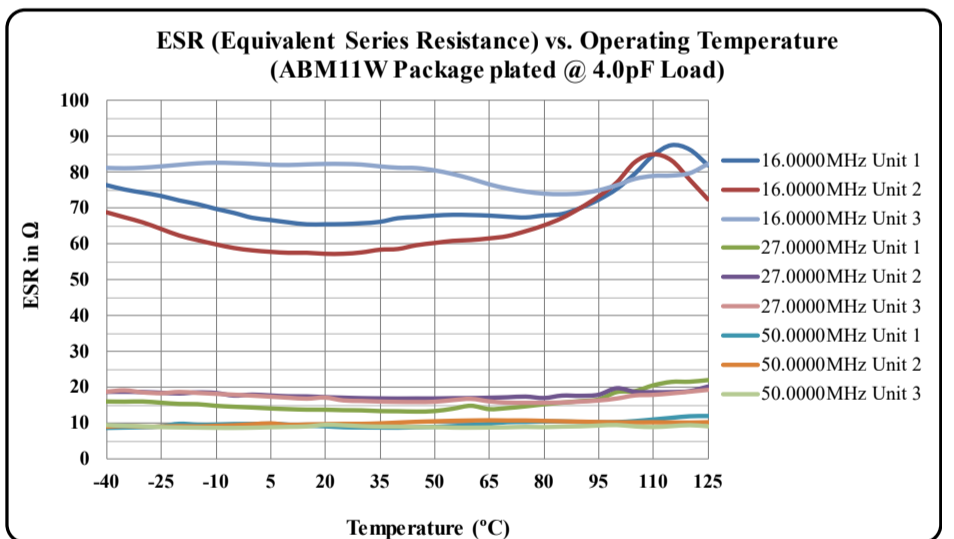
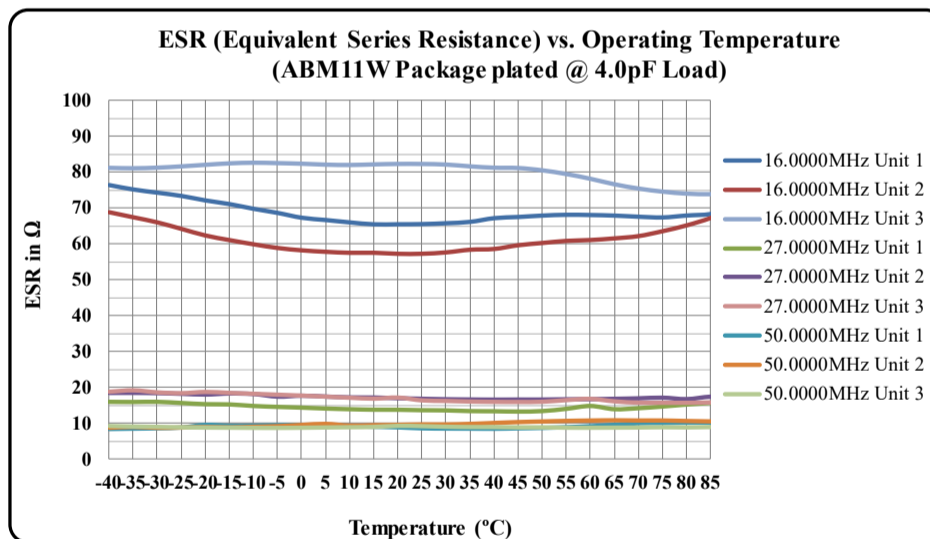

(\* ) Plating Load = Load Capacitance (CL)



5101 Hidden Creek Ln Spicewood TX 78669  
 Phone: 512-371-6159 | Fax: 512-351-8858  
 For terms and conditions of sales, please visit:  
[www.abracon.com](http://www.abracon.com)

REVISED: 10.06.2020

ABRACON IS  
 ISO9001-2015  
 CERTIFIED

# IoT OPTIMIZED LOW PROFILE QUARTZ CRYSTAL

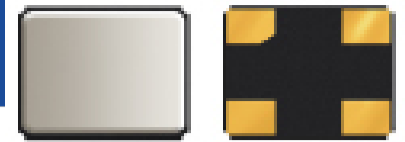

2.0 x 1.6 x 0.5mm

 RoHS/RoHS II Compliant

MSL = N/A: NOT APPLICABLE

ABM11W SERIES

## TYPICAL FREQUENCY TOLERANCE DISTRIBUTION (AT 25°C ± 3°C)

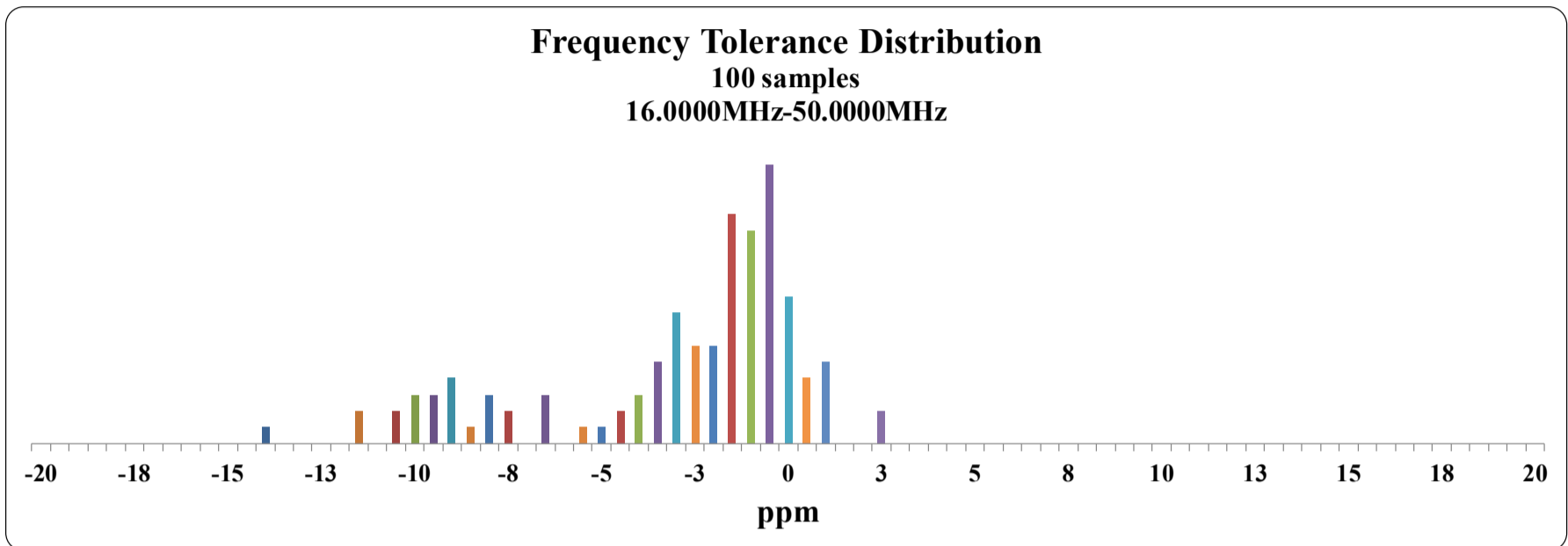

## TYPICAL ESR DISTRIBUTION (AT 25°C ± 3°C)

### ESR Distribution @ 16.0000MHz

100 samples  
MAX ESR = 89.5 Ω

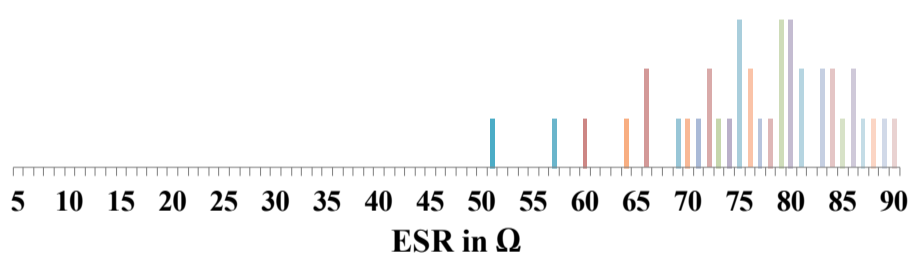

### ESR Distribution @ 27.0000MHz

100 samples  
MAX ESR = 28.3 Ω

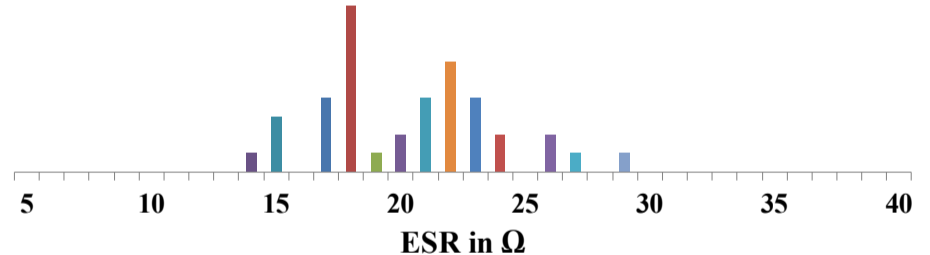

### ESR Distribution @ 50.0000MHz

100 samples  
MAX ESR = 13.4 Ω

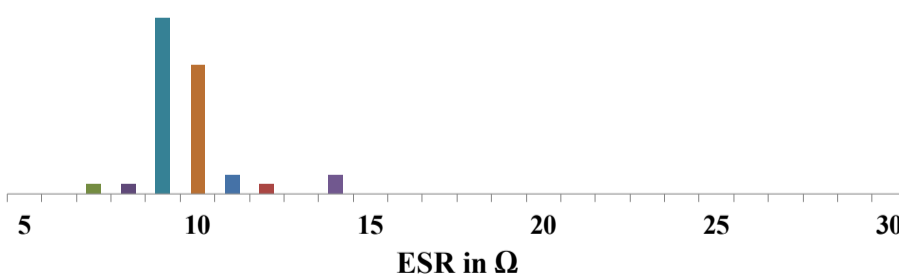

# IoT OPTIMIZED LOW PROFILE QUARTZ CRYSTAL



ABM11W SERIES

2.0 x 1.6 x 0.5mm



RoHS/RoHS II Compliant

MSL = N/A: NOT APPLICABLE

## SPICE MODELS (BASED ON TYPICAL VALUES AT 25°C ± 3°C)

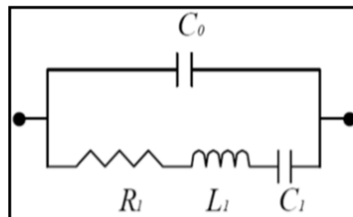

<b>Frequency: 16.0000MHz</b> <b>Plating Load: 4pF</b>		<b>Frequency: 16.0000MHz</b> <b>Plating Load: 6pF</b>	
C0	= 0.73 pF	C0	= 0.71 pF
R1	= 73.02 Ω	R1	= 81.42 Ω
L1	= 84.25 mH	L1	= 81.33 mH
C1	= 1.18 fF	C1	= 1.22 fF
<b>Frequency: 27.0000MHz</b> <b>Plating Load: 4pF</b>		<b>Frequency: 27.0000MHz</b> <b>Plating Load: 6pF</b>	
C0	= 0.78 pF	C0	= 0.76 pF
R1	= 18.71 Ω	R1	= 20.45 Ω
L1	= 18.08 mH	L1	= 18.44 mH
C1	= 1.92 fF	C1	= 1.89 fF
<b>Frequency: 50.0000MHz</b> <b>Plating Load: 4pF</b>		<b>Frequency: 50.0000MHz</b> <b>Plating Load: 6pF</b>	
C0	= 0.92 pF	C0	= 0.97 pF
R1	= 9.02 Ω	R1	= 8.49 Ω
L1	= 3.53 mH	L1	= 3.21 mH
C1	= 2.88 fF	C1	= 3.15 fF

## MECHANICAL DIMENSIONS

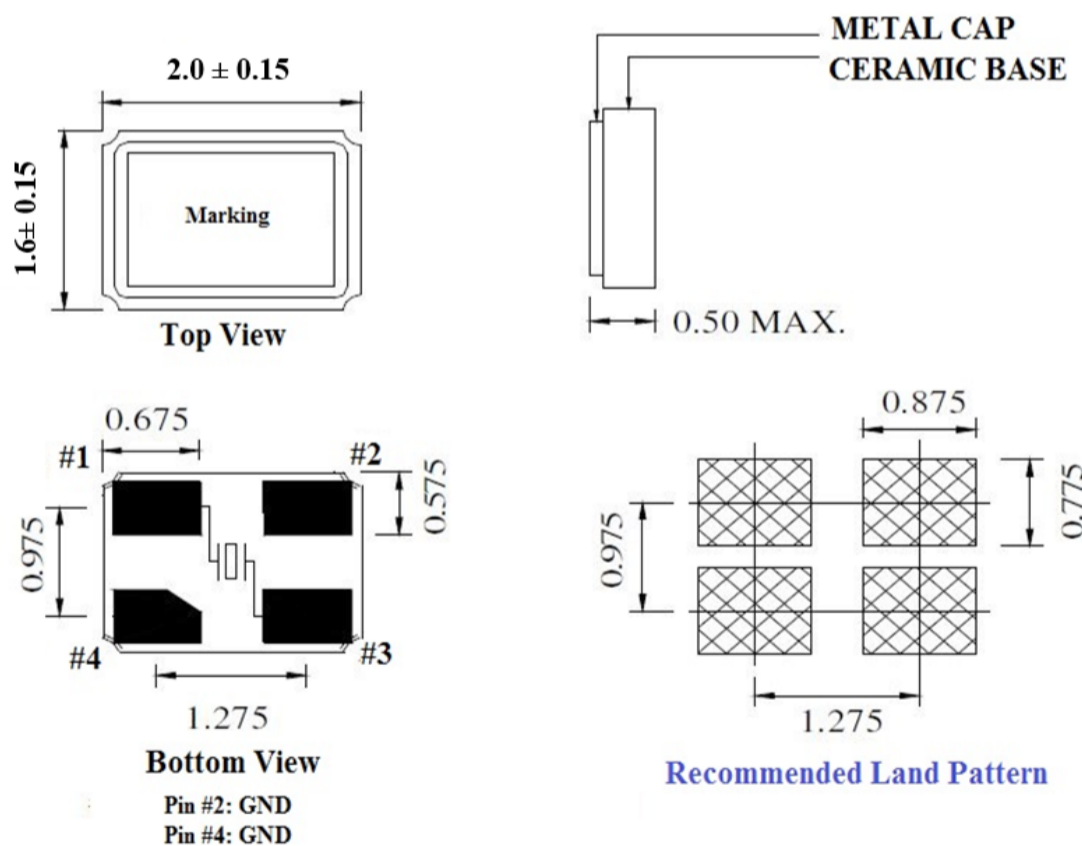

### Note:

Due to material availability the Chamfer could be located on pin #1, 2 or 4. Be advised that the Chamfer location has no impact on the electrical performance of the device.

**DIMENSIONS: MM**



5101 Hidden Creek Ln Spicewood TX 78669  
 Phone: 512-371-6159 | Fax: 512-351-8858  
 For terms and conditions of sales, please visit:  
[www.abracon.com](http://www.abracon.com)

REVISED: 10.06.2020

ABRACON IS  
 ISO9001-2015  
 CERTIFIED

# IoT OPTIMIZED LOW PROFILE QUARTZ CRYSTAL

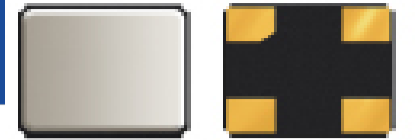

ABM11W SERIES

2.0 x 1.6 x 0.5mm



RoHS/RoHS II Compliant

MSL = N/A: NOT APPLICABLE

## REFLOW PROFILE

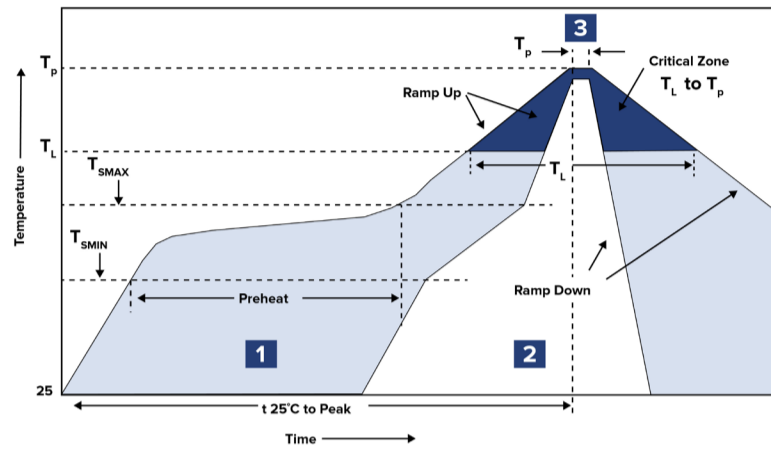

Zone	Description	Temperature	Time
1	Preheat	$T_{SMIN} \sim T_{SMAX}$ 150°C ~ 180°C	60 ~ 120 sec.
2	Reflow	$T_L$ 217°C	45 ~ 90 sec.
3	Peak Heat	$T_P$ 260°C MAX	10 sec.

## PACKAGING

T3: Tape and reel (3,000 pcs/reel)

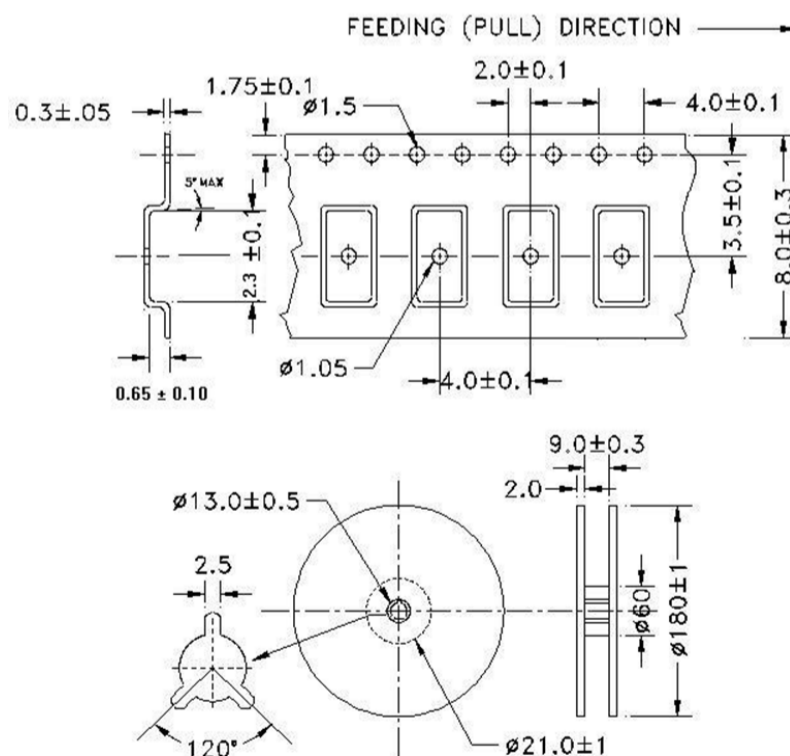

DIMENSIONS: mm



5101 Hidden Creek Ln Spicewood TX 78669  
 Phone: 512-371-6159 | Fax: 512-351-8858  
 For terms and conditions of sales, please visit:  
[www.abracon.com](http://www.abracon.com)

REVISED: 10.06.2020

ABRACON IS  
 ISO9001-2015  
 CERTIFIED

## X-ON Electronics

Largest Supplier of Electrical and Electronic Components

*Click to view similar products for [Crystals](#) category:*

*Click to view products by [Abracon](#) manufacturer:*

Other Similar products are found below :

[MC405 32.0000K-R3:PURE SN](#) [7B-27.000MBBK-T](#) [MP1-8.0 99-BU](#) [9B-15.360MBBK-B](#) [PTX-A2JM-10.000M](#) [9C-7.680MBBK-T](#) [H10S-12.000-18-EXT-TR](#) [R38-32.768-12.5-5PPM-NPB](#) [BTD1062E05A-513](#) [21U15A-21.4MHZ](#) [RTX-781DF1-S-20.950](#) [LFXTAL066198Cutt](#) [9C-14.31818MBBK-T](#) [A-11.000MHZ-27](#) [SPT2A-.032768B](#) [SPT2A.032768G](#) [SSPT7F-9PF20-R](#) [FX325BS-38.88EEM1201](#) [MP-1-25.000MHZ-3L](#) [MP-1-6.000MHZ](#) [LFXTAL065253Cutt](#) [LFXTAL066431Cutt](#) [XT9S20ANA14M7456](#) [XT9SNLANA16M](#) [646G-24-2](#) [7B-30.000MBBK-T](#) [6504-202-1501](#) [6526-202-1501](#) [BTJ120E02C](#) [SG636PCE-20.000MC](#) [3404](#) [C1E-24.000-7-2020-R](#) [C1E-19.200-12-1530-X-R](#) [C1E-16.000-12-1530-X-R](#) [FL5000014](#) [EUCA18-3.1872M](#) [425F35E027M0000](#) [17196](#) [MS3V-T1R-32.768kHz-7pF-20PPM-TA-QC-Au](#) [VXM7-1C1-16M000](#) [MS1V-T1K-32.768kHz-10pF-20PPM-TA-QC-Au](#) [MS1V-T1K-32.768kHz-12.5pF-20PPM-TA-QC-Au](#) [MS3V-T1R-32.768kHz-9pF-20PPM-TA-QC-Au](#) [17000](#) [17301](#) [16875](#) [ECS-80-18-30B-JEM-TR](#) [ECS-100-10-30B-CKL-TR](#) [MS1V-T1K-32.768kHz-6pF-20PPM-TA-QC-Au](#)