

IoT OPTIMIZED LOW PROFILE QUARTZ CRYSTAL

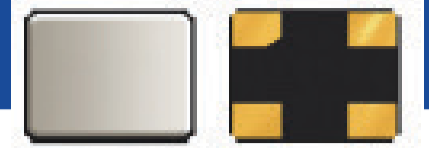

3.2 x 2.5 x 0.75mm

 RoHS/RoHS II Compliant

MSL = N/A: NOT APPLICABLE

ABM8W SERIES

FEATURES

- Optimized for energy saving wearables and IoT applications
- Plated at exceptionally low plating capacitance, as low as 4pF, with optimized ESR
- 0.75 mm max height ideally suited for height constrained designs
- Seam sealed for longterm reliability

APPLICATIONS

- Wearables
- Internet of Things (IoT)
- Bluetooth/Bluetooth Low Energy (BLE)
- Wireless modules
- Machine-to-machine (M2M) connectivity
- Ultra-low power MCU
- Near Field Communication (NFC)
- ISM Band

STANDARD SPECIFICATIONS

Parameters	Minimum	Typical	Maximum	Units	Notes
Frequency Range	10.0000		54.0000	MHz	
Operation Mode	Fundamental				
Operating Temperature Range	-40		+125	°C	See options
Storage Temperature	-55		+125	°C	
Frequency Tolerance @ +25°C	-10		+10	ppm	See options
Frequency Stability over the Operating Temperature (ref. to +25°C)	-10		+10	ppm	See options
Equivalent series resistance (R1) (over -40°C to +125°C)		< 100	200	Ω	10.0000 – 11.9999MHz
		< 60	100		12.0000 – 15.9999MHz
		< 40	70		16.0000 – 19.9999MHz
		< 25	50		20.0000 – 29.9999MHz
		< 20	40		30.0000 – 39.9999MHz
		< 18	30		40.0000 – 54.0000MHz
Shunt capacitance (C0)		< 1.2	2.0	pF	
Load capacitance (CL)		4.0		pF	See options
Drive Level		10	100	μW	
Aging (1 year)	-2		+2	ppm	@ 25°C±3°C
Insulation Resistance	500			MΩ	@ 100Vdc ± 15V

IoT OPTIMIZED LOW PROFILE QUARTZ CRYSTAL

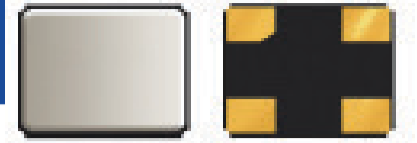

3.2 x 2.5 x 0.75mm



RoHS/RoHS II Compliant

MSL = N/A: NOT APPLICABLE

ABM8W SERIES

OPTIONS AND PART IDENTIFICATION (NOTE 1)

Note 1: Contact Abracon for part number requests with carrier frequency callouts up to 5&6 digit accuracy after the decimal.

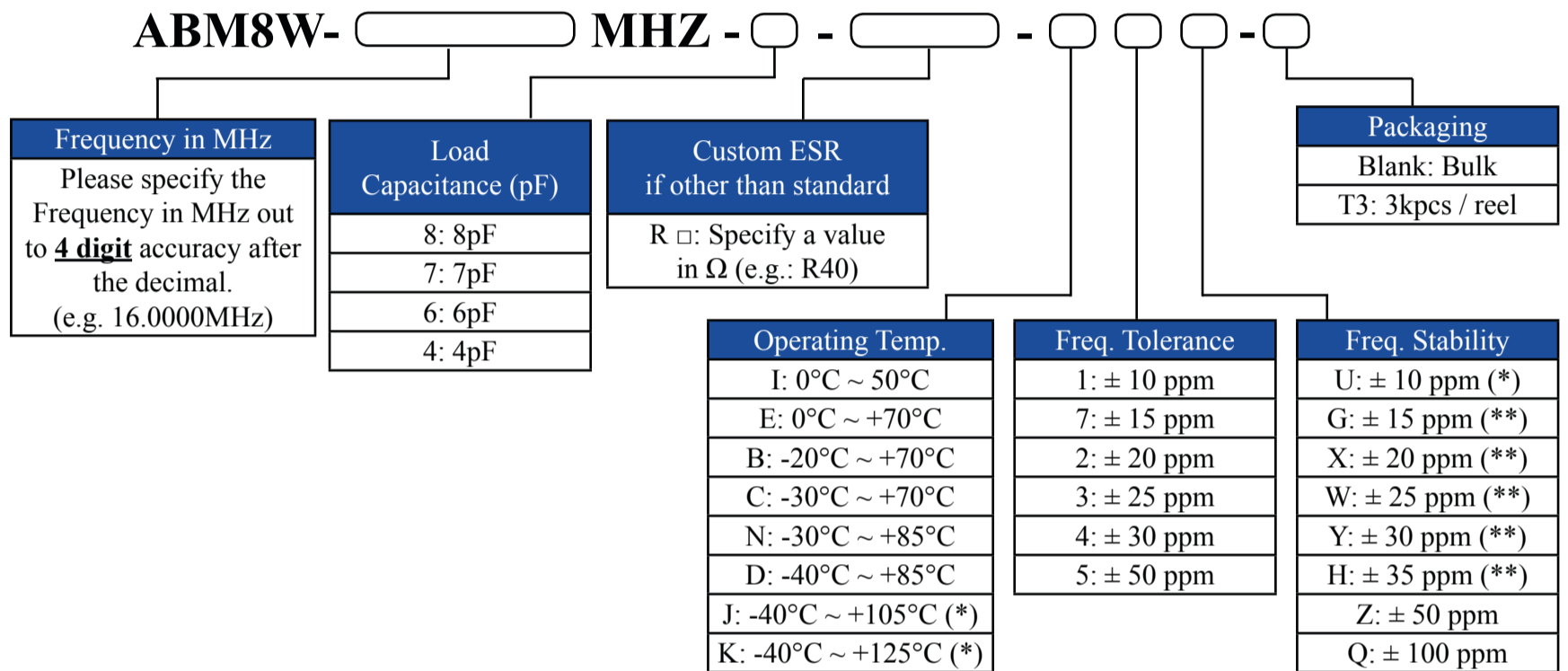

(*) Only offered @ Freq. Stability options: Z & Q.

Contact ABRACON for tighter Frequency Stability.

(*) Only offered @ Operating Temp. Range options: I, E, & B

(**) Only offered @ Operating Temp. Range options: I, E, B, C, N, & D

Contact ABRACON for wider Operating Temp. Range.

IoT OPTIMIZED LOW PROFILE QUARTZ CRYSTAL



3.2 x 2.5 x 0.75mm

RoHS/RoHS II Compliant

MSL = N/A: NOT APPLICABLE

ABM8W SERIES

TYPICAL ESR (EQUIVALENT SERIES RESISTANCE) Vs. TEMPERATURE CHARACTERISTICS

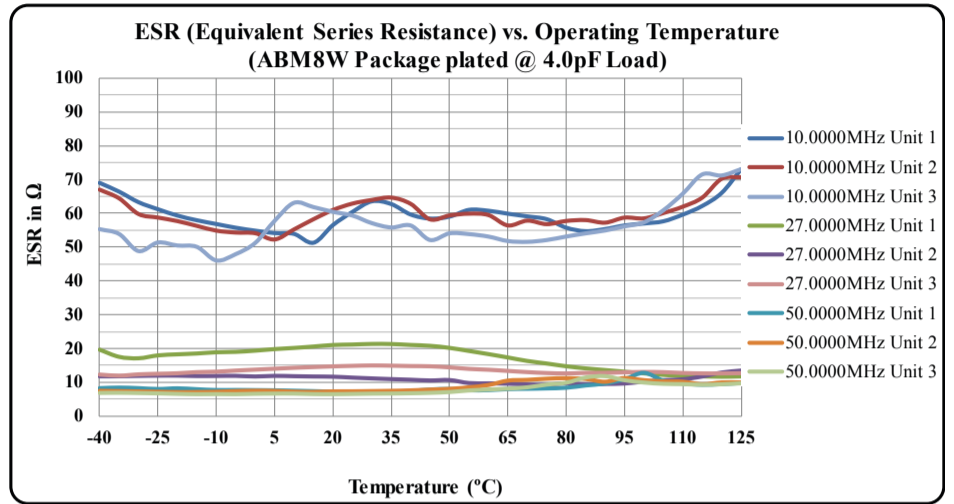
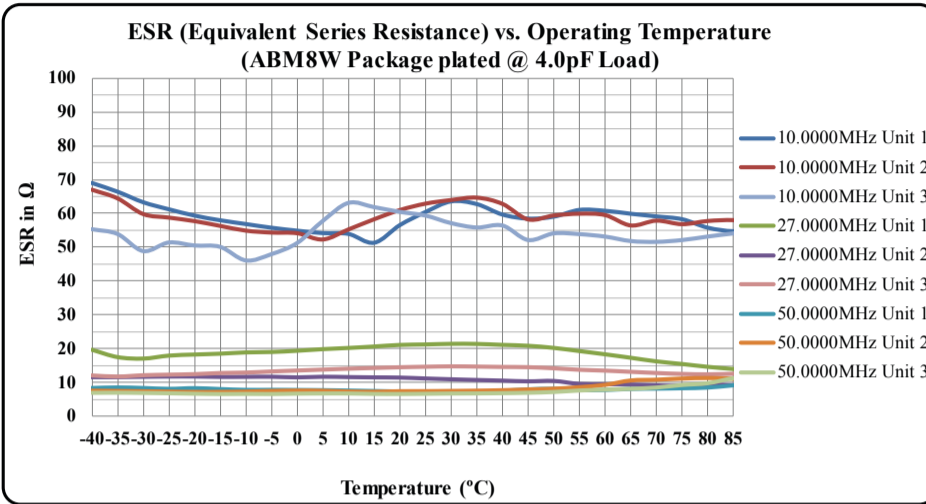

TYPICAL FREQUENCY Vs. TEMPERATURE CHARACTERISTICS

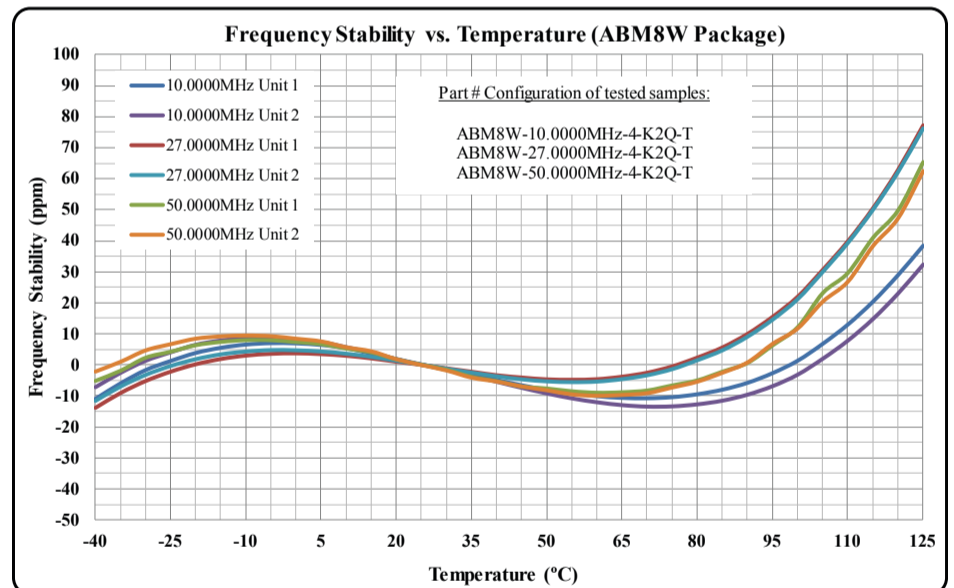
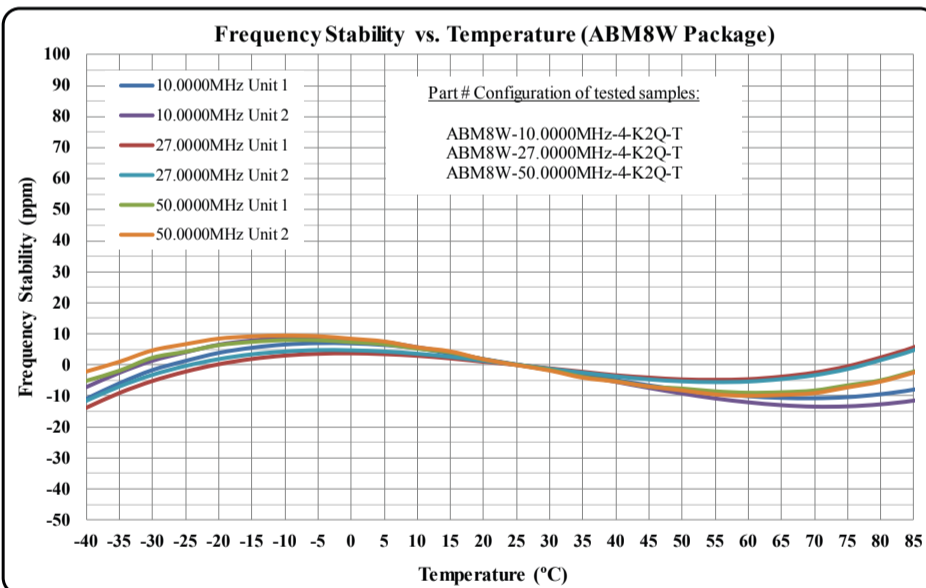

IoT OPTIMIZED LOW PROFILE QUARTZ CRYSTAL



ABM8W SERIES

3.2 x 2.5 x 0.75mm



RoHS/RoHS II Compliant

MSL = N/A: NOT APPLICABLE

TYPICAL FREQUENCY TOLERANCE DISTRIBUTION (AT 25°C ± 3°C)

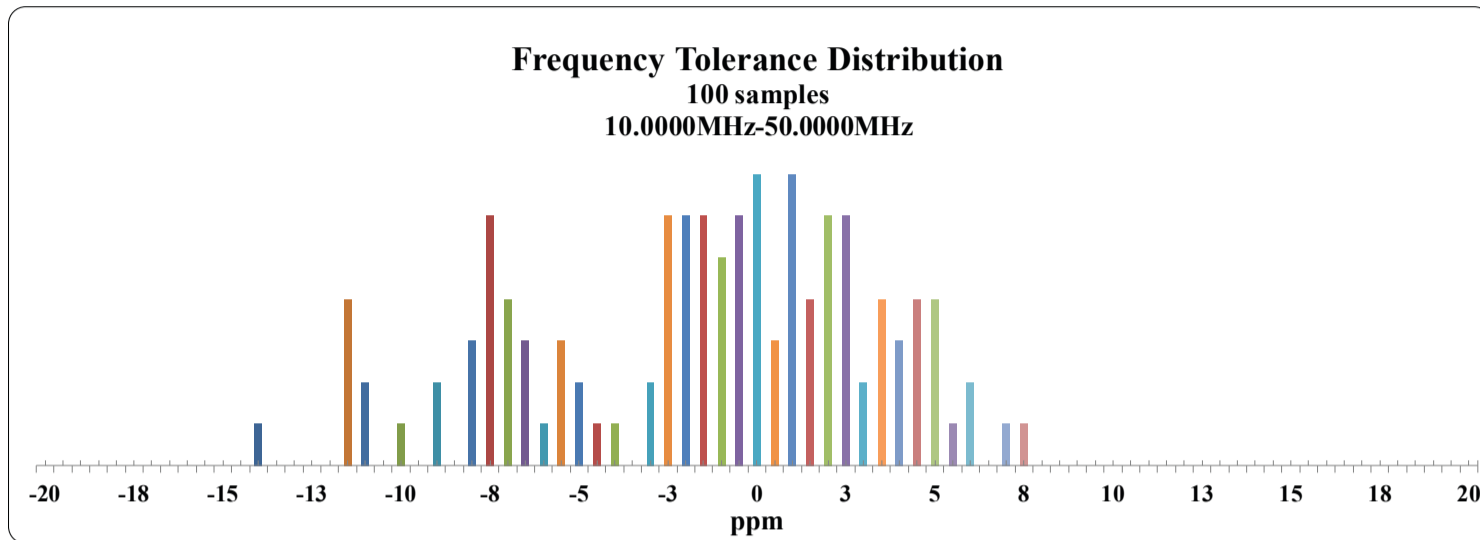

TYPICAL ESR DISTRIBUTION (AT 25°C ± 3°C)

ESR Distribution @ 10.0000MHz

100 samples
MAX ESR = 77.7 Ω

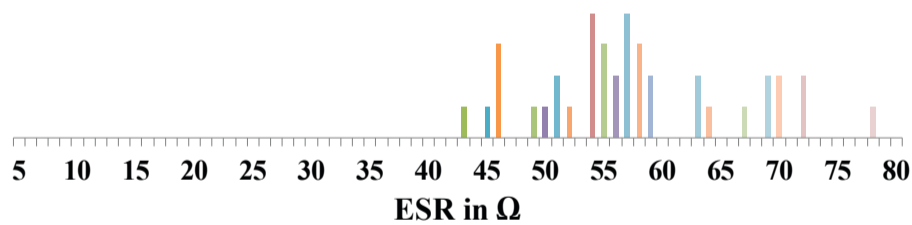

ESR Distribution @ 27.0000MHz

100 samples
MAX ESR = 21.6 Ω

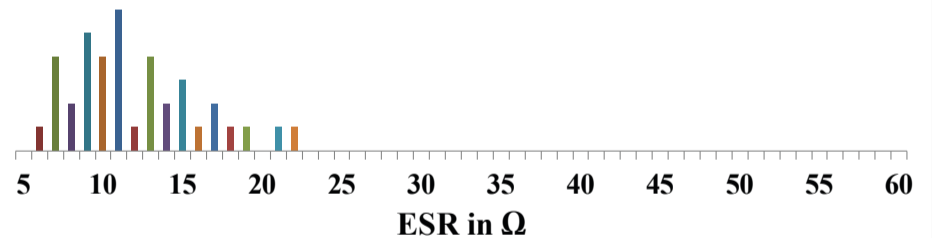

ESR Distribution @ 50.0000MHz

100 samples
MAX ESR = 10.23 Ω

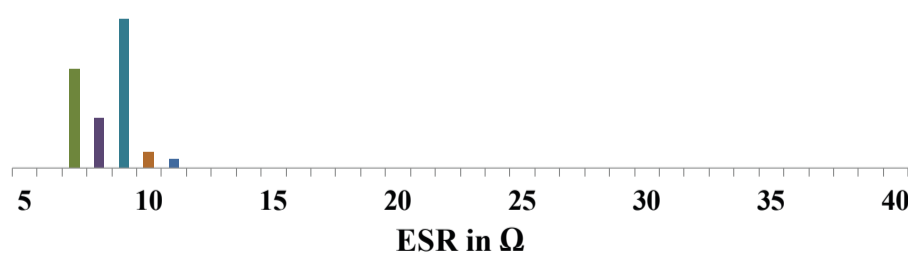

IoT OPTIMIZED LOW PROFILE QUARTZ CRYSTAL



3.2 x 2.5 x 0.75mm

RoHS/RoHS II Compliant

MSL = N/A: NOT APPLICABLE

ABM8W SERIES

SPICE MODELS (BASED ON TYPICAL VALUES AT 25°C ± 3°C)

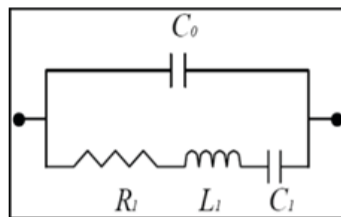

Frequency: 10.0000MHz Plating Load: 4pF			Frequency: 10.0000MHz Plating Load: 6pF		
C0	=	0.88 pF	C0	=	0.86 pF
R1	=	53.82 Ω	R1	=	60.62 Ω
L1	=	162.02 mH	L1	=	164.96 mH
C1	=	1.56 fF	C1	=	1.54 fF
Frequency: 27.0000MHz Plating Load: 4pF			Frequency: 27.0000MHz Plating Load: 6pF		
C0	=	1.16 pF	C0	=	1.16 pF
R1	=	11.83 Ω	R1	=	11.06 Ω
L1	=	9.16 mH	L1	=	9.10 mH
C1	=	3.80 fF	C1	=	3.82 fF
Frequency: 50.0000MHz Plating Load: 4pF			Frequency: 50.0000MHz Plating Load: 6pF		
C0	=	1.16 pF	C0	=	1.15 pF
R1	=	7.61 Ω	R1	=	8.06 Ω
L1	=	2.45 mH	L1	=	2.49 mH
C1	=	4.14 fF	C1	=	4.07 fF

MECHANICAL DIMENSIONS

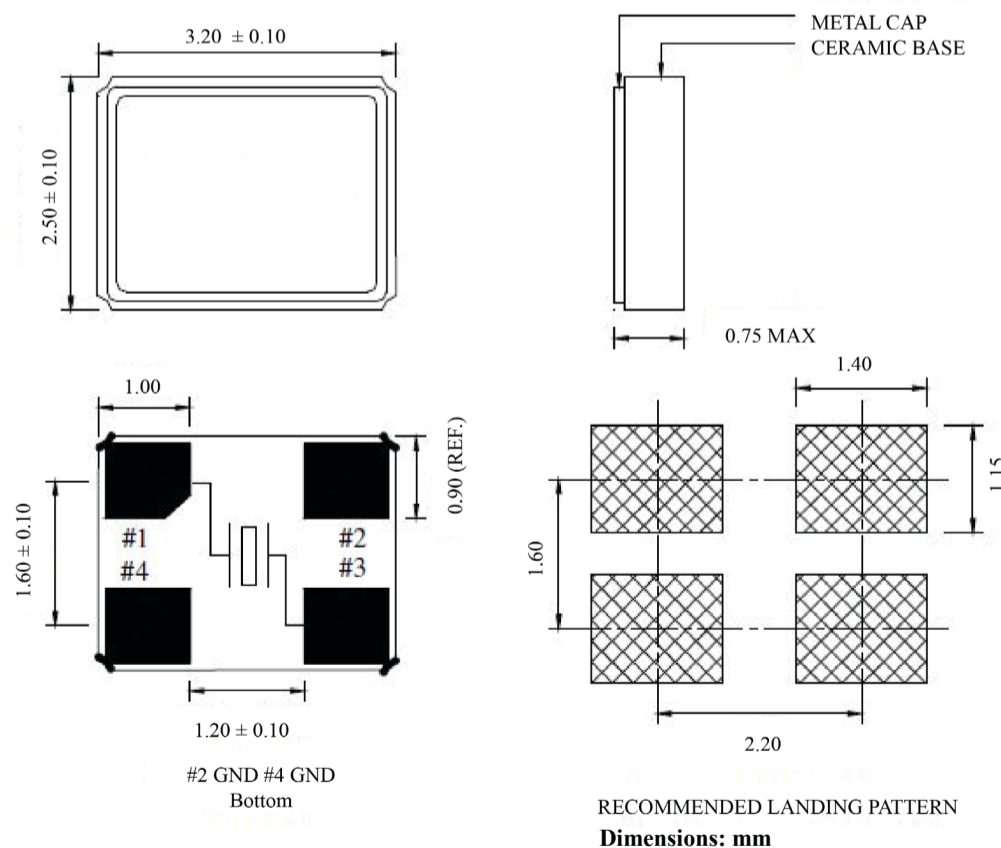

Note:

Due to material availability the Chamfer could be located on pin #1, 2 or 4. Be advised that the Chamfer location has no impact on the electrical performance of the device.

IoT OPTIMIZED LOW PROFILE QUARTZ CRYSTAL



ABM8W SERIES

3.2 x 2.5 x 0.75mm



RoHS/RoHS II Compliant

MSL = N/A: NOT APPLICABLE

REFLOW PROFILE

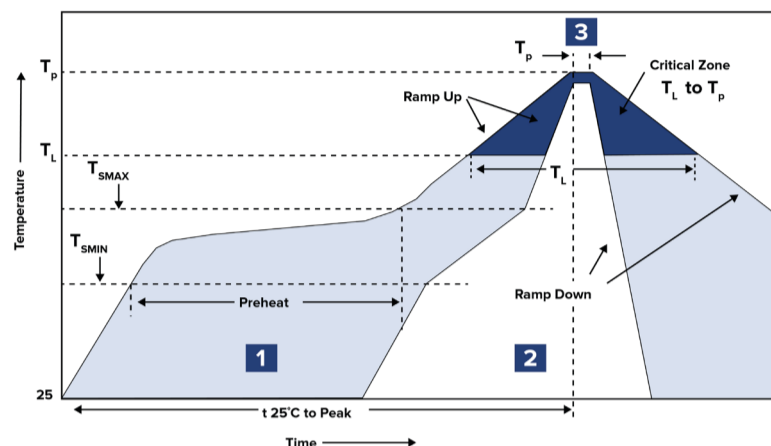

Zone	Description	Temperature	Time
1	Preheat	$T_{SMIN} \sim T_{SMAX}$ 150°C ~ 180°C	60 ~ 120 sec.
2	Reflow	T_L 217°C	45 ~ 90 sec.
3	Peak Heat	T_P 260°C MAX	10 sec.

PACKAGING

T3: Tape and reel (3,000 pcs/reel)

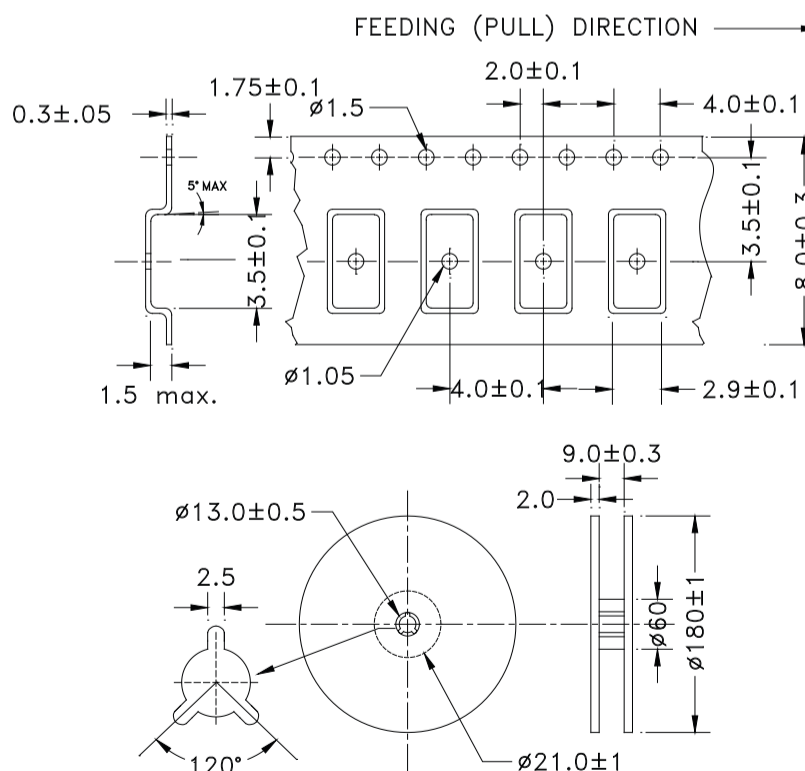

DIMENSIONS: mm

X-ON Electronics

Largest Supplier of Electrical and Electronic Components

Click to view similar products for [Crystals](#) category:

Click to view products by [Abracon](#) manufacturer:

Other Similar products are found below :

[CX3225GB25000M0PPSZ1](#) [718-13.2-1](#) [MC405 32.0000K-R3:PURE SN](#) [7A-40.000MAAE-T](#) [FL2000085](#) [99-BU](#) [9B-15.360MBBK-B](#) [9C-7.680MBBK-T](#) [H10S-12.000-18-EXT-TR](#) [ABC2-6.000MHZ-D4Z-T](#) [ABLS-20.000MHZ-D2-T](#) [ABS071-32.768KHZ-6-T](#) [R38-32.768-12.5-5PPM-NPB](#) [BTD1062E05A-513](#) [21U15A-21.4MHZ](#) [RTX-781DF1-S-20.950](#) [LFXTAL066198Cutt](#) [9C-14.31818MBBK-T](#) [A-11.000MHZ-27](#) [ABL-27.000MHZ-B4Y-T](#) [ABM11-132-24.000MHZ-T3](#) [ABM3B1-25.000MHZ-D2Y-T](#) [SPT2A-.032768B](#) [SPT2A.032768G](#) [SSPT7F-9PF20-R](#) [LFXTAL065253Cutt](#) [LFXTAL066431Cutt](#) [XT9S20ANA14M7456](#) [XT9SNLANA16M](#) [7A-24.576MBBK-T](#) [7B-30.000MBBK-T](#) [MMCC2R32.7680KHZ](#) [7A-14.31818MBBK-T](#) [6504-202-1501](#) [6526-202-1501](#) [ABLS-12.000MHZ-B2Y-T](#) [7A-10.000MBBK-T](#) [SG636PCE-20.000MC](#) [3404](#) [E1SAA18-25.000M TR](#) [CM315D32768EZFT](#) [C1E-24.000-7-2020-R](#) [C1E-19.200-12-1530-X-R](#) [C1E-16.000-12-1530-X-R](#) [ABM11-16.000MHZ-9-B1U-T](#) [FL5000014](#) [EUCA18-3.1872M](#) [FX0800015](#) [425F35E027M0000](#) [FP0800018](#)